



# FCC CO-LOCATION RADIO TEST REPORT

**FCC ID** : PY7-26726G  
**Equipment** : GSM/WCDMA/LTE/5G Phone with BT, DTS/UNII  
a/b/g/n/ac/ax, GPS, WPC and NFC  
**Brand Name** : Sony  
**Applicant** : Sony Corporation  
1-7-1 Konan Minato-ku Tokyo, 108-0075 Japan  
**Manufacturer** : Sony Corporation  
1-7-1 Konan Minato-ku Tokyo, 108-0075 Japan  
**Standard** : FCC Part 15 Subpart E §15.407

The product was received on Feb. 23, 2021 and testing was started from Mar. 17, 2021 and completed on Mar. 19, 2021. We, Sporton International Inc. Wensan Laboratory, would like to declare that the tested sample has been evaluated in accordance with the test procedures and has been in compliance with the applicable technical standards.

The test results in this report apply exclusively to the tested model / sample. Without written approval of Sporton International Inc. Wensan Laboratory, the test report shall not be reproduced except in full.

*Louis Wu*

Approved by: Louis Wu

**Sporton International Inc. Wensan Laboratory**

No.58, Aly. 75, Ln. 564, Wenhua 3rd, Rd., Guishan Dist., Taoyuan City 333010, Taiwan (R.O.C.)



## Table of Contents

History of this test report.....	3
Summary of Test Result.....	4
<b>1 General Description .....</b>	<b>5</b>
1.1 Product Feature of Equipment Under Test.....	5
1.2 Modification of EUT .....	5
1.3 Testing Location .....	6
1.4 Applicable Standards.....	6
<b>2 Test Configuration of Equipment Under Test .....</b>	<b>7</b>
2.1 Carrier Frequency and Channel .....	7
2.2 Connection Diagram of Test System.....	8
2.3 Support Unit used in test configuration and system .....	8
2.4 EUT Operation Test Setup .....	8
<b>3 Test Result .....</b>	<b>9</b>
3.1 Unwanted Emissions Measurement.....	9
3.2 Antenna Requirements.....	13
<b>4 List of Measuring Equipment.....</b>	<b>14</b>
<b>5 Uncertainty of Evaluation .....</b>	<b>15</b>
<b>Appendix A. Radiated Spurious Emission</b>	
<b>Appendix B. Radiated Spurious Emission Plots</b>	
<b>Appendix C. Duty Cycle Plots</b>	





### Summary of Test Result

Report Clause	Ref Std. Clause	Test Items	Result (PASS/FAIL)	Remark
3.1	15.407(b)	Unwanted Emissions	Pass	Under limit 4.35 dB at 17956.000 MHz
3.2	15.203 & 15.407 (a)	Antenna Requirement	Pass	-

<b>Declaration of Conformity:</b> The test results with all measurement uncertainty excluded are presented in accordance with the regulation limits or requirements declared by manufacturers.
<b>Comments and Explanations:</b> The declared of product specification for EUT presented in the report are provided by the manufacturer, and the manufacturer takes all the responsibilities for the accuracy of product specification.

Reviewed by: Wii Chang  
Report Producer: Cindy Liu



# 1 General Description

## 1.1 Product Feature of Equipment Under Test

GSM/WCDMA/LTE, Bluetooth, DTS/UNII a/b/g/n/ac/ax, NFC, FM Receiver, WPC/WPT, and GNSS.

Product Specification subjective to this standard	
Antenna Type	<Ant. 0>: Loop Antenna <Ant. 1>: Loop Antenna

**Remark:** The above EUT's information was declared by manufacturer. Please refer to Comments and Explanations in report summary.

EUT Information List			
HW Version	SW Version	S/N	Performed Test Item
A	0.325	QV7200H36F	Radiated Spurious Emission

Accessory List	
AC Adapter	Model Name : XQZ-UC1
	S/N : 0020W51300105
Earphone	Model Name : STH40D
	S/N : N/A
USB Cable	Model Name : XQZ-UB1
	S/N : N/A

**Note:**

1. Above EUT list used are electrically identical per declared by manufacturer.
2. Above the accessories list are used to exercise the EUT during test, and the serial number of each type of accessories is listed in each section of this report.
3. For other wireless features of this EUT, test report will be issued separately.

## 1.2 Modification of EUT

No modifications are made to the EUT during all test items.



### 1.3 Testing Location

<b>Test Site</b>	Sporton International Inc. Wensan Laboratory
<b>Test Site Location</b>	No.58, Aly. 75, Ln. 564, Wenhua 3rd, Rd., Guishan Dist., Taoyuan City 333010, Taiwan (R.O.C.) TEL: +886-3-327-0868 FAX: +886-3-327-0855
<b>Test Site No.</b>	<b>Sporton Site No.</b>
	03CH16-HY

**Note:** The test site complies with ANSI C63.4 2014 requirement.

FCC designation No.: TW0007

### 1.4 Applicable Standards

According to the specifications of the manufacturer, the EUT must comply with the requirements of the following standards:

- ♦ FCC Part 15 Subpart C §15.247
- ♦ FCC Part 15 Subpart E
- ♦ FCC KDB 789033 D02 General UNII Test Procedures New Rules v02r01.
- ♦ FCC KDB 662911 D01 Multiple Transmitter Output v02r01.
- ♦ FCC KDB 971168 D01 Power Meas. License Digital Systems v03r01
- ♦ ANSI C63.10-2013

**Remark:**

1. All test items were verified and recorded according to the standards and without any deviation during the test.
2. The TAF code is not including all the FCC KDB listed without accreditation.
3. This EUT has also been tested and complied with the requirements of FCC Part 15, Subpart B, recorded in a separate test report.

## 2 Test Configuration of Equipment Under Test

The EUT has been associated with peripherals and configuration operated in a manner tended to maximize its emission characteristics in a typical application. Frequency range investigated: radiation emission (9 kHz to the 10th harmonic of the highest fundamental frequency or to 40 GHz, whichever is lower). For radiated measurement, pre-scanned in three orthogonal panels, X, Y, Z. The worst cases (Y plane) were recorded in this report.

### 2.1 Carrier Frequency and Channel

<Ant. 0>

2400-2483.5 MHz	
Bluetooth	
Channel	Freq. (MHz)
39	2480

MIMO <Ant. 0+1>

2400-2483.5 MHz				5150-5350 MHz	
802.11b		802.11g		802.11a	
Channel	Freq. (MHz)	Channel	Freq. (MHz)	Channel	Freq. (MHz)
01	2412	01	2412	36	5180

**Remark:** During the Radiated Spurious Emission test, the EUT turn on the WWAN functions simultaneously.

<Co-Location>

Modulation	Data Rate
2.4GHz 802.11g for MIMO Ant. 0+1 + GSM850	MCS0 + GMSK
2.4GHz 802.11b for MIMO Ant. 0+1 + LTE Band 7	MCS0 + QPSK
5GHz 802.11a for MIMO Ant. 0+1 + Bluetooth for Ant. 0 + GSM850	MCS0 + GFSK + GMSK
5GHz 802.11a for MIMO Ant. 0+1 + Bluetooth for Ant. 0 + LTE Band 7	MCS0 + GFSK + QPSK

**Remark:** For Radiated Spurious Emission Test Items, Ant. 0 means Chain 0 and Ant. 1 means Chain 1.

## 2.2 Connection Diagram of Test System

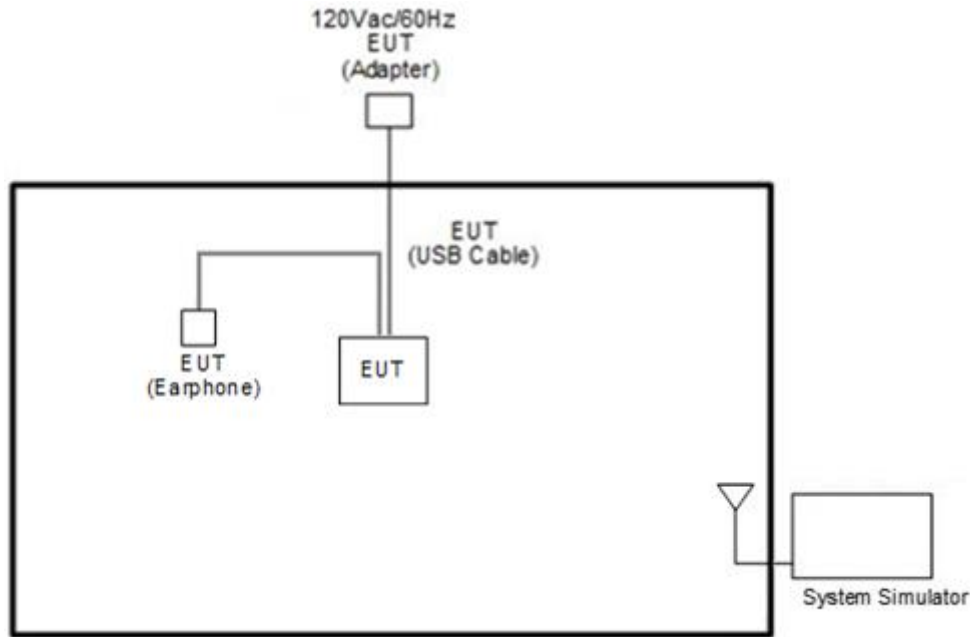

## 2.3 Support Unit used in test configuration and system

Item	Equipment	Brand Name	Model Name	FCC ID	Data Cable	Power Cord
1.	System Simulator	Anritsu	MT8820C	N/A	N/A	Unshielded, 1.8m

## 2.4 EUT Operation Test Setup

The RF test items, utility "CMD" was installed in Notebook which was programmed in order to make the EUT get into the engineering modes to provide channel selection, power level, data rate and the application type and for continuous transmitting signals.





### 3 Test Result

#### 3.1 Unwanted Emissions Measurement

This section is to measure unwanted emissions through radiated measurement for band edge spurious emissions and out of band emissions measurement.

##### 3.1.1 Limit of Unwanted Emissions

(1) Unwanted spurious emissions fallen in restricted bands shall comply with the general field strength limits as below table,

Frequency (MHz)	Field Strength (microvolts/meter)	Measurement Distance (meters)
0.009 – 0.490	2400/F(kHz)	300
0.490 – 1.705	24000/F(kHz)	30
1.705 – 30.0	30	30
30 – 88	100	3
88 – 216	150	3
216 - 960	200	3
Above 960	500	3

**Note:** The following formula is used to convert the EIRP to field strength.

$$E = \frac{1000000\sqrt{30P}}{3} \mu V/m, \text{ where } P \text{ is the eirp (Watts)}$$

EIRP (dBm)	Field Strength at 3m (dBµV/m)
- 27	68.3

(2) KDB789033 D02 v02r01 G)2)c)

- (i) Sections 15.407(b)(1-3) specifies the unwanted emissions limit for the U-NII-1 and U-NII-2 bands. As specified, emissions above 1000 MHz that are outside of the restricted bands are subject to a peak emission limit of -27 dBm/MHz.
- (ii) Section 15.407(b)(4) specifies the unwanted emissions limit for the U-NII-3 band. A band emissions mask is specified in Section 15.407(b)(4)(i). The emission limits are based on the use of a peak detector.

##### 3.1.2 Measuring Instruments

See list of measuring equipment of this test report.



### 3.1.3 Test Procedures

1. The testing follows FCC KDB 789033 D02 General UNII Test Procedures New Rules v02r01. Section G) Unwanted emissions measurement.
  - (1) Procedure for Peak Unwanted Emissions Measurements Above 1000 MHz
    - RBW = 1 MHz
    - VBW  $\geq$  3 MHz
    - Detector = Peak
    - Sweep time = auto
    - Trace mode = max hold
  - (2) Procedures for Average Unwanted Emissions Measurements Above 1000MHz
    - RBW = 1 MHz
    - VBW = 10 Hz, when duty cycle is no less than 98 percent.
    - VBW  $\geq$  1/T, when duty cycle is less than 98 percent where T is the minimum transmission duration over which the transmitter is on and is transmitting at its maximum power control level for the tested mode of operation.
2. The EUT was placed on a turntable with 1.5 meter for frequency above 1GHz respectively above ground.
3. The EUT was set 3 meters from the interference receiving antenna which was mounted on the top of a variable height antenna tower.
4. The antenna is a broadband antenna and its height is adjusted between one meter and four meters above ground to find the maximum value of the field strength for both horizontal polarization and vertical polarization of the antenna.
5. For each suspected emission, the EUT was arranged to its worst case and then adjust the antenna tower (from 1 m to 4 m) and turntable (from 0 degree to 360 degrees) to find the maximum reading.
6. For testing above 1GHz, the emission level of the EUT in peak mode was 20dB lower than average limit (that means the emission level in average mode also complies with the limit in average mode), then peak values of EUT will be reported, otherwise, the emissions will be measured in average mode again and reported.

### 3.1.4 Test Setup

For radiated emissions below 30MHz

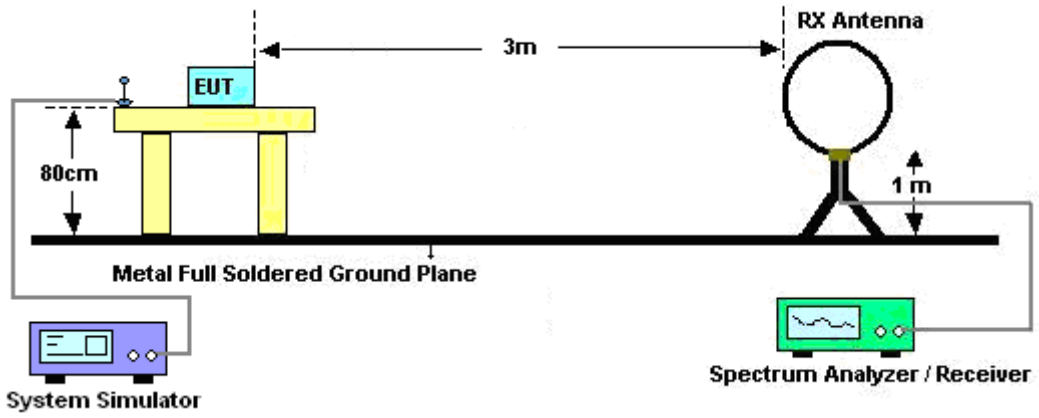

For radiated emissions from 30MHz to 1GHz

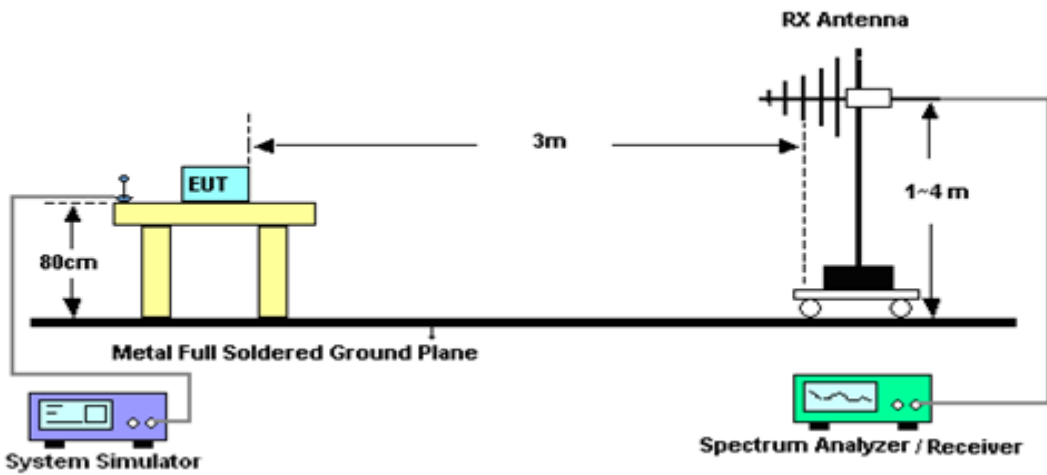

For radiated emissions from 1GHz to 18GHz

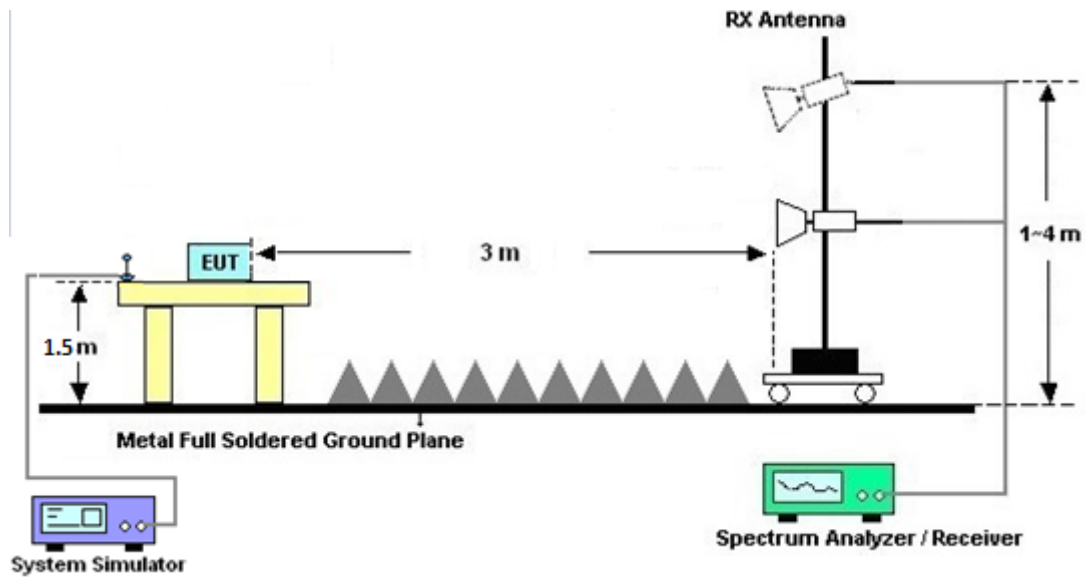

For radiated emissions above 18GHz

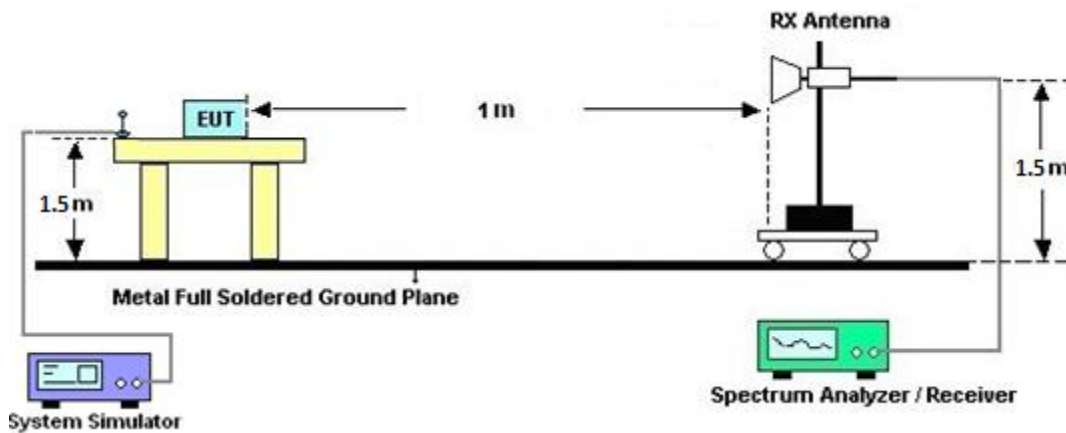

### 3.1.5 Test Result of Radiated Band Edges

Please refer to Appendix A and B.

### 3.1.6 Duty Cycle

Please refer to Appendix C.

### 3.1.7 Test Result of Unwanted Radiated Emission

Please refer to Appendix A and B.



## **3.2 Antenna Requirements**

### **3.2.1 Standard Applicable**

If transmitting antenna directional gain is greater than 6 dBi, both the peak transmit power and the peak power spectral density shall be reduced by the amount in dB that the directional gain of the antenna exceeds 6 dBi.

### **3.2.2 Antenna Anti-Replacement Construction**

An embedded-in antenna design is used.

### **3.2.3 Antenna Gain**

The antenna peak gain of EUT is less than 6 dBi. Therefore, it is not necessary to reduce maximum peak output power limit.



## 4 List of Measuring Equipment

Instrument	Brand Name	Model No.	Serial No.	Characteristics	Calibration Date	Test Date	Due Date	Remark
Loop Antenna	Rohde & Schwarz	HFH2-Z2	100488	9 kHz~30 MHz	Jul. 14, 2020	Mar. 17, 2021~ Mar. 19, 2021	Jul. 13, 2021	Radiation (03CH16-HY)
Bilog Antenna	TESEQ	CBL 6111D & 00802N1D01 N-06	47020 & 06	30MHz to 1GHz	Oct. 11, 2020	Mar. 17, 2021~ Mar. 19, 2021	Oct. 10, 2021	Radiation (03CH16-HY)
Amplifier	SONOMA	310N	371607	9kHz~1G	Sep. 30, 2020	Mar. 17, 2021~ Mar. 19, 2021	Sep. 29, 2021	Radiation (03CH16-HY)
Horn Antenna	SCHWARZBE CK	BBHA 9120 D	9120D-1522	1G~18GHz	Sep. 29, 2020	Mar. 17, 2021~ Mar. 19, 2021	Sep. 28, 2021	Radiation (03CH16-HY)
Amplifier	EMCI	EMC051845S E	980729	1-18GHz	Jul. 10, 2020	Mar. 17, 2021~ Mar. 19, 2021	Jul. 09, 2021	Radiation (03CH16-HY)
SHF-EHF Horn Antenna	SCHWARZBE CK	BBHA 9170	BBHA91705 76	18GHz ~40GHz	May 22, 2020	Mar. 17, 2021~ Mar. 19, 2021	May 21, 2021	Radiation (03CH16-HY)
Preamplifier	Keysight	83017A	MY5327026 4	1GHz~26.5GHz	Dec. 10, 2020	Mar. 17, 2021~ Mar. 19, 2021	Dec. 09, 2021	Radiation (03CH16-HY)
EMI Test Receiver	Keysight	N9038A	MY5905301 2	3Hz~26.5GHz	Nov. 18, 2020	Mar. 17, 2021~ Mar. 19, 2021	Nov. 17, 2021	Radiation (03CH16-HY)
Spectrum Analyzer	Agilent	N9010A	MY53470118	10Hz~44GHz	Jan. 15, 2021	Mar. 17, 2021~ Mar. 19, 2021	Jan. 14, 2022	Radiation (03CH16-HY)
RF Cable	HUBER + SUHNER	SUCOFLEX 104	MY11680/4P E	NA	Aug. 29, 2020	Mar. 17, 2021~ Mar. 19, 2021	Aug. 28, 2021	Radiation (03CH16-HY)
RF Cable	HUBER + SUHNER	SUCOFLEX 104	MY11688/4P E	NA	Aug. 29, 2020	Mar. 17, 2021~ Mar. 19, 2021	Aug. 28, 2021	Radiation (03CH16-HY)
RF Cable	HUBER + SUHNER	SUCOFLEX 102	EC-A5-300-5 757	NA	Aug. 29, 2020	Mar. 17, 2021~ Mar. 19, 2021	Aug. 28, 2021	Radiation (03CH16-HY)
Software	Audix	E3 6.2009-8-24	RK-001136	N/A	N/A	Mar. 17, 2021~ Mar. 19, 2021	N/A	Radiation (03CH16-HY)
Controller	ChainTek	3000-1	N/A	Control Turn table & Ant Mast	N/A	Mar. 17, 2021~ Mar. 19, 2021	N/A	Radiation (03CH16-HY)
Antenna Mast	ChainTek	MBS-520-1	N/A	1m~4m	N/A	Mar. 17, 2021~ Mar. 19, 2021	N/A	Radiation (03CH16-HY)
Turn Table	ChainTek	T-200-S-1	N/A	0~360 Degree	N/A	Mar. 17, 2021~ Mar. 19, 2021	N/A	Radiation (03CH16-HY)



## 5 Uncertainty of Evaluation

### Uncertainty of Radiated Emission Measurement (30 MHz ~ 1000 MHz)

Measuring Uncertainty for a Level of Confidence of 95% ( $U = 2Uc(y)$ )	4.5
---	-----

### Uncertainty of Radiated Emission Measurement (1000 MHz ~ 18000 MHz)

Measuring Uncertainty for a Level of Confidence of 95% ( $U = 2Uc(y)$ )	6.3
---	-----

### Uncertainty of Radiated Emission Measurement (18000 MHz ~ 40000 MHz)

Measuring Uncertainty for a Level of Confidence of 95% ( $U = 2Uc(y)$ )	4.7
---	-----



## Appendix A. Radiated Spurious Emission

Test Engineer :	Karl Hou, CR Liro and Andy Yang	Temperature :	20~25°C
		Relative Humidity :	50~60%

WIFI 802.11g\_Tx\_Ch01+ WWAN GSM850 CH189 Link

2.4GHz 2400~2483.5MHz

WLAN 802.11g (Band Edge @ 3m)

WIFI Ant. 0+1	Note	Frequency ( MHz )	Level ( dBμV/m )	Over Limit ( dB )	Limit Line ( dBμV/m )	Read Level ( dBμV )	Antenna Factor ( dB/m )	Path Loss ( dB )	Preamp Factor ( dB )	Ant Pos ( cm )	Table Pos ( deg )	Peak Avg. ( P/A )	Pol. ( H/V )	
802.11g CH 01 2412MHz		2390	56.93	-17.07	74	41.17	27.56	8.56	30.28	107	29	P	H	
		2390	45.44	-8.56	54	29.68	27.56	8.56	30.28	107	29	A	H	
	*	2412	106.11	-	-	90.38	27.48	8.6	30.27	107	29	P	H	
	*	2412	98.74	-	-	83.01	27.48	8.6	30.27	107	29	A	H	
													H	
													H	
			2367.75	56.33	-17.67	74	40.49	27.69	8.52	30.29	290	111	P	V
			2390	44.43	-9.57	54	28.67	27.56	8.56	30.28	290	111	A	V
	*		2412	102.2	-	-	86.47	27.48	8.6	30.27	290	111	P	V
	*		2412	94.68	-	-	78.95	27.48	8.6	30.27	290	111	A	V
													V	
													V	





WIFI 802.11g\_Tx\_Ch01+ WWAN GSM850 CH189 Link

WIFI 802.11g (Harmonic @ 3m)

WIFI Ant. 0+1	Note	Frequency ( MHz )	Level ( dBμV/m )	Over Limit ( dB )	Limit Line ( dBμV/m )	Read Level ( dBμV )	Antenna Factor ( dB/m )	Path Loss ( dB )	Preamp Factor ( dB )	Ant Pos ( cm )	Table Pos ( deg )	Peak Avg. (P/A)	Pol. (H/V)	
802.11g CH 01 2412MHz		4824	40.3	-33.7	74	51.15	31.15	13.36	55.36	100	0	P	H	
		17880	58.23	-15.77	74	43.03	46.82	25.63	57.25	100	0	P	H	
		17880	48.21	-5.79	54	33.01	46.82	25.63	57.25	100	0	A	H	
													H	
													H	
													H	
			4824	40.23	-33.77	74	51.08	31.15	13.36	55.36	100	0	P	V
			17925	58.74	-15.26	74	42.65	47.72	25.64	57.27	100	0	P	V
			17925	48.75	-5.25	54	32.66	47.72	25.64	57.27	100	0	A	V
														V
														V
														V



Emission above 18GHz

WIFI	Note	Frequency	Level	Over	Limit	Read	Antenna	Path	Preamp	Ant	Table	Peak	Pol.	
Ant.				Limit	Line	Level	Factor	Loss	Factor	Pos	Pos	Avg.		
0+1		( MHz )	( dBμV/m )	( dB )	( dBμV/m )	( dBμV )	( dB/m )	( dB )	( dB )	( cm )	( deg )	( P/A )	( H/V )	
802.11g+ GSM 850 SHF		23075	40.6	-33.4	74	43.01	38.68	12.47	53.56	150	0	P	H	
													H	
													H	
													H	
													H	
													H	
													H	
													H	
													H	
			20576	40.09	-33.91	74	44.29	38.06	11.22	53.48	150	0	P	V
														V
														V
														V
														V
														V
Remark	1. No other spurious found. 2. All results are PASS against limit line.													



Emission below 1GHz

WIFI	Note	Frequency	Level	Over	Limit	Read	Antenna	Path	Preamp	Ant	Table	Peak	Pol.	
Ant.				Limit	Line	Level	Factor	Loss	Factor	Pos	Pos	Avg.		
0+1		( MHz )	( dBμV/m )	( dB )	( dBμV/m )	( dBμV )	( dB/m )	( dB )	( dB )	( cm )	( deg )	(P/A)	(H/V)	
802.11g+ GSM 850 Link LF		78.5	25.02	-14.98	40	43.06	13.35	1.32	32.71	-	-	P	H	
		99.84	25.84	-17.66	43.5	40.82	16.07	1.55	32.6	-	-	P	H	
		159.01	24.76	-18.74	43.5	38.82	16.7	2.02	32.78	-	-	P	H	
		184.23	30.52	-12.98	43.5	46.13	15.03	2.22	32.86	-	-	P	H	
		585.81	27.68	-18.32	46	30.37	25.82	4.16	32.67	-	-	P	H	
		938.89	33.94	-12.06	46	30.07	30.27	5.41	31.81	100	0	P	H	
														H
														H
														H
														H
														H
														H
			38.73	34.72	-5.28	40	46.57	20.12	0.81	32.78	100	19	Q	V
			95.96	33.91	-9.59	43.5	49.54	15.49	1.5	32.62	-	-	P	V
			185.2	32.14	-11.36	43.5	47.73	15.04	2.23	32.86	-	-	P	V
			408.3	28.7	-17.3	46	35.26	22.4	3.43	32.39	-	-	P	V
			666.32	28.65	-17.35	46	30.25	26.45	4.44	32.49	-	-	P	V
			945.68	33.72	-12.28	46	29.32	30.68	5.43	31.71	-	-	P	V
														V
														V
													V	
													V	
													V	
													V	
<b>Remark</b>	1. No other spurious found. 2. All results are PASS against limit line.													



WIFI 802.11b\_Tx\_Ch01+ WWAN LTE B7 BW: 10MHz CH20800 Link

2.4GHz 2400~2483.5MHz

WLAN 802.11b (Band Edge @ 3m)

WIFI Ant.	Note	Frequency	Level	Over Limit	Limit Line	Read Level	Antenna Factor	Path Loss	Preamp Factor	Ant Pos	Table Pos	Peak Avg.	Pol.	
0+1		( MHz )	( dBμV/m )	( dB )	( dBμV/m )	( dBμV )	( dB/m )	( dB )	( dB )	( cm )	( deg )	( P/A )	( H/V )	
802.11b CH 01 2412MHz		2353.575	56.54	-17.46	74	40.64	27.78	18.41	30.29	363	30	P	H	
		2351.055	44.11	-9.89	54	28.2	27.79	18.41	30.29	363	30	A	H	
	*	2412	103.64	29.64	-	-	27.48	18.52	30.27	363	30	P	H	
	*	2412	100.49	46.49	-	-	27.48	18.52	30.27	363	30	A	H	
													H	
													H	
			2311.47	56.39	-17.61	74	40.47	27.88	18.34	30.3	300	265	P	V
			2352.63	44.14	-9.86	54	28.24	27.78	18.41	30.29	300	265	A	V
	*		2412	98.48	24.48	-	-	27.48	18.52	30.27	300	265	P	V
	*		2412	95.32	41.32	-	-	27.48	18.52	30.27	300	265	A	V
													V	
													V	



WIFI 802.11b\_Tx\_Ch01+ WWAN LTE B7 BW: 10MHz CH20800 Link

WIFI 802.11g (Harmonic @ 3m)

WIFI Ant. 0+1	Note	Frequency ( MHz )	Level ( dBμV/m )	Over Limit ( dB )	Limit Line ( dBμV/m )	Read Level ( dBμV )	Antenna Factor ( dB/m )	Path Loss ( dB )	Preamp Factor ( dB )	Ant Pos ( cm )	Table Pos ( deg )	Peak Avg. ( P/A )	Pol. ( H/V )	
802.11b CH 01 2412MHz		4824	40.5	-33.5	74	51.35	31.15	13.36	55.36	100	0	P	H	
		17955	60.23	-13.77	74	43.5	48.35	25.66	57.28	100	0	P	H	
		17955	48.83	-5.17	54	32.1	48.35	25.66	57.28	100	0	A	H	
													H	
													H	
													H	
			4824	40.22	-33.78	74	51.07	31.15	13.36	55.36	100	0	P	V
			17985	60.19	-13.81	74	42.82	48.99	25.67	57.29	100	0	P	V
			17985	49.34	-4.66	54	31.97	48.99	25.67	57.29	100	0	A	V
														V
														V
														V



WIFI 802.11a\_Tx\_Ch36+BT (1M) CH 39\_Tx+ WWAN GSM850 CH189 Link

Band 1 - 5150~5250MHz

WIFI 802.11a (Band Edge @ 3m)

WIFI Ant. 0+1	Note	Frequency ( MHz )	Level ( dBμV/m )	Over Limit ( dB )	Limit Line ( dBμV/m )	Read Level (dBμV)	Antenna Factor ( dB/m )	Path Loss ( dB )	Preamp Factor ( dB )	Ant Pos ( cm )	Table Pos ( deg )	Peak Avg. (P/A)	Pol. (H/V)	
802.11a CH 36 5180MHz		5005.98	53.2	-20.8	74	38.47	31.51	12.87	29.65	242	314	P	H	
		5150	41.19	-12.81	54	26.01	31.8	13.05	29.67	242	314	A	H	
	*	5180	107.41	-	-	92.32	31.68	13.09	29.68	242	314	P	H	
	*	5180	100.29	-	-	85.2	31.68	13.09	29.68	242	314	A	H	
													H	
													H	
													V	
			5148.2	53.71	-20.29	74	38.53	31.8	13.05	29.67	350	4	P	V
			5149.24	40.76	-13.24	54	25.58	31.8	13.05	29.67	350	4	A	V
	*		5180	105.18	-	-	90.09	31.68	13.09	29.68	350	4	P	V
	*		5180	97.57	-	-	82.48	31.68	13.09	29.68	350	4	A	V
														V



**Bluetooth (1M) (Band Edge @ 3m)**

BT	Note	Frequency ( MHz )	Level ( dBμV/m )	Over Limit ( dB )	Limit Line ( dBμV/m )	Read Level ( dBμV )	Antenna Factor ( dB/m )	Path Loss ( dB )	Preamp Factor ( dB )	Ant Pos ( cm )	Table Pos ( deg )	Peak Avg. ( P/A )	Pol. ( H/V )
<b>Bluetooth (1Mbps) CH 39 2441MHz</b>		2363.06	46.43	-27.57	74	40.49	27.72	8.51	30.29	100	199	P	H
		2363.06	21.67	-32.33	54	-	-	-	-	-	-	A	H
	*	2441	100.98	-	-	-	27.42	8.66	30.27	100	199	P	H
	*	2441	76.22	-	-	-	-	-	-	-	-	A	H
		2493.28	46.3	-27.7	74	40.39	27.4	8.76	30.25	100	199	P	H
		2493.28	21.54	-32.46	54	-	-	-	-	-	-	A	H
		2346.96	46.57	-27.43	74	40.57	27.81	8.48	30.29	141	68	P	V
		2346.96	21.81	-32.19	54	-	-	-	-	-	-	A	V
	*	2441	102.74	-	-	-	27.42	8.66	30.27	141	68	P	V
	*	2441	77.98	-	-	-	-	-	-	-	-	A	V
		2496.22	45.67	-28.33	74	39.75	27.4	8.77	30.25	141	68	P	V
		2496.22	20.91	-33.09	54	-	-	-	-	-	-	A	V



WIFI 802.11a\_Tx\_Ch36+BT (1M) CH 39\_Tx+ WWAN GSM850 CH189 Link  
(Harmonic @ 3m)

ANT	Note	Frequency ( MHz )	Level ( dBµV/m )	Over Limit ( dB )	Limit Line ( dBµV/m )	Read Level ( dBµV )	Antenna Factor ( dB/m )	Path Loss ( dB )	Preamp Factor ( dB )	Ant Pos ( cm )	Table Pos ( deg )	Peak Avg. (P/A)	Pol. (H/V)
11a_Ch36+ BT_Ch39+ GSM850 Link		4882	55.93	-18.07	74	39.86	31.14	14.56	29.63	100	0	P	H
		4882	31.17	-22.83	54	-	-	-	-	-	-	A	H
		7323	47.5	-26.5	74	50.69	36.45	16.62	56.26	100	0	P	H
		7323	22.74	-31.26	54	-	-	-	-	-	-	A	H
		10360	57.82	-10.38	68.2	55.22	39.44	19.39	56.23	100	0	P	H
		15540	47.21	-26.79	74	41.42	37.98	23.22	55.41	100	0	P	H
		17967	59.65	-14.35	74	42.89	48.61	25.44	57.29	100	0	P	H
		17967	48.88	-5.12	54	32.12	48.61	25.44	57.29	100	0	A	H
		4882	55.51	-18.49	74	39.44	31.14	14.56	29.63	100	0	P	V
		4882	30.75	-23.25	54	-	-	-	-	-	-	A	V
		7323	46.44	-27.56	74	49.63	36.45	16.62	56.26	100	0	P	V
		7323	21.68	-32.32	54	-	-	-	-	-	-	A	V
		10360	55.81	-12.39	68.2	53.21	39.44	19.39	56.23	100	0	P	V
		15540	48.09	-25.91	74	42.3	37.98	23.22	55.41	100	0	P	V
		17967	59.41	-14.59	74	42.65	48.61	25.44	57.29	100	0	P	V
	17967	48.65	-5.35	54	31.89	48.61	25.44	57.29	100	0	A	V	





WLAN 802.11a\_Tx\_Ch36+BT (1M) CH 39\_Tx+ WWAN LTE B7 BW: 10MHz CH20800

Band 1 - 5150~5250MHz

WIFI 802.11a (Band Edge @ 3m)

WIFI Ant. 0+1	Note	Frequency ( MHz )	Level ( dBμV/m )	Over Limit ( dB )	Limit Line ( dBμV/m )	Read Level (dBμV)	Antenna Factor ( dB/m )	Path Loss ( dB )	Preamp Factor ( dB )	Ant Pos ( cm )	Table Pos ( deg )	Peak Avg. (P/A)	Pol. (H/V)	
802.11a CH 36 5180MHz		5001.04	54.05	-19.95	74	39.34	31.5	12.86	29.65	286	300	P	H	
		5069.68	42.56	-11.44	54	27.59	31.68	12.95	29.66	286	300	A	H	
	*	5180	106.44	-	-	91.35	31.68	13.09	29.68	286	300	P	H	
	*	5180	99.06	-	-	83.97	31.68	13.09	29.68	286	300	A	H	
													H	
														H
														V
			5068.9	53.99	-20.01	74	39.02	31.68	12.95	29.66	387	345	P	V
			5069.68	44.36	-9.64	54	29.39	31.68	12.95	29.66	387	345	A	V
	*		5180	105.14	-	-	90.05	31.68	13.09	29.68	387	345	P	V
	*		5180	96.86	-	-	81.77	31.68	13.09	29.68	387	345	A	V
														V



2.4GHz 2400~2483.5MHz

BT (Band Edge @ 3m)

BT	Note	Frequency ( MHz )	Level ( dBμV/m )	Over Limit ( dB )	Limit Line ( dBμV/m )	Read Level ( dBμV )	Antenna Factor ( dB/m )	Path Loss ( dB )	Preamp Factor ( dB )	Ant Pos ( cm )	Table Pos ( deg )	Peak Avg. (P/A)	Pol. (H/V)
BT CH 39 2441MHz		2345.14	46.92	-27.08	74	40.92	27.81	8.48	30.29	400	303	P	H
		2345.14	22.16	-31.84	54	-	-	-	-	-	-	A	H
	*	2441	100.03	-	-	-	27.42	8.66	30.27	400	303	P	H
	*	2441	75.27	-	-	-	-	-	-	-	-	A	H
		2492.86	46.12	-27.88	74	40.21	27.4	8.76	30.25	400	303	P	H
		2492.86	21.36	-32.64	54	-	-	-	-	-	-	A	H
		2333.94	46.71	-27.29	74	40.72	27.83	8.46	30.3	301	104	P	V
		2333.94	21.95	-32.05	54	-	-	-	-	-	-	A	V
	*	2441	100.44	-	-	-	27.42	8.66	30.27	301	104	P	V
	*	2441	75.68	-	-	-	-	-	-	-	-	A	V
		2483.97	47.18	-26.82	74	41.29	27.4	8.74	30.25	301	104	P	V
		2483.97	22.42	-31.58	54	-	-	-	-	-	-	A	V



WIFI 802.11a\_Tx\_Ch36+BT (1M) CH 39\_Tx+ WWAN LTE B7 BW: 10MHz CH20800 LINK  
(Harmonic @ 3m)

BT	Note	Frequency ( MHz )	Level ( dBµV/m )	Over Limit ( dB )	Limit Line ( dBµV/m )	Read Level ( dBµV )	Antenna Factor ( dB/m )	Path Loss ( dB )	Preamp Factor ( dB )	Ant Pos ( cm )	Table Pos ( deg )	Peak Avg. (P/A)	Pol. (H/V)
11a_Ch36+ BT_Ch39+ LTE B7 Link		4882	56.17	-17.83	74	40.1	31.14	14.56	29.63	100	0	P	H
		4882	31.41	-22.59	54	-	-	-	-	-	-	A	H
		7323	47.1	-26.9	74	50.29	36.45	16.62	56.26	100	0	P	H
		7323	22.34	-31.66	54	-	-	-	-	-	-	A	H
		10360	58.09	-10.11	68.2	55.49	39.44	19.39	56.23	100	0	P	H
		15540	47.72	-26.28	74	41.93	37.98	23.22	55.41	100	0	P	H
		17956	60.82	-13.18	74	44.28	48.38	25.44	57.28	100	0	P	H
		17956	49.65	-4.35	54	33.11	48.38	25.44	57.28	100	0	A	H
		4882	54.88	-19.12	74	38.81	31.14	14.56	29.63	100	0	P	V
		4882	30.12	-23.88	54	-	-	-	-	-	-	A	V
		7323	46.25	-27.75	74	49.44	36.45	16.62	56.26	100	0	P	V
		7323	21.49	-32.51	54	-	-	-	-	-	-	A	V
		10360	57.68	-10.52	68.2	55.08	39.44	19.39	56.23	100	0	P	V
		15540	47.98	-26.02	74	42.19	37.98	23.22	55.41	100	0	P	V
		17956	60.42	-13.58	74	43.88	48.38	25.44	57.28	100	0	P	V
	17956	49.1	-4.9	54	32.56	48.38	25.44	57.28	100	0	A	V	



Emission above 18GHz

WIFI	Note	Frequency	Level	Over	Limit	Read	Antenna	Path	Preamp	Ant	Table	Peak	Pol.
Ant.				Limit	Line	Level	Factor	Loss	Factor	Pos	Pos	Avg.	
0+1		( MHz )	( dBµV/m )	( dB )	( dBµV/m )	( dBµV )	( dB/m )	( dB )	( dB )	( cm )	( deg )	( P/A )	( H/V )
11a_Ch36+		25502	41.07	-27.13	68.2	40.84	39.8	23.37	53.4	150	0	P	H
		34302	43.24	-24.96	68.2	39.5	41.06	27.66	55.44	150	0	P	H
													H
													H
													H
													H
													H
													H
													H
													H
BT_Ch39+													H
													H
													H
													H
													H
													H
													H
													H
													H
													H
LTE B7 Link		20574	38.87	-35.13	74	43.08	38.06	20.76	53.49	150	0	P	V
		30606	43.46	-24.74	68.2	41.92	40.46	25.86	55.24	150	0	P	V
													V
													V
													V
													V
													V
													V
													V
													V
Remark	1. No other spurious found. 2. All results are PASS against limit line.												



Emission below 1GHz

WIFI	Note	Frequency	Level	Over	Limit	Read	Antenna	Path	Preamp	Ant	Table	Peak	Pol.	
Ant.				Limit	Line	Level	Factor	Loss	Factor	Pos	Pos	Avg.		
0+1		( MHz )	( dBμV/m )	( dB )	( dBμV/m )	( dBμV )	( dB/m )	( dB )	( dB )	( cm )	( deg )	(P/A)	(H/V)	
11a_Ch36+ BT_Ch39+ LTE B7 Link		64.92	26.41	-13.59	40	46.09	11.92	1.18	32.78	-	-	P	H	
		78.5	27.28	-12.72	40	45.32	13.35	1.32	32.71	-	-	P	H	
		157.07	24.91	-18.59	43.5	38.88	16.81	2	32.78	-	-	P	H	
		183.26	27.93	-15.57	43.5	43.51	15.05	2.23	32.86	-	-	P	H	
		770.11	30.34	-15.66	46	30.15	28.12	4.79	32.72	-	-	P	H	
		954.41	34.79	-11.21	46	30	30.9	5.46	31.57	100	0	P	H	
													H	
													H	
													H	
													H	
													H	
													H	
													H	
			38.73	35.46	-4.54	40	47.31	20.12	0.81	32.78	100	27	Q	V
			71.71	34.46	-5.54	40	53.44	12.51	1.25	32.74	-	-	P	V
			94.99	30.87	-12.63	43.5	46.72	15.29	1.49	32.63	-	-	P	V
			184.23	34.38	-9.12	43.5	49.99	15.03	2.22	32.86	-	-	P	V
			723.55	30.34	-15.66	46	30.77	27.44	4.64	32.51	-	-	P	V
			946.65	34.07	-11.93	46	29.64	30.69	5.43	31.69	-	-	P	V
													V	
												V		
												V		
												V		
												V		
												V		
<b>Remark</b>	1. No other spurious found. 2. All results are PASS against limit line.													



**Note symbol**

*	<b>Fundamental Frequency</b> which can be ignored. However, the level of any unwanted emissions shall not exceed the level of the fundamental frequency.
-	The signal is <b>Unintentional Radiators</b> .
P/A	<b>Peak or Average</b>
H/V	<b>Horizontal or Vertical</b>



A calculation example for radiated spurious emission is shown as below:

WIFI	Note	Frequency	Level	Over	Limit	Read	Antenna	Path	Preamp	Ant	Table	Peak	Pol.
Ant.				Limit	Line	Level	Factor	Loss	Factor	Pos	Pos	Avg.	
Simultaneously		( MHz )	( dBμV/m )	( dB )	( dBμV/m )	( dBμV )	( dB/m )	( dB )	( dB )	( cm )	( deg )	( P/A )	( H/V )
802.11b		2390	55.45	-18.55	74	54.51	32.22	4.58	35.86	103	308	P	H
CH 01													
2412MHz		2390	43.54	-10.46	54	42.6	32.22	4.58	35.86	103	308	A	H

1. Path Loss(dB) = Cable loss(dB) + Filter loss(dB) + Attenuator loss(dB)
2. Level(dBμV/m) = Antenna Factor(dB/m) + Path Loss(dB) + Read Level(dBμV) - Preamp Factor(dB)
3. Over Limit(dB) = Level(dBμV/m) – Limit Line(dBμV/m)

**For Peak Limit @ 2390MHz:**

1. Level(dBμV/m)  
= Antenna Factor(dB/m) + Path Loss(dB) + Read Level(dBμV) - Preamp Factor(dB)  
= 32.22(dB/m) + 4.58(dB) + 54.51(dBμV) – 35.86 (dB)  
= 55.45 (dBμV/m)
2. Over Limit(dB)  
= Level(dBμV/m) – Limit Line(dBμV/m)  
= 55.45(dBμV/m) – 74(dBμV/m)  
= -18.55(dB)

**For Average Limit @ 2390MHz:**

1. Level(dBμV/m)  
= Antenna Factor(dB/m) + Path Loss(dB) + Read Level(dBμV) - Preamp Factor(dB)  
= 32.22(dB/m) + 4.58(dB) + 42.6(dBμV) – 35.86 (dB)  
= 43.54 (dBμV/m)
2. Over Limit(dB) = Level(dBμV/m) – Limit Line(dBμV/m)  
= 43.54(dBμV/m) – 54(dBμV/m)  
= -10.46(dB)

Both peak and average measured complies with the limit line, so test result is “PASS”.



## Appendix B. Radiated Spurious Emission

Test Engineer :	Karl Hou, CR Liro and Andy Yang	Temperature :	20~25°C
		Relative Humidity :	50~60%

WLAN 802.11g\_Tx\_Ch01+ WWAN GSM850 Ch189 Link

2.4GHz 2400~2483.5MHz

WIFI 802.11g (Band Edge @ 3m)

WIFI	2.4GHz 2400~2483.5MHz Band Edge @ 3m	
ANT	802.11g CH01 2412MHz	
0+1	Horizontal	Fundamental
Peak	<p>Site Condition : 03CH16-HY : PEAK_BE_74 3m 91200_1522 HORIZONTAL : RBW:1000.000kHz VBW:3000.000kHz SWT:Auto</p>	<p>Site Condition : 03CH16-HY : PEAK_74 3m 91200_1522 HORIZONTAL : RBW:1000.000kHz VBW:3000.000kHz SWT:Auto</p>
Avg.	<p>Site Condition : 03CH16-HY : AVG_BE_54 3m 91200_1522 HORIZONTAL : RBW:1000.000kHz VBW:0.010kHz SWT:Auto</p>	<p>Site Condition : 03CH16-HY : AVG_54 3m 91200_1522 HORIZONTAL : RBW:1000.000kHz VBW:0.010kHz SWT:Auto</p>



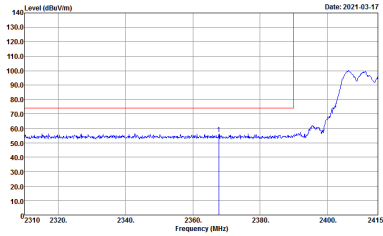
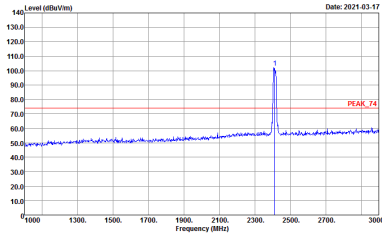
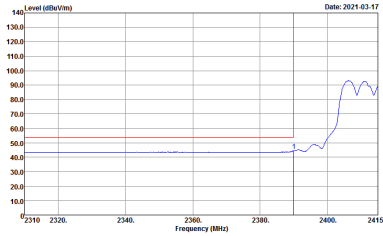
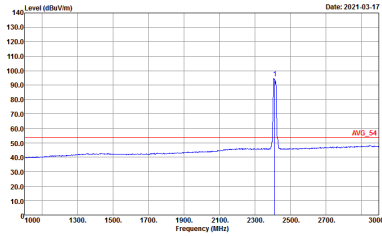

WIFI	2.4GHz 2400~2483.5MHz Band Edge @ 3m	
ANT	802.11b CH01 2412MHz	
0+1	Vertical	Fundamental
Peak	 <p>Level (dBuV/m) vs Frequency (MHz) plot for Peak Vertical. The y-axis ranges from 10.0 to 140.0 dBuV/m, and the x-axis ranges from 2310 to 2415 MHz. A red vertical line is at approximately 2412 MHz. The plot shows a blue signal line with a peak at 2412 MHz reaching approximately 100 dBuV/m. A red horizontal line is at approximately 75 dBuV/m.</p> <p>Site : 03CH16-HY            Condition : PEAK_BE_74 3m 91200_1522 VERTICAL            : RBW:1000.000KHz VBW:3000.000KHz SWT:Auto</p>	 <p>Level (dBuV/m) vs Frequency (MHz) plot for Peak Fundamental. The y-axis ranges from 10.0 to 140.0 dBuV/m, and the x-axis ranges from 1600 to 3000 MHz. A red vertical line is at approximately 2412 MHz. The plot shows a blue signal line with a sharp peak at 2412 MHz reaching approximately 100 dBuV/m. A red horizontal line is at approximately 75 dBuV/m, labeled 'PEAK_74'.</p> <p>Site : 03CH16-HY            Condition : PEAK_74 3m 91200_1522 VERTICAL            : RBW:1000.000KHz VBW:3000.000KHz SWT:Auto</p>
Avg.	 <p>Level (dBuV/m) vs Frequency (MHz) plot for Avg Vertical. The y-axis ranges from 10.0 to 140.0 dBuV/m, and the x-axis ranges from 2310 to 2415 MHz. A red vertical line is at approximately 2412 MHz. The plot shows a blue signal line with a peak at 2412 MHz reaching approximately 100 dBuV/m. A red horizontal line is at approximately 75 dBuV/m.</p> <p>Site : 03CH16-HY            Condition : AV6_BE_54 3m 91200_1522 VERTICAL            : RBW:1000.000KHz VBW:0.010KHz SWT:Auto</p>	 <p>Level (dBuV/m) vs Frequency (MHz) plot for Avg Fundamental. The y-axis ranges from 10.0 to 140.0 dBuV/m, and the x-axis ranges from 1600 to 3000 MHz. A red vertical line is at approximately 2412 MHz. The plot shows a blue signal line with a sharp peak at 2412 MHz reaching approximately 100 dBuV/m. A red horizontal line is at approximately 75 dBuV/m, labeled 'AVG_54'.</p> <p>Site : 03CH16-HY            Condition : AV6_54 3m 91200_1522 VERTICAL            : RBW:1000.000KHz VBW:0.010KHz SWT:Auto</p>

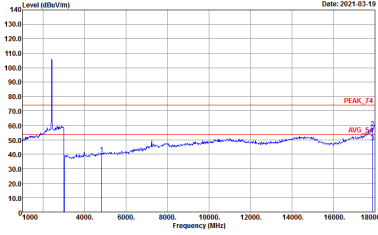
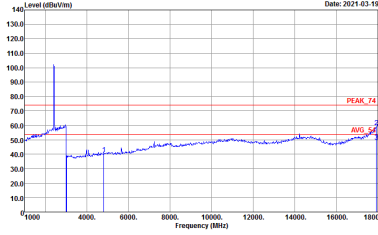

WLAN 802.11g\_Tx\_Ch01+ WWAN GSM850 Ch189 Link  
(Harmonic @ 3m)

ANT	WLAN 802.11g_Tx_Ch01+ WWAN GSM850 Ch189	
0+1	Horizontal	Vertical
<p>Peak</p> <p>Avg.</p>	 <p>Site : 03CH16-HY Condition : PEAK_74 3m 91200_1522 HORIZONTAL -RBW:1000.000KHz VBW:3000.000KHz SWT:Auto</p>	 <p>Site : 03CH16-HY Condition : PEAK_74 3m 91200_1522 VERTICAL -RBW:1000.000KHz VBW:3000.000KHz SWT:Auto</p>



Emission above 18GHz

ANT	WLAN 802.11g_Tx_Ch01+ WWAN GSM850 Ch189 SHF	
0+1	Horizontal	Vertical
QP / Peak	<p>Site : 03CH16-HY Condition : PEAK_74 1m SHF HORN 88HA9170584 HORIZONTAL</p>	<p>Site : 03CH16-HY Condition : PEAK_74 1m SHF HORN 88HA9170584 VERTICAL</p>

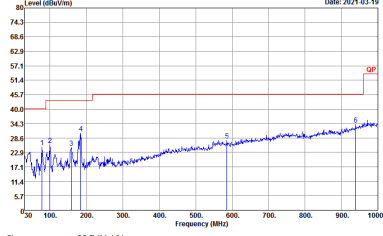
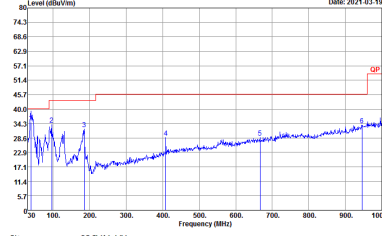

Emission below 1GHz

ANT	WLAN 802.11g_Tx_Ch01+ WWAN GSM850 Ch189 LF	
0+1	Horizontal	Vertical
QP / Peak	 <p>Site : 03CH16-HY Condition : QP 3m BIL06_47020406 HORIZONTAL</p>	 <p>Site : 03CH16-HY Condition : QP 3m BIL06_47020406 VERTICAL</p>



WLAN 802.11b\_Tx\_Ch01+ WWAN LTE B7 BW: 10MHz CH20800 Link

2.4GHz 2400~2483.5MHz

WIFI 802.11b (Band Edge @ 3m)

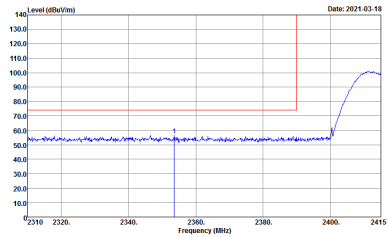
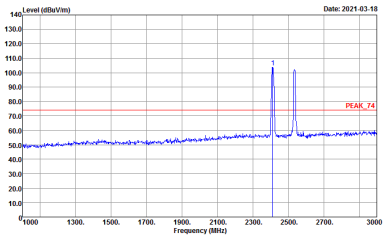
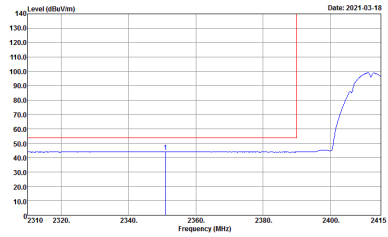
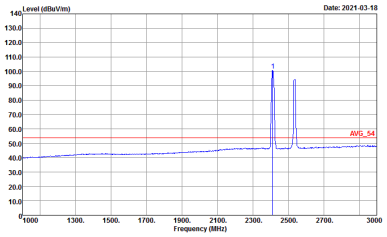
WIFI	2.4GHz 2400~2483.5MHz Band Edge @ 3m	
ANT	802.11b CH01 2412MHz	
0+1	Horizontal	Fundamental
Peak	 <p>Site : 03CH16-HY Condition : PEAK_BE_74 3m 91200_1522 HORIZONTAL : RBW:1000.000KHz VBW:3000.000KHz SWT:Auto</p>	 <p>Site : 03CH16-HY Condition : PEAK_74 3m 91200_1522 HORIZONTAL : RBW:1000.000KHz VBW:3000.000KHz SWT:Auto</p>
Avg.	 <p>Site : 03CH16-HY Condition : AVG_BE_54 3m 91200_1522 HORIZONTAL : RBW:1000.000KHz VBW:0.010KHz SWT:Auto</p>	 <p>Site : 03CH16-HY Condition : AVG_54 3m 91200_1522 HORIZONTAL : RBW:1000.000KHz VBW:0.010KHz SWT:Auto</p>



WIFI	2.4GHz 2400~2483.5MHz Band Edge @ 3m	
ANT	802.11b CH01 2412MHz	
0+1	Vertical	Fundamental
Peak	<p>Site : 03CH16-HY Condition : PEAK_BE_74 3m 91200_1522 VERTICAL : RBW:1000.000kHz VBW:3000.000kHz SWT:Auto</p>	<p>Site : 03CH16-HY Condition : PEAK_74 3m 91200_1522 VERTICAL : RBW:1000.000kHz VBW:3000.000kHz SWT:Auto</p>
Avg.	<p>Site : 03CH16-HY Condition : AVG_BE_54 3m 91200_1522 VERTICAL : RBW:1000.000kHz VBW:0.010kHz SWT:Auto</p>	<p>Site : 03CH16-HY Condition : AVG_54 3m 91200_1522 VERTICAL : RBW:1000.000kHz VBW:0.010kHz SWT:Auto</p>

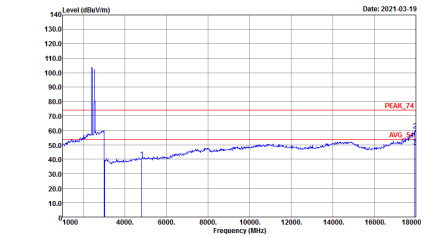
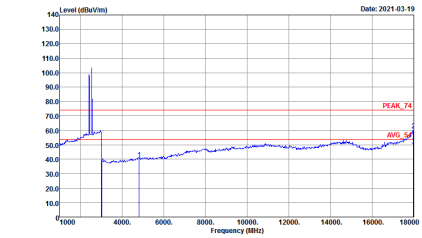

WLAN 802.11b\_Tx\_Ch01+ WWAN LTE B7 BW: 10MHz CH20800 Link  
(Harmonic @ 3m)

ANT	WLAN 802.11b_Tx_Ch01+ WWAN LTE B7 BW: 10MHz CH20800	
0+1	Horizontal	Vertical
Peak	 <p>Site : 03CH16-HY Condition : PEAK_74 3m 91200_1522 HORIZONTAL -RBW:1000.000kHz VBW:3000.000kHz SWT:Auto</p>	 <p>Site : 03CH16-HY Condition : PEAK_74 3m 91200_1522 VERTICAL -RBW:1000.000kHz VBW:3000.000kHz SWT:Auto</p>
Avg.		



WLAN 802.11a\_Tx\_Ch36+BT (1M) CH 39\_Tx+ WWAN GSM850 Ch189 Link

Band 1 - 5150~5250MHz

WIFI 802.11a (Band Edge @ 3m)

WIFI	Band 1 5150~5250MHz Band Edge @ 3m	
ANT	802.11a CH36 5180MHz	
0+1	Horizontal	Fundamental
Peak	<p>Site Condition : 03CH16-IY : PEAK_BE_74 3m 91200_1522 HORIZONTAL : RBW:1000.000KHz VBW:3000.000KHz SWT:Auto</p>	<p>Site Condition : 03CH16-IY : PEAK(UNII) 3m 91200_1522 HORIZONTAL : RBW:1000.000KHz VBW:3000.000KHz SWT:Auto</p>
Avg.	<p>Site Condition : 03CH16-IY : AV6_BE_54 3m 91200_1522 HORIZONTAL : RBW:1000.000KHz VBW:0.010KHz SWT:Auto</p>	Left blank



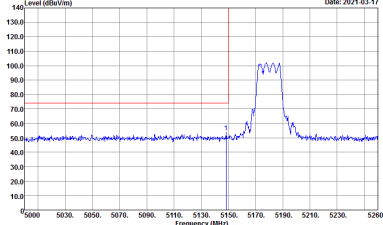
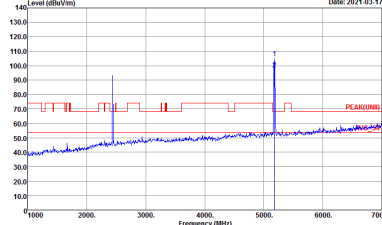
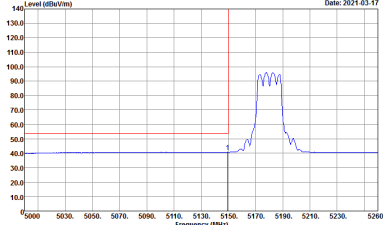

WIFI	Band 1 5150~5250MHz Band Edge @ 3m	
ANT	802.11a CH36 5180MHz	
0+1	Vertical	Fundamental
Peak	 <p>Date: 2021-03-17</p> <p>Site : 03CH16-HY Condition : PEAK_BE_74 3m 91200_1522 VERTICAL RBW:1000.000KHz VBW:3000.000KHz SWT:Auto</p>	 <p>Date: 2021-03-17</p> <p>Site : 03CH16-HY Condition : PEAK(UNIT) 3m 91200_1522 VERTICAL RBW:1000.000KHz VBW:3000.000KHz SWT:Auto</p>
Avg.	 <p>Date: 2021-03-17</p> <p>Site : 03CH16-HY Condition : AVG_BE_54 3m 91200_1522 VERTICAL RBW:1000.000KHz VBW:0.010KHz SWT:Auto</p>	Left blank



2.4GHz 2400~2483.5MHz

BT (Band Edge @ 3m)

BT	2.4GHz 2400~2483.5MHz Band Edge @ 3m	
ANT	BT CH39 2441MHz	
0	Horizontal	Fundamental
Peak	<p>Site : 03CH16-14Y Condition : PEAK_BE_74 3m 91200_1522 HORIZONTAL : RBW:1000.000KHz VBW:3000.000KHz SWT:Auto</p>	<p>Site : 03CH16-14Y Condition : PEAK_74 3m 91200_1522 HORIZONTAL : RBW:1000.000KHz VBW:3000.000KHz SWT:Auto</p>
Peak	<p>Site : 03CH16-14Y Condition : PEAK_BE_74 3m 91200_1522 HORIZONTAL : RBW:1000.000KHz VBW:3000.000KHz SWT:Auto</p>	Left blank

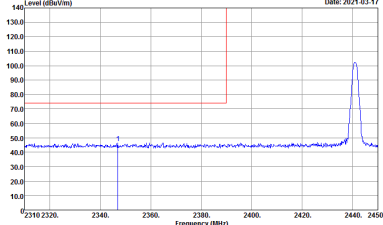
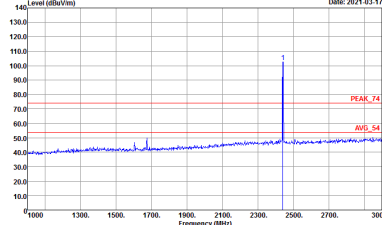
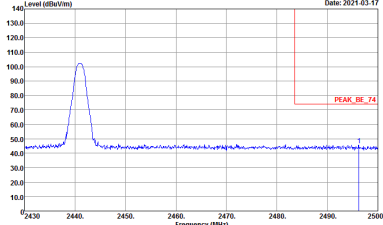

BT	2.4GHz 2400~2483.5MHz Band Edge @ 3m	
ANT	BT CH39 2441MHz	
0+1	Vertical	Fundamental
Peak	 <p>Site : 03CH16-HY Condition : PEAK_BE_74 3m 91200_1522 VERTICAL : RBW:1000.000kHz VBW:3000.000kHz SWT:Auto</p>	 <p>Site : 03CH16-HY Condition : PEAK_74 3m 91200_1522 VERTICAL : RBW:1000.000kHz VBW:3000.000kHz SWT:Auto</p>
Peak	 <p>Site : 03CH16-HY Condition : PEAK_BE_74 3m 91200_1522 VERTICAL : RBW:1000.000kHz VBW:3000.000kHz SWT:Auto</p>	Left blank

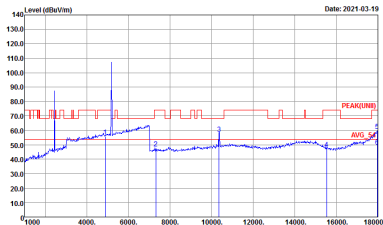
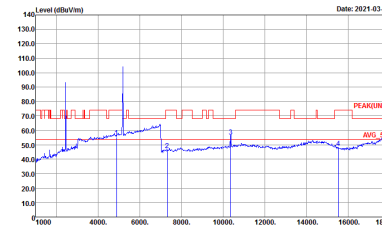

WLAN 802.11a\_Tx\_Ch36+BT (1M) CH 39\_Tx+ WWAN GSM850 Ch189 Link  
(Harmonic @ 3m)

ANT	WLAN 802.11a_Tx_Ch36+BT (1M) CH 39_Tx+ WWAN GSM850 Ch189	
0+1	Horizontal	Vertical
Peak	 <p>Site : 03CH16-HY Condition : PEAK(UNIT) 3m 91200_1522 HORIZONTAL : RBW:1000.000KHz VBW:3000.000KHz SWT:Auto</p>	 <p>Site : 03CH16-HY Condition : PEAK(UNIT) 3m 91200_1522 VERTICAL : RBW:1000.000KHz VBW:3000.000KHz SWT:Auto</p>
Avg.		



WLAN 802.11a\_Tx\_Ch36+BT (1M) CH 39\_Tx+ WWAN LTE B7 BW: 10MHz CH20800 Link

Band 1 - 5150~5250MHz  
WIFI 802.11a (Band Edge @ 3m)

WIFI	Band 1 5150~5250MHz Band Edge @ 3m	
ANT	802.11a CH36 5180MHz	
0+1	Horizontal	Fundamental
Peak	<p>Site Condition : 03CH16-IY : PEAK_BE_74 3m 91200_1522 HORIZONTAL : RBW:1000.000KHz VBW:3000.000KHz SWT:Auto</p>	<p>Site Condition : 03CH16-IY : PEAK(UNITE) 3m 91200_1522 HORIZONTAL : RBW:1000.000KHz VBW:3000.000KHz SWT:Auto</p>
Avg.	<p>Site Condition : 03CH16-IY : AVG_BE_54 3m 91200_1522 HORIZONTAL : RBW:1000.000KHz VBW:0.010KHz SWT:Auto</p>	Left blank



WIFI	Band 1 5150~5250MHz Band Edge @ 3m	
ANT	802.11a CH36 5180MHz	
0+1	Vertical	Fundamental
Peak	<p>Site : 03CH16-HY Condition : PEAK_BE_74 3m 91200_1522 VERTICAL RBW:1000.000KHz VBW:3000.000KHz SWT:Auto</p>	<p>Site : 03CH16-HY Condition : PEAK(UNIT) 3m 91200_1522 VERTICAL RBW:1000.000KHz VBW:3000.000KHz SWT:Auto</p>
Avg.	<p>Site : 03CH16-HY Condition : AVG_BE_54 3m 91200_1522 VERTICAL RBW:1000.000KHz VBW:0.010KHz SWT:Auto</p>	Left blank



2.4GHz 2400~2483.5MHz

BT (Band Edge @ 3m)

BT	2.4GHz 2400~2483.5MHz Band Edge @ 3m	
ANT	BT CH39 2441MHz	
0+1	Horizontal	Fundamental
Peak	<p>Site : 03CH16-14Y Condition : PEAK_BE_74 3m 91200_1522 HORIZONTAL : RBW:1000.000KHz VBW:3000.000KHz SWT:Auto</p>	<p>Site : 03CH16-14Y Condition : PEAK_74 3m 91200_1522 HORIZONTAL : RBW:1000.000KHz VBW:3000.000KHz SWT:Auto</p>
Peak	<p>Site : 03CH16-14Y Condition : PEAK_BE_74 3m 91200_1522 HORIZONTAL : RBW:1000.000KHz VBW:3000.000KHz SWT:Auto</p>	Left blank



BT	2.4GHz 2400~2483.5MHz Band Edge @ 3m	
ANT	BT CH39 2441MHz	
0+1	Vertical	Fundamental
Peak	<p>Site : 03CH16-HY Condition : PEAK_BE_74 3m 91200_1522 VERTICAL : RBW:1000.000KHz VBW:3000.000KHz SWT:Auto</p>	<p>Site : 03CH16-HY Condition : PEAK_74 3m 91200_1522 VERTICAL : RBW:1000.000KHz VBW:3000.000KHz SWT:Auto</p>
Peak	<p>Site : 03CH16-HY Condition : PEAK_BE_74 3m 91200_1522 VERTICAL : RBW:1000.000KHz VBW:3000.000KHz SWT:Auto</p>	Left blank





WLAN 802.11a\_Tx\_Ch36+BT (1M) CH 39\_Tx+ WWAN LTE B7 BW: 10MHz CH20800 Link

(Harmonic @ 3m)

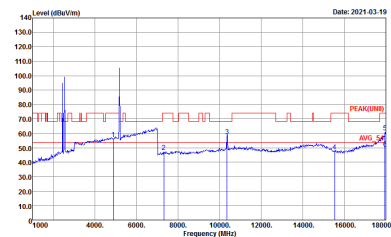
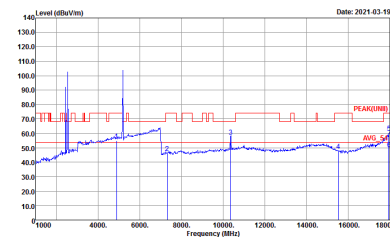
ANT	WLAN 802.11a_Tx_Ch36+BT (1M) CH 39_Tx+ WWAN LTE B7 BW: 10MHz CH20800	
0+1	Horizontal	Vertical
Peak Avg.	 <p>Site : 03CH16-HY Condition : PEAK(UNIT) 3m 91200_1522 HORIZONTAL -RBW:1000.000kHz VBW:3000.000kHz SWT:Auto</p>	 <p>Site : 03CH16-HY Condition : PEAK(UNIT) 3m 91200_1522 VERTICAL -RBW:1000.000kHz VBW:3000.000kHz SWT:Auto</p>



Emission above 18GHz

ANT	<p>WLAN 802.11a_Tx_Ch36+BT (1M) CH 39_Tx+          WWAN LTE B7 BW: 10MHz CH20800</p>	
0+1	Horizontal	Vertical
QP / Peak	<div style="display: flex; justify-content: space-around;"> <div data-bbox="391 548 837 817"> <p>Site : 03CH16-HY              Condition : PEAK(LIN) 1m SHF HORN 88HA9170584 HORIZONTAL</p> </div> <div data-bbox="869 548 1300 817"> <p>Site : 03CH16-HY              Condition : PEAK(LIN) 1m SHF HORN 88HA9170584 VERTICAL</p> </div> </div>	

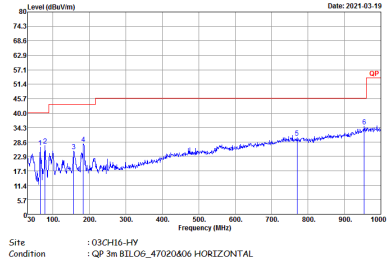
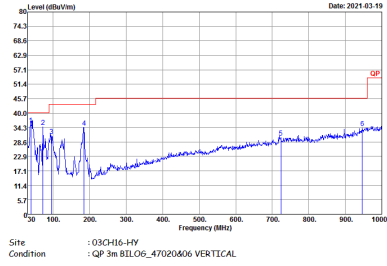

Emission below 1GHz

ANT	WLAN 802.11a_Tx_Ch36+BT (1M) CH 39_Tx+ WWAN LTE B7 BW: 10MHz CH20800	
0+1	Horizontal	Vertical
QP / Peak	 <p>Site : 03CH16-HY Condition : QP 3m BIL06_47020406 HORIZONTAL</p>	 <p>Site : 03CH16-HY Condition : QP 3m BIL06_47020406 VERTICAL</p>



# Appendix C. Duty Cycle Plots

<Ant. 0>

<1Mbps>

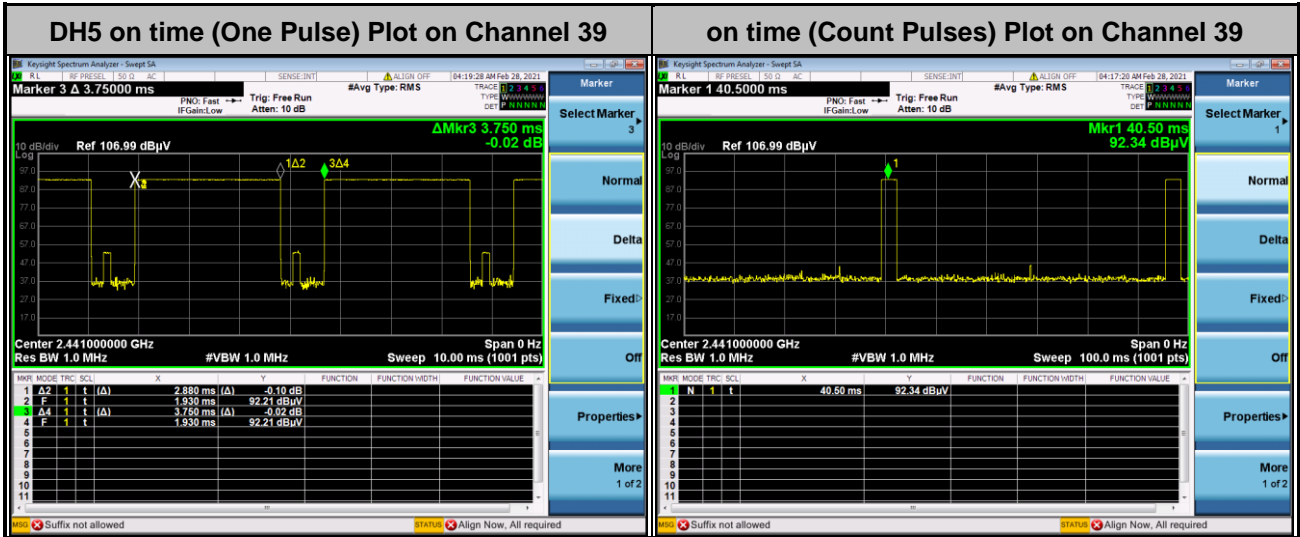

**Note:**

1. Worst case Duty cycle = on time/100 milliseconds =  $2 * 2.88 / 100 = 5.76 \%$
2. Worst case Duty cycle correction factor =  $20 * \log(\text{Duty cycle}) = -24.79 \text{ dB}$
3. DH5 has the highest duty cycle worst case and is reported.

**Duty Cycle Correction Factor Consideration for AFH mode:**

Bluetooth normal hopping rate is 1600Hz and reduced to 800Hz in AFH mode; due to the reduced number of hopping frequencies, with the same packet configuration the dwell time in each channel frequency within 100msec period is longer in AFH mode than normal mode.

In AFH mode, the minimum hopping frequencies are 20, to get the longest dwell time DH5 packet is observed; the period to have DH5 packet completing one hopping sequence is

$$2.88 \text{ ms} \times 20 \text{ channels} = 57.6 \text{ ms}$$

There cannot be 2 complete hopping sequences within 100ms period, considering the random hopping behavior, maximum 2 hops can be possibly observed within the period.  $[100 \text{ ms} / 57.6 \text{ ms}] = 2 \text{ hops}$

Thus, the maximum possible ON time:

$$2.88 \text{ ms} \times 2 = 5.76 \text{ ms}$$

Worst case Duty Cycle Correction factor, which is derived from the maximum possible ON time,

$$20 \times \log(5.76 \text{ ms}/100 \text{ ms}) = -24.79 \text{ dB}$$



Antenna	Band	Duty Cycle(%)	T(us)	1/T(kHz)	VBW Setting	Duty Factor(dB)
0+1	2.4GHz 802.11b for Ant. 0	100.00	-	-	10Hz	0.00
0+1	2.4GHz 802.11b for Ant. 1	100.00	-	-	10Hz	0.00
0+1	2.4GHz 802.11g for Ant. 0	99.05	-	-	10Hz	0.04
0+1	2.4GHz 802.11g for Ant. 1	99.29	-	-	10Hz	0.03
0+1	5GHz 802.11a for Ant. 0	99.24	-	-	10Hz	0.03
0+1	5GHz 802.11a for Ant. 1	99.24	-	-	10Hz	0.03



MIMO <Ant. 0>

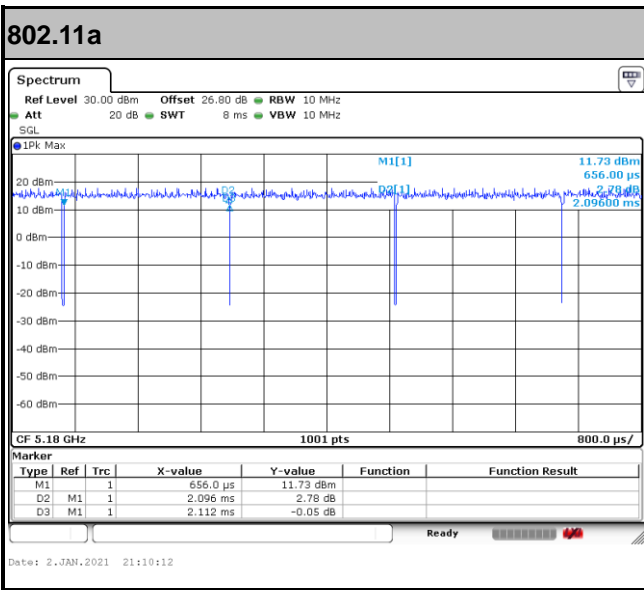
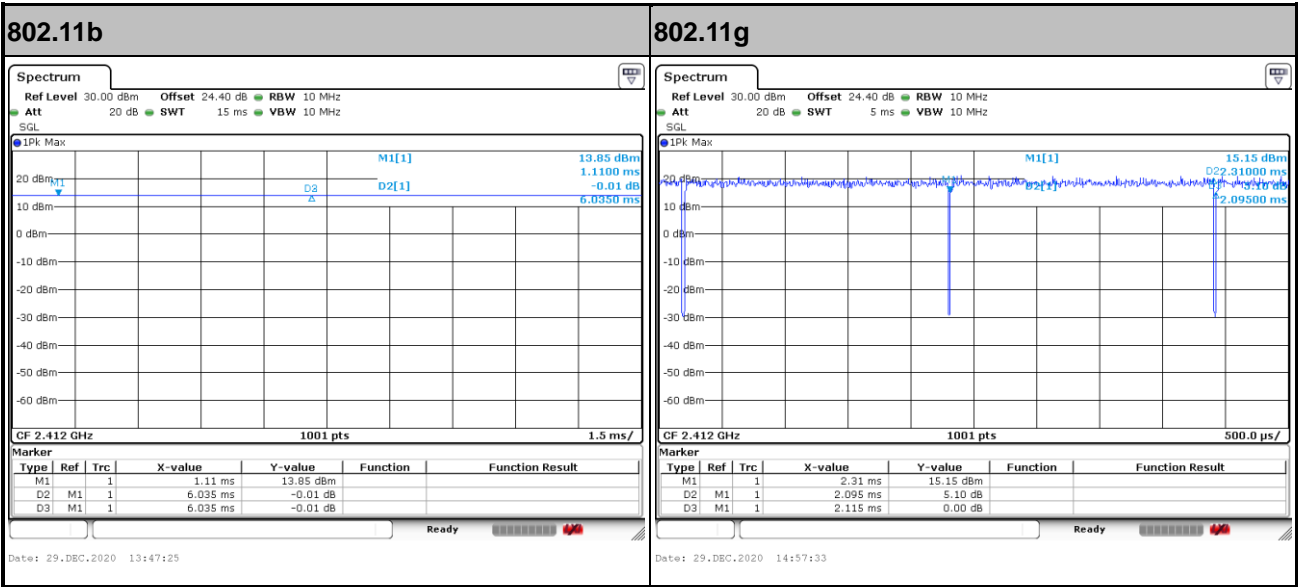



MIMO <Ant. 1>

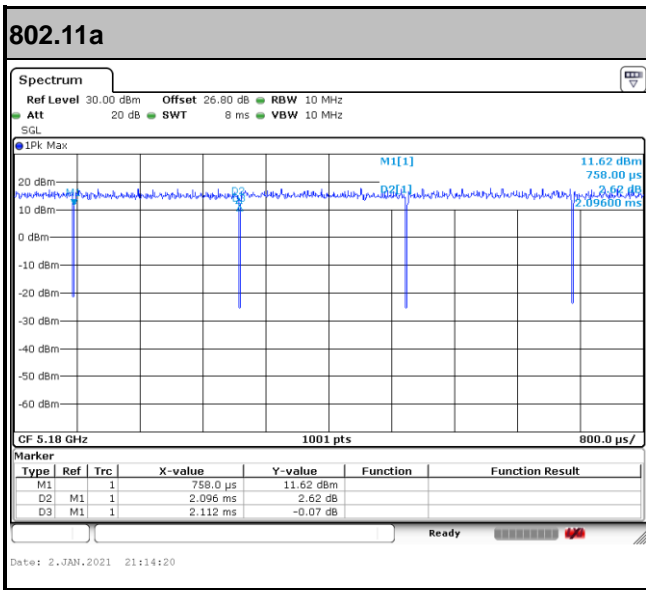
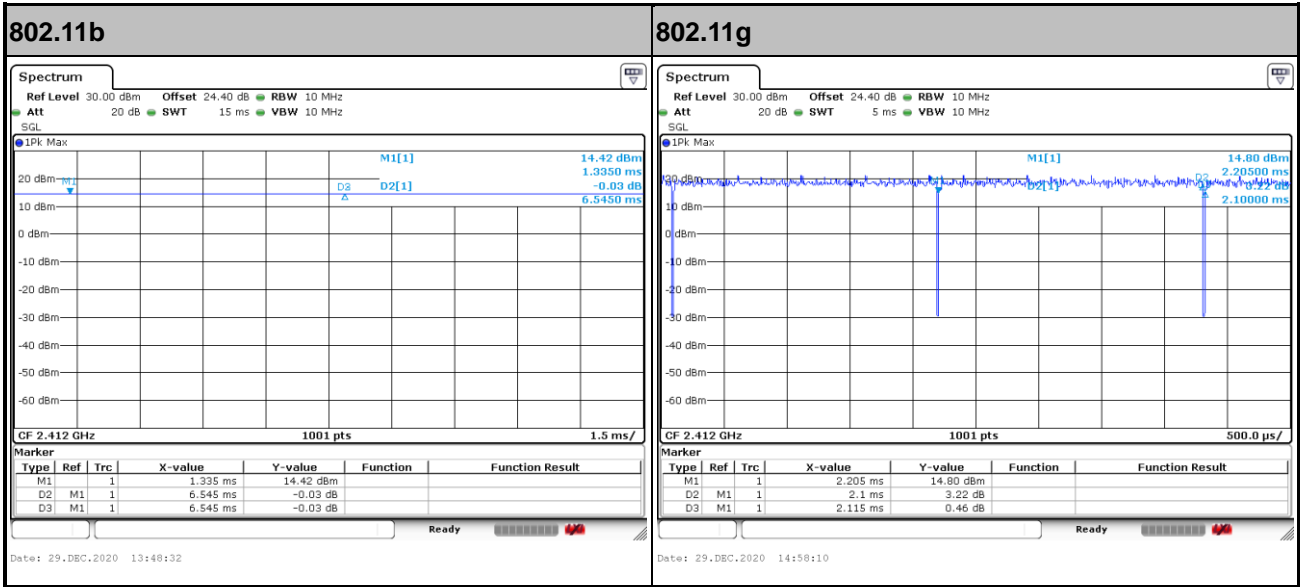

—THE END—