



SAR EVALUATION REPORT

Applicant Name:
Sony Corporation
1-7-1 Konan Minato-ku
Tokyo, 108-0075, Japan

Date of Testing:
02/21/23 - 03/15/23
Test Site/Location:
Element, Columbia, MD, USA
Document Serial No.:
1M2302230018-05.PY7 (Rev2)

FCC ID: PY7-25682R

APPLICANT: SONY CORPORATION

DUT Type: Portable Handset
Application Type: Certification
FCC Rule Part(s): CFR §2.1093

Equipment Class	Band & Mode	Operating Modes	Tx Frequency	SAR			
				1g Head (W/kg)	1g Body-Worn (W/kg)	1g Hotspot (W/kg)	10g Phablet (W/kg)
PCE	GSM/DTM/GPRS/EDGE 850	Voice/Data	824.20 - 848.80 MHz	0.13	0.39	0.37	N/A
PCE	GSM/DTM/GPRS/EDGE 1900	Voice/Data	1850.20 - 1909.80 MHz	< 0.1	0.17	0.26	N/A
PCE	UMTS 850	Voice/Data	826.40 - 846.60 MHz	0.12	0.29	0.29	N/A
PCE	UMTS 1750	Voice/Data	1712.4 - 1752.6 MHz	< 0.1	0.11	0.16	N/A
PCE	UMTS 1900	Voice/Data	1852.4 - 1907.6 MHz	< 0.1	0.29	0.38	N/A
PCE	LTE Band 12	Voice/Data	699.7 - 715.3 MHz	< 0.1	0.27	0.27	N/A
PCE	LTE Band 17	Voice/Data	706.5 - 713.5 MHz	N/A	N/A	N/A	N/A
PCE	LTE Band 13	Voice/Data	779.5 - 784.5 MHz	< 0.1	0.44	0.44	N/A
PCE	LTE Band 5 (Cell)	Voice/Data	824.7 - 848.3 MHz	< 0.1	0.23	0.23	N/A
PCE	LTE Band 66 (AWS)	Voice/Data	1710.7 - 1779.3 MHz	< 0.1	0.14	0.16	N/A
PCE	LTE Band 4 (AWS)	Voice/Data	1710.7 - 1754.3 MHz	N/A	N/A	N/A	N/A
PCE	LTE Band 25 (PCS)	Voice/Data	1850.7 - 1914.3 MHz	< 0.1	0.14	0.28	N/A
PCE	LTE Band 2 (PCS)	Voice/Data	1850.7 - 1909.3 MHz	N/A	N/A	N/A	N/A
PCE	LTE Band 41	Voice/Data	2498.5 - 2687.5 MHz	< 0.1	< 0.1	0.11	N/A
DTS	2.4 GHz WLAN	Data	2412 - 2462 MHz	0.58*	0.13*	0.16*	N/A
NII	U-NII-1	Data	5180 - 5240 MHz	N/A	N/A	< 0.1*	N/A
NII	U-NII-2A	Data	5260 - 5320 MHz	0.12*	< 0.1*	N/A	0.28*
NII	U-NII-2C	Data	5500 - 5720 MHz	0.13*	< 0.1*	N/A	0.52*
NII	U-NII-3	Data	5745 - 5825 MHz	0.19*	< 0.1*	< 0.1*	N/A
DSS/DTS	Bluetooth	Data	2402 - 2480 MHz	0.23	< 0.1	0.10	N/A
DXX	NFC	Data	13.56 MHz	N/A	N/A	N/A	< 0.1
Simultaneous SAR per KDB 690783 D01v01r03:				0.90	0.63	0.64	0.52

* Note: * SAR values represent RF exposure during MIMO operations.

Note: This revised Test Report supersedes and replaces the previously issued test report on the same subject device for the same type of testing as indicated. Please discard or destroy the previously issued test report(s) and dispose of it accordingly.

This wireless portable device has been shown to be capable of compliance for localized specific absorption rate (SAR) for uncontrolled environment/general population exposure limits specified in ANSI/IEEE C95.1-1992 and has been tested in accordance with the measurement procedures specified in Section 1.9 of this report; for North American frequency bands only.

I attest to the accuracy of data. All measurements reported herein were performed by me or were made under my supervision and are correct to the best of my knowledge and belief. I assume full responsibility for the completeness of these measurements and vouch for the qualifications of all persons taking them. Test results reported herein relate only to the item(s) tested.

RJ Ortanez
Executive Vice President



The SAR Tick is an initiative of the Mobile & Wireless Forum (MWF). While a product may be considered eligible, use of the SAR Tick logo requires an agreement with the MWF. Further details can be obtained by emailing: sartick@mwfai.info.

FCC ID: PY7-25682R	SAR EVALUATION REPORT	Approved by: Technical Manager
Document S/N: 1M2302230018-05.PY7 (Rev2)	DUT Type: Portable Handset	Page 1 of 74

REV 22.0
03/30/2022

TABLE OF CONTENTS

1	DEVICE UNDER TEST	3
2	LTE INFORMATION.....	17
3	INTRODUCTION.....	18
4	DOSIMETRIC ASSESSMENT	19
5	DEFINITION OF REFERENCE POINTS	20
6	TEST CONFIGURATION POSITIONS	21
7	RF EXPOSURE LIMITS	25
8	FCC MEASUREMENT PROCEDURES.....	26
9	RF CONDUCTED POWERS.....	32
10	SYSTEM VERIFICATION.....	47
11	SAR DATA SUMMARY	51
12	SAR MEASUREMENT VARIABILITY	69
13	EQUIPMENT LIST.....	70
14	MEASUREMENT UNCERTAINTIES.....	71
15	CONCLUSION.....	72
16	REFERENCES	73
APPENDIX A: SAR TEST PLOTS		
APPENDIX B: SAR DIPOLE VERIFICATION PLOTS		
APPENDIX C: PROBE AND DIPOLE CALIBRATION CERTIFICATES		
APPENDIX D: SAR TISSUE SPECIFICATIONS		
APPENDIX E: MULTI-TX AND ANTENNA SAR CONSIDERATIONS		
APPENDIX F: SAR SYSTEM VALIDATION		
APPENDIX G: LTE LOWER BANDWIDTH RF CONDUCTED POWERS		
APPENDIX H: DOWNLINK LTE CA RF CONDUCTED POWERS		
APPENDIX I: 802.11ax RU SAR EXCLUSION		
APPENDIX J: DUT ANTENNA DIAGRAM & SAR TEST SETUP PHOTOGRAPHS		

FCC ID: PY7-25682R	SAR EVALUATION REPORT	Approved by: Technical Manager
Document S/N: 1M2302230018-05.PY7 (Rev2)	DUT Type: Portable Handset	Page 2 of 74

REV 22.0
03/30/2022

1 DEVICE UNDER TEST

1.1 Device Overview

Band & Mode	Operating Modes	Tx Frequency
GSM/DTM/GPRS/EDGE 850	Voice/Data	824.20 - 848.80 MHz
GSM/DTM/GPRS/EDGE 1900	Voice/Data	1850.20 - 1909.80 MHz
UMTS 850	Voice/Data	826.40 - 846.60 MHz
UMTS 1750	Voice/Data	1712.4 - 1752.6 MHz
UMTS 1900	Voice/Data	1852.4 - 1907.6 MHz
LTE Band 12	Voice/Data	699.7 - 715.3 MHz
LTE Band 17	Voice/Data	706.5 - 713.5 MHz
LTE Band 13	Voice/Data	779.5 - 784.5 MHz
LTE Band 5 (Cell)	Voice/Data	824.7 - 848.3 MHz
LTE Band 66 (AWS)	Voice/Data	1710.7 - 1779.3 MHz
LTE Band 4 (AWS)	Voice/Data	1710.7 - 1754.3 MHz
LTE Band 25 (PCS)	Voice/Data	1850.7 - 1914.3 MHz
LTE Band 2 (PCS)	Voice/Data	1850.7 - 1909.3 MHz
LTE Band 41	Voice/Data	2498.5 - 2687.5 MHz
2.4 GHz WLAN	Data	2412 - 2462 MHz
U-NII-1	Data	5180 - 5240 MHz
U-NII-2A	Data	5260 - 5320 MHz
U-NII-2C	Data	5500 - 5720 MHz
U-NII-3	Data	5745 - 5825 MHz
Bluetooth	Data	2402 - 2480 MHz
NFC	Data	13.56 MHz

FCC ID: PY7-25682R	SAR EVALUATION REPORT	Approved by: Technical Manager
Document S/N: 1M2302230018-05.PY7 (Rev2)	DUT Type: Portable Handset	Page 3 of 74

REV 22.0
03/30/2022

1.2 Nominal and Maximum Output Power Specifications

This device operates using the following maximum and nominal output power specifications. SAR values were scaled to the maximum allowed power to determine compliance per KDB Publication 447498 D04v01.

Note: Targets for 802.11ax RU operations can be found in 802.11ax RU SAR Exclusion Appendix.

1.2.1 2G/3G/4G Output Power

GSM/GPRS/EDGE 850									
	Voice (in dBm)	Data - Burst Average GMSK (in dBm)				Data - Burst Average 8-PSK (in dBm)			
	1 TX Slot	1 TX Slots	2 TX Slots	3 TX Slots	4 TX Slots	1 TX Slots	2 TX Slots	3 TX Slots	4 TX Slots
Max Allowed Power	32.9	32.9	29.9	28.1	26.9	28.0	25.0	23.2	22.0
Nominal	31.9	31.9	28.9	27.1	25.9	27.0	24.0	22.2	21.0
GSM/GPRS/EDGE 1900									
	Voice (in dBm)	Data - Burst Average GMSK (in dBm)				Data - Burst Average 8-PSK (in dBm)			
	1 TX Slot	1 TX Slots	2 TX Slots	3 TX Slots	4 TX Slots	1 TX Slots	2 TX Slots	3 TX Slots	4 TX Slots
Max Allowed Power	28.0	28.0	25.0	23.2	22.0	27.0	24.0	22.2	21.0
Nominal	27.0	27.0	24.0	22.2	21.0	26.0	23.0	21.2	20.0
GSM/DTM 850									
	Data - Burst Average GMSK (in dBm)				Data - Burst Average 8-PSK (in dBm)				
	2 TX Slots		3 TX Slots		2 TX Slots		3 TX Slots		
Max Allowed Power	29.9		28.1		25.0		23.2		
Nominal	28.9		27.1		24.0		22.2		
GSM/DTM 1900									
	Data - Burst Average GMSK (in dBm)				Data - Burst Average 8-PSK (in dBm)				
	2 TX Slots		3 TX Slots		2 TX Slots		3 TX Slots		
Max Allowed Power	25.0		23.2		24.0		22.2		
Nominal	24.0		22.2		23.0		21.2		

For GSM/DTM, the above powers listed are GSM/DTM burst average values.

FCC ID: PY7-25682R	SAR EVALUATION REPORT	Approved by: Technical Manager
Document S/N: 1M2302230018-05.PY7 (Rev2)	DUT Type: Portable Handset	Page 4 of 74

UMTS Band 5 (850 MHz)				
	Modulated Average Output Power (in dBm)			
	3GPP WCDMA Rel 99	3GPP HSDPA Rel 5	3GPP HSUPA Rel 6	3GPP DC-HSDPA Rel 8
Max Allowed Power	22.7	22.0	22.0	22.0
Nominal	22.0	21.0	21.0	21.0
UMTS Band 4 (1750 MHz)				
	Modulated Average Output Power (in dBm)			
	3GPP WCDMA Rel 99	3GPP HSDPA Rel 5	3GPP HSUPA Rel 6	3GPP DC-HSDPA Rel 8
Max Allowed Power	18.7	18.0	18.0	18.0
Nominal	18.0	17.0	17.0	17.0
UMTS Band 2 (1900 MHz)				
	Modulated Average Output Power (in dBm)			
	3GPP WCDMA Rel 99	3GPP HSDPA Rel 5	3GPP HSUPA Rel 6	3GPP DC-HSDPA Rel 8
Max Allowed Power	19.7	19.0	19.0	19.0
Nominal	19.0	18.0	18.0	18.0

FCC ID: PY7-25682R	SAR EVALUATION REPORT	Approved by: Technical Manager
Document S/N: 1M2302230018-05.PY7 (Rev2)	DUT Type: Portable Handset	Page 5 of 74

Mode / Band	Antenna		Modulated Average Output Power (in dBm)
LTE Band 12	Main 1	Max Allowed Power	22.0
		Nominal	21.0
LTE Band 17	Main 1	Max Allowed Power	22.0
		Nominal	21.0
LTE Band 13	Main 1	Max Allowed Power	22.0
		Nominal	21.0
LTE Band 5 (Cell)	Main 1	Max Allowed Power	22.0
		Nominal	21.0
LTE Band 66 (AWS)	Main 2	Max Allowed Power	19.0
		Nominal	18.0
LTE Band 4 (AWS)	Main 2	Max Allowed Power	19.0
		Nominal	18.0
LTE Band 25 (PCS)	Main 2	Max Allowed Power	20.0
		Nominal	19.0
LTE Band 2 (PCS)	Main 2	Max Allowed Power	20.0
		Nominal	19.0
LTE Band 41	Main 2	Max Allowed Power	20.0
		Nominal	19.0

For LTE TDD, the above powers listed are TDD burst average values.

FCC ID: PY7-25682R	SAR EVALUATION REPORT	Approved by: Technical Manager
Document S/N: 1M2302230018-05.PY7 (Rev2)	DUT Type: Portable Handset	Page 6 of 74

REV 22.0
03/30/2022

1.2.2 2.4 GHz Maximum MIMO WLAN Output Power

Mode	Band	IEEE 802.11 (in dBm)							
		MIMO							
		WiFi Main				WiFi Sub			
		b (CDD + STBC)	g (CDD + STBC)	n (CDD + STBC, SDM)	ax (SU) (CDD + STBC, SDM)	b (CDD + STBC)	g (CDD + STBC)	n (CDD + STBC, SDM)	ax (SU) (CDD + STBC, SDM)
Maximum / Nominal Power		Max	Max	Max	Max	Max	Max	Max	Max
2.4 GHz WIFI	2.45 GHz	14.0	14.0	14.0	14.0	12.5	14.0	14.0	14.0

Note: in MIMO operations, each WiFi Main and WiFi Sub transmits at maximum allowed powers as indicated above.

FCC ID: PY7-25682R	SAR EVALUATION REPORT	Approved by: Technical Manager
Document S/N: 1M2302230018-05.PY7 (Rev2)	DUT Type: Portable Handset	Page 7 of 74

1.2.3 5 GHz Maximum MIMO WLAN Output Power

Mode	Band	IEEE 802.11 (in dBm)							
		MIMO							
		WiFi Main				WiFi Sub			
		a (CDD + STBC)	n (CDD + STBC, SDM)	ac (CDD + STBC, SDM)	ax (SU) (CDD + STBC, SDM)	a (CDD + STBC)	n (CDD + STBC, SDM)	ac (CDD + STBC, SDM)	ax (SU) (CDD + STBC, SDM)
Maximum / Nominal Power		Max	Max	Max	Max	Max	Max	Max	Max
5 GHz WIFI (20MHz BW)	UNII-1	11.5	11.5	11.5	11.5	11.5	11.5	11.5	11.5
	UNII-2A	11.5	11.5	11.5	11.5	11.5	11.5	11.5	11.5
	UNII-2C	11.5	11.5	11.5	11.5	11.5	11.5	11.5	11.5
	UNII-3	11.5	11.5	11.5	11.5	11.5	11.5	11.5	11.5
5 GHz WIFI (40MHz BW)	UNII-1		11.5	11.5	11.5		11.5	11.5	11.5
	UNII-2A		11.5	11.5	11.5		11.5	11.5	11.5
	UNII-2C		11.5	11.5	11.5		11.5	11.5	11.5
	UNII-3		11.5	11.5	11.5		11.5	11.5	11.5
5 GHz WIFI (80MHz BW)	UNII-1			11.5	11.5			11.5	11.5
	UNII-2A			11.5	11.5			11.5	11.5
	UNII-2C			11.5	11.5			11.5	11.5
	UNII-3			10.5	10.5			10.5	10.5
5 GHz WIFI (160MHz BW)	UNII-1/2A			11.5	11.5			11.5	11.5
	UNII-2C			11.5	11.5			11.5	11.5
	UNII-3			11.5	11.5			11.5	11.5

Note: in MIMO operations, each WiFi Main and WiFi Sub transmits at maximum allowed powers as indicated above.

FCC ID: PY7-25682R	SAR EVALUATION REPORT	Approved by: Technical Manager
Document S/N: 1M2302230018-05.PY7 (Rev2)	DUT Type: Portable Handset	Page 8 of 74

1.2.4 2.4 GHz Reduced MIMO WLAN Output Power

The below table is applicable during simultaneous conditions with 5 GHz WLAN.

Mode	Band	IEEE 802.11 (in dBm)							
		MIMO							
		WiFi Main				WiFi Sub			
		b (CDD + STBC)	g (CDD + STBC)	n (CDD + STBC, SDM)	ax (SU) (CDD + STBC, SDM)	b (CDD + STBC)	g (CDD + STBC)	n (CDD + STBC, SDM)	ax (SU) (CDD + STBC, SDM)
Maximum / Nominal Power		Max	Max	Max	Max	Max	Max	Max	Max
2.4 GHz	2.45 GHz	11.0	11.0	11.0	11.0	11.0	11.0	11.0	11.0

Note: in MIMO operations, each WiFi Main and WiFi Sub transmits at maximum allowed powers as indicated above.

FCC ID: PY7-25682R	SAR EVALUATION REPORT	Approved by: Technical Manager
Document S/N: 1M2302230018-05.PY7 (Rev2)	DUT Type: Portable Handset	Page 9 of 74

1.2.5 5 GHz Reduced MIMO WLAN Output Power

The below table is applicable during simultaneous conditions with 2.4 GHz WLAN.

Mode	Band	IEEE 802.11 (in dBm)							
		MIMO							
		WiFi Main				WiFi Sub			
		a (CDD + STBC)	n (CDD + STBC, SDM)	ac (CDD + STBC, SDM)	ax (SU) (CDD + STBC, SDM)	a (CDD + STBC)	n (CDD + STBC, SDM)	ac (CDD + STBC, SDM)	ax (SU) (CDD + STBC, SDM)
Maximum / Nominal Power		Max	Max	Max	Max	Max	Max	Max	Max
5 GHz WIFI (20MHz BW)	UNII-1	9.5	9.5	9.5	9.5	9.5	9.5	9.5	9.5
	UNII-2A	9.5	9.5	9.5	9.5	9.5	9.5	9.5	9.5
	UNII-2C	9.5	9.5	9.5	9.5	9.5	9.5	9.5	9.5
	UNII-3	9.5	9.5	9.5	9.5	9.5	9.5	9.5	9.5
5 GHz WIFI (40MHz BW)	UNII-1		9.5	9.5	9.5		9.5	9.5	9.5
	UNII-2A		9.5	9.5	9.5		9.5	9.5	9.5
	UNII-2C		9.5	9.5	9.5		9.5	9.5	9.5
	UNII-3		9.5	9.5	9.5		9.5	9.5	9.5
5 GHz WIFI (80MHz BW)	UNII-1			9.5	9.5			9.5	9.5
	UNII-2A			9.5	9.5			9.5	9.5
	UNII-2C			9.5	9.5			9.5	9.5
	UNII-3			9.5	9.5			9.5	9.5
5 GHz WIFI (160MHz BW)	UNII-1/2A			9.5	9.5			9.5	9.5
	UNII-2C			9.5	9.5			9.5	9.5

Note: in MIMO operations, each WiFi Main and WiFi Sub transmits at maximum allowed powers as indicated above.

FCC ID: PY7-25682R	SAR EVALUATION REPORT	Approved by: Technical Manager
Document S/N: 1M2302230018-05.PY7 (Rev2)	DUT Type: Portable Handset	Page 10 of 74

1.2.6 2.4 GHz Maximum Bluetooth Output Power

WiFi Main	WiFi Sub
Bluetooth (in dBm)	Bluetooth (in dBm)
14	14
EDR (in dBm)	EDR (in dBm)
14	14
BLE 1Mbps (in dBm)	BLE 1Mbps (in dBm)
10.2	10.79
BLE 2Mbps (in dBm)	BLE 2Mbps (in dBm)
10.2	10.79
BLE LR s2 (in dBm)	BLE LR s2 (in dBm)
10.2	10.79
BLE LR s8 (in dBm)	BLE LR s8 (in dBm)
10.2	10.79

FCC ID: PY7-25682R	SAR EVALUATION REPORT	Approved by: Technical Manager
Document S/N: 1M2302230018-05.PY7 (Rev2)	DUT Type: Portable Handset	Page 11 of 74

1.3 DUT Antenna Locations

The overall dimensions of this device are > 9 x 5 cm. A diagram showing the location of the device antennas can be found in DUT Antenna Diagram & SAR Test Setup Photographs Appendix. Since the display diagonal dimension of this device is > 150 mm and <200 mm, it is considered a “phablet.” Exact antenna dimensions and separation distances are shown in the Technical Descriptions in the FCC filing.

**Table 1-1
Device Edges/Sides for SAR Testing**

Device Sides/Edges for SAR Testing							
Mode	Antenna	Back	Front	Top	Bottom	Right	Left
GPRS/DTM 850	Main 1	Yes	Yes	No	Yes	No	Yes
GPRS/DTM 1900	Main 2	Yes	Yes	No	Yes	Yes	No
UMTS 850	Main 1	Yes	Yes	No	Yes	No	Yes
UMTS 1750	Main 2	Yes	Yes	No	Yes	Yes	No
UMTS 1900	Main 2	Yes	Yes	No	Yes	Yes	No
LTE Band 12	Main 1	Yes	Yes	No	Yes	No	Yes
LTE Band 13	Main 1	Yes	Yes	No	Yes	No	Yes
LTE Band 5 (Cell)	Main 1	Yes	Yes	No	Yes	No	Yes
LTE Band 66 (AWS)	Main 2	Yes	Yes	No	Yes	Yes	No
LTE Band 25 (PCS)	Main 2	Yes	Yes	No	Yes	Yes	No
LTE Band 41	Main 2	Yes	Yes	No	Yes	Yes	No
2.4 GHz WLAN	WiFi MIMO	Yes	Yes	Yes	Yes	No	Yes
5 GHz WLAN	WiFi MIMO	Yes	Yes	Yes	Yes	No	Yes
Bluetooth	WiFi Main	Yes	Yes	Yes	No	No	Yes
Bluetooth	WiFi Sub	Yes	Yes	No	Yes	No	Yes
NFC	NFC	Yes	Yes	No	No	No	Yes

Note: Particular DUT edges were not required to be evaluated for wireless router SAR or phablet SAR if the edges were greater than 2.5 cm from the transmitting antenna according to FCC KDB Publication 941225 D06v02r01 Section III and FCC KDB Publication 648474 D04v01r03. The distances between the transmit antennas and the edges of the device are included in the filing. When wireless router mode is enabled, U-NII-2A, U-NII-2C operations are disabled.

1.4 Near Field Communications (NFC) Antenna

This DUT has NFC operations. The NFC antenna is integrated into the device for this model. Therefore, all SAR tests were performed with the device which already incorporates the NFC antenna. A diagram showing the location of the NFC antenna can be found in DUT Antenna Diagram & SAR Test Setup Photographs Appendix.

1.5 Simultaneous Transmission Capabilities

According to FCC KDB Publication 447498 D04v01, transmitters are considered to be operating simultaneously when there is overlapping transmission, with the exception of transmissions during network hand-offs with maximum hand-off duration less than 30 seconds.

This device contains multiple transmitters that may operate simultaneously, and therefore requires a simultaneous transmission analysis according to FCC KDB Publication 447498 D04v01 procedures.

FCC ID: PY7-25682R	SAR EVALUATION REPORT	Approved by: Technical Manager
Document S/N: 1M2302230018-05.PY7 (Rev2)	DUT Type: Portable Handset	Page 12 of 74

**Table 1-2
Simultaneous Transmission Scenarios**

No.	Capable Transmit Configuration	Head	Body-Worn Accessory	Wireless Router	Phablet	Notes
1	GSM voice + 2.4 GHz Bluetooth WiFi Main	Yes^	Yes	N/A	Yes	^ Bluetooth Tethering is considered
2	GSM voice + 2.4 GHz Bluetooth WiFi Sub	Yes^	Yes	N/A	Yes	^ Bluetooth Tethering is considered
3	GSM voice + 2.4 GHz WLAN MIMO	Yes	Yes	N/A	Yes	
4	GSM voice + 5 GHz WLAN MIMO	Yes	Yes	N/A	Yes	
5	GSM voice + 2.4 GHz WLAN MIMO + 5 GHz WLAN MIMO	Yes	Yes	N/A	Yes	
6	GSM voice + 2.4 GHz Bluetooth WiFi Main + 5 GHz WLAN MIMO	Yes^	Yes	N/A	Yes	^ Bluetooth Tethering is considered
7	GSM voice + 2.4 GHz Bluetooth WiFi Sub + 5 GHz WLAN MIMO	Yes^	Yes	N/A	Yes	^ Bluetooth Tethering is considered
8	UMTS + 2.4 GHz Bluetooth WiFi Main	Yes^	Yes	Yes^	Yes	^ Bluetooth Tethering is considered
9	UMTS + 2.4 GHz Bluetooth WiFi Sub	Yes^	Yes	Yes^	Yes	^ Bluetooth Tethering is considered
10	UMTS + 2.4 GHz WLAN MIMO	Yes	Yes	Yes	Yes	
11	UMTS + 5 GHz WLAN MIMO	Yes	Yes	N/A	Yes	
12	UMTS + 2.4 GHz WLAN MIMO + 5 GHz WLAN MIMO	Yes	Yes	Yes	Yes	
13	UMTS + 2.4 GHz Bluetooth WiFi Main + 5 GHz WLAN MIMO	Yes^	Yes	Yes^	Yes	^ Bluetooth Tethering is considered
14	UMTS + 2.4 GHz Bluetooth WiFi Sub + 5 GHz WLAN MIMO	Yes^	Yes	N/A	Yes	^ Bluetooth Tethering is considered
15	LTE + 2.4 GHz Bluetooth WiFi Main	Yes^	Yes	Yes^	Yes	^ Bluetooth Tethering is considered
16	LTE + 2.4 GHz Bluetooth WiFi Sub	Yes^	Yes	Yes^	Yes	^ Bluetooth Tethering is considered
17	LTE + 2.4 GHz WLAN MIMO	Yes	Yes	Yes	Yes	
18	LTE + 5 GHz WLAN MIMO	Yes	Yes	N/A	Yes	
19	LTE + 2.4 GHz WLAN MIMO + 5 GHz WLAN MIMO	Yes	Yes	Yes	Yes	
20	LTE + 2.4 GHz Bluetooth WiFi Main + 5 GHz WLAN MIMO	Yes^	Yes	Yes^	Yes	^ Bluetooth Tethering is considered
21	LTE + 2.4 GHz Bluetooth WiFi Sub + 5 GHz WLAN MIMO	Yes^	Yes	N/A	Yes	^ Bluetooth Tethering is considered
22	DTM/GPRS/EDGE + 2.4 GHz Bluetooth WiFi Main	N/A	N/A	Yes^	Yes	^ Bluetooth Tethering is considered
23	DTM/GPRS/EDGE + 2.4 GHz Bluetooth WiFi Sub	N/A	N/A	Yes^	Yes	^ Bluetooth Tethering is considered
24	DTM/GPRS/EDGE + 2.4 GHz WLAN MIMO	N/A	N/A	Yes	Yes	
25	DTM/GPRS/EDGE + 5 GHz WLAN MIMO	N/A	N/A	N/A	Yes	
26	DTM/GPRS/EDGE + 2.4 GHz WLAN MIMO + 5 GHz WLAN MIMO	N/A	N/A	Yes	Yes	
27	DTM/GPRS/EDGE + 2.4 GHz Bluetooth WiFi Main + 5 GHz WLAN	N/A	N/A	Yes^	Yes	^ Bluetooth Tethering is considered
28	DTM/GPRS/EDGE + 2.4 GHz Bluetooth WiFi Sub + 5 GHz WLAN	N/A	N/A	N/A	Yes	^ Bluetooth Tethering is considered

1. No other simultaneous scenarios besides described above is supported for this model.
2. When the user utilizes multiple services in UMTS 3G mode it uses multi-Radio Access Bearer or multi-RAB. The power control is based on a physical control channel (Dedicated Physical Control Channel [DPCCH]) and power control will be adjusted to meet the needs of both services. Therefore, the UMTS+WLAN scenario also represents the UMTS Voice/DATA + WLAN Hotspot scenario.
3. Per the manufacturer, WIFI Direct is not expected to be used in conjunction with a held-to-ear or body-worn accessory voice call. Therefore, there are no simultaneous transmission scenarios involving WIFI direct beyond that listed in the above table.
4. 2.4 GHz WLAN and 2.4 GHz Bluetooth share the same antenna path and cannot transmit simultaneously.
5. 5 GHz Wireless Router is only supported for the U-NII-1 and U-NII-3 by S/W, therefore U-NII-2A, and U-NII-2C were not evaluated for wireless router conditions.
6. This device supports 2x2 MIMO Tx for WLAN 802.11a/b/g/n/ac/ax. 802.11a/b/g/n/ac/ax supports CDD and STBC and 802.11n/ac/ax additionally supports SDM.
7. This device supports Bluetooth Tethering.
8. This device supports VoLTE.
9. NFC was evaluated for phablet based on expected usage conditions.

1.6 Miscellaneous SAR Test Considerations

(A) WIFI/BT

Since U-NII-1 and U-NII-2A bands have the same maximum output power and the highest reported SAR for U-NII-2A is less than 1.2 W/kg, SAR is not required for U-NII-1 band according to FCC KDB Publication 248227 D01v02r02.

Since Wireless Router operations are not allowed by the chipset firmware using U-NII-2A and U-NII-2C WIFI, only 2.4 GHz WIFI, 2.4 GHz Bluetooth, U-NII-1, and U-NII-3 WIFI Hotspot SAR tests and combinations are

FCC ID: PY7-25682R	SAR EVALUATION REPORT	Approved by: Technical Manager
Document S/N: 1M2302230018-05.PY7 (Rev2)	DUT Type: Portable Handset	Page 13 of 74



considered for SAR with respect to Wireless Router configurations according to FCC KDB 941225 D06v02r01.

This device supports IEEE 802.11ax with the following features:

- a) Up to 160 MHz Bandwidth only for 5 GHz
- b) Up to 20 MHz Bandwidth only for 2.4 GHz
- c) 2 Tx antenna output
- d) Up to 1024 QAM is supported
- e) TDWR and Band gap channels are supported for 5 GHz
- f) MU-MIMO UL Operations are not supported

Per FCC KDB Publication 648474 D04v01r03, this device is considered a "phablet" since the display diagonal dimension is greater than 150mm and less than 200mm. Phablet SAR tests are required when wireless router mode does not apply or if wireless router 1g SAR > 1.2 W/kg. Because wireless router operations are not supported for U-NII-2A, and U-NII-2C WLAN, phablet SAR tests were performed. Phablet SAR was not evaluated for 2.4 GHz WLAN, 2.4 GHz Bluetooth, U-NII-1, and U-NII-3 WLAN operations since wireless router 1g SAR was < 1.2 W/kg.

Per April 2019 TCB Workshop Notes, SAR testing was not required for 802.11ax when applying the initial test configuration procedures of KDB 248227, with 802.11ax considered a higher order 802.11 mode.

FCC ID: PY7-25682R	SAR EVALUATION REPORT	Approved by: Technical Manager
Document S/N: 1M2302230018-05.PY7 (Rev2)	DUT Type: Portable Handset	Page 14 of 74

REV 22.0
03/30/2022

(B) Licensed Transmitter(s)

This device is only capable of QPSK HSUPA in the uplink. Therefore, no additional SAR tests are required beyond that described for devices with HSUPA in KDB 941225 D01v03r01.

LTE SAR for the higher modulations and lower bandwidths were not tested since the maximum average output power of all required channels and configurations was not more than 0.5 dB higher than the highest bandwidth; and the reported LTE SAR for the highest bandwidth was less than 1.45 W/kg for all configurations according to FCC KDB 941225 D05v02r04.

This device supports LTE Carrier Aggregation (CA) in the downlink. All uplink communications are identical to Release 8 specifications. Per FCC KDB Publication 941225 D05A v01r02, SAR for LTE CA operations was not needed since the maximum average output power in LTE CA mode was not >0.25 dB higher than the maximum output power when downlink carrier aggregation was inactive. The downlink carrier aggregation exclusion analysis can be found in Downlink LTE CA RF Conducted Powers Appendix.

Per FCC KDB Publication 648474 D04v01r03, this device is considered a "phablet" since the display diagonal dimension is greater than 150mm and less than 200mm. Therefore, phablet SAR tests are required when wireless router mode does not apply or if wireless router 1g SAR > 1.2 W/kg.

This device supports downlink 4x4 MIMO operations for some LTE Bands. Per May 2017 TCB Workshop Notes, SAR for 4x4 DL MIMO was not needed since the maximum average output power in 4x4 DL MIMO mode was not more than 0.25 dB higher than the maximum output power with 4x4 DL MIMO inactive. Additionally, SAR for 4x4 MIMO Downlink Carrier Aggregation was not needed since the maximum average output power in 4x4 MIMO Downlink Carrier Aggregation mode was not more than 0.25 dB higher than the maximum output power with 4x4 MIMO Downlink and downlink carrier aggregation inactive.

This device supports LTE capabilities with overlapping transmission frequency ranges. When the supported frequency range of an LTE Band falls completely within an LTE band with a larger transmission frequency range, both LTE bands have the same target power (or the band with the larger transmission frequency range has a higher target power), and both LTE bands share the same transmission path and signal characteristics, SAR was only assessed for the band with the larger transmission frequency range.

1.7 Guidance Applied

- IEEE 1528-2013
- FCC KDB Publication 941225 D01v03r01, D05v02r05, D05Av01r02, D06v02r01 (2G/3G/4G and Hotspot)
- FCC KDB Publication 248227 D01v02r02 (SAR Considerations for 802.11 Devices)
- FCC KDB Publication 447498 D04v01 (General SAR Guidance)
- FCC KDB Publication 648474 D04v01r03 (Phablet Procedures)
- October 2013 TCB Workshop Notes (GPRS Testing Considerations)
- May 2017 TCB Workshop Notes (LTE 4x4 Downlink MIMO)
- November 2017, April 2018, October 2018 TCB Workshop Notes (LTE Carrier Aggregation)
- April 2019 TCB Workshop Notes (IEEE 802.11ax)

FCC ID: PY7-25682R	SAR EVALUATION REPORT	Approved by: Technical Manager
Document S/N: 1M2302230018-05.PY7 (Rev2)	DUT Type: Portable Handset	Page 15 of 74

1.8 Device Serial Numbers

Several samples with identical hardware were used to support SAR testing. The manufacturer has confirmed that the device(s) tested have the same physical, mechanical and thermal characteristics and are within operational tolerances expected for production units. The serial numbers used for each test are indicated alongside the results in Section 11.

FCC ID: PY7-25682R	SAR EVALUATION REPORT	Approved by: Technical Manager
Document S/N: 1M2302230018-05.PY7 (Rev2)	DUT Type: Portable Handset	Page 16 of 74

REV 22.0
03/30/2022

2 LTE INFORMATION

LTE Information					
Form Factor	Portable Handset				
	LTE Band 12 (699.7 - 715.3 MHz)				
	LTE Band 17 (706.5 - 713.5 MHz)				
	LTE Band 13 (779.5 - 784.5 MHz)				
	LTE Band 5 (Cell) (824.7 - 848.3 MHz)				
	LTE Band 66 (AWS) (1710.7 - 1779.3 MHz)				
	LTE Band 4 (AWS) (1710.7 - 1754.3 MHz)				
	LTE Band 25 (PCS) (1850.7 - 1914.3 MHz)				
	LTE Band 2 (PCS) (1850.7 - 1909.3 MHz)				
	LTE Band 41 (2498.5 - 2687.5 MHz)				
Channel Bandwidths	LTE Band 12: 1.4 MHz, 3 MHz, 5 MHz, 10 MHz				
	LTE Band 17: 5 MHz, 10 MHz				
	LTE Band 13: 5 MHz, 10 MHz				
	LTE Band 5 (Cell): 1.4 MHz, 3 MHz, 5 MHz, 10 MHz				
	LTE Band 66 (AWS): 1.4 MHz, 3 MHz, 5 MHz, 10 MHz, 15 MHz, 20 MHz				
	LTE Band 4 (AWS): 1.4 MHz, 3 MHz, 5 MHz, 10 MHz, 15 MHz, 20 MHz				
	LTE Band 25 (PCS): 1.4 MHz, 3 MHz, 5 MHz, 10 MHz, 15 MHz, 20 MHz				
	LTE Band 2 (PCS): 1.4 MHz, 3 MHz, 5 MHz, 10 MHz, 15 MHz, 20 MHz				
	LTE Band 41: 5 MHz, 10 MHz, 15 MHz, 20 MHz				
Channel Numbers and Frequencies (MHz)	Low	Low-Mid	Mid	Mid-High	High
LTE Band 12: 1.4 MHz	699.7 (23017)		707.5 (23095)		715.3 (23173)
LTE Band 12: 3 MHz	700.5 (23025)		707.5 (23095)		714.5 (23165)
LTE Band 12: 5 MHz	701.5 (23035)		707.5 (23095)		713.5 (23155)
LTE Band 12: 10 MHz	704 (23060)		707.5 (23095)		711 (23130)
LTE Band 17: 5 MHz	706.5 (23755)		710 (23790)		713.5 (23825)
LTE Band 17: 10 MHz	709 (23780)		710 (23790)		711 (23800)
LTE Band 13: 5 MHz	779.5 (23205)		782 (23230)		784.5 (23255)
LTE Band 13: 10 MHz	N/A		782 (23230)		N/A
LTE Band 5 (Cell): 1.4 MHz	824.7 (20407)		836.5 (20525)		848.3 (20643)
LTE Band 5 (Cell): 3 MHz	825.5 (20415)		836.5 (20525)		847.5 (20635)
LTE Band 5 (Cell): 5 MHz	826.5 (20425)		836.5 (20525)		846.5 (20625)
LTE Band 5 (Cell): 10 MHz	829 (20450)		836.5 (20525)		844 (20600)
LTE Band 66 (AWS): 1.4 MHz	1710.7 (131979)		1745 (132322)		1779.3 (132665)
LTE Band 66 (AWS): 3 MHz	1711.5 (131987)		1745 (132322)		1778.5 (132657)
LTE Band 66 (AWS): 5 MHz	1712.5 (131997)		1745 (132322)		1777.5 (132647)
LTE Band 66 (AWS): 10 MHz	1715 (132022)		1745 (132322)		1775 (132622)
LTE Band 66 (AWS): 15 MHz	1717.5 (132047)		1745 (132322)		1772.5 (132597)
LTE Band 66 (AWS): 20 MHz	1720 (132072)		1745 (132322)		1770 (132572)
LTE Band 4 (AWS): 1.4 MHz	1710.7 (19957)		1732.5 (20175)		1754.3 (20393)
LTE Band 4 (AWS): 3 MHz	1711.5 (19965)		1732.5 (20175)		1753.5 (20385)
LTE Band 4 (AWS): 5 MHz	1712.5 (19975)		1732.5 (20175)		1752.5 (20375)
LTE Band 4 (AWS): 10 MHz	1715 (20000)		1732.5 (20175)		1750 (20350)
LTE Band 4 (AWS): 15 MHz	1717.5 (20025)		1732.5 (20175)		1747.5 (20325)
LTE Band 4 (AWS): 20 MHz	1720 (20050)		1732.5 (20175)		1745 (20300)
LTE Band 25 (PCS): 1.4 MHz	1850.7 (26047)		1882.5 (26365)		1914.3 (26683)
LTE Band 25 (PCS): 3 MHz	1851.5 (26055)		1882.5 (26365)		1913.5 (26675)
LTE Band 25 (PCS): 5 MHz	1852.5 (26065)		1882.5 (26365)		1912.5 (26665)
LTE Band 25 (PCS): 10 MHz	1855 (26090)		1882.5 (26365)		1910 (26640)
LTE Band 25 (PCS): 15 MHz	1857.5 (26115)		1882.5 (26365)		1907.5 (26615)
LTE Band 25 (PCS): 20 MHz	1860 (26140)		1882.5 (26365)		1905 (26590)
LTE Band 2 (PCS): 1.4 MHz	1850.7 (18607)		1880 (18900)		1909.3 (19193)
LTE Band 2 (PCS): 3 MHz	1851.5 (18615)		1880 (18900)		1908.5 (19185)
LTE Band 2 (PCS): 5 MHz	1852.5 (18625)		1880 (18900)		1907.5 (19175)
LTE Band 2 (PCS): 10 MHz	1855 (18650)		1880 (18900)		1905 (19150)
LTE Band 2 (PCS): 15 MHz	1857.5 (18675)		1880 (18900)		1902.5 (19125)
LTE Band 2 (PCS): 20 MHz	1860 (18700)		1880 (18900)		1900 (19100)
LTE Band 41: 5 MHz	2506 (39750)	2549.5 (40185)	2593 (40620)	2636.5 (41055)	2680 (41490)
LTE Band 41: 10 MHz	2506 (39750)	2549.5 (40185)	2593 (40620)	2636.5 (41055)	2680 (41490)
LTE Band 41: 15 MHz	2506 (39750)	2549.5 (40185)	2593 (40620)	2636.5 (41055)	2680 (41490)
LTE Band 41: 20 MHz	2506 (39750)	2549.5 (40185)	2593 (40620)	2636.5 (41055)	2680 (41490)
UE Category	DL UE Cat 20, UL UE Cat 13				
Modulations Supported in UL	QPSK, 16QAM, 64QAM				
LTE MPR Permanently implemented per 3GPP TS 36.101 section 6.2.3~6.2.5? (manufacturer attestation to be provided)	YES				
A-MPR (Additional MPR) disabled for SAR Testing?	YES				
LTE Carrier Aggregation Possible Combinations	The technical description includes all the possible carrier aggregation combinations				
LTE Additional Information	This device does not support full CA features on 3GPP Release 15. It supports carrier aggregation, downlink MIMO, LAA features as shown in Downlink LTE CA RF Conducted Powers Appendix. All uplink communications are identical to the Release 8 Specifications. Uplink communications are done on the PCC. The following LTE Release 15 Features are not supported: Relay, HetNet, Enhanced MIMO, eCIC, eMBMS, Cross-Carrier Scheduling, Enhanced SC-FDMA.				

FCC ID: PY7-25682R	SAR EVALUATION REPORT	Approved by: Technical Manager
Document S/N: 1M2302230018-05.PY7 (Rev2)	DUT Type: Portable Handset	Page 17 of 74

3 INTRODUCTION

The FCC and Innovation, Science, and Economic Development Canada have adopted the guidelines for evaluating the environmental effects of radio frequency (RF) radiation in ET Docket 93-62 on Aug. 6, 1996 and Health Canada Safety Code 6 to protect the public and workers from the potential hazards of RF emissions due to FCC-regulated portable devices. [1]

The safety limits used for the environmental evaluation measurements are based on the criteria published by the American National Standards Institute (ANSI) for localized specific absorption rate (SAR) in IEEE/ANSI C95.1-1992 Standard for Safety Levels with Respect to Human Exposure to Radio Frequency Electromagnetic Fields, 3 kHz to 300 GHz [3] and Health Canada RF Exposure Guidelines Safety Code 6 [22]. The measurement procedure described in IEEE/ANSI C95.3-2002 Recommended Practice for the Measurement of Potentially Hazardous Electromagnetic Fields - RF and Microwave [4] is used for guidance in measuring the Specific Absorption Rate (SAR) due to the RF radiation exposure from the Equipment Under Test (EUT). These criteria for SAR evaluation are similar to those recommended by the International Committee for Non-ionizing Radiation Protection (ICNIRP) in Biological Effects and Exposure Criteria for Radiofrequency Electromagnetic Fields,” Report No. Vol 74. SAR is a measure of the rate of energy absorption due to exposure to an RF transmitting source. SAR values have been related to threshold levels for potential biological hazards.

3.1 SAR Definition

Specific Absorption Rate is defined as the time derivative (rate) of the incremental energy (dU) absorbed by (dissipated in) an incremental mass (dm) contained in a volume element (dV) of a given density (ρ). It is also defined as the rate of RF energy absorption per unit mass at a point in an absorbing body (see Equation 3-1).

Equation 3-1
SAR Mathematical Equation

$$SAR = \frac{d}{dt} \left(\frac{dU}{dm} \right) = \frac{d}{dt} \left(\frac{dU}{\rho dv} \right)$$

SAR is expressed in units of Watts per Kilogram (W/kg).

$$SAR = \frac{\sigma \cdot E^2}{\rho}$$

where:

- σ = conductivity of the tissue-simulating material (S/m)
- ρ = mass density of the tissue-simulating material (kg/m³)
- E = Total RMS electric field strength (V/m)

NOTE: The primary factors that control rate of energy absorption were found to be the wavelength of the incident field in relation to the dimensions and geometry of the irradiated organism, the orientation of the organism in relation to the polarity of field vectors, the presence of reflecting surfaces, and whether conductive contact is made by the organism with a ground plane.[6]

FCC ID: PY7-25682R	SAR EVALUATION REPORT	Approved by: Technical Manager
Document S/N: 1M2302230018-05.PY7 (Rev2)	DUT Type: Portable Handset	Page 18 of 74

REV 22.0
03/30/2022

4 DOSIMETRIC ASSESSMENT

4.1 Measurement Procedure

The evaluation was performed using the following procedure compliant to FCC KDB Publication 865664 D01v01r04 and IEEE 1528-2013:

1. The SAR distribution at the exposed side of the head or body was measured at a distance no greater than 5.0 mm from the inner surface of the shell. The area covered the entire dimension of the device-head and body interface and the horizontal grid resolution was determined per FCC KDB Publication 865664 D01v01r04 (See Table 4-1) and IEEE 1528-2013.
2. The point SAR measurement was taken at the maximum SAR region determined from Step 1 to enable the monitoring of SAR fluctuations/drifts during the 1g/10g cube evaluation. SAR at this fixed point was measured and used as a reference value.
3. Based on the area scan data, the peak of the region with maximum SAR was determined by spline interpolation. Around this point, a volume was assessed according to the measurement resolution and volume size requirements of FCC KDB Publication 865664 D01v01r04 (See Table 4-1) and IEEE 1528-2013. On the basis of this data set, the spatial peak SAR value was evaluated with the following procedure (see references or the DASY manual online for more details):
 - a. SAR values at the inner surface of the phantom are extrapolated from the measured values along the line away from the surface with spacing no greater than that in Table 4-1. The extrapolation was based on a least-squares algorithm. A polynomial of the fourth order was calculated through the points in the z-axis (normal to the phantom shell).
 - b. After the maximum interpolated values were calculated between the points in the cube, the SAR was averaged over the spatial volume (1g or 10g) using a 3D-Spline interpolation algorithm. The 3D-spline is composed of three one-dimensional splines with the “Not a knot” condition (in x, y, and z directions). The volume was then integrated with the trapezoidal algorithm. One thousand points (10 x 10 x 10) were obtained through interpolation, in order to calculate the averaged SAR.
 - c. All neighboring volumes were evaluated until no neighboring volume with a higher average value was found.
4. The SAR reference value, at the same location as step 2, was re-measured after the zoom scan was complete to calculate the SAR drift. If the drift deviated by more than 5%, the SAR test and drift measurements were repeated.

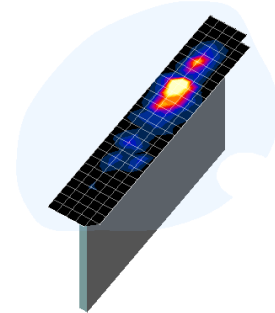

Figure 4-1
Sample SAR Area Scan

Table 4-1
Area and Zoom Scan Resolutions per FCC KDB Publication 865664 D01v01r04*

Frequency	Maximum Area Scan Resolution (mm) ($\Delta x_{area}, \Delta y_{area}$)	Maximum Zoom Scan Resolution (mm) ($\Delta x_{zoom}, \Delta y_{zoom}$)	Maximum Zoom Scan Spatial Resolution (mm)			Minimum Zoom Scan Volume (mm) (x, y, z)
			Uniform Grid	Graded Grid		
				$\Delta z_{zoom}(n)$	$\Delta z_{zoom}(1)^*$	
≤ 2 GHz	≤ 15	≤ 8	≤ 5	≤ 4	≤ 1.5* $\Delta z_{zoom}(n-1)$	≥ 30
2-3 GHz	≤ 12	≤ 5	≤ 5	≤ 4	≤ 1.5* $\Delta z_{zoom}(n-1)$	≥ 30
3-4 GHz	≤ 12	≤ 5	≤ 4	≤ 3	≤ 1.5* $\Delta z_{zoom}(n-1)$	≥ 28
4-5 GHz	≤ 10	≤ 4	≤ 3	≤ 2.5	≤ 1.5* $\Delta z_{zoom}(n-1)$	≥ 25
5-6 GHz	≤ 10	≤ 4	≤ 2	≤ 2	≤ 1.5* $\Delta z_{zoom}(n-1)$	≥ 22

*Also compliant to IEEE 1528-2013 Table 6

FCC ID: PY7-25682R	SAR EVALUATION REPORT	Approved by: Technical Manager
Document S/N: 1M2302230018-05.PY7 (Rev2)	DUT Type: Portable Handset	Page 19 of 74

REV 22.0
03/30/2022

5 DEFINITION OF REFERENCE POINTS

5.1 EAR REFERENCE POINT

Figure 5-2 shows the front, back and side views of the SAM Twin Phantom. The point “M” is the reference point for the center of the mouth, “LE” is the left ear reference point (ERP), and “RE” is the right ERP. The ERP is 15mm posterior to the entrance to the ear canal (EEC) along the B-M line (Back-Mouth), as shown in Figure 5-1. The plane passing through the two ear canals and M is defined as the Reference Plane. The line N-F (Neck-Front), also called the Reference Pivoting Line, is not perpendicular to the reference plane (see Figure 5-1). Line B-M is perpendicular to the N-F line. Both N-F and B-M lines are marked on the external phantom shell to facilitate handset positioning [5].

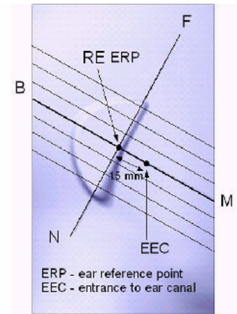

Figure 5-1
Close-Up Side view of ERP

5.2 HANDSET REFERENCE POINTS

Two imaginary lines on the handset were established: the vertical centerline and the horizontal line. The test device was placed in a normal operating position with the acoustic output located along the “vertical centerline” on the front of the device aligned to the “ear reference point” (See Figure 5-3). The acoustic output was then located at the same level as the center of the ear reference point. The test device was positioned so that the “vertical centerline” was bisecting the front surface of the handset at its top and bottom edges, positioning the “ear reference point” on the outer surface of the both the left and right head phantoms on the ear reference point.

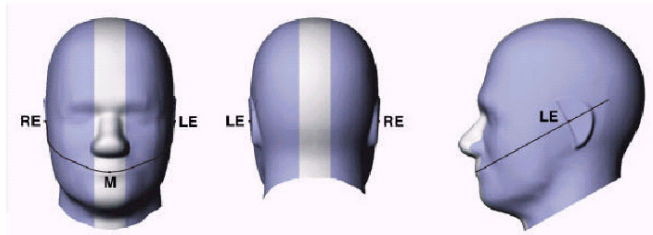

Figure 5-2
Front, back and side view of SAM Twin Phantom

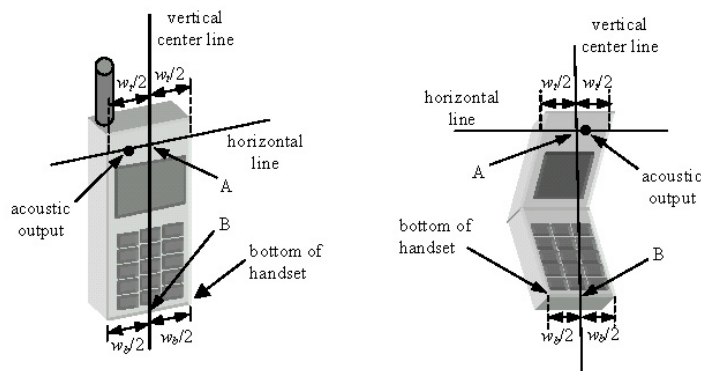

Figure 5-3
Handset Vertical Center & Horizontal Line Reference Points

FCC ID: PY7-25682R	SAR EVALUATION REPORT	Approved by: Technical Manager
Document S/N: 1M2302230018-05.PY7 (Rev2)	DUT Type: Portable Handset	Page 20 of 74

6 TEST CONFIGURATION POSITIONS

6.1 Device Holder

The device holder is made out of low-loss POM material having the following dielectric parameters: relative permittivity $\epsilon = 3$ and loss tangent $\delta = 0.02$.

6.2 Positioning for Cheek

1. The test device was positioned with the device close to the surface of the phantom such that point A is on the (virtual) extension of the line passing through points RE and LE on the phantom (see Figure 6-1), such that the plane defined by the vertical center line and the horizontal line of the phone is approximately parallel to the sagittal plane of the phantom.

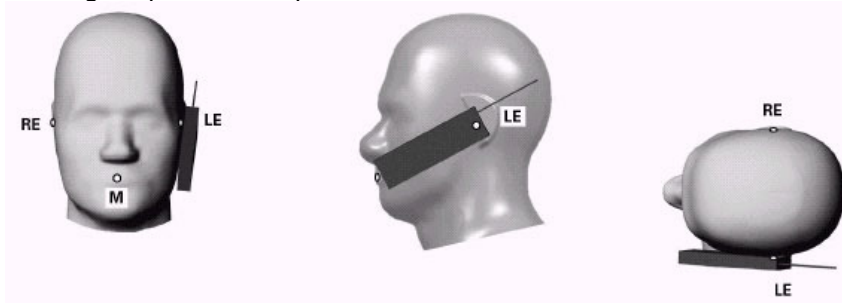

Figure 6-1 Front, Side and Top View of Cheek Position

2. The handset was translated towards the phantom along the line passing through RE & LE until the handset touches the pinna.
3. While maintaining the handset in this plane, the handset was rotated around the LE-RE line until the vertical centerline was in the reference plane.
4. The phone was then rotated around the vertical centerline until the phone (horizontal line) was symmetrical with respect to the line NF.
5. While maintaining the vertical centerline in the reference plane, keeping point A on the line passing through RE and LE, and maintaining the device contact with the ear, the device was rotated about the NF line until any point on the handset made contact with a phantom point below the ear (cheek) (See Figure 6-2).

6.3 Positioning for Ear / 15° Tilt

With the test device aligned in the “Cheek Position”:

1. While maintaining the orientation of the phone, the phone was retracted parallel to the reference plane far enough to enable a rotation of the phone by 15 degrees.
2. The phone was then rotated around the horizontal line by 15 degrees.
3. While maintaining the orientation of the phone, the phone was moved parallel to the reference plane until any part of the handset touched the head. (In this position, point A was located on the line RE-LE). The tilted position is obtained when the contact is on the pinna. If the contact was at any location other than the pinna, the angle of the phone would then be reduced. In this situation, the tilted position was obtained when any part of the phone was in contact of the ear as well as a second part of the phone was in contact with the head (see Figure 6-2).

FCC ID: PY7-25682R	SAR EVALUATION REPORT	Approved by: Technical Manager
Document S/N: 1M2302230018-05.PY7 (Rev2)	DUT Type: Portable Handset	Page 21 of 74

REV 22.0
03/30/2022

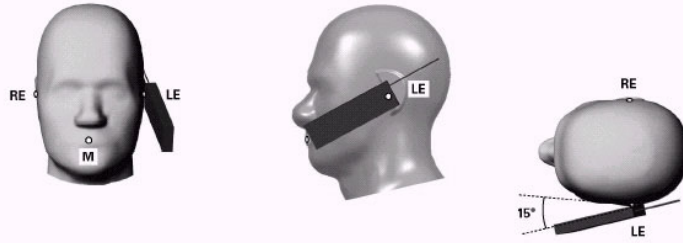

Figure 6-2 Front, Side and Top View of Ear/15° Tilt Position

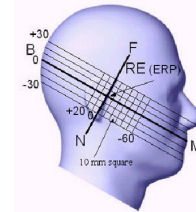

Figure 6-3 Side view w/ relevant markings

6.4 SAR Evaluations near the Mouth/Jaw Regions of the SAM Phantom

Antennas located near the bottom of a phone may require SAR measurements around the mouth and jaw regions of the SAM head phantom. This typically applies to clam-shell style phones that are generally longer in the unfolded normal use positions or to certain older style long rectangular phones. Per IEEE 1528-2013, a rotated SAM phantom is necessary to allow probe access to such regions. Both SAM heads of the TwinSAM-Chin20 are rotated 20 degrees around the NF line. Each head can be removed from the table for emptying and cleaning.

Under these circumstances, the following procedures apply, adopted from the FCC guidance on SAR handsets document FCC KDB Publication 648474 D04v01r03. The SAR required in these regions of SAM should be measured using a flat phantom. The phone should be positioned with a separation distance of 4 mm between the ear reference point (ERP) and the outer surface of the flat phantom shell. While maintaining this distance at the ERP location, the low (bottom) edge of the phone should be lowered from the phantom to establish the same separation distance between the peak SAR location identified by the truncated partial SAR distribution measured with the SAM phantom. The distance from the peak SAR location to the phone is determined by the straight line passing perpendicularly through the phantom surface. When it is not feasible to maintain 4 mm separation at the ERP while also establishing the required separation at the peak SAR location, the top edge of the phone will be allowed to touch the phantom with a separation < 4 mm at the ERP. The phone should not be tilted to the left or right while placed in this inclined position to the flat phantom.

6.5 Body-Worn Accessory Configurations

Body-worn operating configurations are tested with the belt-clips and holsters attached to the device and positioned against a flat phantom in a normal use configuration (see Figure 6-4). Per FCC KDB Publication 648474 D04v01r03, Body-worn accessory exposure is typically related to voice mode operations when handsets are carried in body-worn accessories. The body-worn accessory procedures in FCC KDB Publication 447498 D04v01 should be used to test for body-worn accessory SAR compliance, without a headset connected to it. This enables the test results for such configuration to be compatible with that required for hotspot mode when the body-worn accessory test separation distance is greater than or equal to that required for hotspot mode, when applicable. When the reported SAR for a body-worn accessory, measured without a headset connected to the handset, is > 1.2 W/kg, the highest reported SAR configuration for that wireless mode and frequency band should be repeated for that body-worn accessory with a headset attached to the handset.

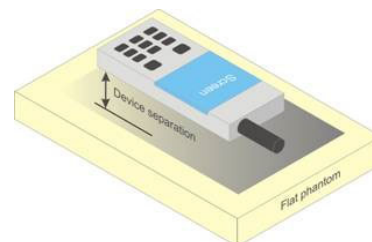

Figure 6-4 Sample Body-Worn Diagram

Accessories for Body-worn operation configurations are divided into two categories: those that do not contain metallic components and those that do contain metallic components. When multiple accessories that do not

FCC ID: PY7-25682R	SAR EVALUATION REPORT	Approved by: Technical Manager
Document S/N: 1M2302230018-05.PY7 (Rev2)	DUT Type: Portable Handset	Page 22 of 74

contain metallic components are supplied with the device, the device is tested with only the accessory that dictates the closest spacing to the body. Then multiple accessories that contain metallic components are tested with the device with each accessory. If multiple accessories share an identical metallic component (i.e. the same metallic belt-clip used with different holsters with no other metallic components) only the accessory that dictates the closest spacing to the body is tested.

Body-worn accessories may not always be supplied or available as options for some devices intended to be authorized for body-worn use. In this case, a test configuration with a separation distance between the back of the device and the flat phantom is used. Test position spacing was documented. Transmitters that are designed to operate in front of a person’s face, as in push-to-talk configurations, are tested for SAR compliance with the front of the device positioned to face the flat phantom in head fluid. For devices that are carried next to the body such as a shoulder, waist or chest-worn transmitters, SAR compliance is tested with the accessories, including headsets and microphones, attached to the device and positioned against a flat phantom in a normal use configuration.

6.6 Extremity Exposure Configurations

Devices that are designed or intended for use on extremities or mainly operated in extremity only exposure conditions; i.e., hands, wrists, feet and ankles, may require extremity SAR evaluation. When the device also operates in close proximity to the user’s body, SAR compliance for the body is also required. The 1g body and 10g extremity SAR Exclusion Thresholds found in KDB Publication 447498 D04v01 should be applied to determine SAR test requirements.

Per KDB Publication 447498 D04v01, Cell phones (handsets) are not normally designed to be used on extremities or operated in extremity only exposure conditions. The maximum output power levels of handsets generally do not require extremity SAR testing to show compliance. Therefore, extremity SAR was not evaluated for this device.

6.7 Wireless Router Configurations

Some battery-operated handsets have the capability to transmit and receive user data through simultaneous transmission of WIFI simultaneously with a separate licensed transmitter. The FCC has provided guidance in FCC KDB Publication 941225 D06v02r01 where SAR test considerations for handsets (L x W ≥ 9 cm x 5 cm) are based on a composite test separation distance of 10 mm from the front, back and edges of the device containing transmitting antennas within 2.5 cm of their edges, determined from general mixed use conditions for this type of devices. Since the hotspot SAR results may overlap with the body-worn accessory SAR requirements, the more conservative configurations can be considered, thus excluding some body-worn accessory SAR tests.

When the user enables the personal wireless router functions for the handset, actual operations include simultaneous transmission of both the WIFI transmitter and another licensed transmitter. Both transmitters often do not transmit at the same transmitting frequency and thus cannot be evaluated for SAR under actual use conditions due to the limitations of the SAR assessment probes. Therefore, SAR must be evaluated for each frequency transmission and mode separately and spatially summed with the WIFI transmitter according to FCC KDB Publication 447498 D04v01 procedures. The “Portable Hotspot” feature on the handset was NOT activated during SAR assessments, to ensure the SAR measurements were evaluated for a single transmission frequency RF signal at a time.

6.8 Phablet Configurations

For smart phones with a display diagonal dimension > 150 mm or an overall diagonal dimension > 160 mm that provide similar mobile web access and multimedia support found in mini-tablets or UMPC mini-tablets that

FCC ID: PY7-25682R	SAR EVALUATION REPORT	Approved by: Technical Manager
Document S/N: 1M2302230018-05.PY7 (Rev2)	DUT Type: Portable Handset	Page 23 of 74



support voice calls next to the ear, the phablets procedures outlined in KDB Publication 648474 D04v01r03 should be applied to evaluate SAR compliance. A device marketed as phablets, regardless of form factors and operating characteristics must be tested as a phablet to determine SAR compliance. In addition to the normally required head and body-worn accessory SAR test procedures required for handsets, the UMPC mini-tablet procedures must also be applied to test the SAR of all surfaces and edges with an antenna ≤ 25 mm from that surface or edge, in direct contact with the phantom, for 10g SAR. The UMPC mini-tablet 1g SAR at 5 mm is not required. When hotspot mode applies, 10g SAR is required only for the surfaces and edges with hotspot mode 1g SAR > 1.2 W/kg.

FCC ID: PY7-25682R	SAR EVALUATION REPORT	Approved by: Technical Manager
Document S/N: 1M2302230018-05.PY7 (Rev2)	DUT Type: Portable Handset	Page 24 of 74

REV 22.0
03/30/2022

7 RF EXPOSURE LIMITS

7.1 Uncontrolled Environment

UNCONTROLLED ENVIRONMENTS are defined as locations where there is the exposure of individuals who have no knowledge or control of their exposure. The general population/uncontrolled exposure limits are applicable to situations in which the general public may be exposed or in which persons who are exposed as a consequence of their employment may not be made fully aware of the potential for exposure or cannot exercise control over their exposure. Members of the general public would come under this category when exposure is not employment-related; for example, in the case of a wireless transmitter that exposes persons in its vicinity.

7.2 Controlled Environment

CONTROLLED ENVIRONMENTS are defined as locations where there is exposure that may be incurred by persons who are aware of the potential for exposure, (i.e. as a result of employment or occupation). In general, occupational/controlled exposure limits are applicable to situations in which persons are exposed as a consequence of their employment, who have been made fully aware of the potential for exposure and can exercise control over their exposure. This exposure category is also applicable when the exposure is of a transient nature due to incidental passage through a location where the exposure levels may be higher than the general population/uncontrolled limits, but the exposed person is fully aware of the potential for exposure and can exercise control over his or her exposure by leaving the area or by some other appropriate means.

**Table 7-1
SAR Human Exposure Specified in ANSI/IEEE C95.1-1992 and Health Canada Safety Code 6**

HUMAN EXPOSURE LIMITS		
	UNCONTROLLED ENVIRONMENT <i>General Population (W/kg) or (mW/g)</i>	CONTROLLED ENVIRONMENT <i>Occupational (W/kg) or (mW/g)</i>
Peak Spatial Average SAR Head	1.6	8.0
Whole Body SAR	0.08	0.4
Peak Spatial Average SAR Hands, Feet, Ankle, Wrists, etc.	4.0	20

1. The Spatial Peak value of the SAR averaged over any 1 gram of tissue (defined as a tissue volume in the shape of a cube) and over the appropriate averaging time.
2. The Spatial Average value of the SAR averaged over the whole body.
3. The Spatial Peak value of the SAR averaged over any 10 grams of tissue (defined as a tissue volume in the shape of a cube) and over the appropriate averaging time.

FCC ID: PY7-25682R	SAR EVALUATION REPORT	Approved by: Technical Manager
Document S/N: 1M2302230018-05.PY7 (Rev2)	DUT Type: Portable Handset	Page 25 of 74

REV 22.0
03/30/2022

8 FCC MEASUREMENT PROCEDURES

Power measurements for licensed transmitters are performed using a base station simulator under digital average power.

8.1 Measured and Reported SAR

Per FCC KDB Publication 447498 D04v01, when SAR is not measured at the maximum power level allowed for production units, the results must be scaled to the maximum tune-up tolerance limit according to the power applied to the individual channels tested to determine compliance. For simultaneous transmission, the measured aggregate SAR must be scaled according to the sum of the differences between the maximum tune-up tolerance and actual power used to test each transmitter. When SAR is measured at or scaled to the maximum tune-up tolerance limit, the results are referred to as *reported* SAR. The highest *reported* SAR results are identified on the grant of equipment authorization according to procedures in KDB 690783 D01v01r03.

8.2 3G SAR Test Reduction Procedure

In FCC KDB Publication 941225 D01v03r01, certain transmission modes within a frequency band and wireless mode evaluated for SAR are defined as primary modes. The equivalent modes considered for SAR test reduction are denoted as secondary modes. When the maximum output power including tune-up tolerance specified for production units in a secondary mode is ≤ 0.25 dB higher than the primary mode or when the highest reported SAR of the primary mode, scaled by the ratio of specified maximum output power and tune-up tolerance of secondary to primary mode, is ≤ 1.2 W/kg, SAR measurements are not required for the secondary mode. These criteria are referred to as the 3G SAR test reduction procedure. When the 3G SAR test reduction procedure is not satisfied, SAR measurements are additionally required for the secondary mode.

8.3 Procedures Used to Establish RF Signal for SAR

The following procedures are according to FCC KDB Publication 941225 D01v03r01 “3G SAR Measurement Procedures.”

The device is placed into a simulated call using a base station simulator in a RF shielded chamber. Establishing connections in this manner ensure a consistent means for testing SAR and are recommended for evaluating SAR [4]. Devices under test are evaluated prior to testing, with a fully charged battery and were configured to operate at maximum output power. In order to verify that the device is tested throughout the SAR test at maximum output power, the SAR measurement system measures a “point SAR” at an arbitrary reference point at the start and end of the 1 gram SAR evaluation, to assess for any power drifts during the evaluation. If the power drift deviates by more than 5%, the SAR test and drift measurements are repeated.

8.4 SAR Measurement Conditions for UMTS

8.4.1 Output Power Verification

Maximum output power is verified on the High, Middle and Low channels according to the general descriptions in section 5.2 of 3GPP TS 34.121, using the appropriate RMC with TPC (transmit power control) set to all “1s” or applying the required inner loop power control procedures to maintain maximum output power while HSUPA is active. Results for all applicable physical channel configurations (DPCCCH, DPDCHn and spreading codes, HS-DPCCH etc) are tabulated in this test report. All configurations that are not supported by the DUT or cannot be measured due to technical or equipment limitations are identified.

FCC ID: PY7-25682R	SAR EVALUATION REPORT	Approved by: Technical Manager
Document S/N: 1M2302230018-05.PY7 (Rev2)	DUT Type: Portable Handset	Page 26 of 74

REV 22.0
03/30/2022

8.4.2 Head SAR Measurements

SAR for next to the ear head exposure is measured using a 12.2 kbps RMC with TPC bits configured to all “1’s”. The 3G SAR test reduction procedure is applied to AMR configurations with 12.2 kbps RMC as the primary mode. Otherwise, SAR is measured for 12.2 kbps AMR in 3.4 kbps SRB (signaling radio bearer) using the highest reported SAR configuration in 12.2 kbps RMC for head exposure.

8.4.3 Body SAR Measurements

SAR for body exposure configurations is measured using the 12.2 kbps RMC with the TPC bits all “1s”. The 3G SAR test reduction procedure is applied to other spreading codes and multiple DPDCH_n configurations supported by the handset with 12.2 kbps RMC as the primary mode. Otherwise, SAR is measured using an applicable RMC configuration with the corresponding spreading code or DPDCH_n, for the highest reported SAR configuration in 12.2 kbps RMC.

8.4.4 SAR Measurements with Rel 5 HSDPA

The 3G SAR test reduction procedure is applied to HSDPA body configurations with 12.2 kbps RMC as the primary mode. Otherwise, Body SAR for HSDPA is measured using an FRC with H-Set 1 in Sub-test 1 and a 12.2 kbps RMC configured in Test Loop Mode 1, for the highest reported SAR configuration in 12.2 kbps RMC without HSDPA. Handsets with both HSDPA and HSUPA are tested according to Release 6 HSPA test procedures.

8.4.5 SAR Measurements with Rel 6 HSUPA

The 3G SAR test reduction procedure is applied to HSPA (HSUPA/HSDPA with RMC) body configurations with 12.2 kbps RMC as the primary mode. Otherwise, Body SAR for HSPA is measured with E-DCH Sub-test 5, using H-Set 1 and QPSK for FRC and a 12.2 kbps RMC configured in Test Loop Mode 1 and power control algorithm 2, according to the highest reported body SAR configuration in 12.2 kbps RMC without HSPA.

When VOIP applies to head exposure, the 3G SAR test reduction procedure is applied with 12.2 kbps RMC as the primary mode; otherwise, the same HSPA configuration used for body SAR measurements are applied to head exposure testing.

8.4.6 SAR Measurement Conditions for DC-HSDPA

SAR is required for Rel. 8 DC-HSDPA when SAR is required for Rel. 5 HSDPA; otherwise, the 3G SAR test reduction procedure is applied to DC-HSDPA with 12.2 kbps RMC as the primary mode. Power is measured for DC-HSDPA according to the H-Set 12, FRC configuration in Table C.8.1.12 of 3GPP TS 34.121-1 to determine SAR test reduction. A primary and a secondary serving HS-DSCH Cell are required to perform the power measurement and for the results to be acceptable.

8.5 SAR Measurement Conditions for LTE

LTE modes are tested according to FCC KDB 941225 D05v02r04 publication. Establishing connections with base station simulators ensure a consistent means for testing SAR and are recommended for evaluating SAR [4]. The R&S CMW500 or Anritsu MT8820C simulators are used for LTE output power measurements and SAR testing. Closed loop power control was used so the UE transmits with maximum output power during SAR testing. SAR tests were performed with the same number of RB and RB offsets transmitting on all TTI frames (maximum TTI).

FCC ID: PY7-25682R	SAR EVALUATION REPORT	Approved by: Technical Manager
Document S/N: 1M2302230018-05.PY7 (Rev2)	DUT Type: Portable Handset	Page 27 of 74

REV 22.0
03/30/2022

8.5.1 Spectrum Plots for RB Configurations

A properly configured base station simulator was used for SAR tests and power measurements. Therefore, spectrum plots for RB configurations were not required to be included in this report.

8.5.2 MPR

MPR is permanently implemented for this device by the manufacturer. The specific manufacturer target MPR is indicated alongside the SAR results. MPR is enabled for this device, according to 3GPP TS36.101 Section 6.2.3 – 6.2.5 under Table 6.2.3-1.

8.5.3 A-MPR

A-MPR (Additional MPR) has been disabled for all SAR tests by setting NS=01 on the base station simulator.

8.5.4 Required RB Size and RB Offsets for SAR Testing

According to FCC KDB 941225 D05v02r04:

- a. Per Section 5.2.1, SAR is required for QPSK 1 RB Allocation for the largest bandwidth
 - i. The required channel and offset combination with the highest maximum output power is required for SAR.
 - ii. When the reported SAR is ≤ 0.8 W/kg, testing of the remaining RB offset configurations and required test channels is not required. Otherwise, SAR is required for the remaining required test channels using the RB offset configuration with highest output power for that channel.
 - iii. When the reported SAR for a required test channel is > 1.45 W/kg, SAR is required for all RB offset configurations for that channel.
- b. Per Section 5.2.2, SAR is required for 50% RB allocation using the largest bandwidth following the same procedures outlined in Section 5.2.1.
- c. Per Section 5.2.3, QPSK SAR is not required for the 100% allocation when the highest maximum output power for the 100% allocation is less than the highest maximum output power of the 1 RB and 50% RB allocations and the reported SAR for the 1 RB and 50% RB allocations is < 0.8 W/kg.
- d. Per Section 5.2.4 and 5.3, SAR tests for higher order modulations and lower bandwidths configurations are not required when the conducted power of the required test configurations determined by Sections 5.2.1 through 5.2.3 is less than or equal to $\frac{1}{2}$ dB higher than the equivalent configuration using QPSK modulation and when the QPSK SAR for those configurations is < 1.45 W/kg.

8.5.5 TDD

LTE TDD testing is performed using the SAR test guidance provided in FCC KDB 941225 D05v02r04. TDD is tested at the highest duty factor using UL-DL configuration 0 with special subframe configuration 6 and applying the FDD LTE procedures in KDB 941225 D05v02r04. SAR testing is performed using the extended cyclic prefix listed in 3GPP TS 36.211 Section 4.

8.5.6 Downlink Only Carrier Aggregation

Conducted power measurements with LTE Carrier Aggregation (CA) (downlink only) active are made in accordance to KDB Publication 941225 D05Av01r02. The RRC connection is only handled by one cell, the primary component carrier (PCC) for downlink and uplink communications. After making a data connection to the PCC, the UE device adds secondary component carrier(s) (SCC) on the downlink only. All uplink communications and acknowledgements remain identical to specifications when downlink

FCC ID: PY7-25682R	SAR EVALUATION REPORT	Approved by: Technical Manager
Document S/N: 1M2302230018-05.PY7 (Rev2)	DUT Type: Portable Handset	Page 28 of 74

carrier aggregation is inactive on the PCC. Additional conducted output powers are measured with the downlink carrier aggregation active for the configuration with highest measured maximum conducted power with downlink carrier aggregation inactive measured among the channel bandwidth, modulation, and RB combinations in each frequency band. Per FCC KDB Publication 941225 D05Av01r02, no SAR measurements are required for downlink only carrier aggregation configurations when the average output power with downlink only carrier aggregation active is not more than 0.25 dB higher than the average output power with downlink only carrier aggregation inactive.

8.6 SAR Testing with 802.11 Transmitters

The normal network operating configurations of 802.11 transmitters are not suitable for SAR measurements. Unpredictable fluctuations in network traffic and antenna diversity conditions can introduce undesirable variations in SAR results. The SAR for these devices should be measured using chipset based test mode software to ensure the results are consistent and reliable. See KDB Publication 248227 D01v02r02 for more details.

8.6.1 General Device Setup

Chipset based test mode software is hardware dependent and generally varies among manufacturers. The device operating parameters established in test mode for SAR measurements must be identical to those programmed in production units, including output power levels, amplifier gain settings and other RF performance tuning parameters.

A periodic duty factor is required for current generation SAR systems to measure SAR. When 802.11 frame gaps are accounted for in the transmission, a maximum transmission duty factor of 92 - 96% is typically achievable in most test mode configurations. A minimum transmission duty factor of 85% is required to avoid certain hardware and device implementation issues related to wide range SAR scaling. The reported SAR is scaled to 100% transmission duty factor to determine compliance at the maximum tune-up tolerance limit.

8.6.2 U-NII-1 and U-NII-2A

For devices that operate in both U-NII-1 and U-NII-2A bands, when the same maximum output power is specified for both bands, SAR measurement using OFDM SAR test procedures is not required for U-NII-1 unless the highest reported SAR for U-NII-2A is > 1.2 W/kg. When different maximum output powers are specified for the bands, SAR measurement for the U-NII band with the lower maximum output power is not required unless the highest reported SAR for the U-NII band with the higher maximum output power, adjusted by the ratio of lower to higher specified maximum output power for the two bands, is > 1.2 W/kg. When 10g SAR measurement is considered, a factor of 2.5 is applied to the thresholds above.

8.6.3 U-NII-2C and U-NII-3

The frequency range covered by U-NII-2C and U-NII-3 is 380 MHz (5.47 – 5.85 GHz), which requires a minimum of at least two SAR probe calibration frequency points to support SAR measurements. When Terminal Doppler Weather Radar (TDWR) restriction applies, the channels at 5.60 – 5.65 GHz in U-NII-2C band must be disabled with acceptable mechanisms and documented in the equipment certification. Unless band gap channels are permanently disabled, SAR must be considered for these channels. Each band is tested independently according to the normally required OFDM SAR measurement and probe calibration frequency points requirements.

FCC ID: PY7-25682R	SAR EVALUATION REPORT	Approved by: Technical Manager
Document S/N: 1M2302230018-05.PY7 (Rev2)	DUT Type: Portable Handset	Page 29 of 74

REV 22.0
03/30/2022

8.6.4 Initial Test Position Procedure

For exposure conditions with multiple test positions, such as handset operating next to the ear, devices with hotspot mode or UMPC mini-tablet, procedures for initial test position can be applied. Using the transmission mode determined by the DSSS procedure or initial test configuration, area scans are measured for all positions in an exposure condition. The test position with the highest extrapolated (peak) SAR is used as the initial test position. When reported SAR for the initial test position is ≤ 0.4 W/kg, no additional testing for the remaining test positions is required. Otherwise, SAR is evaluated at the subsequent highest peak SAR positions until the reported SAR result is ≤ 0.8 W/kg or all test positions are measured. When 10g SAR measurement is considered, a factor of 2.5 is applied to the thresholds above.

8.6.5 2.4 GHz SAR Test Requirements

SAR is measured for 2.4 GHz 802.11b DSSS using either the fixed test position or, when applicable, the initial test position procedure. SAR test reduction is determined according to the following:

- 1) When the reported SAR of the highest measured maximum output power channel for the exposure configuration is ≤ 0.8 W/kg, no further SAR testing is required for 802.11b DSSS in that exposure configuration.
- 2) When the reported SAR is > 0.8 W/kg, SAR is required for that position using the next highest measured output power channel. When any reported SAR is > 1.2 W/kg, SAR is required for the third channel; i.e., all channels require testing.

2.4 GHz 802.11 g/n/ax OFDM are additionally evaluated for SAR if the highest reported SAR for 802.11b, adjusted by the ratio of the OFDM to DSSS specified maximum output power, is > 1.2 W/kg. When SAR is required for OFDM modes in 2.4 GHz band, the Initial Test Configuration Procedures should be followed. When 10g SAR measurement is considered, a factor of 2.5 is applied to the thresholds above.

8.6.6 OFDM Transmission Mode and SAR Test Channel Selection

When the same maximum output power was specified for multiple OFDM transmission mode configurations in a frequency band or aggregated band, SAR is measured using the configuration with the largest channel bandwidth, lowest order modulation and lowest data rate. When the maximum output power of a channel is the same for equivalent OFDM configurations; for example, 802.11a, 802.11n and 802.11ac or 802.11g and 802.11n with the same channel bandwidth, modulation and data rate etc., the lower order 802.11 mode i.e., 802.11a, then 802.11n and 802.11ac or 802.11g then 802.11n, is used for SAR measurement. Per April 2019 TCB Workshop guidance, 802.11ax was considered the highest order 802.11 mode. When the maximum output power are the same for multiple test channels, either according to the default or additional power measurement requirements, SAR is measured using the channel closest to the middle of the frequency band or aggregated band. When there are multiple channels with the same maximum output power, SAR is measured using the higher number channel.

8.6.7 Initial Test Configuration Procedure

For OFDM, an initial test configuration is determined for each frequency band and aggregated band, according to the transmission mode with the highest maximum output power specified for SAR measurements. When the same maximum output power is specified for multiple OFDM transmission mode configurations in a frequency band or aggregated band, SAR is measured using the configuration(s) with the largest channel bandwidth, lowest order modulation, lowest data rate and lowest order IEEE 802.11 mode. The channel of the transmission mode with the highest average RF output conducted power will be the initial test configuration.

FCC ID: PY7-25682R	SAR EVALUATION REPORT	Approved by: Technical Manager
Document S/N: 1M2302230018-05.PY7 (Rev2)	DUT Type: Portable Handset	Page 30 of 74

When the reported SAR is ≤ 0.8 W/kg, no additional measurements on other test channels are required. Otherwise, SAR is evaluated using the subsequent highest average RF output channel until the reported SAR result is ≤ 1.2 W/kg or all channels are measured. When there are multiple untested channels having the same subsequent highest average RF output power, the channel with higher frequency from the lowest 802.11 mode is considered for SAR measurements (See Section 8.6.6). When 10g SAR measurement is considered, a factor of 2.5 is applied to the thresholds above.

8.6.8 Subsequent Test Configuration Procedures

For OFDM configurations in each frequency band and aggregated band, SAR is evaluated for initial test configuration using the fixed test position or the initial test position procedure. When the highest reported SAR (for the initial test configuration), adjusted by the ratio of the specified maximum output power of the subsequent test configuration to initial test configuration, is ≤ 1.2 W/kg, no additional SAR tests for the subsequent test configurations are required. When 10g SAR measurement is considered, a factor of 2.5 is applied to the thresholds above.

8.6.9 MIMO SAR considerations

Per KDB Publication 248227 D01v02r02, the simultaneous SAR provisions in KDB Publication 447498 D04v01 should be applied to determine simultaneous transmission SAR test exclusion for WIFI MIMO. If the sum of 1g single transmission chain SAR measurements is < 1.6 W/kg, no additional SAR measurements for MIMO are required. Alternatively, SAR for MIMO can be measured with all antennas transmitting simultaneously at the specified maximum output power of MIMO operation. When 10g SAR measurement is considered, a factor of 2.5 is applied to the thresholds above.

FCC ID: PY7-25682R	SAR EVALUATION REPORT	Approved by: Technical Manager
Document S/N: 1M2302230018-05.PY7 (Rev2)	DUT Type: Portable Handset	Page 31 of 74

REV 22.0
03/30/2022

9 RF CONDUCTED POWERS

9.1 GSM Conducted Powers

**Table 9-1
GSM/GPRS/EDGE Maximum Conducted Powers**

Maximum Burst-Averaged Output Power										
		Voice	GPRS/EDGE Data (GMSK)				EDGE Data (8-PSK)			
Band	Channel	GSM [dBm] CS (1 Slot)	GPRS [dBm] 1 Tx Slot	GPRS [dBm] 2 Tx Slot	GPRS [dBm] 3 Tx Slot	GPRS [dBm] 4 Tx Slot	EDGE [dBm] 1 Tx Slot	EDGE [dBm] 2 Tx Slot	EDGE [dBm] 3 Tx Slot	EDGE [dBm] 4 Tx Slot
GSM 850	128	31.75	32.00	28.78	27.11	25.91	26.73	23.91	22.01	21.00
	190	31.72	31.75	28.84	27.19	25.74	26.62	23.91	22.11	21.10
	251	31.65	31.76	28.88	26.28	25.98	26.72	23.81	22.09	21.03
GSM 1900	512	26.60	26.71	23.65	21.98	20.60	25.55	22.60	20.63	19.15
	661	26.77	26.66	23.83	22.04	20.79	25.61	22.70	20.91	19.32
	810	26.88	27.15	23.78	22.18	20.90	25.59	22.76	20.63	19.41

Calculated Maximum Frame-Averaged Output Power										
		Voice	GPRS/EDGE Data (GMSK)				EDGE Data (8-PSK)			
Band	Channel	GSM [dBm] CS (1 Slot)	GPRS [dBm] 1 Tx Slot	GPRS [dBm] 2 Tx Slot	GPRS [dBm] 3 Tx Slot	GPRS [dBm] 4 Tx Slot	EDGE [dBm] 1 Tx Slot	EDGE [dBm] 2 Tx Slot	EDGE [dBm] 3 Tx Slot	EDGE [dBm] 4 Tx Slot
GSM 850	128	22.55	22.80	22.59	22.68	22.73	17.53	17.72	17.58	17.82
	190	22.52	22.55	22.65	22.76	22.56	17.42	17.72	17.68	17.92
	251	22.45	22.56	22.69	21.85	22.80	17.52	17.62	17.66	17.85
GSM 1900	512	17.40	17.51	17.46	17.55	17.42	16.35	16.41	16.20	15.97
	661	17.57	17.46	17.64	17.61	17.61	16.41	16.51	16.48	16.14
	810	17.68	17.95	17.59	17.75	17.72	16.39	16.57	16.20	16.23

FCC ID: PY7-25682R	SAR EVALUATION REPORT	Approved by: Technical Manager
Document S/N: 1M2302230018-05.PY7 (Rev2)	DUT Type: Portable Handset	Page 32 of 74

**Table 9-2
DTM Maximum Conducted Powers**

Maximum Burst-Averaged Output Power					
Band	Channel	DTM (GSM + GPRS)		DTM (GSM + EGPRS)	
		DTM [dBm] CS + PS (2 Slots)	DTM [dBm] CS + 2PS (3 Slots)	DTM [dBm] CS + PS (2 Slots)	DTM [dBm] CS + 2PS (3 Slots)
GSM 850	128	29.87	27.57	24.34	22.76
	190	29.26	27.50	24.51	22.80
	251	29.44	27.72	24.43	22.70
GSM 1900	512	24.41	22.66	23.31	21.51
	661	24.71	22.89	23.60	21.78
	810	24.87	23.15	23.46	21.81

Calculated Maximum Frame-Averaged Output Power					
Band	Channel	GPRS/EDGE Data (GMSK)		EDGE Data (8-PSK)	
		GPRS [dBm] 2 Tx Slot	GPRS [dBm] 3 Tx Slot	EDGE [dBm] 2 Tx Slot	EDGE [dBm] 3 Tx Slot
GSM 850	128	23.68	23.14	18.15	18.33
	190	23.07	23.07	18.32	18.37
	251	23.25	23.29	18.24	18.27
GSM 1900	512	18.22	18.23	17.12	17.08
	661	18.52	18.46	17.41	17.35
	810	18.68	18.72	17.27	17.38

GSM 850	Frame	22.71	22.67	17.81	17.77
GSM 1900	Avg. Targets:	17.81	17.77	16.81	16.77

Note:

- Both burst-averaged and calculated frame-averaged powers are included. Frame-averaged power was calculated from the measured burst-averaged power by converting the slot powers into linear units and calculating the energy over 8 timeslots.
- GPRS/EDGE (GMSK) output powers were measured with coding scheme setting of 1 (CS1) on the base station simulator. CS1 was configured to measure GPRS output power measurements and SAR to

FCC ID: PY7-25682R	SAR EVALUATION REPORT	Approved by: Technical Manager
Document S/N: 1M2302230018-05.PY7 (Rev2)	DUT Type: Portable Handset	Page 33 of 74

ensure GMSK modulation in the signal. Our Investigation has shown that CS1 - CS4 settings do not have any impact on the output levels or modulation in the GPRS modes.

3. EDGE (8-PSK) output powers were measured with MCS7 on the base station simulator. MCS7 coding scheme was used to measure the output powers for EDGE since investigation has shown that choosing MCS7 coding scheme will ensure 8-PSK modulation. It has been shown that MCS levels that produce 8-PSK modulation do not have an impact on output power.
4. DTM output powers were measured with a communication test set with DTM supported when the device was operating in DTM using one CS slot plus PS multislots. The bolded DTM modes were selected for SAR testing according to the according to the maximum CS and PS slots according to KDB 941225 D04v01.

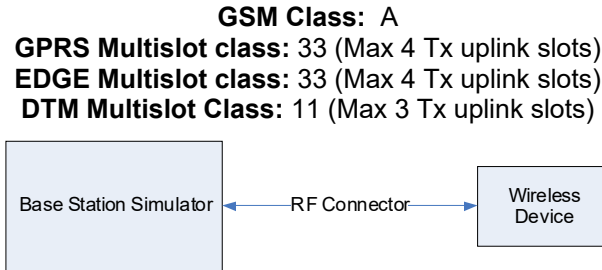

Figure 9-1
Power Measurement Setup

FCC ID: PY7-25682R	SAR EVALUATION REPORT	Approved by: Technical Manager
Document S/N: 1M2302230018-05.PY7 (Rev2)	DUT Type: Portable Handset	Page 34 of 74

9.2 UMTS Conducted Powers

**Table 9-3
Maximum Conducted Powers**

3GPP Release Version	Mode	3GPP 34.121 Subtest	Cellular Band [dBm]			AWS Band [dBm]			PCS Band [dBm]			3GPP MPR [dB]
			4132	4183	4233	1312	1412	1513	9262	9400	9538	
99	WCDMA	12.2 kbps RMC	22.61	22.64	22.60	18.42	18.49	18.42	18.53	18.61	18.51	-
99		12.2 kbps AMR	22.69	22.65	22.62	18.39	18.49	18.36	18.50	18.59	18.51	-
6	HSDPA	Subtest 1	21.18	21.21	21.11	16.85	17.00	16.95	17.88	17.91	17.75	0
6		Subtest 2	21.19	21.20	21.13	16.87	16.99	16.95	17.90	17.93	17.78	0
6		Subtest 3	20.68	20.65	20.62	16.39	16.49	16.47	17.38	17.41	17.26	0.5
6		Subtest 4	20.68	20.66	20.61	16.44	16.48	16.44	17.37	17.39	17.24	0.5
6	HSUPA	Subtest 1	21.17	21.17	21.12	16.89	16.99	16.95	17.86	17.90	17.76	0
6		Subtest 2	19.15	19.15	19.11	14.85	14.95	14.91	15.83	15.86	15.74	2
6		Subtest 3	20.14	20.16	20.10	15.84	15.95	15.92	16.81	16.86	16.73	1
6		Subtest 4	19.14	19.13	19.08	14.85	14.98	14.92	15.83	15.88	15.75	2
6		Subtest 5	21.16	21.17	21.10	16.87	16.99	16.96	17.85	17.91	17.77	0
8	DC-HSDPA	Subtest 1	21.14	21.15	21.09	16.83	16.98	16.94	17.84	17.85	17.73	0
8		Subtest 2	21.17	21.14	21.10	16.83	16.96	16.92	17.85	17.88	17.75	0
8		Subtest 3	20.64	20.67	20.58	16.33	16.48	16.45	17.31	17.36	17.24	0.5
8		Subtest 4	20.66	20.63	20.60	16.32	16.46	16.40	17.31	17.35	17.24	0.5

DC-HSDPA considerations

- 3GPP Specification 34.121-1 Release 8 Ver 8.10.0 was used for DC-HSDPA guidance
- H-Set 12 (QPSK) was confirmed to be used during DC-HSDPA measurements
- The DUT supports UE category 24 for HSDPA



**Figure 9-2
Power Measurement Setup**

FCC ID: PY7-25682R	SAR EVALUATION REPORT	Approved by: Technical Manager
Document S/N: 1M2302230018-05.PY7 (Rev2)	DUT Type: Portable Handset	Page 35 of 74

9.3 LTE Conducted Powers

Note: Per FCC KDB Publication 941225 D05v02r05, LTE SAR for the lower bandwidths was not required for testing since the maximum average output power of all required channels and configurations was not more than 0.5 dB higher than the highest bandwidth and the reported LTE SAR for the highest bandwidth was less than 1.45 W/kg. Lower bandwidth conducted powers for all LTE bands can be found in LTE Lower Bandwidth RF Conducted Powers Appendix.

Note: Some bands do not support three non-overlapping channels. Per KDB Publication 941225 D05v02, when a device supports overlapping channel assignment in a channel bandwidth configuration, the middle channel of the group of overlapping channels should be selected for testing.

FCC ID: PY7-25682R	SAR EVALUATION REPORT	Approved by: Technical Manager
Document S/N: 1M2302230018-05.PY7 (Rev2)	DUT Type: Portable Handset	Page 36 of 74

REV 22.0
03/30/2022

9.3.1 LTE Band 12

**Table 9-4
LTE Band 12 Maximum Conducted Powers - 10 MHz Bandwidth**

LTE Band 12 10 MHz Bandwidth					
Modulation	RB Size	RB Offset	Mid Channel	MPR Allowed per 3GPP [dB]	MPR [dB]
			23095 (707.5 MHz)		
			Conducted Power [dBm]		
QPSK	1	0	21.37	0	0
	1	25	21.38		0
	1	49	21.31		0
	25	0	21.35	0-1	0
	25	12	21.36		0
	25	25	21.35		0
	50	0	21.30		0
16QAM	1	0	21.51	0-1	0
	1	25	21.60		0
	1	49	21.68		0
	25	0	21.37	0-2	0
	25	12	21.36		0
	25	25	21.37		0
	50	0	21.41		0
64QAM	1	0	21.76	0-2	0
	1	25	21.41		0
	1	49	21.42		0
	25	0	20.88	0-3	0
	25	12	20.87		0
	25	25	20.92		0
	50	0	20.88		0

FCC ID: PY7-25682R	SAR EVALUATION REPORT	Approved by: Technical Manager
Document S/N: 1M2302230018-05.PY7 (Rev2)	DUT Type: Portable Handset	Page 37 of 74

9.3.2 LTE Band 13

**Table 9-5
LTE Band 13 Maximum Conducted Powers - 10 MHz Bandwidth**

LTE Band 13 10 MHz Bandwidth					
Modulation	RB Size	RB Offset	Mid Channel	MPR Allowed per 3GPP [dB]	MPR [dB]
			23230 (782.0 MHz)		
			Conducted Power [dBm]		
QPSK	1	0	21.28	0	0
	1	25	21.25		0
	1	49	21.03		0
	25	0	21.12	0-1	0
	25	12	21.17		0
	25	25	21.14		0
	50	0	21.04		0
16QAM	1	0	21.37	0-1	0
	1	25	21.38		0
	1	49	21.31		0
	25	0	21.21	0-2	0
	25	12	21.08		0
	25	25	21.13		0
	50	0	21.08		0
64QAM	1	0	21.32	0-2	0
	1	25	21.32		0
	1	49	21.24		0
	25	0	20.83	0-3	0
	25	12	20.80		0
	25	25	20.85		0
	50	0	20.83		0

FCC ID: PY7-25682R	SAR EVALUATION REPORT	Approved by: Technical Manager
Document S/N: 1M2302230018-05.PY7 (Rev2)	DUT Type: Portable Handset	Page 38 of 74

9.3.3 LTE Band 5

**Table 9-6
LTE Band 5 (Cell) Maximum Conducted Powers - 10 MHz Bandwidth**

LTE Band 5 (Cell) 10 MHz Bandwidth					
Modulation	RB Size	RB Offset	Mid Channel	MPR Allowed per 3GPP [dB]	MPR [dB]
			20525 (836.5 MHz)		
			Conducted Power [dBm]		
QPSK	1	0	21.12	0	0
	1	25	21.26		0
	1	49	21.10		0
	25	0	21.16	0-1	0
	25	12	21.14		0
	25	25	21.18		0
	50	0	21.15		0
16QAM	1	0	21.47	0-1	0
	1	25	21.42		0
	1	49	21.32		0
	25	0	21.18	0-2	0
	25	12	21.16		0
	25	25	21.18		0
	50	0	21.11		0
64QAM	1	0	21.31	0-2	0
	1	25	21.44		0
	1	49	21.24		0
	25	0	21.23	0-3	0
	25	12	21.11		0
	25	25	21.16		0
	50	0	21.13		0

FCC ID: PY7-25682R	SAR EVALUATION REPORT	Approved by: Technical Manager
Document S/N: 1M2302230018-05.PY7 (Rev2)	DUT Type: Portable Handset	Page 39 of 74

9.3.4 LTE Band 66

**Table 9-7
LTE Band 66 (AWS) Maximum Conducted Powers – 20 MHz Bandwidth**

LTE Band 66 (AWS) 20 MHz Bandwidth							
Modulation	RB Size	RB Offset	Low Channel	Mid Channel	High Channel	MPR Allowed per 3GPP [dB]	MPR [dB]
			132072 (1720.0 MHz)	132322 (1745.0 MHz)	132572 (1770.0 MHz)		
			Conducted Power [dBm]				
QPSK	1	0	18.52	18.20	18.16	0	0
	1	50	18.53	18.35	18.14		0
	1	99	18.50	18.20	18.10		0
	50	0	18.22	18.29	18.25	0-1	0
	50	25	18.28	18.28	18.23		0
	50	50	18.33	18.27	18.22		0
100	0	18.30	18.20	18.21	0		
16QAM	1	0	19.00	19.00	18.99	0-1	0
	1	50	18.99	18.98	19.00		0
	1	99	19.00	19.00	18.70		0
	50	0	18.24	18.27	18.30	0-2	0
	50	25	18.22	18.29	18.29		0
	50	50	18.32	18.35	18.30		0
100	0	18.29	18.30	18.27	0		
64QAM	1	0	18.66	18.89	18.64	0-2	0
	1	50	18.92	19.00	18.54		0
	1	99	18.75	18.85	18.56		0
	50	0	18.26	18.31	18.33	0-3	0
	50	25	18.33	18.34	18.30		0
	50	50	18.35	18.30	18.43		0
100	0	18.29	18.40	18.40	0		

9.3.5 LTE Band 25

**Table 9-8
LTE Band 25 (PCS) Maximum Conducted Powers – 20 MHz Bandwidth**

LTE Band 25 (PCS) 20 MHz Bandwidth							
Modulation	RB Size	RB Offset	Low Channel	Mid Channel	High Channel	MPR Allowed per 3GPP [dB]	MPR [dB]
			26140 (1860.0 MHz)	26365 (1882.5 MHz)	26590 (1905.0 MHz)		
			Conducted Power [dBm]				
QPSK	1	0	19.30	19.51	19.34	0	0
	1	50	19.40	19.62	19.43		0
	1	99	19.34	19.65	19.40		0
	50	0	19.42	19.47	19.38	0-1	0
	50	25	19.51	19.48	19.42		0
	50	50	19.53	19.54	19.34		0
100	0	19.52	19.48	19.41	0		
16QAM	1	0	20.00	19.98	19.96	0-1	0
	1	50	20.00	19.92	19.98		0
	1	99	19.89	19.95	20.00		0
	50	0	19.78	19.50	19.65	0-2	0
	50	25	19.94	19.50	19.44		0
	50	50	19.90	19.52	19.30		0
100	0	19.88	19.50	19.42	0		
64QAM	1	0	19.69	19.66	19.61	0-2	0
	1	50	19.76	20.00	19.76		0
	1	99	19.83	19.95	19.54		0
	50	0	19.76	19.49	19.54	0-3	0
	50	25	19.60	19.47	19.64		0
	50	50	19.87	19.52	19.45		0
100	0	19.92	19.48	19.60	0		

FCC ID: PY7-25682R	SAR EVALUATION REPORT	Approved by: Technical Manager
Document S/N: 1M2302230018-05.PY7 (Rev2)	DUT Type: Portable Handset	Page 40 of 74

9.3.6 LTE Band 41

**Table 9-9
LTE Band 41 PC3 Maximum Conducted Powers – 20 MHz Bandwidth**

LTE Band 41 20 MHz Bandwidth									
Modulation	RB Size	RB Offset	Low Channel	Low-Mid Channel	Mid Channel	Mid-High Channel	High Channel	MPR Allowed per 3GPP [dB]	MPR [dB]
			39750 (2506.0 MHz)	40185 (2549.5 MHz)	40620 (2593.0 MHz)	41055 (2636.5 MHz)	41490 (2680.0 MHz)		
Conducted Power [dBm]									
QPSK	1	0	19.41	19.42	19.40	19.25	19.25	0	0
	1	50	19.40	19.41	19.36	19.33	19.11		0
	1	99	19.33	19.36	19.43	19.30	19.15		0
	50	0	19.37	19.30	19.41	19.38	19.17	0-1	0
	50	25	19.40	19.47	19.44	19.37	19.10		0
	50	50	19.43	19.40	19.48	19.39	19.23		0
16QAM	100	0	19.40	19.32	19.40	19.30	19.20	0-1	0
	1	0	19.36	19.30	19.44	19.25	19.15		0
	1	50	19.69	19.45	19.57	19.39	19.10		0
	50	0	19.60	19.43	19.51	19.20	19.23	0-2	0
	50	25	19.38	19.23	19.37	19.40	19.32		0
	50	50	19.43	19.40	19.46	19.35	19.20		0
64QAM	100	0	19.40	19.32	19.45	19.45	19.13	0-2	0
	1	0	19.39	19.20	19.27	19.30	19.10		0
	1	50	19.50	19.43	19.43	19.40	19.32		0
	50	0	19.43	19.33	19.22	19.39	19.21	0-3	0
	50	25	19.32	19.32	19.31	19.33	19.31		0
	50	50	19.40	19.45	19.30	19.45	19.20		0
100	0	19.32	19.30	19.26	19.44	19.03	0-3	0	
100	0	19.21	19.20	19.20	19.23	19.10		0	



**Figure 9-3
Power Measurement Setup**

FCC ID: PY7-25682R	SAR EVALUATION REPORT	Approved by: Technical Manager
Document S/N: 1M2302230018-05.PY7 (Rev2)	DUT Type: Portable Handset	Page 41 of 74

9.4 WLAN Conducted Powers

**Table 9-10
2.4 GHz WLAN Maximum Average RF Power – MIMO**

2.4GHz 802.11n Conducted Power [dBm]				
Freq [MHz]	Channel	WiFi Main	WiFi Sub	MIMO
2412	1	13.35	13.76	16.57
2437	6	13.74	13.57	16.67
2462	11	13.44	13.67	16.57

**Table 9-11
5 GHz WLAN Maximum Average RF Power – MIMO**

5GHz (40MHz) 802.11n Conducted Power [dBm]				
Freq [MHz]	Channel	WiFi Main	WiFi Sub	MIMO
5190	38	11.46	9.85	13.74
5230	46	11.38	9.83	13.68
5270	54	11.44	9.81	13.71
5310	62	11.12	9.79	13.52
5510	102	11.47	9.62	13.65
5590	118	11.36	9.54	13.55
5630	126	11.39	9.48	13.55
5710	142	11.42	10.39	13.95
5755	151	11.33	9.62	13.57
5795	159	11.49	9.51	13.62
5GHz (80MHz) 802.11ac Conducted Power [dBm]				
Freq [MHz]	Channel	WiFi Main	WiFi Sub	MIMO
5210	42	11.32	9.52	13.52
5290	58	11.34	9.72	13.62
5530	106	11.27	9.65	13.55
5610	122	11.39	9.39	13.51
5690	138	11.42	9.85	13.72
5775	155	10.41	8.91	12.73

Justification for test configurations for WLAN per KDB Publication 248227 D01v02r02:

- Power measurements were performed for the transmission mode configuration with the highest maximum output power specified for production units.
- For transmission modes with the same maximum output power specification, powers were measured for the largest channel bandwidth, lowest order modulation and lowest data rate.
- For transmission modes with identical maximum specified output power, channel bandwidth, modulation and data rates, power measurements were required for all identical configurations.
- For each transmission mode configuration, powers were measured for the highest and lowest channels; and at the mid-band channel(s) when there were at least 3 channels supported. For configurations with multiple mid-band channels, due to an even number of channels, both channels were measured.

FCC ID: PY7-25682R	SAR EVALUATION REPORT	Approved by: Technical Manager
Document S/N: 1M2302230018-05.PY7 (Rev2)	DUT Type: Portable Handset	Page 42 of 74

REV 22.0
03/30/2022

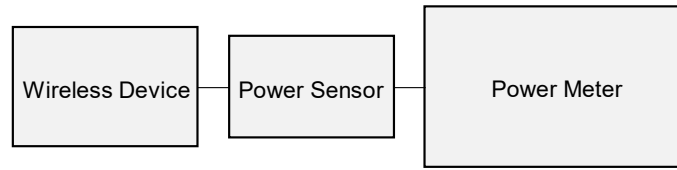

Figure 9-4
Power Measurement Setup

9.5 Bluetooth Conducted Powers

Table 9-12
Bluetooth Maximum Average RF Power– WiFi Main

Frequency [MHz]	Data Rate [Mbps]	Mod.	Channel No.	Avg Conducted Power	
				[dBm]	[mW]
2402	1.0	GFSK	0	13.39	21.802
2441	1.0	GFSK	39	13.41	21.903
2480	1.0	GFSK	78	13.64	23.115

Table 9-13
Bluetooth Maximum Average RF Power– WiFi Sub

Frequency [MHz]	Data Rate [Mbps]	Mod.	Channel No.	Avg Conducted Power	
				[dBm]	[mW]
2402	1.0	GFSK	0	13.18	20.792
2441	1.0	GFSK	39	13.57	22.772
2480	1.0	GFSK	78	13.82	24.094

FCC ID: PY7-25682R	SAR EVALUATION REPORT	Approved by: Technical Manager
Document S/N: 1M2302230018-05.PY7 (Rev2)	DUT Type: Portable Handset	Page 43 of 74

**Figure 9-5
Bluetooth Main Transmission Plot**

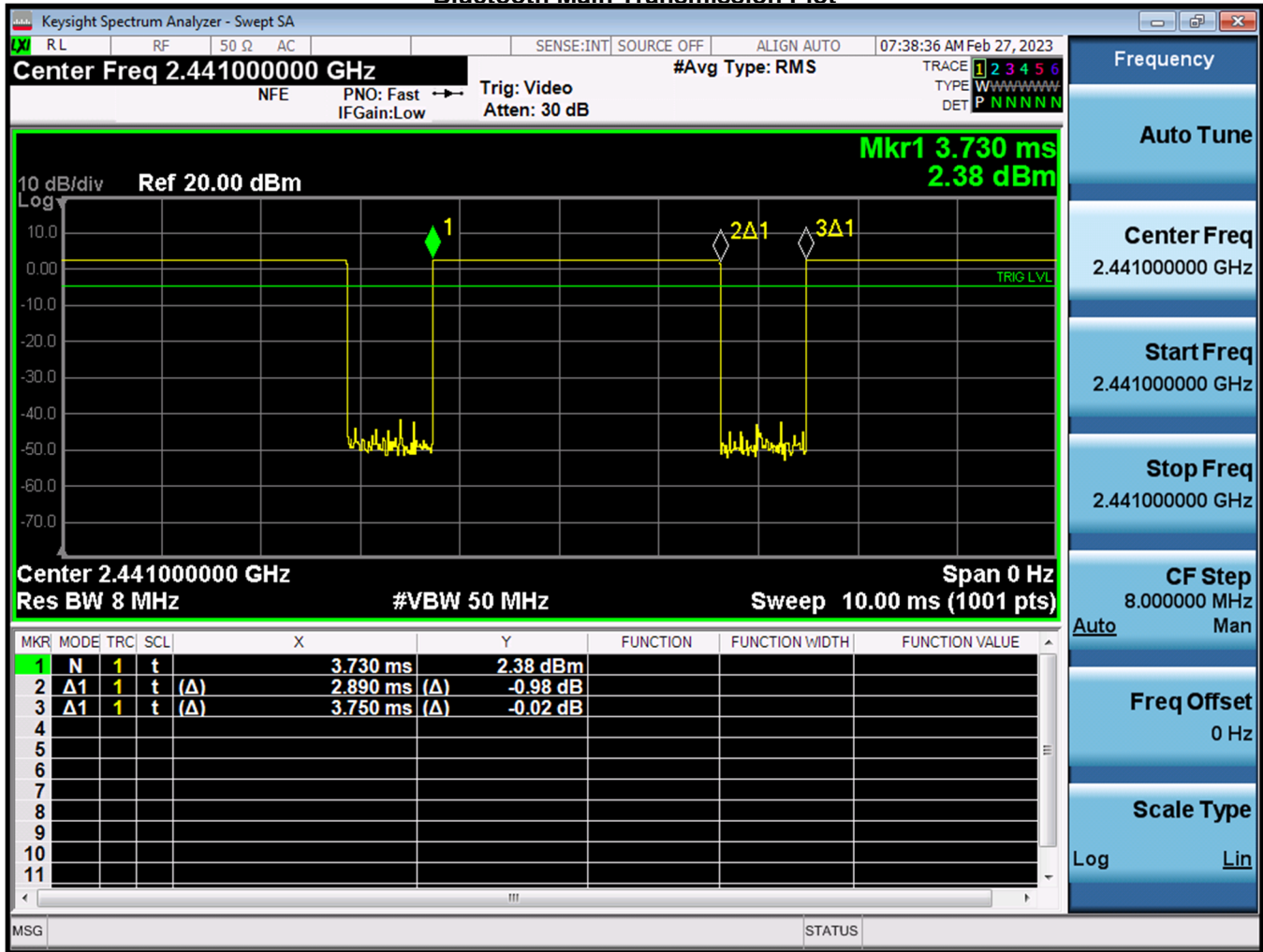

**Equation 9-1
Bluetooth WiFi Main Duty Cycle Calculation**

$$Duty\ Cycle = \frac{Pulse\ Width}{Period} * 100\% = \frac{2.890ms}{3.750ms} * 100\% = 77.07\%$$

FCC ID: PY7-25682R	SAR EVALUATION REPORT	Approved by: Technical Manager
Document S/N: 1M2302230018-05.PY7 (Rev2)	DUT Type: Portable Handset	Page 44 of 74

Figure 9-6
Bluetooth Sub Transmission Plot

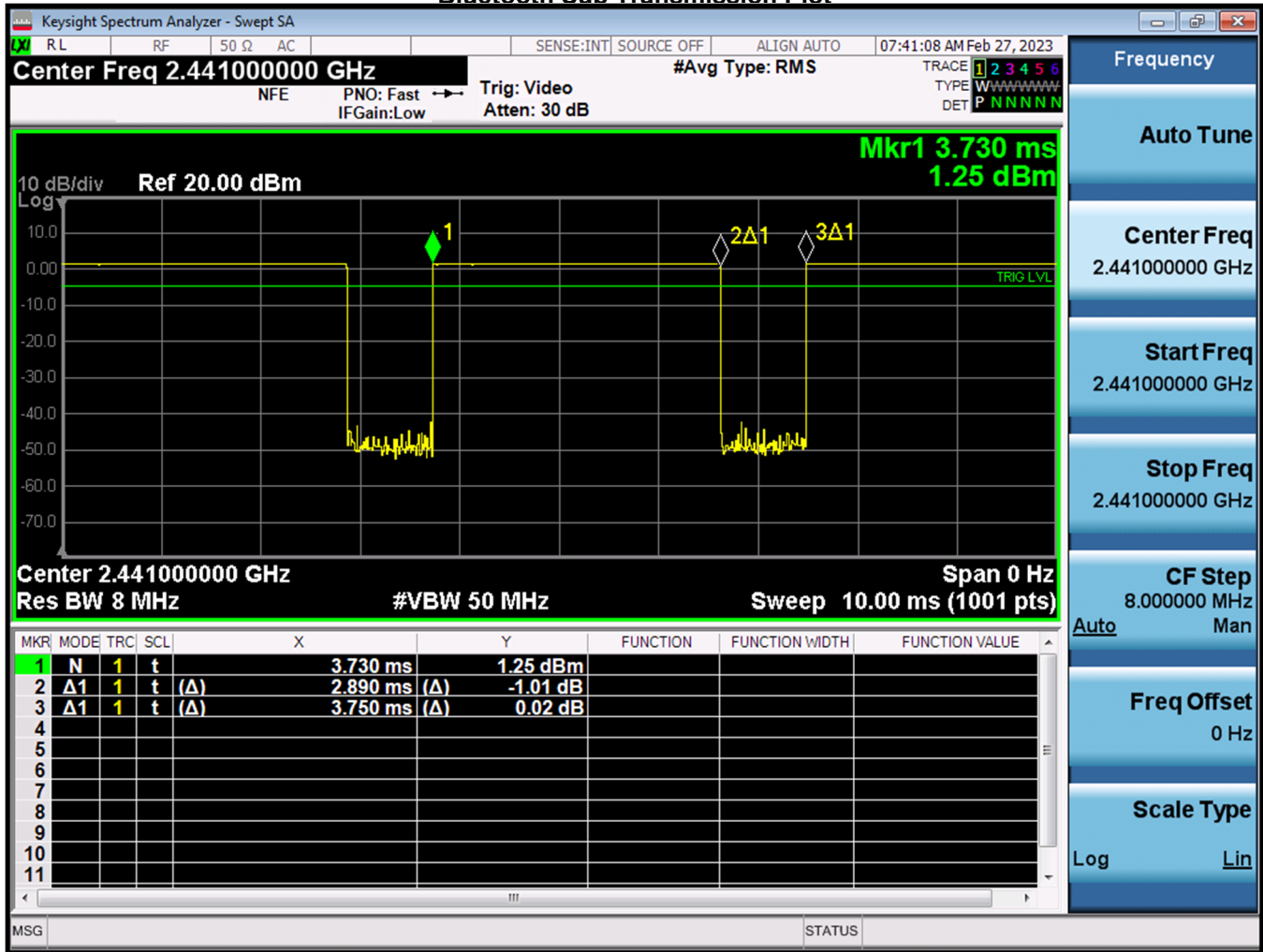

Equation 9-2
Bluetooth WiFi Sub Duty Cycle Calculation

$$Duty\ Cycle = \frac{Pulse\ Width}{Period} * 100\% = \frac{2.890ms}{3.750ms} * 100\% = 77.07\%$$

FCC ID: PY7-25682R	SAR EVALUATION REPORT	Approved by: Technical Manager
Document S/N: 1M2302230018-05.PY7 (Rev2)	DUT Type: Portable Handset	Page 45 of 74

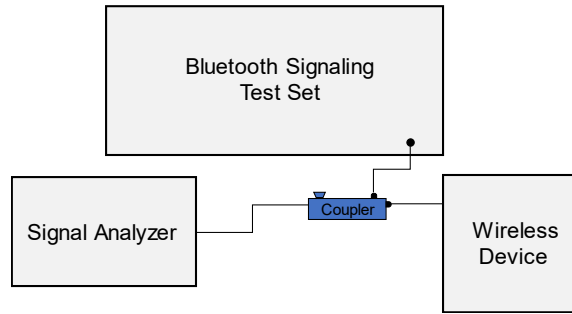

Figure 9-7
Power Measurement Setup

FCC ID: PY7-25682R	SAR EVALUATION REPORT	Approved by: Technical Manager
Document S/N: 1M2302230018-05.PY7 (Rev2)	DUT Type: Portable Handset	Page 46 of 74

10 SYSTEM VERIFICATION

10.1 Tissue Verification

**Table 10-1
Measured Head Tissue Properties**

Calibrated for Tests Performed on	Tissue Type	Tissue Temp During Calibration (°C)	Measured Frequency (MHz)	Measured Conductivity, σ (S/m)	Measured Dielectric Constant, ϵ	TARGET Conductivity, σ (S/m)	TARGET Dielectric Constant, ϵ	% dev σ	% dev ϵ
02/26/2023	30 Head	22.1	12	0.745	55.851	0.750	55.000	-0.67%	1.55%
			13	0.745	55.517	0.750	55.000	-0.67%	0.94%
			14	0.745	55.470	0.750	55.000	-0.67%	0.87%
			680	0.860	42.844	0.888	42.305	-4.79%	1.27%
			695	0.850	42.850	0.889	42.227	-4.34%	1.57%
			700	0.860	42.888	0.888	42.201	-4.20%	1.63%
			710	0.854	42.852	0.890	42.189	-4.63%	1.67%
			725	0.856	42.725	0.891	42.071	-3.76%	1.56%
			750	0.864	42.515	0.894	41.942	-3.46%	1.37%
			770	0.870	42.470	0.895	41.938	-2.48%	1.52%
			785	0.881	42.507	0.895	41.760	-1.73%	1.79%
			800	0.897	42.533	0.897	41.682	-1.15%	2.04%
			815	0.914	40.877	0.898	41.594	1.35%	-1.48%
			820	0.916	40.955	0.899	41.578	1.89%	-1.50%
835	0.921	40.896	0.900	41.500	2.33%	-1.48%			
850	0.927	40.854	0.916	41.500	1.20%	-1.56%			
815	0.930	40.729	0.899	41.094	0.95%	-2.08%			
820	0.905	40.709	0.899	41.578	0.67%	-2.09%			
835	0.911	40.642	0.900	41.500	1.22%	-2.07%			
850	0.917	40.576	0.916	41.500	0.11%	-2.22%			
815	0.966	41.750	0.898	41.584	-1.11%	0.38%			
820	0.966	41.737	0.899	41.678	-1.02%	0.38%			
835	0.965	41.690	0.900	41.500	-0.89%	0.46%			
850	0.960	41.626	0.916	41.000	-1.78%	0.52%			
02/22/2023	1750 Head	20.7	1710	1.335	39.500	1.345	40.142	-0.68%	-1.60%
			1720	1.340	39.480	1.354	40.128	-1.03%	-1.61%
			1745	1.361	39.456	1.368	40.087	-1.10%	-1.57%
			1750	1.365	39.451	1.371	40.078	-1.09%	-1.57%
			1770	1.367	39.446	1.383	40.047	-1.16%	-1.52%
			1790	1.370	39.442	1.394	40.016	-1.08%	-1.47%
			1710	1.338	39.160	1.348	40.142	-0.74%	-2.46%
			1720	1.344	39.145	1.354	40.128	-0.74%	-2.44%
			1745	1.359	39.093	1.368	40.087	-0.66%	-2.48%
			1750	1.361	39.088	1.371	40.079	-0.72%	-2.49%
			1770	1.375	39.043	1.383	40.047	-0.58%	-2.51%
			1790	1.367	39.022	1.394	40.016	-0.60%	-2.48%
			1850	1.388	39.262	1.400	40.000	-1.02%	-1.82%
			1880	1.391	39.261	1.400	40.000	-0.64%	-1.82%
1880	1.403	39.251	1.400	40.000	0.21%	-1.88%			
1900	1.410	39.196	1.400	40.000	1.07%	-2.01%			
1945	1.416	39.176	1.400	40.000	1.36%	-2.02%			
1950	1.422	39.186	1.400	40.000	1.57%	-2.04%			
1950	1.414	40.457	1.400	40.000	1.02%	1.24%			
1850	1.410	40.488	1.400	40.000	1.29%	1.22%			
1880	1.428	40.453	1.400	40.000	1.11%	1.11%			
1900	1.434	40.407	1.400	40.000	2.43%	1.02%			
1905	1.438	40.399	1.400	40.000	2.71%	1.00%			
1910	1.441	40.396	1.400	40.000	3.07%	0.98%			
2300	1.749	41.092	1.670	39.500	4.73%	4.05%			
2310	1.759	41.078	1.679	39.480	4.71%	4.05%			
2320	1.768	41.063	1.687	39.460	4.68%	4.06%			
2400	1.831	40.912	1.756	39.289	4.27%	4.15%			
2450	1.876	40.833	1.800	39.200	4.22%	4.17%			
2480	1.886	40.778	1.833	39.162	3.44%	4.13%			
2500	1.911	40.726	1.856	39.138	3.02%	4.08%			
2510	1.920	40.714	1.866	39.123	2.89%	4.07%			
2535	1.946	40.676	1.883	39.092	2.80%	4.05%			
2550	1.960	40.654	1.909	39.073	2.67%	4.05%			
2560	1.968	40.640	1.920	39.060	2.60%	4.05%			
2600	1.997	40.572	1.964	39.009	1.68%	4.01%			
2650	2.048	40.496	2.018	38.945	1.49%	3.96%			
2680	2.077	40.443	2.051	38.907	1.07%	3.93%			
2700	2.089	40.394	2.073	38.882	0.77%	3.89%			
2300	1.744	39.514	1.670	39.500	4.43%	0.04%			
2310	1.751	39.500	1.679	39.480	4.23%	0.05%			
2320	1.759	39.477	1.687	39.460	4.15%	0.04%			
2400	1.819	39.348	1.756	39.289	3.58%	0.18%			
2450	1.859	39.242	1.800	39.200	3.22%	0.17%			
2480	1.885	39.201	1.833	39.162	2.73%	0.16%			
2500	1.897	39.193	1.855	39.138	2.58%	0.15%			
2510	1.905	39.186	1.866	39.123	2.69%	0.16%			
2535	1.925	39.131	1.893	39.092	1.69%	0.10%			
2550	1.938	39.091	1.909	39.073	1.62%	0.09%			
2560	1.948	39.067	1.920	39.060	1.46%	0.05%			
2600	1.980	39.027	1.964	39.009	0.81%	0.05%			
2650	2.026	39.021	2.018	38.945	0.10%	-0.60%			
2680	2.048	38.964	2.051	38.907	-0.15%	-0.71%			
2700	2.063	38.856	2.073	38.882	-0.48%	-0.07%			
5180	4.533	34.903	4.635	36.009	-2.20%	-3.07%			
5190	4.541	34.874	4.645	35.988	-2.11%	-3.12%			
5200	4.559	34.857	4.655	35.966	-2.06%	-3.14%			
5210	4.571	34.846	4.668	35.975	-2.04%	-3.14%			
5220	4.586	34.830	4.676	35.983	-2.01%	-3.16%			
5240	4.605	34.796	4.696	35.940	-1.94%	-3.18%			
5250	4.616	34.774	4.706	35.929	-1.91%	-3.21%			
5260	4.631	34.752	4.717	35.917	-1.82%	-3.24%			
5270	4.646	34.729	4.727	35.906	-1.69%	-3.28%			
5280	4.665	34.720	4.737	35.894	-1.52%	-3.27%			
5290	4.678	34.717	4.748	35.883	-1.47%	-3.25%			
5300	4.688	34.708	4.758	35.871	-1.57%	-3.24%			
5310	4.695	34.696	4.768	35.860	-1.53%	-3.25%			
5320	4.708	34.681	4.778	35.849	-1.47%	-3.26%			
5500	4.895	34.349	4.983	35.643	-1.31%	-3.67%			
5510	4.913	34.338	4.973	35.632	-1.27%	-3.62%			
5520	4.928	34.320	4.983	35.620	-1.14%	-3.66%			
5530	4.938	34.298	4.994	35.609	-1.16%	-3.68%			
5540	4.948	34.273	5.004	35.597	-1.19%	-3.72%			
5550	4.955	34.251	5.014	35.586	-1.18%	-3.75%			
5560	4.965	34.233	5.024	35.574	-1.17%	-3.77%			
5580	4.991	34.190	5.045	35.551	-1.07%	-3.82%			
5600	5.017	34.151	5.065	35.529	-0.95%	-3.88%			
5610	5.033	34.138	5.076	35.518	-0.88%	-3.88%			
5620	5.050	34.121	5.088	35.506	-0.71%	-3.92%			
5640	5.078	34.087	5.106	35.483	-0.59%	-3.93%			
5660	5.097	34.058	5.127	35.460	-0.59%	-3.95%			
5670	5.108	34.038	5.137	35.449	-0.66%	-3.88%			
5680	5.121	34.016	5.147	35.437	-0.91%	-4.07%			
5690	5.138	34.000	5.158	35.428	-0.83%	-4.02%			
5700	5.151	33.987	5.168	35.414	-0.33%	-4.02%			
5710	5.164	33.972	5.178	35.403	-0.27%	-4.04%			
5720	5.178	33.966	5.188	35.391	-0.23%	-4.05%			
5745	5.198	33.931	5.214	35.363	-0.36%	-4.05%			
5790	5.200	33.926	5.219	35.357	-0.38%	-4.08%			
5795	5.204	33.922	5.224	35.351	-0.38%	-4.08%			
5785	5.241	33.911	5.265	35.340	-0.38%	-4.07%			
5775	5.228	33.887	5.245	35.328	-0.36%	-4.14%			
5785	5.237	33.854	5.255	35.317	-0.34%	-4.22%			
5795	5.241	33.811	5.265	35.305	-0.36%	-4.23%			
5800	5.252	33.800	5.270	35.300	-0.34%	-4.25%			

FCC ID: PY7-25682R	SAR EVALUATION REPORT	Approved by: Technical Manager
Document S/N: 1M2302230018-05.PY7 (Rev2)	DUT Type: Portable Handset	Page 47 of 74

**Table 10-2
Measured Body Tissue Properties**

Calibrated for Tests Performed on:	Tissue Type	Tissue Temp During Calibration (°C)	Measured Frequency (MHz)	Measured Conductivity, σ (S/m)	Measured Dielectric Constant, ϵ	TARGET Conductivity, σ (S/m)	TARGET Dielectric Constant, ϵ	% dev σ	% dev ϵ
03/09/2023	750 Body	20.6	680	0.922	55.030	0.958	55.804	-3.76%	-1.39%
			695	0.928	54.959	0.959	55.745	-3.23%	-1.41%
			700	0.931	54.938	0.959	55.726	-2.92%	-1.41%
			710	0.935	54.908	0.960	55.687	-2.60%	-1.40%
			725	0.941	54.885	0.961	55.629	-2.08%	-1.34%
			750	0.950	54.856	0.964	55.531	-1.45%	-1.22%
			770	0.956	54.812	0.965	55.453	-0.93%	-1.16%
			785	0.961	54.751	0.966	55.395	-0.52%	-1.16%
			800	0.968	54.679	0.967	55.336	0.10%	-1.19%
			815	0.934	54.996	0.968	55.271	-3.51%	-0.50%
03/14/2023	835 Body	19.8	820	0.936	54.974	0.969	55.258	-3.41%	-0.51%
			835	0.942	54.914	0.970	55.200	-2.89%	-0.52%
			850	0.948	54.867	0.988	55.154	-4.05%	-0.52%
			815	0.937	53.287	0.968	55.271	-3.20%	-3.59%
02/24/2023	835 Body	19.0	820	0.942	53.234	0.969	55.258	-2.79%	-3.66%
			835	0.958	53.061	0.970	55.200	-1.24%	-3.88%
			850	0.973	52.883	0.988	55.154	-1.52%	-4.12%
02/27/2023	835 Body	19.5	815	0.937	55.809	0.968	55.271	-3.20%	0.97%
			820	0.940	55.798	0.969	55.258	-2.99%	0.98%
			835	0.947	55.765	0.970	55.200	-2.37%	1.02%
			850	0.954	55.738	0.988	55.154	-3.44%	1.06%
02/23/2023	1750 Body	21.0	1710	1.474	51.790	1.463	53.537	0.75%	-3.26%
			1720	1.484	51.748	1.469	53.511	1.02%	-3.29%
			1745	1.512	51.634	1.485	53.445	1.82%	-3.39%
			1750	1.518	51.608	1.488	53.432	2.02%	-3.41%
			1770	1.542	51.522	1.501	53.379	2.73%	-3.48%
			1790	1.566	51.459	1.514	53.326	3.43%	-3.50%
03/14/2023	1750 Body	19.8	1710	1.433	53.420	1.463	53.537	-2.05%	-0.22%
			1720	1.440	53.394	1.469	53.511	-1.97%	-0.22%
			1745	1.458	53.331	1.485	53.445	-1.82%	-0.21%
			1750	1.462	53.321	1.488	53.432	-1.75%	-0.21%
			1770	1.474	53.292	1.501	53.379	-1.80%	-0.16%
02/21/2023	1900 Body	20.0	1790	1.487	53.270	1.514	53.326	-1.78%	-0.11%
			1850	1.541	51.613	1.520	53.300	1.38%	-3.17%
			1860	1.549	51.613	1.520	53.300	1.91%	-3.17%
			1880	1.560	51.572	1.520	53.300	2.63%	-3.24%
			1900	1.578	51.459	1.520	53.300	3.82%	-3.45%
			1905	1.585	51.425	1.520	53.300	4.28%	-3.52%
02/23/2023	1900 Body	22.4	1910	1.592	51.393	1.520	53.300	4.74%	-3.58%
			1850	1.497	52.918	1.520	53.300	-1.51%	-0.72%
			1860	1.509	52.877	1.520	53.300	-0.72%	-0.79%
			1880	1.535	52.797	1.520	53.300	0.99%	-0.94%
			1900	1.560	52.743	1.520	53.300	2.63%	-1.05%
03/15/2023	1900 Body	19.9	1905	1.567	52.732	1.520	53.300	3.09%	-1.07%
			1910	1.572	52.723	1.520	53.300	3.42%	-1.08%
			1850	1.474	52.271	1.520	53.300	-3.03%	-1.93%
			1860	1.482	52.253	1.520	53.300	-2.50%	-1.96%
			1880	1.497	52.219	1.520	53.300	-1.51%	-2.03%
			1900	1.512	52.201	1.520	53.300	-0.53%	-2.06%
02/28/2023	2450 Body	19.0	1905	1.516	52.197	1.520	53.300	-0.26%	-2.07%
			1910	1.519	52.192	1.520	53.300	-0.07%	-2.08%
			1920	1.526	52.181	1.520	53.300	0.39%	-2.10%
			2300	1.783	53.634	1.809	52.900	-1.44%	1.39%
			2310	1.792	53.618	1.816	52.887	-1.32%	1.38%
			2320	1.801	53.600	1.826	52.873	-1.37%	1.37%
			2400	1.877	53.481	1.902	52.767	-1.31%	1.35%
			2450	1.925	53.392	1.950	52.700	-1.28%	1.31%
			2480	1.957	53.359	1.993	52.662	-1.81%	1.32%
			2500	1.977	53.334	2.021	52.636	-2.18%	1.33%
			2510	1.987	53.317	2.035	52.623	-2.36%	1.32%
			2535	2.012	53.259	2.071	52.592	-2.85%	1.27%
			2550	2.028	53.224	2.092	52.573	-3.06%	1.24%
			2560	2.038	53.210	2.106	52.560	-3.23%	1.24%
2600	2.082	53.158	2.163	52.509	-3.74%	1.24%			
2650	2.132	53.052	2.234	52.445	-4.57%	1.16%			
2680	2.167	52.996	2.277	52.407	-4.83%	1.12%			

FCC ID: PY7-25682R	SAR EVALUATION REPORT	Approved by: Technical Manager
Document S/N: 1M2302230018-05.PY7 (Rev2)	DUT Type: Portable Handset	Page 48 of 74

**Table 10-3
Measured Body Tissue Properties (cont.)**

Calibrated for Tests Performed on:	Tissue Type	Tissue Temp During Calibration (°C)	Measured Frequency (MHz)	Measured Conductivity, σ (S/m)	Measured Dielectric Constant, ϵ	TARGET Conductivity, σ (S/m)	TARGET Dielectric Constant, ϵ	% dev σ	% dev ϵ
02/28/2023	5200-5800 Body	21.9	5180	5.092	48.702	5.276	49.041	-3.49%	-0.69%
			5190	5.107	48.663	5.288	49.028	-3.42%	-0.74%
			5200	5.123	48.639	5.299	49.014	-3.32%	-0.77%
			5210	5.138	48.638	5.311	49.001	-3.26%	-0.74%
			5220	5.155	48.630	5.323	48.987	-3.16%	-0.73%
			5240	5.183	48.582	5.346	48.960	-3.05%	-0.77%
			5250	5.194	48.566	5.358	48.947	-3.06%	-0.78%
			5260	5.204	48.553	5.369	48.933	-3.07%	-0.78%
			5270	5.219	48.529	5.381	48.919	-3.01%	-0.80%
			5280	5.237	48.507	5.393	48.906	-2.89%	-0.82%
			5290	5.255	48.494	5.404	48.892	-2.76%	-0.81%
			5300	5.271	48.480	5.416	48.879	-2.68%	-0.82%
			5310	5.284	48.464	5.428	48.865	-2.65%	-0.82%
			5320	5.299	48.440	5.439	48.851	-2.57%	-0.84%
			5500	5.533	48.102	5.650	48.607	-2.07%	-1.04%
			5510	5.546	48.077	5.661	48.594	-2.03%	-1.06%
			5520	5.561	48.054	5.673	48.580	-1.97%	-1.08%
			5530	5.580	48.030	5.685	48.566	-1.85%	-1.10%
			5540	5.601	48.011	5.696	48.553	-1.67%	-1.12%
			5550	5.617	47.986	5.708	48.539	-1.59%	-1.14%
			5560	5.629	47.975	5.720	48.526	-1.59%	-1.14%
			5580	5.655	47.951	5.743	48.499	-1.53%	-1.13%
			5600	5.687	47.903	5.766	48.471	-1.37%	-1.17%
			5610	5.700	47.885	5.778	48.458	-1.35%	-1.18%
			5620	5.716	47.861	5.790	48.444	-1.28%	-1.20%
			5640	5.753	47.830	5.813	48.417	-1.03%	-1.21%
			5660	5.780	47.811	5.837	48.390	-0.98%	-1.20%
			5670	5.793	47.797	5.848	48.376	-0.94%	-1.20%
			5680	5.808	47.777	5.860	48.363	-0.89%	-1.21%
			5690	5.824	47.762	5.872	48.349	-0.82%	-1.21%
			5700	5.840	47.745	5.883	48.336	-0.73%	-1.22%
			5710	5.854	47.738	5.895	48.322	-0.70%	-1.21%
			5720	5.867	47.721	5.907	48.309	-0.66%	-1.22%
			5745	5.905	47.685	5.936	48.275	-0.52%	-1.26%
			5750	5.909	47.657	5.942	48.268	-0.56%	-1.27%
			5755	5.916	47.646	5.947	48.261	-0.52%	-1.27%
			5765	5.928	47.629	5.959	48.248	-0.52%	-1.28%
			5775	5.942	47.606	5.971	48.234	-0.49%	-1.30%
			5785	5.957	47.584	5.982	48.220	-0.42%	-1.32%
			5795	5.972	47.561	5.994	48.207	-0.37%	-1.34%
			5800	5.980	47.547	6.000	48.200	-0.33%	-1.35%
			5180	5.072	47.594	5.276	49.041	-3.87%	-2.98%
			5190	5.087	47.573	5.288	49.028	-3.80%	-2.97%
			5200	5.102	47.552	5.299	49.014	-3.72%	-2.98%
			5210	5.120	47.533	5.311	49.001	-3.60%	-3.00%
			5220	5.132	47.514	5.323	48.987	-3.59%	-3.01%
			5240	5.155	47.467	5.346	48.960	-3.57%	-3.05%
			5250	5.168	47.447	5.358	48.947	-3.55%	-3.06%
5260	5.187	47.426	5.369	48.933	-3.39%	-3.08%			
5270	5.204	47.413	5.381	48.919	-3.29%	-3.08%			
5280	5.218	47.398	5.393	48.906	-3.24%	-3.08%			
5290	5.231	47.376	5.404	48.892	-3.20%	-3.10%			
5300	5.243	47.356	5.416	48.879	-3.19%	-3.12%			
5310	5.257	47.340	5.428	48.865	-3.15%	-3.12%			
5320	5.275	47.335	5.439	48.851	-3.02%	-3.10%			
5500	5.516	46.982	5.650	48.607	-2.37%	-3.34%			
5510	5.528	46.968	5.661	48.594	-2.35%	-3.35%			
5520	5.543	46.952	5.673	48.580	-2.29%	-3.35%			
5530	5.559	46.932	5.685	48.566	-2.22%	-3.36%			
5540	5.579	46.907	5.696	48.553	-2.05%	-3.39%			
5550	5.594	46.880	5.708	48.539	-2.00%	-3.42%			
5560	5.607	46.855	5.720	48.526	-1.98%	-3.44%			
5580	5.631	46.811	5.743	48.499	-1.95%	-3.48%			
5600	5.663	46.778	5.766	48.471	-1.79%	-3.49%			
5610	5.681	46.760	5.778	48.458	-1.68%	-3.50%			
5620	5.699	46.736	5.790	48.444	-1.57%	-3.53%			
5640	5.726	46.703	5.813	48.417	-1.50%	-3.54%			
5660	5.751	46.675	5.837	48.390	-1.47%	-3.54%			
5670	5.766	46.648	5.848	48.376	-1.40%	-3.57%			
5680	5.780	46.627	5.860	48.363	-1.37%	-3.59%			
5690	5.795	46.602	5.872	48.349	-1.31%	-3.61%			
5700	5.812	46.583	5.883	48.336	-1.21%	-3.63%			
5710	5.828	46.563	5.895	48.322	-1.14%	-3.64%			
5720	5.845	46.542	5.907	48.309	-1.05%	-3.66%			
5745	5.880	46.502	5.936	48.275	-0.94%	-3.67%			
5750	5.886	46.497	5.942	48.268	-0.94%	-3.67%			
5755	5.892	46.490	5.947	48.261	-0.92%	-3.67%			
5765	5.904	46.465	5.959	48.248	-0.92%	-3.70%			
5775	5.917	46.450	5.971	48.234	-0.90%	-3.70%			
5785	5.933	46.435	5.982	48.220	-0.82%	-3.70%			
5795	5.953	46.416	5.994	48.207	-0.68%	-3.72%			
5800	5.962	46.403	6.000	48.200	-0.63%	-3.73%			

The above measured tissue parameters were used in the DASY software. The DASY software was used to perform interpolation to determine the dielectric parameters at the SAR test device frequencies (per KDB Publication 865664 D01v01r04 and IEEE 1528-2013 6.6.1.2). The tissue parameters listed in the SAR test plots may slightly differ from the table above due to significant digit rounding in the software.

FCC ID: PY7-25682R	SAR EVALUATION REPORT	Approved by: Technical Manager
Document S/N: 1M2302230018-05.PY7 (Rev2)	DUT Type: Portable Handset	Page 49 of 74

10.2 Test System Verification

Prior to SAR assessment, the system is verified to $\pm 10\%$ of the SAR measurement on the reference dipole at the time of calibration by the calibration facility. Full system validation status and result summary can be found in SAR System Validation Appendix.

**Table 10-3
System Verification Results**

System Verification TARGET & MEASURED																	
SAR System	Tissue Frequency (MHz)	Tissue Type	Date	Amb. Temp. (C)	Liquid Temp. (C)	Input Power (W)	Source SN	Probe SN	DAE	Measured SAR 1g (W/kg)	1W Target SAR 1g (W/kg)	1W Normalized SAR 1g (W/kg)	Deviation 1g (%)	Measured SAR 10g (W/kg)	1W Target SAR 10g (W/kg)	1W Normalized SAR 10g (W/kg)	Deviation 10g (%)
G	13	HEAD	02/28/2023	23.2	21.1	1.00	1002	7417	665	0.503	0.557	0.503	-9.69%	0.313	0.346	0.313	-9.54%
P	750	HEAD	02/27/2023	21.7	19.7	0.20	1161	7409	1334	1.650	8.440	8.250	-2.25%	1.100	5.510	5.500	-0.18%
AM4	835	HEAD	02/23/2023	20.6	20.0	0.20	4d040	7490	1644	2.040	9.790	10.200	4.19%	1.330	6.380	6.650	4.23%
C	835	HEAD	02/27/2023	23.1	21.2	0.20	4d133	7406	1677	1.900	9.760	9.500	-2.66%	1.230	6.370	6.150	-3.45%
P	835	HEAD	03/01/2023	25.0	21.0	0.20	4d132	7409	1334	2.100	9.660	10.500	8.70%	1.370	6.270	6.850	9.25%
AM5	1750	HEAD	02/22/2023	21.1	19.7	0.10	1104	7639	1646	3.550	35.700	35.500	-0.56%	1.850	18.800	18.500	-1.60%
AM4	1750	HEAD	02/23/2023	20.6	20.0	0.10	1104	7490	1644	3.490	35.700	34.900	-2.24%	1.860	18.800	18.600	-1.06%
P	1900	HEAD	02/23/2023	22.3	21.0	0.10	5d148	7409	1334	4.240	40.100	42.400	5.74%	2.210	21.000	22.100	5.24%
P	1900	HEAD	02/27/2023	21.7	19.7	0.10	5d149	7409	1334	4.120	40.500	41.200	1.73%	2.150	21.200	21.500	1.42%
AM1	2450	HEAD	02/27/2023	21.2	20.8	0.10	750	7420	1333	5.400	52.600	54.000	2.66%	2.500	24.500	25.000	2.04%
C	2450	HEAD	02/28/2023	21.5	21.5	0.10	981	7406	1677	5.290	53.900	52.900	-1.86%	2.440	25.400	24.400	-3.94%
AM1	2600	HEAD	02/27/2023	21.2	20.8	0.10	1042	7420	1333	5.630	55.800	56.300	0.90%	2.510	24.900	25.100	0.80%
O	5250	HEAD	03/12/2023	19.1	19.0	0.05	1057	7570	1558	3.860	81.200	77.200	-4.93%	1.120	23.200	22.400	-3.45%
O	5600	HEAD	03/12/2023	19.1	19.0	0.05	1057	7570	1558	4.190	84.200	83.800	-0.48%	1.200	23.900	24.000	0.42%
O	5750	HEAD	03/12/2023	19.1	19.0	0.05	1057	7570	1558	3.990	80.800	79.800	-1.24%	1.130	22.900	22.600	-1.31%
O	750	BODY	03/09/2023	20.7	19.6	0.20	1161	7570	1558	1.750	8.790	8.750	-0.46%	1.160	5.840	5.800	-0.68%
AM4	835	BODY	02/23/2023	20.9	20.1	0.20	460	7490	1644	1.950	9.790	9.750	-0.41%	1.290	6.460	6.450	-0.15%
C	835	BODY	02/27/2023	21.5	21.5	0.20	4d133	7406	1677	1.950	9.690	9.750	0.62%	1.280	6.360	6.400	0.63%
C	835	BODY	03/14/2023	22.9	19.7	0.20	4d132	7406	1677	1.860	9.810	9.300	-5.20%	1.220	6.440	6.100	-5.28%
AM5	1750	BODY	02/23/2023	21.7	19.9	0.10	1104	7639	1646	3.650	36.300	36.500	0.55%	1.910	19.300	19.100	-1.04%
C	1750	BODY	03/14/2023	21.7	19.7	0.10	1008	7406	1677	3.820	37.800	38.200	1.06%	2.090	19.900	20.300	2.01%
P	1900	BODY	02/21/2023	22.5	20.4	0.10	5d148	7409	1334	4.010	39.900	40.100	0.50%	2.070	20.900	20.700	-0.96%
P	1900	BODY	02/23/2023	23.2	20.4	0.10	5d148	7409	1334	4.290	39.900	42.900	7.52%	2.220	20.900	22.200	6.22%
AM5	1900	BODY	03/15/2023	21.8	19.4	0.10	5d181	7639	1646	4.040	39.700	40.400	1.76%	2.100	21.000	21.000	0.00%
AM1	2450	BODY	02/28/2023	20.4	19.6	0.10	921	7420	1333	5.100	49.700	51.000	2.62%	2.390	23.600	23.900	1.27%
AM1	2600	BODY	02/28/2023	20.4	19.6	0.10	1068	7420	1333	5.480	53.900	54.800	1.67%	2.480	24.100	24.800	2.90%
K	5250	BODY	02/28/2023	22.3	21.9	0.05	1191	7659	1407	3.540	74.600	70.800	-5.09%	1.010	20.700	20.200	-2.42%
K	5250	BODY	03/06/2023	23.0	21.3	0.05	1057	7659	1407	3.460	74.200	69.200	-6.74%	0.992	20.600	19.840	-3.69%
K	5600	BODY	02/28/2023	22.3	21.9	0.05	1191	7659	1407	3.760	78.600	75.200	-4.33%	1.070	21.800	21.400	-1.83%
K	5600	BODY	03/06/2023	23.0	21.3	0.05	1057	7659	1407	3.940	77.000	78.800	2.34%	1.110	21.200	22.200	4.72%
K	5750	BODY	02/28/2023	22.3	21.9	0.05	1191	7659	1407	3.500	74.900	70.000	-6.54%	0.993	20.700	19.860	-4.06%
K	5750	BODY	03/06/2023	23.0	21.3	0.05	1057	7659	1407	3.570	74.900	71.400	-4.67%	1.010	20.700	20.200	-2.42%

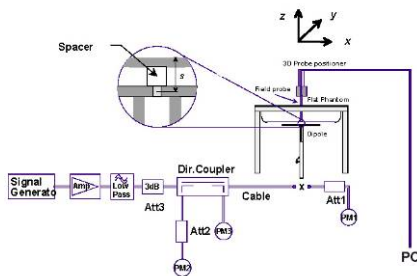

**Figure 10-1
System Verification Setup Diagram**



**Figure 10-2
System Verification Setup Photo**

FCC ID: PY7-25682R	SAR EVALUATION REPORT	Approved by: Technical Manager
Document S/N: 1M2302230018-05.PY7 (Rev2)	DUT Type: Portable Handset	Page 50 of 74

11 SAR DATA SUMMARY

11.1 Standalone Head SAR Data

**Table 11-1
GSM/DTM 850 Head SAR**

MEASUREMENT RESULTS																
FREQUENCY		Side	Test Position	Mode	Service	Antenna Config.	Device Serial Number	# of Time Slots	Maximum Allowed Power [dBm]	Conducted Power [dBm]	Power Drift [dB]	Duty Cycle	SAR (1g)	Scaling Factor	Reported SAR (1g)	Plot #
MHz	Ch.												(W/kg)		(W/kg)	
824.20	128	Right	Cheek	GSM 850	GSM	Main 1	89747	N/A	32.9	31.75	0.04	1:8.3	0.103	1.303	0.134	
824.20	128	Right	Tilt	GSM 850	GSM	Main 1	89747	N/A	32.9	31.75	-0.06	1:8.3	0.040	1.303	0.052	
824.20	128	Left	Cheek	GSM 850	GSM	Main 1	89747	N/A	32.9	31.75	0.05	1:8.3	0.098	1.303	0.128	
824.20	128	Left	Tilt	GSM 850	GSM	Main 1	89747	N/A	32.9	31.75	-0.14	1:8.3	0.037	1.303	0.048	
848.80	251	Right	Cheek	GSM 850	DTM	Main 1	89747	3	28.1	27.72	0.06	1:2.76	0.108	1.091	0.118	A1
848.80	251	Right	Tilt	GSM 850	DTM	Main 1	89747	3	28.1	27.72	-0.08	1:2.76	0.043	1.091	0.047	
848.80	251	Left	Cheek	GSM 850	DTM	Main 1	89747	3	28.1	27.72	0.14	1:2.76	0.091	1.091	0.099	
848.80	251	Left	Tilt	GSM 850	DTM	Main 1	89747	3	28.1	27.72	0.11	1:2.76	0.042	1.091	0.046	
ICNIRP 1998 - SAFETY LIMIT Spatial Peak Uncontrolled Exposure/General Population								Head 1.6 W/kg (mW/g) averaged over 1 gram								

**Table 11-2
GSM/DTM 1900 Head SAR**

MEASUREMENT RESULTS																
FREQUENCY		Side	Test Position	Mode	Service	Antenna Config.	Device Serial Number	# of Time Slots	Maximum Allowed Power [dBm]	Conducted Power [dBm]	Power Drift [dB]	Duty Cycle	SAR (1g)	Scaling Factor	Reported SAR (1g)	Plot #
MHz	Ch.												(W/kg)		(W/kg)	
1909.80	810	Right	Cheek	GSM 1900	GSM	Main 2	89747	N/A	28.0	26.88	0.12	1:8.3	0.032	1.294	0.041	
1909.80	810	Right	Tilt	GSM 1900	GSM	Main 2	89747	N/A	28.0	26.88	-0.13	1:8.3	0.013	1.294	0.017	
1909.80	810	Left	Cheek	GSM 1900	GSM	Main 2	89747	N/A	28.0	26.88	-0.06	1:8.3	0.019	1.294	0.025	
1909.80	810	Left	Tilt	GSM 1900	GSM	Main 2	89747	N/A	28.0	26.88	0.07	1:8.3	0.016	1.294	0.021	
1909.80	810	Right	Cheek	GSM 1900	DTM	Main 2	89747	3	23.2	23.15	0.13	1:2.76	0.033	1.012	0.033	A2
1909.80	810	Right	Tilt	GSM 1900	DTM	Main 2	89747	3	23.2	23.15	-0.15	1:2.76	0.015	1.012	0.015	
1909.80	810	Left	Cheek	GSM 1900	DTM	Main 2	89747	3	23.2	23.15	0.17	1:2.76	0.021	1.012	0.021	
1909.80	810	Left	Tilt	GSM 1900	DTM	Main 2	89747	3	23.2	23.15	0.09	1:2.76	0.019	1.012	0.019	
ANSI / IEEE C95.1 1992 - SAFETY LIMIT Spatial Peak Uncontrolled Exposure/General Population								Head 1.6 W/kg (mW/g) averaged over 1 gram								

FCC ID: PY7-25682R	SAR EVALUATION REPORT	Approved by: Technical Manager
Document S/N: 1M2302230018-05.PY7 (Rev2)	DUT Type: Portable Handset	Page 51 of 74

**Table 11-3
UMTS 850 Head SAR**

MEASUREMENT RESULTS															
FREQUENCY		Side	Test Position	Mode	Service	Antenna Config.	Device Serial Number	Maximum Allowed Power [dBm]	Conducted Power [dBm]	Power Drift [dB]	Duty Cycle	SAR (1g)	Scaling Factor	Reported SAR (1g)	Plot #
MHz	Ch.											(W/kg)		(W/kg)	
836.60	4183	Right	Cheek	UMTS 850	RMC	Main 1	89788	22.7	22.64	0.12	1:1	0.114	1.014	0.116	A3
836.60	4183	Right	Tilt	UMTS 850	RMC	Main 1	89788	22.7	22.64	-0.11	1:1	0.051	1.014	0.052	
836.60	4183	Left	Cheek	UMTS 850	RMC	Main 1	89788	22.7	22.64	-0.07	1:1	0.071	1.014	0.072	
836.60	4183	Left	Tilt	UMTS 850	RMC	Main 1	89788	22.7	22.64	0.03	1:1	0.049	1.014	0.050	
ANSI / IEEE C95.1 1992 - SAFETY LIMIT Spatial Peak Uncontrolled Exposure/General Population							Head 1.6 W/kg (mW/g) averaged over 1 gram								

**Table 11-4
UMTS 1750 Head SAR**

MEASUREMENT RESULTS															
FREQUENCY		Side	Test Position	Mode	Service	Antenna Config.	Device Serial Number	Maximum Allowed Power [dBm]	Conducted Power [dBm]	Power Drift [dB]	Duty Cycle	SAR (1g)	Scaling Factor	Reported SAR (1g)	Plot #
MHz	Ch.											(W/kg)		(W/kg)	
1732.40	1412	Right	Cheek	UMTS 1750	RMC	Main 2	89788	18.7	18.49	-0.12	1:1	0.022	1.050	0.023	A4
1732.40	1412	Right	Tilt	UMTS 1750	RMC	Main 2	89788	18.7	18.49	-0.12	1:1	0.013	1.050	0.014	
1732.40	1412	Left	Cheek	UMTS 1750	RMC	Main 2	89788	18.7	18.49	-0.13	1:1	0.017	1.050	0.018	
1732.40	1412	Left	Tilt	UMTS 1750	RMC	Main 2	89788	18.7	18.49	0.12	1:1	0.014	1.050	0.015	
ANSI / IEEE C95.1 1992 - SAFETY LIMIT Spatial Peak Uncontrolled Exposure/General Population							Head 1.6 W/kg (mW/g) averaged over 1 gram								

**Table 11-5
UMTS 1900 Head SAR**

MEASUREMENT RESULTS															
FREQUENCY		Side	Test Position	Mode	Service	Antenna Config.	Device Serial Number	Maximum Allowed Power [dBm]	Conducted Power [dBm]	Power Drift [dB]	Duty Cycle	SAR (1g)	Scaling Factor	Reported SAR (1g)	Plot #
MHz	Ch.											(W/kg)		(W/kg)	
1880.00	9400	Right	Cheek	UMTS 1900	RMC	Main 2	89747	19.7	18.61	-0.10	1:1	0.049	1.285	0.063	A5
1880.00	9400	Right	Tilt	UMTS 1900	RMC	Main 2	89747	19.7	18.61	-0.14	1:1	0.021	1.285	0.027	
1880.00	9400	Left	Cheek	UMTS 1900	RMC	Main 2	89747	19.7	18.61	0.07	1:1	0.030	1.285	0.039	
1880.00	9400	Left	Tilt	UMTS 1900	RMC	Main 2	89747	19.7	18.61	-0.08	1:1	0.026	1.285	0.033	
ANSI / IEEE C95.1 1992 - SAFETY LIMIT Spatial Peak Uncontrolled Exposure/General Population							Head 1.6 W/kg (mW/g) averaged over 1 gram								

FCC ID: PY7-25682R	SAR EVALUATION REPORT	Approved by: Technical Manager
Document S/N: 1M2302230018-05.PY7 (Rev2)	DUT Type: Portable Handset	Page 52 of 74

**Table 11-6
LTE Band 12 Head SAR**

MEASUREMENT RESULTS																				
FREQUENCY		Side	Test Position	Mode	Antenna Config.	Device Serial Number	Bandwidth [MHz]	Modulation	RB Size	RB Offset	Maximum Allowed Power [dBm]	Conducted Power [dBm]	MPR [dB]	Power Drift [dB]	Duty Cycle	SAR (1g)	Scaling Factor	Reported SAR (1g)	Plot #	
MHz	Ch.															(W/kg)		(W/kg)		
707.50	23095	Mid	Right	Cheek	LTE Band 12	Main 1	89523	10	QPSK	1	25	22.0	21.38	0	0.06	1:1	0.059	1.153	0.068	A6
707.50	23095	Mid	Right	Cheek	LTE Band 12	Main 1	89523	10	QPSK	25	12	22.0	21.36	0	-0.02	1:1	0.048	1.159	0.056	
707.50	23095	Mid	Right	Tilt	LTE Band 12	Main 1	89523	10	QPSK	1	25	22.0	21.38	0	0.14	1:1	0.018	1.153	0.021	
707.50	23095	Mid	Right	Tilt	LTE Band 12	Main 1	89523	10	QPSK	25	12	22.0	21.36	0	0.08	1:1	0.015	1.159	0.017	
707.50	23095	Mid	Left	Cheek	LTE Band 12	Main 1	89523	10	QPSK	1	25	22.0	21.38	0	0.08	1:1	0.039	1.153	0.045	
707.50	23095	Mid	Left	Cheek	LTE Band 12	Main 1	89523	10	QPSK	25	12	22.0	21.36	0	-0.07	1:1	0.034	1.159	0.039	
707.50	23095	Mid	Left	Tilt	LTE Band 12	Main 1	89523	10	QPSK	1	25	22.0	21.38	0	0.15	1:1	0.015	1.153	0.017	
707.50	23095	Mid	Left	Tilt	LTE Band 12	Main 1	89523	10	QPSK	25	12	22.0	21.36	0	0.13	1:1	0.013	1.159	0.015	
ANSI / IEEE C95.1 1992 - SAFETY LIMIT Spatial Peak Uncontrolled Exposure/General Population												Head 1.6 W/kg (mW/g) averaged over 1 gram								

**Table 11-7
LTE Band 13 Head SAR**

MEASUREMENT RESULTS																				
FREQUENCY		Side	Test Position	Mode	Antenna Config.	Device Serial Number	Bandwidth [MHz]	Modulation	RB Size	RB Offset	Maximum Allowed Power [dBm]	Conducted Power [dBm]	MPR [dB]	Power Drift [dB]	Duty Cycle	SAR (1g)	Scaling Factor	Reported SAR (1g)	Plot #	
MHz	Ch.															(W/kg)		(W/kg)		
782.00	23230	Mid	Right	Cheek	LTE Band 13	Main 1	89523	10	QPSK	1	0	22.0	21.28	0	0.03	1:1	0.069	1.180	0.081	A7
782.00	23230	Mid	Right	Cheek	LTE Band 13	Main 1	89523	10	QPSK	25	12	22.0	21.17	0	0.05	1:1	0.059	1.211	0.071	
782.00	23230	Mid	Right	Tilt	LTE Band 13	Main 1	89523	10	QPSK	1	0	22.0	21.28	0	0.00	1:1	0.027	1.180	0.032	
782.00	23230	Mid	Right	Tilt	LTE Band 13	Main 1	89523	10	QPSK	25	12	22.0	21.17	0	0.04	1:1	0.026	1.211	0.031	
782.00	23230	Mid	Left	Cheek	LTE Band 13	Main 1	89523	10	QPSK	1	0	22.0	21.28	0	-0.07	1:1	0.056	1.180	0.066	
782.00	23230	Mid	Left	Cheek	LTE Band 13	Main 1	89523	10	QPSK	25	12	22.0	21.17	0	-0.03	1:1	0.045	1.211	0.054	
782.00	23230	Mid	Left	Tilt	LTE Band 13	Main 1	89523	10	QPSK	1	0	22.0	21.28	0	-0.02	1:1	0.032	1.180	0.038	
782.00	23230	Mid	Left	Tilt	LTE Band 13	Main 1	89523	10	QPSK	25	12	22.0	21.17	0	0.10	1:1	0.025	1.211	0.030	
ANSI / IEEE C95.1 1992 - SAFETY LIMIT Spatial Peak Uncontrolled Exposure/General Population												Head 1.6 W/kg (mW/g) averaged over 1 gram								

FCC ID: PY7-25682R	SAR EVALUATION REPORT	Approved by: Technical Manager
Document S/N: 1M2302230018-05.PY7 (Rev2)	DUT Type: Portable Handset	Page 53 of 74

**Table 11-8
LTE Band 5 (Cell) Head SAR**

MEASUREMENT RESULTS																				
FREQUENCY		Side	Test Position	Mode	Antenna Config.	Device Serial Number	Bandwidth [MHz]	Modulation	RB Size	RB Offset	Maximum Allowed Power [dBm]	Conducted Power [dBm]	MPR [dB]	Power Drift [dB]	Duty Cycle	SAR (1g)	Scaling Factor	Reported SAR (1g)	Plot #	
MHz	Ch.															(W/kg)		(W/kg)		
836.50	20525	Mid	Right	Cheek	LTE Band 5 (Cell)	Main 1	89523	10	QPSK	1	25	22.0	21.26	0	0.03	1:1	0.067	1.186	0.079	A8
836.50	20525	Mid	Right	Cheek	LTE Band 5 (Cell)	Main 1	89523	10	QPSK	25	25	22.0	21.18	0	0.04	1:1	0.053	1.208	0.064	
836.50	20525	Mid	Right	Tilt	LTE Band 5 (Cell)	Main 1	89523	10	QPSK	1	25	22.0	21.26	0	0.16	1:1	0.025	1.186	0.030	
836.50	20525	Mid	Right	Tilt	LTE Band 5 (Cell)	Main 1	89523	10	QPSK	25	25	22.0	21.18	0	-0.03	1:1	0.019	1.208	0.023	
836.50	20525	Mid	Left	Cheek	LTE Band 5 (Cell)	Main 1	89523	10	QPSK	1	25	22.0	21.26	0	0.13	1:1	0.047	1.186	0.056	
836.50	20525	Mid	Left	Cheek	LTE Band 5 (Cell)	Main 1	89523	10	QPSK	25	25	22.0	21.18	0	0.05	1:1	0.039	1.208	0.047	
836.50	20525	Mid	Left	Tilt	LTE Band 5 (Cell)	Main 1	89523	10	QPSK	1	25	22.0	21.26	0	0.12	1:1	0.025	1.186	0.030	
836.50	20525	Mid	Left	Tilt	LTE Band 5 (Cell)	Main 1	89523	10	QPSK	25	25	22.0	21.18	0	0.16	1:1	0.021	1.208	0.025	
ANSI / IEEE C95.1 1992 - SAFETY LIMIT Spatial Peak Uncontrolled Exposure/General Population											Head 1.6 W/kg (mW/g) averaged over 1 gram									

**Table 11-9
LTE Band 66 (AWS) Head SAR**

MEASUREMENT RESULTS																				
FREQUENCY		Side	Test Position	Mode	Antenna Config.	Device Serial Number	Bandwidth [MHz]	Modulation	RB Size	RB Offset	Maximum Allowed Power [dBm]	Conducted Power [dBm]	MPR [dB]	Power Drift [dB]	Duty Cycle	SAR (1g)	Scaling Factor	Reported SAR (1g)	Plot #	
MHz	Ch.															(W/kg)		(W/kg)		
1720.00	132072	Low	Right	Cheek	LTE Band 66 (AWS)	Main 2	89721	20	QPSK	1	50	19.0	18.53	0	0.12	1:1	0.025	1.114	0.028	A9
1720.00	132072	Low	Right	Cheek	LTE Band 66 (AWS)	Main 2	89721	20	QPSK	50	50	19.0	18.33	0	0.05	1:1	0.020	1.167	0.023	
1720.00	132072	Low	Right	Tilt	LTE Band 66 (AWS)	Main 2	89721	20	QPSK	1	50	19.0	18.53	0	0.13	1:1	0.013	1.114	0.014	
1720.00	132072	Low	Right	Tilt	LTE Band 66 (AWS)	Main 2	89721	20	QPSK	50	50	19.0	18.33	0	-0.18	1:1	0.010	1.167	0.012	
1720.00	132072	Low	Left	Cheek	LTE Band 66 (AWS)	Main 2	89721	20	QPSK	1	50	19.0	18.53	0	-0.15	1:1	0.019	1.114	0.021	
1720.00	132072	Low	Left	Cheek	LTE Band 66 (AWS)	Main 2	89721	20	QPSK	50	50	19.0	18.33	0	-0.07	1:1	0.021	1.167	0.025	
1720.00	132072	Low	Left	Tilt	LTE Band 66 (AWS)	Main 2	89721	20	QPSK	1	50	19.0	18.53	0	0.10	1:1	0.010	1.114	0.011	
1720.00	132072	Low	Left	Tilt	LTE Band 66 (AWS)	Main 2	89721	20	QPSK	50	50	19.0	18.33	0	-0.13	1:1	0.010	1.167	0.012	
ANSI / IEEE C95.1 1992 - SAFETY LIMIT Spatial Peak Uncontrolled Exposure/General Population											Head 1.6 W/kg (mW/g) averaged over 1 gram									

**Table 11-10
LTE Band 25 (PCS) Head SAR**

MEASUREMENT RESULTS																				
FREQUENCY		Side	Test Position	Mode	Antenna Config.	Device Serial Number	Bandwidth [MHz]	Modulation	RB Size	RB Offset	Maximum Allowed Power [dBm]	Conducted Power [dBm]	MPR [dB]	Power Drift [dB]	Duty Cycle	SAR (1g)	Scaling Factor	Reported SAR (1g)	Plot #	
MHz	Ch.															(W/kg)		(W/kg)		
1882.50	26365	Mid	Right	Cheek	LTE Band 25 (PCS)	Main 2	89523	20	QPSK	1	99	20.0	19.65	0	-0.13	1:1	0.045	1.084	0.049	A10
1882.50	26365	Mid	Right	Cheek	LTE Band 25 (PCS)	Main 2	89523	20	QPSK	50	50	20.0	19.54	0	-0.05	1:1	0.037	1.112	0.041	
1882.50	26365	Mid	Right	Tilt	LTE Band 25 (PCS)	Main 2	89523	20	QPSK	1	99	20.0	19.65	0	0.17	1:1	0.015	1.084	0.016	
1882.50	26365	Mid	Right	Tilt	LTE Band 25 (PCS)	Main 2	89523	20	QPSK	50	50	20.0	19.54	0	-0.15	1:1	0.015	1.112	0.017	
1882.50	26365	Mid	Left	Cheek	LTE Band 25 (PCS)	Main 2	89523	20	QPSK	1	99	20.0	19.65	0	0.12	1:1	0.031	1.084	0.034	
1882.50	26365	Mid	Left	Cheek	LTE Band 25 (PCS)	Main 2	89523	20	QPSK	50	50	20.0	19.54	0	-0.03	1:1	0.023	1.112	0.026	
1882.50	26365	Mid	Left	Tilt	LTE Band 25 (PCS)	Main 2	89523	20	QPSK	1	99	20.0	19.65	0	0.12	1:1	0.023	1.084	0.025	
1882.50	26365	Mid	Left	Tilt	LTE Band 25 (PCS)	Main 2	89523	20	QPSK	50	50	20.0	19.54	0	0.12	1:1	0.017	1.112	0.019	
ANSI / IEEE C95.1 1992 - SAFETY LIMIT Spatial Peak Uncontrolled Exposure/General Population											Head 1.6 W/kg (mW/g) averaged over 1 gram									

FCC ID: PY7-25682R	SAR EVALUATION REPORT	Approved by: Technical Manager
Document S/N: 1M2302230018-05.PY7 (Rev2)	DUT Type: Portable Handset	Page 54 of 74

**Table 11-11
LTE Band 41 Head SAR**

MEASUREMENT RESULTS																				
FREQUENCY		Side	Test Position	Mode	Antenna Config.	Device Serial Number	Bandwidth [MHz]	Modulation	RB Size	RB Offset	Maximum Allowed Power [dBm]	Conducted Power [dBm]	MPR [dB]	Power Drift [dB]	Duty Cycle	SAR (1g) (W/kg)	Scaling Factor	Reported SAR (1g) (W/kg)	Plot #	
MHz	Ch.																			
2593.00	40620	Mid	Right	Cheek	LTE Band 41	Main 2	89721	20	QPSK	1	99	20.0	19.43	0	-0.05	1:1.58	0.018	1.140	0.021	A11
2593.00	40620	Mid	Right	Cheek	LTE Band 41	Main 2	89721	20	QPSK	50	50	20.0	19.48	0	-0.18	1:1.58	0.013	1.127	0.015	
2593.00	40620	Mid	Right	Tilt	LTE Band 41	Main 2	89721	20	QPSK	1	99	20.0	19.43	0	0.20	1:1.58	0.006	1.140	0.007	
2593.00	40620	Mid	Right	Tilt	LTE Band 41	Main 2	89721	20	QPSK	50	50	20.0	19.48	0	0.12	1:1.58	0.005	1.127	0.006	
2593.00	40620	Mid	Left	Cheek	LTE Band 41	Main 2	89721	20	QPSK	1	99	20.0	19.43	0	0.19	1:1.58	0.014	1.140	0.016	
2593.00	40620	Mid	Left	Cheek	LTE Band 41	Main 2	89721	20	QPSK	50	50	20.0	19.48	0	-0.09	1:1.58	0.011	1.127	0.012	
2593.00	40620	Mid	Left	Tilt	LTE Band 41	Main 2	89721	20	QPSK	1	99	20.0	19.43	0	0.20	1:1.58	0.013	1.140	0.015	
2593.00	40620	Mid	Left	Tilt	LTE Band 41	Main 2	89721	20	QPSK	50	50	20.0	19.48	0	0.03	1:1.58	0.010	1.127	0.011	
ANSI / IEEE C95.1 1992 - SAFETY LIMIT Spatial Peak Uncontrolled Exposure/General Population											Head 1.6 W/kg (mW/g) averaged over 1 gram									

**Table 11-12
DTS Head MIMO SAR**

MEASUREMENT RESULTS																						
FREQUENCY		Side	Test Position	Mode	Service	Antenna Config.	Device Serial Number	Bandwidth [MHz]	Data Rate (Mbps)	Maximum Allowed Power (Chain 0) [dBm]	Conducted Power (Chain 0) [dBm]	Maximum Allowed Power (Chain 1) [dBm]	Conducted Power (Chain 1) [dBm]	Power Drift [dB]	Maximum Duty Cycle (%)	Duty Cycle (%)	Peak SAR of Area Scan (W/kg)	SAR (1g) (W/kg)	Scaling Factor (Power)	Scaling Factor (Duty Cycle)	Reported SAR (1g) (W/kg)	Plot #
MHz	Ch.																					
2437	6	Right	Cheek	802.11n	OFDM	MIMO	89606	20	13	14.0	13.74	14.0	13.57	0.00	100.00	99.71	0.697	0.525	1.104	1.003	0.581	A12
2437	6	Right	Tilt	802.11n	OFDM	MIMO	89606	20	13	14.0	13.74	14.0	13.57	0.08	100.00	99.71	0.151	0.139	1.104	1.003	0.154	
2437	6	Left	Cheek	802.11n	OFDM	MIMO	89606	20	13	14.0	13.74	14.0	13.57	-0.16	100.00	99.71	0.159	0.120	1.104	1.003	0.133	
2437	6	Left	Tilt	802.11n	OFDM	MIMO	89606	20	13	14.0	13.74	14.0	13.57	0.09	100.00	99.71	0.053	0.042	1.104	1.003	0.047	
ANSI / IEEE C95.1 1992 - SAFETY LIMIT Spatial Peak Uncontrolled Exposure/General Population											Head 1.6 W/kg (mW/g) averaged over 1 gram											

Note: In MIMO operations, each antenna transmits at a maximum allowed power of 14.0 dBm.

**Table 11-13
NII MIMO Head SAR**

MEASUREMENT RESULTS																						
FREQUENCY		Side	Test Position	Mode	Service	Antenna Config.	Device Serial Number	Bandwidth [MHz]	Data Rate (Mbps)	Maximum Allowed Power (Chain 0) [dBm]	Conducted Power (Chain 0) [dBm]	Maximum Allowed Power (Chain 1) [dBm]	Conducted Power (Chain 1) [dBm]	Power Drift [dB]	Maximum Duty Cycle (%)	Duty Cycle (%)	Peak SAR of Area Scan (W/kg)	SAR (1g) (W/kg)	Scaling Factor (Power)	Scaling Factor (Duty Cycle)	Reported SAR (1g) (W/kg)	Plot #
MHz	Ch.																					
5290	58	Right	Cheek	802.11ac	OFDM	MIMO	87089	80	58.5	11.5	11.34	11.5	9.72	0.20	100.00	99.71	0.134	0.080	1.507	1.003	0.121	
5290	58	Right	Tilt	802.11ac	OFDM	MIMO	87089	80	58.5	11.5	11.34	11.5	9.72	0.12	100.00	99.71	0.054	0.046	1.507	1.003	0.070	
5290	58	Left	Cheek	802.11ac	OFDM	MIMO	87089	80	58.5	11.5	11.34	11.5	9.72	-0.05	100.00	99.71	0.051	0.031	1.507	1.003	0.047	
5290	58	Left	Tilt	802.11ac	OFDM	MIMO	89606	80	58.5	11.5	11.34	11.5	9.72	-0.17	100.00	99.71	0.033	0.019	1.507	1.003	0.029	
5690	138	Right	Cheek	802.11ac	OFDM	MIMO	87089	80	58.5	11.5	11.42	11.5	9.85	0.09	100.00	99.71	0.118	0.090	1.462	1.003	0.132	
5690	138	Right	Tilt	802.11ac	OFDM	MIMO	87089	80	58.5	11.5	11.42	11.5	9.85	-0.12	100.00	99.71	0.042	0.024	1.462	1.003	0.035	
5690	138	Left	Cheek	802.11ac	OFDM	MIMO	87089	80	58.5	11.5	11.42	11.5	9.85	0.13	100.00	99.71	0.061	0.044	1.462	1.003	0.065	
5690	138	Left	Tilt	802.11ac	OFDM	MIMO	87089	80	58.5	11.5	11.42	11.5	9.85	-0.15	100.00	99.71	0.024	0.013	1.462	1.003	0.019	
5795	159	Right	Cheek	802.11n	OFDM	MIMO	87089	40	27	11.5	11.49	11.5	9.51	0.13	100.00	99.72	0.134	0.118	1.581	1.003	0.187	A13
5795	159	Right	Tilt	802.11n	OFDM	MIMO	87089	40	27	11.5	11.49	11.5	9.51	-0.07	100.00	99.72	0.053	0.022	1.581	1.003	0.035	
5795	159	Left	Cheek	802.11n	OFDM	MIMO	87089	40	27	11.5	11.49	11.5	9.51	0.15	100.00	99.72	0.084	0.063	1.581	1.003	0.100	
5795	159	Left	Tilt	802.11n	OFDM	MIMO	87089	40	27	11.5	11.49	11.5	9.51	0.14	100.00	99.72	0.032	0.021	1.581	1.003	0.033	
ANSI / IEEE C95.1 1992 - SAFETY LIMIT Spatial Peak Uncontrolled Exposure/General Population											Head 1.6 W/kg (mW/g) averaged over 1 gram											

Note: In MIMO operations, each antenna transmits at a maximum allowed power of 11.5 dBm.

FCC ID: PY7-25682R	SAR EVALUATION REPORT	Approved by: Technical Manager
Document S/N: 1M2302230018-05.PY7 (Rev2)	DUT Type: Portable Handset	Page 55 of 74

**Table 11-14
DSS Head SISO SAR**

MEASUREMENT RESULTS																		
FREQUENCY		Side	Test Position	Mode	Service	Antenna Config.	Device Serial Number	Data Rate (Mbps)	Maximum Allowed Power [dBm]	Conducted Power [dBm]	Power Drift [dB]	Maximum Duty Cycle (%)	Duty Cycle (%)	SAR (1g)	Scaling Factor (Cond Power)	Scaling Factor (Duty Cycle)	Reported SAR (1g)	Plot #
MHz	Ch.													(W/kg)			(W/kg)	
2480	78	Right	Cheek	Bluetooth	FHSS	WiFi Main	89606	1	14.0	13.64	0.03	83.30	77.07	0.195	1.086	1.081	0.229	A14
2480	78	Right	Tilt	Bluetooth	FHSS	WiFi Main	89606	1	14.0	13.64	-0.14	83.30	77.07	0.029	1.086	1.081	0.034	
2480	78	Left	Cheek	Bluetooth	FHSS	WiFi Main	89606	1	14.0	13.64	0.14	83.30	77.07	0.041	1.086	1.081	0.048	
2480	78	Left	Tilt	Bluetooth	FHSS	WiFi Main	89606	1	14.0	13.64	0.01	83.30	77.07	0.009	1.086	1.081	0.011	
2480	78	Right	Cheek	Bluetooth	FHSS	WiFi Sub	89606	1	14.0	13.82	-0.10	83.30	77.07	0.000	1.042	1.081	0.000	
2480	78	Right	Tilt	Bluetooth	FHSS	WiFi Sub	89606	1	14.0	13.82	-0.10	83.30	77.07	0.003	1.042	1.081	0.003	
2480	78	Left	Cheek	Bluetooth	FHSS	WiFi Sub	89606	1	14.0	13.82	0.15	83.30	77.07	0.000	1.042	1.081	0.000	
2480	78	Left	Tilt	Bluetooth	FHSS	WiFi Sub	89606	1	14.0	13.82	-0.13	83.30	77.07	0.000	1.042	1.081	0.000	
ANSI / IEEE C95.1 1992 - SAFETY LIMIT Spatial Peak Uncontrolled Exposure/General Population									Head 1.6 W/kg (mW/g) averaged over 1 gram									

FCC ID: PY7-25682R	SAR EVALUATION REPORT	Approved by: Technical Manager
Document S/N: 1M2302230018-05.PY7 (Rev2)	DUT Type: Portable Handset	Page 56 of 74

11.2 Standalone Body-Worn SAR Data

**Table 11-15
GSM/DTM Body-Worn SAR Data**

MEASUREMENT RESULTS																
FREQUENCY		Side	Spacing	Mode	Service	Antenna Config.	Device Serial Number	# of Time Slots	Maximum Allowed Power [dBm]	Conducted Power [dBm]	Power Drift [dB]	Duty Cycle	SAR (1g)	Scaling Factor	Reported SAR (1g)	Plot #
MHz	Ch.												(W/kg)		(W/kg)	
824.20	128	back	10 mm	GSM 850	GSM	Main 1	89747	N/A	32.9	31.75	-0.02	1:8.3	0.296	1.303	0.386	
848.80	251	back	10 mm	GSM 850	DTM	Main 1	89747	3	28.1	27.72	-0.02	1:2.76	0.341	1.091	0.372	A15
1909.80	810	back	10 mm	GSM 1900	GSM	Main 2	89747	N/A	28.0	26.88	-0.05	1:8.3	0.132	1.294	0.171	
1909.80	810	back	10 mm	GSM 1900	DTM	Main 2	89747	3	23.2	23.15	-0.03	1:2.76	0.138	1.012	0.140	A16
ANSI / IEEE C95.1 1992 - SAFETY LIMIT Spatial Peak Uncontrolled Exposure/General Population								Body 1.6 W/kg (mW/g) averaged over 1 gram								

**Table 11-16
UMTS Body-Worn SAR Data**

MEASUREMENT RESULTS																
FREQUENCY		Side	Spacing	Mode	Service	Antenna Config.	Device Serial Number	Maximum Allowed Power [dBm]	Conducted Power [dBm]	Power Drift [dB]	Duty Cycle	SAR (1g)	Scaling Factor	Reported SAR (1g)	Plot #	
MHz	Ch.											(W/kg)		(W/kg)		
836.60	4183	back	10 mm	UMTS 850	RMC	Main 1	89788	22.7	22.64	-0.01	1:1	0.288	1.014	0.292	A18	
1732.40	1412	back	10 mm	UMTS 1750	RMC	Main 2	89721	18.7	18.49	-0.02	1:1	0.109	1.050	0.114	A19	
1880.00	9400	back	10 mm	UMTS 1900	RMC	Main 2	89747	19.7	18.61	-0.02	1:1	0.224	1.285	0.288	A21	
ANSI / IEEE C95.1 1992 - SAFETY LIMIT Spatial Peak Uncontrolled Exposure/General Population								Body 1.6 W/kg (mW/g) averaged over 1 gram								

**Table 11-17
LTE Body-Worn SAR**

MEASUREMENT RESULTS																			
FREQUENCY		Side	Spacing	Mode	Antenna Config.	Device Serial Number	Bandwidth [MHz]	Modulation	RB Size	RB Offset	Maximum Allowed Power [dBm]	Conducted Power [dBm]	MPR [dB]	Power Drift [dB]	Duty Cycle	SAR (1g)	Scaling Factor	Reported SAR (1g)	Plot #
MHz	Ch.															(W/kg)		(W/kg)	
707.50	23095	Mid	back	LTE Band 12	Main 1	89523	10	QPSK	1	25	22.0	21.38	0	0.01	1:1	0.226	1.153	0.261	
707.50	23095	Mid	back	LTE Band 12	Main 1	89523	10	QPSK	25	12	22.0	21.36	0	0.00	1:1	0.233	1.159	0.270	A23
782.00	23230	Mid	back	LTE Band 13	Main 1	89523	10	QPSK	1	0	22.0	21.28	0	-0.02	1:1	0.345	1.180	0.407	
782.00	23230	Mid	back	LTE Band 13	Main 1	89523	10	QPSK	25	12	22.0	21.17	0	-0.03	1:1	0.359	1.211	0.435	A24
836.50	20525	Mid	back	LTE Band 5 (Cell)	Main 1	89523	10	QPSK	1	25	22.0	21.26	0	-0.05	1:1	0.187	1.186	0.222	
836.50	20525	Mid	back	LTE Band 5 (Cell)	Main 1	89523	10	QPSK	25	25	22.0	21.18	0	0.00	1:1	0.189	1.208	0.228	A25
1720.00	132072	Low	back	LTE Band 66 (AWS)	Main 2	89523	20	QPSK	1	50	19.0	18.53	0	0.03	1:1	0.117	1.114	0.130	
1720.00	132072	Low	back	LTE Band 66 (AWS)	Main 2	89523	20	QPSK	50	50	19.0	18.33	0	-0.01	1:1	0.118	1.167	0.138	A26
1882.50	26365	Mid	back	LTE Band 25 (PCS)	Main 2	89788	20	QPSK	1	99	20.0	19.65	0	0.08	1:1	0.126	1.084	0.137	A28
1882.50	26365	Mid	back	LTE Band 25 (PCS)	Main 2	89788	20	QPSK	50	50	20.0	19.54	0	-0.06	1:1	0.125	1.112	0.139	
2593.00	40620	Mid	back	LTE Band 41	Main 2	89788	20	QPSK	1	99	20.0	19.43	0	0.04	1:1.58	0.064	1.140	0.073	A30
2593.00	40620	Mid	back	LTE Band 41	Main 2	89788	20	QPSK	50	50	20.0	19.48	0	0.07	1:1.58	0.051	1.127	0.057	
ANSI / IEEE C95.1 1992 - SAFETY LIMIT Spatial Peak Uncontrolled Exposure/General Population								Body 1.6 W/kg (mW/g) averaged over 1 gram											

FCC ID: PY7-25682R	SAR EVALUATION REPORT	Approved by: Technical Manager
Document S/N: 1M2302230018-05.PY7 (Rev2)	DUT Type: Portable Handset	Page 57 of 74

**Table 11-18
DTS MIMO Body-Worn SAR**

MEASUREMENT RESULTS																						
FREQUENCY		Side	Spacing	Mode	Service	Antenna Config.	Device Serial Number	Bandwidth [MHz]	Data Rate (Mbps)	Maximum Allowed Power (Chain 0) [dBm]	Conducted Power (Chain 0) [dBm]	Maximum Allowed Power (Chain 1) [dBm]	Conducted Power (Chain 1) [dBm]	Power Drift [dB]	Maximum Duty Cycle (%)	Duty Cycle (%)	Peak SAR of Area Scan	SAR (1g)	Scaling Factor (Power)	Scaling Factor (Duty Cycle)	Reported SAR (1g)	Plot #
MHz	Ch.																W/kg	(W/kg)			(W/kg)	
2437	6	back	10 mm	802.11n	OFDM	MIMO	87089	20	13	14.0	13.74	14.0	13.57	-0.14	100.00	99.71	0.148	0.113	1.104	1.003	0.125	A32
ANSI / IEEE C95.1 1992 - SAFETY LIMIT Spatial Peak Uncontrolled Exposure/General Population											Body 1.6 W/kg (mW/g) averaged over 1 gram											

Note: In MIMO operations, each antenna transmits at a maximum allowed power of 14.0 dBm.

**Table 11-19
NII MIMO Body-Worn SAR**

MEASUREMENT RESULTS																						
FREQUENCY		Side	Spacing	Mode	Service	Antenna Config.	Device Serial Number	Bandwidth [MHz]	Data Rate (Mbps)	Maximum Allowed Power (Chain 0) [dBm]	Conducted Power (Chain 0) [dBm]	Maximum Allowed Power (Chain 1) [dBm]	Conducted Power (Chain 1) [dBm]	Power Drift [dB]	Maximum Duty Cycle (%)	Duty Cycle (%)	Peak SAR of Area Scan	SAR (1g)	Scaling Factor (Power)	Scaling Factor (Duty Cycle)	Reported SAR (1g)	Plot #
MHz	Ch.																W/kg	(W/kg)			(W/kg)	
5290	58	back	10 mm	802.11ac	OFDM	MIMO	89762	80	58.5	11.5	11.34	11.5	9.72	-0.19	100.00	99.71	0.075	0.046	1.507	1.003	0.070	A34
5690	138	back	10 mm	802.11ac	OFDM	MIMO	89762	80	58.5	11.5	11.42	11.5	9.85	0.10	100.00	99.71	0.059	0.028	1.462	1.003	0.041	
5795	159	back	10 mm	802.11n	OFDM	MIMO	89606	40	27	11.5	11.49	11.5	9.51	-0.14	100.00	99.72	0.058	0.032	1.581	1.003	0.051	
ANSI / IEEE C95.1 1992 - SAFETY LIMIT Spatial Peak Uncontrolled Exposure/General Population											Body 1.6 W/kg (mW/g) averaged over 1 gram											

Note: In MIMO operations, each antenna transmits at a maximum allowed power of 11.5 dBm.

**Table 11-20
DSS ISO Body-Worn SAR**

MEASUREMENT RESULTS																			
FREQUENCY		Side	Spacing	Mode	Service	Antenna Config.	Device Serial Number	Data Rate (Mbps)	Maximum Allowed Power [dBm]	Conducted Power [dBm]	Power Drift [dB]	Maximum Duty Cycle (%)	Duty Cycle (%)	SAR (1g)	Scaling Factor (Cond Power)	Scaling Factor (Duty Cycle)	Reported SAR (1g)	Plot #	
MHz	Ch.													(W/kg)			(W/kg)		(W/kg)
2480	78	back	10 mm	Bluetooth	FHSS	WiFi Main	87089	1	14.0	13.64	-0.01	83.30	77.07	0.041	1.086	1.081	0.048		
2480	78	back	10 mm	Bluetooth	FHSS	WiFi Sub	87089	1	14.0	13.82	0.13	83.30	77.07	0.054	1.042	1.081	0.061	A36	
ANSI / IEEE C95.1 1992 - SAFETY LIMIT Spatial Peak Uncontrolled Exposure/General Population											Body 1.6 W/kg (mW/g) averaged over 1 gram								

FCC ID: PY7-25682R	SAR EVALUATION REPORT	Approved by: Technical Manager
Document S/N: 1M2302230018-05.PY7 (Rev2)	DUT Type: Portable Handset	Page 58 of 74

11.3 Standalone Hotspot SAR Data

**Table 11-21
GPRS/DTM Hotspot SAR Data**

MEASUREMENT RESULTS																
FREQUENCY		Side	Spacing	Mode	Service	Antenna Config.	Device Serial Number	# of Time Slots	Maximum Allowed Power [dBm]	Conducted Power [dBm]	Power Drift [dB]	Duty Cycle	SAR (1g)	Scaling Factor	Reported SAR (1g)	Plot #
MHz	Ch.												(W/kg)		(W/kg)	
848.80	251	back	10 mm	GSM 850	GPRS	Main 1	89747	4	26.9	25.98	0.05	1:2.076	0.257	1.236	0.318	
848.80	251	front	10 mm	GSM 850	GPRS	Main 1	89747	4	26.9	25.98	0.01	1:2.076	0.228	1.236	0.282	
848.80	251	bottom	10 mm	GSM 850	GPRS	Main 1	89747	4	26.9	25.98	-0.06	1:2.076	0.119	1.236	0.147	
848.80	251	left	10 mm	GSM 850	GPRS	Main 1	89747	4	26.9	25.98	0.03	1:2.076	0.081	1.236	0.100	
848.80	251	back	10 mm	GSM 850	DTM	Main 1	89747	3	28.1	27.72	-0.02	1:2.76	0.341	1.091	0.372	A15
848.80	251	front	10 mm	GSM 850	DTM	Main 1	89747	3	28.1	27.72	-0.01	1:2.76	0.310	1.091	0.338	
848.80	251	bottom	10 mm	GSM 850	DTM	Main 1	89747	3	28.1	27.72	-0.01	1:2.76	0.135	1.091	0.147	
848.80	251	left	10 mm	GSM 850	DTM	Main 1	89747	3	28.1	27.72	-0.06	1:2.76	0.092	1.091	0.100	
1909.80	810	back	10 mm	GSM 1900	GPRS	Main 2	89747	4	22.0	20.90	-0.02	1:2.076	0.119	1.288	0.153	
1909.80	810	front	10 mm	GSM 1900	GPRS	Main 2	89747	4	22.0	20.90	-0.01	1:2.076	0.137	1.288	0.176	
1909.80	810	bottom	10 mm	GSM 1900	GPRS	Main 2	89747	4	22.0	20.90	-0.03	1:2.076	0.201	1.288	0.259	
1909.80	810	right	10 mm	GSM 1900	GPRS	Main 2	89747	4	22.0	20.90	-0.01	1:2.076	0.045	1.288	0.058	
1909.80	810	back	10 mm	GSM 1900	DTM	Main 2	89747	3	23.2	23.15	-0.03	1:2.76	0.138	1.012	0.140	
1909.80	810	front	10 mm	GSM 1900	DTM	Main 2	89747	3	23.2	23.15	0.19	1:2.76	0.134	1.012	0.136	
1909.80	810	bottom	10 mm	GSM 1900	DTM	Main 2	89747	3	23.2	23.15	-0.07	1:2.76	0.247	1.012	0.250	A17
1909.80	810	right	10 mm	GSM 1900	DTM	Main 2	89747	3	23.2	23.15	0.03	1:2.76	0.051	1.012	0.052	
ANSI / IEEE C95.1 1992 - SAFETY LIMIT							Body									
Spatial Peak							1.6 W/kg (mW/g)									
Uncontrolled Exposure/General Population							averaged over 1 gram									

FCC ID: PY7-25682R	SAR EVALUATION REPORT	Approved by: Technical Manager
Document S/N: 1M2302230018-05.PY7 (Rev2)	DUT Type: Portable Handset	Page 59 of 74

**Table 11-22
UMTS Hotspot SAR Data**

MEASUREMENT RESULTS															
FREQUENCY		Side	Spacing	Mode	Service	Antenna Config.	Device Serial Number	Maximum Allowed Power [dBm]	Conducted Power [dBm]	Power Drift [dB]	Duty Cycle	SAR (1g)	Scaling Factor	Reported SAR (1g)	Plot #
MHz	Ch.											(W/kg)		(W/kg)	
836.60	4183	back	10 mm	UMTS 850	RMC	Main 1	89788	22.7	22.64	-0.01	1:1	0.288	1.014	0.292	A18
836.60	4183	front	10 mm	UMTS 850	RMC	Main 1	89788	22.7	22.64	0.00	1:1	0.230	1.014	0.233	
836.60	4183	bottom	10 mm	UMTS 850	RMC	Main 1	89788	22.7	22.64	-0.01	1:1	0.133	1.014	0.135	
836.60	4183	left	10 mm	UMTS 850	RMC	Main 1	89788	22.7	22.64	-0.03	1:1	0.111	1.014	0.113	
1732.40	1412	back	10 mm	UMTS 1750	RMC	Main 2	89721	18.7	18.49	-0.02	1:1	0.109	1.050	0.114	
1732.40	1412	front	10 mm	UMTS 1750	RMC	Main 2	89721	18.7	18.49	-0.02	1:1	0.106	1.050	0.111	
1732.40	1412	bottom	10 mm	UMTS 1750	RMC	Main 2	89721	18.7	18.49	-0.05	1:1	0.152	1.050	0.160	A20
1732.40	1412	right	10 mm	UMTS 1750	RMC	Main 2	89721	18.7	18.49	0.06	1:1	0.070	1.050	0.074	
1880.00	9400	back	10 mm	UMTS 1900	RMC	Main 2	89747	19.7	18.61	-0.02	1:1	0.224	1.285	0.288	
1880.00	9400	front	10 mm	UMTS 1900	RMC	Main 2	89747	19.7	18.61	-0.01	1:1	0.199	1.285	0.256	
1880.00	9400	bottom	10 mm	UMTS 1900	RMC	Main 2	89747	19.7	18.61	0.00	1:1	0.295	1.285	0.379	A22
1880.00	9400	right	10 mm	UMTS 1900	RMC	Main 2	89747	19.7	18.61	-0.01	1:1	0.081	1.285	0.104	
ANSI / IEEE C95.1 1992 - SAFETY LIMIT Spatial Peak Uncontrolled Exposure/General Population							Body 1.6 W/kg (mW/g) averaged over 1 gram								

FCC ID: PY7-25682R	SAR EVALUATION REPORT	Approved by: Technical Manager
Document S/N: 1M2302230018-05.PY7 (Rev2)	DUT Type: Portable Handset	Page 60 of 74

**Table 11-23
LTE Band 12 Hotspot SAR**

MEASUREMENT RESULTS																				
FREQUENCY		Side	Spacing	Mode	Antenna Config.	Device Serial Number	Bandwidth [MHz]	Modulation	RB Size	RB Offset	Maximum Allowed Power [dBm]	Conducted Power [dBm]	MPR [dB]	Power Drift [dB]	Duty Cycle	SAR (1g)	Scaling Factor	Reported SAR (1g)	Plot #	
MHz	Ch.															(W/kg)		(W/kg)		
707.50	23095	Mid	back	10 mm	LTE Band 12	Main 1	89523	10	QPSK	1	25	22.0	21.38	0	0.01	1:1	0.226	1.153	0.261	
707.50	23095	Mid	back	10 mm	LTE Band 12	Main 1	89523	10	QPSK	25	12	22.0	21.36	0	0.00	1:1	0.233	1.159	0.270	A23
707.50	23095	Mid	front	10 mm	LTE Band 12	Main 1	89523	10	QPSK	1	25	22.0	21.38	0	0.01	1:1	0.151	1.153	0.174	
707.50	23095	Mid	front	10 mm	LTE Band 12	Main 1	89523	10	QPSK	25	12	22.0	21.36	0	-0.01	1:1	0.156	1.159	0.181	
707.50	23095	Mid	bottom	10 mm	LTE Band 12	Main 1	89523	10	QPSK	1	25	22.0	21.38	0	0.04	1:1	0.084	1.153	0.097	
707.50	23095	Mid	bottom	10 mm	LTE Band 12	Main 1	89523	10	QPSK	25	12	22.0	21.36	0	-0.01	1:1	0.090	1.159	0.104	
707.50	23095	Mid	left	10 mm	LTE Band 12	Main 1	89523	10	QPSK	1	25	22.0	21.38	0	-0.05	1:1	0.089	1.153	0.103	
707.50	23095	Mid	left	10 mm	LTE Band 12	Main 1	89523	10	QPSK	25	12	22.0	21.36	0	-0.02	1:1	0.085	1.159	0.099	
ANSI / IEEE C95.1 1992 - SAFETY LIMIT Spatial Peak Uncontrolled Exposure/General Population												Body 1.6 W/kg (mW/g) averaged over 1 gram								

**Table 11-24
LTE Band 13 Hotspot SAR**

MEASUREMENT RESULTS																				
FREQUENCY		Side	Spacing	Mode	Antenna Config.	Device Serial Number	Bandwidth [MHz]	Modulation	RB Size	RB Offset	Maximum Allowed Power [dBm]	Conducted Power [dBm]	MPR [dB]	Power Drift [dB]	Duty Cycle	SAR (1g)	Scaling Factor	Reported SAR (1g)	Plot #	
MHz	Ch.															(W/kg)		(W/kg)		
782.00	23230	Mid	back	10 mm	LTE Band 13	Main 1	89523	10	QPSK	1	0	22.0	21.28	0	-0.02	1:1	0.345	1.180	0.407	
782.00	23230	Mid	back	10 mm	LTE Band 13	Main 1	89523	10	QPSK	25	12	22.0	21.17	0	-0.03	1:1	0.359	1.211	0.435	A24
782.00	23230	Mid	front	10 mm	LTE Band 13	Main 1	89523	10	QPSK	1	0	22.0	21.28	0	0.01	1:1	0.241	1.180	0.284	
782.00	23230	Mid	front	10 mm	LTE Band 13	Main 1	89523	10	QPSK	25	12	22.0	21.17	0	0.01	1:1	0.252	1.211	0.305	
782.00	23230	Mid	bottom	10 mm	LTE Band 13	Main 1	89523	10	QPSK	1	0	22.0	21.28	0	-0.01	1:1	0.136	1.180	0.160	
782.00	23230	Mid	bottom	10 mm	LTE Band 13	Main 1	89523	10	QPSK	25	12	22.0	21.17	0	-0.03	1:1	0.140	1.211	0.170	
782.00	23230	Mid	left	10 mm	LTE Band 13	Main 1	89523	10	QPSK	1	0	22.0	21.28	0	-0.07	1:1	0.093	1.180	0.110	
782.00	23230	Mid	left	10 mm	LTE Band 13	Main 1	89523	10	QPSK	25	12	22.0	21.17	0	0.02	1:1	0.088	1.211	0.107	
ANSI / IEEE C95.1 1992 - SAFETY LIMIT Spatial Peak Uncontrolled Exposure/General Population												Body 1.6 W/kg (mW/g) averaged over 1 gram								

FCC ID: PY7-25682R	SAR EVALUATION REPORT	Approved by: Technical Manager
Document S/N: 1M2302230018-05.PY7 (Rev2)	DUT Type: Portable Handset	Page 61 of 74

**Table 11-25
LTE Band 5 (Cell) Hotspot SAR**

MEASUREMENT RESULTS																				
FREQUENCY		Side	Spacing	Mode	Antenna Config.	Device Serial Number	Bandwidth [MHz]	Modulation	RB Size	RB Offset	Maximum Allowed Power [dBm]	Conducted Power [dBm]	MPR [dB]	Power Drift [dB]	Duty Cycle	SAR (1g)	Scaling Factor	Reported SAR (1g)	Plot #	
MHz	Ch.															(W/kg)		(W/kg)		
836.50	20525	Mid	back	10 mm	LTE Band 5 (Cell)	Main 1	89523	10	QPSK	1	25	22.0	21.26	0	-0.05	1:1	0.187	1.186	0.222	
836.50	20525	Mid	back	10 mm	LTE Band 5 (Cell)	Main 1	89523	10	QPSK	25	25	22.0	21.18	0	0.00	1:1	0.189	1.208	0.228	A25
836.50	20525	Mid	front	10 mm	LTE Band 5 (Cell)	Main 1	89523	10	QPSK	1	25	22.0	21.26	0	-0.01	1:1	0.181	1.186	0.215	
836.50	20525	Mid	front	10 mm	LTE Band 5 (Cell)	Main 1	89523	10	QPSK	25	25	22.0	21.18	0	-0.01	1:1	0.186	1.208	0.225	
836.50	20525	Mid	bottom	10 mm	LTE Band 5 (Cell)	Main 1	89523	10	QPSK	1	25	22.0	21.26	0	-0.02	1:1	0.079	1.186	0.094	
836.50	20525	Mid	bottom	10 mm	LTE Band 5 (Cell)	Main 1	89523	10	QPSK	25	25	22.0	21.18	0	-0.03	1:1	0.080	1.208	0.097	
836.50	20525	Mid	left	10 mm	LTE Band 5 (Cell)	Main 1	89523	10	QPSK	1	25	22.0	21.26	0	-0.02	1:1	0.060	1.186	0.071	
836.50	20525	Mid	left	10 mm	LTE Band 5 (Cell)	Main 1	89523	10	QPSK	25	25	22.0	21.18	0	-0.04	1:1	0.060	1.208	0.072	
ANSI / IEEE C95.1 1992 - SAFETY LIMIT Spatial Peak Uncontrolled Exposure/General Population												Body 1.6 W/kg (mW/g) averaged over 1 gram								

**Table 11-26
LTE Band 66 (AWS) Hotspot SAR**

MEASUREMENT RESULTS																				
FREQUENCY		Side	Spacing	Mode	Antenna Config.	Device Serial Number	Bandwidth [MHz]	Modulation	RB Size	RB Offset	Maximum Allowed Power [dBm]	Conducted Power [dBm]	MPR [dB]	Power Drift [dB]	Duty Cycle	SAR (1g)	Scaling Factor	Reported SAR (1g)	Plot #	
MHz	Ch.															(W/kg)		(W/kg)		
1720.00	132072	Low	back	10 mm	LTE Band 66 (AWS)	Main 2	89523	20	QPSK	1	50	19.0	18.53	0	0.03	1:1	0.117	1.114	0.130	
1720.00	132072	Low	back	10 mm	LTE Band 66 (AWS)	Main 2	89523	20	QPSK	50	50	19.0	18.33	0	-0.01	1:1	0.118	1.167	0.138	
1720.00	132072	Low	front	10 mm	LTE Band 66 (AWS)	Main 2	89523	20	QPSK	1	50	19.0	18.53	0	0.07	1:1	0.120	1.114	0.134	
1720.00	132072	Low	front	10 mm	LTE Band 66 (AWS)	Main 2	89523	20	QPSK	50	50	19.0	18.33	0	-0.03	1:1	0.120	1.167	0.140	
1720.00	132072	Low	bottom	10 mm	LTE Band 66 (AWS)	Main 2	89523	20	QPSK	1	50	19.0	18.53	0	0.04	1:1	0.141	1.114	0.157	A27
1720.00	132072	Low	bottom	10 mm	LTE Band 66 (AWS)	Main 2	89523	20	QPSK	50	50	19.0	18.33	0	0.02	1:1	0.139	1.167	0.162	
1720.00	132072	Low	right	10 mm	LTE Band 66 (AWS)	Main 2	89523	20	QPSK	1	50	19.0	18.53	0	0.01	1:1	0.068	1.114	0.076	
1720.00	132072	Low	right	10 mm	LTE Band 66 (AWS)	Main 2	89523	20	QPSK	50	50	19.0	18.33	0	0.02	1:1	0.064	1.167	0.075	
ANSI / IEEE C95.1 1992 - SAFETY LIMIT Spatial Peak Uncontrolled Exposure/General Population												Body 1.6 W/kg (mW/g) averaged over 1 gram								

FCC ID: PY7-25682R	SAR EVALUATION REPORT	Approved by: Technical Manager
Document S/N: 1M2302230018-05.PY7 (Rev2)	DUT Type: Portable Handset	Page 62 of 74

**Table 11-27
LTE Band 25 (PCS) Hotspot SAR**

MEASUREMENT RESULTS																				
FREQUENCY		Side	Spacing	Mode	Antenna Config.	Device Serial Number	Bandwidth [MHz]	Modulation	RB Size	RB Offset	Maximum Allowed Power [dBm]	Conducted Power [dBm]	MPR [dB]	Power Drift [dB]	Duty Cycle	SAR (1g)	Scaling Factor	Reported SAR (1g)	Plot #	
MHz	Ch.															(W/kg)		(W/kg)		
1882.50	26365	Mid	back	10 mm	LTE Band 25 (PCS)	Main 2	89788	20	QPSK	1	99	20.0	19.65	0	0.08	1:1	0.126	1.084	0.137	
1882.50	26365	Mid	back	10 mm	LTE Band 25 (PCS)	Main 2	89788	20	QPSK	50	50	20.0	19.54	0	-0.06	1:1	0.125	1.112	0.139	
1882.50	26365	Mid	front	10 mm	LTE Band 25 (PCS)	Main 2	89788	20	QPSK	1	99	20.0	19.65	0	-0.08	1:1	0.121	1.084	0.131	
1882.50	26365	Mid	front	10 mm	LTE Band 25 (PCS)	Main 2	89788	20	QPSK	50	50	20.0	19.54	0	-0.02	1:1	0.122	1.112	0.136	
1882.50	26365	Mid	bottom	10 mm	LTE Band 25 (PCS)	Main 2	89788	20	QPSK	1	99	20.0	19.65	0	-0.02	1:1	0.252	1.084	0.273	A29
1882.50	26365	Mid	bottom	10 mm	LTE Band 25 (PCS)	Main 2	89788	20	QPSK	50	50	20.0	19.54	0	-0.01	1:1	0.252	1.112	0.280	
1882.50	26365	Mid	right	10 mm	LTE Band 25 (PCS)	Main 2	89788	20	QPSK	1	99	20.0	19.65	0	-0.01	1:1	0.066	1.084	0.072	
1882.50	26365	Mid	right	10 mm	LTE Band 25 (PCS)	Main 2	89788	20	QPSK	50	50	20.0	19.54	0	0.01	1:1	0.066	1.112	0.073	
ANSI / IEEE C95.1 1992 - SAFETY LIMIT Spatial Peak Uncontrolled Exposure/General Population												Body 1.6 W/kg (mW/g) averaged over 1 gram								

**Table 11-28
LTE Band 41 Hotspot SAR**

MEASUREMENT RESULTS																				
FREQUENCY		Side	Spacing	Mode	Antenna Config.	Device Serial Number	Bandwidth [MHz]	Modulation	RB Size	RB Offset	Maximum Allowed Power [dBm]	Conducted Power [dBm]	MPR [dB]	Power Drift [dB]	Duty Cycle	SAR (1g)	Scaling Factor	Reported SAR (1g)	Plot #	
MHz	Ch.															(W/kg)		(W/kg)		
2593.00	40620	Mid	back	10 mm	LTE Band 41	Main 2	89788	20	QPSK	1	99	20.0	19.43	0	0.04	1:1.58	0.064	1.140	0.073	
2593.00	40620	Mid	back	10 mm	LTE Band 41	Main 2	89788	20	QPSK	50	50	20.0	19.48	0	0.07	1:1.58	0.051	1.127	0.057	
2593.00	40620	Mid	front	10 mm	LTE Band 41	Main 2	89788	20	QPSK	1	99	20.0	19.43	0	0.11	1:1.58	0.098	1.140	0.112	A31
2593.00	40620	Mid	front	10 mm	LTE Band 41	Main 2	89788	20	QPSK	50	50	20.0	19.48	0	-0.01	1:1.58	0.081	1.127	0.091	
2593.00	40620	Mid	bottom	10 mm	LTE Band 41	Main 2	89788	20	QPSK	1	99	20.0	19.43	0	0.12	1:1.58	0.085	1.140	0.097	
2593.00	40620	Mid	bottom	10 mm	LTE Band 41	Main 2	89788	20	QPSK	50	50	20.0	19.48	0	-0.02	1:1.58	0.068	1.127	0.077	
2593.00	40620	Mid	right	10 mm	LTE Band 41	Main 2	89788	20	QPSK	1	99	20.0	19.43	0	-0.12	1:1.58	0.035	1.140	0.040	
2593.00	40620	Mid	right	10 mm	LTE Band 41	Main 2	89788	20	QPSK	50	50	20.0	19.48	0	-0.13	1:1.58	0.020	1.127	0.023	
ANSI / IEEE C95.1 1992 - SAFETY LIMIT Spatial Peak Uncontrolled Exposure/General Population												Body 1.6 W/kg (mW/g) averaged over 1 gram								

**Table 11-29
DTS MIMO WLAN Hotspot SAR**

MEASUREMENT RESULTS																						
FREQUENCY		Side	Spacing	Mode	Service	Antenna Config.	Device Serial Number	Bandwidth [MHz]	Data Rate (Mbps)	Maximum Allowed Power (Chain 0) [dBm]	Conducted Power (Chain 0) [dBm]	Maximum Allowed Power (Chain 1) [dBm]	Conducted Power (Chain 1) [dBm]	Power Drift [dB]	Maximum Duty Cycle (%)	Duty Cycle (%)	Peak SAR of Area Scan	SAR (1g)	Scaling Factor (Power)	Scaling Factor (Duty Cycle)	Reported SAR (1g)	Plot #
MHz	Ch.																(W/kg)	(W/kg)			(W/kg)	
2437	6	back	10 mm	802.11n	OFDM	MIMO	87089	20	13	14.0	13.74	14.0	13.57	-0.14	100.00	99.71	0.148	0.113	1.104	1.003	0.125	
2437	6	front	10 mm	802.11n	OFDM	MIMO	87089	20	13	14.0	13.74	14.0	13.57	-0.19	100.00	99.71	0.088	0.060	1.104	1.003	0.066	
2437	6	top	10 mm	802.11n	OFDM	MIMO	87089	20	13	14.0	13.74	14.0	13.57	0.13	100.00	99.71	0.019	0.013	1.104	1.003	0.014	
2437	6	bottom	10 mm	802.11n	OFDM	MIMO	87089	20	13	14.0	13.74	14.0	13.57	0.11	100.00	99.71	0.023	0.017	1.104	1.003	0.019	
2437	6	left	10 mm	802.11n	OFDM	MIMO	87089	20	13	14.0	13.74	14.0	13.57	0.06	100.00	99.71	0.200	0.145	1.104	1.003	0.161	A33
ANSI / IEEE C95.1 1992 - SAFETY LIMIT Spatial Peak Uncontrolled Exposure/General Population												Body 1.6 W/kg (mW/g) averaged over 1 gram										

Note: In MIMO operations, each antenna transmits at a maximum allowed power of 14.0 dBm.

FCC ID: PY7-25682R	SAR EVALUATION REPORT	Approved by: Technical Manager
Document S/N: 1M2302230018-05.PY7 (Rev2)	DUT Type: Portable Handset	Page 63 of 74

**Table 11-30
NII MIMO WLAN Hotspot SAR**

MEASUREMENT RESULTS																						
FREQUENCY		Side	Spacing	Mode	Service	Antenna Config.	Device Serial Number	Bandwidth [MHz]	Data Rate (Mbps)	Maximum Allowed Power (Chain 0) [dBm]	Conducted Power (Chain 0) [dBm]	Maximum Allowed Power (Chain 1) [dBm]	Conducted Power (Chain 1) [dBm]	Power Drift [dB]	Maximum Duty Cycle (%)	Duty Cycle (%)	Peak SAR of Area Scan	SAR (1g)	Scaling Factor (Power)	Scaling Factor (Duty Cycle)	Reported SAR (1g)	Plot #
MHz	Ch.																W/kg	(W/kg)	(W/kg)	(W/kg)		
5210	42	back	10 mm	802.11ac	OFDM	MIMO	89606	80	58.5	11.5	11.32	11.5	9.52	0.14	100.00	99.71	-0.310	0.053	1.578	1.003	0.084	
5210	42	front	10 mm	802.11ac	OFDM	MIMO	89606	80	58.5	11.5	11.32	11.5	9.52	-0.01	100.00	99.71	0.180	0.022	1.578	1.003	0.035	
5210	42	top	10 mm	802.11ac	OFDM	MIMO	89606	80	58.5	11.5	11.32	11.5	9.52	0.03	100.00	99.71	0.750	0.005	1.578	1.003	0.008	
5210	42	bottom	10 mm	802.11ac	OFDM	MIMO	89606	80	58.5	11.5	11.32	11.5	9.52	0.06	100.00	99.71	-0.210	0.016	1.578	1.003	0.025	
5210	42	left	10 mm	802.11ac	OFDM	MIMO	89606	80	58.5	11.5	11.32	11.5	9.52	-0.08	100.00	99.71	-0.710	0.041	1.578	1.003	0.065	
5795	159	back	10 mm	802.11n	OFDM	MIMO	89606	40	27	11.5	11.49	11.5	9.51	-0.14	100.00	99.72	0.058	0.032	1.581	1.003	0.051	
5795	159	front	10 mm	802.11n	OFDM	MIMO	89606	40	27	11.5	11.49	11.5	9.51	0.10	100.00	99.72	0.026	0.023	1.581	1.003	0.036	
5795	159	top	10 mm	802.11n	OFDM	MIMO	89606	40	27	11.5	11.49	11.5	9.51	-0.14	100.00	99.72	0.026	0.020	1.581	1.003	0.032	
5795	159	bottom	10 mm	802.11n	OFDM	MIMO	89606	40	27	11.5	11.49	11.5	9.51	0.14	100.00	99.72	0.018	0.008	1.581	1.003	0.013	
5795	159	left	10 mm	802.11n	OFDM	MIMO	89606	40	27	11.5	11.49	11.5	9.51	-0.11	100.00	99.72	0.084	0.055	1.581	1.003	0.087	A35
ANSI / IEEE C95.1 1992 - SAFETY LIMIT Spatial Peak Uncontrolled Exposure/General Population											Body 1.6 W/kg (mW/g) averaged over 1 gram											

Note: In MIMO operations, each antenna transmits at a maximum allowed power of 11.5 dBm

**Table 11-31
DSS Hotspot SAR**

MEASUREMENT RESULTS																		
FREQUENCY		Side	Spacing	Mode	Service	Antenna Config.	Device Serial Number	Data Rate (Mbps)	Maximum Allowed Power [dBm]	Conducted Power [dBm]	Power Drift [dB]	Maximum Duty Cycle (%)	Duty Cycle (%)	SAR (1g)	Scaling Factor (Cond Power)	Scaling Factor (Duty Cycle)	Reported SAR (1g)	Plot #
MHz	Ch.													(W/kg)	(W/kg)	(W/kg)		
2480	78	back	10 mm	Bluetooth	FHSS	WiFi Main	87089	1	14.0	13.64	-0.01	83.30	77.07	0.041	1.086	1.081	0.048	
2480	78	front	10 mm	Bluetooth	FHSS	WiFi Main	87089	1	14.0	13.64	0.03	83.30	77.07	0.031	1.086	1.081	0.036	
2480	78	top	10 mm	Bluetooth	FHSS	WiFi Main	87089	1	14.0	13.64	0.16	83.30	77.07	0.005	1.086	1.081	0.006	
2480	78	left	10 mm	Bluetooth	FHSS	WiFi Main	87089	1	14.0	13.64	-0.12	83.30	77.07	0.084	1.086	1.081	0.099	A37
2480	78	back	10 mm	Bluetooth	FHSS	WiFi Sub	87089	1	14.0	13.82	0.13	83.30	77.07	0.054	1.042	1.081	0.061	
2480	78	front	10 mm	Bluetooth	FHSS	WiFi Sub	87089	1	14.0	13.82	0.15	83.30	77.07	0.004	1.042	1.081	0.005	
2480	78	bottom	10 mm	Bluetooth	FHSS	WiFi Sub	87089	1	14.0	13.82	0.17	83.30	77.07	0.006	1.042	1.081	0.007	
2480	78	left	10 mm	Bluetooth	FHSS	WiFi Sub	87089	1	14.0	13.82	0.12	83.30	77.07	0.004	1.042	1.081	0.005	
ANSI / IEEE C95.1 1992 - SAFETY LIMIT Spatial Peak Uncontrolled Exposure/General Population											Body 1.6 W/kg (mW/g) averaged over 1 gram							

FCC ID: PY7-25682R	SAR EVALUATION REPORT	Approved by: Technical Manager
Document S/N: 1M2302230018-05.PY7 (Rev2)	DUT Type: Portable Handset	Page 64 of 74

11.4 Standalone Phablet SAR Data

**Table 11-32
WLAN MIMO Phablet SAR**

MEASUREMENT RESULTS																						
FREQUENCY MHz	Ch.	Side	Spacing	Mode	Service	Antenna Config.	Device Serial Number	Bandwidth [MHz]	Data Rate (Mbps)	Maximum Allowed Power (Chain 0) [dBm]	Conducted Power (Chain 0) [dBm]	Maximum Allowed Power (Chain 1) [dBm]	Conducted Power (Chain 1) [dBm]	Power Drift [dB]	Maximum Duty Cycle (%)	Duty Cycle (%)	Peak SAR of Area Scan	SAR (10g)	Scaling Factor (Power)	Scaling Factor (Duty Cycle)	Reported SAR (10g)	Plot #
																	W/kg	(W/kg)			(W/kg)	
5290	58	back	0 mm	802.11ac	OFDM	MIMO	89762	80	58.5	11.5	11.34	11.5	9.72	-0.16	100.00	99.71	0.492	0.117	1.507	1.003	0.177	
5290	58	front	0 mm	802.11ac	OFDM	MIMO	89762	80	58.5	11.5	11.34	11.5	9.72	0.14	100.00	99.71	0.542	0.094	1.507	1.003	0.142	
5290	58	top	0 mm	802.11ac	OFDM	MIMO	89762	80	58.5	11.5	11.34	11.5	9.72	-0.14	100.00	99.71	0.068	0.013	1.507	1.003	0.020	
5290	58	bottom	0 mm	802.11ac	OFDM	MIMO	89762	80	58.5	11.5	11.34	11.5	9.72	0.15	100.00	99.71	0.150	0.018	1.507	1.003	0.027	
5290	58	left	0 mm	802.11ac	OFDM	MIMO	89762	80	58.5	11.5	11.34	11.5	9.72	-0.03	100.00	99.71	1.580	0.186	1.507	1.003	0.281	
5690	138	back	0 mm	802.11ac	OFDM	MIMO	89762	80	58.5	11.5	11.42	11.5	9.85	0.13	100.00	99.71	0.919	0.219	1.462	1.003	0.321	
5690	138	front	0 mm	802.11ac	OFDM	MIMO	89762	80	58.5	11.5	11.42	11.5	9.85	0.00	100.00	99.71	0.369	0.092	1.462	1.003	0.135	
5690	138	top	0 mm	802.11ac	OFDM	MIMO	89762	80	58.5	11.5	11.42	11.5	9.85	0.17	100.00	99.71	0.127	0.022	1.462	1.003	0.032	
5690	138	bottom	0 mm	802.11ac	OFDM	MIMO	89762	80	58.5	11.5	11.42	11.5	9.85	-0.14	100.00	99.71	0.035	0.004	1.462	1.003	0.006	
5690	138	left	0 mm	802.11ac	OFDM	MIMO	89762	80	58.5	11.5	11.42	11.5	9.85	0.15	100.00	99.71	2.770	0.351	1.462	1.003	0.515	A38
ANSI / IEEE C95.1 1992 - SAFETY LIMIT Spatial Peak Uncontrolled Exposure/General Population											Phablet 4.0 W/kg (mW/g) averaged over 10 grams											

Note: In MIMO operations, each antenna transmits at a maximum allowed power of 11.5 dBm.

**Table 11-33
NFC Phablet SAR**

MEASUREMENT RESULTS									
FREQUENCY MHz	Side	Spacing	Mode	Type	Antenna Config.	Device Serial Number	Power Drift	SAR (10g)	Plot #
								(W/kg)	
13.56	back	0 mm	NFC	B	NFC	89747	0.06	0.036	A39
13.56	front	0 mm	NFC	B	NFC	89747	0.02	0.000	
13.56	left	0 mm	NFC	B	NFC	89747	0.06	0.000	
ANSI / IEEE C95.1 1992 - SAFETY LIMIT Spatial Peak Uncontrolled Exposure/General Population							Phablet 4.0 W/kg (mW/g) averaged over 10 grams		

FCC ID: PY7-25682R	SAR EVALUATION REPORT	Approved by: Technical Manager
Document S/N: 1M2302230018-05.PY7 (Rev2)	DUT Type: Portable Handset	Page 65 of 74

11.5 SAR Test Notes

General Notes:

1. The test data reported are the worst-case SAR values according to test procedures specified in IEEE 1528-2013, and FCC KDB Publication 447498 D04v01.
2. Batteries are fully charged at the beginning of the SAR measurements.
3. Liquid tissue depth was at least 15.0 cm for all frequencies.
4. The manufacturer has confirmed that the device(s) tested have the same physical, mechanical and thermal characteristics and are within operational tolerances expected for production units.
5. SAR results were scaled to the maximum allowed power to demonstrate compliance per FCC KDB Publication 447498 D04v01.
6. Device was tested using a fixed spacing for body-worn accessory testing. A separation distance of 10 mm was considered because the manufacturer has determined that there will be body-worn accessories available in the marketplace for users to support this separation distance.
7. Per FCC KDB Publication 648474 D04v01r03, body-worn SAR was evaluated without a headset connected to the device. Since the standalone reported body-worn SAR was ≤ 1.2 W/kg, no additional body-worn SAR evaluations using a headset cable were required.
8. Per FCC KDB 865664 D01v01r04, variability SAR tests were not performed since the measured SAR results for a frequency band were not greater than or equal to 0.8 W/kg. Please see Section 12 for variability analysis.
9. During SAR Testing for the Wireless Router conditions per FCC KDB Publication 941225 D06v02r01, the actual Portable Hotspot operation (with actual simultaneous transmission of a transmitter with WIFI) was not activated (See Section 6.7 for more details).
10. Per FCC KDB Publication 648474 D04v01r03, this device is considered a "phablet" since the display diagonal dimension is > 150 mm and < 200 mm. Therefore, phablet SAR tests are required when wireless router mode does not apply or if wireless router 1g SAR > 1.2 W/kg.
11. Unless otherwise noted, when 10g SAR measurement is considered, a factor of 2.5 is applied to the 1g thresholds for the equivalent test cases.

GSM Test Notes:

1. Body-Worn accessory testing is typically associated with voice operations. Therefore, GSM voice was evaluated for body-worn SAR.
2. Justification for reduced test configurations per KDB Publication 941225 D01v03r01 and October 2013 TCB Workshop Notes: The source-based frame-averaged output power was evaluated for all GPRS/EDGE slot configurations. The configuration with the highest target frame averaged output power was evaluated for hotspot SAR. When the maximum frame-averaged powers are equivalent across two or more slots (within 0.25 dB), the configuration with the most number of time slots was tested.
3. Per FCC KDB Publication 447498 D04v01, if the reported (scaled) SAR measured at the highest output power channel for each test configuration is ≤ 0.8 W/kg for 1g evaluations then testing at the other channels is not required for such test configuration(s).
4. DTM SAR was evaluated with CMW500 Radio Communication Tester FW version 3.7.26 when the device was operating in DTM using maximum CS and PS slots according to FCC KDB 941225 D01v03r01.

UMTS Notes:

1. UMTS mode was tested under RMC 12.2 kbps with HSPA Inactive per KDB Publication 941225 D01v03r01. AMR and HSPA SAR was not required per the 3G Test Reduction Procedure in KDB Publication 941225 D01v03r01.
2. Per FCC KDB Publication 447498 D04v01, if the reported (scaled) SAR measured at the highest output power channel for each test configuration is ≤ 0.8 W/kg for 1g evaluations then testing at the other channels is not required for such test configuration(s).

FCC ID: PY7-25682R	SAR EVALUATION REPORT	Approved by: Technical Manager
Document S/N: 1M2302230018-05.PY7 (Rev2)	DUT Type: Portable Handset	Page 66 of 74

REV 22.0
03/30/2022

LTE Notes:

1. LTE test configurations are determined according to SAR Evaluation Considerations for LTE Devices in FCC KDB Publication 941225 D05v02r04. The general test procedures used for testing can be found in Section 8.5.4.
2. MPR is permanently implemented for this device by the manufacturer. The specific manufacturer target MPR is indicated alongside the SAR results. MPR is enabled for this device, according to 3GPP TS36.101 Section 6.2.3 – 6.2.5 under Table 6.2.3-1.
3. A-MPR was disabled for all SAR tests by setting NS=01 and MCC=001 on the base station simulator. SAR tests were performed with the same number of RB and RB offsets transmitting on all TTI frames (maximum TTI).
4. Per FCC KDB Publication 447498 D04v01, when the reported 1g SAR measured at the highest output power channel in a given a test configuration was > 0.6 W/kg for LTE B41, testing at the other channels was required for such test configurations.
5. TDD LTE was tested per the guidance provided in FCC KDB Publication 941225 D05v02r04. Testing was performed using UL-DL configuration 0 with 6 UL subframes and 2 S subframes using extended cyclic prefix only and special subframe configuration 6. SAR tests were performed at maximum output power and worst-case transmission duty factor in extended cyclic prefix. Per 3GPP 36.211 Section 4, the duty factor for special subframe configuration 6 using extended cyclic prefix is 0.633.
6. Per KDB Publication 941225 D05Av01r02, SAR for downlink only LTE CA operations was not needed since the maximum average output power in LTE CA mode was not >0.25 dB higher than the maximum output power when downlink carrier aggregation was inactive.

WLAN Notes:

1. For held-to-ear, hotspot, and phablet operations, the initial test position procedures were applied. The test position with the highest extrapolated peak SAR will be used as the initial test position. When reported SAR for the initial test position is ≤ 0.4 W/kg for 1g evaluations, no additional testing for the remaining test positions was required. Otherwise, SAR is evaluated at the subsequent highest peak SAR positions until the reported SAR result is ≤ 0.8 W/kg or all test positions are measured.
2. Justification for test configurations for WLAN per KDB Publication 248227 D01v02r02 for 2.4 GHz WIFI single transmission chain operations, the highest measured maximum output power channel for DSSS was selected for SAR measurement. SAR for OFDM modes (2.4 GHz 802.11g/n/ax) was not required due to the maximum allowed powers and the highest reported DSSS SAR. See Section 8.6.5 for more information.
3. Justification for test configurations for WLAN per KDB Publication 248227 D01v02r02 for 5 GHz WIFI operations, the initial test configuration was selected according to the transmission mode with the highest maximum allowed powers. Other transmission modes were not investigated since the highest reported SAR for initial test configuration adjusted by the ratio of maximum output powers is less than 1.2 W/kg for 1g evaluations. See Section 8.6.6 for more information.
4. When the maximum reported 1g averaged SAR is ≤ 0.8 W/kg, SAR testing on additional channels was not required. Otherwise, SAR for the next highest output power channel was required until the reported SAR result was ≤ 1.20 W/kg for 1g evaluations or all test channels were measured.
5. The device was configured to transmit continuously at the required data rate, channel bandwidth and signal modulation, using the highest transmission duty factor supported by the test mode tools. The reported SAR was scaled to the 100% transmission duty factor to determine compliance. Procedures used to measure the duty factor are identical to that in the associated EMC test reports.
6. When 10g SAR measurement is considered, a factor of 2.5 is applied to the thresholds above.
7. Per KDB Publication 248227 D01v02r02, SAR for MIMO was evaluated by following the simultaneous SAR provisions from KDB Publication 447498 D04v01 by either evaluating the sum of the 1g SAR values of each antenna transmitting independently or making a SAR measurement with both antennas transmitting simultaneously. Please see Multi-TX and Antenna SAR Considerations Appendix for complete analysis.

FCC ID: PY7-25682R	SAR EVALUATION REPORT	Approved by: Technical Manager
Document S/N: 1M2302230018-05.PY7 (Rev2)	DUT Type: Portable Handset	Page 67 of 74

Bluetooth Notes

1. Bluetooth SAR was measured with the device connected to a call box with hopping disabled with DH5 operation and Tx Tests test mode type. Per October 2016 TCB Workshop Notes, the reported SAR was scaled to the 83.3% transmission duty factor to determine compliance. See RF Conducted Power Section for the time domain plot and calculation for the duty factor of the device.
2. Head and Hotspot Bluetooth SAR were evaluated for BT BDR tethering applications.

FCC ID: PY7-25682R	SAR EVALUATION REPORT	Approved by: Technical Manager
Document S/N: 1M2302230018-05.PY7 (Rev2)	DUT Type: Portable Handset	Page 68 of 74

REV 22.0
03/30/2022

12 SAR MEASUREMENT VARIABILITY

12.1 Measurement Variability

Per FCC KDB Publication 865664 D01v01r04, variability SAR tests were not required since measured SAR results for all frequency bands were less than 0.8 W/kg for 1g SAR and less than 2.0 W/kg for 10g SAR.

12.2 Measurement Uncertainty

The measured SAR was <1.5 W/kg for 1g and <3.75 W/kg for 10g for all frequency bands. Therefore, per KDB Publication 865664 D01v01r04, the extended measurement uncertainty analysis per IEEE 1528-2013 was not required.

FCC ID: PY7-25682R	SAR EVALUATION REPORT	Approved by: Technical Manager
Document S/N: 1M2302230018-05.PY7 (Rev2)	DUT Type: Portable Handset	Page 69 of 74

REV 22.0
03/30/2022

13 EQUIPMENT LIST

Manufacturer	Model	Description	Cal Date	Cal Interval	Cal Due	Serial Number
Agilent	E4404B	Spectrum Analyzer	N/A	N/A	N/A	MY45113242
Agilent	E4438C	ESG Vector Signal Generator	1/18/2023	Annual	1/18/2024	MY47270002
Agilent	E4438C	ESG Vector Signal Generator	11/17/2022	Annual	11/17/2023	MY45093852
Agilent	N5182A	MXG Vector Signal Generator	11/30/2022	Annual	11/30/2023	MY47420603
Agilent	N5182A	MXG Vector Signal Generator	7/20/2022	Annual	7/20/2023	MY47420800
Agilent	8753ES	S-Parameter Vector Network Analyzer	6/14/2022	Annual	6/14/2023	US39170118
Agilent	8753ES	S-Parameter Vector Network Analyzer	1/12/2023	Annual	1/12/2024	MY40001472
Agilent	E5515C	Wireless Communications Test Set	5/12/2022	Annual	5/12/2023	GB43304278
Agilent	E5515C	Wireless Communications Test Set	5/4/2021	Biennial	5/4/2023	GB41450275
Agilent	N4010A	Wireless Connectivity Test Set	N/A	N/A	N/A	GB46170464
Amplifier Research	15S1G6	Amplifier	CBT	N/A	CBT	433972
Amplifier Research	150A100C	Amplifier	CBT	N/A	CBT	350132
Anritsu	ML2496A	Power Meter	8/16/2022	Annual	8/16/2023	1351001
Anritsu	ML2496A	Power Meter	3/31/2022	Annual	3/31/2023	1138001
Anritsu	MA2411B	Pulse Power Sensor	1/10/2023	Annual	1/10/2024	1315051
Anritsu	MA2411B	Pulse Power Sensor	3/28/2022	Annual	3/28/2023	1339007
Anritsu	MT8821C	Radio Communication Analyzer MT8821C	1/10/2023	Annual	1/10/2024	6201524637
Anritsu	MT8821C	Radio Communication Analyzer MT8821C	1/20/2023	Annual	1/20/2024	6201144419
Anritsu	MT8821C	Radio Communication Analyzer MT8821C	11/28/2022	Annual	11/28/2023	6262150047
Anritsu	MT8821C	Radio Communication Analyzer MT8821C	6/27/2022	Annual	6/27/2023	6261895213
Anritsu	MT8000A	Radio Communication Test Station	2/9/2023	Annual	2/9/2024	6272337408
Anritsu	MT8000A	Radio Communication Test Station	4/15/2022	Annual	4/15/2023	6272337439
Anritsu	MT8000A	Radio Communication Test Station	1/5/2023	Annual	1/5/2024	6272337436
Anritsu	MA24106A	USB Power Sensor	2/9/2023	Annual	2/9/2024	1520505
Anritsu	MA24106A	USB Power Sensor	2/14/2023	Annual	2/14/2024	1827529
Mini-Circuits	PWR-4GHS	USB Power Sensor	11/11/2022	Annual	11/11/2023	11710030062
Control Company	4352	Long Stem Thermometer	9/10/2021	Biennial	9/10/2023	210774678
Control Company	4352	Long Stem Thermometer	9/10/2021	Biennial	9/10/2023	210774685
Control Company	4040	Therm./Clock/Humidity Monitor	1/17/2023	Annual	1/17/2024	160574418
Mitutoyo	500-196-30	CD-6°ASX 6inch Digital Caliper	2/16/2022	Triennial	2/16/2025	A02238413
Keysight Technologies	N6705B	DC Power Analyzer	5/5/2021	Triennial	5/5/2024	MY30004059
Keysight Technologies	N9020A	MXA Signal Analyzer	3/4/2022	Annual	3/4/2023	US46470561
MCL	BW-N6W5+	6dB Attenuator	CBT	N/A	CBT	1139
Mini-Circuits	VLF-6000+	Low Pass Filter DC to 6000 MHz	CBT	N/A	CBT	N/A
Mini-Circuits	VLF-6000+	Low Pass Filter DC to 6000 MHz	7/5/2022	Annual	7/5/2023	31634
Mini-Circuits	BW-N20W5+	DC to 18 GHz Precision Fixed 20 dB Attenuator	CBT	N/A	CBT	N/A
Mini-Circuits	NLP-1200+	Low Pass Filter DC to 1000 MHz	CBT	N/A	CBT	N/A
Mini-Circuits	NLP-2950+	Low Pass Filter DC to 2700 MHz	CBT	N/A	CBT	N/A
Mini-Circuits	BW-N20W5	Power Attenuator	CBT	N/A	CBT	1226
Mini-Circuits	ZUDC10-83-5+	Directional Coupler	CBT	N/A	CBT	2050
Narda	4772-3	Attenuator (3dB)	CBT	N/A	CBT	9406
Narda	BW-53W2	Attenuator (3dB)	CBT	N/A	CBT	120
Seekonk	TSF-100	Torque Wrench	7/11/2022	Annual	7/11/2023	47639-29
Rohde & Schwarz	CMW500	Wideband Radio Communication Tester	2/17/2023	Annual	2/17/2024	164948
Rohde & Schwarz	CMW500	Wideband Radio Communication Tester	2/10/2023	Annual	2/10/2024	101699
Rohde & Schwarz	CMW500	Wideband Radio Communication Tester	11/30/2022	Annual	11/30/2023	128635
Rohde & Schwarz	CMW500	Wideband Radio Communication Tester	9/6/2022	Annual	9/6/2023	167286
SPEAG	DAK-3.5	Dielectric Assessment Kit	12/15/2022	Annual	12/15/2023	1278
SPEAG	DAKS-3.5	Portable Dielectric Assessment Kit	8/15/2022	Annual	8/15/2023	1041
SPEAG	MAIA	Modulation and Audio Interference Analyzer	N/A	N/A	N/A	1379
SPEAG	MAIA	Modulation and Audio Interference Analyzer	N/A	N/A	N/A	1237
SPEAG	CLA-13	Confined Loop Antenna	9/13/2022	Annual	9/13/2023	1002
SPEAG	D750V3	750 MHz SAR Dipole	10/19/2021	Biennial	10/19/2023	1161
SPEAG	D835V2	835 MHz SAR Dipole	5/16/2022	Annual	5/16/2023	4d040
SPEAG	D835V2	835 MHz SAR Dipole	10/19/2021	Biennial	10/19/2023	4d133
SPEAG	D835V2	835 MHz SAR Dipole	5/16/2022	Biennial	5/16/2023	460
SPEAG	D835V2	835 MHz SAR Dipole	1/21/2021	Triennial	1/21/2024	4d132
SPEAG	D1750V2	1750 MHz SAR Dipole	9/9/2020	Triennial	9/9/2023	1104
SPEAG	D1765V2	1750 MHz SAR Dipole	5/14/2021	Biennial	5/14/2023	1008
SPEAG	D1900V2	1900 MHz SAR Dipole	2/21/2022	Biennial	2/21/2024	5d148
SPEAG	D1900V2	1900 MHz SAR Dipole	9/21/2021	Biennial	9/21/2023	5d149
SPEAG	D1900V2	1900 MHz SAR Dipole	9/10/2020	Triennial	9/10/2023	5d181
SPEAG	D2450V2	2450 MHz SAR Dipole	5/11/2022	Annual	5/11/2023	750
SPEAG	D2450V2	2450 MHz SAR Dipole	11/25/2021	Biennial	11/25/2023	981
SPEAG	D2450V2	2450 MHz SAR Dipole	11/9/2021	Biennial	11/9/2023	921
SPEAG	D2600V2	2600 MHz SAR Dipole	5/11/2022	Annual	5/11/2023	1042
SPEAG	D2600V2	2600MHz SAR Dipole	11/15/2022	Annual	11/15/2023	1068
SPEAG	DSGHv2	5 GHz SAR Dipole	1/10/2022	Biennial	1/10/2024	1057
SPEAG	DSGHv2	5 GHz SAR Dipole	1/18/2023	Annual	1/18/2024	1191
SPEAG	DAE4	Dasy Data Acquisition Electronics	2/15/2023	Annual	2/15/2024	665
SPEAG	DAE4	Dasy Data Acquisition Electronics	6/14/2022	Annual	6/14/2023	1334
SPEAG	DAE4	Dasy Data Acquisition Electronics	12/13/2022	Annual	12/13/2023	1644
SPEAG	DAE4	Dasy Data Acquisition Electronics	7/18/2022	Annual	7/18/2023	1677
SPEAG	DAE4	Dasy Data Acquisition Electronics	11/10/2022	Annual	11/10/2023	1646
SPEAG	DAE4	Dasy Data Acquisition Electronics	10/13/2022	Annual	10/13/2023	1333
SPEAG	DAE4	Dasy Data Acquisition Electronics	1/17/2023	Annual	1/17/2024	1558
SPEAG	DAE4	Dasy Data Acquisition Electronics	4/13/2022	Annual	4/13/2023	1407
SPEAG	EX3DV4	SAR Probe	2/8/2023	Annual	2/8/2024	7417
SPEAG	EX3DV4	SAR Probe	6/16/2022	Annual	6/16/2023	7409
SPEAG	EX3DV4	SAR Probe	12/9/2022	Annual	12/9/2023	7490
SPEAG	EX3DV4	SAR Probe	7/18/2022	Annual	7/18/2023	7406
SPEAG	EX3DV4	SAR Probe	11/14/2022	Annual	11/14/2023	7639
SPEAG	EX3DV4	SAR Probe	10/20/2022	Annual	10/20/2023	7420
SPEAG	EX3DV4	SAR Probe	1/11/2023	Annual	1/11/2024	7570
SPEAG	EX3DV4	SAR Probe	4/20/2022	Annual	4/20/2023	7659

Note: CBT (Calibrated Before Testing). Prior to testing, the measurement paths containing a cable, amplifier, attenuator, coupler or filter were connected to a calibrated source (i.e. a signal generator) to determine the losses of the measurement path. The power meter offset was then adjusted to compensate for the measurement system losses. This level offset is stored within the power meter before measurements are made. This calibration verification procedure applies to the system verification and output power measurements. The calibrated reading is then taken directly from the power meter after compensation of the losses for all final power measurements.

Note: All equipment was used solely within its respective calibration period.

FCC ID: PY7-25682R	SAR EVALUATION REPORT	Approved by: Technical Manager
Document S/N: 1M2032230018-05.PY7 (Rev2)	DUT Type: Portable Handset	Page 70 of 74

14 MEASUREMENT UNCERTAINTIES

a	b	c	d	e= f(d,k)	f	g	h = c x f/e	i = c x g/e	k
Uncertainty Component	IEEE 1528 Sec.	Tol. (± %)	Prob. Dist.	Div.	c _i 1gm	c _i 10 gms	1gm u _i (± %)	10gms u _i (± %)	v _i
Measurement System									
Probe Calibration	E.2.1	7	N	1	1	1	7.0	7.0	∞
Axial Isotropy	E.2.2	0.25	N	1	0.7	0.7	0.2	0.2	∞
Hemishperical Isotropy	E.2.2	1.3	N	1	0.7	0.7	0.9	0.9	∞
Boundary Effect	E.2.3	2	R	1.732	1	1	1.2	1.2	∞
Linearity	E.2.4	0.3	N	1	1	1	0.3	0.3	∞
System Detection Limits	E.2.4	0.25	R	1.732	1	1	0.1	0.1	∞
Modulation Response	E.2.5	4.8	R	1.732	1	1	2.8	2.8	∞
Readout Electronics	E.2.6	0.3	N	1	1	1	0.3	0.3	∞
Response Time	E.2.7	0.8	R	1.732	1	1	0.5	0.5	∞
Integration Time	E.2.8	2.6	R	1.732	1	1	1.5	1.5	∞
RF Ambient Conditions - Noise	E.6.1	3	R	1.732	1	1	1.7	1.7	∞
RF Ambient Conditions - Reflections	E.6.1	3	R	1.732	1	1	1.7	1.7	∞
Probe Positioner Mechanical Tolerance	E.6.2	0.8	R	1.732	1	1	0.5	0.5	∞
Probe Positioning w/ respect to Phantom	E.6.3	6.7	R	1.732	1	1	3.9	3.9	∞
Extrapolation, Interpolation & Integration algorithms for Max. SAR Evaluation	E.5	4	R	1.732	1	1	2.3	2.3	∞
Test Sample Related									
Test Sample Positioning	E.4.2	3.12	N	1	1	1	3.1	3.1	35
Device Holder Uncertainty	E.4.1	1.67	N	1	1	1	1.7	1.7	5
Output Power Variation - SAR drift measurement	E.2.9	5	R	1.732	1	1	2.9	2.9	∞
SAR Scaling	E.6.5	0	R	1.732	1	1	0.0	0.0	∞
Phantom & Tissue Parameters									
Phantom Uncertainty (Shape & Thickness tolerances)	E.3.1	7.6	R	1.73	1.0	1.0	4.4	4.4	∞
Liquid Conductivity - measurement uncertainty	E.3.3	4.3	N	1	0.78	0.71	3.3	3.0	76
Liquid Permittivity - measurement uncertainty	E.3.3	4.2	N	1	0.23	0.26	1.0	1.1	75
Liquid Conductivity - Temperature Uncertainty	E.3.4	3.4	R	1.732	0.78	0.71	1.5	1.4	∞
Liquid Permittivity - Temperature Uncertainty	E.3.4	0.6	R	1.732	0.23	0.26	0.1	0.1	∞
Liquid Conductivity - deviation from target values	E.3.2	5.0	R	1.73	0.64	0.43	1.8	1.2	∞
Liquid Permittivity - deviation from target values	E.3.2	5.0	R	1.73	0.60	0.49	1.7	1.4	∞
Combined Standard Uncertainty (k=1)	RSS						12.2	12.0	191
Expanded Uncertainty (95% CONFIDENCE LEVEL)	k=2						24.4	24.0	

The above measurement uncertainties are according to IEEE Std. 1528-2013

FCC ID: PY7-25682R	SAR EVALUATION REPORT	Approved by: Technical Manager
Document S/N: 1M2302230018-05.PY7 (Rev2)	DUT Type: Portable Handset	Page 71 of 74

REV 22.0
03/30/2022

15 CONCLUSION

15.1 Measurement Conclusion

The SAR evaluation indicates that the EUT complies with the RF radiation exposure limits of the FCC and Innovation, Science, and Economic Development Canada, with respect to all parameters subject to this test. These measurements were taken to simulate the RF effects of RF exposure under worst-case conditions. Precise laboratory measures were taken to assure repeatability of the tests. The results and statements relate only to the item(s) tested.

Please note that the absorption and distribution of electromagnetic energy in the body are very complex phenomena that depend on the mass, shape, and size of the body, the orientation of the body with respect to the field vectors, and the electrical properties of both the body and the environment. Other variables that may play a substantial role in possible biological effects are those that characterize the environment (e.g. ambient temperature, air velocity, relative humidity, and body insulation) and those that characterize the individual (e.g. age, gender, activity level, debilitation, or disease). Because various factors may interact with one another to vary the specific biological outcome of an exposure to electromagnetic fields, any protection guide should consider maximal amplification of biological effects as a result of field-body interactions, environmental conditions, and physiological variables. [3]

FCC ID: PY7-25682R	SAR EVALUATION REPORT	Approved by: Technical Manager
Document S/N: 1M2302230018-05.PY7 (Rev2)	DUT Type: Portable Handset	Page 72 of 74

REV 22.0
03/30/2022

16 REFERENCES

- [1] Federal Communications Commission, ET Docket 93-62, Guidelines for Evaluating the Environmental Effects of Radiofrequency Radiation, Aug. 1996.
- [2] ANSI/IEEE C95.1-2005, American National Standard safety levels with respect to human exposure to radio frequency electromagnetic fields, 3kHz to 300GHz, New York: IEEE, 2006.
- [3] ANSI/IEEE C95.1-1992, American National Standard safety levels with respect to human exposure to radio frequency electromagnetic fields, 3kHz to 300GHz, New York: IEEE, Sept. 1992.
- [4] ANSI/IEEE C95.3-2002, IEEE Recommended Practice for the Measurement of Potentially Hazardous Electromagnetic Fields - RF and Microwave, New York: IEEE, December 2002.
- [5] IEEE Standards Coordinating Committee 39 –Standards Coordinating Committee 34 – IEEE Std. 1528-2013, IEEE Recommended Practice for Determining the Peak Spatial-Average Specific Absorption Rate (SAR) in the Human Head from Wireless Communications Devices: Measurement Techniques.
- [6] NCRP, National Council on Radiation Protection and Measurements, Biological Effects and Exposure Criteria for RadioFrequency Electromagnetic Fields, NCRP Report No. 86, 1986. Reprinted Feb. 1995.
- [7] T. Schmid, O. Egger, N. Kuster, Automated E-field scanning system for dosimetric assessments, IEEE Transaction on Microwave Theory and Techniques, vol. 44, Jan. 1996, pp. 105-113.
- [8] K. Pokovic, T. Schmid, N. Kuster, Robust setup for precise calibration of E-field probes in tissue simulating liquids at mobile communications frequencies, ICECOM97, Oct. 1997, pp. 1 -124.
- [9] K. Pokovic, T. Schmid, and N. Kuster, E-field Probe with improved isotropy in brain simulating liquids, Proceedings of the ELMAR, Zadar, Croatia, June 23-25, 1996, pp. 172-175.
- [10] Schmid & Partner Engineering AG, Application Note: Data Storage and Evaluation, June 1998, p2.
- [11] V. Hombach, K. Meier, M. Burkhardt, E. Kuhn, N. Kuster, The Dependence of EM Energy Absorption upon Human Modeling at 900 MHz, IEEE Transaction on Microwave Theory and Techniques, vol. 44 no. 10, Oct. 1996, pp. 1865-1873.
- [12] N. Kuster and Q. Balzano, Energy absorption mechanism by biological bodies in the near field of dipole antennas above 300MHz, IEEE Transaction on Vehicular Technology, vol. 41, no. 1, Feb. 1992, pp. 17-23.
- [13] G. Hartsgrove, A. Kraszewski, A. Surowiec, Simulated Biological Materials for Electromagnetic Radiation Absorption Studies, University of Ottawa, Bioelectromagnetics, Canada: 1987, pp. 29-36.
- [14] Q. Balzano, O. Garay, T. Manning Jr., Electromagnetic Energy Exposure of Simulated Users of Portable Cellular Telephones, IEEE Transactions on Vehicular Technology, vol. 44, no.3, Aug. 1995.
- [15] W. Gander, Computermathematik, Birkhaeuser, Basel, 1992.
- [16] W.H. Press, S.A. Teukolsky, W.T. Vetterling, and B.P. Flannery, Numerical Recipes in C, The Art of Scientific Computing, Second edition, Cambridge University Press, 1992.
- [17] N. Kuster, R. Kastle, T. Schmid, Dosimetric evaluation of mobile communications equipment with known precision, IEEE Transaction on Communications, vol. E80-B, no. 5, May 1997, pp. 645-652.

FCC ID: PY7-25682R	SAR EVALUATION REPORT	Approved by: Technical Manager
Document S/N: 1M2302230018-05.PY7 (Rev2)	DUT Type: Portable Handset	Page 73 of 74

REV 22.0
03/30/2022

- [18] CENELEC CLC/SC111B, European Prestandard (prENV 50166-2), Human Exposure to Electromagnetic Fields High-frequency: 10kHz-300GHz, Jan. 1995.
- [19] Prof. Dr. Niels Kuster, ETH, Eidgenössische Technische Hochschule Zürich, Dosimetric Evaluation of the Cellular Phone.
- [20] IEC 62209-1, Measurement procedure for the assessment of specific absorption rate of human exposure to radio frequency fields from hand-held and body-mounted wireless communication devices - Part 1: Devices used next to the ear (Frequency range of 300 MHz to 6 GHz), July 2016.
- [21] Innovation, Science, Economic Development Canada RSS-102 Radio Frequency Exposure Compliance of Radiocommunication Apparatus (All Frequency Bands) Issue 5, March 2015.
- [22] Health Canada Safety Code 6 Limits of Human Exposure to Radio Frequency Electromagnetic Fields in the Frequency Range from 3 kHz – 300 GHz, 2015
- [23] FCC SAR Test Procedures for 2G-3G Devices, Mobile Hotspot and UMPC Devices KDB Publications 941225, D01-D07
- [24] SAR Measurement Guidance for IEEE 802.11 Transmitters, KDB Publication 248227 D01
- [25] FCC SAR Considerations for Handsets with Multiple Transmitters and Antennas, KDB Publications 648474 D03-D04
- [26] FCC SAR Evaluation Considerations for Laptop, Notebook, Netbook and Tablet Computers, FCC KDB Publication 616217 D04
- [27] FCC SAR Measurement and Reporting Requirements for 100MHz – 6 GHz, KDB Publications 865664 D01-D02
- [28] FCC General RF Exposure Guidance and SAR Procedures for Dongles, KDB Publication 447498, D01-D04
- [29] Anexo à Resolução No. 533, de 10 de Setembro de 2009.
- [30] IEC 62209-2, Human exposure to radio frequency fields from hand-held and body-mounted wireless communication devices - Human models, instrumentation, and procedures - Part 2: Procedure to determine the specific absorption rate (SAR) for wireless communication devices used in close proximity to the human body (frequency range of 30 MHz to 6 GHz), Mar. 2010.

FCC ID: PY7-25682R	SAR EVALUATION REPORT	Approved by: Technical Manager
Document S/N: 1M2302230018-05.PY7 (Rev2)	DUT Type: Portable Handset	Page 74 of 74

REV 22.0
03/30/2022