



CERTIFICATION TEST REPORT

Report Number. : 12097277-E2V2

Applicant : SONY MOBILE COMMUNICATIONS INC.
4-12-3 HIGASHI-SHINAGAWA, SHINAGAWA-KU
TOKYO, 140-0002, JAPAN

FCC ID : PY7-72474U

EUT Description : GSM/WCDMA/LTE PHONE with BT, DTS/UNII a/b/g/n/ac & NFC

Test Standard(s) : FCC 47 CFR PART 15 SUBPART C

Date Of Issue:

JANUARY 29, 2018

Prepared by:

UL Verification Services Inc.
47173 Benicia Street
Fremont, CA 94538, U.S.A.
TEL: (510) 771-1000
FAX: (510) 661-0888



Revision History

<u>Rev.</u>	<u>Issue Date</u>	<u>Revisions</u>	<u>Revised By</u>
V1	01/24/18	Initial Issue	Dan Corona
V2	01/29/18	Updated Section 6	Kiya Kedida

TABLE OF CONTENTS

1. ATTESTATION OF TEST RESULTS	5
2. TEST METHODOLOGY	6
3. FACILITIES AND ACCREDITATION	6
4. CALIBRATION AND UNCERTAINTY	7
4.1. MEASURING INSTRUMENT CALIBRATION	7
4.2. SAMPLE CALCULATION	7
4.3. MEASUREMENT UNCERTAINTY	7
5. EQUIPMENT UNDER TEST	8
5.1. DESCRIPTION OF EUT	8
5.2. MAXIMUM OUTPUT POWER	8
5.3. DESCRIPTION OF AVAILABLE ANTENNAS	8
5.4. SOFTWARE AND FIRMWARE	8
5.5. WORST-CASE CONFIGURATION AND MODE	9
5.6. DESCRIPTION OF TEST SETUP	10
6. TEST AND MEASUREMENT EQUIPMENT	13
7. ANTENNA PORT TEST RESULTS	14
7.1. BASIC DATA RATE GFSK MODULATION	15
7.1.1. 20 dB BANDWIDTH	15
7.1.2. 99% BANDWIDTH	18
7.1.3. HOPPING FREQUENCY SEPARATION	21
7.1.4. NUMBER OF HOPPING CHANNELS	22
7.1.5. AVERAGE TIME OF OCCUPANCY	25
7.1.6. OUTPUT POWER	29
7.1.7. AVERAGE POWER	30
7.1.8. CONDUCTED BANDEDGE AND SPURIOUS EMISSIONS	31
7.2. ENHANCED DATA RATE 8PSK MODULATION	36
7.2.1. 20 dB BANDWIDTH	36
7.2.1. 99% BANDWIDTH	39
7.2.2. HOPPING FREQUENCY SEPARATION	42
7.2.3. NUMBER OF HOPPING CHANNELS	43
7.2.4. AVERAGE TIME OF OCCUPANCY	46
7.2.5. OUTPUT POWER	50
7.2.6. AVERAGE POWER	51
7.2.7. CONDUCTED BANDEDGE AND SPURIOUS EMISSIONS	52

8. RADIATED TEST RESULTS	57
8.1. LIMITS AND PROCEDURE	57
8.2. BASIC DATA RATE GFSK MODULATION.....	58
8.2.1. RESTRICTED BANDEDGE (LOW CHANNEL).....	58
8.2.2. AUTHORIZED BANDEDGE (HIGH CHANNEL)	60
8.2.3. HARMONICS AND SPURIOUS EMISSIONS	62
8.3. ENHANCED DATA RATE 8PSK MODULATION.....	68
8.3.1. RESTRICTED BANDEDGE (LOW CHANNEL).....	68
8.3.2. AUTHORIZED BANDEDGE (HIGH CHANNEL)	70
8.3.3. HARMONICS AND SPURIOUS EMISSIONS	72
8.4. WORST-CASE BELOW 30 MHz.....	78
8.5. WORST-CASE BELOW 1 GHz.....	79
8.6. WORST-CASE ABOVE 18 GHz.....	81
9. AC POWER LINE CONDUCTED EMISSIONS.....	83
10. SETUP PHOTOS.....	86

1. ATTESTATION OF TEST RESULTS

COMPANY NAME: SONY MOBILE COMMUNICATIONS INC.
4-12-3 HIGASHI-SHINAGAWA, SHINAGAWA-KU
TOKYO, 140-0002, JAPAN

EUT DESCRIPTION: GSM/WCDMA/LTE PHONE with BT, DTS/UNII a/b/g/n/ac, & NFC

SERIAL NUMBER: RADIATED: BH90006RAY & BH900083AY
CONDUCTED: BH90005MAY & BH9000ALAY

DATE TESTED: December 27, 2017 – JANUARY 10, 2018

APPLICABLE STANDARDS	
STANDARD	TEST RESULTS
CFR 47 Part 15 Subpart C	Complies

UL Verification Services Inc. tested the above equipment in accordance with the requirements set forth in the above standards. All indications of Pass/Fail in this report are opinions expressed by UL Verification Services Inc. based on interpretations and/or observations of test results. Measurement Uncertainties were not taken into account and are published for informational purposes only. The test results show that the equipment tested is capable of demonstrating compliance with the requirements as documented in this report.

Note: The results documented in this report apply only to the tested sample, under the conditions and modes of operation as described herein. This document may not be altered or revised in any way unless done so by UL Verification Services Inc. and all revisions are duly noted in the revisions section. Any alteration of this document not carried out by UL Verification Services Inc. will constitute fraud and shall nullify the document. This report must not be used by the client to claim product certification, approval, or endorsement by NVLAP, NIST, any agency of the Federal Government, or any agency of any government.

Approved & Released For
UL Verification Services Inc. By:



DAN CORONIA
OPERATIONS LEADER
UL VERIFICATION SERVICES INC.

Prepared By:



KIYA KEDIDA
PROEJCT ENGINEER
UL VERIFICATION SERVICES INC.

2. TEST METHODOLOGY

The tests documented in this report were performed in accordance with FCC CFR 47 Part 2, FCC CFR 47 Part 15, ANSI C63.10-2013.

3. FACILITIES AND ACCREDITATION

The test sites and measurement facilities used to collect data are located at 47173 and 47266 Benicia Street, Fremont, California, USA. Line conducted emissions are measured only at the 47173 address. The following table identifies which facilities were utilized for radiated emission measurements documented in this report. Specific facilities are also identified in the test results sections.

47173 Benicia Street	47266 Benicia Street
<input type="checkbox"/> Chamber A(IC: 2324B-1)	<input checked="" type="checkbox"/> Chamber D(IC: 22541-1)
<input checked="" type="checkbox"/> Chamber B(IC: 2324B-2)	<input type="checkbox"/> Chamber E(IC: 22541-2)
<input type="checkbox"/> Chamber C(IC: 2324B-3)	<input type="checkbox"/> Chamber F(IC: 22541-3)
	<input type="checkbox"/> Chamber G(IC: 22541-4)
	<input type="checkbox"/> Chamber H(IC: 22541-5)

The above test sites and facilities are covered under FCC Test Firm Registration # 208313. UL Verification Services Inc. is accredited by NVLAP, Laboratory Code 200065-0. Chambers A through C are covered under Industry Canada company address code 2324B with site numbers 2324B -1 through 2324B-3, respectively. Chambers D through H are covered under Industry Canada company address code 22541 with site numbers 22541 -1 through 22541-5, respectively.

4. CALIBRATION AND UNCERTAINTY

4.1. MEASURING INSTRUMENT CALIBRATION

The measuring equipment utilized to perform the tests documented in this report has been calibrated in accordance with the manufacturer's recommendations, and is traceable to recognized national standards.

4.2. SAMPLE CALCULATION

Where relevant, the following sample calculation is provided:

$$\begin{aligned} \text{Field Strength (dBuV/m)} &= \text{Measured Voltage (dBuV)} + \text{Antenna Factor (dB/m)} + \\ &\text{Cable Loss (dB)} - \text{Preamp Gain (dB)} \\ 36.5 \text{ dBuV} + 18.7 \text{ dB/m} + 0.6 \text{ dB} - 26.9 \text{ dB} &= 28.9 \text{ dBuV/m} \end{aligned}$$

4.3. MEASUREMENT UNCERTAINTY

Where relevant, the following measurement uncertainty levels have been estimated for tests performed on the apparatus:

Parameter	Uncertainty
Worst Case Conducted Disturbance, 9KHz to 0.15 MHz	3.84 dB
Worst Case Conducted Disturbance, 0.15 to 30 MHz	3.65 dB
Worst Case Radiated Disturbance, 9KHz to 30 MHz	3.15 dB
Worst Case Radiated Disturbance, 30 to 1000 MHz	5.36 dB
Worst Case Radiated Disturbance, 1000 to 18000 MHz	4.32 dB
Worst Case Radiated Disturbance, 18000 to 26000 MHz	4.45 dB
Worst Case Radiated Disturbance, 26000 to 40000 MHz	5.24 dB

Uncertainty figures are valid to a confidence level of 95%.

5. EQUIPMENT UNDER TEST

5.1. DESCRIPTION OF EUT

The EUT is a GSM/WCDMA/LTE Phone with BT, DTS/UNII a/b/g/n/ac, & NFC.

5.2. MAXIMUM OUTPUT POWER

The transmitter has a maximum peak conducted output power as follows:

Frequency Range (MHz)	Mode	Output Power (dBm)	Output Power (mW)
2402 - 2480	Basic GFSK	10.57	11.40
2402 - 2480	Enhanced 8PSK	10.12	10.28

5.3. DESCRIPTION OF AVAILABLE ANTENNAS

The radio utilizes the Loop antenna, with the maximum gains:

Frequency Band (GHz)	Antenna Gain (dBi)
2402-2480	-1.90

5.4. SOFTWARE AND FIRMWARE

The firmware installed in the EUT during testing was SONY, s_atp_1_00139_B_10_5.
The test utility software used during testing was Tera Term Ver 4.79.

5.5. WORST-CASE CONFIGURATION AND MODE

Radiated band edge, harmonics, and spurious emissions from 1 GHz to 18GHz were performed with the EUT was set to transmit at the Low/Middle/High channels.

Radiated emission below 30MHz, below 1GHz, above 18GHz, and power line conducted emission were performed with the EUT was set to transmit at the channel with highest output power as worst-case scenario.

The fundamental of the EUT was investigated in three orthogonal orientations X, Y, & Z, using the following two configurations, AC/DC Adapter and headphone. It was determined that X-Axis with only AC/DC Adapter was worst-case orientation; therefore, all final radiated testing was performed with the EUT in X-Axis with AC/DC Adapter orientation.

Worst-case data rates were:

GFSK mode: DH5
8PSK mode: 3-DH5

DQPSK mode has been verified to have the lowest power.

5.6. DESCRIPTION OF TEST SETUP

SUPPORT EQUIPMENT

Support Equipment List				
Description	Manufacturer	Model	Serial Number	FCC ID
Laptop	Lenovo	20B7S0A200	PC015REW	NA
AC Adapter	SONY	1309-8864.1	VB17W46601037	NA
DC Power Supply	Ametek	XT 15-4	T463	NA

I/O CABLES (CONDUCTED TEST)

I/O Cable List						
Cable No	Port	# of identical ports	Connector Type	Cable Type	Cable Length (m)	Remarks
1	Antenna	1	RF	Shielded	0.2	To spectrum Analyzer
2	USB	1	USB	Shielded	1	N/A
3	DC	1	DC	Shielded	0.3	N/A

I/O CABLES (RADIATED AND CONDUCTED EMISSIONS)

I/O Cable List						
Cable No	Port	# of identical ports	Connector Type	Cable Type	Cable Length (m)	Remarks
1	USB	1	USB	Shielded	3	N/A

TEST SETUP

CONDCUTED TEST SETUP DIAGRAM

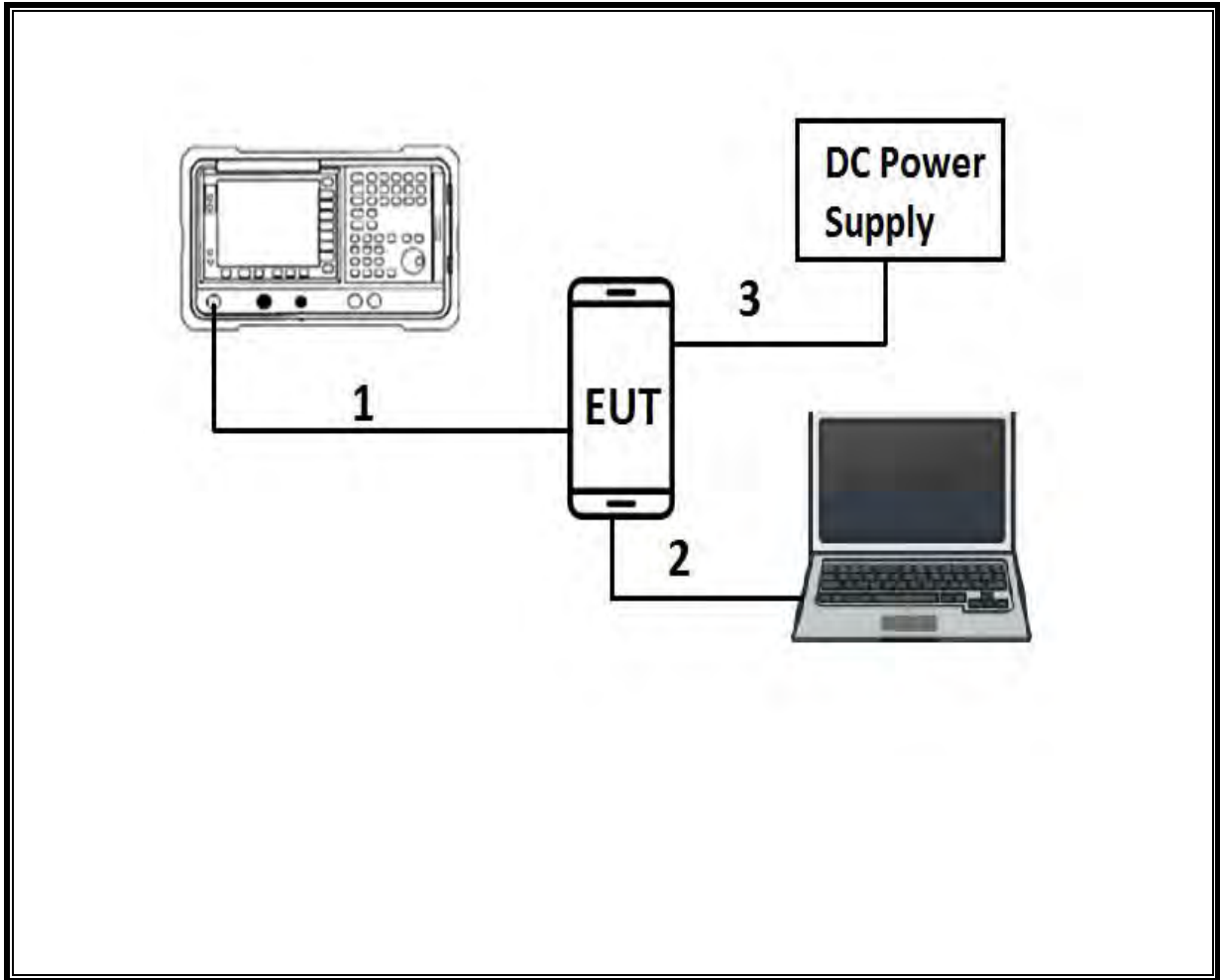

TEST SETUP

RADIATED AND AC LINE CONDUCTED EMISSIONS SETUP DIAGRAM

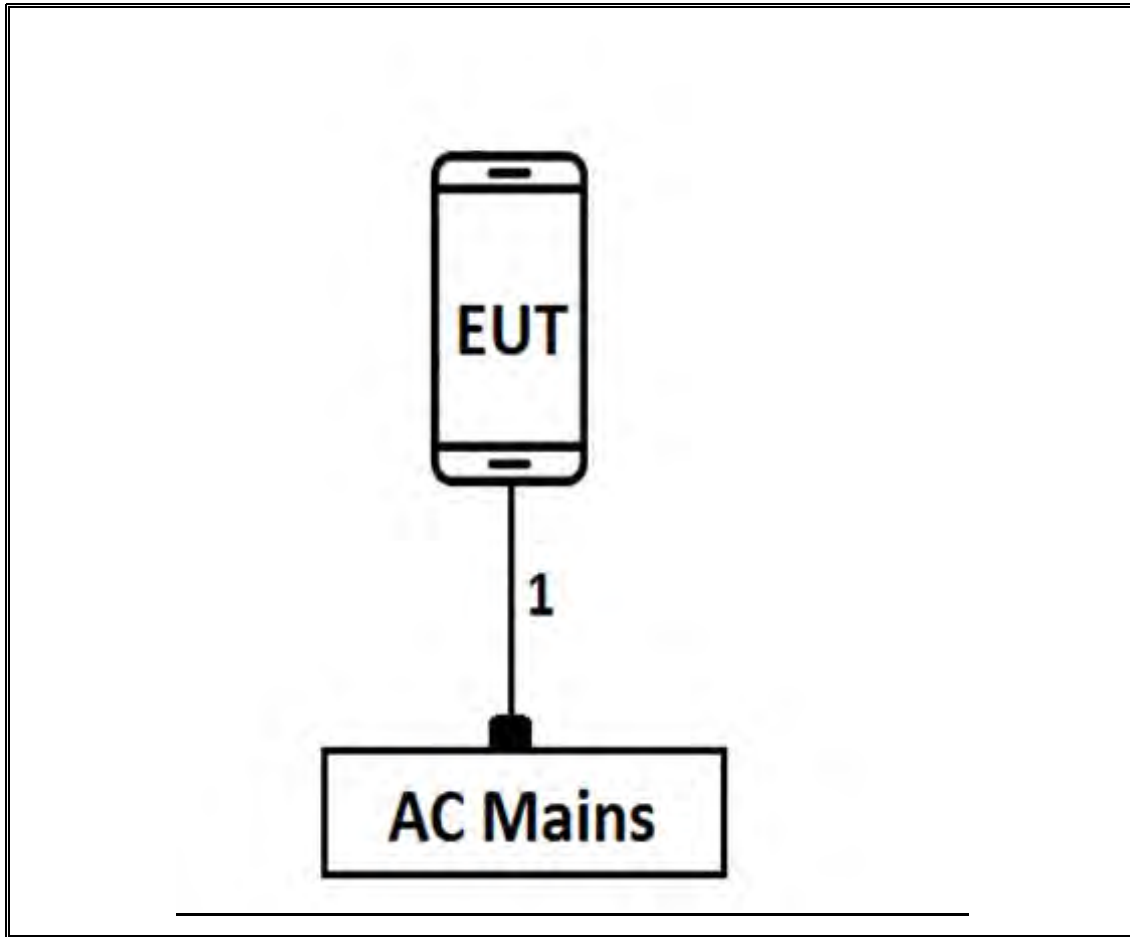

6. TEST AND MEASUREMENT EQUIPMENT

The following test and measurement equipment was utilized for the tests documented in this report:

TEST EQUIPMENT LIST				
Description	Manufacturer	Model	Asset	Cal Due
Antenna, Broadband Hybrid, 30MHz to 2000MHz	Sunol Sciences	JB3	T899	06/15/2018
Antenna, Active Loop 9kHz-30MHz	Com-Power Corp.	AL-130R	T1866	10/10/2018
Antenna, Horn 1-18GHz	ETS-Lindgren	3117	T711	01/30/2018
Antenna, Horn 18-26.5GHz	ARA	MWH-1826	T89	01/18/2019
Power Meter, P-series single channel	Agilent (Keysight) Technologies	N1911A	T1268	06/15/2018
Power Sensor, P – series, 50MHz to 18GHz, Wideband	Agilent (Keysight) Technologies	N1921A	T1223	03/29/2018
Amplifier, 1 - 18GHz	MITEQ	AFS42-00101800-25-S-42	T740	12/30/2018
Pre Amplifier, 1-26.5GHz	Agilent	8449B	T404	7/23/2018
Amplifier, 10kHz-1GHz	Agilent (Keysight) Technologies	8447D	T15	08/14/2018
Spectrum Analyzer, PXA, 3Hz to 44GHz	Agilent (Keysight) Technologies	N9030A	T1210	07/17/2018
Spectrum Analyzer, PXA, 3Hz to 44GHz	Agilent (Keysight) Technologies	N9030A	T905	01/11/2018
Spectrum Analyzer, PXA, 3Hz to 44GHz	Agilent (Keysight) Technologies	N9030A	T907	01/23/2018
Test Receiver, EMI, 10Hz-7GHz	Rhode&Schwarz	ESR	T1436	01/06/2018
LISN	FISCHER	FCC-LISN-50/250-25-2-01	T1310	01/17/2018

Test Software List			
Description	Manufacturer	Model	Version
Radiated Software	UL	UL EMC	Ver 9.5, Dec 01, 2016
Conducted Software	UL	UL EMC	Ver 9.5, May 26, 2015
Antenna Port Software	UL	UL RF	Ver 7.7, Dec 14, 2017

NOTE: *testing is completed before equipment calibration expiration date.

7. ANTENNA PORT TEST RESULTS

ON TIME AND DUTY CYCLE

LIMITS

None; for reporting purposes only.

PROCEDURE

KDB 558074 Zero-Span Spectrum Analyzer Method.

ON TIME AND DUTY CYCLE RESULTS

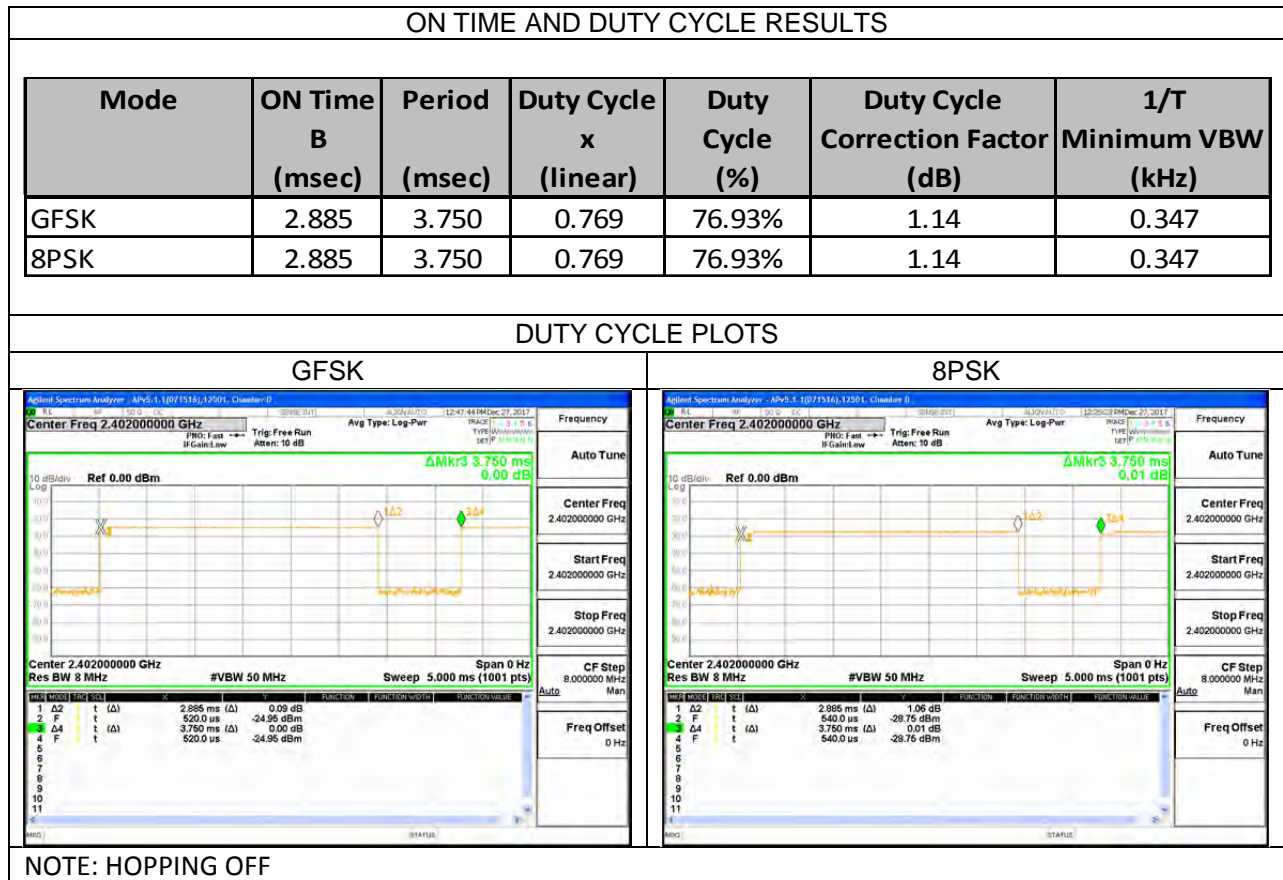

7.1. BASIC DATA RATE GFSK MODULATION

7.1.1. 20 dB BANDWIDTH

LIMITS

None; for reporting purposes only.

TEST PROCEDURE

The transmitter output is connected to a spectrum analyzer. The RBW is set to $\geq 1\%$ of the 20 dB bandwidth. The VBW is set to \geq RBW. The sweep time is coupled.

RESULTS

Channel	Frequency (MHz)	20 dB Bandwidth (KHz)
Low	2402	888
Middle	2441	878
High	2480	926

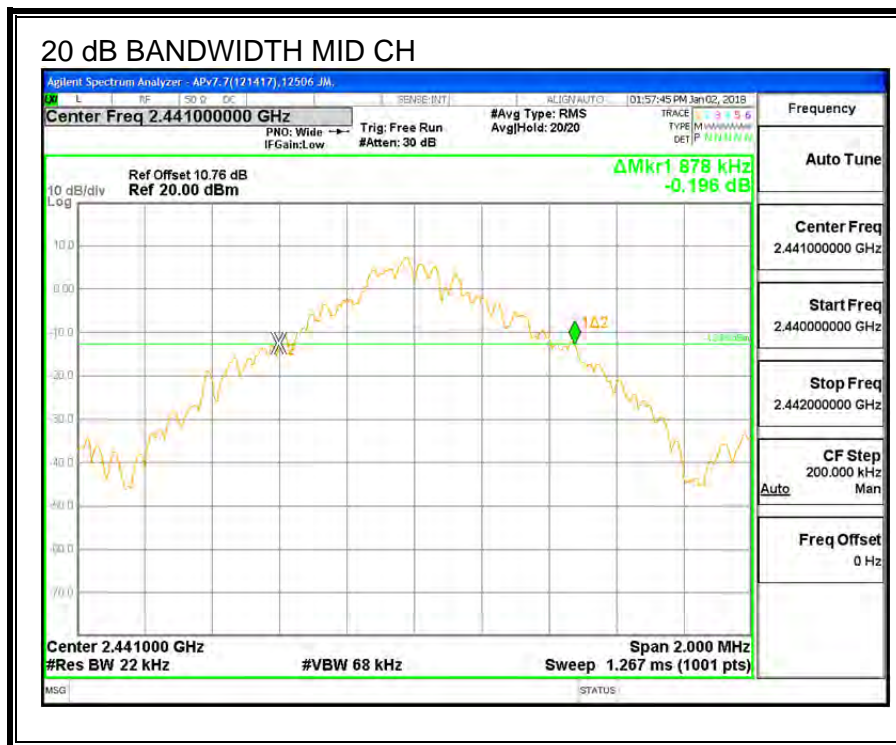
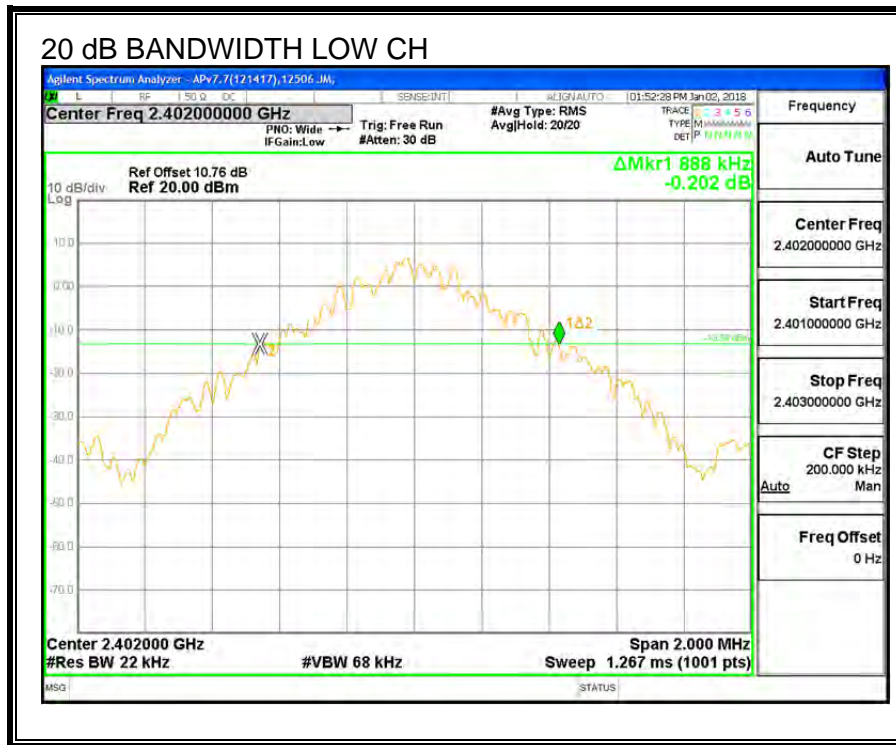

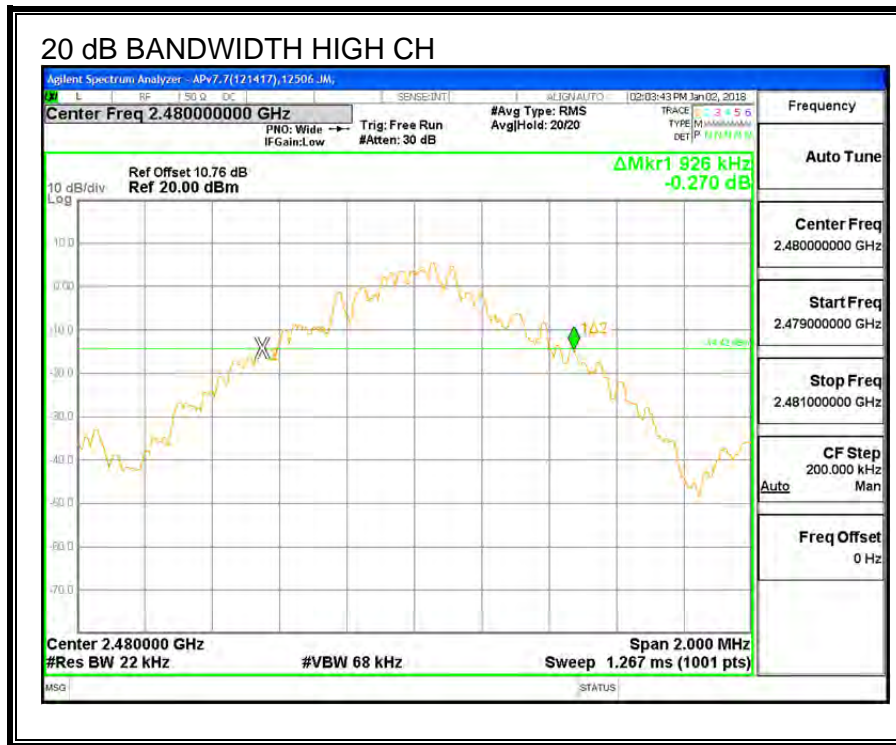

7.1.2. 99% BANDWIDTH

LIMITS

None; for reporting purposes only.

TEST PROCEDURE

The transmitter output is connected to a spectrum analyzer. The RBW is set to 1%-5% the OBW. The VBW is set to ≥ 3 times RBW. The sweep time is coupled.

RESULTS

Channel	Frequency (MHz)	99% Bandwidth (KHz)
Low	2402	833.24
Middle	2441	830.22
High	2480	837.56

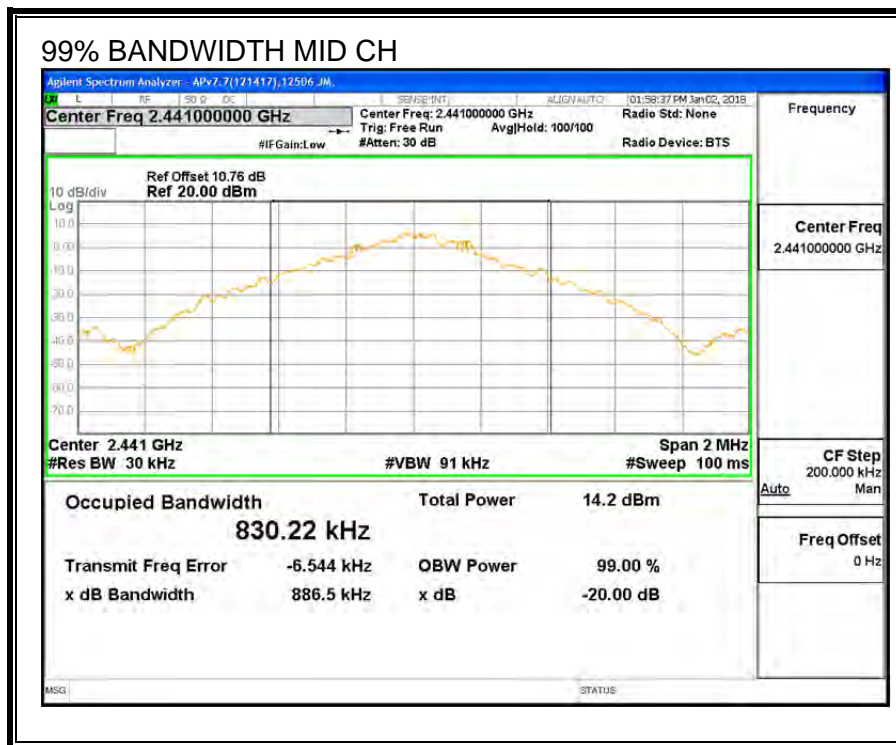
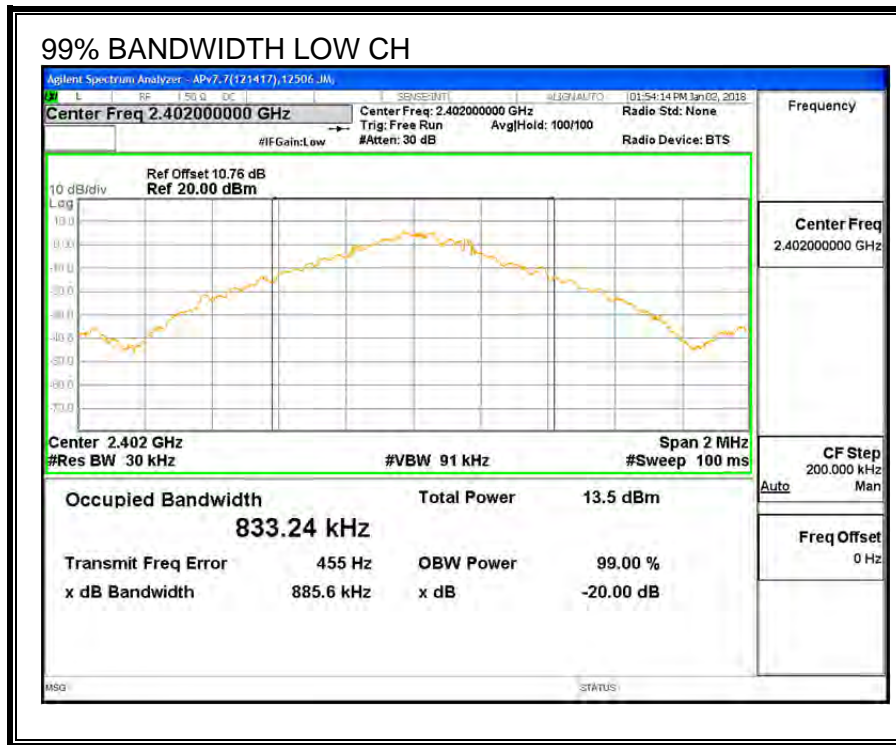

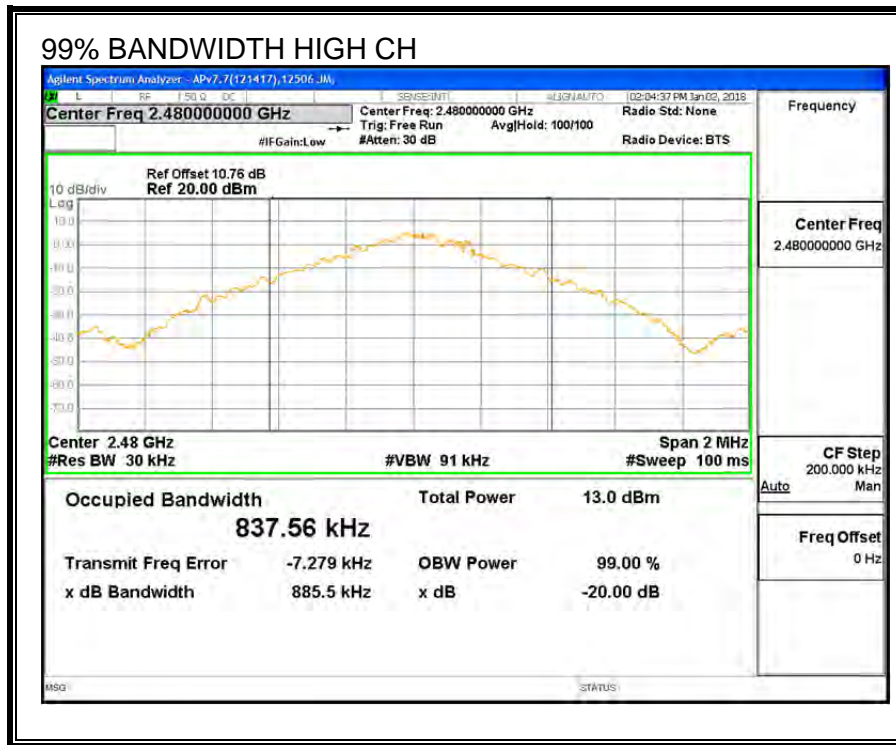

7.1.3. HOPPING FREQUENCY SEPARATION

LIMITS

FCC §15.247 (a) (1)

Frequency hopping systems shall have hopping channel carrier frequencies separated by a minimum of 25 kHz or the 20 dB bandwidth of the hopping channel, whichever is greater.

Alternatively, frequency hopping systems operating in the 2400-2483.5 MHz band may have hopping channel carrier frequencies that are separated by 25 kHz or two-thirds of the 20 dB bandwidth of the hopping channel, whichever is greater, provided the systems operate with an output power no greater than 125 mW.

TEST PROCEDURE

The transmitter output is connected to a spectrum analyzer. The RBW is set to 300 kHz and the VBW is set to 910 kHz. The sweep time is coupled.

RESULTS

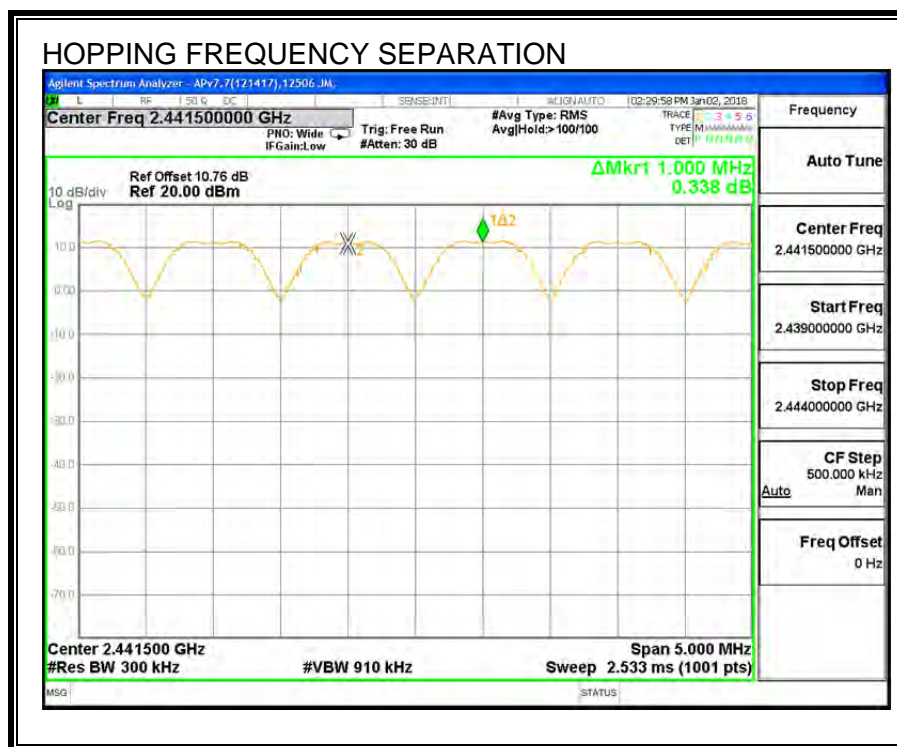

7.1.4. NUMBER OF HOPPING CHANNELS

LIMITS

FCC §15.247 (a) (1) (iii)

Frequency hopping systems in the 2400 – 2483.5 MHz band shall use at least 15 non-overlapping channels.

TEST PROCEDURE

The transmitter output is connected to a spectrum analyzer. The span is set to cover the entire authorized band, in either a single sweep or in multiple contiguous sweeps. The RBW is set to a maximum of 1 % of the span. The analyzer is set to Max Hold.

RESULTS

Normal Mode: 79 Channels observed.

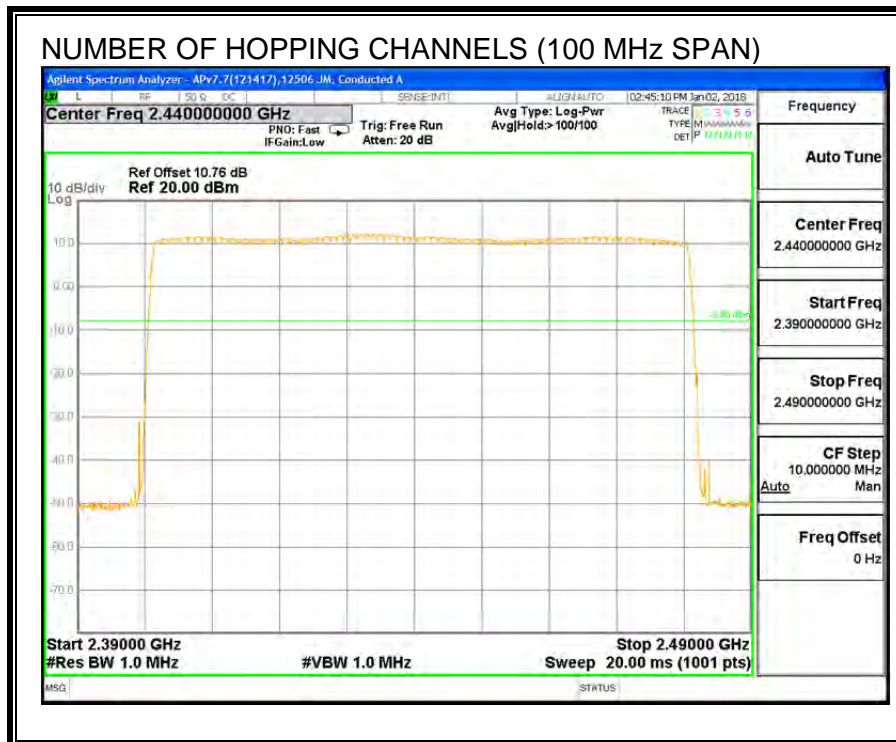

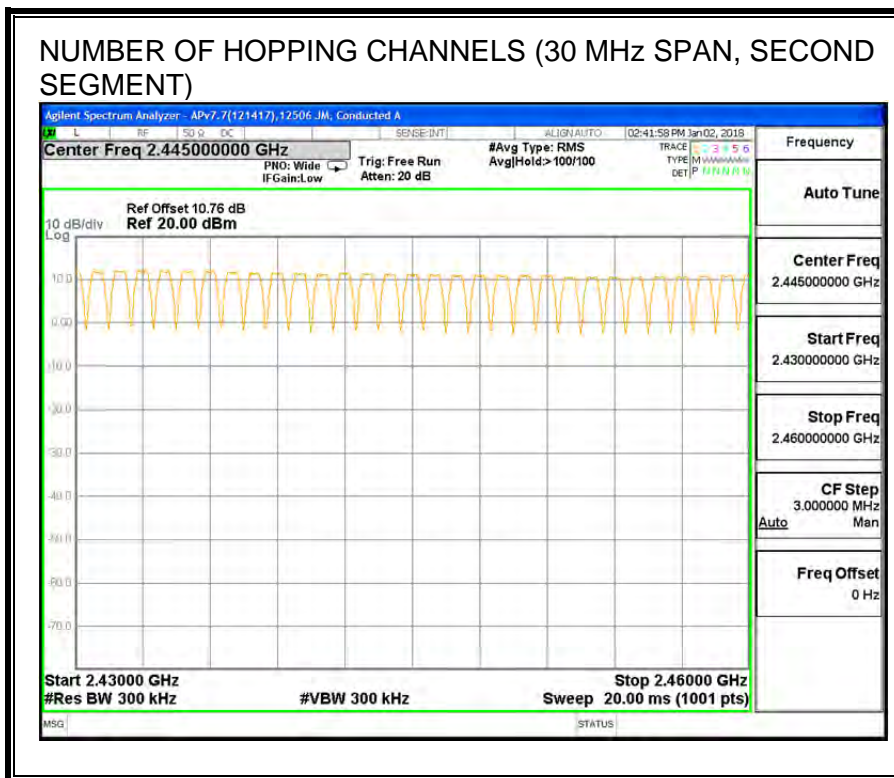
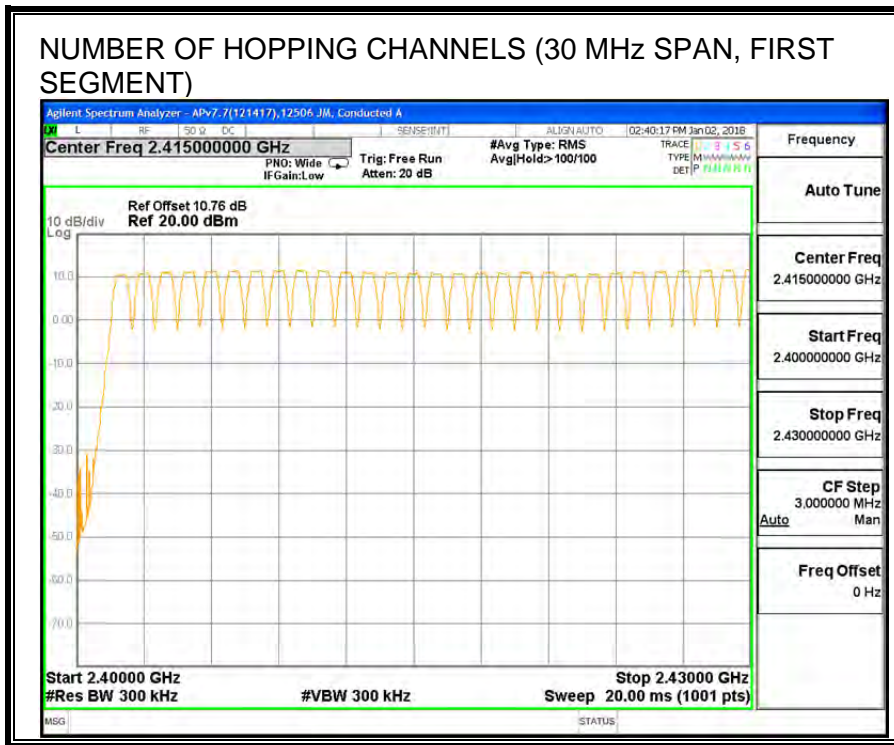

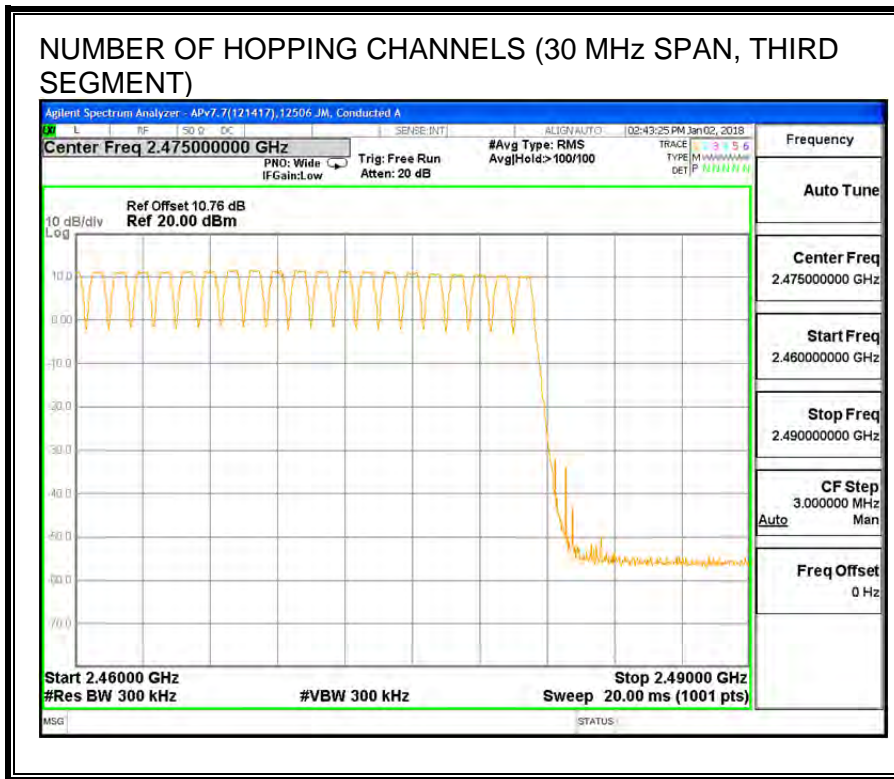

7.1.5. AVERAGE TIME OF OCCUPANCY

LIMITS

FCC §15.247 (a) (1) (iii)

The average time of occupancy on any channel shall not be greater than 0.4 seconds within a period of 0.4 seconds multiplied by the number of hopping channels employed.

TEST PROCEDURE

The transmitter output is connected to a spectrum analyzer. The span is set to 0 Hz, centered on a single, selected hopping channel. The width of a single pulse is measured in a fast scan. The number of pulses is measured in a 3.16 second scan, to enable resolution of each occurrence.

The average time of occupancy in the specified 31.6 second period (79 channels * 0.4 s) is equal to $10 * (\# \text{ of pulses in } 3.16 \text{ s}) * \text{ pulse width}$.

For AFH mode, the average time of occupancy in the specified 8 second period (20 channels * 0.4 seconds) is equal to $10 * (\# \text{ of pulses in } 0.8 \text{ s}) * \text{ pulse width}$.

RESULTS

AVERAGE TIME OF OCCUPANCY					
DH Packet	Pulse Width (msec)	Number of Pulses in 3.16 seconds	Average Time of Occupancy (sec)	Limit (sec)	Margin (sec)
GFSK Normal Mode					
DH1	0.383	32	0.1224	0.4	-0.2776
DH3	1.639	13	0.2131	0.4	-0.1869
DH5	2.887	9	0.2598	0.4	-0.1402
DH Packet	Pulse Width (sec)	Number of Pulses in 0.8 seconds	Average Time of Occupancy (sec)	Limit (sec)	Margin (sec)
GFSK AFH Mode					
DH1	0.383	8	0.03061	0.4	-0.3694
DH3	1.639	3.25	0.05327	0.4	-0.3467
DH5	2.887	2.25	0.06496	0.4	-0.3350
NOTE: --					

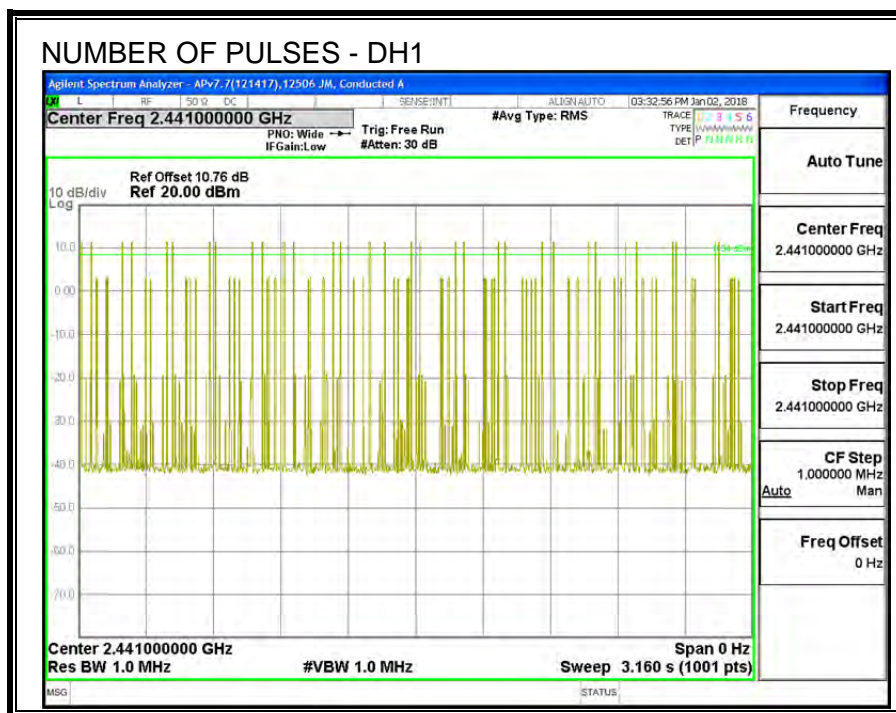
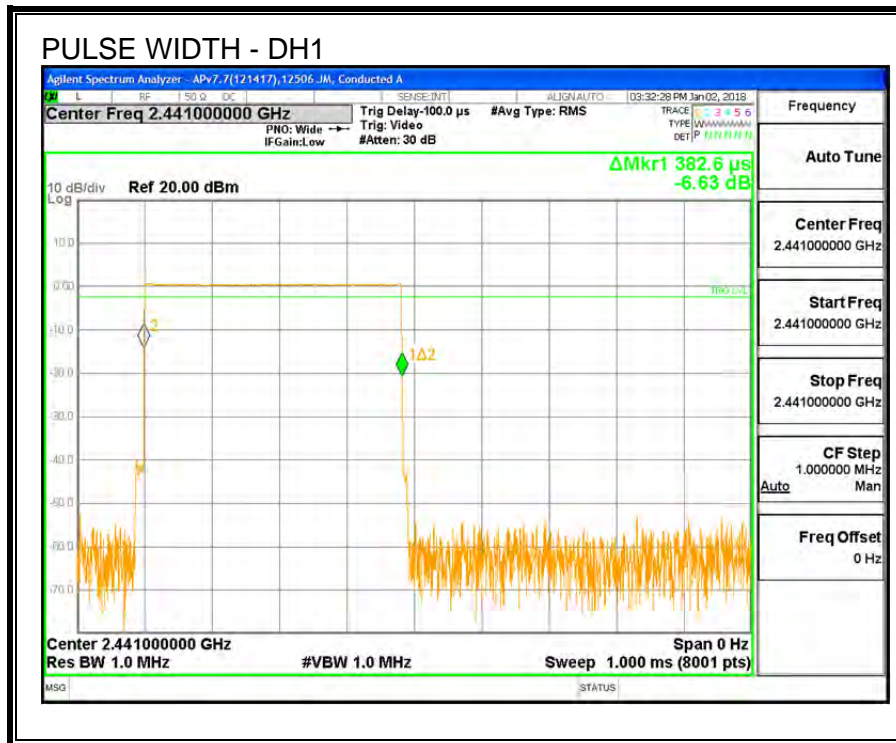

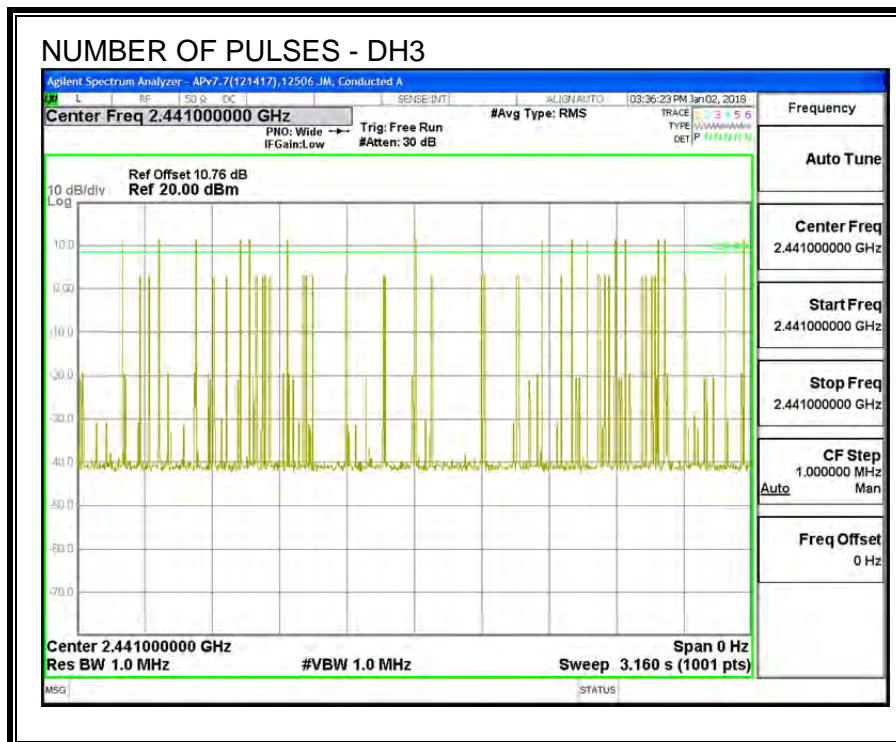
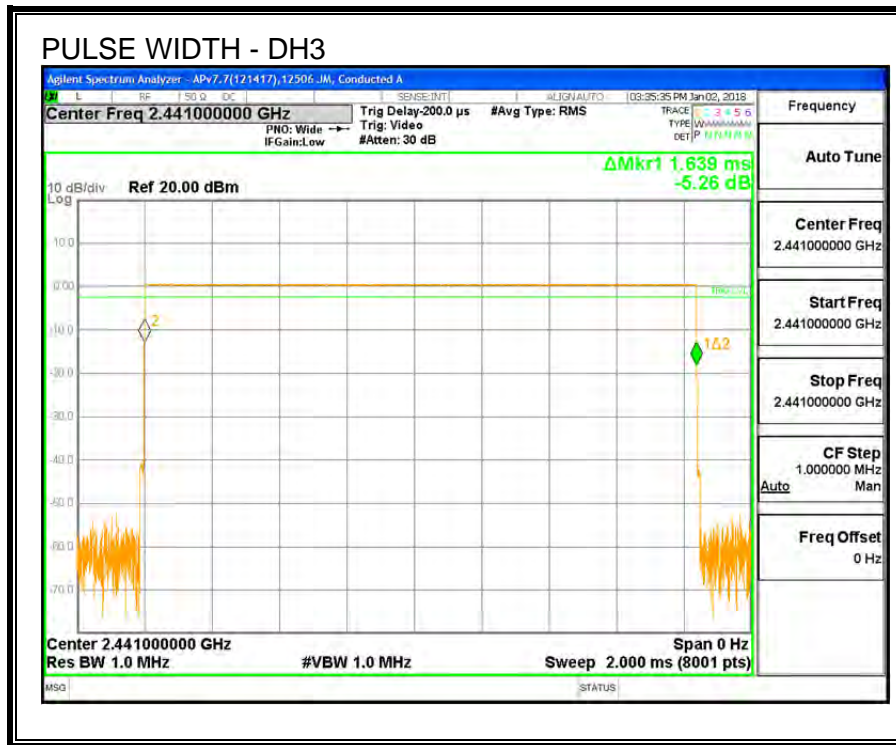

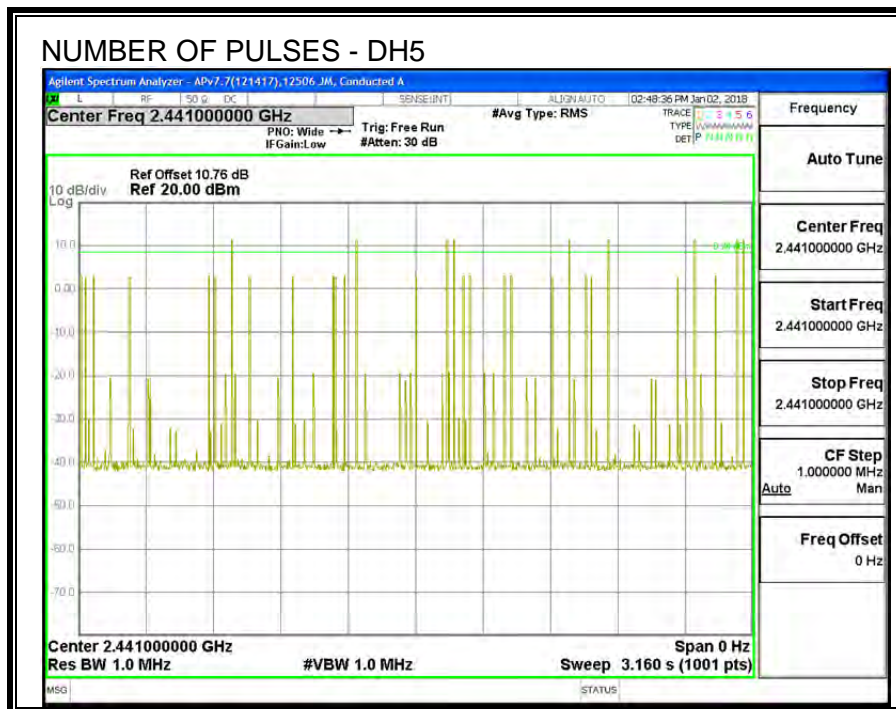
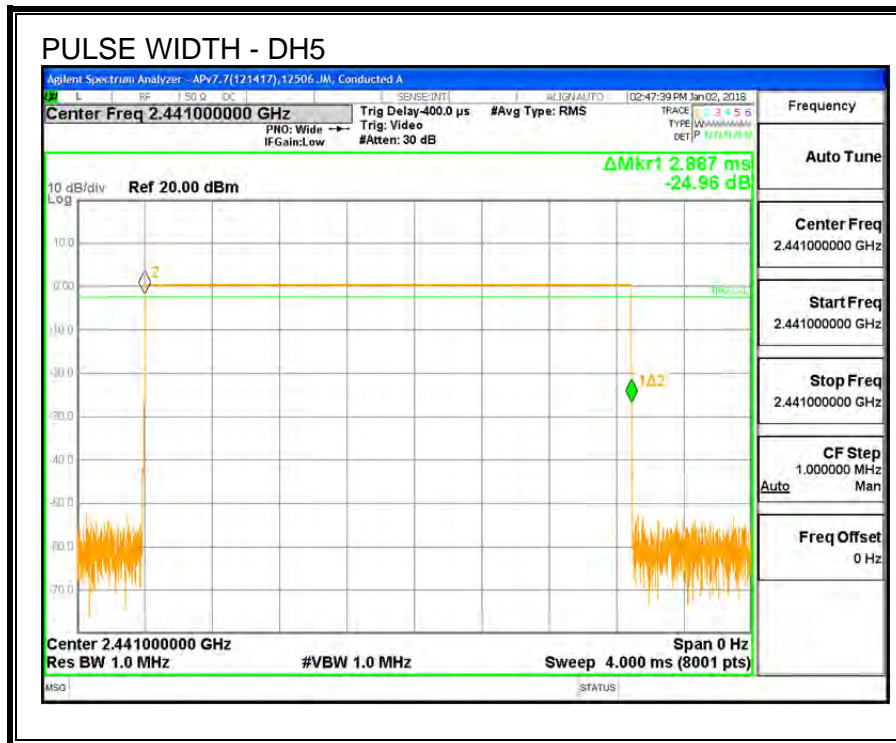

7.1.6. OUTPUT POWER

LIMITS

§15.247 (b) (1)

The maximum antenna gain is less than 6 dBi, therefore the limit is 30 dBm.

TEST PROCEDURE

The transmitter output is connected to a power meter.

The cable assembly insertion loss of 10.6 dB (consisting of 10 dB pad and 0.6 dB cable) is entered as an offset in the power meter to enable direct reading of the power. The power meter is gated to measure peak power during the ON time of the transmitter.

RESULTS

TEST ENGINEER:	12506 JM	Date:	01/05/2018
-----------------------	----------	--------------	------------

Channel	Frequency (MHz)	Output Power (dBm)	Limit (dBm)	Margin (dB)
Low	2402	10.27	30	-19.73
Middle	2441	10.57	30	-19.43
High	2480	10.43	30	-19.57

7.1.7. AVERAGE POWER

LIMITS

None; for reporting purposes only.

TEST PROCEDURE

The transmitter output is connected to a power meter.

The cable assembly insertion loss of 10.6 dB (consisting of 10 dB pad and 0.6 dB cable) is entered as an offset in the power meter to enable direct reading of the power. The power meter is gated to measure average power during the ON time of the transmitter.

RESULTS

TEST ENGINEER:	12506 JM	Date:	01/05/2018
-----------------------	----------	--------------	------------

Channel	Frequency (MHz)	Average Power (dBm)
Low	2402	10.19
Middle	2441	10.48
High	2480	10.35

7.1.8. CONDUCTED BANDEDGE AND SPURIOUS EMISSIONS

LIMITS

FCC §15.247 (d)

IC RSS-210 A8.5

TEST PROCEDURE

The transmitter output is connected to a spectrum analyzer. The resolution bandwidth is set to 100 kHz. The video bandwidth is set to 300 kHz.

The spectrum from 30 MHz to 26 GHz is investigated with the transmitter set to the lowest, middle, and highest channels.

The bandedges at 2.4 and 2.4835 GHz are investigated with the transmitter set to the normal hopping mode.

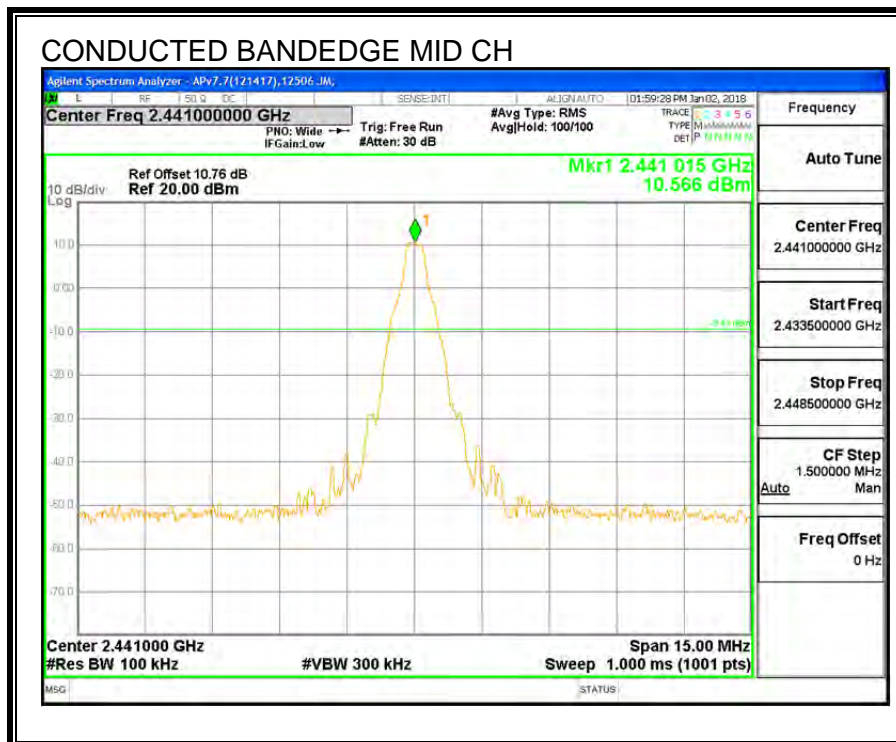
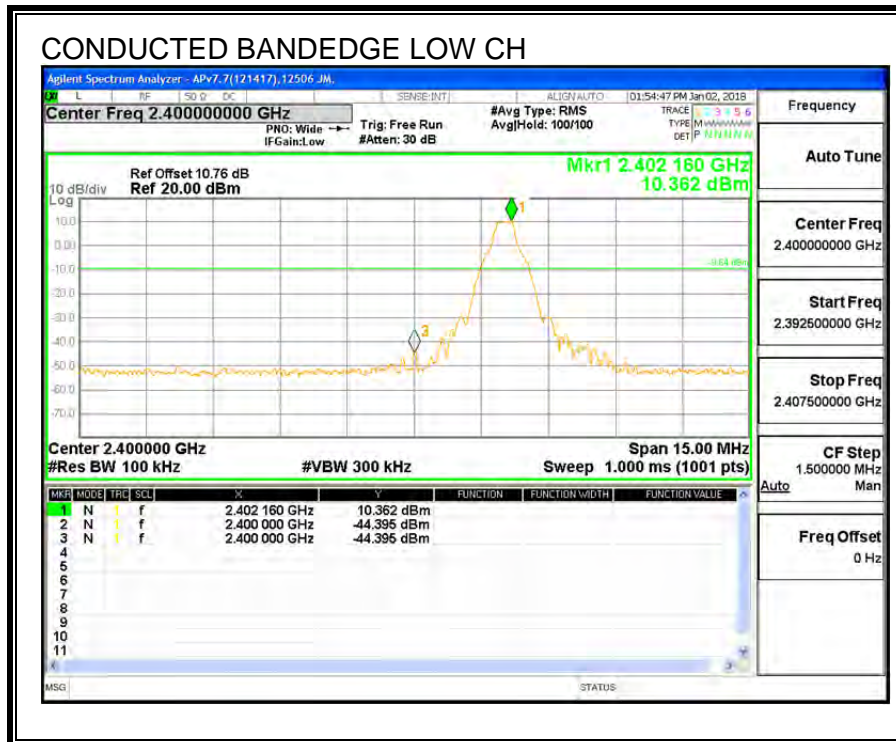

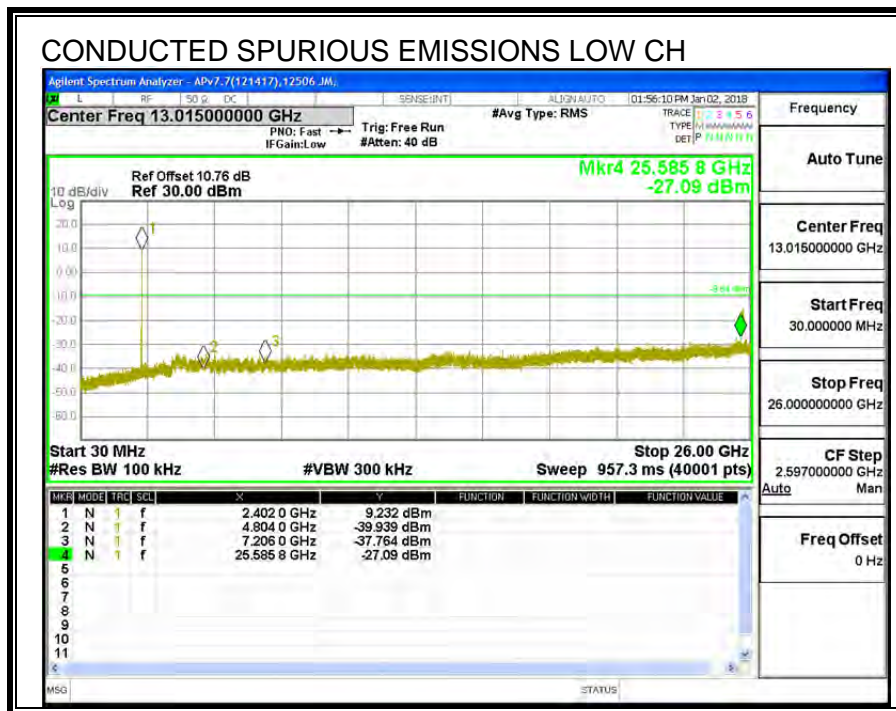
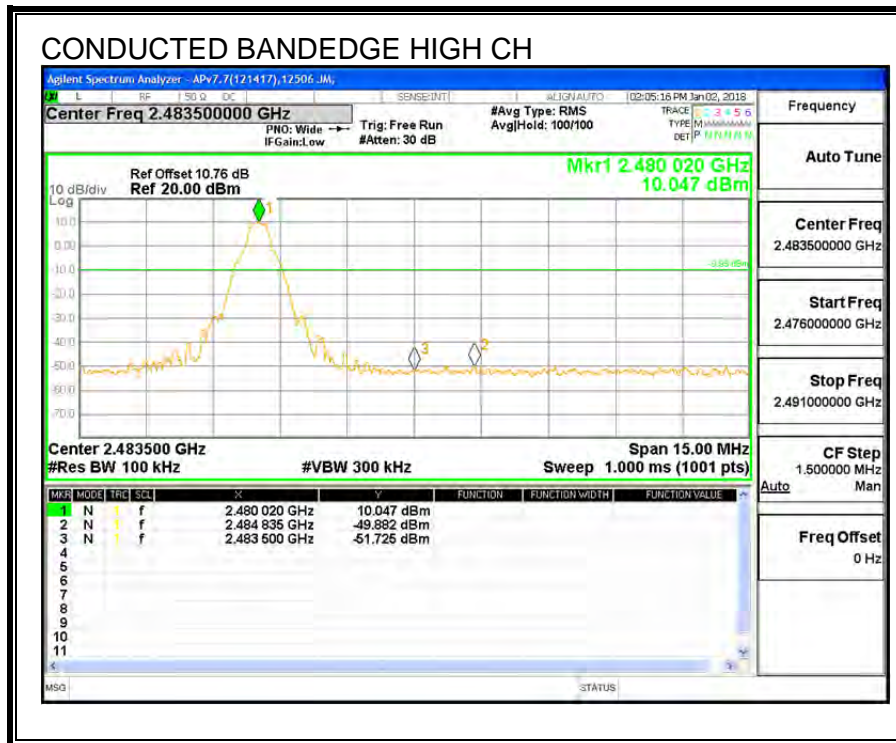

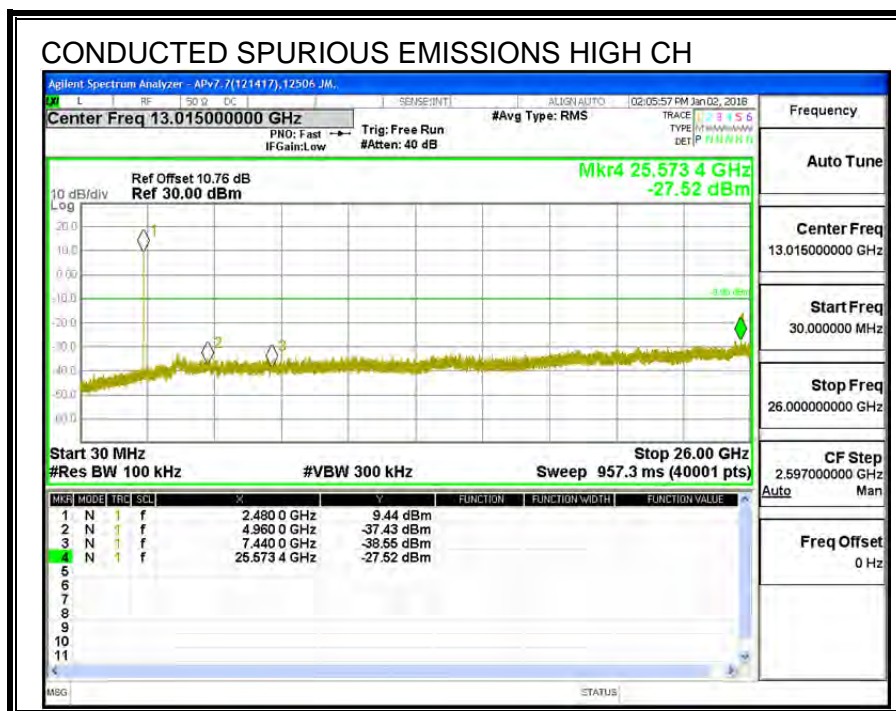
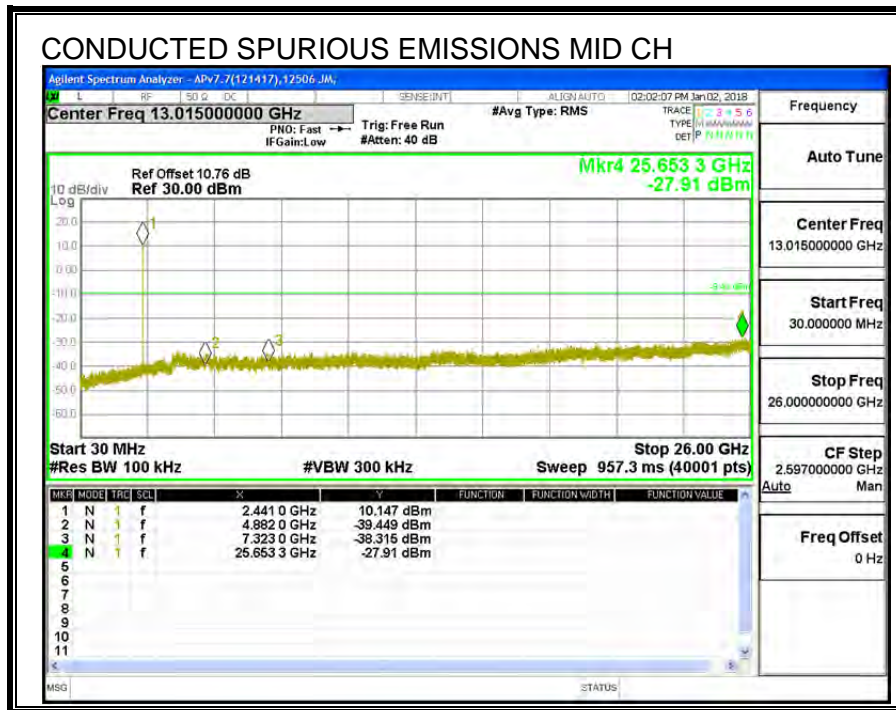

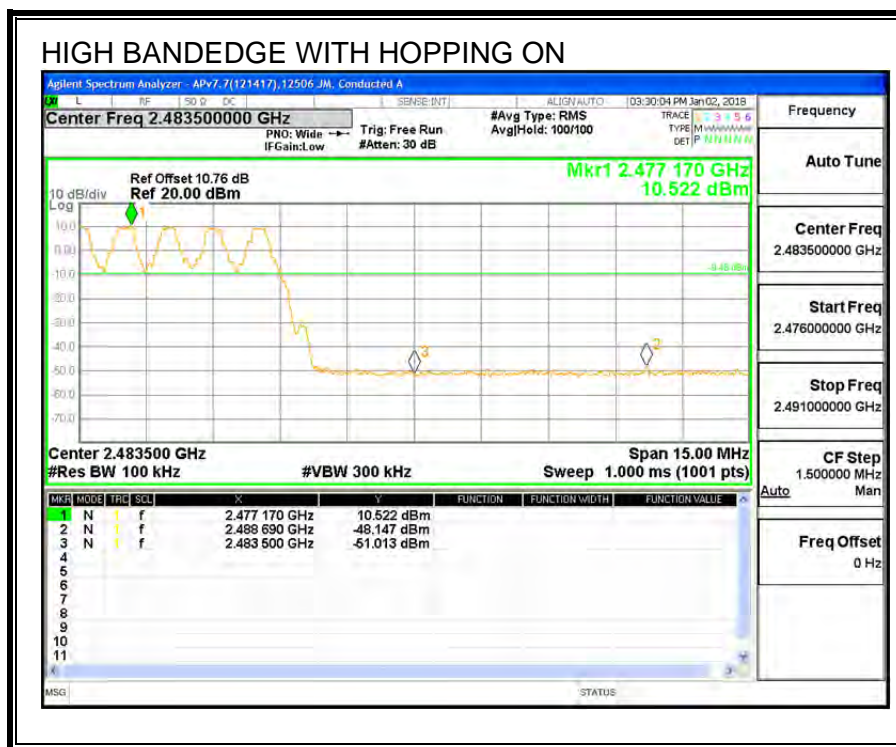
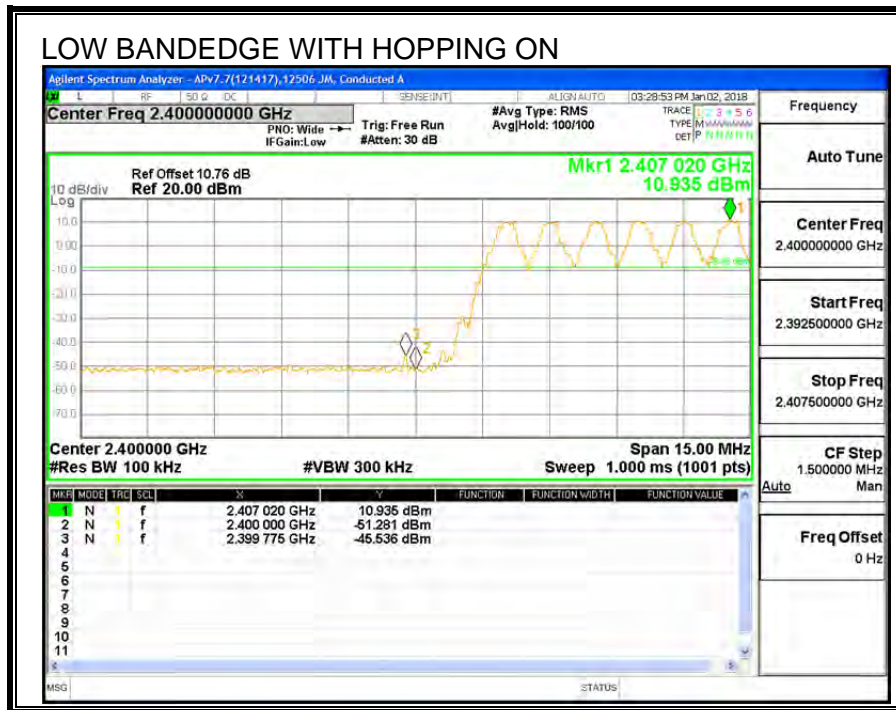

7.2. ENHANCED DATA RATE 8PSK MODULATION

7.2.1. 20 dB BANDWIDTH

LIMITS

None; for reporting purposes only.

TEST PROCEDURE

The transmitter output is connected to a spectrum analyzer. The RBW is set to $\geq 1\%$ of the 20 dB bandwidth. The VBW is set to \geq RBW. The sweep time is coupled.

RESULTS

Channel	Frequency (MHz)	20 dB Bandwidth (MHz)
Low	2402	1.322
Middle	2441	1.344
High	2480	1.324

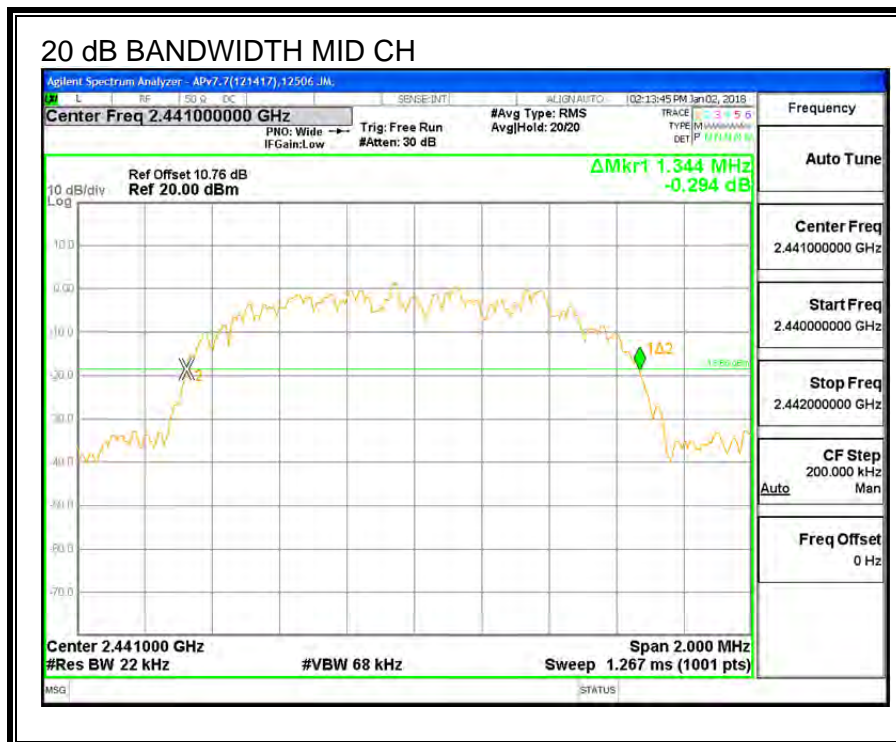
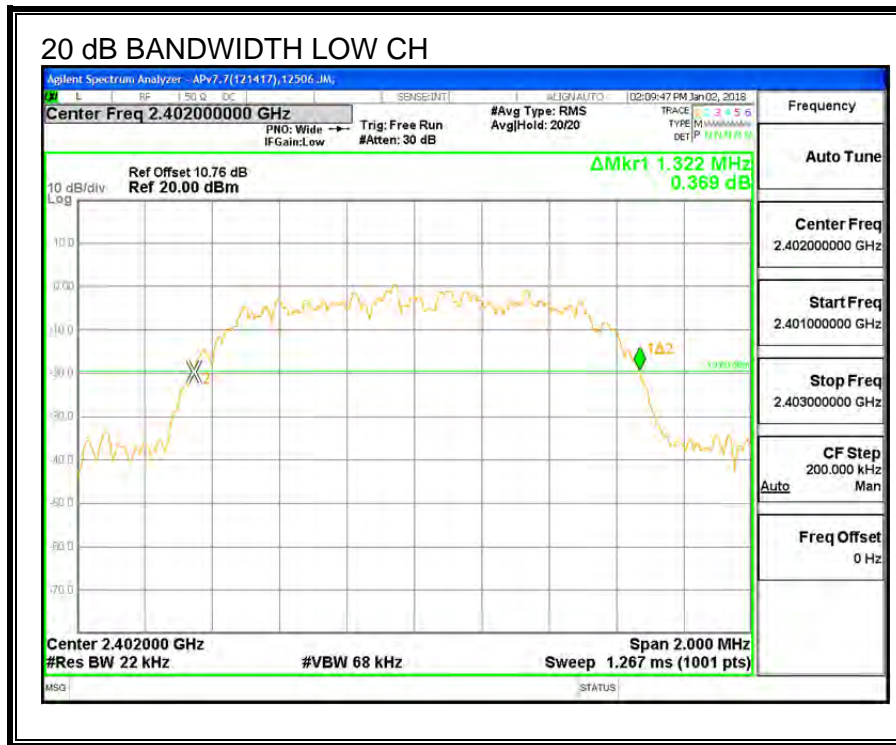

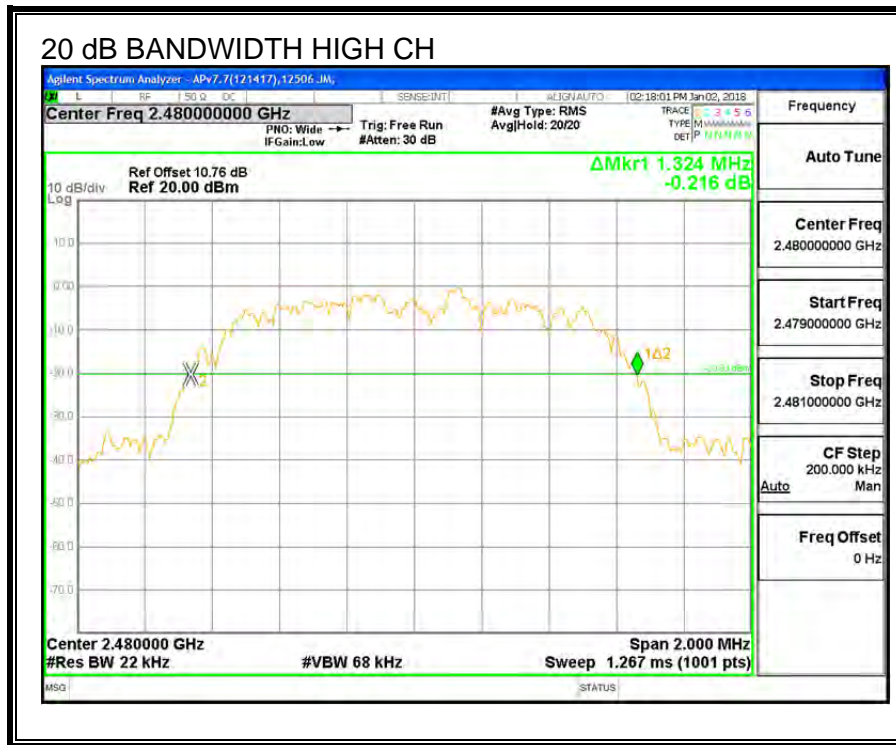

7.2.1. 99% BANDWIDTH

LIMITS

None; for reporting purposes only.

TEST PROCEDURE

The transmitter output is connected to a spectrum analyzer. The RBW is set to 1%-5% the OBW. The VBW is set to ≥ 3 times RBW. The sweep time is coupled.

RESULTS

Channel	Frequency (MHz)	99% Bandwidth (MHz)
Low	2402	1.1927
Middle	2441	1.1930
High	2480	1.1906

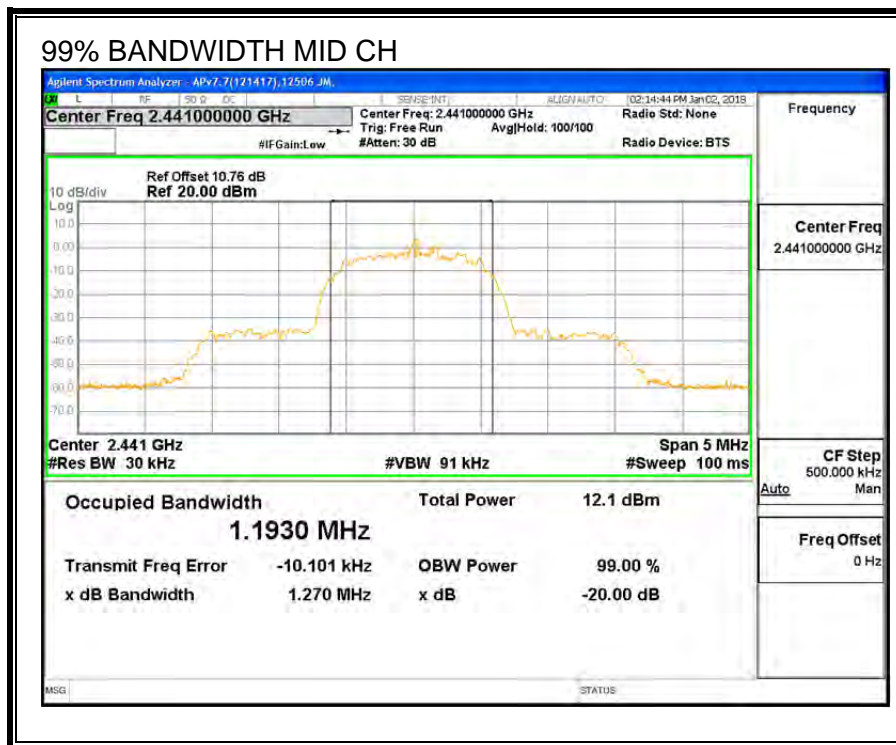
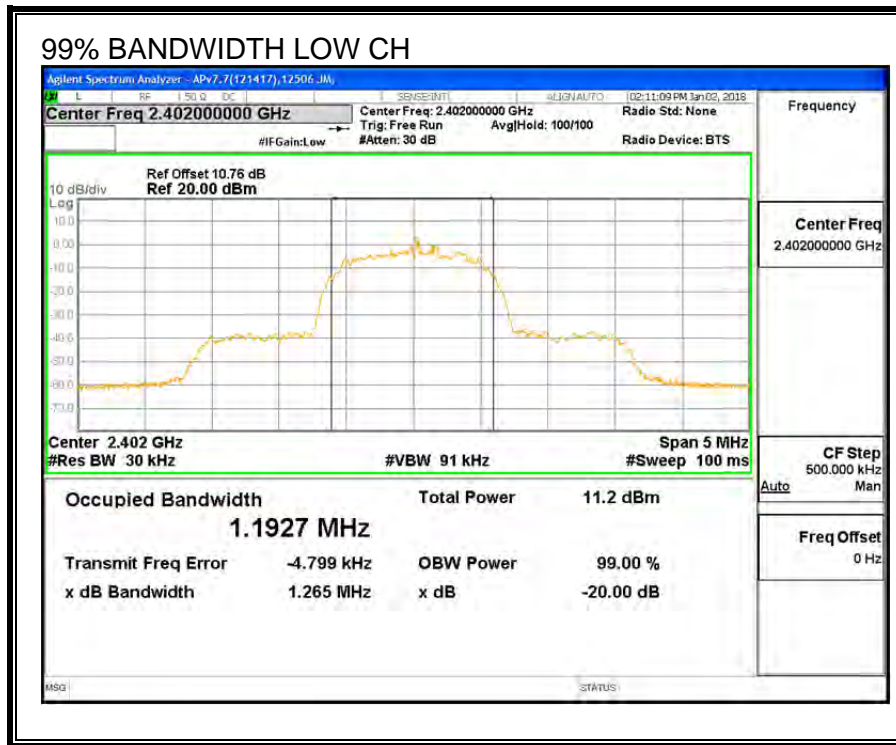

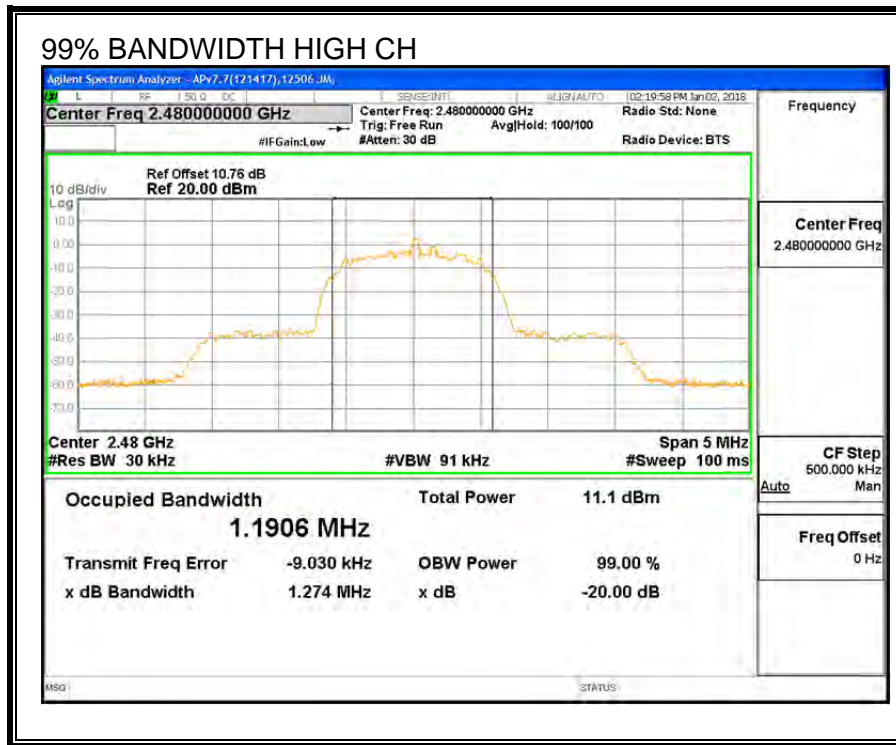

7.2.2. HOPPING FREQUENCY SEPARATION

LIMITS

FCC §15.247 (a) (1)

Frequency hopping systems shall have hopping channel carrier frequencies separated by a minimum of 25 kHz or the 20 dB bandwidth of the hopping channel, whichever is greater.

Alternatively, frequency hopping systems operating in the 2400-2483.5 MHz band may have hopping channel carrier frequencies that are separated by 25 kHz or two-thirds of the 20 dB bandwidth of the hopping channel, whichever is greater, provided the systems operate with an output power no greater than 125 mW.

TEST PROCEDURE

The transmitter output is connected to a spectrum analyzer. The RBW is set to 300 kHz and the VBW is set to 910 kHz. The sweep time is coupled.

RESULTS

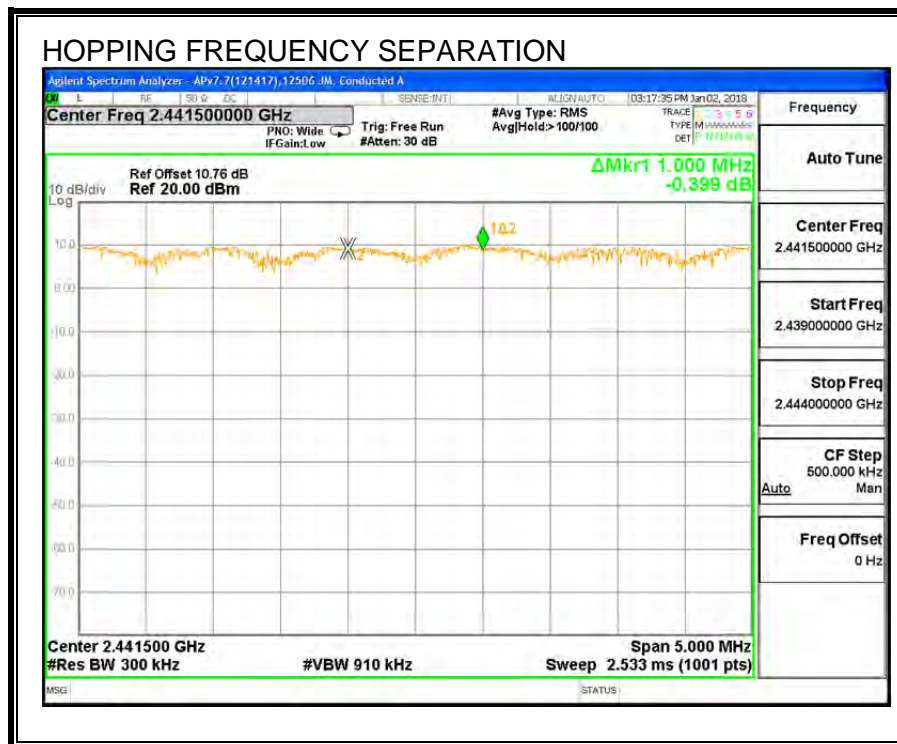

7.2.3. NUMBER OF HOPPING CHANNELS

LIMITS

FCC §15.247 (a) (1) (iii)

Frequency hopping systems in the 2400 – 2483.5 MHz band shall use at least 15 non-overlapping channels.

TEST PROCEDURE

The transmitter output is connected to a spectrum analyzer. The span is set to cover the entire authorized band, in either a single sweep or in multiple contiguous sweeps. The RBW is set to a maximum of 1 % of the span. The analyzer is set to Max Hold.

RESULTS

Normal Mode: 79 Channels observed.

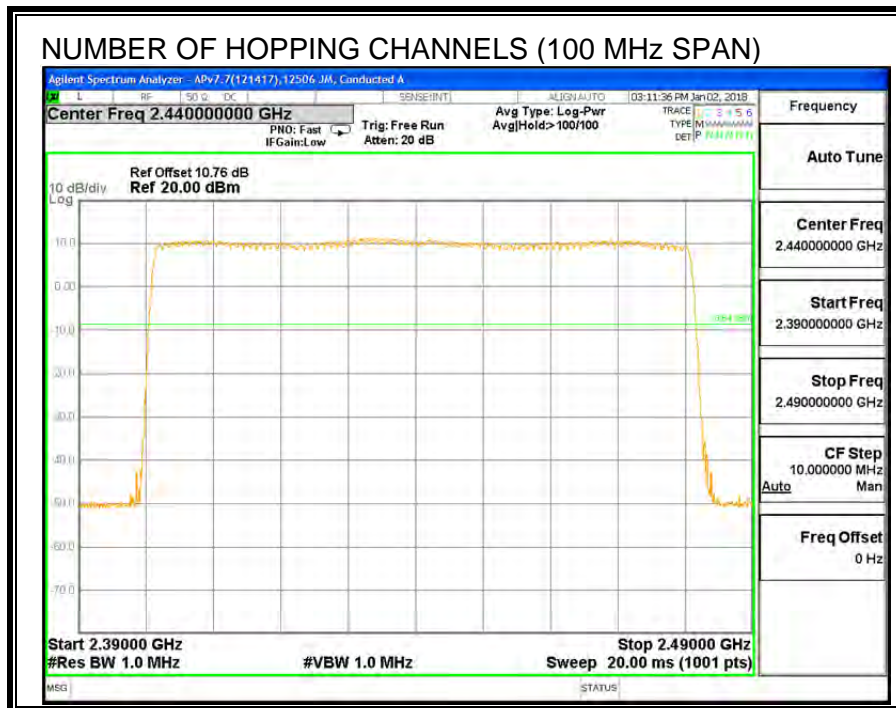

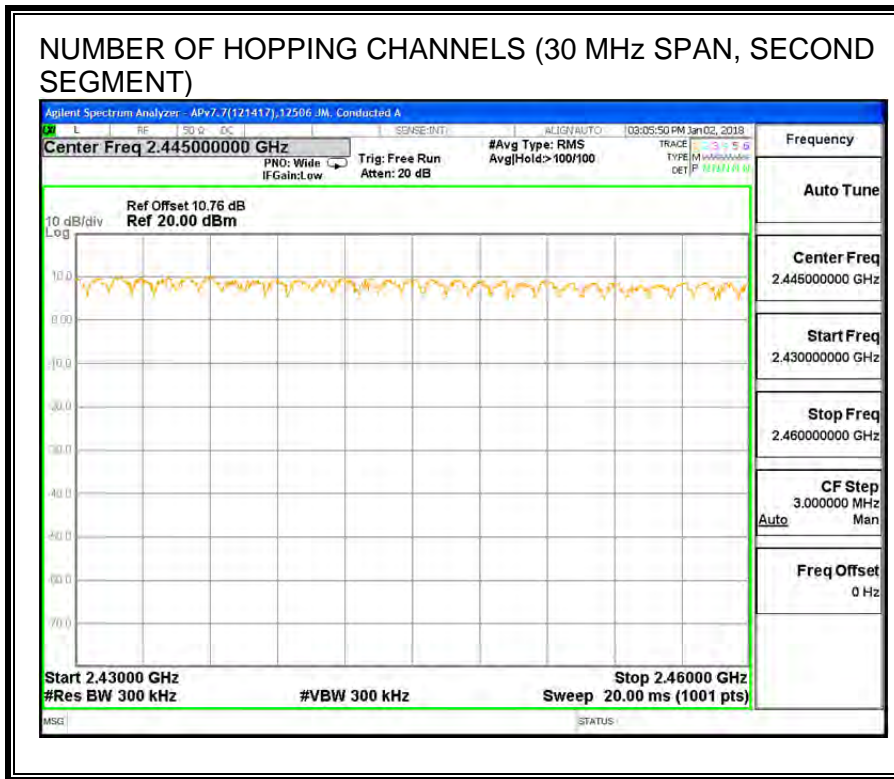
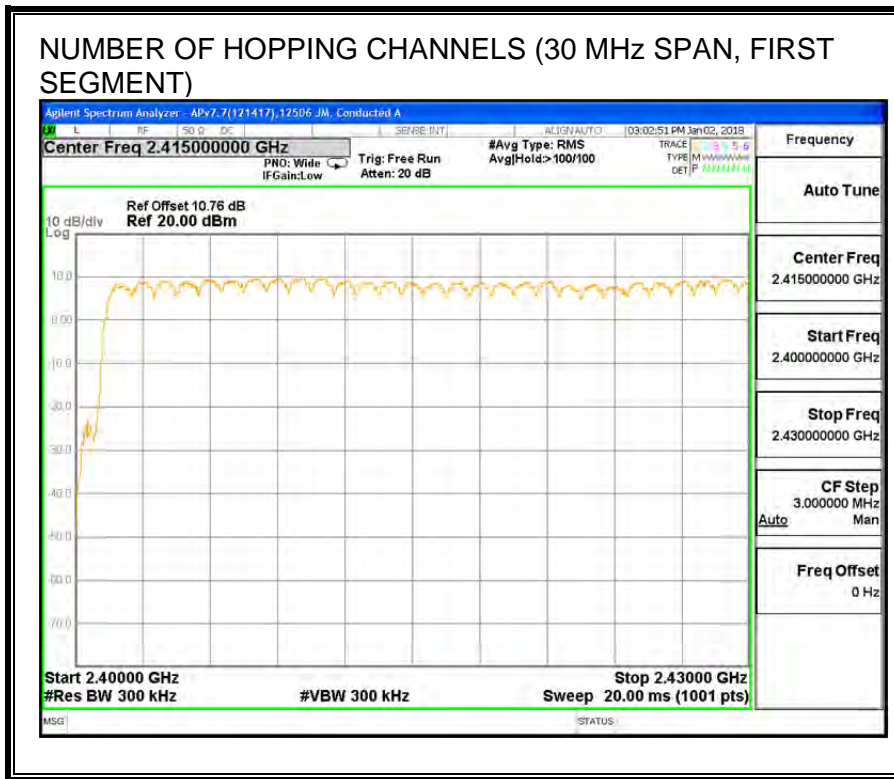

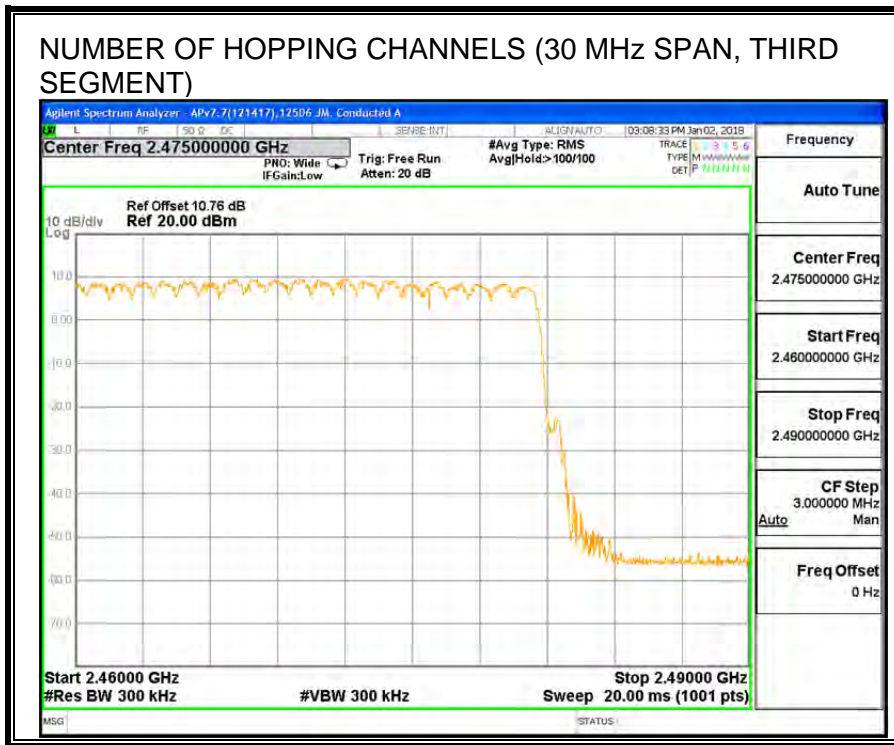

7.2.4. AVERAGE TIME OF OCCUPANCY

LIMITS

FCC §15.247 (a) (1) (iii)

The average time of occupancy on any channel shall not be greater than 0.4 seconds within a period of 0.4 seconds multiplied by the number of hopping channels employed.

TEST PROCEDURE

The transmitter output is connected to a spectrum analyzer. The span is set to 0 Hz, centered on a single, selected hopping channel. The width of a single pulse is measured in a fast scan. The number of pulses is measured in a 3.16 second scan, to enable resolution of each occurrence.

The average time of occupancy in the specified 31.6 second period (79 channels * 0.4 s) is equal to $10 * (\# \text{ of pulses in } 3.16 \text{ s}) * \text{ pulse width}$.

For AFH mode, the average time of occupancy in the specified 8 second period (20 channels * 0.4 seconds) is equal to $10 * (\# \text{ of pulses in } 0.8 \text{ s}) * \text{ pulse width}$.

RESULTS

AVERAGE TIME OF OCCUPANCY					
DH Packet	Pulse Width (msec)	Number of Pulses in 3.16 seconds	Average Time of Occupancy (sec)	Limit (sec)	Margin (sec)
8PSK Normal Mode					
3-DH1	0.388	32	0.1243	0.4	-0.2757
3-DH3	1.639	14	0.2295	0.4	-0.1705
3-DH5	2.890	8	0.2312	0.4	-0.1688
DH Packet	Pulse Width (sec)	Number of Pulses in 0.8 seconds	Average Time of Occupancy (sec)	Limit (sec)	Margin (sec)
8PSK AFH Mode					
3-DH1	0.388	8	0.03107	0.4	-0.3689
3-DH3	1.639	3.5	0.05737	0.4	-0.3426
3-DH5	2.890	2	0.05780	0.4	-0.3422
NOTE: --					

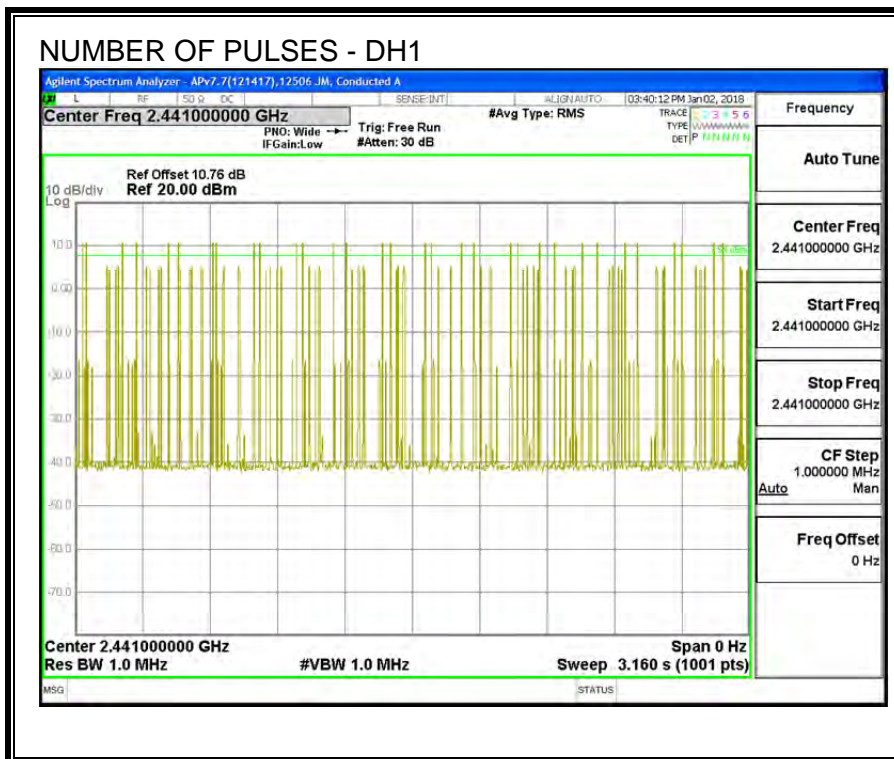
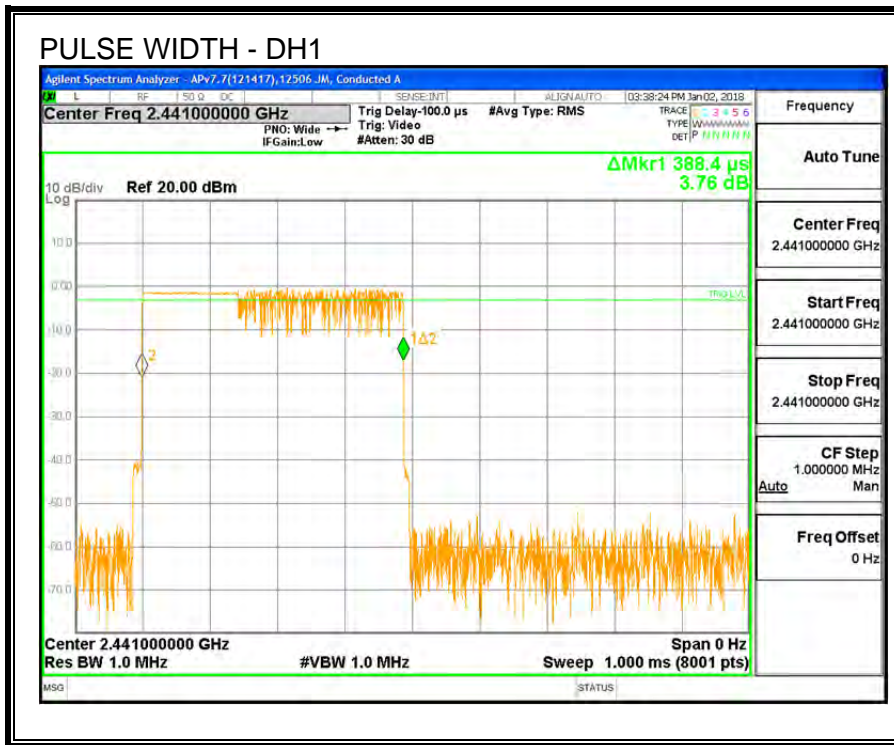

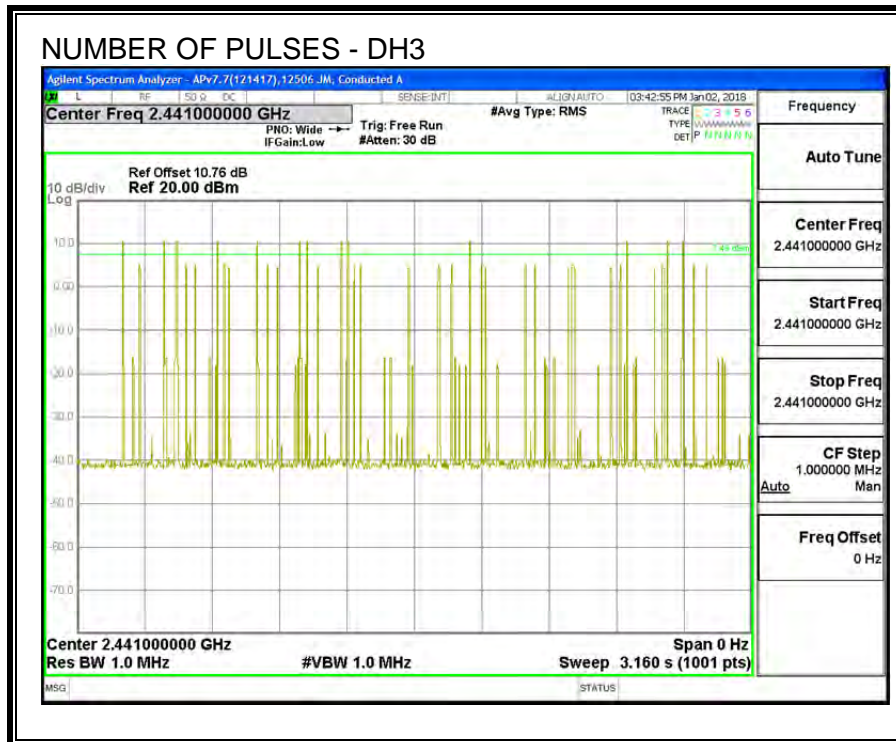

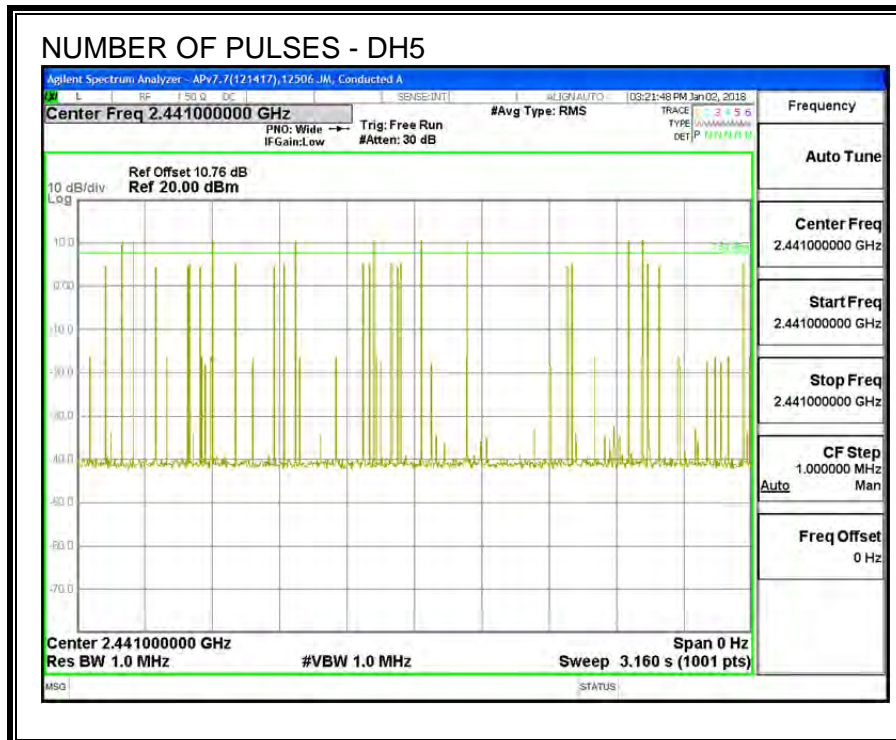
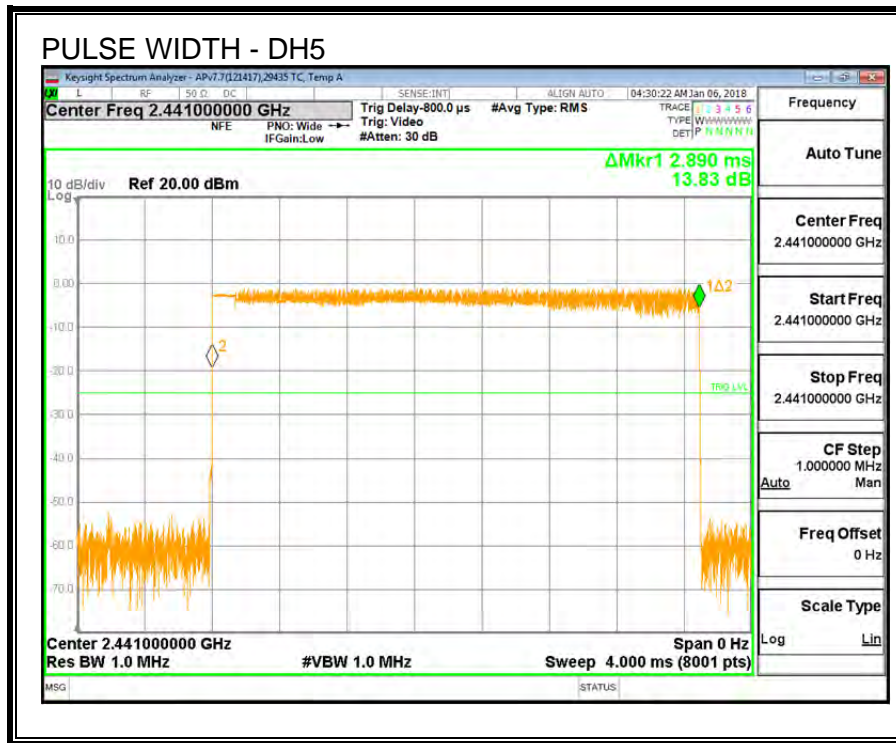

7.2.5. OUTPUT POWER

LIMITS

§15.247 (b) (1)

The maximum antenna gain is less than 6 dBi, therefore the limit is 30 dBm.

TEST PROCEDURE

The transmitter output is connected to a power meter.

The cable assembly insertion loss of 10.6 dB (consisting of 10 dB pad and 0.6 dB cable) is entered as an offset in the power meter to enable direct reading of the power. The power meter is gated to measure peak power during the ON time of the transmitter.

RESULTS

TEST ENGINEER:	12506 JM	Date:	01/05/2018
-----------------------	----------	--------------	------------

Channel	Frequency (MHz)	Output Power (dBm)	Limit (dBm)	Margin (dB)
Low	2402	9.59	30	-20.41
Middle	2441	10.12	30	-19.88
High	2480	8.37	30	-21.63

7.2.6. AVERAGE POWER

LIMITS

None; for reporting purposes only.

TEST PROCEDURE

The transmitter output is connected to a power meter.

The cable assembly insertion loss of 10.6 dB (consisting of 10 dB pad and 0.6 dB cable) is entered as an offset in the power meter to enable direct reading of the power. The power meter is gated to measure average power during the ON time of the transmitter.

RESULTS

TEST ENGINEER:	12506 JM	Date:	01/05/2018
-----------------------	----------	--------------	------------

Channel	Frequency (MHz)	Average Power (dBm)
Low	2402	7.39
Middle	2441	7.92
High	2480	7.81

7.2.7. CONDUCTED BANDEDGE AND SPURIOUS EMISSIONS

LIMITS

FCC §15.247 (d)

TEST PROCEDURE

The transmitter output is connected to a spectrum analyzer. The resolution bandwidth is set to 100 kHz. The video bandwidth is set to 300 kHz.

The spectrum from 30 MHz to 26 GHz is investigated with the transmitter set to the lowest, middle, and highest channels.

The bandedges at 2.4 and 2.4835 GHz are investigated with the transmitter set to the normal hopping mode.

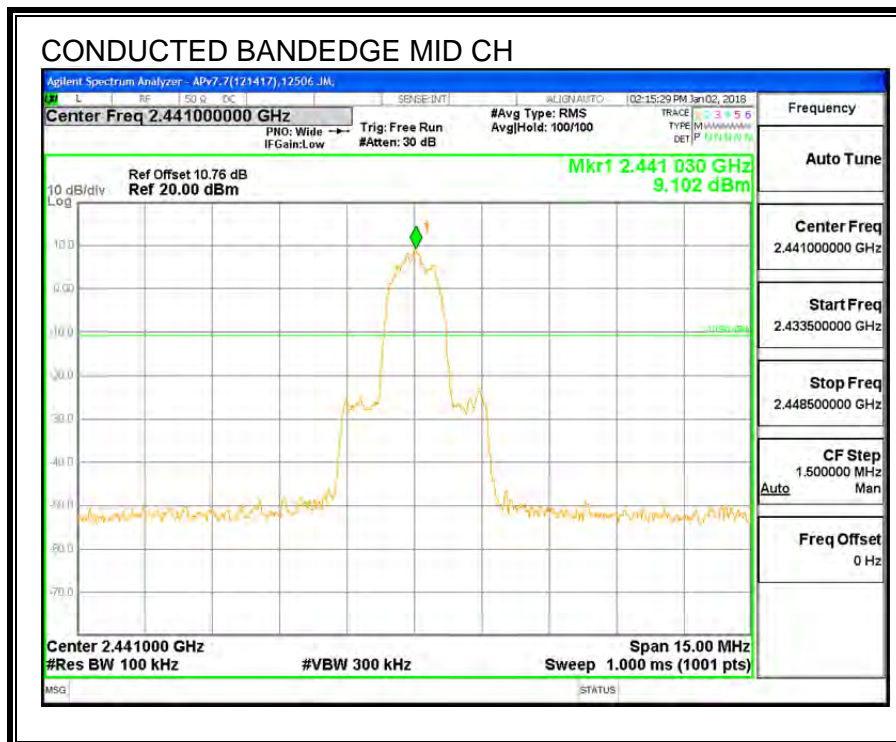
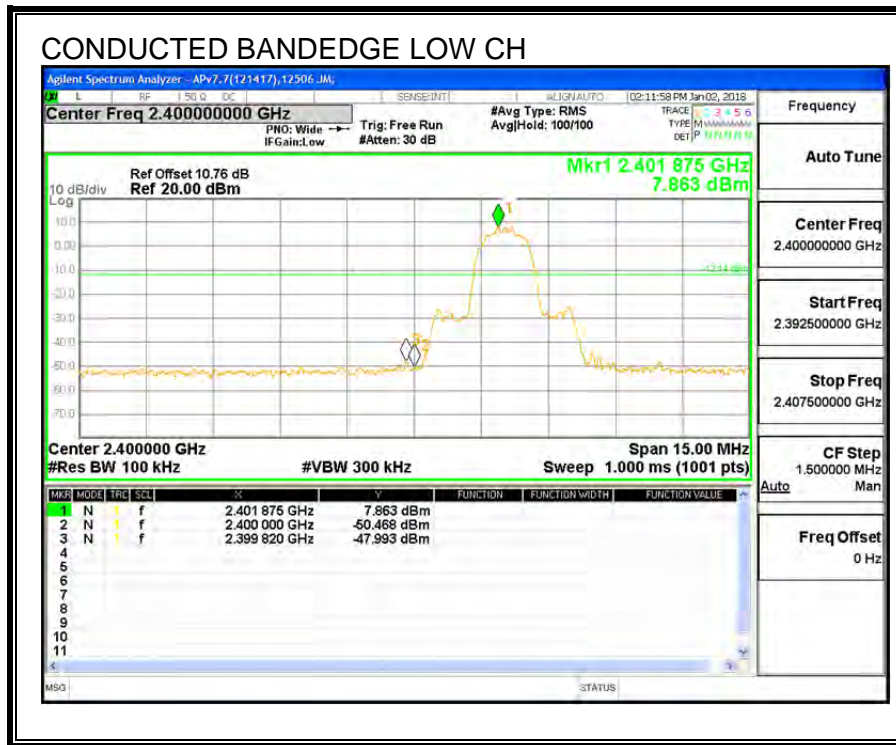

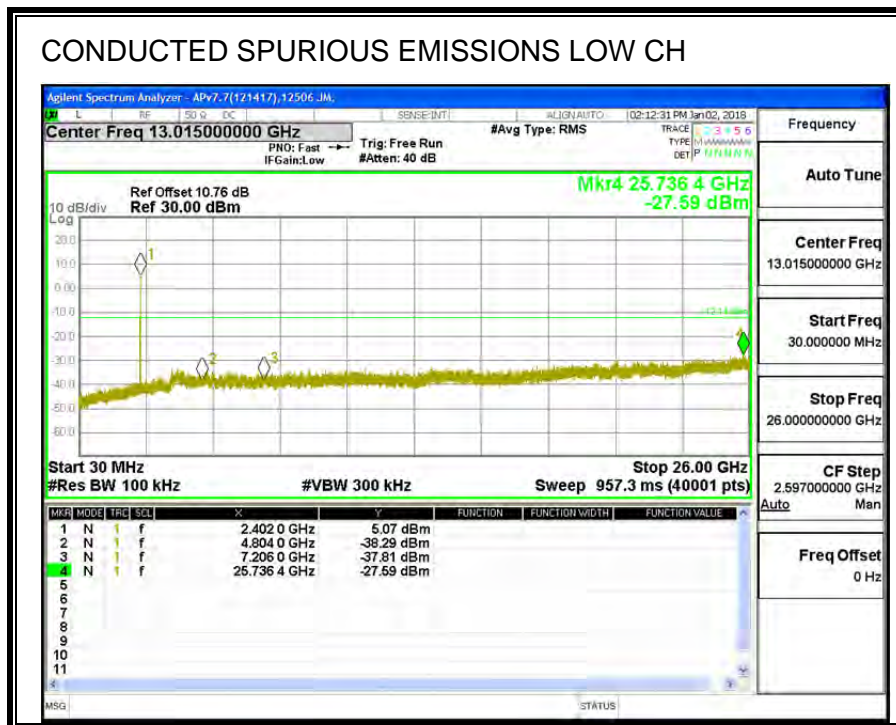
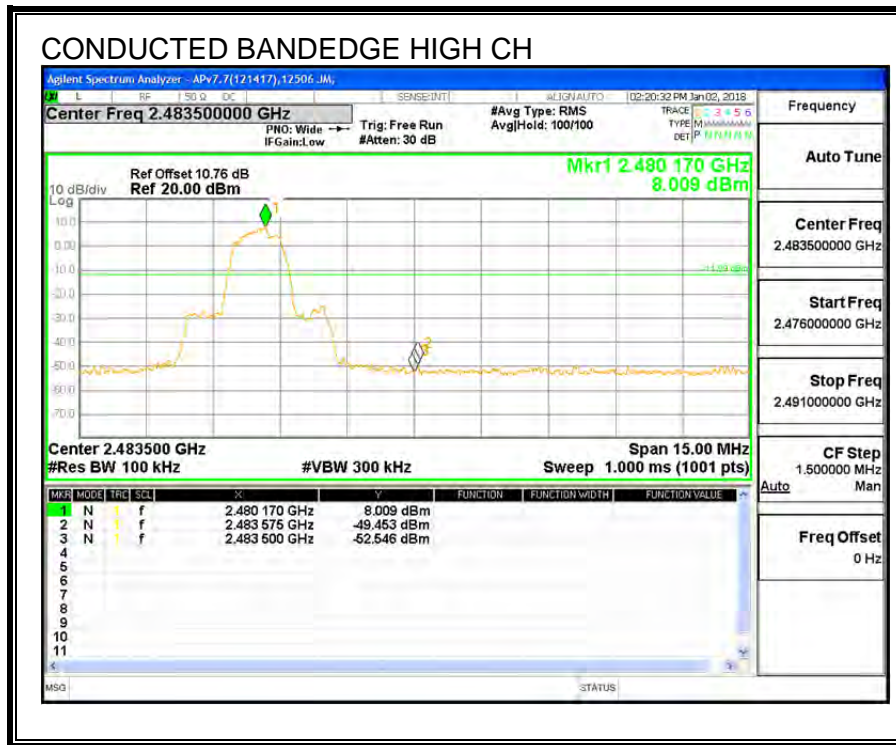

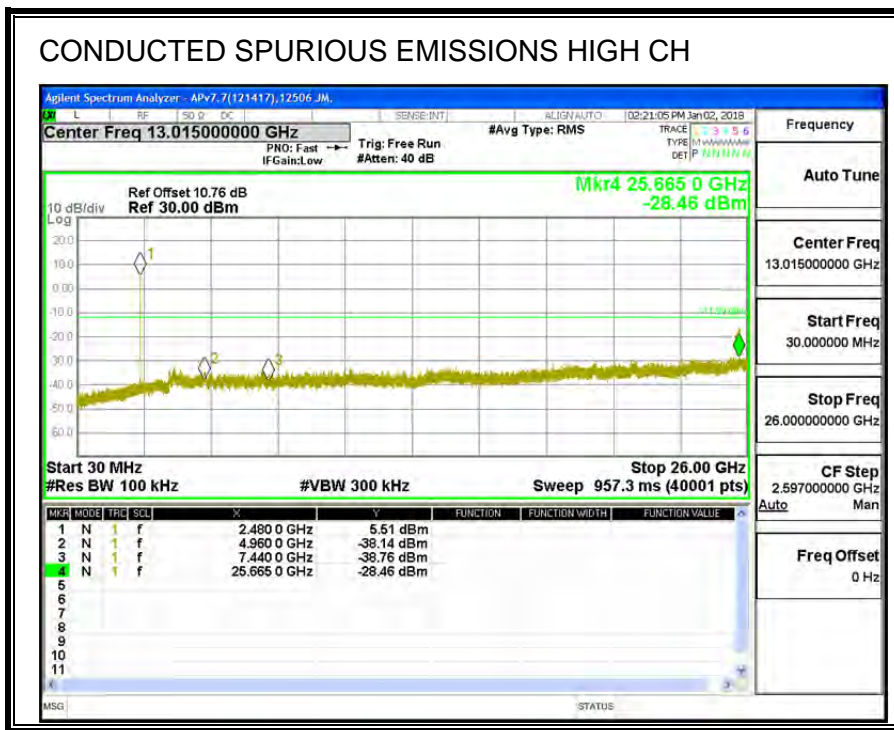
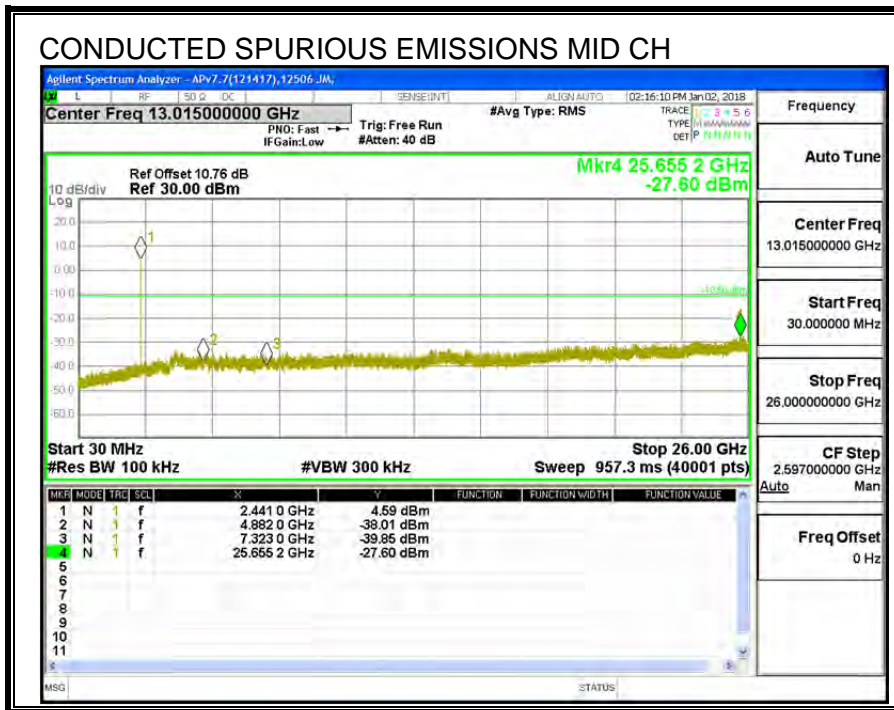

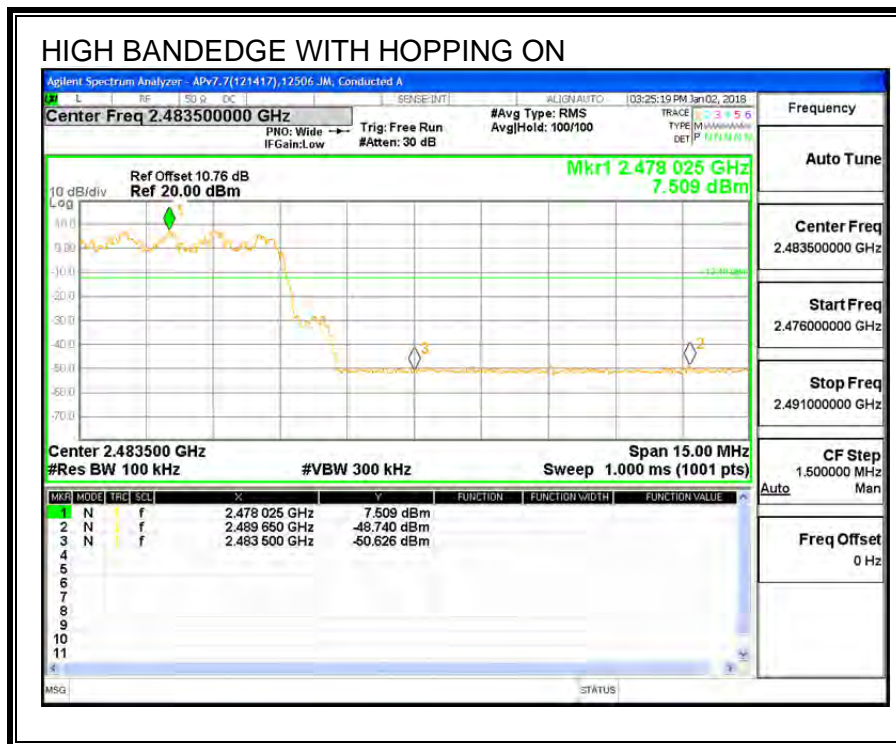
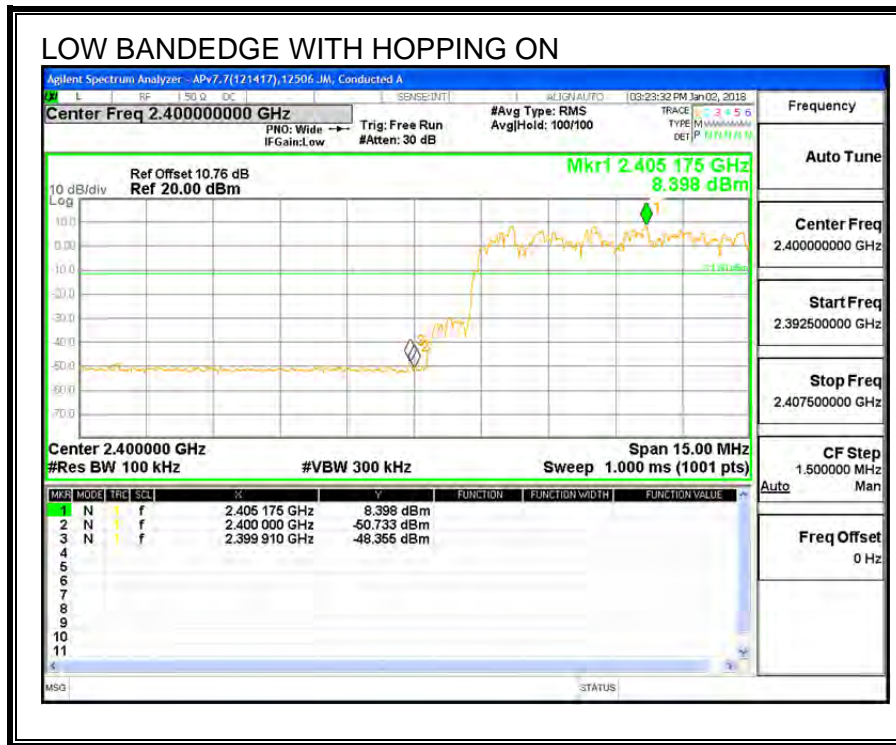

8. RADIATED TEST RESULTS

8.1. LIMITS AND PROCEDURE

LIMITS

FCC §15.205 and §15.209

Frequency Range (MHz)	Field Strength Limit (uV/m) at 3 m	Field Strength Limit (dBuV/m) at 3 m
0.009-0.490	2400/F(kHz) @ 300 m	-
0.490-1.705	24000/F(kHz) @ 30 m	-
1.705 - 30	30 @ 30m	-
30 - 88	100	40
88 - 216	150	43.5
216 - 960	200	46
Above 960	500	54

TEST PROCEDURE

The EUT is placed on a non-conducting table 80 cm above the ground plane for measurement below 1GHz; 1.5 m above the ground plane for measurement above 1GHz. The antenna to EUT distance is 3 meters. The EUT is configured in accordance with ANSI C63.10. The EUT is set to transmit in a continuous mode.

For measurements below 1 GHz the resolution bandwidth is set to 100 kHz for peak detection measurements or 120 kHz for quasi-peak detection measurements. Peak detection is used unless otherwise noted as quasi-peak.

For measurements above 1 GHz the resolution bandwidth is set to 1 MHz, then the video bandwidth is set to 3 MHz for peak measurements and 1 MHz resolution bandwidth with 1/T (10 Hz) video bandwidth with peak detector for average measurements.

The spectrum from 1 GHz to 18 GHz is investigated with the transmitter set to the lowest, middle, and highest channels in each applicable band. Below 1GHz and above 18GHz emissions, the channel with the highest output power was tested.

The frequency range of interest is monitored at a fixed antenna height and EUT azimuth. The EUT is rotated through 360 degrees to maximize emissions received. The antenna is scanned from 1 to 4 meters above the ground plane to further maximize the emission. Measurements are made with the antenna polarized in both the vertical and the horizontal positions.

RESULTS

8.2. BASIC DATA RATE GFSK MODULATION

8.2.1. RESTRICTED BANDEGE (LOW CHANNEL)

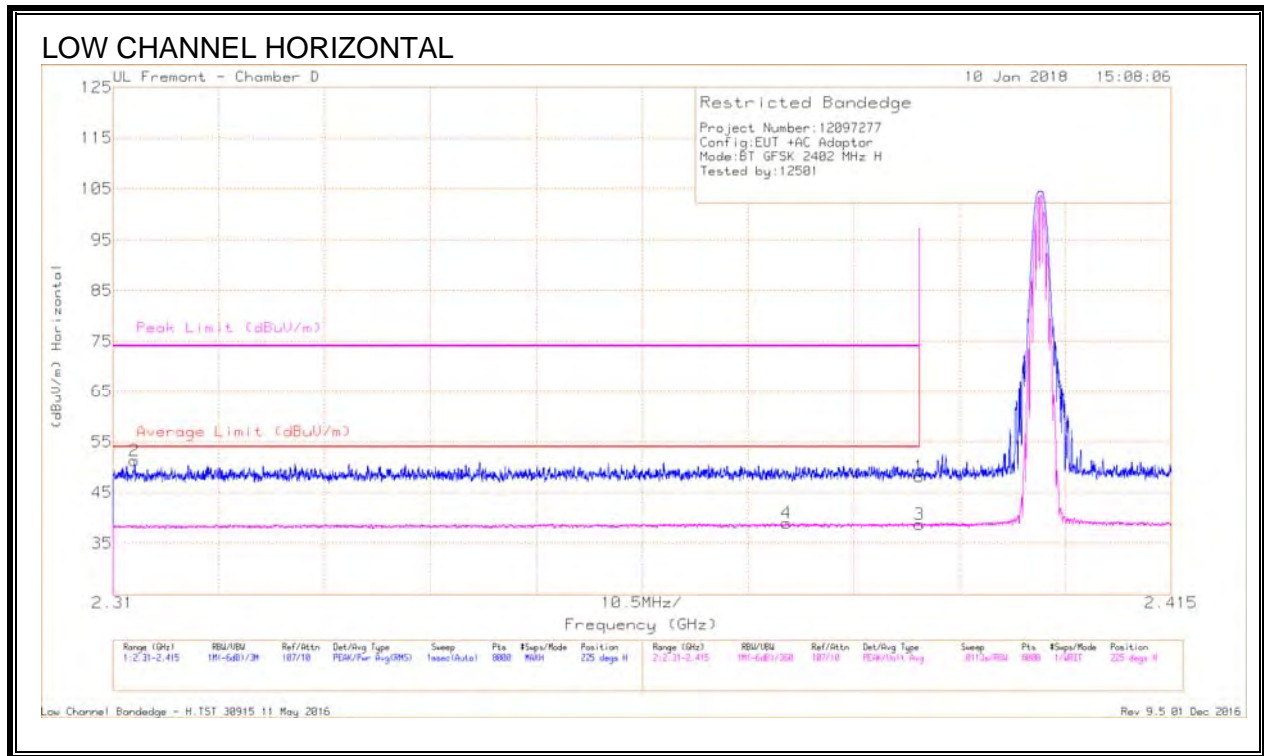

Trace Markers

Marker	Frequency (GHz)	Meter Reading (dBuV)	Det	AF T711 (dB/m)	Amp/Cbl/Fitr/Pad (dB)	Corrected Reading (dBuV/m)	Average Limit (dBuV/m)	Margin (dB)	Peak Limit (dBuV/m)	PK Margin (dB)	Azimuth (Degs)	Height (cm)	Polarity
1	* 2.39	36.55	Pk	32.1	-20.5	48.15	-	-	74	-25.85	225	297	H
2	* 2.312	40.14	Pk	31.9	-20.7	51.34	-	-	74	-22.66	225	297	H
3	* 2.39	27.17	VA1T	32.1	-20.5	38.77	54	-15.23	-	-	225	297	H
4	* 2.377	27.33	VA1T	32.1	-20.4	39.03	54	-14.97	-	-	225	297	H

* - indicates frequency in CFR47 Pt 15 - Restricted Band

Pk - Peak detector

VA1T - FHSS: Linear Voltage Average $VB=1/Ton$ where: Ton is transmit duration

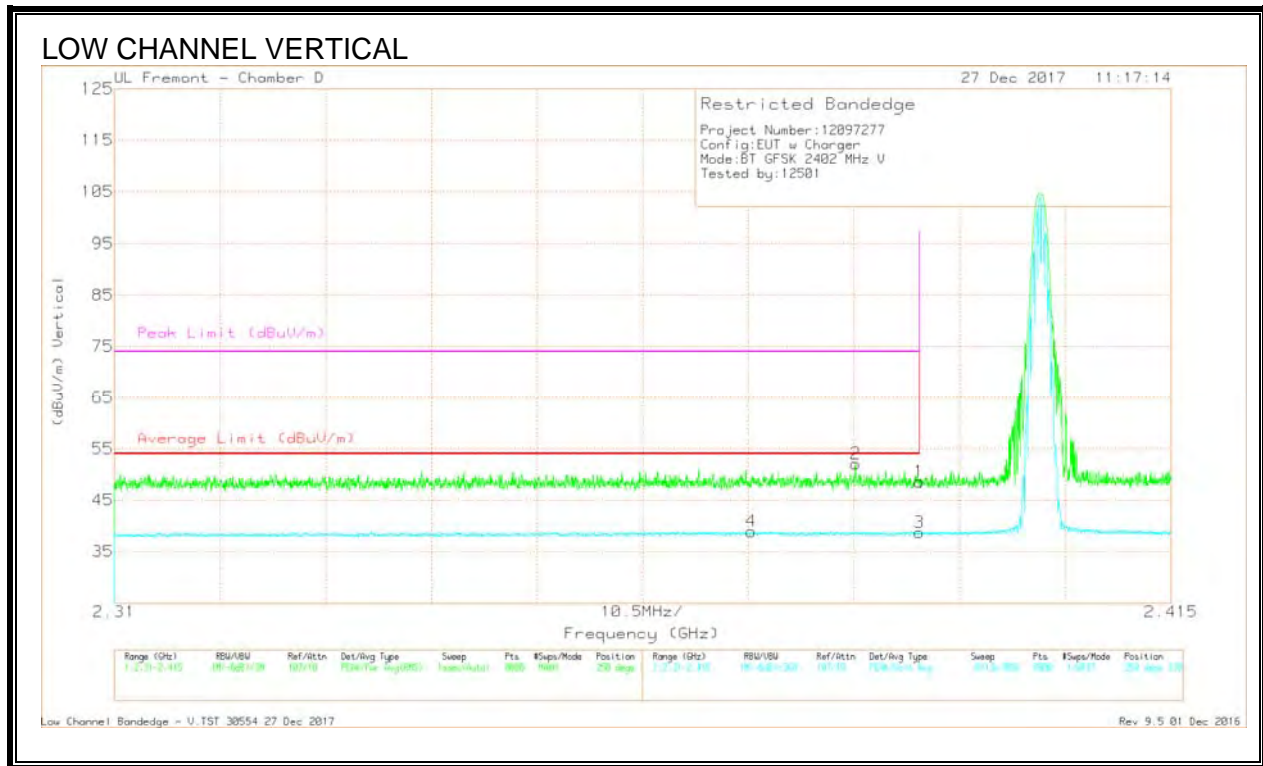

Trace Markers

Marker	Frequency (GHz)	Meter Reading (dBuV)	Det	AF T711 (dB/m)	Amp/CbI/Fitr/Pa d (dB)	Corrected Reading (dBuV/m)	Average Limit (dBuV/m)	Margin (dB)	Peak Limit (dBuV/m)	PK Margin (dB)	Azimuth (Degs)	Height (cm)	Polarity
1	* 2.39	36.96	Pk	32.1	-20.5	48.56	-	-	74	-25.44	250	331	V
2	* 2.384	40.45	Pk	32.1	-20.5	52.05	-	-	74	-21.95	250	331	V
3	* 2.39	27.12	VA1T	32.1	-20.5	38.72	54	-15.28	-	-	250	330	V
4	* 2.373	27.32	VA1T	32.1	-20.5	38.92	54	-15.08	-	-	250	330	V

* - indicates frequency in CFR47 Pt 15 - Restricted Band

Pk - Peak detector

VA1T - FHSS: Linear Voltage Average $V_B=1/T_{on}$ where: T_{on} is transmit duration

8.2.2. AUTHORIZED BANDEDGE (HIGH CHANNEL)

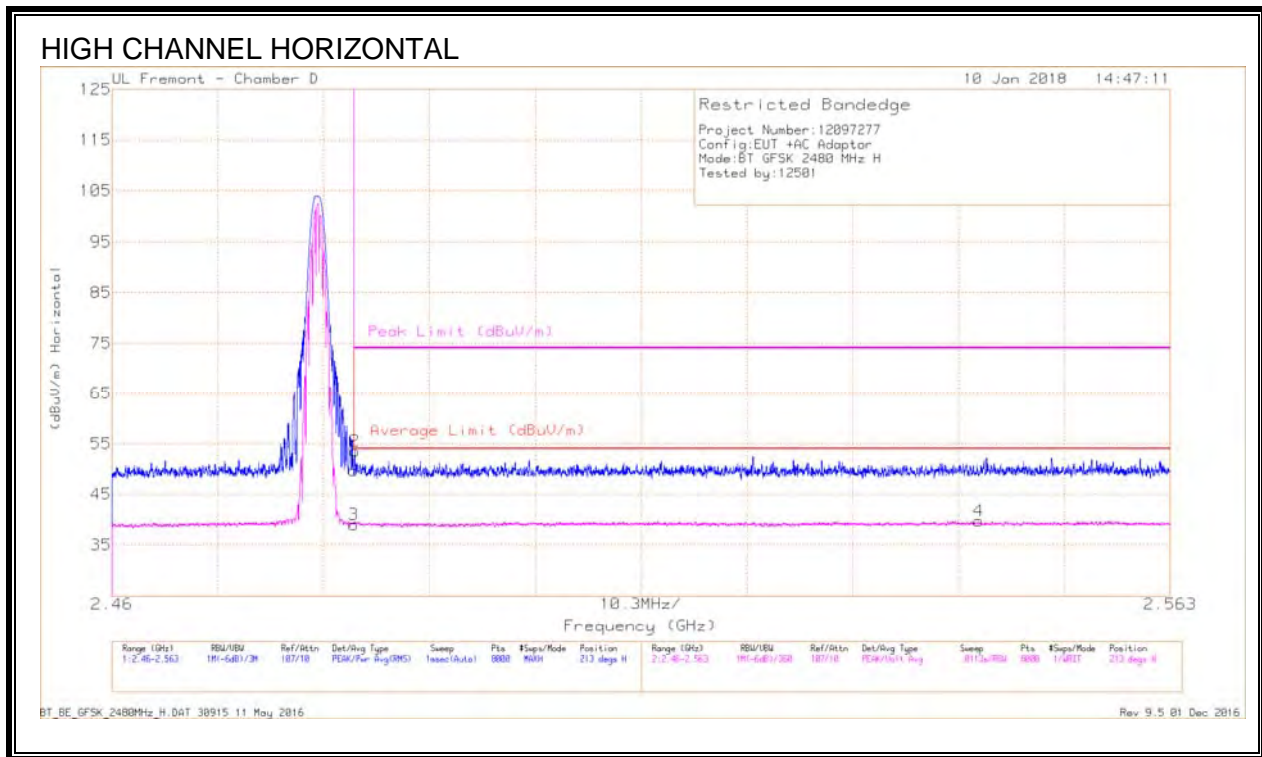

Trace Markers

Marker	Frequency (GHz)	Meter Reading (dBuV)	Det	AF T711 (dB/m)	Amp/Cb/Fktr/Pa d (dB)	Corrected Reading (dBuV/m)	Average Limit (dBuV/m)	Margin (dB)	Peak Limit (dBuV/m)	PK Margin (dB)	Azimuth (Degs)	Height (cm)	Polarity
1	* 2.484	37.57	Pk	32.5	-20.4	49.67	-	-	74	-24.33	213	214	H
2	* 2.484	41.55	Pk	32.5	-20.5	53.55	-	-	74	-20.45	213	214	H
3	* 2.484	26.89	VA1T	32.5	-20.4	38.99	54	-15.01	-	-	213	213	H
4	2.544	27.4	VA1T	32.6	-20.3	39.7	54	-14.3	-	-	213	213	H

* - indicates frequency in CFR47 Pt 15 - Restricted Band

Pk - Peak detector

VA1T - FHSS: Linear Voltage Average $VB=1/Ton$ where: Ton is transmit duration



Trace Markers

Marker	Frequency (GHz)	Meter Reading (dBuV)	Det	AF T711 (dB/m)	Amp/Cb1/Ftr/Pa d (dB)	Corrected Reading (dBuV/m)	Average Limit (dBuV/m)	Margin (dB)	Peak Limit (dBuV/m)	PK Margin (dB)	Azimuth (Degs)	Height (cm)	Polarity
1	* 2.484	38.61	Pk	32.5	-20.4	50.71	-	-	74	-23.29	259	348	V
2	* 2.484	40.76	Pk	32.5	-20.5	52.76	-	-	74	-21.24	259	348	V
3	* 2.484	26.99	VA1T	32.5	-20.4	39.09	54	-14.91	-	-	259	348	V
4	2.557	27.54	VA1T	32.6	-20.3	39.84	54	-14.16	-	-	259	348	V

* - indicates frequency in CFR47 Pt 15 - Restricted Band

Pk - Peak detector

VA1T - FHSS: Linear Voltage Average $V_B=1/T_{on}$ where: T_{on} is transmit duration

8.2.3. HARMONICS AND SPURIOUS EMISSIONS

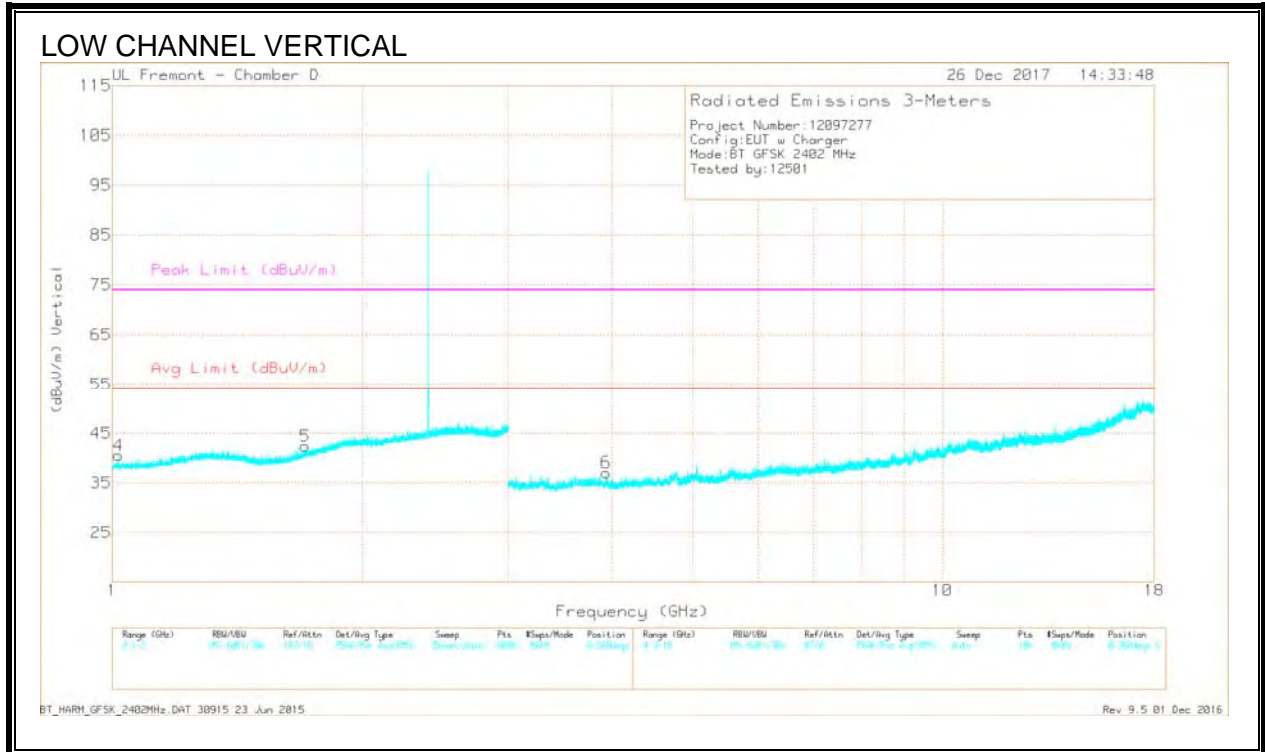
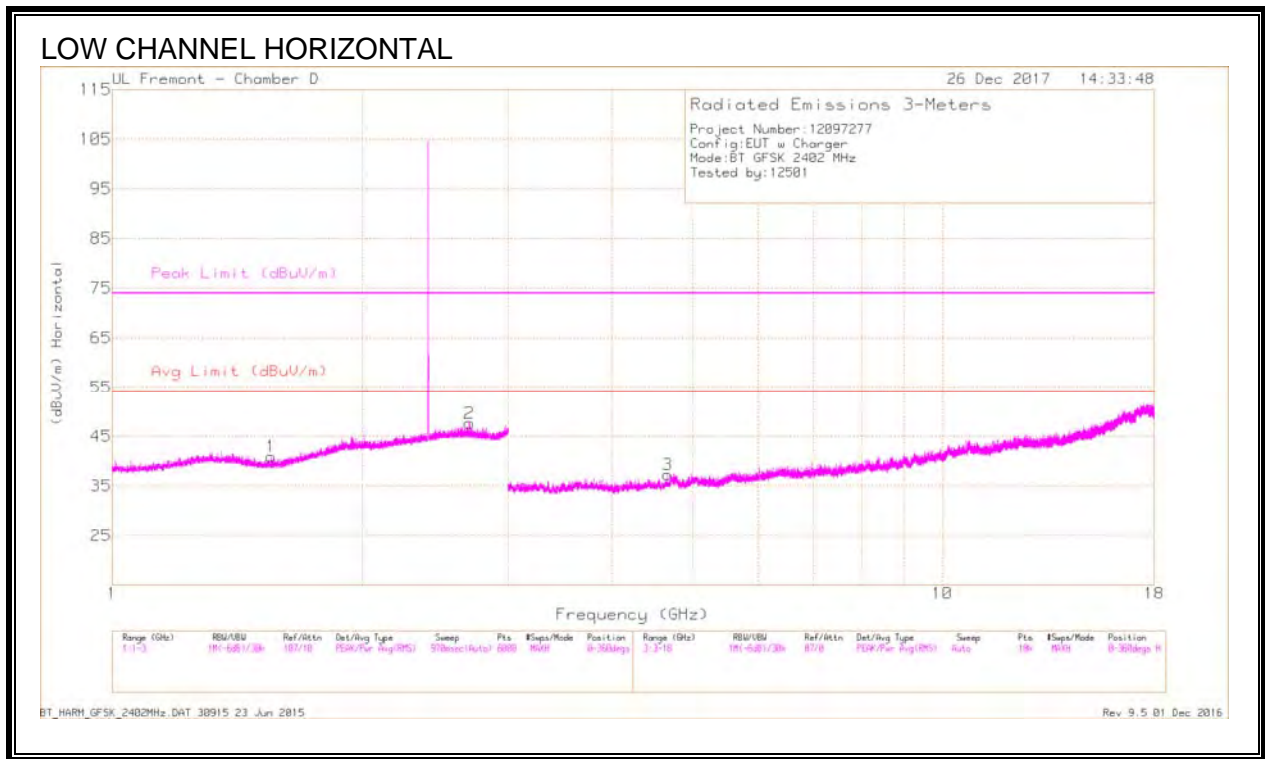

Radiated Emissions

Frequency (GHz)	Meter Reading (dBuV)	Det	AF T711 (dB/m)	Amp/Cbl/Filtr/Pad (dB)	Corrected Reading (dBuV/m)	Avg Limit (dBuV/m)	Margin (dB)	Peak Limit (dBuV/m)	PK Margin (dB)	Azimuth (Degs)	Height (cm)	Polarity
* 1.557	38.93	PKFH	28.2	-21.6	45.53	-	-	74	-28.47	27	379	H
* 1.555	27.1	VA1T	28.2	-21.6	33.7	54	-20.3	-	-	27	379	H
* 2.693	38.37	PKFH	32.7	-20.3	50.77	-	-	74	-23.23	175	252	H
* 2.691	26.99	VA1T	32.7	-20.3	39.39	54	-14.61	-	-	175	252	H
* 1.018	38.97	PKFH	27.8	-22.5	44.27	-	-	74	-29.73	154	349	V
* 1.017	27.48	VA1T	27.8	-22.5	32.78	54	-21.22	-	-	154	349	V
* 1.71	38.47	PKFH	29.4	-21.4	46.47	-	-	74	-27.53	149	314	V
* 1.709	27.03	VA1T	29.3	-21.4	34.93	54	-19.07	-	-	149	314	V
* 4.664	35.71	PKFH	33.8	-27.7	41.81	-	-	74	-32.19	50	162	H
* 4.666	23.61	VA1T	33.8	-27.7	29.71	54	-24.29	-	-	50	162	H
* 3.939	35.39	PKFH	33.4	-27.8	40.99	-	-	74	-33.01	90	119	V
* 3.938	23.58	VA1T	33.4	-27.8	29.18	54	-24.82	-	-	90	119	V

* - indicates frequency in CFR47 Pt 15 - Restricted Band

PKFH - FHSS: RB=100k/1MHz VB=3 x RB, Peak

VA1T - FHSS: Linear Voltage Average VB=1/Ton where: Ton is transmit duration

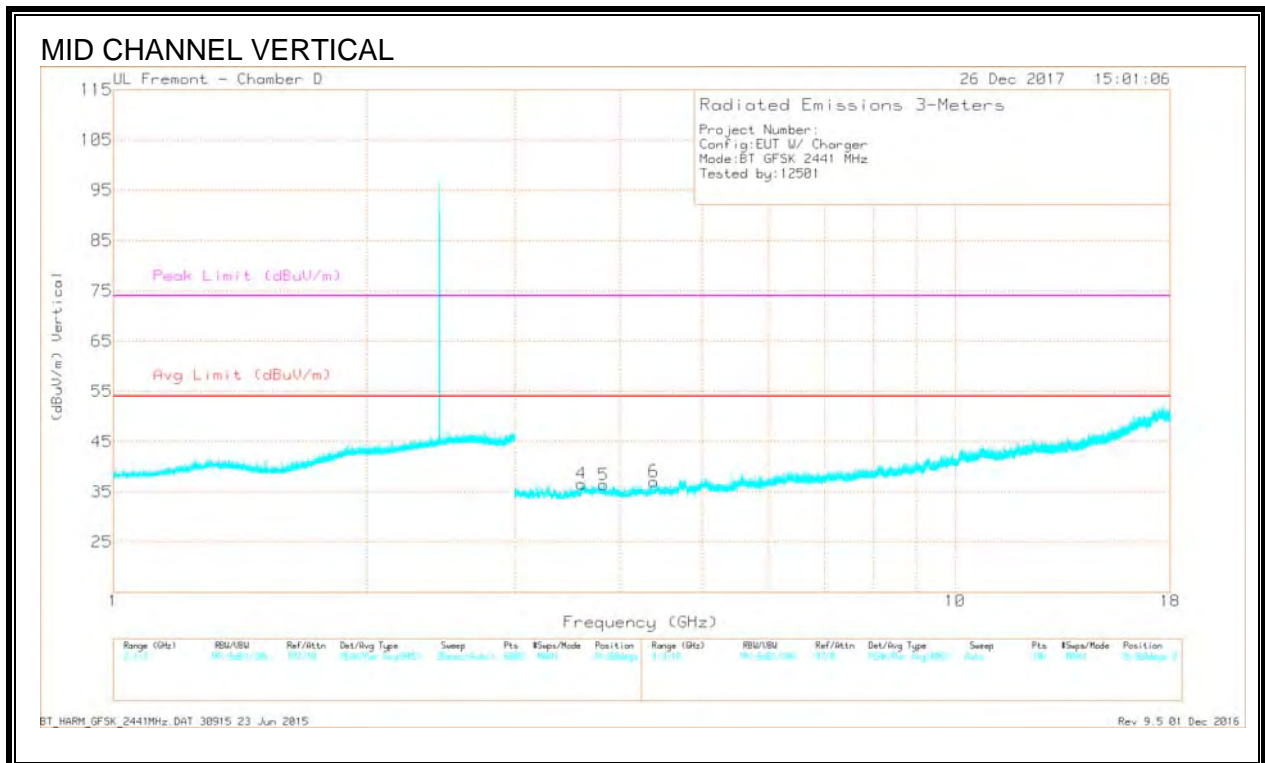
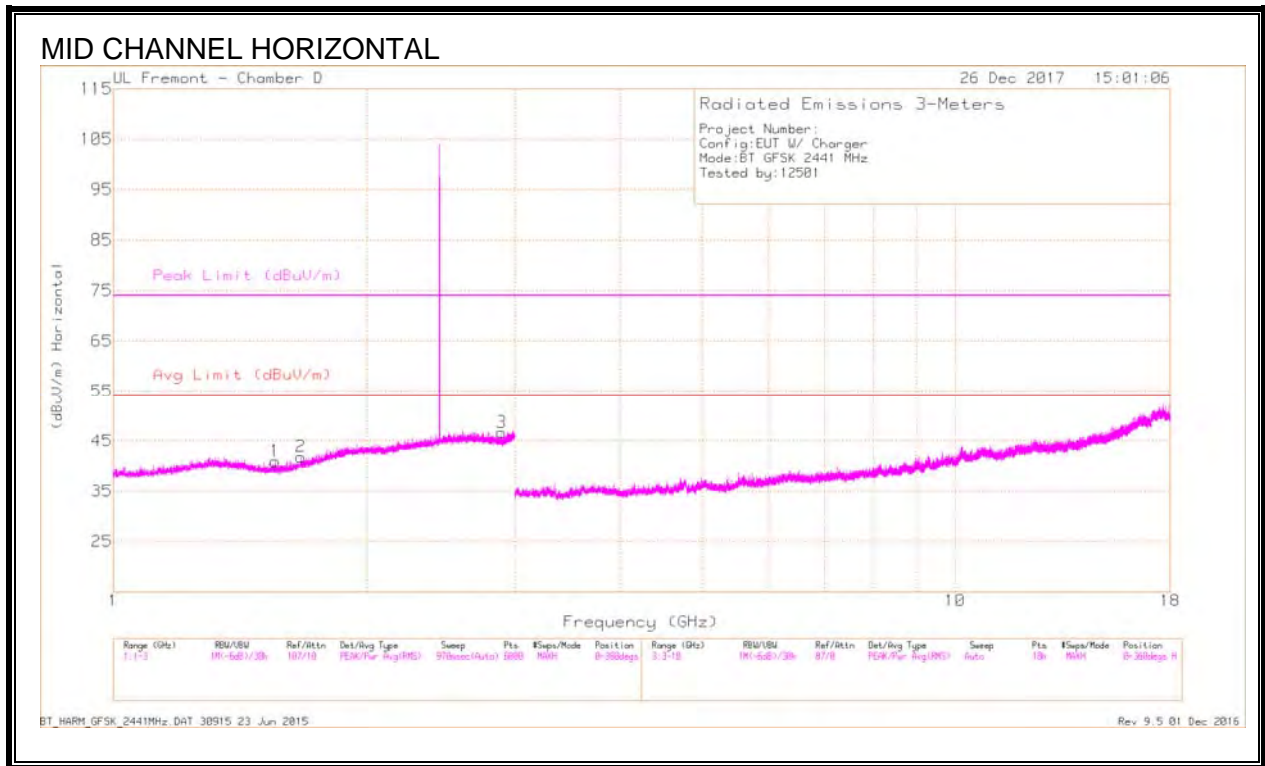

Radiated Emissions

Frequency (GHz)	Meter Reading (dBuV)	Det	AF T711 (dB/m)	Amp/Cbl/Filtr/Pad (dB)	Corrected Reading (dBuV/m)	Avg Limit (dBuV/m)	Margin (dB)	Peak Limit (dBuV/m)	PK Margin (dB)	Azimuth (Degs)	Height (cm)	Polarity
* 1.557	38.67	PKFH	28.2	-21.6	45.27	-	-	74	-28.73	317	300	H
* 1.558	27.13	VA1T	28.2	-21.6	33.73	54	-20.27	-	-	317	300	H
* 1.669	38.93	PKFH	28.9	-21.4	46.43	-	-	74	-27.57	288	306	H
* 1.672	27.05	VA1T	29	-21.4	34.65	54	-19.35	-	-	288	306	H
* 2.893	38.56	PKFH	32	-20	50.56	-	-	74	-23.44	234	275	H
* 2.894	26.72	VA1T	32	-20	38.72	54	-15.28	-	-	234	275	H
* 3.601	34.16	PKFH	33.1	-27.8	39.46	-	-	74	-34.54	347	113	V
* 3.6	23.59	VA1T	33.1	-27.8	28.89	54	-25.11	-	-	347	113	V
* 3.824	36.51	PKFH	33.2	-28.1	41.61	-	-	74	-32.39	188	396	V
* 3.822	24.09	VA1T	33.2	-28.1	29.19	54	-24.81	-	-	188	396	V
* 3.939	35.39	PKFH	33.4	-27.8	40.99	-	-	74	-33.01	90	119	V
* 3.938	23.58	VA1T	33.4	-27.8	29.18	54	-24.82	-	-	90	119	V

* - indicates frequency in CFR47 Pt 15 - Restricted Band

PKFH - FHSS: RB=100k/1MHz VB=3 x RB, Peak

VA1T - FHSS: Linear Voltage Average VB=1/Ton where: Ton is transmit duration

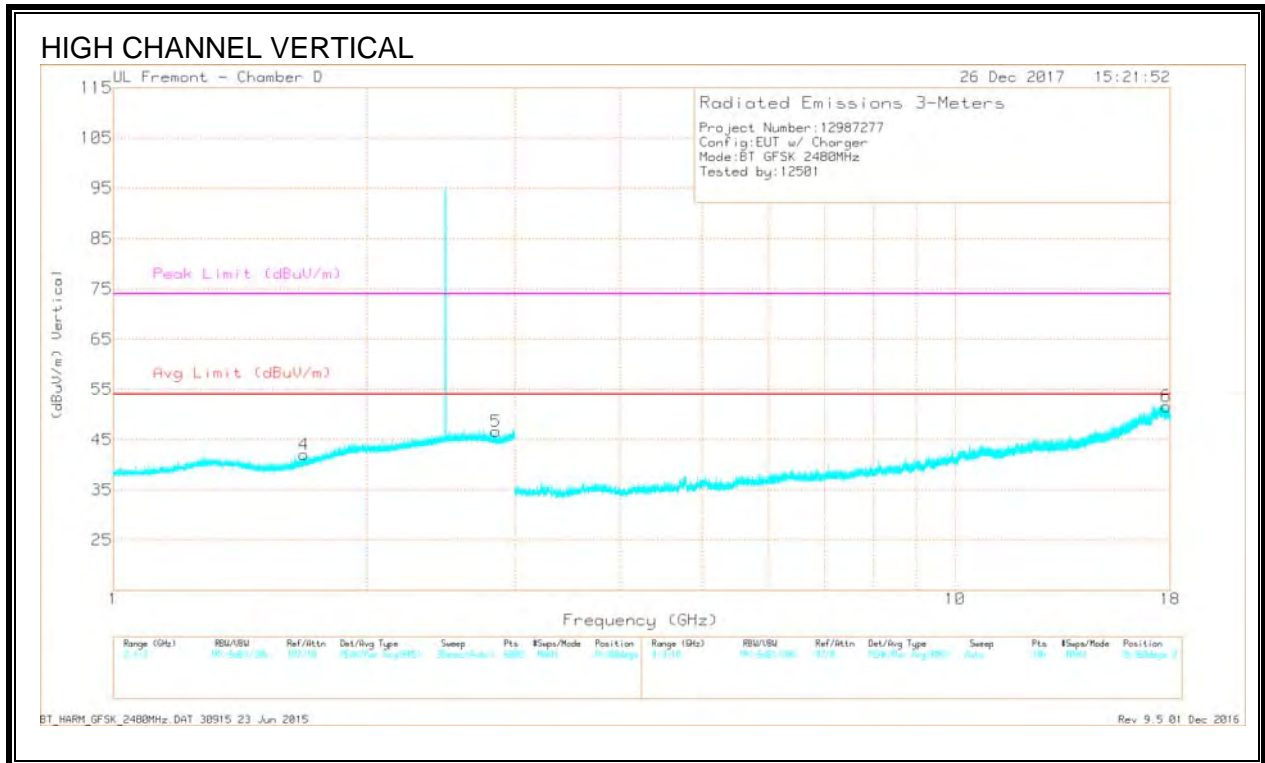
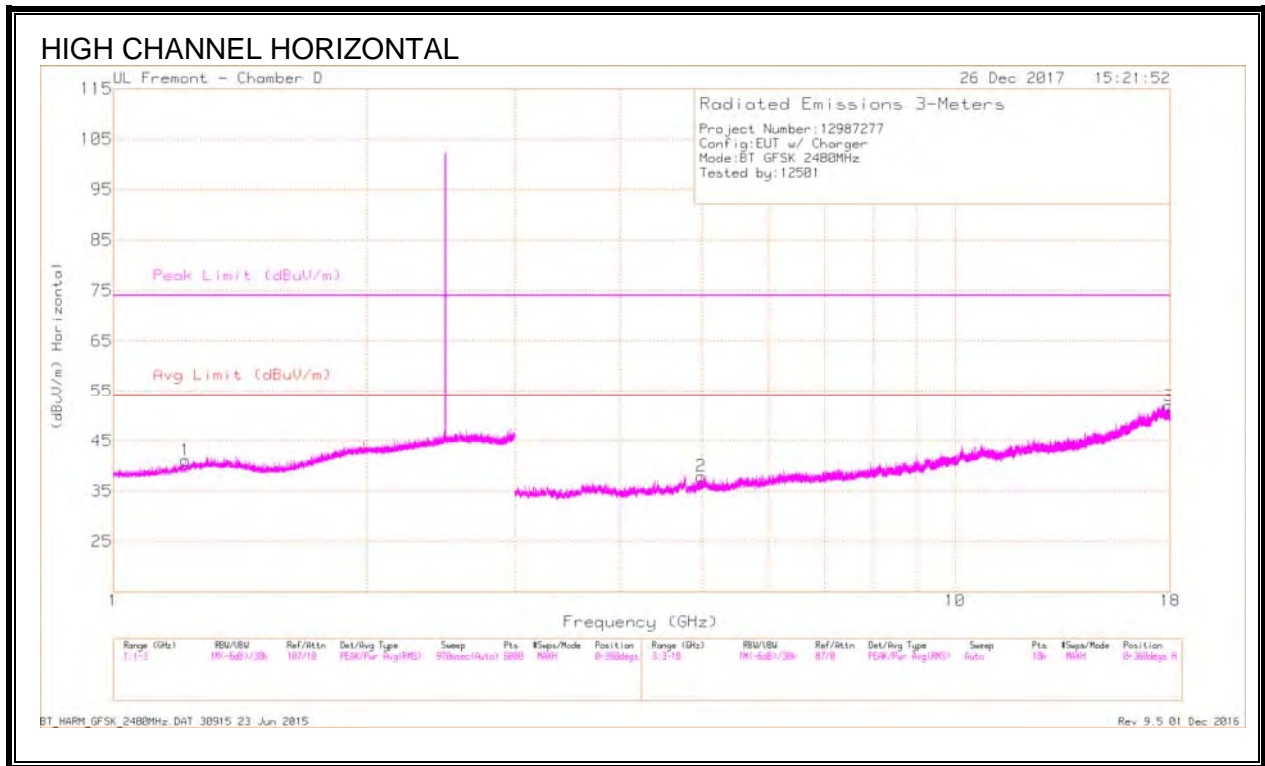

Frequency (GHz)	Meter Reading (dBuV)	Det	AF T711 (dB/m)	Amp/Cbl/Fitr/Pad (dB)	Corrected Reading (dBuV/m)	Avg Limit (dBuV/m)	Margin (dB)	Peak Limit (dBuV/m)	PK Margin (dB)	Azimuth (Degs)	Height (cm)	Polarity
* 1.22	38.49	PKFH	28.8	-22.2	45.09	-	-	74	-28.91	300	288	H
* 1.219	27.28	VA1T	28.8	-22.2	33.88	54	-20.12	-	-	300	288	H
* 1.686	39.12	PKFH	29.1	-21.4	46.82	-	-	74	-27.18	41	287	V
* 1.685	27.01	VA1T	29.1	-21.4	34.71	54	-19.29	-	-	41	287	V
* 2.849	38.67	PKFH	32.2	-19.9	50.97	-	-	74	-23.03	169	221	V
* 2.848	26.71	VA1T	32.2	-19.9	39.01	54	-14.99	-	-	169	221	V
* 4.996	34.13	PKFH	34.1	-26.6	41.63	-	-	74	-32.37	147	294	H
* 4.993	22.77	VA1T	34.1	-26.7	30.17	54	-23.83	-	-	147	294	H
* 17.93	30.66	PKFH	41.4	-15.5	56.56	-	-	74	-17.44	183	323	H
* 17.931	18.7	VA1T	41.4	-15.5	44.6	54	-9.4	-	-	183	323	H
* 17.822	30.3	PKFH	41.5	-15.6	56.2	-	-	74	-17.8	14	187	V
* 17.819	18.78	VA1T	41.5	-15.6	44.68	54	-9.32	-	-	14	187	V

* - indicates frequency in CFR47 Pt 15 - Restricted Band

PKFH - FHSS: RB=100k/1MHz VB=3 x RB, Peak

VA1T - FHSS: Linear Voltage Average VB=1/Ton where: Ton is transmit duration

8.3. ENHANCED DATA RATE 8PSK MODULATION

8.3.1. RESTRICTED BANDEDGE (LOW CHANNEL)

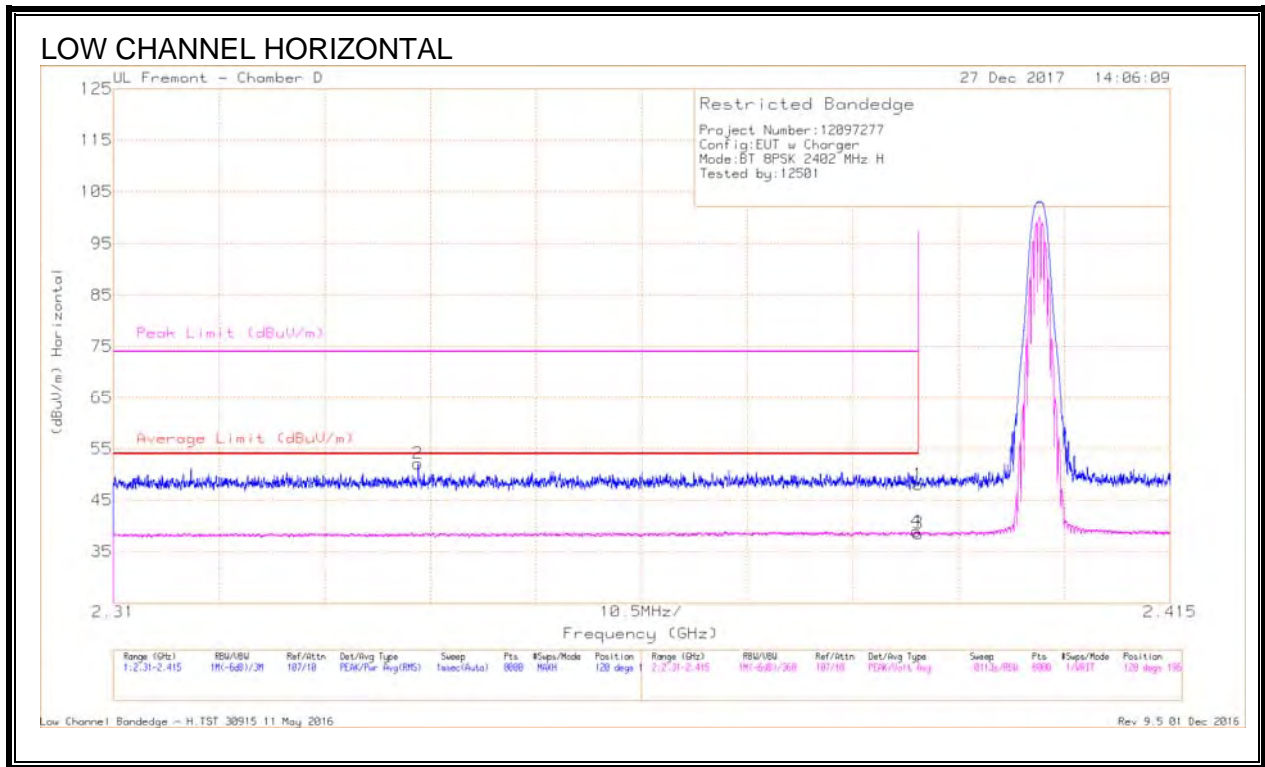

Trace Markers

Marker	Frequency (GHz)	Meter Reading (dBuV)	Det	AF T711 (dB/m)	Amp/Cb1/Ftr/Pa d (dB)	Corrected Reading (dBuV/m)	Average Limit (dBuV/m)	Margin (dB)	Peak Limit (dBuV/m)	PK Margin (dB)	Azimuth (Degs)	Height (cm)	Polarity
1	* 2.39	36.44	Pk	32.1	-20.5	48.04	-	-	74	-25.96	120	196	H
2	* 2.34	40.71	Pk	32	-20.6	52.11	-	-	74	-21.89	120	196	H
3	* 2.39	26.93	VA1T	32.1	-20.5	38.53	54	-15.47	-	-	120	196	H
4	* 2.39	27.31	VA1T	32.1	-20.5	38.91	54	-15.09	-	-	120	196	H

* - indicates frequency in CFR47 Pt 15 - Restricted Band

Pk - Peak detector

VA1T - FHSS: Linear Voltage Average $VB=1/Ton$ where: Ton is transmit duration

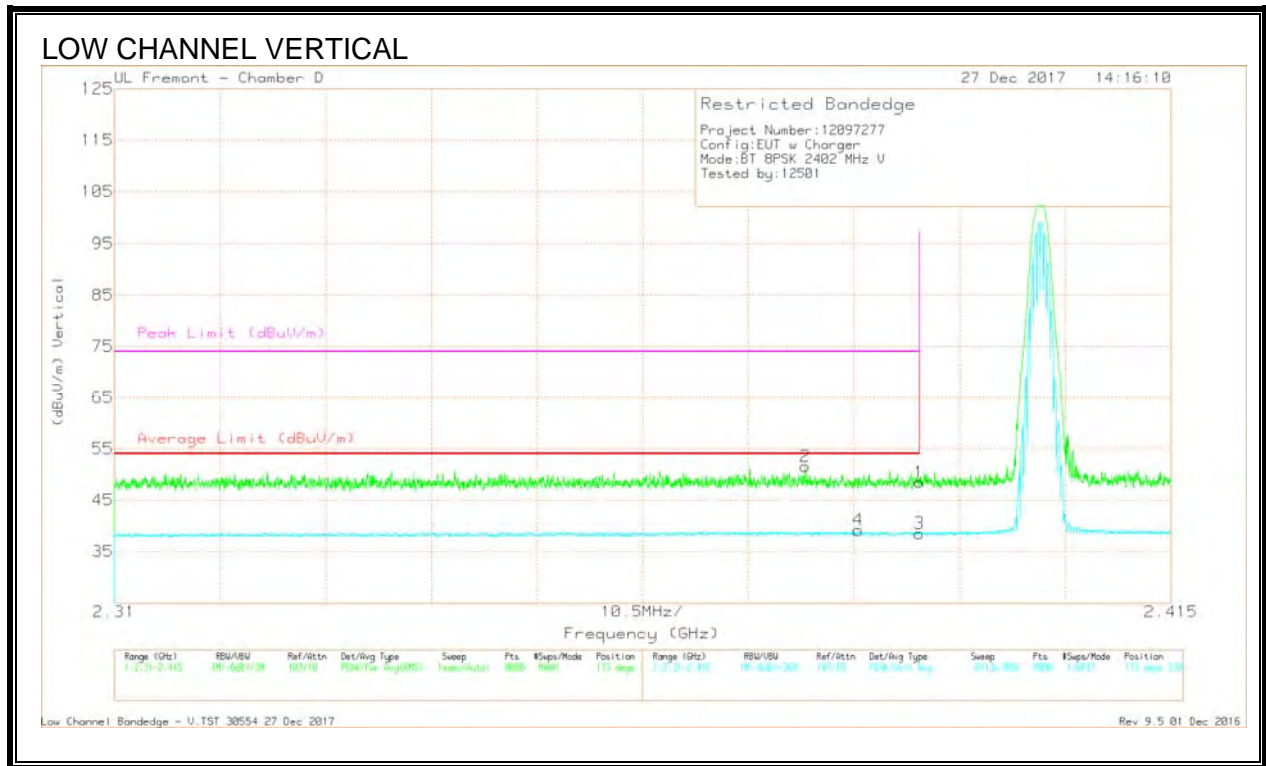

Trace Markers

Marker	Frequency (GHz)	Meter Reading (dBuV)	Det	AF T711 (dB/m)	Amp/Cbl/Fitr/Pa d (dB)	Corrected Reading (dBuV/m)	Average Limit (dBuV/m)	Margin (dB)	Peak Limit (dBuV/m)	PK Margin (dB)	Azimuth (Degs)	Height (cm)	Polarity
1	* 2.39	36.87	Pk	32.1	-20.5	48.47	-	-	74	-25.53	173	330	V
2	* 2.379	39.93	Pk	32.1	-20.5	51.53	-	-	74	-22.47	173	330	V
3	* 2.39	26.9	VA1T	32.1	-20.5	38.5	54	-15.5	-	-	173	330	V
4	* 2.384	27.56	VA1T	32.1	-20.5	39.16	54	-14.84	-	-	173	330	V

* - indicates frequency in CFR47 Pt 15 - Restricted Band

Pk - Peak detector

VA1T - FHSS: Linear Voltage Average $V_B=1/T_{on}$ where: T_{on} is transmit duration

8.3.2. AUTHORIZED BANDEDGE (HIGH CHANNEL)

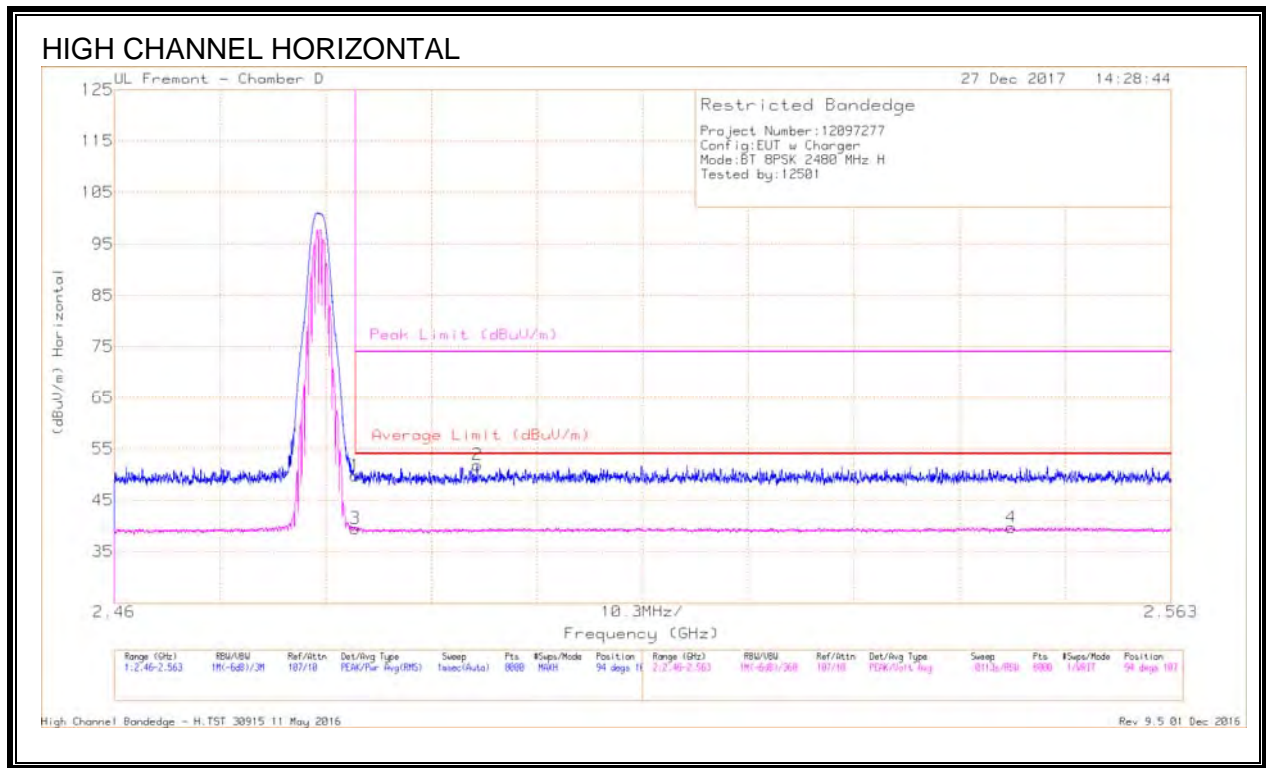

Trace Markers

Marker	Frequency (GHz)	Meter Reading (dBuV)	Det	AF T711 (dB/m)	Amp/Cb/Fltr/Pa d (dB)	Corrected Reading (dBuV/m)	Average Limit (dBuV/m)	Margin (dB)	Peak Limit (dBuV/m)	PK Margin (dB)	Azimuth (Degs)	Height (cm)	Polarity
1	* 2.484	37.74	Pk	32.5	-20.5	49.74	-	-	74	-24.26	94	107	H
2	* 2.495	39.75	Pk	32.6	-20.5	51.85	-	-	74	-22.15	94	107	H
3	* 2.484	27.5	VA1T	32.5	-20.5	39.5	54	-14.5	-	-	94	107	H
4	2.547	27.4	VA1T	32.6	-20.3	39.7	54	-14.3	-	-	94	107	H

* - indicates frequency in CFR47 Pt 15 - Restricted Band

Pk - Peak detector

VA1T - FHSS: Linear Voltage Average $V_B=1/T_{on}$ where: T_{on} is transmit duration

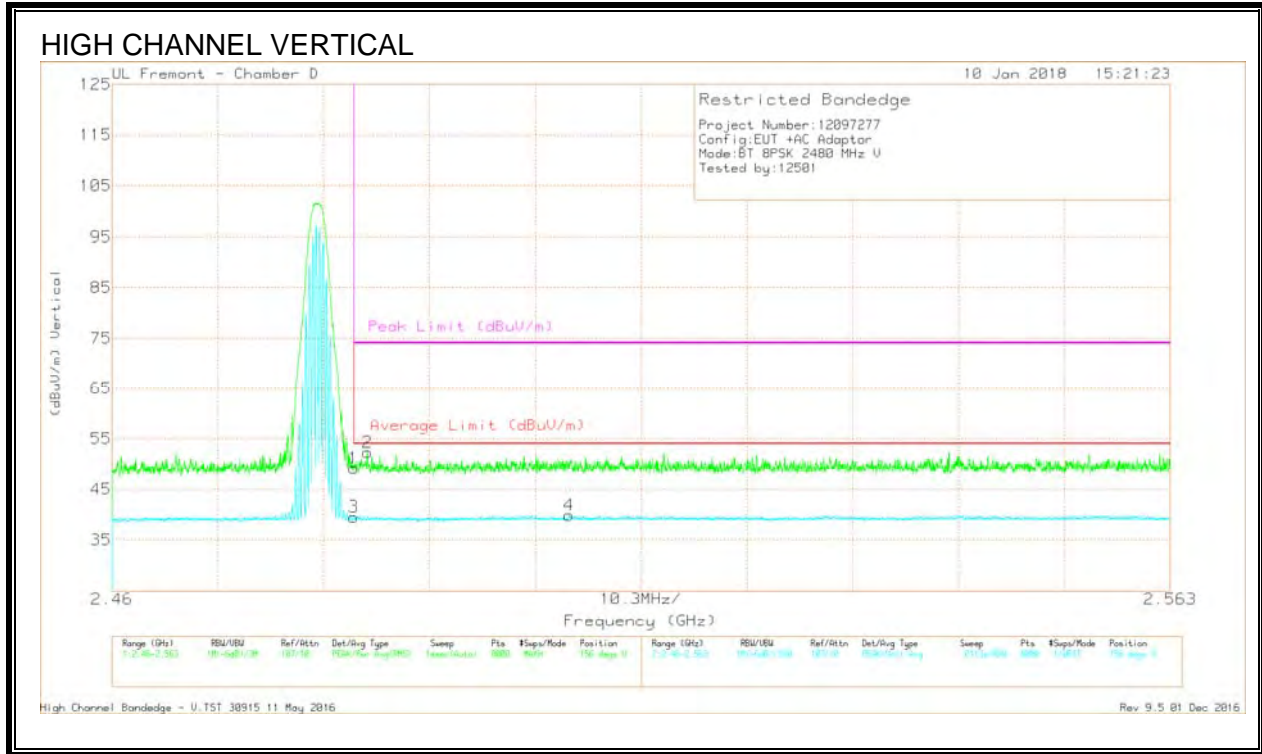

Trace Markers

Marker	Frequency (GHz)	Meter Reading (dBuV)	Det	AF T711 (dB/m)	Amp/Cb/Ftr/Pad (dB)	Corrected Reading (dBuV/m)	Average Limit (dBuV/m)	Margin (dB)	Peak Limit (dBuV/m)	PK Margin (dB)	Azimuth (Degs)	Height (cm)	Polarity
1	* 2.484	37.09	Pk	32.5	-20.4	49.19	-	-	74	-24.81	156	358	V
2	* 2.485	40.2	Pk	32.6	-20.5	52.3	-	-	74	-21.7	156	358	V
3	* 2.484	27.45	VA1T	32.5	-20.4	39.55	54	-14.45	-	-	156	358	V
4	2.505	27.63	VA1T	32.6	-20.4	39.83	54	-14.17	-	-	156	358	V

* - indicates frequency in CFR47 Pt 15 - Restricted Band

Pk - Peak detector

VA1T - FHSS: Linear Voltage Average VB=1/Ton where: Ton is transmit duration

8.3.3. HARMONICS AND SPURIOUS EMISSIONS

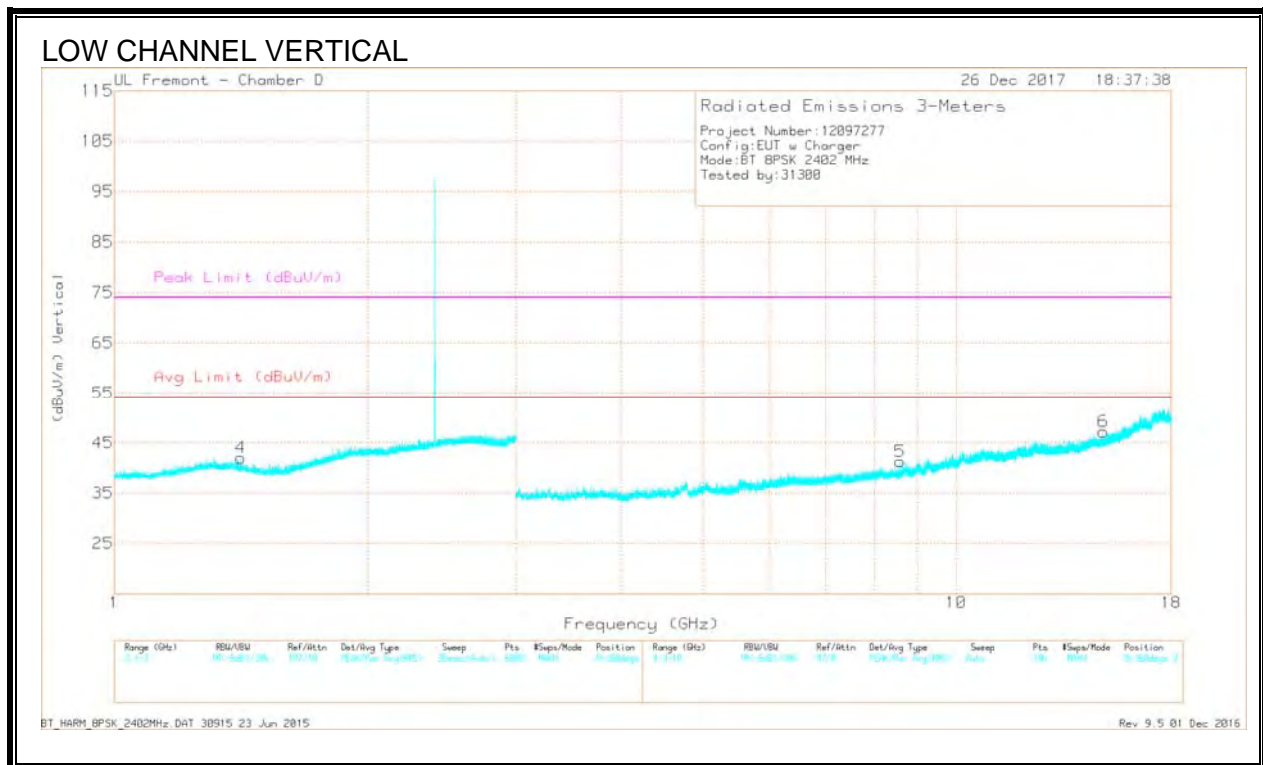
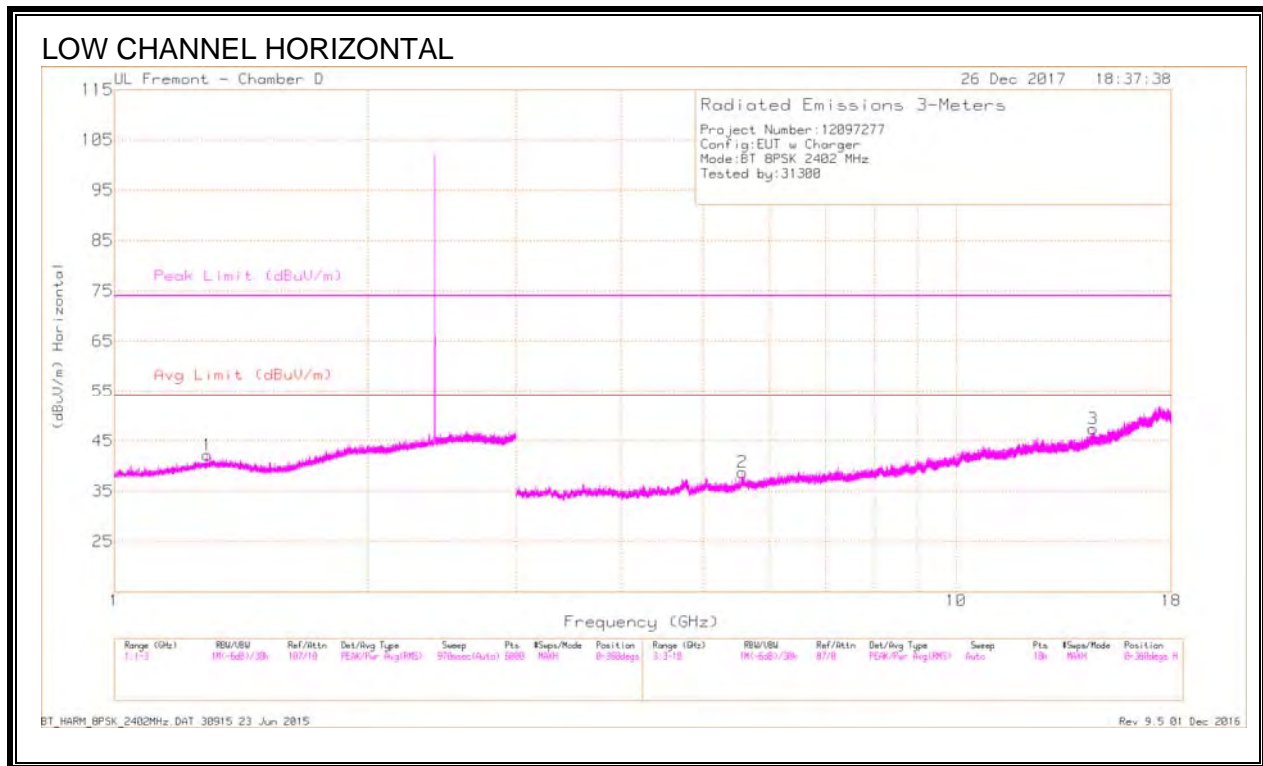

Radiated Emissions

Frequency (GHz)	Meter Reading (dBuV)	Det	AF T711 (dB/m)	Amp/Cbi/Filtr/Pad (dB)	Corrected Reading (dBuV/m)	Avg Limit (dBuV/m)	Margin (dB)	Peak Limit (dBuV/m)	PK Margin (dB)	Azimuth (Degs)	Height (cm)	Polarity
* 1.293	39.19	PKFH	29.5	-22	46.69	-	-	74	-27.31	115	304	H
* 1.287	27.05	VA1T	29.4	-22.1	34.35	54	-19.65	-	-	115	304	H
* 1.411	39.24	PKFH	29.1	-21.9	46.44	-	-	74	-27.56	5	154	V
* 1.417	27.11	VA1T	29	-21.8	34.31	54	-19.69	-	-	5	154	V
5.572	35.07	PKFH	34.6	-26.4	43.27	-	-	74	-30.73	105	184	H
5.575	22.86	VA1T	34.6	-26.4	31.06	-	-	-	-	105	184	H
8.581	32.5	PKFH	35.7	-22.8	45.4	-	-	74	-28.6	4	184	V
8.583	20.37	VA1T	35.7	-22.8	33.27	-	-	-	-	4	184	V
14.538	32.31	PKFH	39.8	-21.4	50.71	-	-	74	-23.29	190	385	H
14.542	21.19	VA1T	39.8	-21.4	39.59	-	-	-	-	190	385	H
14.952	33.25	PKFH	39.8	-21	52.05	-	-	74	-21.95	155	206	V
14.957	20.97	VA1T	39.8	-21	39.77	-	-	-	-	155	206	V

* - indicates frequency in CFR47 Pt 15 - Restricted Band

PKFH - FHSS: RB=100k/1MHz VB=3 x RB, Peak

VA1T - FHSS: Linear Voltage Average VB=1/Ton where: Ton is transmit duration

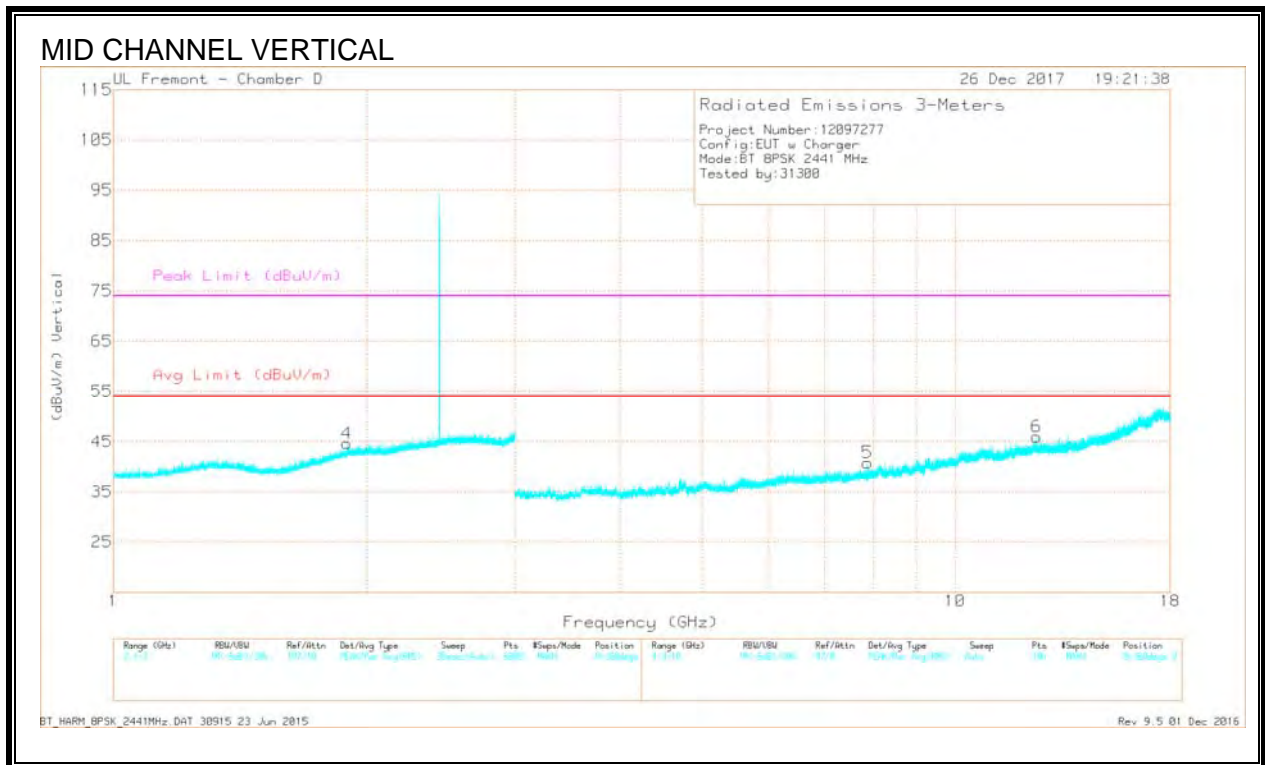
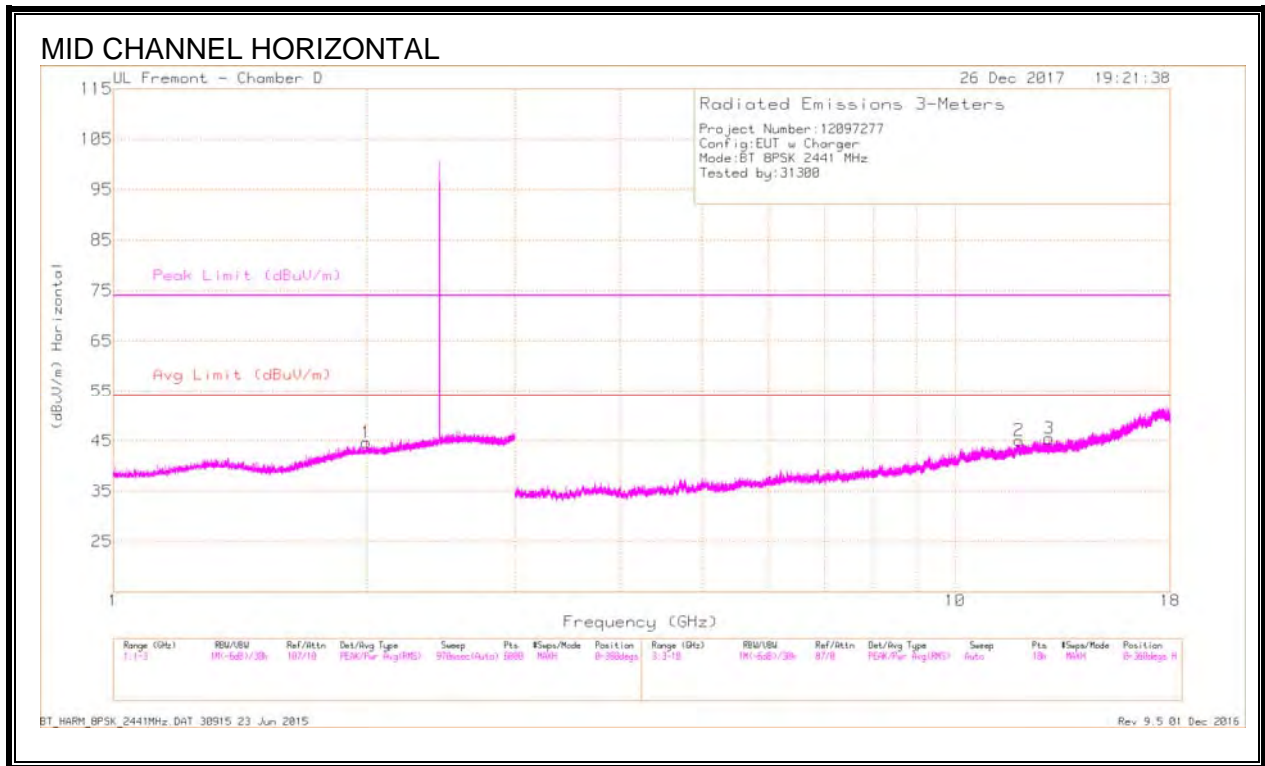

Radiated Emissions

Frequency (GHz)	Meter Reading (dBuV)	Det	AF T711 (dB/m)	Amp/Cbl/Filtr/Prod (dB)	Corrected Reading (dBuV/m)	Avg Limit (dBuV/m)	Margin (dB)	Peak Limit (dBuV/m)	PK Margin (dB)	Azimuth (Degs)	Height (cm)	Polarity
* 11.911	30.77	PKFH	38.5	-20.1	49.17	-	-	74	-24.83	359	371	H
* 11.913	19.23	VA1T	38.5	-20.1	37.63	54	-16.37	-	-	359	371	H
* 12.489	31.22	PKFH	38.9	-20	50.12	-	-	74	-23.88	203	166	V
* 12.49	19.28	VA1T	38.9	-20	38.18	54	-15.82	-	-	203	166	V
1.895	26.94	VA1T	31.3	-21.1	37.14	-	-	-	-	323	291	V
1.896	39.05	PKFH	31.3	-21.1	49.25	-	-	74	-24.75	323	291	V
2	39.34	PKFH	31.4	-21.1	49.64	-	-	74	-24.36	305	243	H
2.001	27.06	VA1T	31.4	-21.1	37.36	-	-	-	-	305	243	H
7.87	33.42	PKFH	35.6	-23.8	45.22	-	-	74	-28.78	199	248	V
7.87	21.15	VA1T	35.6	-23.8	32.95	-	-	-	-	199	248	V
12.93	19.87	VA1T	39	-20.8	38.07	-	-	-	-	245	255	H
12.933	31.87	PKFH	39	-20.9	49.97	-	-	74	-24.03	245	255	H

* - indicates frequency in CFR47 Pt 15 - Restricted Band

PKFH - FHSS: RB=100k/1MHz VB=3 x RB, Peak

VA1T - FHSS: Linear Voltage Average VB=1/Ton where: Ton is transmit duration

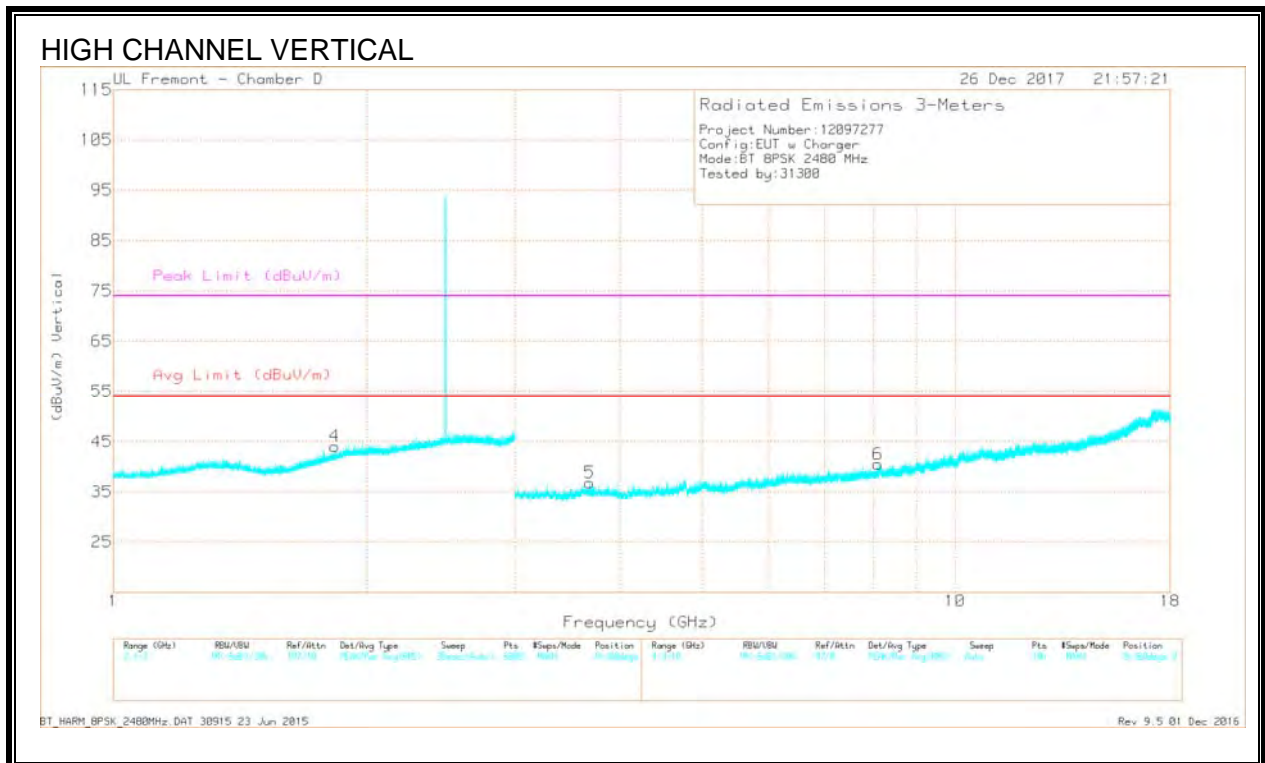
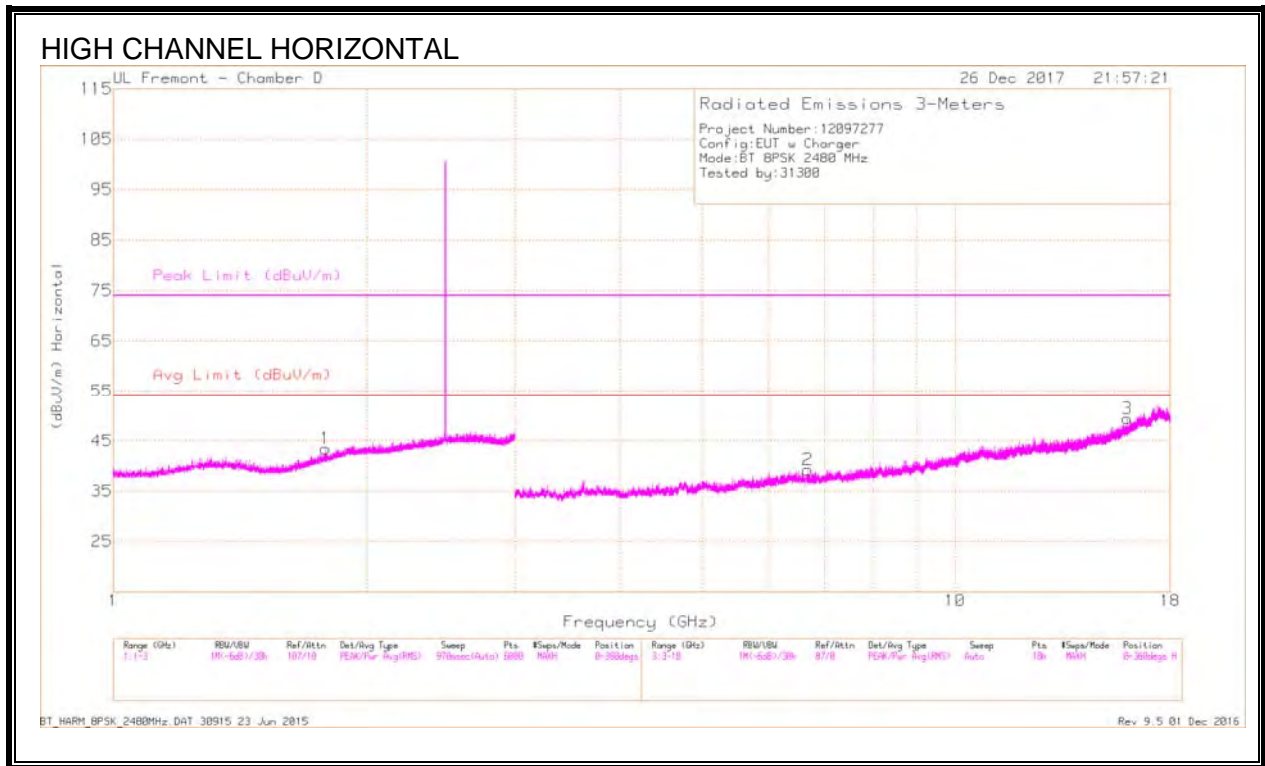

Radiated Emissions

Frequency (GHz)	Meter Reading (dBuV)	Det	AF T711 (dB/m)	Amp/Cbl/Filtr/Pad (dB)	Corrected Reading (dBuV/m)	Avg Limit (dBuV/m)	Margin (dB)	Peak Limit (dBuV/m)	PK Margin (dB)	Azimuth (Degs)	Height (cm)	Polarity
* 16.016	31.59	PKFH	40.9	-18.9	53.59	-	-	74	-20.41	132	383	H
* 16.012	19.69	VA1T	40.9	-19	41.59	54	-12.41	-	-	132	383	H
* 3.682	36.07	PKFH	33	-28.7	40.37	-	-	74	-33.63	354	380	V
* 3.681	24.29	VA1T	33	-28.7	28.59	54	-25.41	-	-	354	380	V
* 8.095	32.68	PKFH	35.6	-23.2	45.08	-	-	74	-28.92	290	313	V
* 8.095	20.92	VA1T	35.6	-23.2	33.32	54	-20.68	-	-	290	313	V
1.787	27	VA1T	30.2	-21.3	35.9	-	-	-	-	236	341	H
1.79	39.42	PKFH	30.2	-21.2	48.42	-	-	74	-25.58	236	341	H
1.832	39.19	PKFH	30.6	-21.2	48.59	-	-	74	-25.41	10	108	V
1.832	26.98	VA1T	30.6	-21.2	36.38	-	-	-	-	10	108	V
6.685	22.01	VA1T	35.6	-25.8	31.81	-	-	-	-	156	317	H
6.686	34.22	PKFH	35.6	-25.8	44.02	-	-	74	-29.98	156	317	H

* - indicates frequency in CFR47 Pt 15 - Restricted Band

PKFH - FHSS: RB=100k/1MHz VB=3 x RB, Peak

VA1T - FHSS: Linear Voltage Average VB=1/Ton where: Ton is transmit duration

8.4. WORST-CASE BELOW 30 MHz

SPURIOUS EMISSIONS BELOW 30 MHz (WORST-CASE CONFIGURATION)

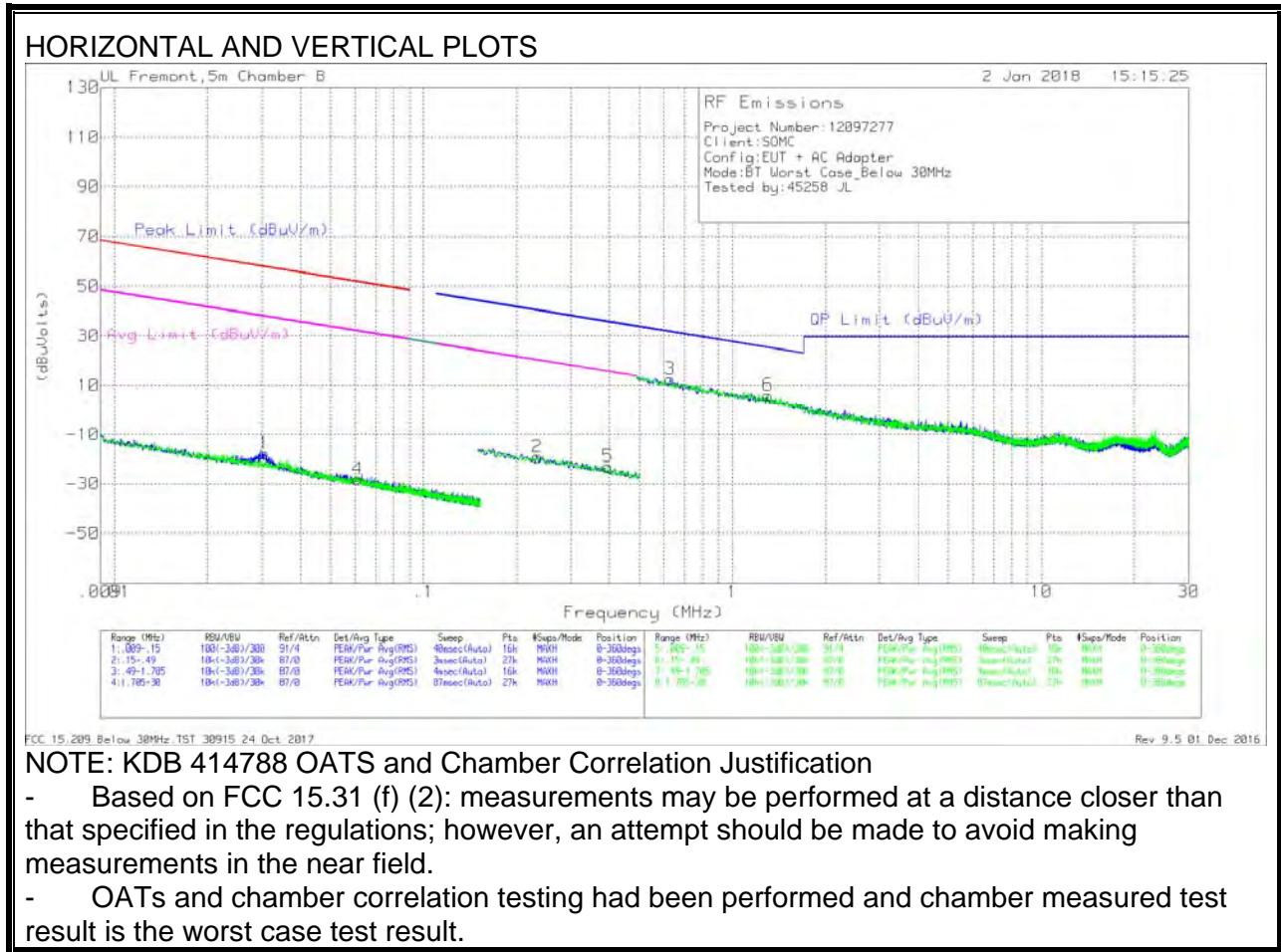

NOTE: KDB 414788 OATS and Chamber Correlation Justification

- Based on FCC 15.31 (f) (2): measurements may be performed at a distance closer than that specified in the regulations; however, an attempt should be made to avoid making measurements in the near field.
- OATs and chamber correlation testing had been performed and chamber measured test result is the worst case test result.

Trace Markers

Marker	Frequency (MHz)	Meter Reading (dBuV)	Det	Loop Antenna (dB/m)	Qf (dB)	Dist Corr 30cm (dB)	Corrected Reading (dBuV)	Peak Limit (dBuV/m)	Margin (dB)	Avg Limit (dBuV/m)	Margin (dB)	Peak Limit (dBuV/m)	Margin (dB)	Avg Limit (dBuV/m)	Margin (dB)	Azimuth (Degs)
1	.03053	45.4	Pk	15.5	1.4	-80	-17.7	57.89	-75.59	37.89	-55.59	-	-	-	-	0-360
4	.06133	35.97	Pk	14.5	1.4	-80	-28.13	51.83	-79.96	31.83	-59.96	-	-	-	-	0-360
2	.23357	45.38	Pk	13.9	1.5	-80	-19.22	-	-	-	-	40.25	-59.47	20.25	-39.47	0-360
5	.3956	41.71	Pk	13.8	1.5	-80	-22.99	-	-	-	-	35.66	-58.65	15.66	-38.65	0-360

Pk - Peak detector

Marker	Frequency (MHz)	Meter Reading (dBuV)	Det	Loop Antenna (dB/m)	Qf (dB)	Dist Corr (dB) 40Log	Corrected Reading (dBuV)	QP Limit (dBuV/m)	Margin (dB)	Azimuth (Degs)
3	.62931	37.09	Pk	14	1.5	-40	12.59	31.63	-19.04	0-360
6	1.30381	30.26	Pk	14.3	1.5	-40	6.06	25.32	-19.26	0-360

Pk - Peak detector

8.5. WORST-CASE BELOW 1 GHz

SPURIOUS EMISSIONS 30 TO 1000 MHz (WORST-CASE CONFIGURATION)

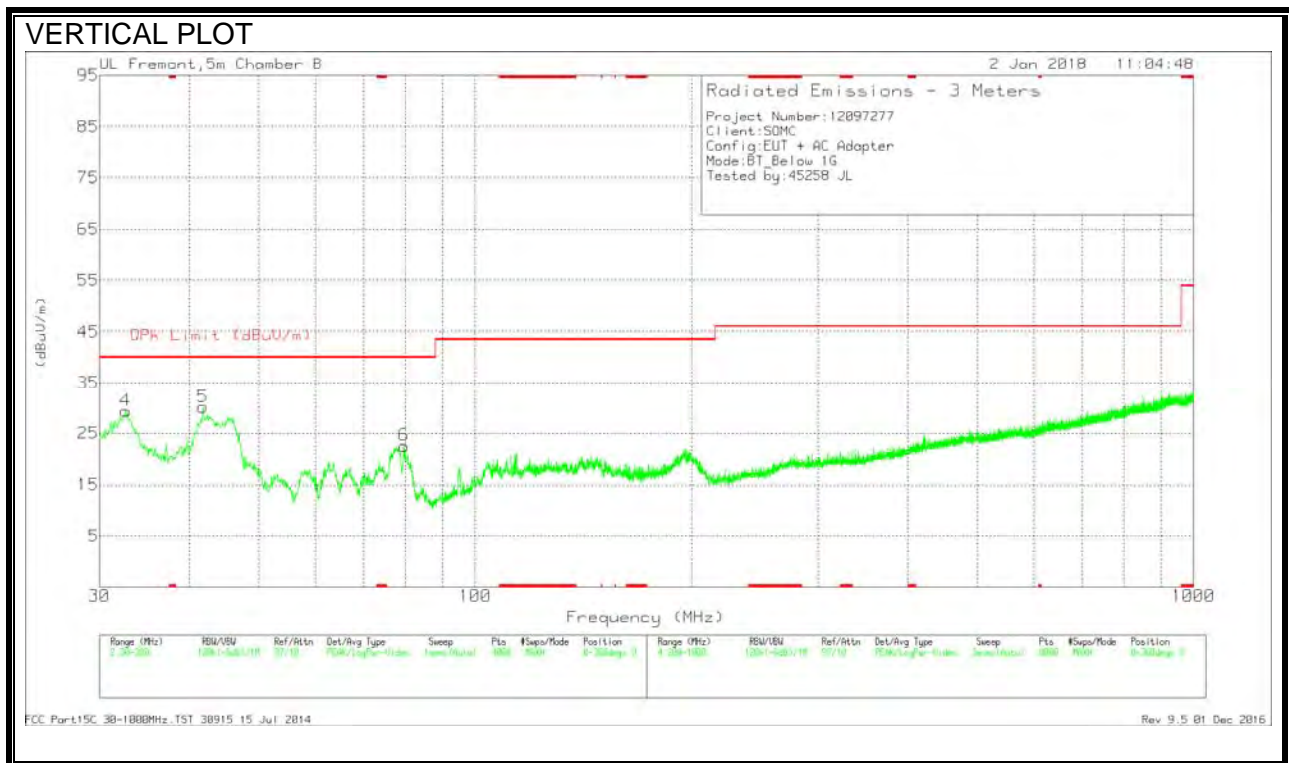
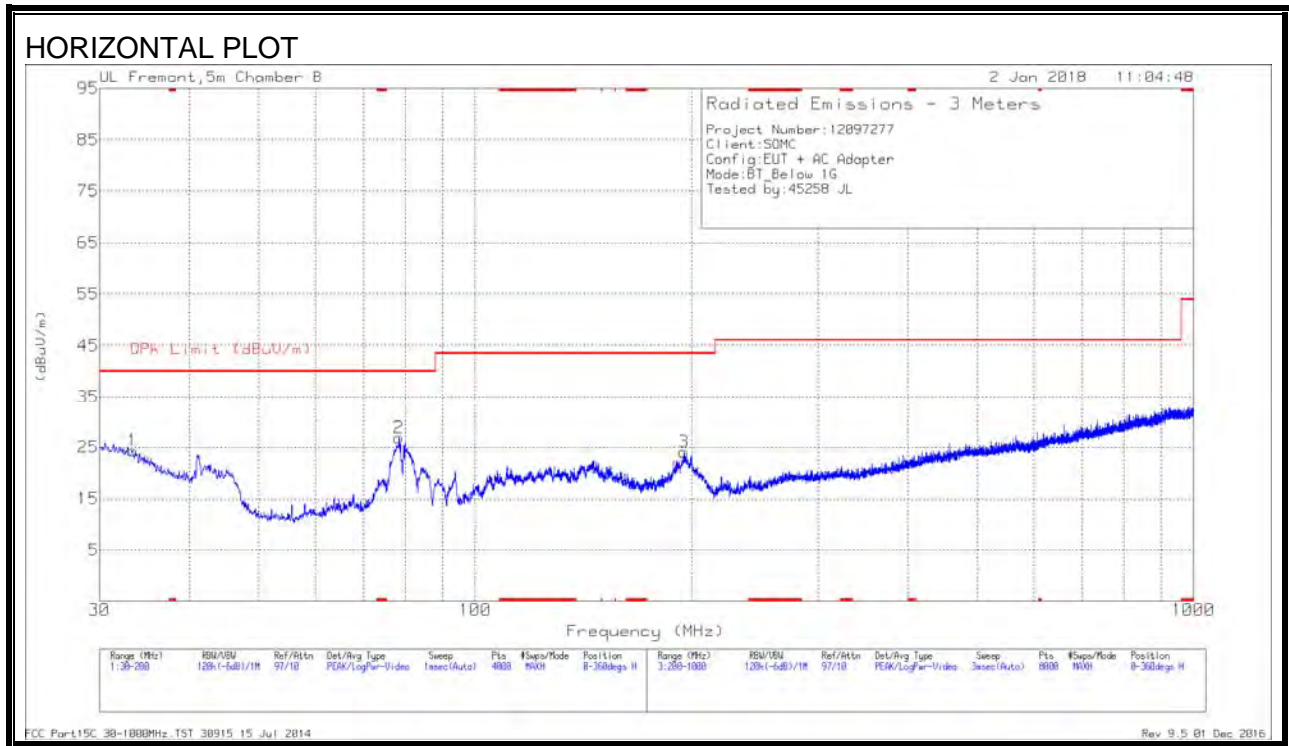

DATA

Trace Markers

Marker	Frequency (MHz)	Meter Reading (dBuV)	Det	AF T899 (dB/m)	Amp/Cbl (dB)	Corrected Reading (dBuV/m)	QPk Limit (dBuV/m)	Margin (dB)	Azimuth (Degs)	Height (cm)	Polarity
4	32.6357	34.63	Pk	23.6	-28.8	29.43	40	-10.57	0-360	100	V
1	33.3584	30.09	Pk	23.1	-28.8	24.39	40	-15.61	0-360	200	H
5	41.8181	41.97	Pk	16.8	-28.6	30.17	40	-9.83	0-360	100	V
2	78.335	43.66	Pk	11.4	-28.2	26.86	40	-13.14	0-360	200	H
6	79.5678	39.62	Pk	11.2	-28.2	22.62	40	-17.38	0-360	100	V
3	195.4103	35.02	Pk	15.9	-26.9	24.02	43.52	-19.5	0-360	100	H

Pk - Peak detector

8.6. WORST-CASE ABOVE 18 GHz

SPURIOUS EMISSIONS 18 TO 26 GHz (WORST-CASE CONFIGURATION)

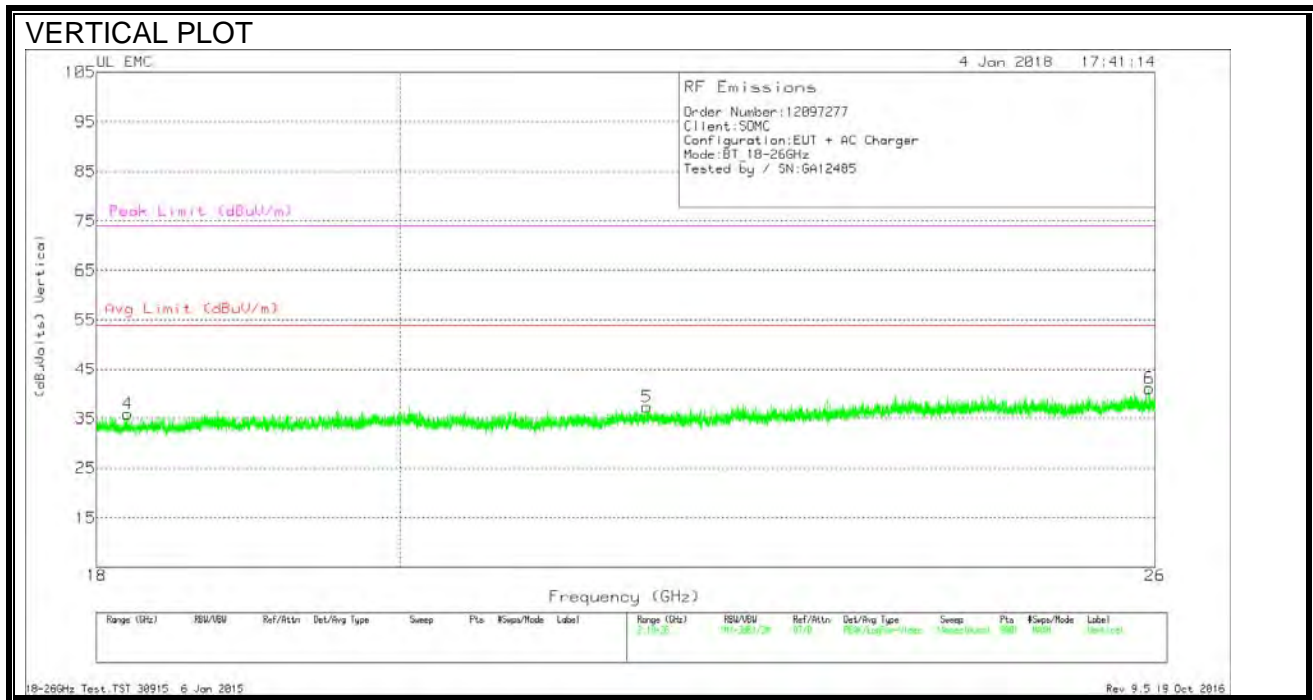
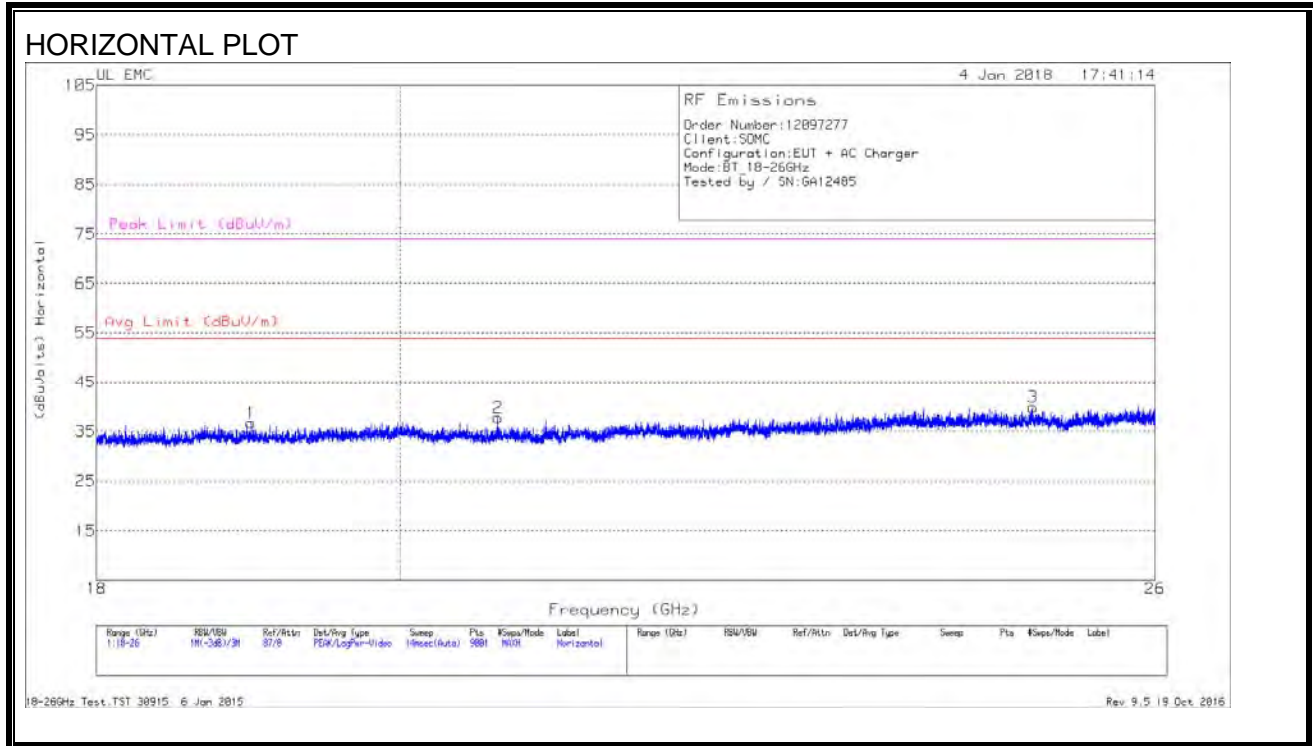

Data

Trace Markers

Marker	Frequency (GHz)	Meter Reading (dBuV)	Det	T89 AF (dB/m)	Amp/Cbl (dB)	Dist Corr (dB)	Corrected Reading (dBuVolts)	Avg Limit (dBuV/m)	Margin (dB)	Peak Limit (dBuV/m)	PK Margin (dB)
1	18.994	38.91	Pk	32.2	-24.9	-9.5	36.71	54	-17.29	74	-37.29
2	20.692	39.63	Pk	32.8	-25.2	-9.5	37.73	54	-16.27	74	-36.27
3	24.917	39.49	Pk	34.1	-24.2	-9.5	39.89	54	-14.11	74	-34.11
4	18.195	38.38	Pk	32.4	-25.4	-9.5	35.88	54	-18.12	74	-38.12
5	21.789	38.33	Pk	33.3	-24.8	-9.5	37.33	54	-16.67	74	-36.67
6	25.945	41.74	Pk	33.8	-25	-9.5	41.04	54	-12.96	74	-32.96

Pk - Peak detector

9. AC POWER LINE CONDUCTED EMISSIONS

LIMITS

FCC §15.207 (a)

Frequency of Emission (MHz)	Conducted Limit (dB μ V)	
	Quasi-peak	Average
0.15-0.5	66 to 56 *	56 to 46 *
0.5-5	56	46
5-30	60	50

*Decreases with the logarithm of the frequency.

TEST PROCEDURE

The EUT is placed on a non-conducting table 40 cm from the vertical ground plane and 80 cm above the horizontal ground plane. The EUT is configured in accordance with ANSI C63.10.

The receiver is set to a resolution bandwidth of 9 kHz. Peak detection is used unless otherwise noted as quasi-peak or average.

Line conducted data is recorded for both NEUTRAL and HOT lines.

RESULTS

LINE 1 RESULTS

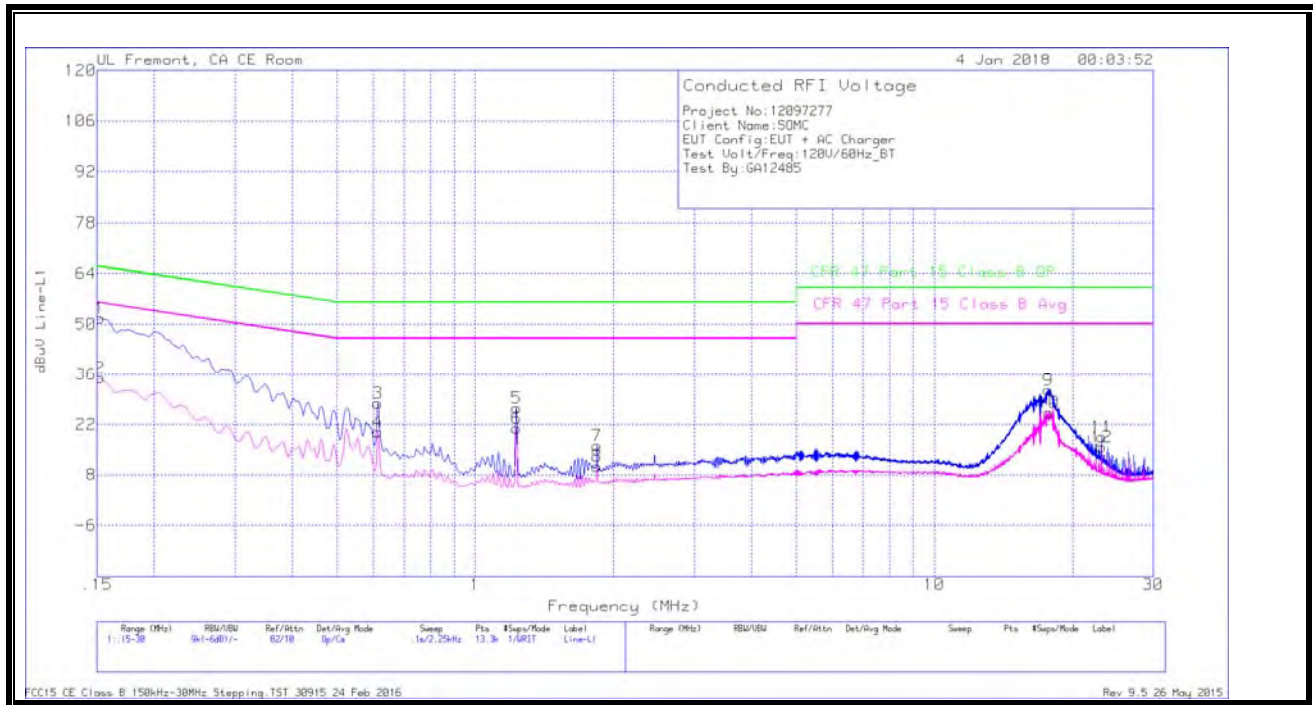

WORST EMISSIONS

Range 1: Line-L1 .15 - 30MHz											
Marker	Frequency (MHz)	Meter Reading (dBuV)	Det	LISN L1	LC Cables C1&C3	Limiter (dB)	Corrected Reading dBuV	CFR 47 Part 15 Class B QP	QP Margin (dB)	CFR 47 Part 15 Class B Avg	Av(CISPR) Margin (dB)
1	.15225	41.52	Qp	.1	0	10.1	51.72	65.88	-14.16	-	-
2	.15225	24.9	Ca	.1	0	10.1	35.1	-	-	55.88	-20.78
3	.6135	17.82	Qp	0	0	10.1	27.92	56	-28.08	-	-
4	.6135	9.75	Ca	0	0	10.1	19.85	-	-	46	-26.15
5	1.23	16.39	Qp	0	.1	10.1	26.59	56	-29.41	-	-
6	1.23	10.74	Ca	0	.1	10.1	20.94	-	-	46	-25.06
7	1.84425	5.84	Qp	0	.1	10.1	16.04	56	-39.96	-	-
8	1.84425	.25	Ca	0	.1	10.1	10.45	-	-	46	-35.55
9	17.73375	21.03	Qp	0	.3	10.3	31.63	60	-28.37	-	-
10	17.76525	14.66	Ca	0	.3	10.3	25.26	-	-	50	-24.74
11	23.1315	7.75	Qp	.1	.3	10.4	18.55	60	-41.45	-	-
12	23.1315	4.98	Ca	.1	.3	10.4	15.78	-	-	50	-34.22

Qp - Quasi-Peak detector

Ca - CISPR average detection

LINE 2 RESULTS

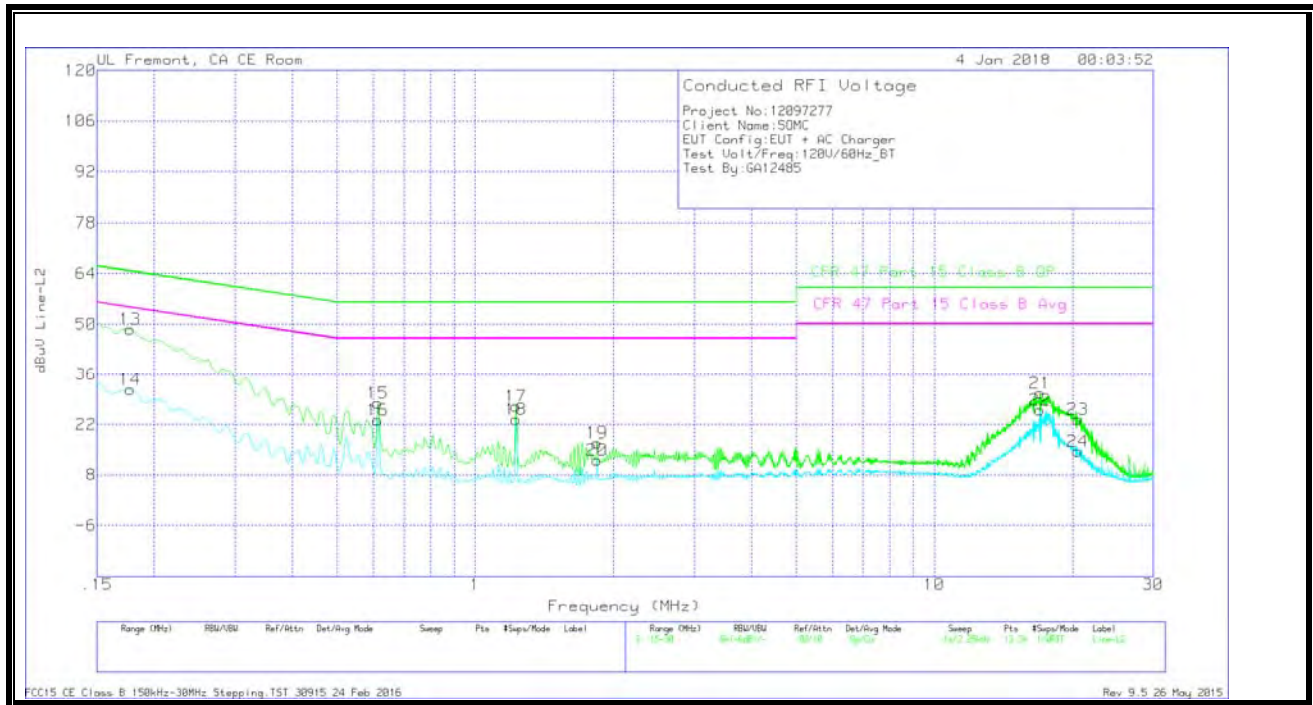

WORST EMISSIONS

Range 2: Line-L2 .15 - 30MHz												
Marker	Frequency (MHz)	Meter Reading (dBuV)	Det	LISN L2	LC Cables C2&C3	Limiter (dB)	Corrected Reading (dBuV)	CFR 47 Part 15 Class B QP	QP Margin (dB)	CFR 47 Part 15 Class B Avg	Av(CISPR) Margin (dB)	
13	.177	38.56	Qp	0	0	10.1	48.66	64.63	-15.97	-	-	
14	.177	21.7	Ca	0	0	10.1	31.8	-	-	54.63	-22.83	
15	.6135	17.78	Qp	0	0	10.1	27.88	56	-28.12	-	-	
16	.6135	13.13	Ca	0	0	10.1	23.23	-	-	46	-22.77	
17	1.22775	16.8	Qp	0	.1	10.1	27	56	-29	-	-	
18	1.22775	13.27	Ca	0	.1	10.1	23.47	-	-	46	-22.53	
19	1.84425	6.68	Qp	0	.1	10.1	16.88	56	-39.12	-	-	
20	1.84425	1.88	Ca	0	.1	10.1	12.08	-	-	46	-33.92	
21	16.9935	20.09	Qp	0	.3	10.3	30.69	60	-29.31	-	-	
22	16.99125	15.37	Ca	0	.3	10.3	25.97	-	-	50	-24.03	
23	20.53725	12.68	Qp	0	.3	10.4	23.38	60	-36.62	-	-	
24	20.53725	3.77	Ca	0	.3	10.4	14.47	-	-	50	-35.53	

Qp - Quasi-Peak detector

Ca - CISPR average detection