



FCC RADIO TEST REPORT

FCC ID : PY7-24117P
Equipment : GSM/WCDMA/LTE Phone with BT, DTS/UNII
a/b/g/n/ac, GPS and NFC
Brand Name : Sony
Applicant : Sony Mobile Communications Inc.
4-12-3 HIGASHI-SHINAGAWA,
SHINAGAWA-KU, TOKYO, 140-0002, JAPAN
Manufacturer : Sony Mobile Communications Inc.
4-12-3 HIGASHI-SHINAGAWA,
SHINAGAWA-KU, TOKYO, 140-0002, JAPAN
Standard : 47 CFR Part 2, 22(H), 24(E), 27(L)

The product was received on Nov. 01, 2018 and testing was started from Feb. 15, 2019 and completed on Feb. 21, 2019. We, SPORTON INTERNATIONAL INC. EMC & Wireless Communications Laboratory, would like to declare that the tested sample has been evaluated in accordance with the test procedures given in ANSI / TIA-603-E and has been in compliance with the applicable technical standards.

The report must not be used by the client to claim product certification, approval, or endorsement by TAF or any agency of government.

The test results in this report apply exclusively to the tested model / sample. Without written approval of SPORTON INTERNATIONAL INC. EMC & Wireless Communications Laboratory, the test report shall not be reproduced except in full.

Approved by: Jones Tsai

SPORTON INTERNATIONAL INC. EMC & Wireless Communications Laboratory
No. 52, Huaya 1st Rd., Guishan Dist., Taoyuan City, Taiwan (R.O.C.)



Table of Contents

History of this test report.....3

Summary of Test Result.....4

1 General Description5

 1.1 Product Feature of Equipment Under Test5

 1.2 Modification of EUT5

 1.3 Maximum ERP/EIRP Power, Frequency Tolerance, and Emission Designator6

 1.4 Testing Location7

 1.5 Applicable Standards7

2 Test Configuration of Equipment Under Test8

 2.1 Test Mode.....8

 2.2 Connection Diagram of Test System9

 2.3 Support Unit used in test configuration9

 2.4 Measurement Results Explanation Example9

 2.5 Frequency List of Low/Middle/High Channels.....10

3 Conducted Test Result11

 3.1 Measuring Instruments.....11

 3.2 Conducted Output Power and ERP/EIRP12

 3.3 Peak-to-Average Ratio.....13

 3.4 99% Occupied Bandwidth and 26dB Bandwidth Measurement.....14

 3.5 Conducted Band Edge15

 3.6 Conducted Spurious Emission16

 3.7 Frequency Stability.....17

4 Radiated Test Items18

 4.1 Measuring Instruments.....18

 4.2 Test Setup18

 4.3 Test Result of Radiated Test.....18

 4.4 Field Strength of Spurious Radiation Measurement19

5 List of Measuring Equipment.....20

6 Uncertainty of Evaluation.....22

Appendix A. Test Results of Conducted Test

Appendix B. Test Results of ERP/EIRP and Radiated Test



History of this test report

Report No.	Version	Description	Issued Date
FG8O2417-03A	01	Initial issue of report	Mar. 06, 2019



Summary of Test Result

Report Clause	Ref Std. Clause	Test Items	Result (PASS/FAIL)	Remark
3.2	§2.1046	Conducted Output Power	Pass	-
	§22.913 (a)(2)	Effective Radiated Power		
	§24.232 (c)	Equivalent Isotropic Radiated Power		
	§27.50 (d)(4)	Equivalent Isotropic Radiated Power		
3.3	§24.232 (d)	Peak-to-Average Ratio	Pass	-
3.4	§2.1049 §22.917 (b) §24.238 (b) §27.53 (g)	Occupied Bandwidth	Pass	-
3.5	§2.1051 §22.917 (a) §24.238 (a) §27.53 (g)	Band Edge Measurement	Pass	-
3.6	§2.1051 §22.917 (a) §24.238 (a) §27.53 (g)	Conducted Emission	Pass	-
3.7	§2.1055 §22.355	Frequency Stability Temperature & Voltage	Pass	-
	§2.1055 §24.235 §27.54			-
4.4	§2.1053 §22.917 (a) §24.238 (a) §27.53 (h)	Field Strength of Spurious Radiation	Pass	Under limit 32.45 dB at 3344.000 MHz

Declaration of Conformity:

The test results with all measurement uncertainty excluded are presented in accordance with the regulation limits or requirements declared by manufacturers.

Comments and Explanations:

The declared of product specification for EUT presented in the report are provided by the manufacturer, and the manufacturer takes all the responsibilities for the accuracy of product specification.

Reviewed by: Wii Chang

Report Producer: Natasha Hsieh



1 General Description

1.1 Product Feature of Equipment Under Test

GSM/WCDMA/LTE, Bluetooth, DTS/UNII a/b/g/n/ac, NFC, and GNSS.

Standards-related Product Specification	
Antenna Type	Monopole / Loop Antenna

EUT Information List			
HW Version	SW Version	S/N	Performed Test Item
A	1.63	BH97002AFU	Conducted Measurement ERP/EIRP Test
		BH9700G3FR	Radiated Spurious Emission

Accessory List	
AC Adapter	Model No. : UCH32
	S/N: 6218W30200140
Earphone	Model No.: MH750
	S/N : N/A
USB Cable	Model No.: UCB24
	S/N : N/A
2 in 1 USB Audio Cable	Model No.: EC270
	S/N : N/A

Note:

1. Above EUT list used are electrically identical per declared by manufacturer.
2. Above the accessories list are used to exercise the EUT during test, and the serial number of each type of accessories is listed in each section of this report. .
3. For other wireless features of this EUT, test report will be issued separately.

1.2 Modification of EUT

No modifications are made to the EUT during all test items.



1.3 Maximum ERP/EIRP Power, Frequency Tolerance, and Emission Designator

FCC Rule	Frequency Range (MHz)	System	Type of Modulation	Maximum ERP/EIRP (W)	Frequency Tolerance (ppm)	Emission Designator
Part 22	824.2 ~848.8	GSM850 GPRS class 8	GMSK	0.4227	0.0120 ppm	245KGXW
Part 22	824.2 ~848.8	GSM850 EDGE class 8	8PSK	0.1521	0.0179 ppm	247KG7W
Part 22	826.4 ~846.6	WCDMA Band V RMC 12.2Kbps	BPSK	0.0818	0.0155 ppm	4M15F9W
Part 24	1850.2 ~1909.8	GSM1900 GPRS class 8	GMSK	0.2018	0.0053 ppm	246KGXW
Part 24	1850.2 ~1909.8	GSM1900 EDGE class 8	8PSK	0.1358	0.0080 ppm	244KG7W
Part 24	1852.4 ~ 1907.6	WCDMA Band II RMC 12.2Kbps	BPSK	0.0279	0.0021 ppm	4M16F9W
Part 27	1712.4 ~ 1752.6	WCDMA Band IV RMC 12.2Kbps	BPSK	0.0899	0.0075 ppm	4M16F9W



1.4 Testing Location

Test Site	SPORTON INTERNATIONAL INC.
Test Site Location	No.52, Huaya 1st Rd., Guishan Dist., Taoyuan City, Taiwan (R.O.C.) TEL: +886-3-327-3456 FAX: +886-3-328-4978
Test Site No.	Sporton Site No.
	TH03-HY

Note: The test site complies with ANSI C63.4 2014 requirement.

Test Site	SPORTON INTERNATIONAL INC.
Test Site Location	No.58, Aly. 75, Ln. 564, Wenhua 3rd, Rd., Guishan Dist., Taoyuan City, Taiwan (R.O.C.) TEL: +886-3-327-0868 FAX: +886-3-327-0855
Test Site No.	Sporton Site No.
	03CH10-HY

Note: The test site complies with ANSI C63.4 2014 requirement.

FCC Designation No.: TW1190 and TW0007

1.5 Applicable Standards

According to the specifications of the manufacturer, the EUT must comply with the requirements of the following standards:

- ♦ ANSI C63.26-2015
- ♦ ANSI / TIA-603-E
- ♦ 47 CFR Part 2, 22(H), 24(E), 27(L)
- ♦ FCC KDB 971168 D01 Power Meas. License Digital Systems v03r01
- ♦ FCC KDB 412172 D01 Determining ERP and EIRP v01r01

Remark:

1. All test items were verified and recorded according to the standards and without any deviation during the test.
2. This EUT has also been tested and complied with the requirements of FCC Part 15, Subpart B, recorded in a separate test report.



2 Test Configuration of Equipment Under Test

2.1 Test Mode

Antenna port conducted and radiated test items were performed according to KDB 971168 D01 Power Meas. License Digital Systems v03r01 with maximum output power.

For radiated measurement, pre-scanned in three orthogonal panels, X, Y, Z. The worst cases (Y plane) were recorded in this report.

Radiated emissions were investigated as following frequency range:

1. 30 MHz to 9000 MHz for GSM850 and WCDMA Band V
2. 30 MHz to 18000 MHz for WCDMA Band IV.
3. 30 MHz to 19100 MHz for GSM1900 and WCDMA Band II.

All modes and data rates and positions were investigated.

Test modes are chosen to be reported as the worst case configuration below:

Test Modes		
Band	Radiated TCs	Conducted TCs
GSM 850	■ GPRS Class 8 Link ■ EDGE Class 8 Link	■ GPRS Class 8 Link ■ EDGE Class 8 Link
GSM 1900	■ GPRS Class 8 Link ■ EDGE Class 8 Link	■ GPRS Class 8 Link ■ EDGE Class 8 Link
WCDMA Band V	■ RMC 12.2Kbps Link	■ RMC 12.2Kbps Link
WCDMA Band II	■ RMC 12.2Kbps Link	■ RMC 12.2Kbps Link
WCDMA Band IV	■ RMC 12.2Kbps Link	■ RMC 12.2Kbps Link

2.2 Connection Diagram of Test System

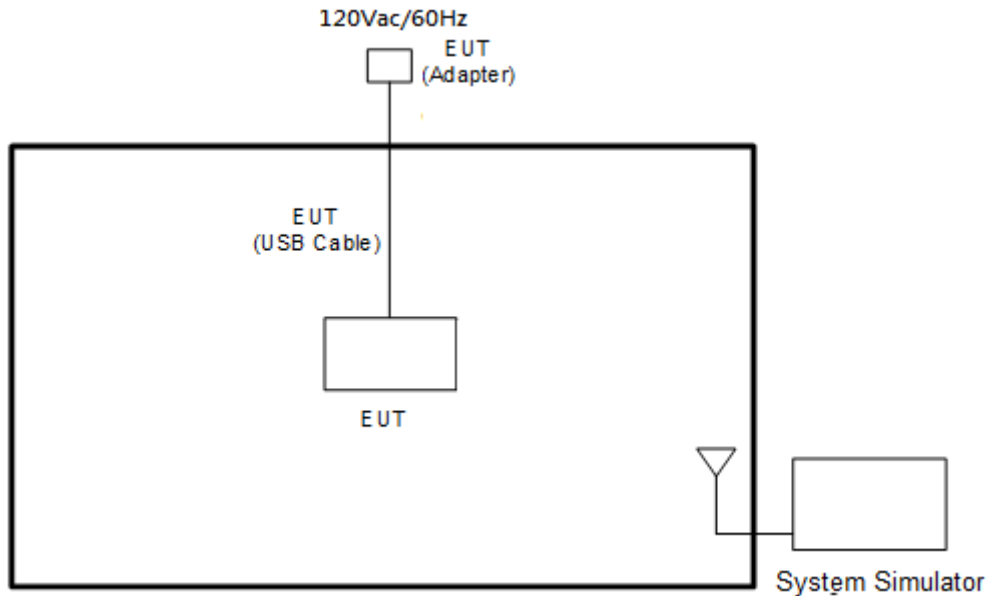

2.3 Support Unit used in test configuration

Item	Equipment	Trade Name	Model No.	FCC ID	Data Cable	Power Cord
1.	System Simulator	Anritsu	8820C	N/A	N/A	Unshielded, 1.8 m
2.	System Simulator	Anritsu	MT8821C	N/A	N/A	Unshielded, 1.8 m

2.4 Measurement Results Explanation Example

For all conducted test items:

The offset level is set in the spectrum analyzer to compensate the RF cable loss and attenuator factor between RF conducted output port and spectrum analyzer. With the offset compensation, the spectrum analyzer reading level will be exactly the RF output level.

The spectrum analyzer offset is derived from RF cable loss and attenuator factor.

Offset = RF cable loss + attenuator factor.

The following shows an offset computation example with RF cable loss 4.2 dB and a 10dB attenuator.

Example:

$$\begin{aligned} \text{Offset(dB)} &= \text{RF cable loss(dB)} + \text{attenuator factor(dB)}. \\ &= 4.2 + 10 = 14.2 \text{ (dB)} \end{aligned}$$



2.5 Frequency List of Low/Middle/High Channels

Frequency List				
Band	Channel/Frequency(MHz)	Lowest	Middle	Highest
GSM850	Channel	128	189	251
	Frequency	824.2	836.4	848.8
WCDMA Band V	Channel	4132	4182	4233
	Frequency	826.4	836.4	846.6
GSM1900	Channel	512	661	810
	Frequency	1850.2	1880.0	1909.8
WCDMA Band II	Channel	9262	9400	9538
	Frequency	1852.4	1880.0	1907.6
WCDMA Band IV	Channel	1312	1413	1513
	Frequency	1712.4	1732.6	1752.6

3 Conducted Test Result

3.1 Measuring Instruments

See list of measuring instruments of this test report.

3.1.1 Test Setup

3.1.2 Conducted Output Power

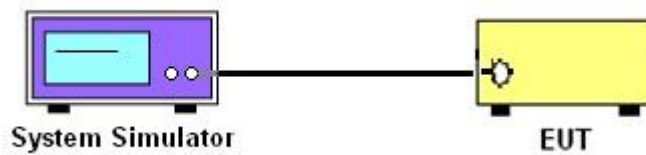

3.1.3 Peak-to-Average Ratio, Occupied Bandwidth, Conducted Band-Edge and Conducted Spurious Emission

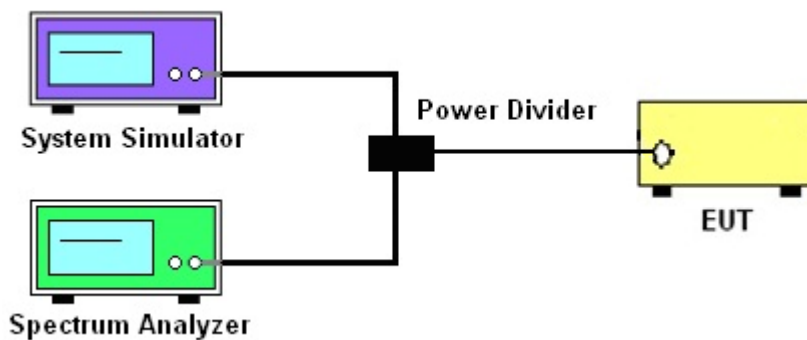

3.1.4 Frequency Stability

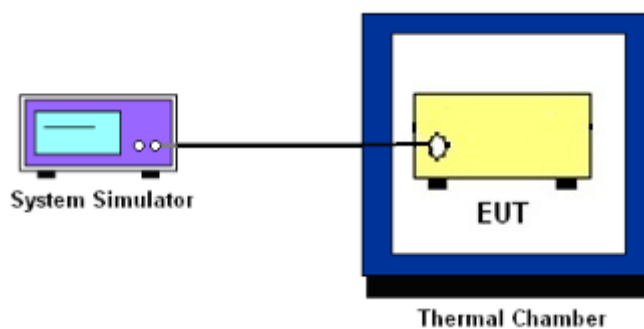

3.1.5 Test Result of Conducted Test

Please refer to Appendix A.



3.2 Conducted Output Power and ERP/EIRP

3.2.1 Description of the Conducted Output Power and ERP/EIRP

A system simulator was used to establish communication with the EUT. Its parameters were set to enforce EUT transmitting at the maximum power. The measured power in the radio frequency on the transmitter output terminals shall be reported.

The ERP of mobile transmitters must not exceed 7 Watts for GSM850 and WCDMA Band V.

The EIRP of mobile transmitters must not exceed 2 Watts for GSM1900 and WCDMA Band II.

The EIRP of mobile transmitters must not exceed 1 Watts for WCDMA Band IV.

According to KDB 412172 D01 Power Approach,

$EIRP = P_T + G_T - L_C$, $ERP = EIRP - 2.15$, where

P_T = transmitter output power in dBm

G_T = gain of the transmitting antenna in dBi

L_C = signal attenuation in the connecting cable between the transmitter and antenna in dB

3.2.2 Test Procedures

1. The transmitter output port was connected to the system simulator.
2. Set EUT at maximum power through system simulator.
3. Select lowest, middle, and highest channels for each band and different modulation.
4. Measure the maximum burst average power for GSM and maximum average power for other modulation signal.



3.3 Peak-to-Average Ratio

3.3.1 Description of the PAR Measurement

The peak-to-average ratio (PAR) of the transmission may not exceed 13 dB.

3.3.2 Test Procedures

The testing follows FCC KDB 971168 D01 v03r01 Section 5.7.1

1. The EUT was connected to spectrum analyzer and system simulator via a power divider.
2. Set EUT to transmit at maximum output power.
3. When the duty cycle is less than 98%, then signal gating will be implemented on the spectrum analyzer by triggering from the system simulator.
4. Set the CCDF (Complementary Cumulative Distribution Function) option of the spectrum analyzer.
5. Record the maximum PAPR level associated with a probability of 0.1%.



3.4 99% Occupied Bandwidth and 26dB Bandwidth Measurement

3.4.1 Description of 99% Occupied Bandwidth and 26dB Bandwidth Measurement

The occupied bandwidth is the width of a frequency band such that, below the lower and above the upper frequency limits, the mean powers emitted are each equal to a specified percentage 0.5% of the total mean transmitted power.

The 26 dB emission bandwidth is defined as the frequency range between two points, one above and one below the carrier frequency, at which the spectral density of the emission is attenuated 26 dB below the maximum in-band spectral density of the modulated signal. Spectral density (power per unit bandwidth) is to be measured with a detector of resolution bandwidth equal to approximately 1.0% of the emission bandwidth.

3.4.2 Test Procedures

The testing follows FCC KDB 971168 D01 v03r01 Section 4.2

1. The EUT was connected to spectrum analyzer and system simulator via a power divider.
2. The spectrum analyzer center frequency is set to the nominal EUT channel center frequency. The span range for the spectrum analyzer shall be between two and five times the anticipated OBW.
3. The nominal resolution bandwidth (RBW) shall be in the range of 1 to 5 % of the anticipated OBW, and the VBW shall be at least 3 times the RBW.
4. Set the detection mode to peak, and the trace mode to max hold.
5. Determine the reference value: Set the EUT to transmit a modulated signal. Allow the trace to stabilize. Set the spectrum analyzer marker to the highest level of the displayed trace.
(this is the reference value)
6. Determine the “-26 dB down amplitude” as equal to (Reference Value – X).
7. Place two markers, one at the lowest and the other at the highest frequency of the envelope of the spectral display such that each marker is at or slightly below the “-X dB down amplitude” determined in step 6. If a marker is below this “-X dB down amplitude” value it shall be placed as close as possible to this value. The OBW is the positive frequency difference between the two markers.
8. Use the 99 % power bandwidth function of the spectrum analyzer and report the measured bandwidth.



3.5 Conducted Band Edge

3.5.1 Description of Conducted Band Edge Measurement

The power of any emission outside of the authorized operating frequency ranges must be lower than the transmitter power (P) by a factor of at least $43 + 10 \log (P)$ dB.

3.5.2 Test Procedures

The testing follows FCC KDB 971168 D01 v03r01 Section 6.0.

1. The EUT was connected to the spectrum analyzer and system simulator via a power divider.
2. The RF output of EUT was connected to the spectrum analyzer by an RF cable and attenuator. The path loss was compensated to the results for each measurement.
3. The band edges of low and high channels for the highest RF powers were measured.
4. The RF fundamental frequency should be excluded against the limit line in the operating frequency band.
5. The limit line is derived from $43 + 10\log(P)$ dB below the transmitter power P(Watts)



3.6 Conducted Spurious Emission

3.6.1 Description of Conducted Spurious Emission Measurement

The power of any emission outside of the authorized operating frequency ranges must be lower than the transmitter power (P) by a factor of at least $43 + 10 \log (P)$ dB.

It is measured by means of a calibrated spectrum analyzer and scanned from 30 MHz up to a frequency including its 10th harmonic.

3.6.2 Test Procedures

The testing follows FCC KDB 971168 D01 v03r01 Section 6.0.

1. The EUT was connected to the spectrum analyzer and system simulator via a power divider.
2. The RF output of EUT was connected to the spectrum analyzer by an RF cable and attenuator. The path loss was compensated to the results for each measurement.
3. The middle channel for the highest RF power within the transmitting frequency was measured.
4. The conducted spurious emission for the whole frequency range was taken.
5. The RF fundamental frequency should be excluded against the limit line in the operating frequency band.
6. The limit line is derived from $43 + 10\log(P)$ dB below the transmitter power P(Watts)



3.7 Frequency Stability

3.7.1 Description of Frequency Stability Measurement

22.355

The frequency stability shall be measured by variation of ambient temperature and variation of primary supply voltage to ensure that the fundamental emission stays within the authorized frequency block. The frequency stability of the transmitter shall be maintained within $\pm 0.00025\%$ ($\pm 2.5\text{ppm}$) of the center frequency.

24.235 & 27.54

The frequency stability shall be sufficient to ensure that the fundamental emission stays within the authorized frequency block.

3.7.2 Test Procedures for Temperature Variation

The testing follows FCC KDB 971168 D01 v03r01 Section 9.0.

1. The EUT was set up in the thermal chamber and connected with the system simulator.
2. With power OFF, the temperature was decreased to -30°C and the EUT was stabilized before testing. Power was applied and the maximum change in frequency was recorded within one minute.
3. With power OFF, the temperature was raised in 10°C steps up to 50°C . The EUT was stabilized at each step for at least half an hour. Power was applied and the maximum frequency change was recorded within one minute.

3.7.3 Test Procedures for Voltage Variation

The testing follows FCC KDB 971168 D01 v03r01 Section 9.0.

1. The EUT was placed in a temperature chamber at $20\pm 5^{\circ}\text{C}$ and connected with the system simulator.
2. The power supply voltage to the EUT was varied from 85% to 115% of the nominal value measured at the input to the EUT.
3. The variation in frequency was measured for the worst case.

4 Radiated Test Items

4.1 Measuring Instruments

See list of measuring instruments of this test report.

4.2 Test Setup

For radiated test from 30MHz to 1GHz

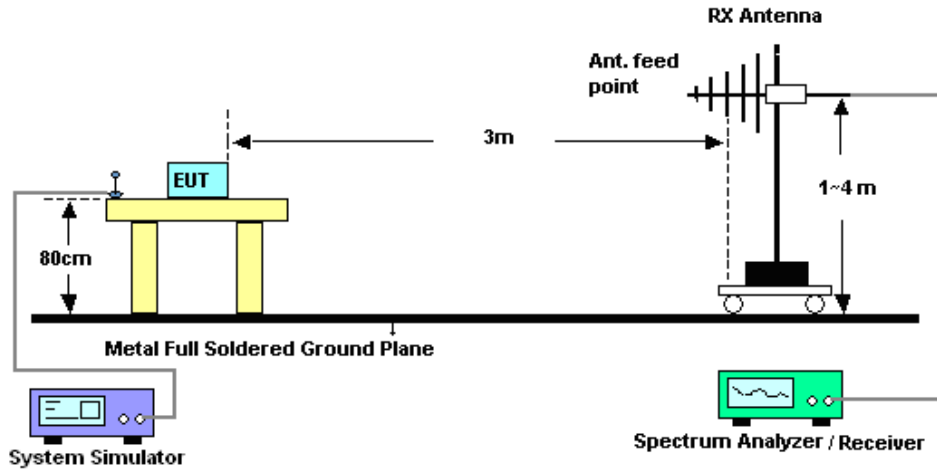

For radiated test above 1GHz

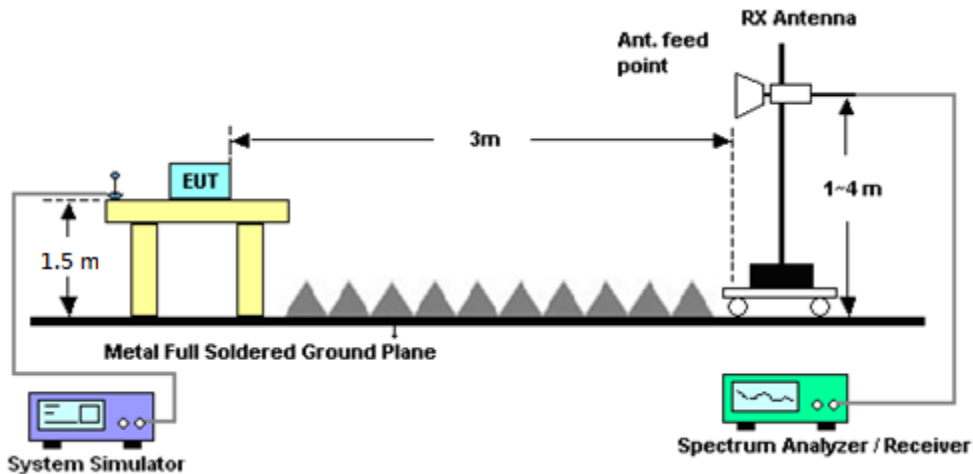

4.3 Test Result of Radiated Test

Please refer to Appendix B.



4.4 Field Strength of Spurious Radiation Measurement

4.4.1 Description of Field Strength of Spurious Radiated Measurement

The power of any emission outside of the authorized operating frequency ranges must be attenuated below the transmitter power (P) by a factor of at least $43 + 10 \log (P)$ dB. The spectrum is scanned from 30 MHz up to a frequency including its 10th harmonic.

4.4.2 Test Procedures

The testing follows FCC KDB 971168 D01 v03r01 Section 5.8 and ANSI / TIA-603-E Section 2.2.12.

1. The EUT was placed on a rotatable wooden table 0.8 meters for frequency below 1GHz and 1.5 meter for frequency above 1GHz above the ground.
2. The EUT was set 3 meters from the receiving antenna, which was mounted on the antenna tower.
3. The table was rotated 360 degrees to determine the position of the highest spurious emission.
4. The height of the receiving antenna is varied between one meter and four meters to search for the maximum spurious emission for both horizontal and vertical polarizations.
5. Make the measurement with the spectrum analyzer's RBW = 1MHz, VBW = 3MHz, taking record of maximum spurious emission.
6. A horn antenna was substituted in place of the EUT and was driven by a signal generator.
7. Tune the output power of signal generator to the same emission level with EUT maximum spurious emission.
8. Taking the record of output power at antenna port.
9. Repeat step 7 to step 8 for another polarization.
10. $EIRP (dBm) = S.G. Power - Tx Cable Loss + Tx Antenna Gain$
11. $ERP (dBm) = EIRP - 2.15$
12. The RF fundamental frequency should be excluded against the limit line in the operating frequency band.
13. The limit line is derived from $43 + 10\log(P)$ dB below the transmitter power P(Watts)



5 List of Measuring Equipment

Instrument	Manufacturer	Model No.	Serial No.	Characteristics	Calibration Date	Test Date	Due Date	Remark
Hygrometer	Testo	608-H1	34893241	N/A	Mar. 06, 2018	Feb. 20, 2019~ Feb. 21, 2019	Mar. 05, 2019	Conducted (TH03-HY)
Spectrum Analyzer	Rohde & Schwarz	FSP30	101329	9kHz~30GHz	Jun. 29, 2018	Feb. 20, 2019~ Feb. 21, 2019	Jun. 28, 2019	Conducted (TH03-HY)
Temperature Chamber	ESPEC	SU-641	92013721	-30°C ~70°C	Dec. 06, 2017	Feb. 20, 2019~ Feb. 21, 2019	Dec. 05, 2019	Conducted (TH03-HY)
Programmable Power Supply	GW Instek	PSS-2005	EL883644	Voltage:0~20V;C urrent:0~5A	Dec. 06, 2017	Feb. 20, 2019~ Feb. 21, 2019	Dec. 05, 2019	Conducted (TH03-HY)
Base Station (Measure)	Rohde & Schwarz	CMU200	117995	GSM / GPRS / WCDMA / CDMA	Aug. 10, 2018	Feb. 20, 2019~ Feb. 21, 2019	Aug. 09, 2019	Conducted (TH03-HY)
Amplifier	SONOMA	310N	187311	9kHz~1GHz	Oct. 23, 2018	Feb. 15, 2019~ Feb. 18, 2019	Oct. 22, 2019	Radiation (03CH10-HY)
Bilog Antenna	TESEQ	CBL 6111D&0080 ON1D01N-06	35413&02	30MHz~1GHz	Feb. 12, 2019	Feb. 15, 2019~ Feb. 18, 2019	Feb. 11, 2020	Radiation (03CH10-HY)
Horn Antenna	SCHWARZBE CK	BBHA 9120 D	9120D-1325	1GHz ~ 18GHz	Oct. 02, 2018	Feb. 15, 2019~ Feb. 18, 2019	Oct. 01, 2019	Radiation (03CH10-HY)
Horn Antenna	ESCO	3117	00211469	1GHz~18GHz	Aug. 06, 2018	Feb. 15, 2019~ Feb. 18, 2019	Aug. 05, 2019	Radiation (03CH10-HY)
Loop Antenna	Rohde & Schwarz	HFH2-Z2	100315	9 kHz~30 MHz	May 15, 2017	Feb. 15, 2019~ Feb. 18, 2019	May 14, 2019	Radiation (03CH10-HY)
Preamplifier	Keysight	83017A	MY5327007 8	1GHz~26.5GHz	Oct. 28, 2018	Feb. 15, 2019~ Feb. 18, 2019	Oct. 27, 2019	Radiation (03CH10-HY)
Spectrum Analyzer	Keysight	N9010A	MY5420048 5	10Hz ~ 44GHz	Nov. 02, 2018	Feb. 15, 2019~ Feb. 18, 2019	Nov. 01, 2019	Radiation (03CH10-HY)
Controller	EMEC	EM 1000	N/A	Control Turn table & Ant Mast	N/A	Feb. 15, 2019~ Feb. 18, 2019	N/A	Radiation (03CH10-HY)
Antenna Mast	EMEC	AM-BS-4500 -B	N/A	1~4m	N/A	Feb. 15, 2019~ Feb. 18, 2019	N/A	Radiation (03CH10-HY)
Turn Table	EMEC	TT 2200	N/A	0~360 Degree	N/A	Feb. 15, 2019~ Feb. 18, 2019	N/A	Radiation (03CH10-HY)
Software	Audix	E3 6.2009-8-24	RK-001042	N/A	N/A	Feb. 15, 2019~ Feb. 18, 2019	N/A	Radiation (03CH10-HY)
Signal Generator	Rohde & Schwarz	SMF100A	101107	100kHz~40GHz	May 22, 2018	Feb. 15, 2019~ Feb. 18, 2019	May 21, 2019	Radiation (03CH10-HY)
SHF-EHF Horn Antenna	SCHWARZBE CK	BBHA 9170	BBHA91705 76	18GHz ~ 40GHz	May 08, 2018	Feb. 15, 2019~ Feb. 18, 2019	May 07, 2019	Radiation (03CH10-HY)
SHF-EHF Horn Antenna	SCHWARZBE CK	BBHA 9170	BBHA91702 51	18GHz ~ 40GHz	Nov. 20, 2018	Feb. 15, 2019~ Feb. 18, 2019	Nov. 19, 2019	Radiation (03CH10-HY)
RF Cable	HUBER + SUHNER	SUCOFLEX 104 / 102	MY11692/4P E, MY11693/4P E, MY2855/2	30M-1G	Nov. 08, 2018	Feb. 15, 2019~ Feb. 18, 2019	Nov. 07, 2019	Radiation (03CH10-HY)
RF Cable	HUBER + SUHNER	SUCOFLEX 104 / 102	MY11692/4P E, MY11693/4P E, MY2855/2	1G-18G	Nov. 08, 2018	Feb. 15, 2019~ Feb. 18, 2019	Nov. 07, 2019	Radiation (03CH10-HY)
RF Cable	HUBER + SUHNER	SUCOFLEX 102	505134/2	30M~40GHz	Oct. 16, 2018	Feb. 15, 2019~ Feb. 18, 2019	Oct. 15, 2019	Radiation (03CH10-HY)
RF Cable	HUBER + SUHNER	SUCOFLEX 102	800740/2	30M~40GHz	Oct. 16, 2018	Feb. 15, 2019~ Feb. 18, 2019	Oct. 15, 2019	Radiation (03CH10-HY)



Instrument	Manufacturer	Model No.	Serial No.	Characteristics	Calibration Date	Test Date	Due Date	Remark
Notch Filter	Wainwright	WTRCT5-82 4-849-20-70- 60SSK	SN1	824-849	Mar. 22, 2018	Feb. 15, 2019~ Feb. 18, 2019	Mar. 21, 2019	Radiation (03CH10-HY)
Notch Filter	Wainwright	WRCT10-19 20-1980-20- 40-40SSK	SN1	1920-1980	May 22, 2018	Feb. 15, 2019~ Feb. 18, 2019	May 21, 2019	Radiation (03CH10-HY)
Notch Filter	Wainwright	WRCG1710/ 1755-1690/1 755-45/7SS	SN2	AWS Band	Nov. 06, 2018	Feb. 15, 2019~ Feb. 18, 2019	Nov. 05, 2019	Radiation (03CH10-HY)
Filter	Wainwright	WLJ4-1000- 1530-6000-4 0ST	SN3	1.53 GHz Lowpass	Mar. 21, 2018	Feb. 15, 2019~ Feb. 18, 2019	Mar. 20, 2019	Radiation (03CH10-HY)
Filter	Microwave	H1G013G1	SN477215	1.0G High Pass	Nov. 02, 2018	Feb. 15, 2019~ Feb. 18, 2019	Nov. 01, 2019	Radiation (03CH10-HY)
Filter	Microwave	H3G018G1	SN477220	3.0G High Pass	Nov. 02, 2018	Feb. 15, 2019~ Feb. 18, 2019	Nov. 01, 2019	Radiation (03CH10-HY)



6 Uncertainty of Evaluation

Uncertainty of Radiated Emission Measurement (30 MHz ~ 1000 MHz)

Measuring Uncertainty for a Level of Confidence of 95% ($U = 2Uc(y)$)	3.17
---	------

Uncertainty of Radiated Emission Measurement (1 GHz ~ 18 GHz)

Measuring Uncertainty for a Level of Confidence of 95% ($U = 2Uc(y)$)	3.48
---	------

Uncertainty of Radiated Emission Measurement (18 GHz ~ 40 GHz)

Measuring Uncertainty for a Level of Confidence of 95% ($U = 2Uc(y)$)	4.00
---	------



Appendix A. Test Results of Conducted Test

Conducted Output Power(Average power)

Conducted Power (*Unit: dBm)						
Band	GSM850			GSM1900		
Channel	128	189	251	512	661	810
Frequency	824.2	836.4	848.8	1850.2	1880	1909.8
GSM	31.24	31.30	31.25	27.12	27.52	27.61
GPRS class 8	31.24	31.31	31.26	27.12	27.54	27.65
GPRS class 10	29.46	29.35	28.77	25.15	25.56	25.73
GPRS class 11	27.34	26.82	26.89	23.18	23.56	23.71
GPRS class 12	26.37	26.22	26.04	22.29	22.67	22.85
EGPRS class 8	26.83	26.87	26.84	25.43	25.81	25.93
EGPRS class 10	25.23	25.31	25.17	23.95	24.19	24.25
EGPRS class 11	23.27	23.33	23.24	22.08	22.39	22.37
EGPRS class 12	22.12	22.16	22.13	20.93	21.22	21.26

Conducted Power (*Unit: dBm)						
Band	WCDMA Band V			WCDMA Band II		
Channel	4132	4182	4233	9262	9400	9538
Frequency	826.4	836.4	846.6	1852.4	1880	1907.6
RMC 12.2K	24.03	24.18	24.11	18.83	19.05	19.04
HSDPA Subtest-1	22.95	23.09	23.02	17.83	18.19	18.09
HSDPA Subtest-2	22.97	23.04	22.88	17.87	18.18	18.14
HSDPA Subtest-3	22.45	22.56	22.57	17.36	17.68	17.64
HSDPA Subtest-4	22.48	22.63	22.53	17.36	17.64	17.66
HSUPA Subtest-1	22.93	23.05	23.04	17.90	17.96	18.12
HSUPA Subtest-2	20.91	21.08	20.99	15.79	16.03	16.09
HSUPA Subtest-3	22.08	22.16	21.99	16.85	17.05	17.12
HSUPA Subtest-4	21.06	21.20	21.05	15.86	16.16	16.14
HSUPA Subtest-5	23.00	23.16	23.06	17.88	18.10	18.18



Conducted Power (*Unit: dBm)			
Band	WCDMA Band IV		
Channel	1312	1413	1513
Frequency	1712.4	1732.6	1752.6
RMC 12.2K	19.40	19.38	19.44
HSDPA Subtest-1	18.46	18.55	18.60
HSDPA Subtest-2	18.37	18.51	18.59
HSDPA Subtest-3	17.89	18.08	18.02
HSDPA Subtest-4	17.80	18.10	18.02
HSUPA Subtest-1	18.43	18.52	18.54
HSUPA Subtest-2	16.48	16.51	16.54
HSUPA Subtest-3	17.32	17.57	17.57
HSUPA Subtest-4	16.38	16.54	16.51
HSUPA Subtest-5	18.44	18.43	18.58



A2. GSM

Peak-to-Average Ratio

Mode	GSM850		Limit: 13dB
Mod.	GPRS class 8	EDGE class 8	Result
Lowest CH	0.32	3.36	PASS
Middle CH	0.32	3.44	
Highest CH	0.32	3.16	

Mode	GSM1900		Limit: 13dB
Mod.	GPRS class 8	EDGE class 8	Result
Lowest CH	0.52	3.52	PASS
Middle CH	0.48	3.52	
Highest CH	0.52	3.56	

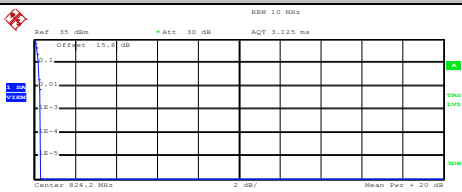
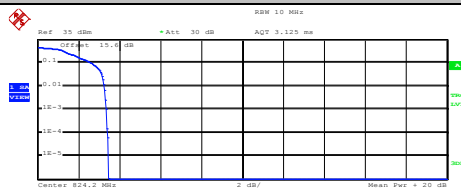
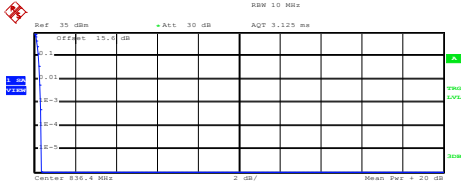
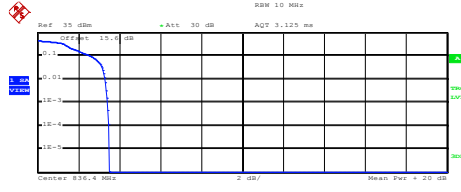
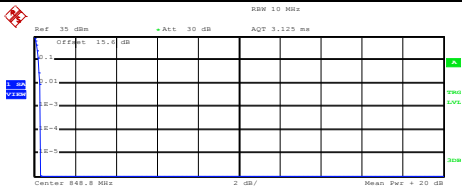
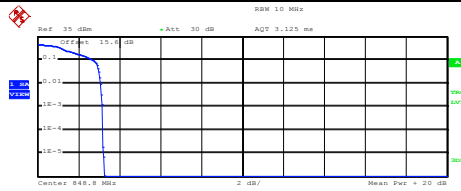

GSM850 (GPRS class 8)	GSM850 (EDGE class 8)																
<p style="text-align: center;">Lowest Channel</p>  <p>Ref: 35 dBm, Att: 30 dB, AQT: 3.125 ms, RBW: 10 MHz, Center: 824.2 MHz, Mean Pwr: +20 dB</p> <p>Complementary Cumulative Distribution Function (100000 samples) Trace 1 Mean: 31.21 dBm Peak: 31.51 dBm Crest: 0.30 dB</p> <table border="1"> <tr><td>10 %</td><td>0.20 dB</td></tr> <tr><td>1 %</td><td>0.28 dB</td></tr> <tr><td>.1 %</td><td>0.32 dB</td></tr> <tr><td>.01 %</td><td>0.32 dB</td></tr> </table> <p>Date: 19.FEB.2019 19:50:22</p>	10 %	0.20 dB	1 %	0.28 dB	.1 %	0.32 dB	.01 %	0.32 dB	<p style="text-align: center;">Lowest Channel</p>  <p>Ref: 35 dBm, Att: 30 dB, AQT: 3.125 ms, RBW: 10 MHz, Center: 824.2 MHz, Mean Pwr: +20 dB</p> <p>Complementary Cumulative Distribution Function (100000 samples) Trace 1 Mean: 26.78 dBm Peak: 30.24 dBm Crest: 3.46 dB</p> <table border="1"> <tr><td>10 %</td><td>2.64 dB</td></tr> <tr><td>1 %</td><td>3.24 dB</td></tr> <tr><td>.1 %</td><td>3.36 dB</td></tr> <tr><td>.01 %</td><td>3.44 dB</td></tr> </table> <p>Date: 19.FEB.2019 20:02:12</p>	10 %	2.64 dB	1 %	3.24 dB	.1 %	3.36 dB	.01 %	3.44 dB
10 %	0.20 dB																
1 %	0.28 dB																
.1 %	0.32 dB																
.01 %	0.32 dB																
10 %	2.64 dB																
1 %	3.24 dB																
.1 %	3.36 dB																
.01 %	3.44 dB																
<p style="text-align: center;">Middle Channel</p>  <p>Ref: 35 dBm, Att: 30 dB, AQT: 3.125 ms, RBW: 10 MHz, Center: 836.4 MHz, Mean Pwr: +20 dB</p> <p>Complementary Cumulative Distribution Function (100000 samples) Trace 1 Mean: 30.98 dBm Peak: 31.30 dBm Crest: 0.32 dB</p> <table border="1"> <tr><td>10 %</td><td>0.20 dB</td></tr> <tr><td>1 %</td><td>0.28 dB</td></tr> <tr><td>.1 %</td><td>0.32 dB</td></tr> <tr><td>.01 %</td><td>0.36 dB</td></tr> </table> <p>Date: 19.FEB.2019 19:50:40</p>	10 %	0.20 dB	1 %	0.28 dB	.1 %	0.32 dB	.01 %	0.36 dB	<p style="text-align: center;">Middle Channel</p>  <p>Ref: 35 dBm, Att: 30 dB, AQT: 3.125 ms, RBW: 10 MHz, Center: 836.4 MHz, Mean Pwr: +20 dB</p> <p>Complementary Cumulative Distribution Function (100000 samples) Trace 1 Mean: 26.61 dBm Peak: 30.10 dBm Crest: 3.49 dB</p> <table border="1"> <tr><td>10 %</td><td>2.60 dB</td></tr> <tr><td>1 %</td><td>3.28 dB</td></tr> <tr><td>.1 %</td><td>3.44 dB</td></tr> <tr><td>.01 %</td><td>3.48 dB</td></tr> </table> <p>Date: 19.FEB.2019 20:02:29</p>	10 %	2.60 dB	1 %	3.28 dB	.1 %	3.44 dB	.01 %	3.48 dB
10 %	0.20 dB																
1 %	0.28 dB																
.1 %	0.32 dB																
.01 %	0.36 dB																
10 %	2.60 dB																
1 %	3.28 dB																
.1 %	3.44 dB																
.01 %	3.48 dB																
<p style="text-align: center;">Highest Channel</p>  <p>Ref: 35 dBm, Att: 30 dB, AQT: 3.125 ms, RBW: 10 MHz, Center: 848.8 MHz, Mean Pwr: +20 dB</p> <p>Complementary Cumulative Distribution Function (100000 samples) Trace 1 Mean: 31.22 dBm Peak: 31.51 dBm Crest: 0.30 dB</p> <table border="1"> <tr><td>10 %</td><td>0.20 dB</td></tr> <tr><td>1 %</td><td>0.28 dB</td></tr> <tr><td>.1 %</td><td>0.32 dB</td></tr> <tr><td>.01 %</td><td>0.32 dB</td></tr> </table> <p>Date: 19.FEB.2019 19:50:58</p>	10 %	0.20 dB	1 %	0.28 dB	.1 %	0.32 dB	.01 %	0.32 dB	<p style="text-align: center;">Highest Channel</p>  <p>Ref: 35 dBm, Att: 30 dB, AQT: 3.125 ms, RBW: 10 MHz, Center: 848.8 MHz, Mean Pwr: +20 dB</p> <p>Complementary Cumulative Distribution Function (100000 samples) Trace 1 Mean: 26.91 dBm Peak: 30.17 dBm Crest: 3.26 dB</p> <table border="1"> <tr><td>10 %</td><td>2.72 dB</td></tr> <tr><td>1 %</td><td>3.08 dB</td></tr> <tr><td>.1 %</td><td>3.16 dB</td></tr> <tr><td>.01 %</td><td>3.20 dB</td></tr> </table> <p>Date: 19.FEB.2019 20:02:49</p>	10 %	2.72 dB	1 %	3.08 dB	.1 %	3.16 dB	.01 %	3.20 dB
10 %	0.20 dB																
1 %	0.28 dB																
.1 %	0.32 dB																
.01 %	0.32 dB																
10 %	2.72 dB																
1 %	3.08 dB																
.1 %	3.16 dB																
.01 %	3.20 dB																

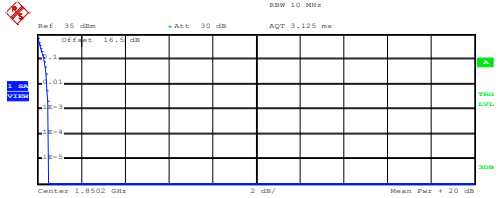
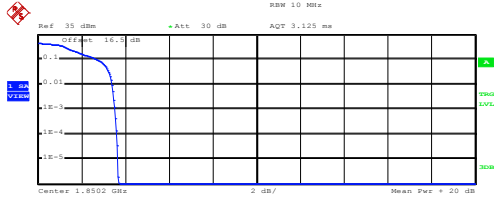
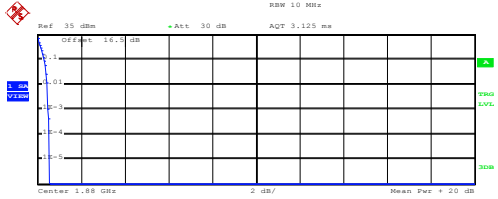
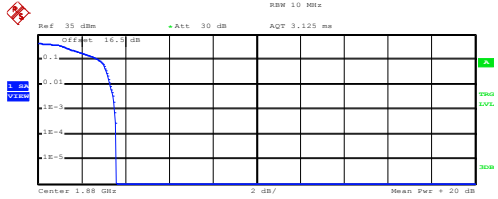
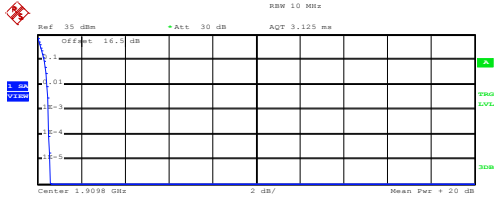
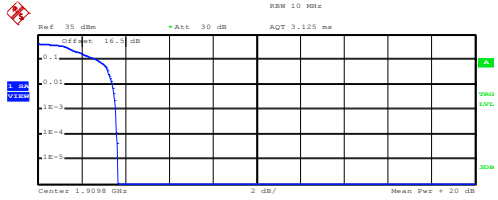

GSM1900 (GPRS class 8)	GSM1900 (EDGE class 8)
<p style="text-align: center;">Lowest Channel</p>  <p>Center 1.8502 GHz 2 dB/ Mean Pwr + 20 dB</p> <p>Complementary Cumulative Distribution Function (100000 samples)</p> <p>Trace 1</p> <p>Mean 26.25 dBm Peak 26.76 dBm Crest 0.51 dB</p> <p>10 % 0.32 dB 1 % 0.44 dB .1 % 0.52 dB .01 % 0.52 dB</p> <p>Date: 20.FEB.2019 16:50:42</p>	<p style="text-align: center;">Lowest Channel</p>  <p>Center 1.8502 GHz 2 dB/ Mean Pwr + 20 dB</p> <p>Complementary Cumulative Distribution Function (100000 samples)</p> <p>Trace 1</p> <p>Mean 24.71 dBm Peak 28.38 dBm Crest 3.68 dB</p> <p>10 % 2.76 dB 1 % 3.40 dB .1 % 3.52 dB .01 % 3.60 dB</p> <p>Date: 20.FEB.2019 17:08:53</p>
<p style="text-align: center;">Middle Channel</p>  <p>Center 1.88 GHz 2 dB/ Mean Pwr + 20 dB</p> <p>Complementary Cumulative Distribution Function (100000 samples)</p> <p>Trace 1</p> <p>Mean 26.64 dBm Peak 27.18 dBm Crest 0.55 dB</p> <p>10 % 0.32 dB 1 % 0.44 dB .1 % 0.48 dB .01 % 0.56 dB</p> <p>Date: 20.FEB.2019 16:50:59</p>	<p style="text-align: center;">Middle Channel</p>  <p>Center 1.88 GHz 2 dB/ Mean Pwr + 20 dB</p> <p>Complementary Cumulative Distribution Function (100000 samples)</p> <p>Trace 1</p> <p>Mean 25.09 dBm Peak 28.67 dBm Crest 3.58 dB</p> <p>10 % 2.80 dB 1 % 3.32 dB .1 % 3.52 dB .01 % 3.60 dB</p> <p>Date: 20.FEB.2019 17:09:15</p>
<p style="text-align: center;">Highest Channel</p>  <p>Center 1.9098 GHz 2 dB/ Mean Pwr + 20 dB</p> <p>Complementary Cumulative Distribution Function (100000 samples)</p> <p>Trace 1</p> <p>Mean 26.54 dBm Peak 27.11 dBm Crest 0.57 dB</p> <p>10 % 0.32 dB 1 % 0.44 dB .1 % 0.52 dB .01 % 0.52 dB</p> <p>Date: 20.FEB.2019 16:51:21</p>	<p style="text-align: center;">Highest Channel</p>  <p>Center 1.9098 GHz 2 dB/ Mean Pwr + 20 dB</p> <p>Complementary Cumulative Distribution Function (100000 samples)</p> <p>Trace 1</p> <p>Mean 24.94 dBm Peak 28.60 dBm Crest 3.66 dB</p> <p>10 % 2.72 dB 1 % 3.40 dB .1 % 3.56 dB .01 % 3.60 dB</p> <p>Date: 20.FEB.2019 17:09:35</p>



26dB Bandwidth

Mode	GSM850: 26dB BW(MHz)	
Mod.	GPRS class 8	EDGE class 8
Lowest CH	0.296	0.302
Middle CH	0.312	0.295
Highest CH	0.315	0.293

Mode	GSM1900: 26dB BW(MHz)	
Mod.	GPRS class 8	EDGE class 8
Lowest CH	0.298	0.293
Middle CH	0.310	0.288
Highest CH	0.297	0.305

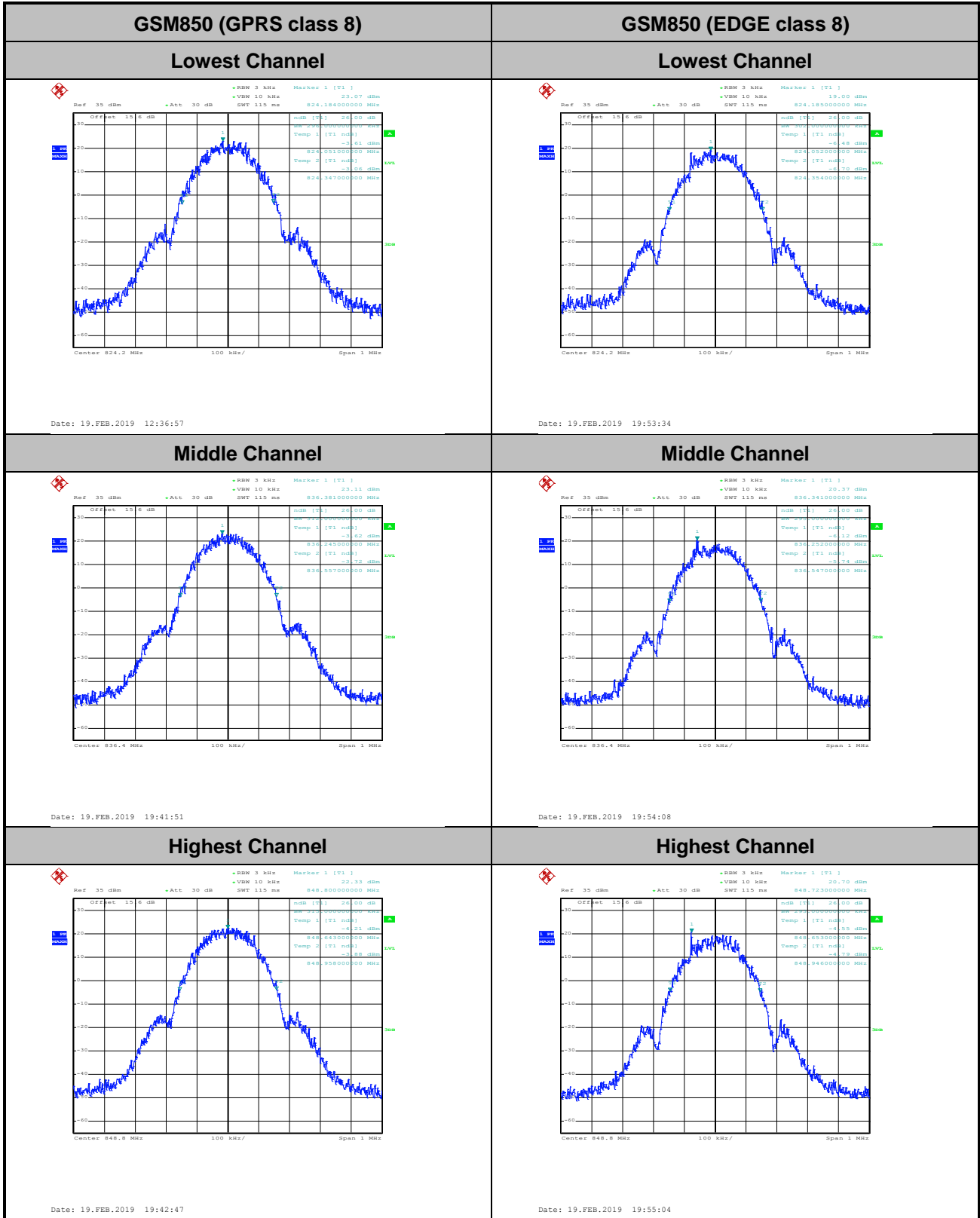

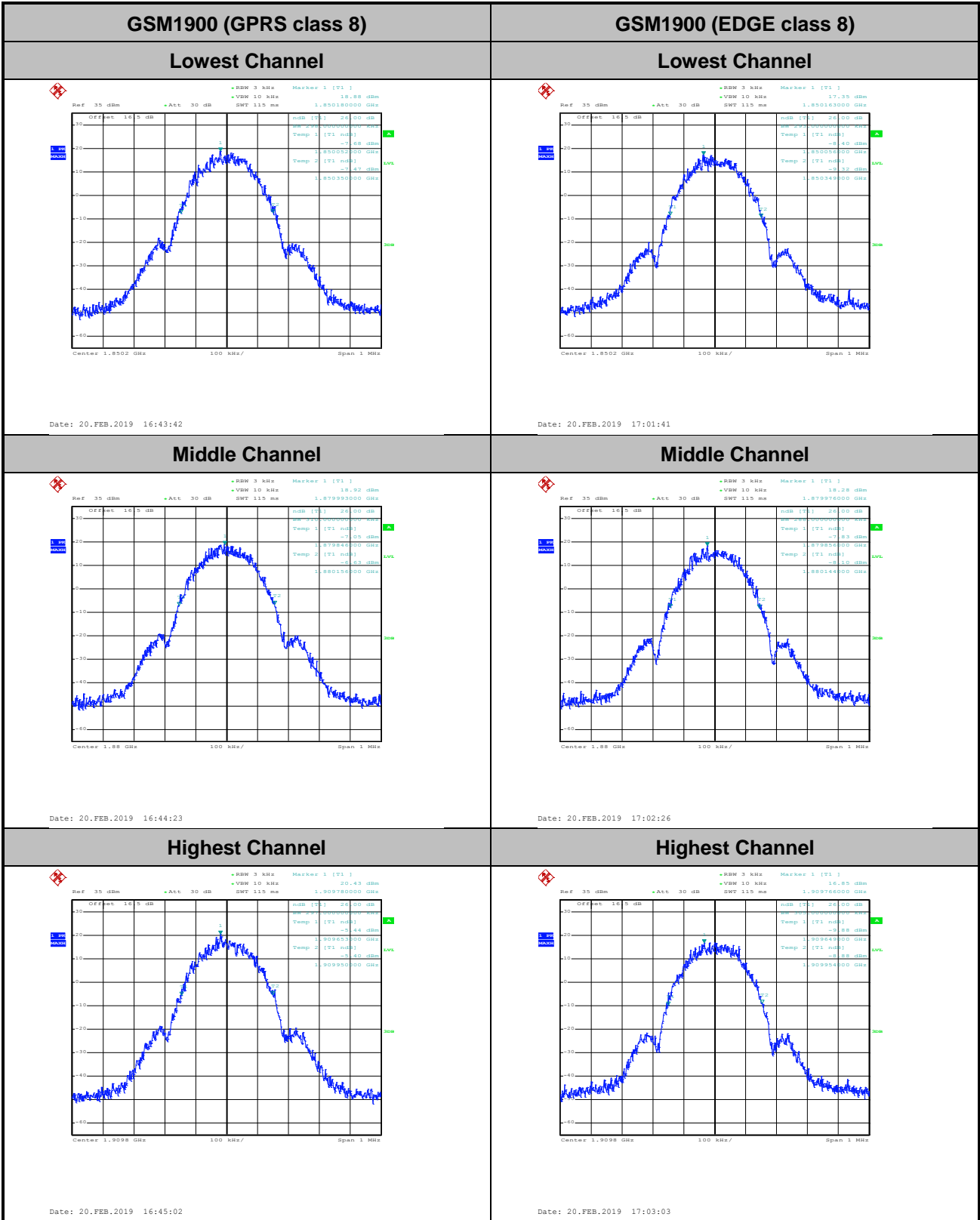



Occupied Bandwidth

Mode	GSM850 : 99% OBW(MHz)	
Mod.	GPRS class 8	EDGE class 8
Lowest CH	0.245	0.236
Middle CH	0.243	0.247
Highest CH	0.243	0.237

Mode	GSM1900: 99% OBW(MHz)	
Mod.	GPRS class 8	EDGE class 8
Lowest CH	0.246	0.238
Middle CH	0.242	0.244
Highest CH	0.242	0.242

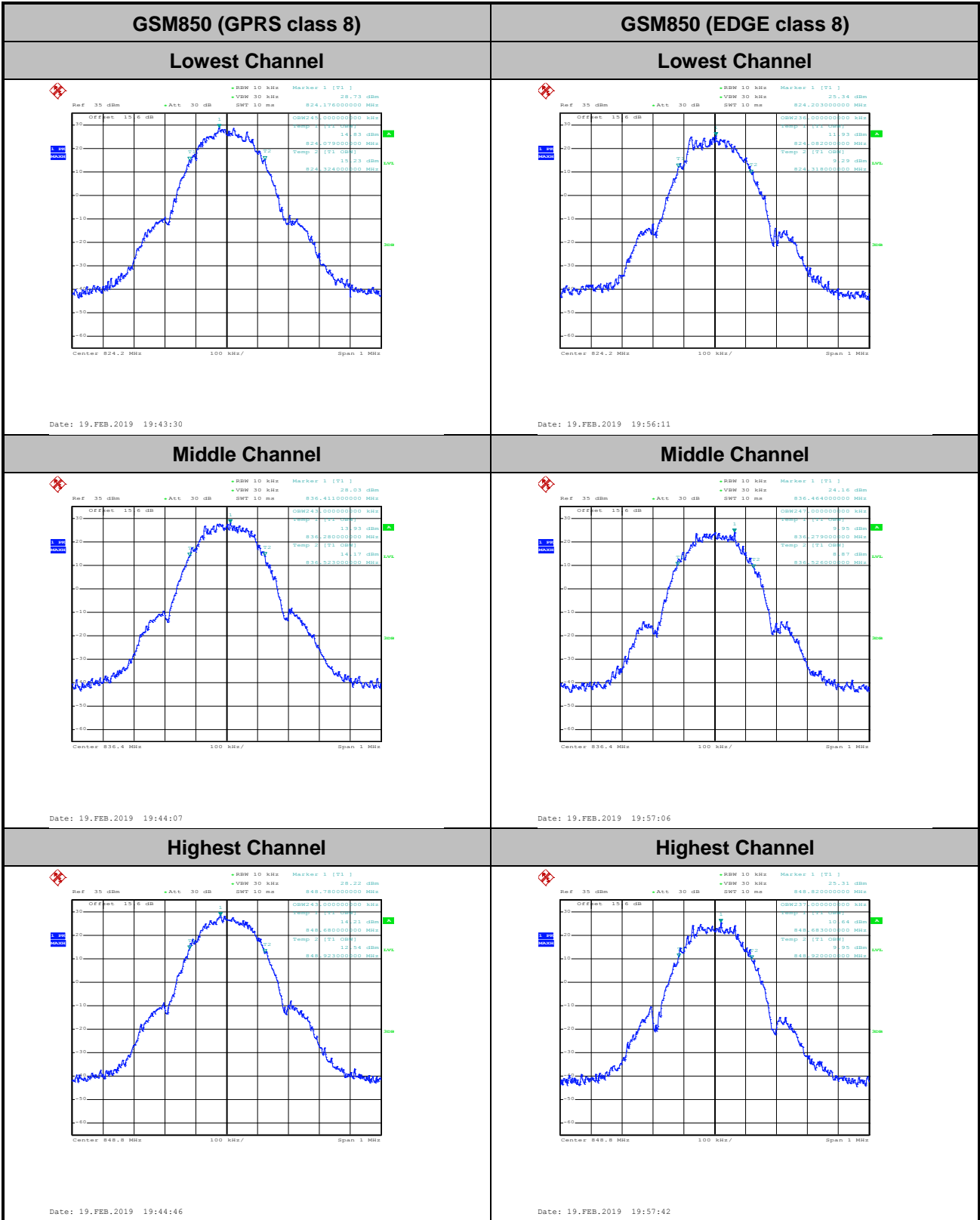

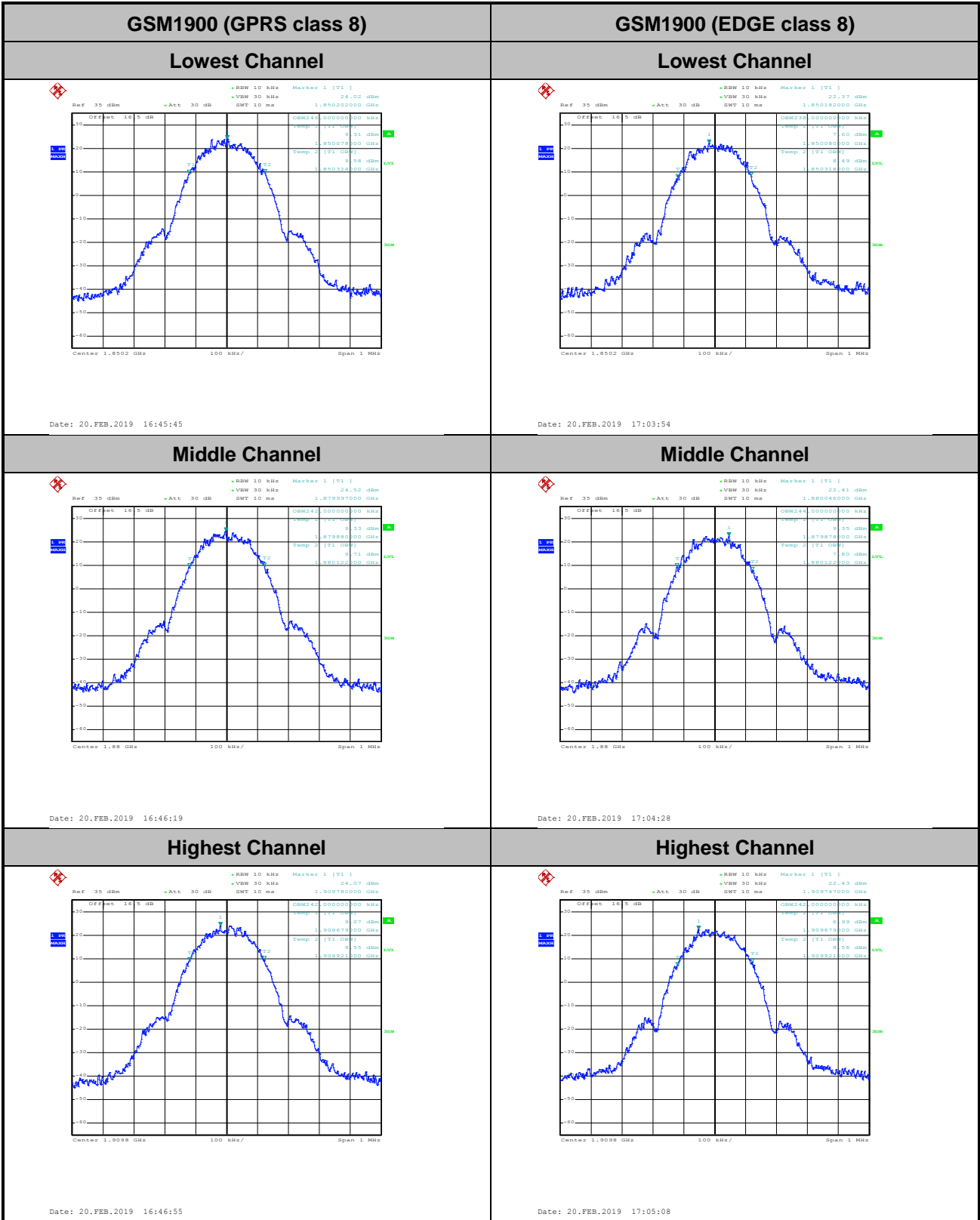



Conducted Band Edge

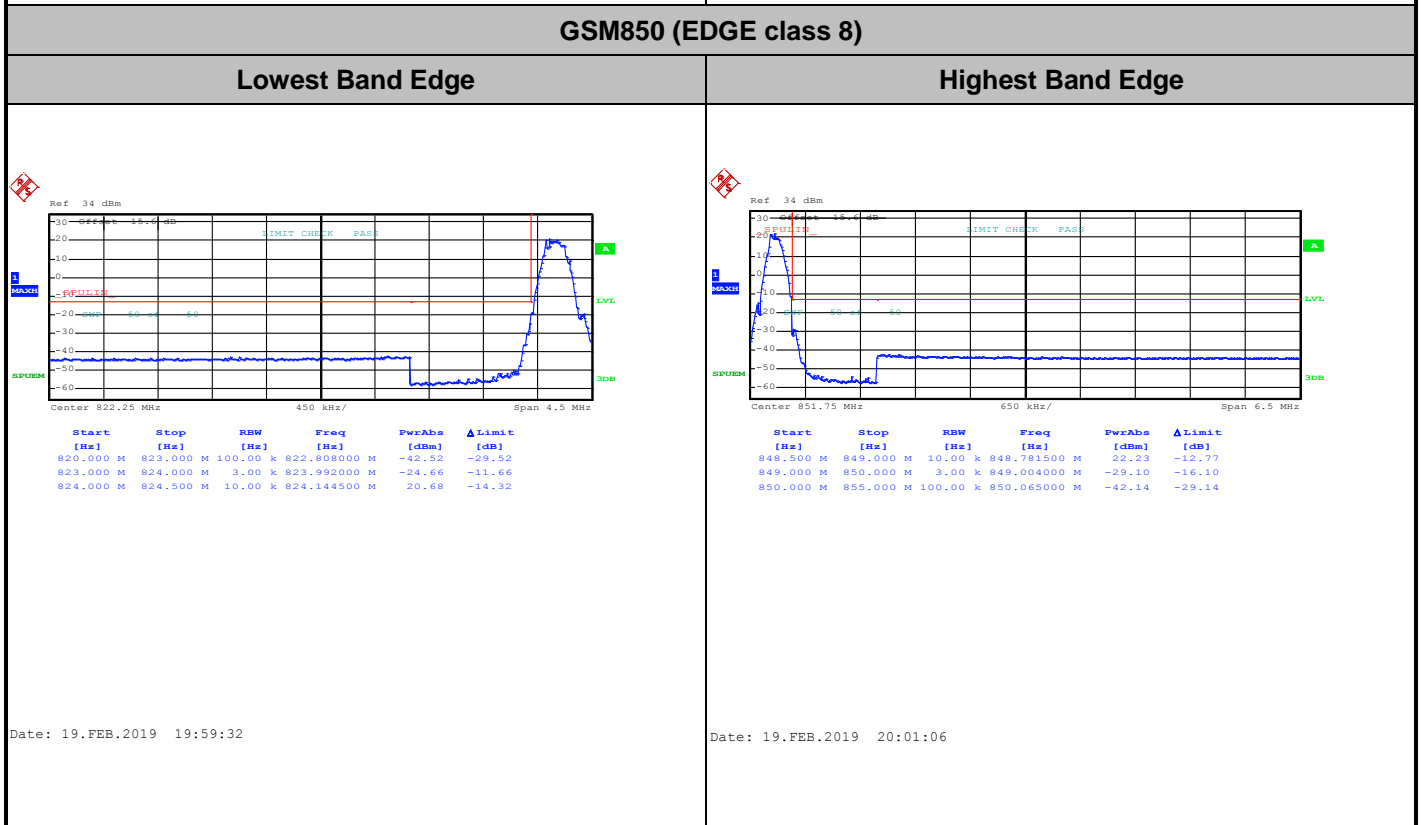
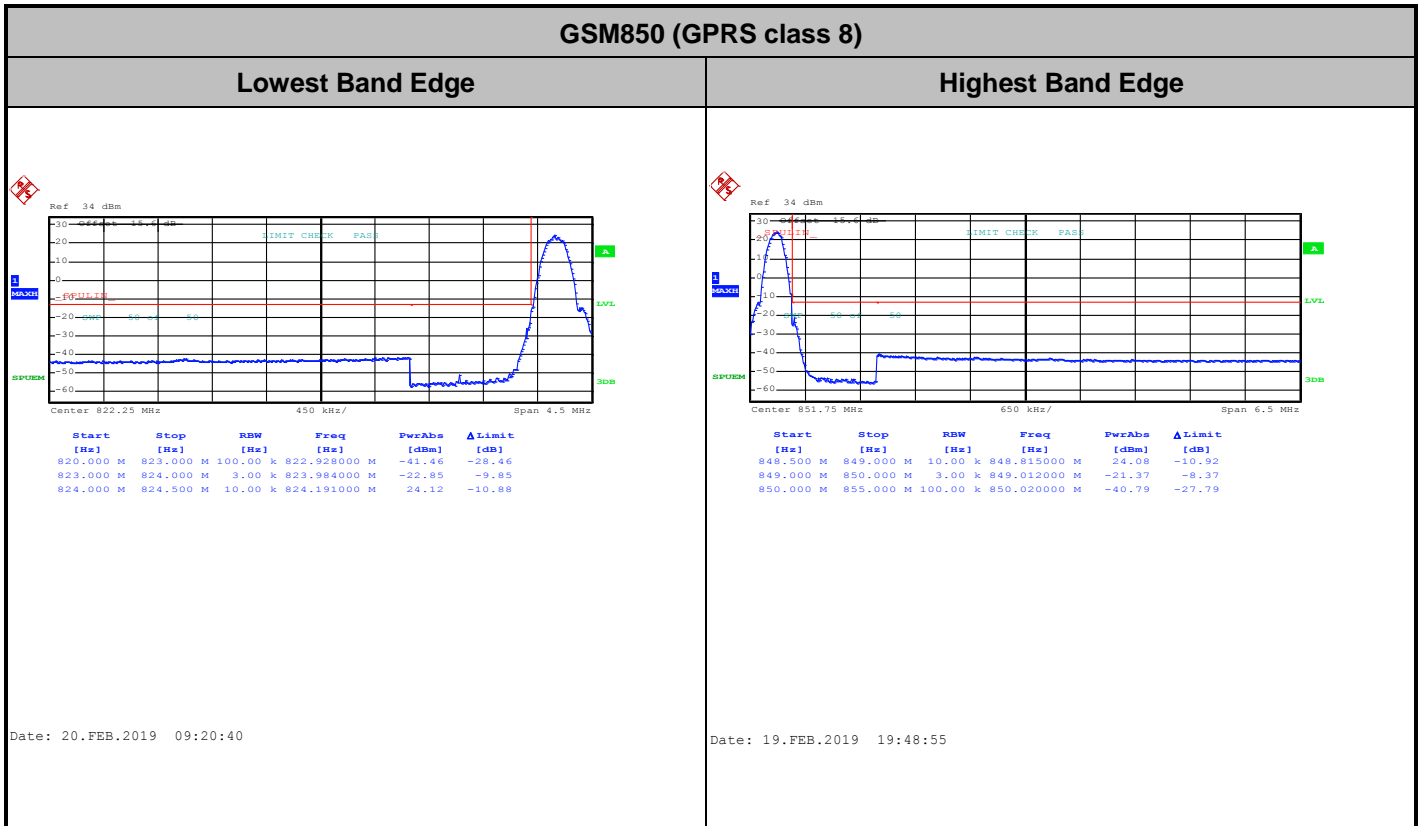



GSM1900 (GPRS class 8)

Lowest Band Edge

Highest Band Edge

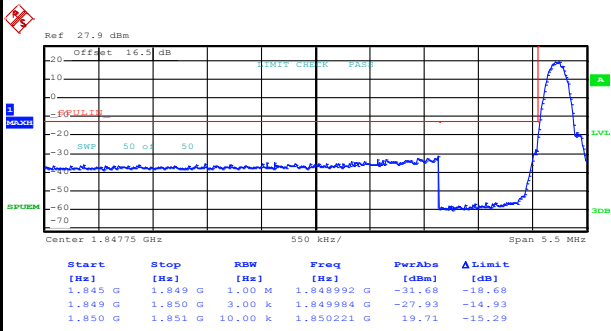

Date: 20.FEB.2019 16:48:35

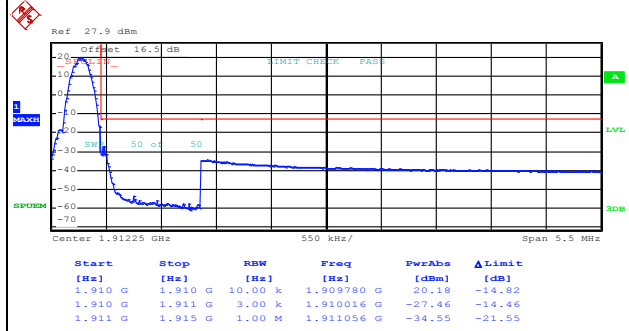

Date: 20.FEB.2019 16:50:09

GSM1900 (EDGE class 8)

Lowest Band Edge

Highest Band Edge

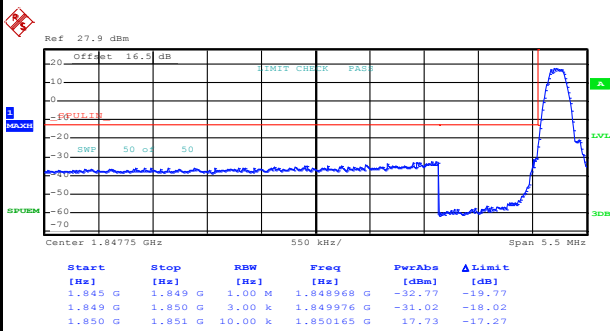

Date: 20.FEB.2019 17:06:44

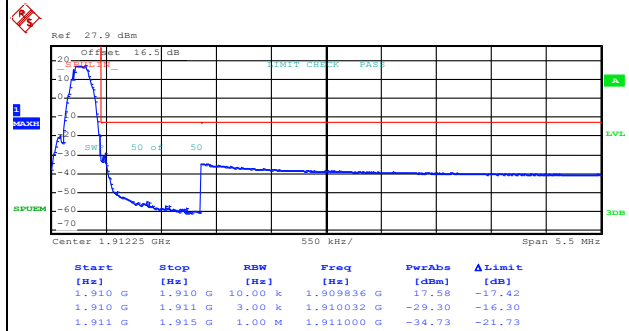

Date: 20.FEB.2019 17:08:26

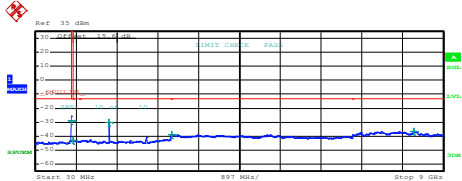
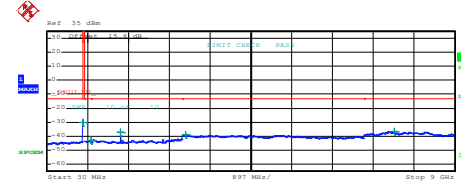
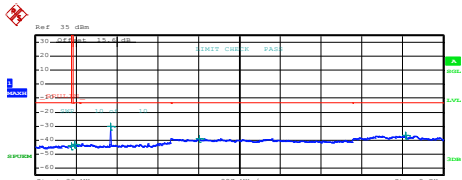
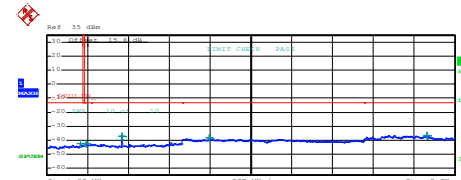
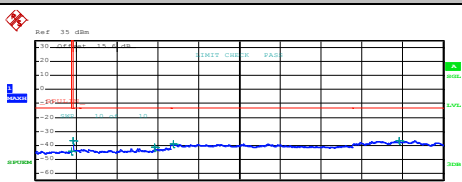
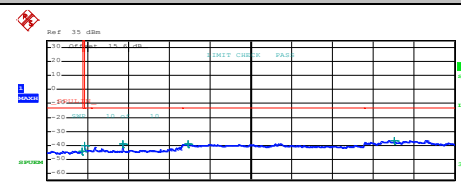

Conducted Spurious Emission

GSM850 (GPRS class 8)	GSM850 (EDGE class 8)																																																																								
Lowest Channel	Lowest Channel																																																																								
 <table border="1" data-bbox="239 660 654 739"> <thead> <tr> <th>Start [Hz]</th> <th>Stop [Hz]</th> <th>RBW [Hz]</th> <th>Freq [Hz]</th> <th>PerAbs [dBm]</th> <th>ΔLimit [dB]</th> </tr> </thead> <tbody> <tr> <td>30,000 M</td> <td>820,000 M</td> <td>1,00 M</td> <td>818,000000 M</td> <td>-29.10</td> <td>-16.10</td> </tr> <tr> <td>850,000 M</td> <td>1,000 G</td> <td>1,00 M</td> <td>859,930000 M</td> <td>-43.16</td> <td>-30.16</td> </tr> <tr> <td>1,000 G</td> <td>3,000 G</td> <td>1,00 M</td> <td>1,648000 G</td> <td>-30.25</td> <td>-27.25</td> </tr> <tr> <td>3,000 G</td> <td>7,000 G</td> <td>1,00 M</td> <td>3,031000 G</td> <td>-38.79</td> <td>-25.79</td> </tr> <tr> <td>7,000 G</td> <td>9,000 G</td> <td>1,00 M</td> <td>8,349000 G</td> <td>-36.64</td> <td>-23.64</td> </tr> </tbody> </table> <p>Date: 20.FEB.2019 16:28:09</p>	Start [Hz]	Stop [Hz]	RBW [Hz]	Freq [Hz]	PerAbs [dBm]	ΔLimit [dB]	30,000 M	820,000 M	1,00 M	818,000000 M	-29.10	-16.10	850,000 M	1,000 G	1,00 M	859,930000 M	-43.16	-30.16	1,000 G	3,000 G	1,00 M	1,648000 G	-30.25	-27.25	3,000 G	7,000 G	1,00 M	3,031000 G	-38.79	-25.79	7,000 G	9,000 G	1,00 M	8,349000 G	-36.64	-23.64	 <table border="1" data-bbox="877 660 1292 739"> <thead> <tr> <th>Start [Hz]</th> <th>Stop [Hz]</th> <th>RBW [Hz]</th> <th>Freq [Hz]</th> <th>PerAbs [dBm]</th> <th>ΔLimit [dB]</th> </tr> </thead> <tbody> <tr> <td>30,000 M</td> <td>820,000 M</td> <td>1,00 M</td> <td>818,000000 M</td> <td>-29.02</td> <td>-16.02</td> </tr> <tr> <td>850,000 M</td> <td>1,000 G</td> <td>1,00 M</td> <td>859,891260 M</td> <td>-42.98</td> <td>-29.98</td> </tr> <tr> <td>1,000 G</td> <td>3,000 G</td> <td>1,00 M</td> <td>1,648000 G</td> <td>-37.45</td> <td>-24.45</td> </tr> <tr> <td>3,000 G</td> <td>7,000 G</td> <td>1,00 M</td> <td>3,077000 G</td> <td>-39.13</td> <td>-26.13</td> </tr> <tr> <td>7,000 G</td> <td>9,000 G</td> <td>1,00 M</td> <td>7,675000 G</td> <td>-36.40</td> <td>-23.40</td> </tr> </tbody> </table> <p>Date: 20.FEB.2019 16:35:58</p>	Start [Hz]	Stop [Hz]	RBW [Hz]	Freq [Hz]	PerAbs [dBm]	ΔLimit [dB]	30,000 M	820,000 M	1,00 M	818,000000 M	-29.02	-16.02	850,000 M	1,000 G	1,00 M	859,891260 M	-42.98	-29.98	1,000 G	3,000 G	1,00 M	1,648000 G	-37.45	-24.45	3,000 G	7,000 G	1,00 M	3,077000 G	-39.13	-26.13	7,000 G	9,000 G	1,00 M	7,675000 G	-36.40	-23.40
Start [Hz]	Stop [Hz]	RBW [Hz]	Freq [Hz]	PerAbs [dBm]	ΔLimit [dB]																																																																				
30,000 M	820,000 M	1,00 M	818,000000 M	-29.10	-16.10																																																																				
850,000 M	1,000 G	1,00 M	859,930000 M	-43.16	-30.16																																																																				
1,000 G	3,000 G	1,00 M	1,648000 G	-30.25	-27.25																																																																				
3,000 G	7,000 G	1,00 M	3,031000 G	-38.79	-25.79																																																																				
7,000 G	9,000 G	1,00 M	8,349000 G	-36.64	-23.64																																																																				
Start [Hz]	Stop [Hz]	RBW [Hz]	Freq [Hz]	PerAbs [dBm]	ΔLimit [dB]																																																																				
30,000 M	820,000 M	1,00 M	818,000000 M	-29.02	-16.02																																																																				
850,000 M	1,000 G	1,00 M	859,891260 M	-42.98	-29.98																																																																				
1,000 G	3,000 G	1,00 M	1,648000 G	-37.45	-24.45																																																																				
3,000 G	7,000 G	1,00 M	3,077000 G	-39.13	-26.13																																																																				
7,000 G	9,000 G	1,00 M	7,675000 G	-36.40	-23.40																																																																				
Middle Channel	Middle Channel																																																																								
 <table border="1" data-bbox="239 1176 654 1254"> <thead> <tr> <th>Start [Hz]</th> <th>Stop [Hz]</th> <th>RBW [Hz]</th> <th>Freq [Hz]</th> <th>PerAbs [dBm]</th> <th>ΔLimit [dB]</th> </tr> </thead> <tbody> <tr> <td>30,000 M</td> <td>820,000 M</td> <td>1,00 M</td> <td>818,017500 M</td> <td>-44.05</td> <td>-31.05</td> </tr> <tr> <td>850,000 M</td> <td>1,000 G</td> <td>1,00 M</td> <td>861,093700 M</td> <td>-43.24</td> <td>-30.24</td> </tr> <tr> <td>1,000 G</td> <td>3,000 G</td> <td>1,00 M</td> <td>1,673000 G</td> <td>-30.45</td> <td>-17.45</td> </tr> <tr> <td>3,000 G</td> <td>7,000 G</td> <td>1,00 M</td> <td>3,027000 G</td> <td>-38.94</td> <td>-25.94</td> </tr> <tr> <td>7,000 G</td> <td>9,000 G</td> <td>1,00 M</td> <td>8,381000 G</td> <td>-36.88</td> <td>-23.88</td> </tr> </tbody> </table> <p>Date: 20.FEB.2019 16:29:07</p>	Start [Hz]	Stop [Hz]	RBW [Hz]	Freq [Hz]	PerAbs [dBm]	ΔLimit [dB]	30,000 M	820,000 M	1,00 M	818,017500 M	-44.05	-31.05	850,000 M	1,000 G	1,00 M	861,093700 M	-43.24	-30.24	1,000 G	3,000 G	1,00 M	1,673000 G	-30.45	-17.45	3,000 G	7,000 G	1,00 M	3,027000 G	-38.94	-25.94	7,000 G	9,000 G	1,00 M	8,381000 G	-36.88	-23.88	 <table border="1" data-bbox="877 1176 1292 1254"> <thead> <tr> <th>Start [Hz]</th> <th>Stop [Hz]</th> <th>RBW [Hz]</th> <th>Freq [Hz]</th> <th>PerAbs [dBm]</th> <th>ΔLimit [dB]</th> </tr> </thead> <tbody> <tr> <td>30,000 M</td> <td>820,000 M</td> <td>1,00 M</td> <td>771,612500 M</td> <td>-42.25</td> <td>-29.25</td> </tr> <tr> <td>850,000 M</td> <td>1,000 G</td> <td>1,00 M</td> <td>861,087500 M</td> <td>-42.36</td> <td>-29.36</td> </tr> <tr> <td>1,000 G</td> <td>3,000 G</td> <td>1,00 M</td> <td>1,673500 G</td> <td>-37.42</td> <td>-24.42</td> </tr> <tr> <td>3,000 G</td> <td>7,000 G</td> <td>1,00 M</td> <td>3,003000 G</td> <td>-38.64</td> <td>-25.64</td> </tr> <tr> <td>7,000 G</td> <td>9,000 G</td> <td>1,00 M</td> <td>8,389000 G</td> <td>-36.73</td> <td>-23.73</td> </tr> </tbody> </table> <p>Date: 20.FEB.2019 16:36:52</p>	Start [Hz]	Stop [Hz]	RBW [Hz]	Freq [Hz]	PerAbs [dBm]	ΔLimit [dB]	30,000 M	820,000 M	1,00 M	771,612500 M	-42.25	-29.25	850,000 M	1,000 G	1,00 M	861,087500 M	-42.36	-29.36	1,000 G	3,000 G	1,00 M	1,673500 G	-37.42	-24.42	3,000 G	7,000 G	1,00 M	3,003000 G	-38.64	-25.64	7,000 G	9,000 G	1,00 M	8,389000 G	-36.73	-23.73
Start [Hz]	Stop [Hz]	RBW [Hz]	Freq [Hz]	PerAbs [dBm]	ΔLimit [dB]																																																																				
30,000 M	820,000 M	1,00 M	818,017500 M	-44.05	-31.05																																																																				
850,000 M	1,000 G	1,00 M	861,093700 M	-43.24	-30.24																																																																				
1,000 G	3,000 G	1,00 M	1,673000 G	-30.45	-17.45																																																																				
3,000 G	7,000 G	1,00 M	3,027000 G	-38.94	-25.94																																																																				
7,000 G	9,000 G	1,00 M	8,381000 G	-36.88	-23.88																																																																				
Start [Hz]	Stop [Hz]	RBW [Hz]	Freq [Hz]	PerAbs [dBm]	ΔLimit [dB]																																																																				
30,000 M	820,000 M	1,00 M	771,612500 M	-42.25	-29.25																																																																				
850,000 M	1,000 G	1,00 M	861,087500 M	-42.36	-29.36																																																																				
1,000 G	3,000 G	1,00 M	1,673500 G	-37.42	-24.42																																																																				
3,000 G	7,000 G	1,00 M	3,003000 G	-38.64	-25.64																																																																				
7,000 G	9,000 G	1,00 M	8,389000 G	-36.73	-23.73																																																																				
Highest Channel	Highest Channel																																																																								
 <table border="1" data-bbox="239 1691 654 1769"> <thead> <tr> <th>Start [Hz]</th> <th>Stop [Hz]</th> <th>RBW [Hz]</th> <th>Freq [Hz]</th> <th>PerAbs [dBm]</th> <th>ΔLimit [dB]</th> </tr> </thead> <tbody> <tr> <td>30,000 M</td> <td>820,000 M</td> <td>1,00 M</td> <td>812,000000 M</td> <td>-44.05</td> <td>-31.05</td> </tr> <tr> <td>850,000 M</td> <td>1,000 G</td> <td>1,00 M</td> <td>850,036200 M</td> <td>-36.49</td> <td>-23.49</td> </tr> <tr> <td>1,000 G</td> <td>3,000 G</td> <td>1,00 M</td> <td>2,684000 G</td> <td>-42.59</td> <td>-28.59</td> </tr> <tr> <td>3,000 G</td> <td>7,000 G</td> <td>1,00 M</td> <td>3,067000 G</td> <td>-38.73</td> <td>-25.73</td> </tr> <tr> <td>7,000 G</td> <td>9,000 G</td> <td>1,00 M</td> <td>8,033000 G</td> <td>-36.59</td> <td>-23.59</td> </tr> </tbody> </table> <p>Date: 20.FEB.2019 16:31:28</p>	Start [Hz]	Stop [Hz]	RBW [Hz]	Freq [Hz]	PerAbs [dBm]	ΔLimit [dB]	30,000 M	820,000 M	1,00 M	812,000000 M	-44.05	-31.05	850,000 M	1,000 G	1,00 M	850,036200 M	-36.49	-23.49	1,000 G	3,000 G	1,00 M	2,684000 G	-42.59	-28.59	3,000 G	7,000 G	1,00 M	3,067000 G	-38.73	-25.73	7,000 G	9,000 G	1,00 M	8,033000 G	-36.59	-23.59	 <table border="1" data-bbox="877 1691 1292 1769"> <thead> <tr> <th>Start [Hz]</th> <th>Stop [Hz]</th> <th>RBW [Hz]</th> <th>Freq [Hz]</th> <th>PerAbs [dBm]</th> <th>ΔLimit [dB]</th> </tr> </thead> <tbody> <tr> <td>30,000 M</td> <td>820,000 M</td> <td>1,00 M</td> <td>799,000000 M</td> <td>-43.97</td> <td>-30.97</td> </tr> <tr> <td>850,000 M</td> <td>1,000 G</td> <td>1,00 M</td> <td>850,181200 M</td> <td>-40.30</td> <td>-27.30</td> </tr> <tr> <td>1,000 G</td> <td>3,000 G</td> <td>1,00 M</td> <td>1,697500 G</td> <td>-38.79</td> <td>-25.79</td> </tr> <tr> <td>3,000 G</td> <td>7,000 G</td> <td>1,00 M</td> <td>3,127000 G</td> <td>-38.80</td> <td>-25.80</td> </tr> <tr> <td>7,000 G</td> <td>9,000 G</td> <td>1,00 M</td> <td>7,665500 G</td> <td>-36.40</td> <td>-23.40</td> </tr> </tbody> </table> <p>Date: 20.FEB.2019 16:38:04</p>	Start [Hz]	Stop [Hz]	RBW [Hz]	Freq [Hz]	PerAbs [dBm]	ΔLimit [dB]	30,000 M	820,000 M	1,00 M	799,000000 M	-43.97	-30.97	850,000 M	1,000 G	1,00 M	850,181200 M	-40.30	-27.30	1,000 G	3,000 G	1,00 M	1,697500 G	-38.79	-25.79	3,000 G	7,000 G	1,00 M	3,127000 G	-38.80	-25.80	7,000 G	9,000 G	1,00 M	7,665500 G	-36.40	-23.40
Start [Hz]	Stop [Hz]	RBW [Hz]	Freq [Hz]	PerAbs [dBm]	ΔLimit [dB]																																																																				
30,000 M	820,000 M	1,00 M	812,000000 M	-44.05	-31.05																																																																				
850,000 M	1,000 G	1,00 M	850,036200 M	-36.49	-23.49																																																																				
1,000 G	3,000 G	1,00 M	2,684000 G	-42.59	-28.59																																																																				
3,000 G	7,000 G	1,00 M	3,067000 G	-38.73	-25.73																																																																				
7,000 G	9,000 G	1,00 M	8,033000 G	-36.59	-23.59																																																																				
Start [Hz]	Stop [Hz]	RBW [Hz]	Freq [Hz]	PerAbs [dBm]	ΔLimit [dB]																																																																				
30,000 M	820,000 M	1,00 M	799,000000 M	-43.97	-30.97																																																																				
850,000 M	1,000 G	1,00 M	850,181200 M	-40.30	-27.30																																																																				
1,000 G	3,000 G	1,00 M	1,697500 G	-38.79	-25.79																																																																				
3,000 G	7,000 G	1,00 M	3,127000 G	-38.80	-25.80																																																																				
7,000 G	9,000 G	1,00 M	7,665500 G	-36.40	-23.40																																																																				



GSM1900 (GPRS class 8)

GSM1900 (EDGE class 8)

Lowest Channel

Lowest Channel

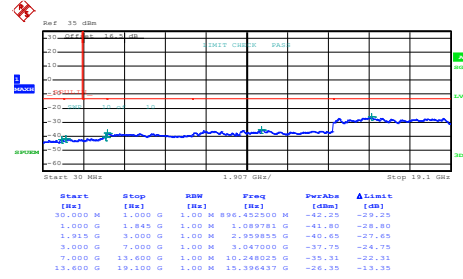
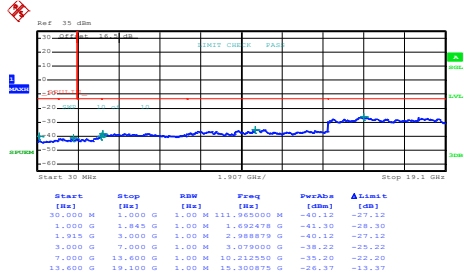

Date: 20.FEB.2019 16:54:19

Date: 20.FEB.2019 17:13:11

Middle Channel

Middle Channel

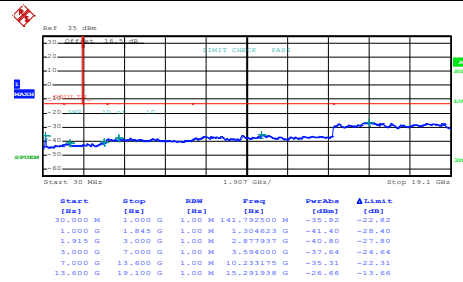
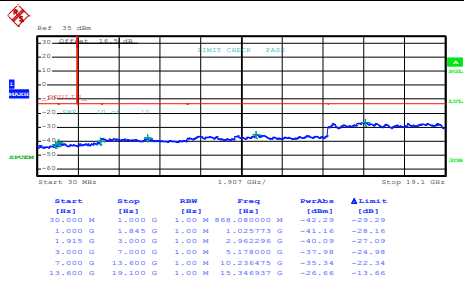

Date: 20.FEB.2019 16:55:12

Date: 20.FEB.2019 17:14:13

Highest Channel

Highest Channel

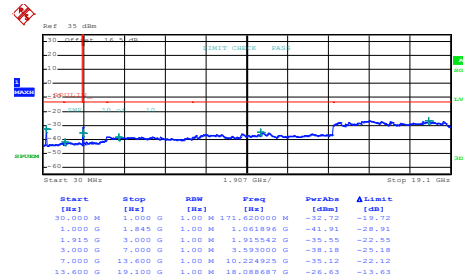
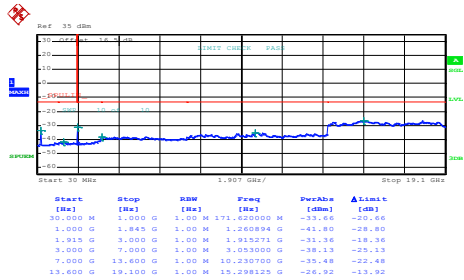

Date: 20.FEB.2019 16:56:49

Date: 20.FEB.2019 17:15:23



Frequency Stability

Test Conditions	Middle Channel	GSM850 (GPRS class 8)	GSM850 (EDGE class 8)	Limit 2.5ppm
Temperature (°C)	Voltage (Volt)	Deviation (ppm)		Result
50	Normal Voltage	0.0060	0.0096	PASS
40	Normal Voltage	0.0036	0.0072	
30	Normal Voltage	0.0084	0.0048	
20(Ref.)	Normal Voltage	0.0000	0.0000	
10	Normal Voltage	0.0012	0.0072	
0	Normal Voltage	0.0060	0.0120	
-10	Normal Voltage	0.0024	0.0143	
-20	Normal Voltage	0.0120	0.0179	
-30	Normal Voltage	0.0024	0.0096	
20	Maximum Voltage	0.0000	0.0072	
20	Normal Voltage	0.0000	0.0000	
20	Battery End Point	0.0024	0.0060	



Test Conditions	Middle Channel	GSM1900 (GPRS class 8)	GSM1900 (EDGE class 8)	Limit Note 2.
Temperature (°C)	Voltage (Volt)	Deviation (ppm)		Result
50	Normal Voltage	0.0043	0.0048	PASS
40	Normal Voltage	0.0000	0.0032	
30	Normal Voltage	0.0005	0.0021	
20(Ref.)	Normal Voltage	0.0000	0.0000	
10	Normal Voltage	0.0011	0.0048	
0	Normal Voltage	0.0021	0.0080	
-10	Normal Voltage	0.0043	0.0032	
-20	Normal Voltage	0.0016	0.0059	
-30	Normal Voltage	0.0053	0.0074	
20	Maximum Voltage	0.0043	0.0021	
20	Normal Voltage	0.0000	0.0000	
20	Battery End Point	0.0032	0.0005	

Note:

- 1. Normal Voltage = 3.85V. ; Battery End Point (BEP) = 3.65 V. ; Maximum Voltage =4.25 V
- 2. The frequency fundamental emissions stay within the authorized frequency block.





A3. WCDMA

Peak-to-Average Ratio

Mode	WCDMA Band V	WCDMA Band II	WCDMA Band IV	Limit: 13dB
Mod.	RMC 12.2Kbps	RMC 12.2Kbps	RMC 12.2Kbps	Result
Lowest CH	3.28	2.88	3.04	PASS
Middle CH	3.36	3.00	2.88	
Highest CH	3.40	3.00	3.04	

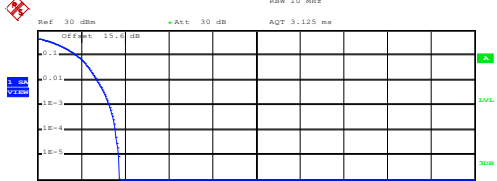

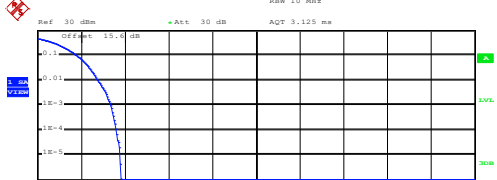
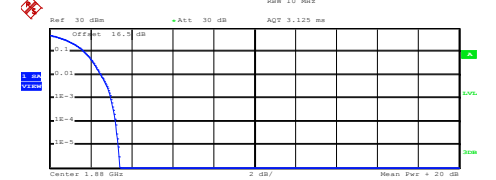
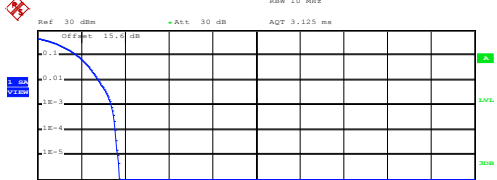
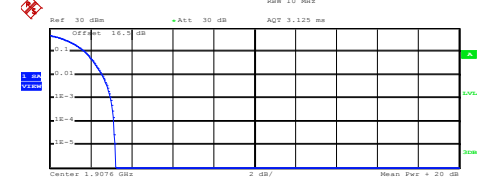
WCDMA Band V (RMC 12.2Kbps)	WCDMA Band II (RMC 12.2Kbps)
<p style="text-align: center;">Lowest Channel</p>  <p>Center 826.4 MHz RBW 10 MHz AGT 3.125 ms</p> <p>Ref 30 dBm Att 30 dB</p> <p>Complementary Cumulative Distribution Function (100000 samples)</p> <p>Trace 1</p> <p>Mean 22.74 dBm Peak 26.49 dBm Crest 3.75 dB</p> <p>10 % 1.80 dB 1 % 2.72 dB .1 % 3.28 dB .01 % 3.56 dB</p> <p>Date: 20.FEB.2019 18:08:01</p>	<p style="text-align: center;">Lowest Channel</p>  <p>Center 1.8524 GHz RBW 10 MHz AGT 3.125 ms</p> <p>Ref 30 dBm Att 30 dB</p> <p>Complementary Cumulative Distribution Function (100000 samples)</p> <p>Trace 1</p> <p>Mean 17.93 dBm Peak 20.98 dBm Crest 3.06 dB</p> <p>10 % 1.68 dB 1 % 2.52 dB .1 % 2.88 dB .01 % 3.00 dB</p> <p>Date: 20.FEB.2019 18:36:21</p>
<p style="text-align: center;">Middle Channel</p>  <p>Center 836.4 MHz RBW 10 MHz AGT 3.125 ms</p> <p>Ref 30 dBm Att 30 dB</p> <p>Complementary Cumulative Distribution Function (100000 samples)</p> <p>Trace 1</p> <p>Mean 22.83 dBm Peak 26.63 dBm Crest 3.80 dB</p> <p>10 % 1.80 dB 1 % 2.76 dB .1 % 3.36 dB .01 % 3.60 dB</p> <p>Date: 20.FEB.2019 18:08:18</p>	<p style="text-align: center;">Middle Channel</p>  <p>Center 1.85 GHz RBW 10 MHz AGT 3.125 ms</p> <p>Ref 30 dBm Att 30 dB</p> <p>Complementary Cumulative Distribution Function (100000 samples)</p> <p>Trace 1</p> <p>Mean 18.06 dBm Peak 21.48 dBm Crest 3.42 dB</p> <p>10 % 1.68 dB 1 % 2.52 dB .1 % 3.00 dB .01 % 3.24 dB</p> <p>Date: 20.FEB.2019 18:36:47</p>
<p style="text-align: center;">Highest Channel</p>  <p>Center 846.0 MHz RBW 10 MHz AGT 3.125 ms</p> <p>Ref 30 dBm Att 30 dB</p> <p>Complementary Cumulative Distribution Function (100000 samples)</p> <p>Trace 1</p> <p>Mean 22.88 dBm Peak 26.63 dBm Crest 3.75 dB</p> <p>10 % 1.84 dB 1 % 2.80 dB .1 % 3.40 dB .01 % 3.56 dB</p> <p>Date: 20.FEB.2019 18:08:35</p>	<p style="text-align: center;">Highest Channel</p>  <p>Center 1.9076 GHz RBW 10 MHz AGT 3.125 ms</p> <p>Ref 30 dBm Att 30 dB</p> <p>Complementary Cumulative Distribution Function (100000 samples)</p> <p>Trace 1</p> <p>Mean 17.90 dBm Peak 21.13 dBm Crest 3.22 dB</p> <p>10 % 1.72 dB 1 % 2.56 dB .1 % 3.00 dB .01 % 3.12 dB</p> <p>Date: 20.FEB.2019 18:37:05</p>



WCDMA Band IV (RMC 12.2Kbps)

Lowest Channel

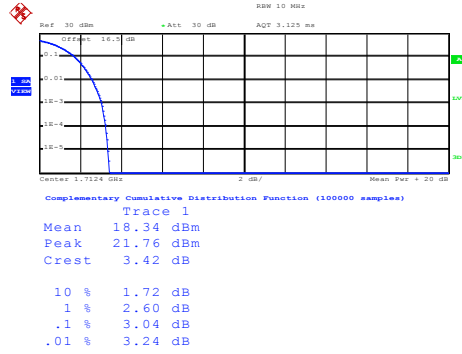

Date: 20.FEB.2019 18:56:26

Middle Channel

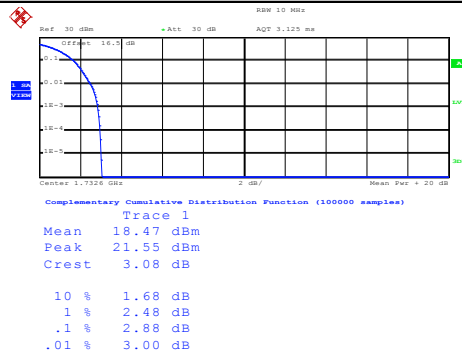

Date: 20.FEB.2019 18:56:41

Highest Channel

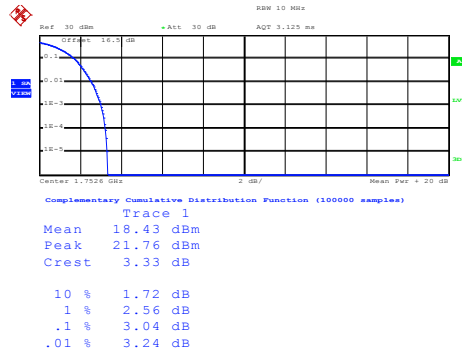

Date: 20.FEB.2019 18:56:55



26dB Bandwidth

Mode	WCDMA Band V 26dB BW(MHz)	WCDMA Band II 26dB BW(MHz)	WCDMA Band IV 26dB BW(MHz)
Mod.	RMC 12.2Kbps	RMC 12.2Kbps	RMC 12.2Kbps
Lowest CH	4.70	4.71	4.71
Middle CH	4.71	4.73	4.73
Highest CH	4.74	4.74	4.72



WCDMA Band V (RMC 12.2Kbps)

WCDMA Band II (RMC 12.2Kbps)

Lowest Channel

Lowest Channel

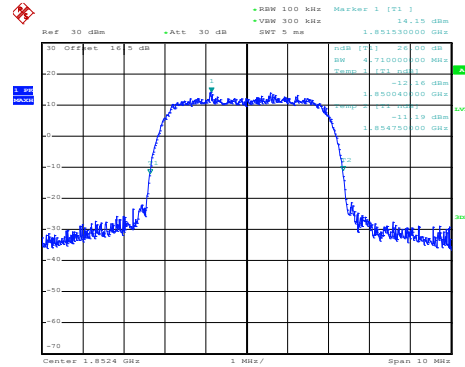
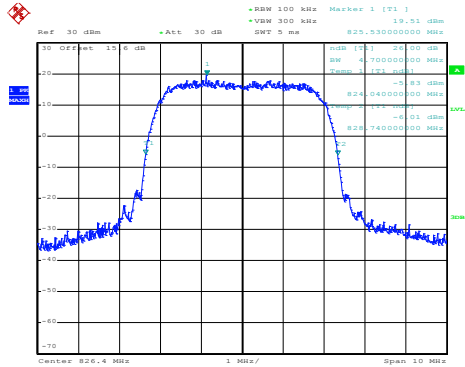

Date: 20.FEB.2019 17:18:49

Date: 20.FEB.2019 18:15:29

Middle Channel

Middle Channel

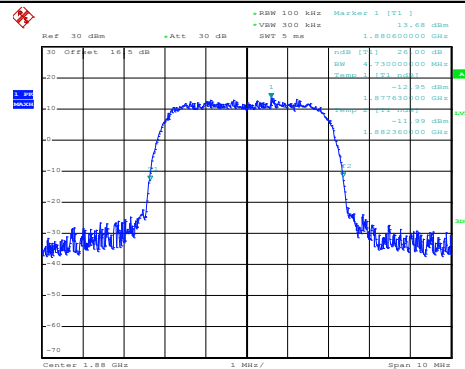
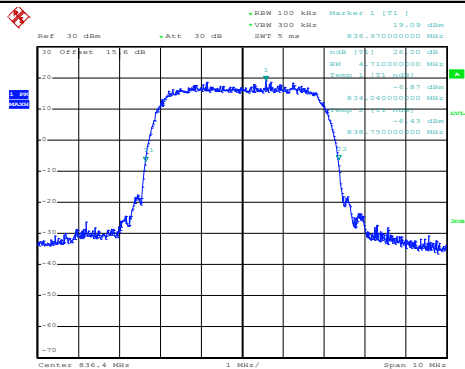

Date: 20.FEB.2019 17:19:34

Date: 20.FEB.2019 18:16:03

Highest Channel

Highest Channel

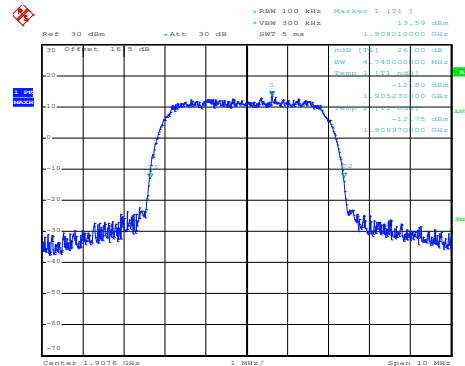
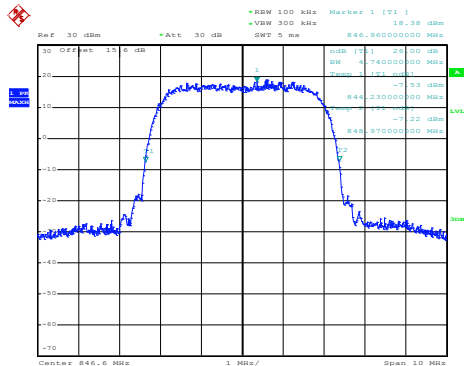

Date: 20.FEB.2019 17:21:19

Date: 20.FEB.2019 18:16:38



WCDMA Band IV (RMC 12.2Kbps)

Lowest Channel

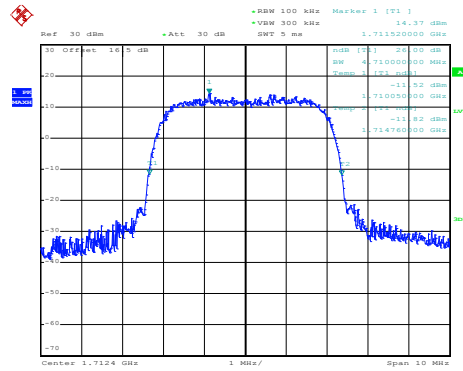

Date: 20.FEB.2019 18:38:01

Middle Channel

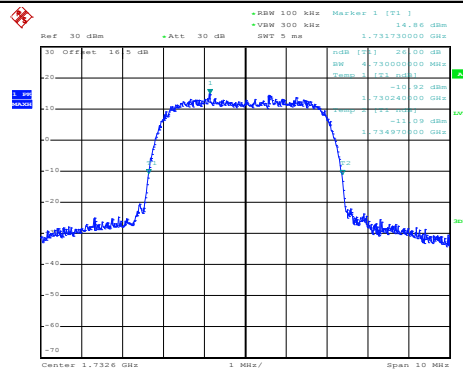

Date: 20.FEB.2019 18:38:36

Highest Channel

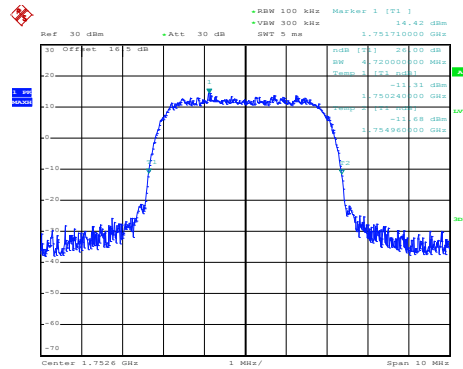

Date: 20.FEB.2019 18:39:25



Occupied Bandwidth

Mode	WCDMA Band V 99% OBW(MHz)	WCDMA Band II 99% OBW(MHz)	WCDMA Band IV 99% OBW(MHz)
Mod.	RMC 12.2Kbps	RMC 12.2Kbps	RMC 12.2Kbps
Lowest CH	4.14	4.16	4.13
Middle CH	4.14	4.15	4.16
Highest CH	4.15	4.14	4.15



WCDMA Band V (RMC 12.2Kbps)

Lowest Channel

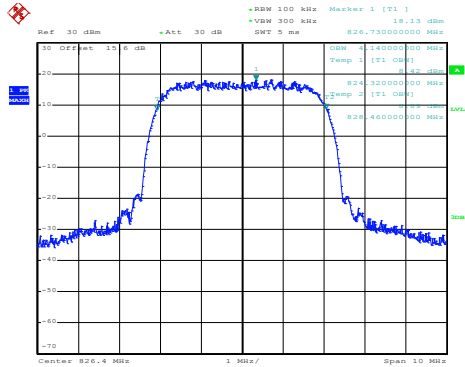

Date: 20.FEB.2019 17:22:03

WCDMA Band II (RMC 12.2Kbps)

Lowest Channel

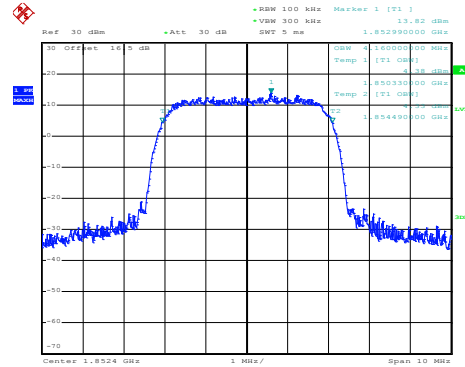

Date: 20.FEB.2019 18:24:09

Middle Channel

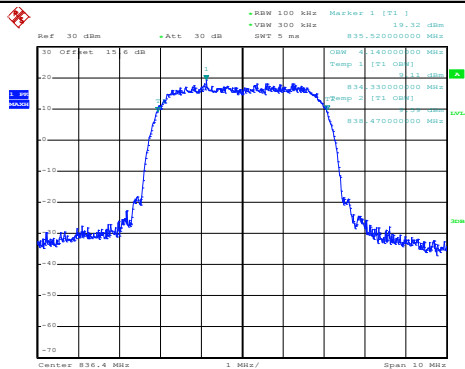

Date: 20.FEB.2019 17:22:50

Middle Channel

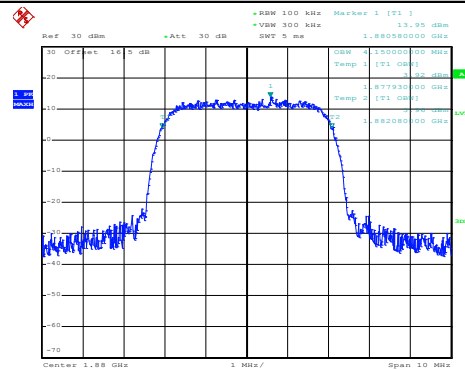

Date: 20.FEB.2019 18:24:45

Highest Channel

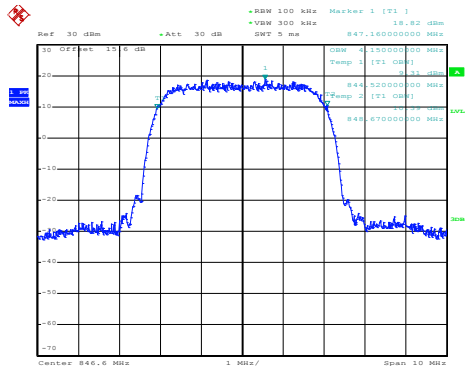

Date: 20.FEB.2019 17:23:52

Highest Channel

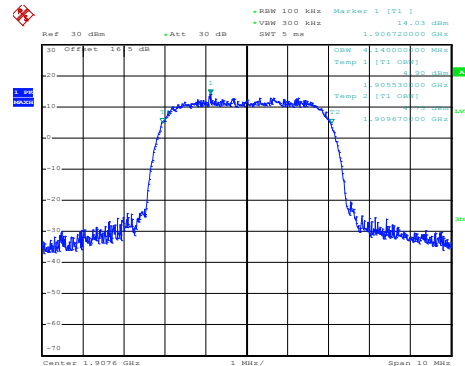

Date: 20.FEB.2019 18:25:21



WCDMA Band IV (RMC 12.2Kbps)

Lowest Channel

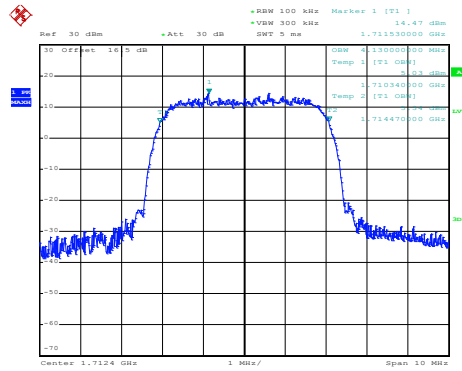

Date: 20.FEB.2019 18:40:08

Middle Channel

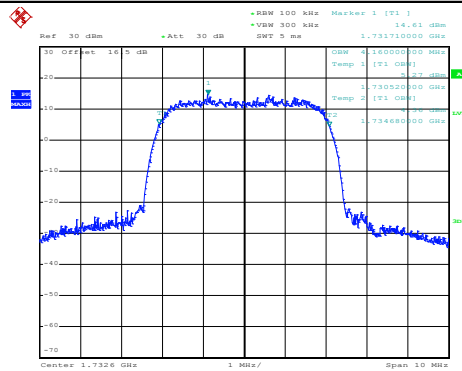

Date: 20.FEB.2019 18:40:53

Highest Channel

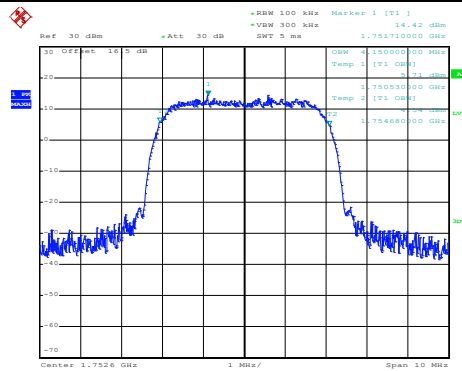

Date: 20.FEB.2019 18:41:35



Conducted Band Edge

WCDMA Band V (RMC 12.2Kbps)

Lowest Band Edge

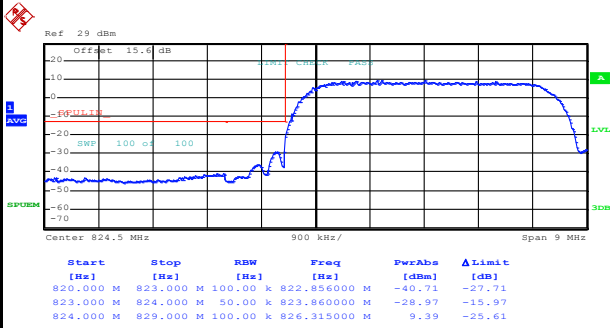

Date: 20.FEB.2019 17:26:46

Highest Band Edge

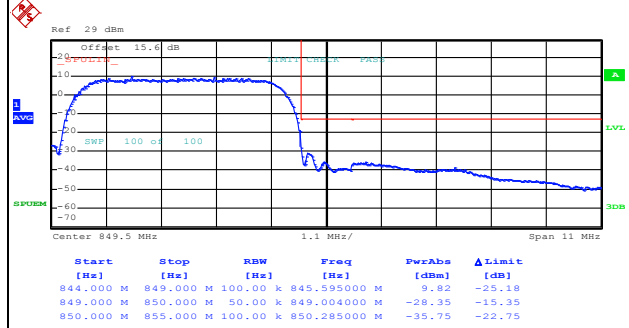

Date: 20.FEB.2019 18:07:34

WCDMA Band II (RMC 12.2Kbps)

Lowest Band Edge

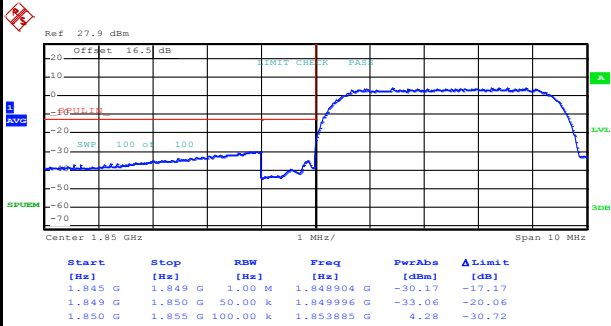

Date: 20.FEB.2019 18:28:17

Highest Band Edge

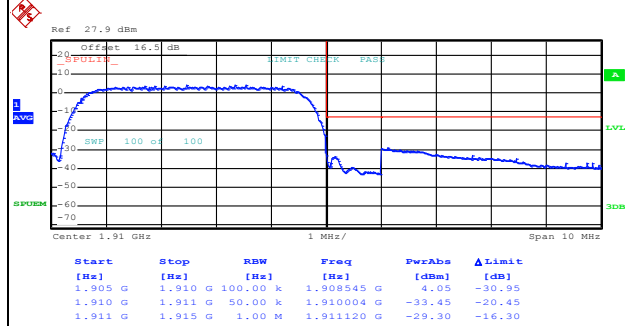

Date: 20.FEB.2019 18:31:22



WCDMA Band IV (RMC 12.2Kbps)

Lowest Band Edge

Highest Band Edge

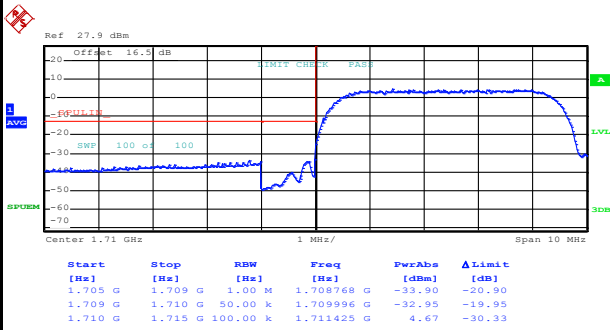

Date: 20.FEB.2019 18:45:30

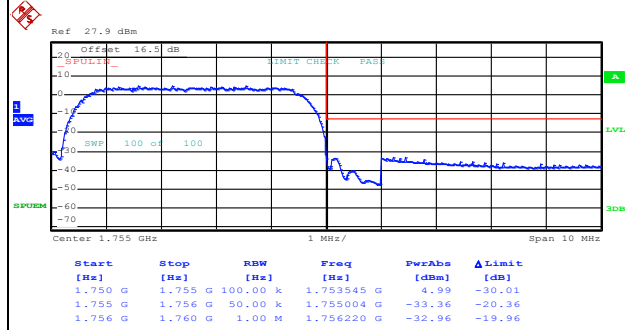

Date: 20.FEB.2019 18:48:35

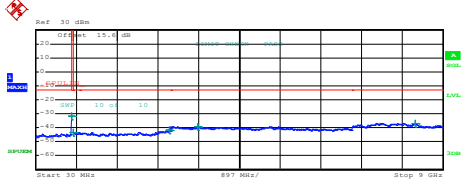
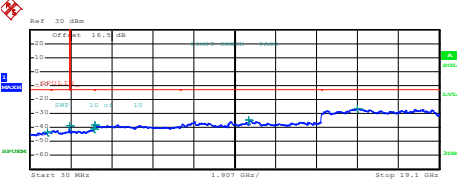
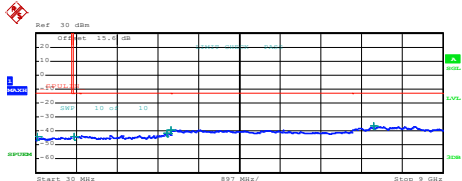
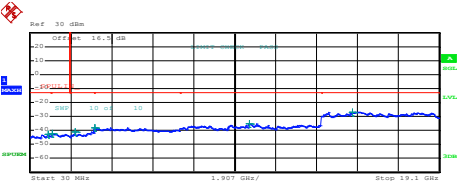
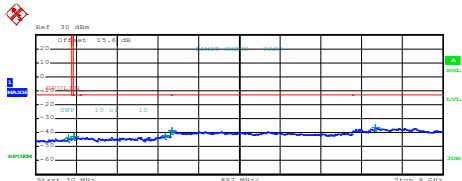
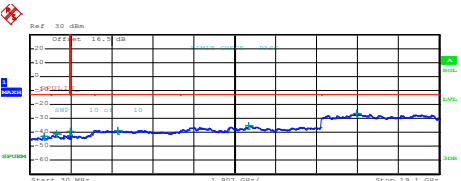

Conducted Spurious Emission

WCDMA Band V (RMC 12.2Kbps)	WCDMA Band II (RMC 12.2Kbps)																																																																																										
Lowest Channel	Lowest Channel																																																																																										
 <table border="1" data-bbox="239 660 654 739"> <thead> <tr> <th>Start</th> <th>Stop</th> <th>RBW</th> <th>Freq</th> <th>PwrAbs</th> <th>ΔLimit</th> </tr> <tr> <th>[Hz]</th> <th>[Hz]</th> <th>[Hz]</th> <th>[Hz]</th> <th>[dBm]</th> <th>[dB]</th> </tr> </thead> <tbody> <tr> <td>30,000 M</td> <td>820,000 M</td> <td>1,000 M</td> <td>819,407500 M</td> <td>-31.93</td> <td>-38.93</td> </tr> <tr> <td>835,000 M</td> <td>1,000 G</td> <td>1,000 G</td> <td>864,062501 M</td> <td>-43.33</td> <td>-30.33</td> </tr> <tr> <td>1,000 G</td> <td>3,000 G</td> <td>1,000 M</td> <td>2,975000 G</td> <td>-42.55</td> <td>-28.55</td> </tr> <tr> <td>3,000 G</td> <td>7,000 G</td> <td>1,000 M</td> <td>3,520000 G</td> <td>-39.02</td> <td>-26.02</td> </tr> <tr> <td>7,000 G</td> <td>9,000 G</td> <td>1,000 M</td> <td>8,383000 G</td> <td>-36.80</td> <td>-23.80</td> </tr> </tbody> </table> <p>Date: 20.FEB.2019 18:12:24</p>	Start	Stop	RBW	Freq	PwrAbs	ΔLimit	[Hz]	[Hz]	[Hz]	[Hz]	[dBm]	[dB]	30,000 M	820,000 M	1,000 M	819,407500 M	-31.93	-38.93	835,000 M	1,000 G	1,000 G	864,062501 M	-43.33	-30.33	1,000 G	3,000 G	1,000 M	2,975000 G	-42.55	-28.55	3,000 G	7,000 G	1,000 M	3,520000 G	-39.02	-26.02	7,000 G	9,000 G	1,000 M	8,383000 G	-36.80	-23.80	 <table border="1" data-bbox="893 660 1308 739"> <thead> <tr> <th>Start</th> <th>Stop</th> <th>RBW</th> <th>Freq</th> <th>PwrAbs</th> <th>ΔLimit</th> </tr> <tr> <th>[Hz]</th> <th>[Hz]</th> <th>[Hz]</th> <th>[Hz]</th> <th>[dBm]</th> <th>[dB]</th> </tr> </thead> <tbody> <tr> <td>30,000 M</td> <td>1,000 G</td> <td>1,000 M</td> <td>830,975000 M</td> <td>-43.12</td> <td>-30.12</td> </tr> <tr> <td>1,000 G</td> <td>3,845 G</td> <td>1,000 M</td> <td>3,844578 G</td> <td>-38.60</td> <td>-25.60</td> </tr> <tr> <td>3,845 G</td> <td>3,000 G</td> <td>1,000 M</td> <td>2,997288 G</td> <td>-40.99</td> <td>-27.99</td> </tr> <tr> <td>3,000 G</td> <td>7,000 G</td> <td>1,000 M</td> <td>3,036000 G</td> <td>-38.22</td> <td>-25.22</td> </tr> <tr> <td>7,000 G</td> <td>13,600 G</td> <td>1,000 M</td> <td>10,213725 G</td> <td>-34.68</td> <td>-21.68</td> </tr> <tr> <td>13,600 G</td> <td>19,100 G</td> <td>1,000 M</td> <td>15,208563 G</td> <td>-26.70</td> <td>-13.70</td> </tr> </tbody> </table> <p>Date: 20.FEB.2019 18:34:10</p>	Start	Stop	RBW	Freq	PwrAbs	ΔLimit	[Hz]	[Hz]	[Hz]	[Hz]	[dBm]	[dB]	30,000 M	1,000 G	1,000 M	830,975000 M	-43.12	-30.12	1,000 G	3,845 G	1,000 M	3,844578 G	-38.60	-25.60	3,845 G	3,000 G	1,000 M	2,997288 G	-40.99	-27.99	3,000 G	7,000 G	1,000 M	3,036000 G	-38.22	-25.22	7,000 G	13,600 G	1,000 M	10,213725 G	-34.68	-21.68	13,600 G	19,100 G	1,000 M	15,208563 G	-26.70	-13.70
Start	Stop	RBW	Freq	PwrAbs	ΔLimit																																																																																						
[Hz]	[Hz]	[Hz]	[Hz]	[dBm]	[dB]																																																																																						
30,000 M	820,000 M	1,000 M	819,407500 M	-31.93	-38.93																																																																																						
835,000 M	1,000 G	1,000 G	864,062501 M	-43.33	-30.33																																																																																						
1,000 G	3,000 G	1,000 M	2,975000 G	-42.55	-28.55																																																																																						
3,000 G	7,000 G	1,000 M	3,520000 G	-39.02	-26.02																																																																																						
7,000 G	9,000 G	1,000 M	8,383000 G	-36.80	-23.80																																																																																						
Start	Stop	RBW	Freq	PwrAbs	ΔLimit																																																																																						
[Hz]	[Hz]	[Hz]	[Hz]	[dBm]	[dB]																																																																																						
30,000 M	1,000 G	1,000 M	830,975000 M	-43.12	-30.12																																																																																						
1,000 G	3,845 G	1,000 M	3,844578 G	-38.60	-25.60																																																																																						
3,845 G	3,000 G	1,000 M	2,997288 G	-40.99	-27.99																																																																																						
3,000 G	7,000 G	1,000 M	3,036000 G	-38.22	-25.22																																																																																						
7,000 G	13,600 G	1,000 M	10,213725 G	-34.68	-21.68																																																																																						
13,600 G	19,100 G	1,000 M	15,208563 G	-26.70	-13.70																																																																																						
Middle Channel	Middle Channel																																																																																										
 <table border="1" data-bbox="239 1178 654 1256"> <thead> <tr> <th>Start</th> <th>Stop</th> <th>RBW</th> <th>Freq</th> <th>PwrAbs</th> <th>ΔLimit</th> </tr> <tr> <th>[Hz]</th> <th>[Hz]</th> <th>[Hz]</th> <th>[Hz]</th> <th>[dBm]</th> <th>[dB]</th> </tr> </thead> <tbody> <tr> <td>30,000 M</td> <td>820,000 M</td> <td>1,000 M</td> <td>84,365000 M</td> <td>-43.76</td> <td>-30.76</td> </tr> <tr> <td>835,000 M</td> <td>1,000 G</td> <td>1,000 M</td> <td>866,328751 M</td> <td>-42.79</td> <td>-30.79</td> </tr> <tr> <td>1,000 G</td> <td>3,000 G</td> <td>1,000 M</td> <td>2,921500 G</td> <td>-41.80</td> <td>-28.80</td> </tr> <tr> <td>3,000 G</td> <td>7,000 G</td> <td>1,000 M</td> <td>3,005000 G</td> <td>-39.27</td> <td>-26.27</td> </tr> <tr> <td>7,000 G</td> <td>9,000 G</td> <td>1,000 M</td> <td>7,474500 G</td> <td>-36.63</td> <td>-23.63</td> </tr> </tbody> </table> <p>Date: 20.FEB.2019 18:13:17</p>	Start	Stop	RBW	Freq	PwrAbs	ΔLimit	[Hz]	[Hz]	[Hz]	[Hz]	[dBm]	[dB]	30,000 M	820,000 M	1,000 M	84,365000 M	-43.76	-30.76	835,000 M	1,000 G	1,000 M	866,328751 M	-42.79	-30.79	1,000 G	3,000 G	1,000 M	2,921500 G	-41.80	-28.80	3,000 G	7,000 G	1,000 M	3,005000 G	-39.27	-26.27	7,000 G	9,000 G	1,000 M	7,474500 G	-36.63	-23.63	 <table border="1" data-bbox="893 1178 1308 1256"> <thead> <tr> <th>Start</th> <th>Stop</th> <th>RBW</th> <th>Freq</th> <th>PwrAbs</th> <th>ΔLimit</th> </tr> <tr> <th>[Hz]</th> <th>[Hz]</th> <th>[Hz]</th> <th>[Hz]</th> <th>[dBm]</th> <th>[dB]</th> </tr> </thead> <tbody> <tr> <td>30,000 M</td> <td>1,000 G</td> <td>1,000 M</td> <td>880,205000 M</td> <td>-42.87</td> <td>-29.87</td> </tr> <tr> <td>1,000 G</td> <td>3,845 G</td> <td>1,000 M</td> <td>3,047583 G</td> <td>-42.21</td> <td>-29.21</td> </tr> <tr> <td>3,845 G</td> <td>3,000 G</td> <td>1,000 M</td> <td>2,114098 G</td> <td>-41.16</td> <td>-28.16</td> </tr> <tr> <td>3,000 G</td> <td>7,000 G</td> <td>1,000 M</td> <td>3,042000 G</td> <td>-38.01</td> <td>-25.01</td> </tr> <tr> <td>7,000 G</td> <td>13,600 G</td> <td>1,000 M</td> <td>10,242250 G</td> <td>-35.22</td> <td>-22.22</td> </tr> <tr> <td>13,600 G</td> <td>19,100 G</td> <td>1,000 M</td> <td>15,057500 G</td> <td>-26.89</td> <td>-13.89</td> </tr> </tbody> </table> <p>Date: 20.FEB.2019 18:35:03</p>	Start	Stop	RBW	Freq	PwrAbs	ΔLimit	[Hz]	[Hz]	[Hz]	[Hz]	[dBm]	[dB]	30,000 M	1,000 G	1,000 M	880,205000 M	-42.87	-29.87	1,000 G	3,845 G	1,000 M	3,047583 G	-42.21	-29.21	3,845 G	3,000 G	1,000 M	2,114098 G	-41.16	-28.16	3,000 G	7,000 G	1,000 M	3,042000 G	-38.01	-25.01	7,000 G	13,600 G	1,000 M	10,242250 G	-35.22	-22.22	13,600 G	19,100 G	1,000 M	15,057500 G	-26.89	-13.89
Start	Stop	RBW	Freq	PwrAbs	ΔLimit																																																																																						
[Hz]	[Hz]	[Hz]	[Hz]	[dBm]	[dB]																																																																																						
30,000 M	820,000 M	1,000 M	84,365000 M	-43.76	-30.76																																																																																						
835,000 M	1,000 G	1,000 M	866,328751 M	-42.79	-30.79																																																																																						
1,000 G	3,000 G	1,000 M	2,921500 G	-41.80	-28.80																																																																																						
3,000 G	7,000 G	1,000 M	3,005000 G	-39.27	-26.27																																																																																						
7,000 G	9,000 G	1,000 M	7,474500 G	-36.63	-23.63																																																																																						
Start	Stop	RBW	Freq	PwrAbs	ΔLimit																																																																																						
[Hz]	[Hz]	[Hz]	[Hz]	[dBm]	[dB]																																																																																						
30,000 M	1,000 G	1,000 M	880,205000 M	-42.87	-29.87																																																																																						
1,000 G	3,845 G	1,000 M	3,047583 G	-42.21	-29.21																																																																																						
3,845 G	3,000 G	1,000 M	2,114098 G	-41.16	-28.16																																																																																						
3,000 G	7,000 G	1,000 M	3,042000 G	-38.01	-25.01																																																																																						
7,000 G	13,600 G	1,000 M	10,242250 G	-35.22	-22.22																																																																																						
13,600 G	19,100 G	1,000 M	15,057500 G	-26.89	-13.89																																																																																						
Highest Channel	Highest Channel																																																																																										
 <table border="1" data-bbox="239 1695 654 1774"> <thead> <tr> <th>Start</th> <th>Stop</th> <th>RBW</th> <th>Freq</th> <th>PwrAbs</th> <th>ΔLimit</th> </tr> <tr> <th>[Hz]</th> <th>[Hz]</th> <th>[Hz]</th> <th>[Hz]</th> <th>[dBm]</th> <th>[dB]</th> </tr> </thead> <tbody> <tr> <td>30,000 M</td> <td>820,000 M</td> <td>1,000 M</td> <td>747,317500 M</td> <td>-44.12</td> <td>-31.12</td> </tr> <tr> <td>835,000 M</td> <td>1,000 G</td> <td>1,000 M</td> <td>877,910002 M</td> <td>-42.95</td> <td>-29.95</td> </tr> <tr> <td>1,000 G</td> <td>3,000 G</td> <td>1,000 M</td> <td>2,980500 G</td> <td>-42.21</td> <td>-29.21</td> </tr> <tr> <td>3,000 G</td> <td>7,000 G</td> <td>1,000 M</td> <td>3,029000 G</td> <td>-38.94</td> <td>-25.94</td> </tr> <tr> <td>7,000 G</td> <td>9,000 G</td> <td>1,000 M</td> <td>7,506000 G</td> <td>-36.42</td> <td>-23.42</td> </tr> </tbody> </table> <p>Date: 20.FEB.2019 18:14:10</p>	Start	Stop	RBW	Freq	PwrAbs	ΔLimit	[Hz]	[Hz]	[Hz]	[Hz]	[dBm]	[dB]	30,000 M	820,000 M	1,000 M	747,317500 M	-44.12	-31.12	835,000 M	1,000 G	1,000 M	877,910002 M	-42.95	-29.95	1,000 G	3,000 G	1,000 M	2,980500 G	-42.21	-29.21	3,000 G	7,000 G	1,000 M	3,029000 G	-38.94	-25.94	7,000 G	9,000 G	1,000 M	7,506000 G	-36.42	-23.42	 <table border="1" data-bbox="893 1695 1308 1774"> <thead> <tr> <th>Start</th> <th>Stop</th> <th>RBW</th> <th>Freq</th> <th>PwrAbs</th> <th>ΔLimit</th> </tr> <tr> <th>[Hz]</th> <th>[Hz]</th> <th>[Hz]</th> <th>[Hz]</th> <th>[dBm]</th> <th>[dB]</th> </tr> </thead> <tbody> <tr> <td>30,000 M</td> <td>1,000 G</td> <td>1,000 M</td> <td>676,557000 M</td> <td>-45.65</td> <td>-32.65</td> </tr> <tr> <td>1,000 G</td> <td>3,845 G</td> <td>1,000 M</td> <td>3,237022 G</td> <td>-41.31</td> <td>-28.31</td> </tr> <tr> <td>3,845 G</td> <td>3,000 G</td> <td>1,000 M</td> <td>1,936386 G</td> <td>-39.50</td> <td>-26.50</td> </tr> <tr> <td>3,000 G</td> <td>7,000 G</td> <td>1,000 M</td> <td>4,096000 G</td> <td>-38.51</td> <td>-25.51</td> </tr> <tr> <td>7,000 G</td> <td>13,600 G</td> <td>1,000 M</td> <td>10,215025 G</td> <td>-35.07</td> <td>-22.07</td> </tr> <tr> <td>13,600 G</td> <td>19,100 G</td> <td>1,000 M</td> <td>15,238938 G</td> <td>-26.63</td> <td>-13.63</td> </tr> </tbody> </table> <p>Date: 20.FEB.2019 18:35:57</p>	Start	Stop	RBW	Freq	PwrAbs	ΔLimit	[Hz]	[Hz]	[Hz]	[Hz]	[dBm]	[dB]	30,000 M	1,000 G	1,000 M	676,557000 M	-45.65	-32.65	1,000 G	3,845 G	1,000 M	3,237022 G	-41.31	-28.31	3,845 G	3,000 G	1,000 M	1,936386 G	-39.50	-26.50	3,000 G	7,000 G	1,000 M	4,096000 G	-38.51	-25.51	7,000 G	13,600 G	1,000 M	10,215025 G	-35.07	-22.07	13,600 G	19,100 G	1,000 M	15,238938 G	-26.63	-13.63
Start	Stop	RBW	Freq	PwrAbs	ΔLimit																																																																																						
[Hz]	[Hz]	[Hz]	[Hz]	[dBm]	[dB]																																																																																						
30,000 M	820,000 M	1,000 M	747,317500 M	-44.12	-31.12																																																																																						
835,000 M	1,000 G	1,000 M	877,910002 M	-42.95	-29.95																																																																																						
1,000 G	3,000 G	1,000 M	2,980500 G	-42.21	-29.21																																																																																						
3,000 G	7,000 G	1,000 M	3,029000 G	-38.94	-25.94																																																																																						
7,000 G	9,000 G	1,000 M	7,506000 G	-36.42	-23.42																																																																																						
Start	Stop	RBW	Freq	PwrAbs	ΔLimit																																																																																						
[Hz]	[Hz]	[Hz]	[Hz]	[dBm]	[dB]																																																																																						
30,000 M	1,000 G	1,000 M	676,557000 M	-45.65	-32.65																																																																																						
1,000 G	3,845 G	1,000 M	3,237022 G	-41.31	-28.31																																																																																						
3,845 G	3,000 G	1,000 M	1,936386 G	-39.50	-26.50																																																																																						
3,000 G	7,000 G	1,000 M	4,096000 G	-38.51	-25.51																																																																																						
7,000 G	13,600 G	1,000 M	10,215025 G	-35.07	-22.07																																																																																						
13,600 G	19,100 G	1,000 M	15,238938 G	-26.63	-13.63																																																																																						



WCDMA Band IV (RMC 12.2Kbps)

Lowest Channel

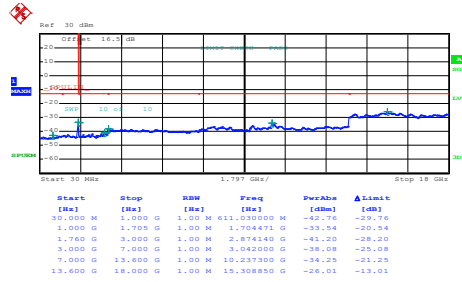

Date: 20.FEB.2019 18:54:10

Middle Channel

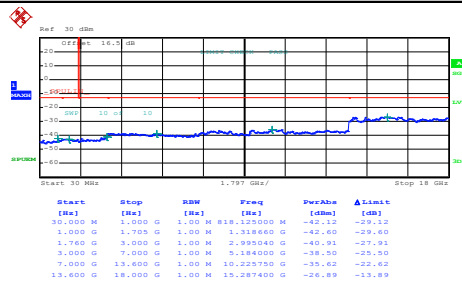

Date: 20.FEB.2019 18:55:02

Highest Channel

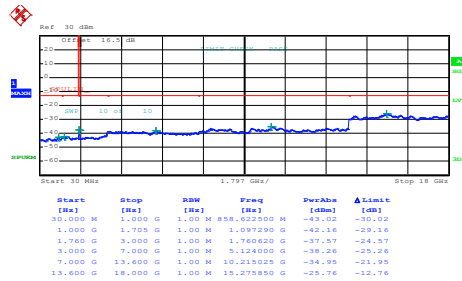

Date: 20.FEB.2019 18:55:55



Frequency Stability

Test Conditions	Middle Channel	WCDMA Band V (RMC 12.2Kbps)	Limit 2.5ppm
Temperature (°C)	Voltage (Volt)	Deviation (ppm)	Result
50	Normal Voltage	0.0132	PASS
40	Normal Voltage	0.0155	
30	Normal Voltage	0.0143	
20(Ref.)	Normal Voltage	0.0000	
10	Normal Voltage	0.0048	
0	Normal Voltage	0.0060	
-10	Normal Voltage	0.0120	
-20	Normal Voltage	0.0155	
-30	Normal Voltage	0.0108	
20	Maximum Voltage	0.0036	
20	Normal Voltage	0.0000	
20	Battery End Point	0.0048	

Test Conditions	Middle Channel	WCDMA Band II (RMC 12.2Kbps)	Limit Note 2.
Temperature (°C)	Voltage (Volt)	Deviation (ppm)	Result
50	Normal Voltage	0.0005	PASS
40	Normal Voltage	0.0021	
30	Normal Voltage	0.0011	
20(Ref.)	Normal Voltage	0.0000	
10	Normal Voltage	0.0005	
0	Normal Voltage	0.0000	
-10	Normal Voltage	0.0005	
-20	Normal Voltage	0.0005	
-30	Normal Voltage	0.0016	
20	Maximum Voltage	0.0005	
20	Normal Voltage	0.0000	
20	Battery End Point	0.0016	



Test Conditions	Middle Channel	WCDMA Band IV (RMC 12.2Kbps)	Limit Note 2.
Temperature (°C)	Voltage (Volt)	Deviation (ppm)	Result
50	Normal Voltage	0.0023	PASS
40	Normal Voltage	0.0017	
30	Normal Voltage	0.0035	
20(Ref.)	Normal Voltage	0.0000	
10	Normal Voltage	0.0075	
0	Normal Voltage	0.0035	
-10	Normal Voltage	0.0040	
-20	Normal Voltage	0.0017	
-30	Normal Voltage	0.0006	
20	Maximum Voltage	0.0012	
20	Normal Voltage	0.0000	
20	Battery End Point	0.0023	

Note:

1. Normal Voltage = 3.85V. ; Battery End Point (BEP) = 3.65 V. ; Maximum Voltage =4.25 V
2. The frequency fundamental emissions stay within the authorized frequency block.



Appendix B. Test Results of ERP/EIRP and Radiated Test

ERP/EIRP

Channel	Mode	Conducted		ERP	
		Power (dBm)	Power (Watts)	ERP(dBm)	ERP(W)
Lowest	GSM850	31.24	1.3305	26.19	0.4159
Middle	GPRS class 8	31.31	1.3521	26.26	0.4227
Highest	(GT - LC = -2.9 dB)	31.26	1.3366	26.21	0.4178
Lowest	GSM850	26.83	0.4819	21.78	0.1507
Middle	EDGE class 8	26.87	0.4864	21.82	0.1521
Highest	(GT - LC = -2.9 dB)	26.84	0.4831	21.79	0.1510
Lowest	WCDMA Band V	24.03	0.2529	18.98	0.0791
Middle	RMC 12.2Kbps	24.18	0.2618	19.13	0.0818
Highest	(GT - LC = -2.9 dB)	24.11	0.2576	19.06	0.0805
Limit	ERP < 7W	Result		PASS	

Channel	Mode	Conducted		EIRP	
		Power (dBm)	Power (Watts)	EIRP(dBm)	EIRP(W)
Lowest	GSM1900	27.12	0.5152	22.52	0.1786
Middle	GPRS class 8	27.54	0.5675	22.94	0.1968
Highest	(GT - LC = -4.6 dB)	27.65	0.5821	23.05	0.2018
Lowest	GSM1900	25.43	0.3491	20.83	0.1211
Middle	EDGE class 8	25.81	0.3811	21.21	0.1321
Highest	(GT - LC = -4.6 dB)	25.93	0.3917	21.33	0.1358
Lowest	WCDMA Band II	18.83	0.0764	14.23	0.0265
Middle	RMC 12.2Kbps	19.05	0.0804	14.45	0.0279
Highest	(GT - LC = -4.6 dB)	19.04	0.0802	14.44	0.0278
Limit	EIRP < 2W	Result		PASS	

Channel	Mode	Conducted		EIRP	
		Power (dBm)	Power (Watts)	EIRP(dBm)	EIRP(W)
Lowest	WCDMA Band IV	19.40	0.0871	19.50	0.0891
Middle	RMC 12.2Kbps	19.38	0.0867	19.48	0.0887
Highest	(GT - LC = 0.1 dB)	19.44	0.0879	19.54	0.0899
Limit	EIRP < 1W	Result		PASS	



Radiated Spurious Emission

GPRS 850

GPRS 850									
Channel	Frequency (MHz)	ERP (dBm)	Limit (dBm)	Over Limit (dB)	SPA Reading (dBm)	S.G. Power (dBm)	TX Cable loss (dB)	TX Antenna Gain (dBi)	Polarization (H/V)
Lowest	1648	-57.87	-13	-44.87	-65.61	-63.60	0.81	8.69	H
	2472	-60.08	-13	-47.08	-73.65	-67.65	1.04	10.76	H
	3296	-58.68	-13	-45.68	-74.29	-67.28	1.10	11.85	H
									H
									H
									H
	1648	-55.93	-13	-42.93	-64.52	-61.66	0.81	8.69	V
	2472	-59.90	-13	-46.90	-73.61	-67.47	1.04	10.76	V
	3296	-58.05	-13	-45.05	-74.03	-66.65	1.10	11.85	V
									V
									V
									V
Middle	1672	-50.46	-13	-37.46	-72.28	-56.28	0.82	8.79	H
	2504	-47.36	-13	-34.36	-73.96	-54.96	1.05	10.80	H
	3344	-45.45	-13	-32.45	-73.83	-54.16	1.10	11.96	H
									H
									H
									H
	1672	-47.98	-13	-34.98	-69.63	-53.80	0.82	8.79	V
	2504	-60.15	-13	-47.15	-73.85	-67.75	1.05	10.80	V
	3344	-58.09	-13	-45.09	-73.96	-66.80	1.10	11.96	V
									V
									V
									V



Highest	1696	-59.49	-13	-46.49	-68.41	-65.39	0.83	8.88	H
	2544	-60.33	-13	-47.33	-74.04	-67.96	1.06	10.84	H
	3392	-58.70	-13	-45.70	-73.82	-67.51	1.10	12.06	H
									H
									H
									H
									H
	1696	-55.76	-13	-42.76	-64.52	-61.66	0.83	8.88	V
	2544	-59.79	-13	-46.79	-73.58	-67.42	1.06	10.84	V
	3392	-57.81	-13	-44.81	-73.58	-66.62	1.10	12.06	V
									V
									V
									V
									V
								V	

Remark: Spurious emissions within 30-1000MHz were found more than 20dB below limit line.



EDGE 850

EDGE 850									
Channel	Frequency (MHz)	ERP (dBm)	Limit (dBm)	Over Limit (dB)	SPA Reading (dBm)	S.G. Power (dBm)	TX Cable loss (dB)	TX Antenna Gain (dBi)	Polarization (H/V)
Lowest	1648	-59.22	-13	-46.22	-67.95	-64.95	0.81	8.69	H
	2472	-55.83	-13	-42.83	-69.41	-63.40	1.04	10.76	H
	3296	-58.43	-13	-45.43	-74.04	-67.03	1.10	11.85	H
									H
									H
									H
									H
	1648	-54.13	-13	-41.13	-62.74	-59.86	0.81	8.69	V
	2472	-53.86	-13	-40.86	-67.59	-61.43	1.04	10.76	V
	3296	-58.05	-13	-45.05	-74.03	-66.65	1.10	11.85	V
									V
									V
									V
									V
Middle	1672	-61.68	-13	-48.68	-70.5	-67.50	0.82	8.79	H
	2512	-56.84	-13	-43.84	-70.47	-64.45	1.05	10.81	H
	3344	-58.49	-13	-45.49	-73.86	-67.20	1.10	11.96	H
									H
									H
									H
									H
	1672	-59.96	-13	-46.96	-68.63	-65.78	0.82	8.79	V
	2512	-52.53	-13	-39.53	-66.24	-60.14	1.05	10.81	V
	3344	-58.92	-13	-45.92	-73.8	-67.63	1.10	11.96	V
									V
									V
									V
									V



Highest	1696	-59.50	-13	-46.50	-68.42	-65.40	0.83	8.88	H
	2544	-56.53	-13	-43.53	-70.24	-64.16	1.06	10.84	H
	3392	-58.69	-13	-45.69	-73.82	-67.50	1.10	12.06	H
									H
									H
									H
									H
	1696	-58.45	-13	-45.45	-66.21	-64.35	0.83	8.88	V
	2544	-55.03	-13	-42.03	-68.81	-62.66	1.06	10.84	V
	3392	-58.22	-13	-45.22	-73.97	-67.03	1.10	12.06	V
									V
									V
									V
									V

Remark: Spurious emissions within 30-1000MHz were found more than 20dB below limit line.



WCDMA850

WCDMA850									
Channel	Frequency (MHz)	ERP (dBm)	Limit (dBm)	Over Limit (dB)	SPA Reading (dBm)	S.G. Power (dBm)	TX Cable loss (dB)	TX Antenna Gain (dBi)	Polarization (H/V)
Lowest	1656	-63.65	-13	-50.65	-72.39	-69.40	0.82	8.72	H
	3304	-59.68	-13	-46.68	-74.26	-68.30	1.10	11.87	H
	4960	-56.20	-13	-43.20	-76.7	-65.33	1.41	12.69	H
									H
									H
									H
									H
	1656	-64.10	-13	-51.10	-72.71	-69.85	0.82	8.72	V
	3304	-59.10	-13	-46.10	-74.07	-67.72	1.10	11.87	V
	4960	-55.39	-13	-42.39	-76.46	-64.52	1.41	12.69	V
									V
									V
									V
									V
Middle	1673	-63.91	-13	-50.91	-72.73	-69.73	0.82	8.79	H
	2509	-60.23	-13	-47.23	-73.86	-67.84	1.05	10.81	H
	3346	-58.47	-13	-45.47	-73.83	-67.18	1.10	11.96	H
									H
									H
									H
									H
	1673	-64.12	-13	-51.12	-72.79	-69.94	0.82	8.79	V
	2509	-59.92	-13	-46.92	-73.64	-67.53	1.05	10.81	V
	3346	-57.86	-13	-44.86	-73.74	-66.57	1.10	11.96	V
									V
									V
									V
									V



Highest	1696	-63.92	-13	-50.92	-72.84	-69.82	0.83	8.88	H
	2544	-59.67	-13	-46.67	-73.37	-67.30	1.06	10.84	H
	3392	-58.47	-13	-45.47	-73.59	-67.28	1.10	12.06	H
									H
									H
									H
									H
	1696	-63.62	-13	-50.62	-72.38	-69.52	0.83	8.88	V
	2544	-60.24	-13	-47.24	-74.03	-67.87	1.06	10.84	V
	3392	-57.97	-13	-44.97	-73.72	-66.78	1.10	12.06	V
									V
									V
									V
									V

Remark: Spurious emissions within 30-1000MHz were found more than 20dB below limit line.



GPRS 1900

GPRS 1900									
Channel	Frequency (MHz)	EIRP (dBm)	Limit (dBm)	Over Limit (dB)	SPA Reading (dBm)	S.G. Power (dBm)	TX Cable loss (dB)	TX Antenna Gain (dBi)	Polarization (H/V)
Lowest	3700	-56.99	-13	-43.99	-74.55	-68.22	1.23	12.46	H
	5551	-53.97	-13	-40.97	-75.58	-65.46	1.80	13.29	H
	7401	-49.34	-13	-36.34	-75.36	-58.15	2.43	11.24	H
									H
									H
									H
									H
	3700	-56.57	-13	-43.57	-74.65	-67.80	1.23	12.46	V
	5551	-53.44	-13	-40.44	-75.84	-64.93	1.80	13.29	V
	7401	-50.11	-13	-37.11	-75.86	-58.92	2.43	11.24	V
									V
									V
									V
									V
Middle	3760	-56.83	-13	-43.83	-74.46	-68.07	1.27	12.51	H
	5640	-53.47	-13	-40.47	-75.22	-64.89	1.85	13.27	H
	7520	-48.50	-13	-35.50	-75.16	-57.12	2.50	11.11	H
									H
									H
									H
									H
	3760	-56.18	-13	-43.18	-74.41	-67.42	1.27	12.51	V
	5640	-53.04	-13	-40.04	-75.45	-64.46	1.85	13.27	V
	7520	-49.16	-13	-36.16	-75.62	-57.78	2.50	11.11	V
									V
									V
									V
									V



Highest	3819	-57.03	-13	-44.03	-74.75	-68.28	1.31	12.56	H
	5729	-53.80	-13	-40.80	-75.72	-65.15	1.90	13.25	H
	7639	-50.11	-13	-37.11	-76.17	-58.70	2.59	11.18	H
									H
									H
									H
									H
	3819	-56.20	-13	-43.20	-74.6	-67.45	1.31	12.56	V
	5729	-53.38	-13	-40.38	-75.96	-64.73	1.90	13.25	V
	7639	-50.04	-13	-37.04	-76.17	-58.63	2.59	11.18	V
									V
									V
									V
									V

Remark: Spurious emissions within 30-1000MHz were found more than 20dB below limit line.



EDGE 1900

EDGE 1900									
Channel	Frequency (MHz)	EIRP (dBm)	Limit (dBm)	Over Limit (dB)	SPA Reading (dBm)	S.G. Power (dBm)	TX Cable loss (dB)	TX Antenna Gain (dBi)	Polarization (H/V)
Lowest	3700	-57.25	-13	-44.25	-74.81	-68.48	1.23	12.46	H
	5551	-53.98	-13	-40.98	-75.59	-65.47	1.80	13.29	H
	7403	-49.75	-13	-36.75	-75.79	-58.55	2.43	11.24	H
									H
									H
									H
									H
	3700	-56.75	-13	-43.75	-74.83	-67.98	1.23	12.46	V
	5551	-53.44	-13	-40.44	-75.84	-64.93	1.80	13.29	V
	7403	-50.10	-13	-37.10	-75.86	-58.90	2.43	11.24	V
									V
									V
									V
									V
Middle	3760	-56.82	-13	-43.82	-74.45	-68.06	1.27	12.51	H
	5640	-53.69	-13	-40.69	-75.44	-65.11	1.85	13.27	H
	7522	-48.89	-13	-35.89	-75.53	-57.51	2.50	11.11	H
									H
									H
									H
									H
	3760	-56.06	-13	-43.06	-74.29	-67.30	1.27	12.51	V
	5640	-53.25	-13	-40.25	-75.66	-64.67	1.85	13.27	V
	7522	-49.00	-13	-36.00	-75.46	-57.62	2.50	11.11	V
									V
									V
									V
									V



Highest	3819	-56.85	-13	-43.85	-74.57	-68.10	1.31	12.56	H
	5729	-54.10	-13	-41.10	-76.02	-65.45	1.90	13.25	H
	7641	-50.01	-13	-37.01	-76.07	-58.60	2.59	11.18	H
									H
									H
									H
									H
	3819	-56.34	-13	-43.34	-74.74	-67.59	1.31	12.56	V
	5729	-52.91	-13	-39.91	-75.49	-64.26	1.90	13.25	V
	7641	-49.52	-13	-36.52	-75.66	-58.11	2.59	11.18	V
									V
									V
									V
									V

Remark: Spurious emissions within 30-1000MHz were found more than 20dB below limit line.



WCDMA 1900

WCDMA 1900									
Channel	Frequency (MHz)	EIRP (dBm)	Limit (dBm)	Over Limit (dB)	SPA Reading (dBm)	S.G. Power (dBm)	TX Cable loss (dB)	TX Antenna Gain (dBi)	Polarization (H/V)
Lowest	3705	-56.98	-13	-43.98	-74.55	-68.21	1.24	12.46	H
	5557	-54.14	-13	-41.14	-75.76	-65.63	1.80	13.29	H
	7410	-50.04	-13	-37.04	-76.14	-58.83	2.44	11.23	H
									H
									H
									H
									H
	3705	-56.43	-13	-43.43	-74.52	-67.66	1.24	12.46	V
	5557	-53.12	-13	-40.12	-75.52	-64.61	1.80	13.29	V
	7410	-50.12	-13	-37.12	-75.95	-58.91	2.44	11.23	V
									V
									V
									V
									V
Middle	3760	-56.66	-13	-43.66	-74.29	-67.90	1.27	12.51	H
	5640	-53.50	-13	-40.50	-75.25	-64.92	1.85	13.27	H
	7520	-48.93	-13	-35.93	-75.59	-57.55	2.50	11.11	H
									H
									H
									H
									H
	3760	-56.02	-13	-43.02	-74.25	-67.26	1.27	12.51	V
	5640	-52.69	-13	-39.69	-75.1	-64.11	1.85	13.27	V
	7520	-48.97	-13	-35.97	-75.45	-57.59	2.50	11.11	V
									V
									V
									V
									V



Highest	3815	-57.22	-13	-44.22	-74.93	-68.46	1.31	12.55	H
	5723	-53.75	-13	-40.75	-75.65	-65.11	1.90	13.26	H
	7630	-50.48	-13	-37.48	-76.53	-59.08	2.58	11.18	H
									H
									H
									H
									H
	3715	-56.47	-13	-43.47	-74.86	-67.70	1.24	12.47	V
	5723	-52.86	-13	-39.86	-75.42	-64.22	1.90	13.26	V
	7630	-50.57	-13	-37.57	-76.69	-59.17	2.58	11.18	V
									V
									V
									V
									V

Remark: Spurious emissions within 30-1000MHz were found more than 20dB below limit line.



WCDMA 1700

WCDMA 1700									
Channel	Frequency (MHz)	EIRP (dBm)	Limit (dBm)	Over Limit (dB)	SPA Reading (dBm)	S.G. Power (dBm)	TX Cable loss (dB)	TX Antenna Gain (dBi)	Polarization (H/V)
Lowest	3425	-58.03	-13	-45.03	-74.1	-69.06	1.10	12.14	H
	5137	-55.25	-13	-42.25	-76.16	-66.59	1.52	12.86	H
	6850	-51.32	-13	-38.32	-75.59	-61.09	2.18	11.95	H
									H
									H
									H
									H
	3425	-57.71	-13	-44.71	-74.33	-68.74	1.10	12.14	V
	5137	-54.78	-13	-41.78	-76.33	-66.12	1.52	12.86	V
	6850	-51.30	-13	-38.30	-75.79	-61.07	2.18	11.95	V
									V
									V
									V
									V
Middle	3465	-57.28	-13	-44.28	-74.01	-68.40	1.10	12.22	H
	5198	-55.30	-13	-42.30	-76.32	-66.67	1.56	12.94	H
	6930	-51.84	-13	-38.84	-76.14	-61.50	2.21	11.87	H
									H
									H
									H
									H
	3465	-57.12	-13	-44.12	-74.19	-68.24	1.10	12.22	V
	5198	-54.63	-13	-41.63	-76.35	-66.00	1.56	12.94	V
	6930	-51.20	-13	-38.20	-76.01	-60.86	2.21	11.87	V
									V
									V
									V
									V



Highest	3505	-56.87	-13	-43.87	-74.17	-68.07	1.10	12.30	H
	5258	-54.78	-13	-41.78	-75.9	-66.18	1.61	13.01	H
	7010	-51.29	-13	-38.29	-75.68	-60.83	2.24	11.79	H
									H
									H
									H
									H
	3505	-56.27	-13	-43.27	-73.75	-67.47	1.10	12.30	V
	5258	-54.11	-13	-41.11	-75.94	-65.51	1.61	13.01	V
	7010	-50.25	-13	-37.25	-75.4	-59.79	2.24	11.79	V
									V
									V
									V
									V

Remark: Spurious emissions within 30-1000MHz were found more than 20dB below limit line.

————THE END————