



# **SETUP PHOTO EXHIBIT**

**Report Number:** R14176161-EP2

**Applicant :** Sony Corporation  
1-7-1 Konan Minato-ku  
Tokyo, 108-0076, Japan

**FCC ID :** PY7-24116L

**EUT Description :** GSM/WCDMA/LTE Phone with BT, DTS/UNII a/b/g/n/ac/ax, GPS,  
WPT & NFC

**Test Standard(s) :** FCC 47 CFR Part 2, Part 22, Part 24, and Part 27

**Date Of Issue:**  
2022-03-30

**Prepared by:**  
UL LLC  
12 Laboratory Dr.  
Research Triangle Park, NC 27709 U.S.A.  
TEL: (919) 549-1400



---

## REPORT REVISION HISTORY

Rev.	Issue Date	Revisions	Revised By
v1	2022-03-30	Initial Issue	Noah Bennett

---

## TABLE OF CONTENTS

REPORT REVISION HISTORY .....	2
TABLE OF CONTENTS .....	3
1. SETUP DIAGRAMS .....	4
2. SETUP PHOTOS.....	5
END OF TEST REPORT .....	12

# 1. SETUP DIAGRAMS

Conducted:

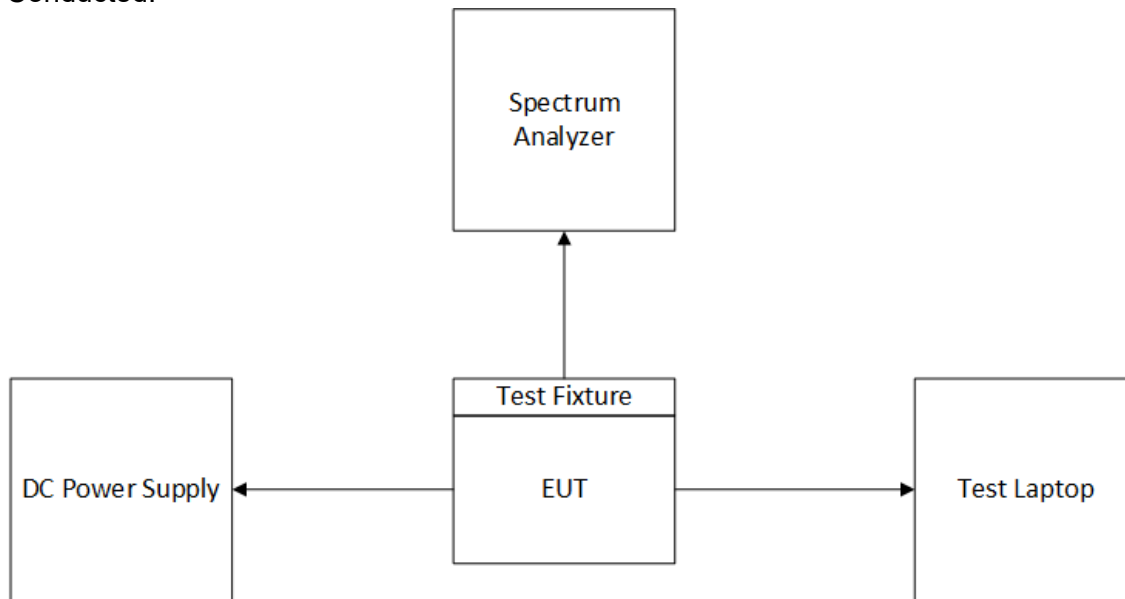

Radiated:

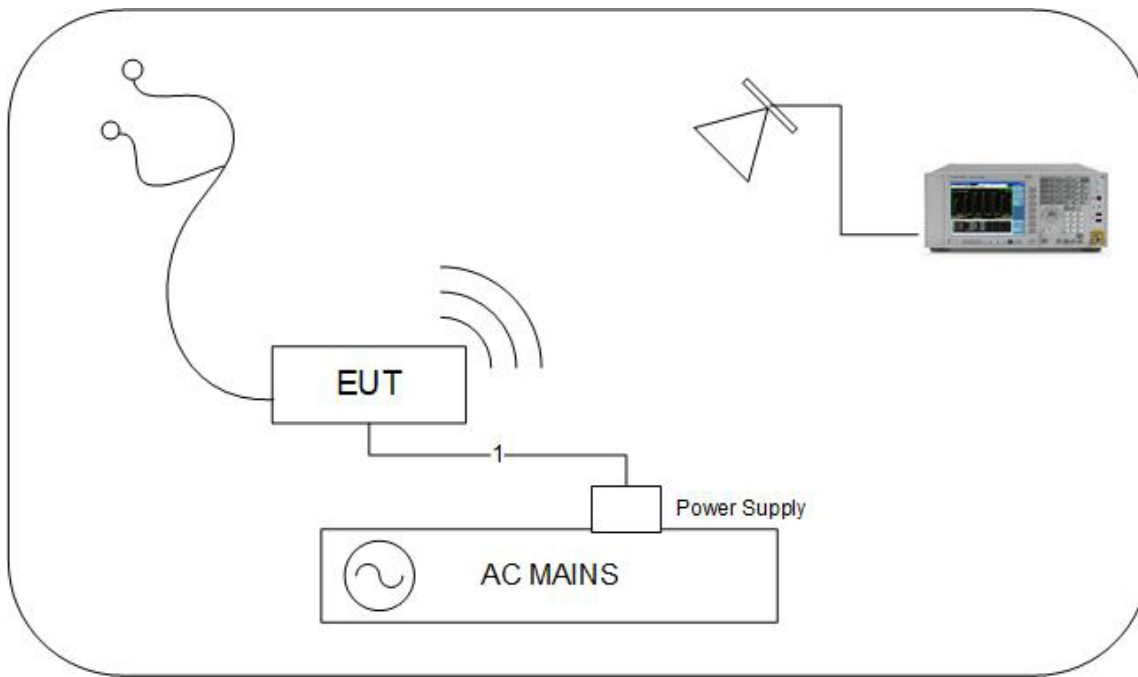

## 2. SETUP PHOTOS

### CONDUCTED MEASUREMENT SETUP

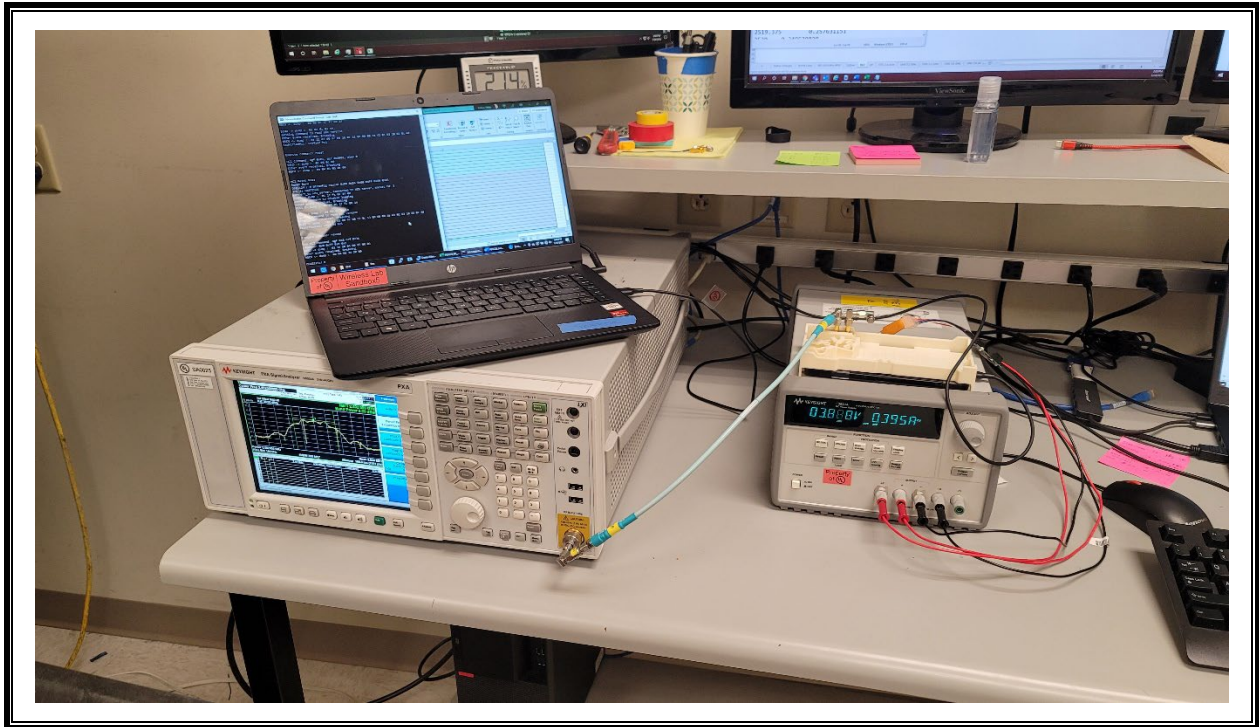

**RADIATED RF MEASUREMENT SETUP**

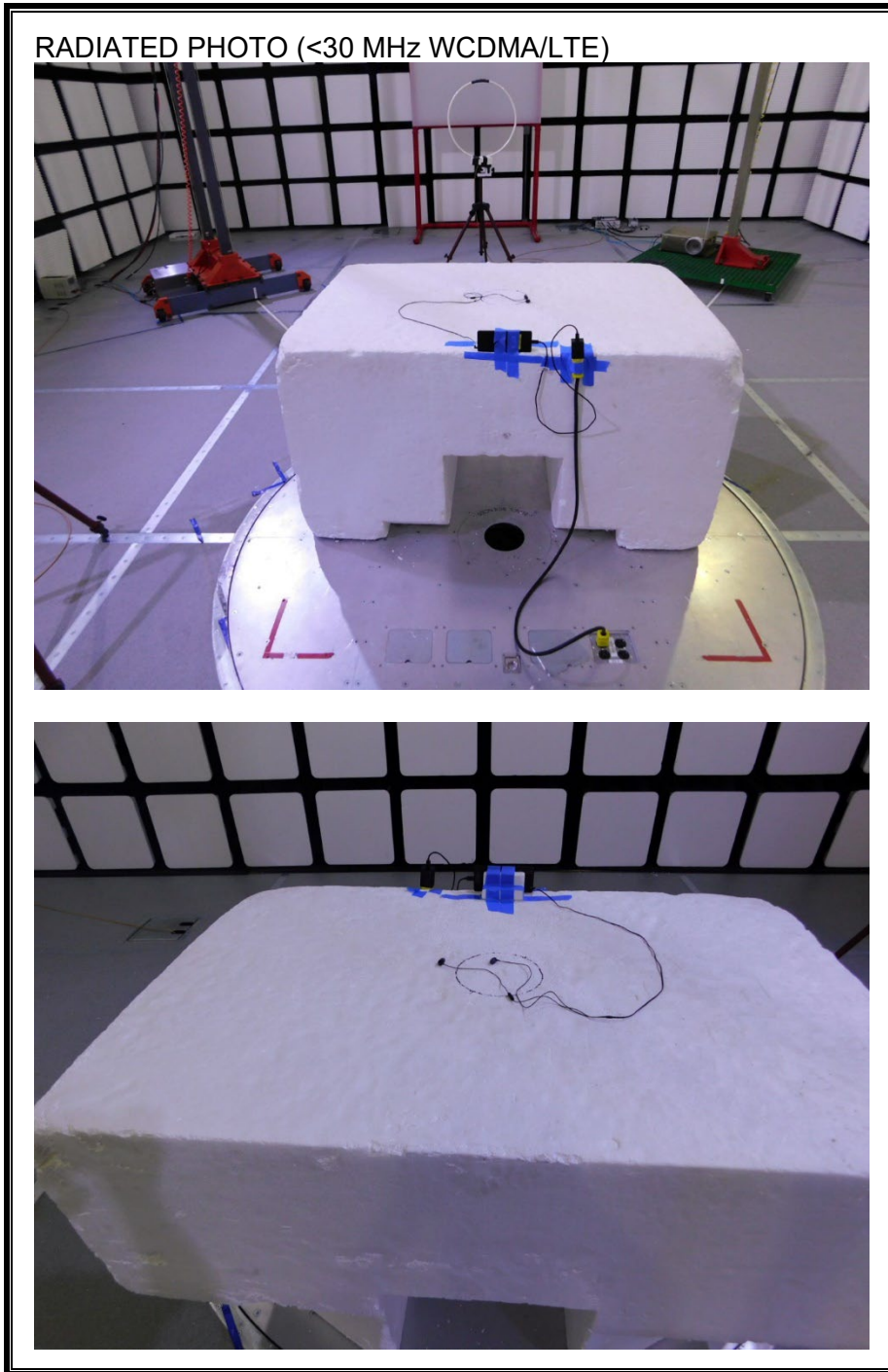

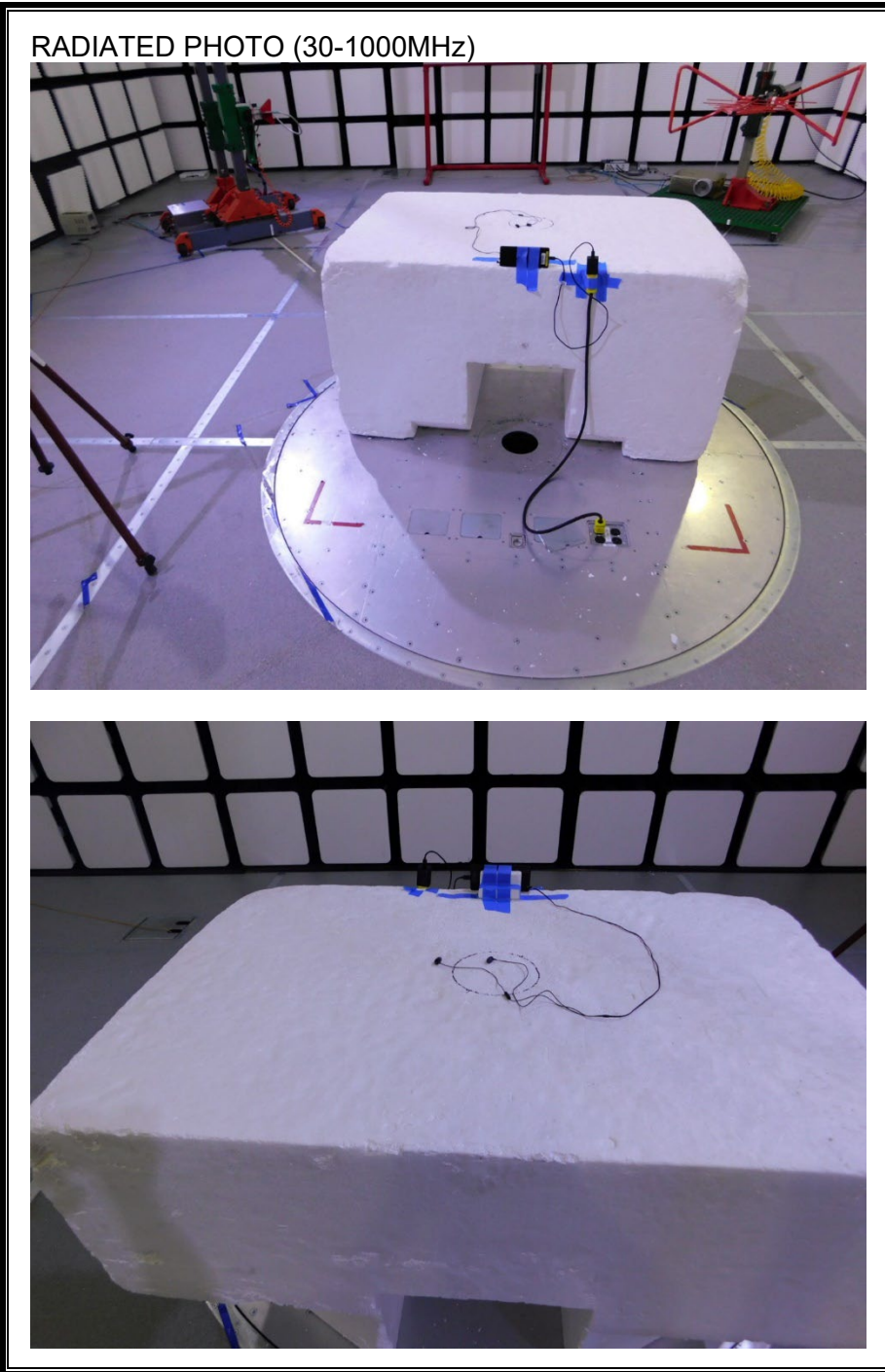



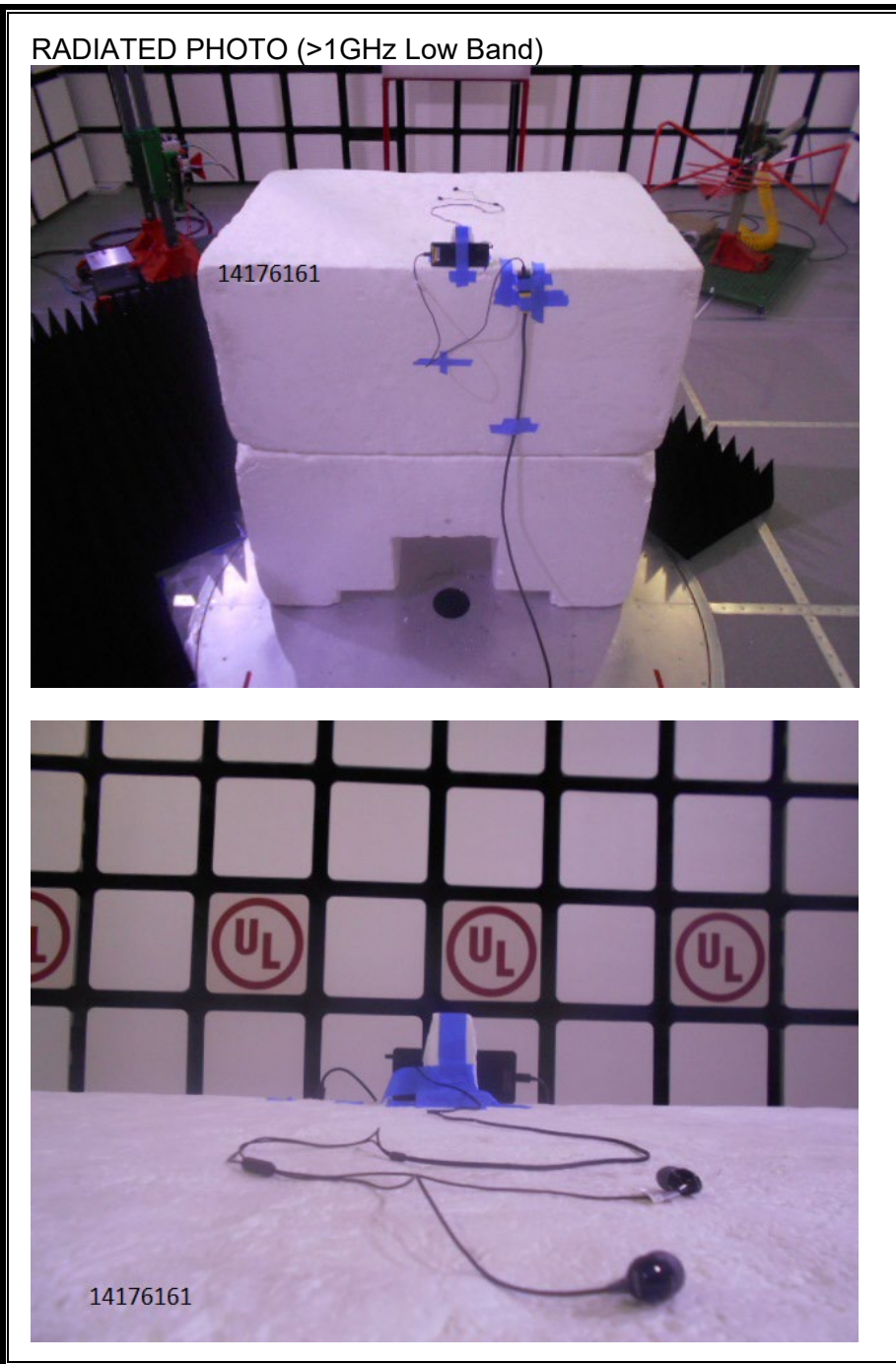



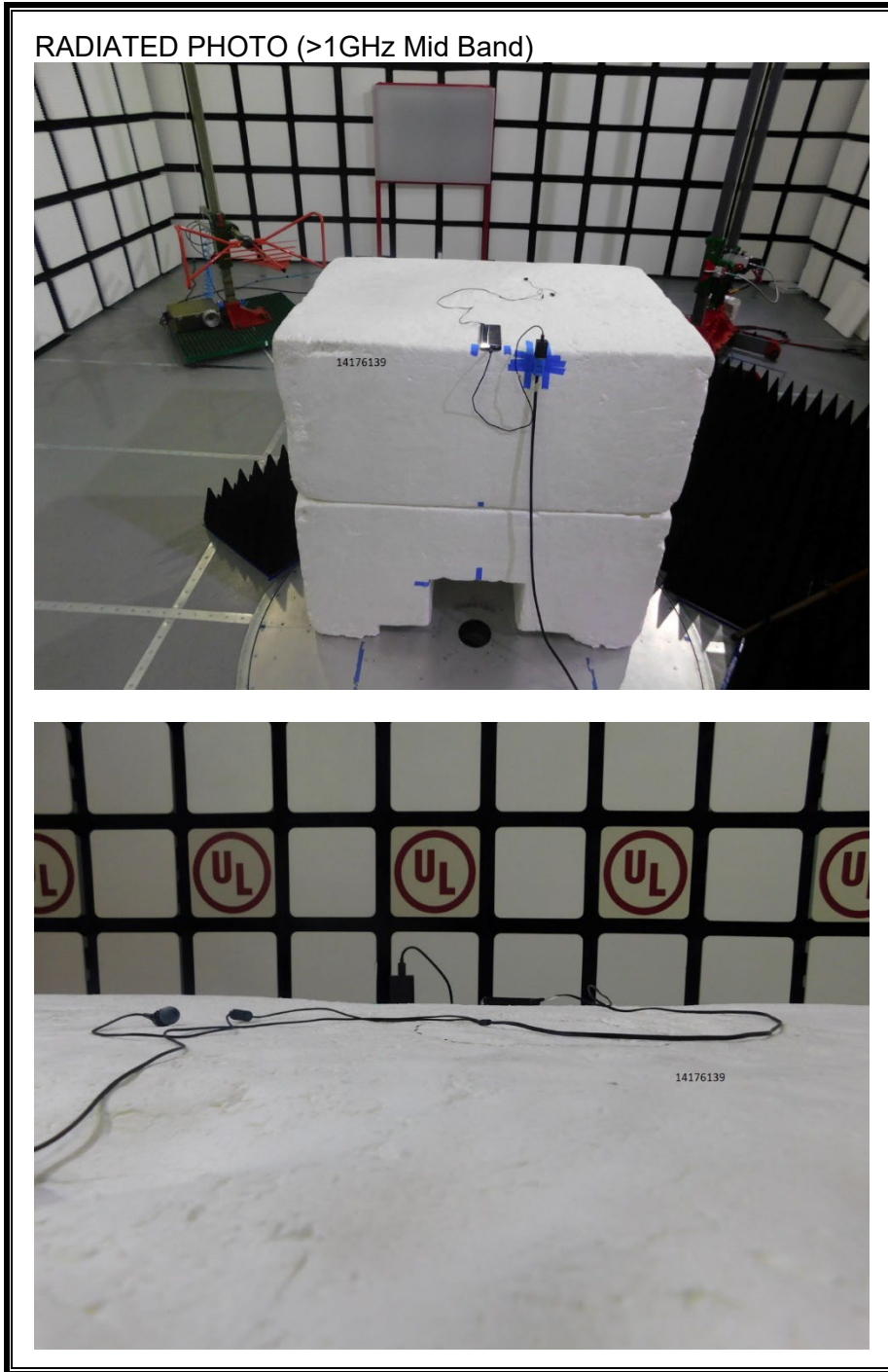

**XYZ SETUP PHOTOS**

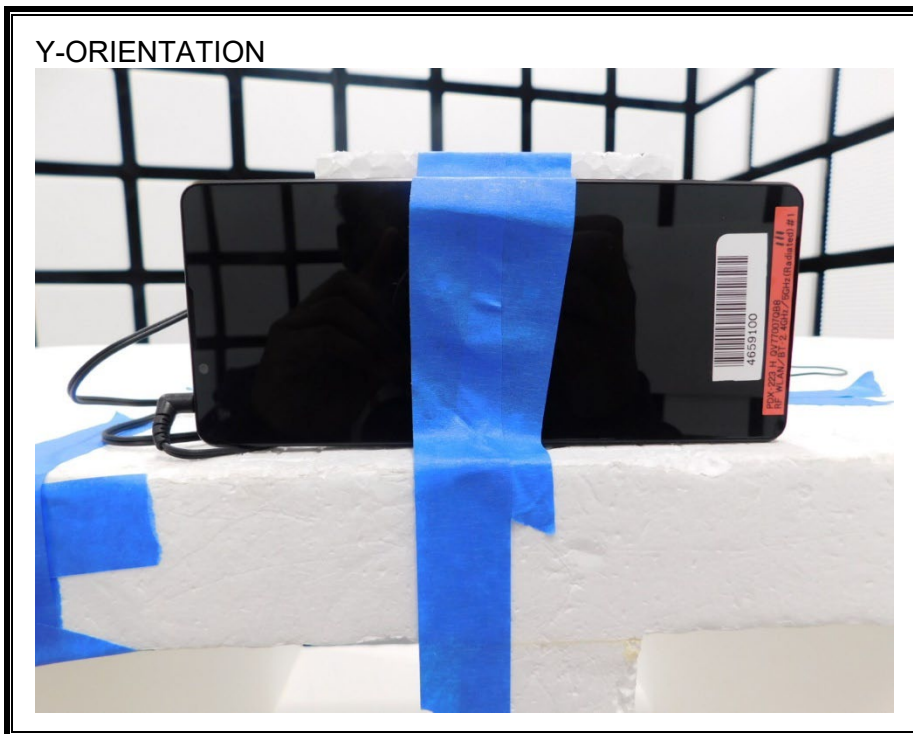
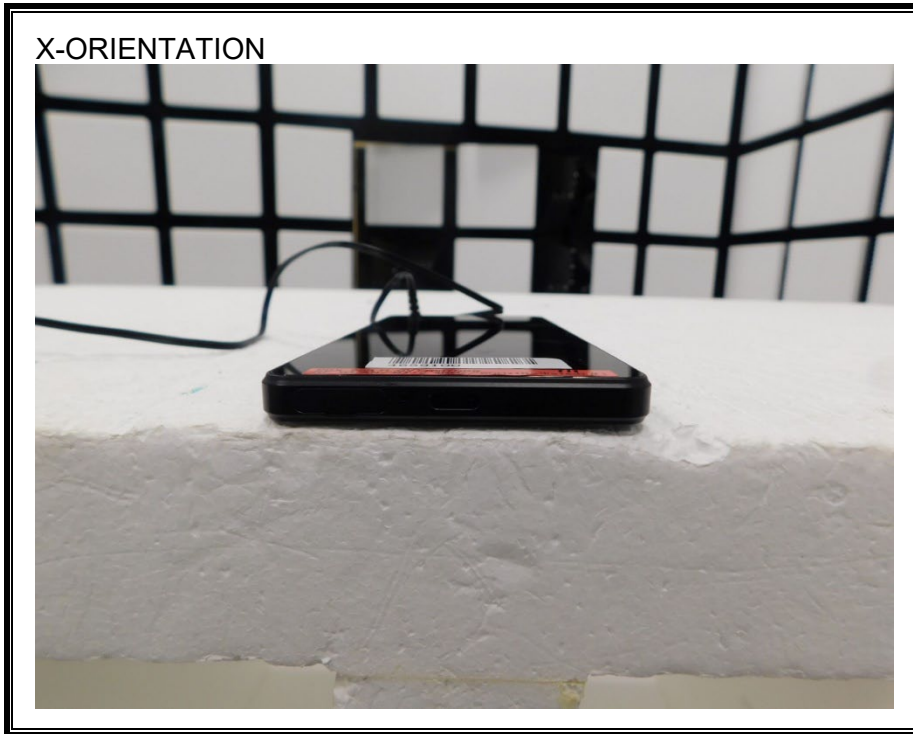

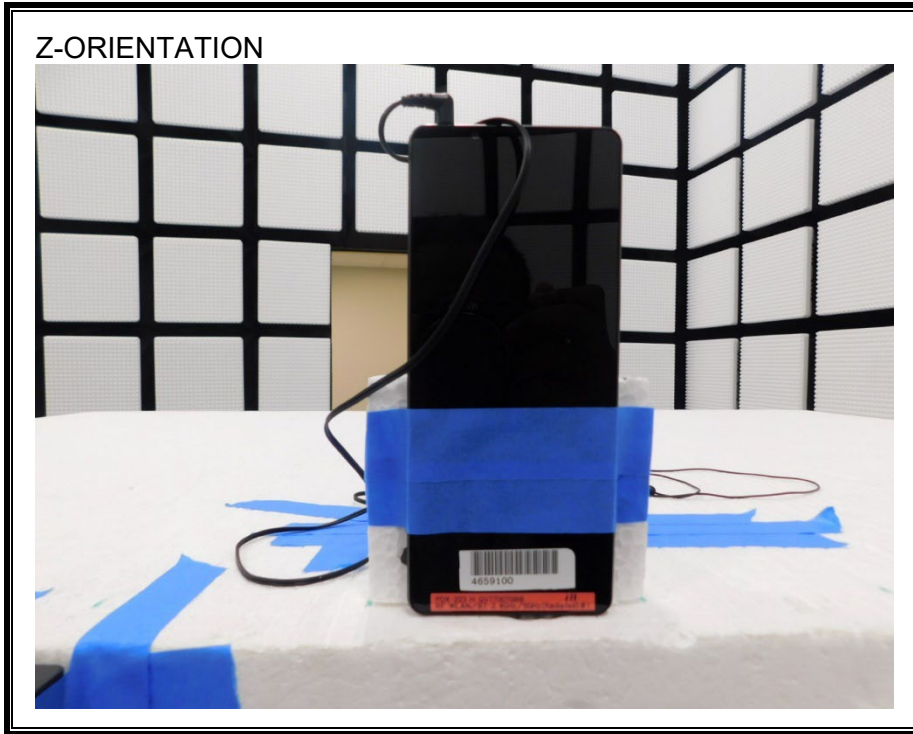

**AC MAINS LINE CONDUCTED MEASUREMENT SETUP**

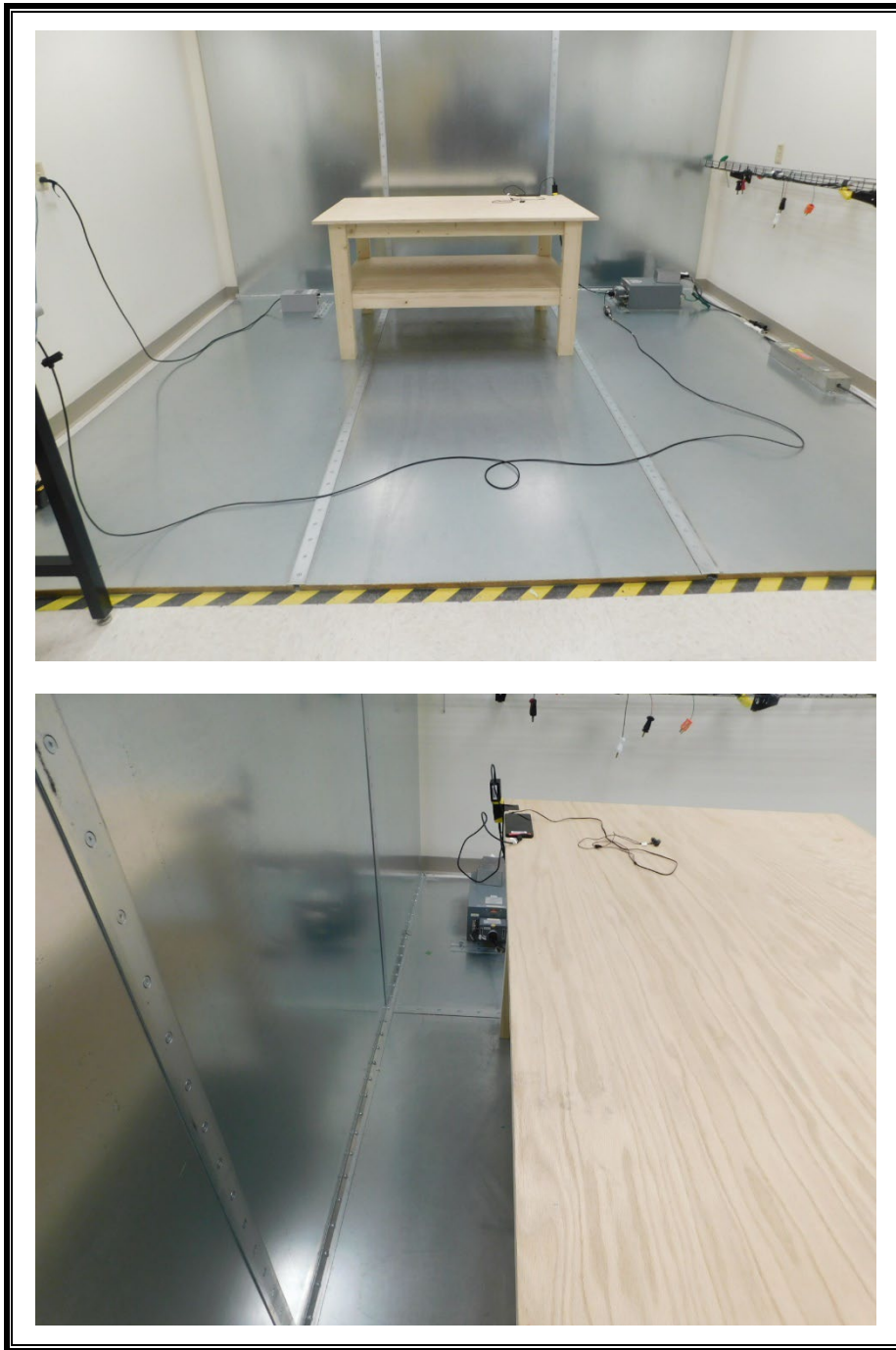

**END OF TEST REPORT**