



FCC RF Test Report

APPLICANT : SONY MOBILE COMMUNICATIONS INC.
EQUIPMENT : GSM/WCDMA/LTE PHONE + BLUETOOTH, DTS/UNII
a/b/g/n/ac & NFC.
BRAND NAME : Sony
FCC ID : PY7-22041R
STANDARD : FCC Part 15 Subpart C §15.225
CLASSIFICATION : (DXX) Low Power Communication Device Transmitter

The testing was completed on Sep. 02, 2016. We, SPORTON INTERNATIONAL INC., would like to declare that the tested sample has been evaluated in accordance with the test procedures and has been in compliance with the applicable technical standards.

The test results in this report apply exclusively to the tested model / sample. Without written approval of SPORTON INTERNATIONAL INC., the test report shall not be reproduced except in full.

Reviewed by: Joseph Lin / Supervisor

Approved by: Jones Tsai / Manager



SPORTON INTERNATIONAL INC.

No. 52, Hwa Ya 1st Rd., Hwa Ya Technology Park, Kwei-Shan District, Tao Yuan City, Taiwan, R.O.C.



TABLE OF CONTENTS

SUMMARY OF THE TEST RESULT4

1. GENERAL INFORMATION.....5

1.1 Applicant..... 5

1.2 Manufacturer 5

1.3 Product Details 5

1.4 Modification of EUT 5

1.5 Testing Location 6

1.6 Applicable Standards..... 6

2. TEST CONFIGURATION OF EQUIPMENT UNDER TEST7

2.1 Descriptions of Test Mode 7

2.2 Connection Diagram of Test System 7

2.3 Table for Supporting Units 8

2.4 EUT Operation Test Setup 8

3. TEST RESULTS.....9

3.1 AC Power Line Conducted Emissions Measurement 9

3.2 20dB and 99% OBW Spectrum Bandwidth Measurement..... 11

3.3 Frequency Stability Measurement 12

3.4 Field Strength of Fundamental Emissions and Mask Measurement..... 13

3.5 Radiated Emissions Measurement 15

3.6 Antenna Requirements..... 18

4. LIST OF MEASURING EQUIPMENT19

APPENDIX A. TEST RESULTS OF CONDUCTED EMISSION TEST

APPENDIX B. TEST RESULTS OF CONDUCTED TEST ITEMS

B1. Test Result of 20dB Spectrum Bandwidth

B2. Test Result of Frequency Stability

APPENDIX C. TEST RESULTS OF RADIATED TEST ITEMS

C1. Test Result of Field Strength of Fundamental Emissions

C2. Results of Radiated Emissions (9 kHz~30MHz)

C3. Results of Radiated Emissions (30MHz~1GHz)

APPENDIX D. VERIFICATION OF RADIATED SPURIOUS EMISSIONS AT OPEN-AREA TEST SITE

D1. Results of Radiated Emissions (9 kHz~30MHz)

D2. List of Measuring Equipment



REVISION HISTORY

REPORT NO.	VERSION	DESCRIPTION	ISSUED DATE
FR690118	Rev. 01	Initial issue of report	Sep. 05, 2016



SUMMARY OF THE TEST RESULT

Applied Standard: 47 CFR FCC Part 15 Subpart C				
Part	FCC Rule	Description of Test	Result	Under Limit
3.1	15.207	AC Power Line Conducted Emissions	Complies	8.2 dB at 0.686MHz
3.2	15.215(c)	20dB Spectrum Bandwidth	Complies	-
	-	99% OBW Spectrum Bandwidth	Complies	-
3.3	15.225(e)	Frequency Stability	Complies	-
3.4	15.225(a)(b)(c)	Field Strength of Fundamental Emissions	Complies	62.70 dB at 13.560 MHz
3.5	15.225(d) 15.209	Radiated Emissions	Complies	2.08 dB at 40.800 MHz for Quasi-Peak
3.6	15.203	Antenna Requirements	Complies	-

Test Items	Uncertainty	Remark
AC Power Line Conducted Emissions	±2.70dB	Confidence levels of 95%
Radiated Emissions (30MHz~1000MHz)	±5.70dB	Confidence levels of 95%



1. GENERAL INFORMATION

1.1 Applicant

SONY MOBILE COMMUNICATIONS INC.

4-12-3 HIGASHI-SHINAGAWA, SHINAGAWA -KU,TOKYO, 140-0002, JAPAN

1.2 Manufacturer

SONY MOBILE COMMUNICATIONS INC.

4-12-3 HIGASHI-SHINAGAWA, SHINAGAWA -KU,TOKYO, 140-0002, JAPAN

1.3 Product Details

Items	Description
Number of Channels	1
20dB Bandwidth	2.64kHz
99% Occupied Bandwidth	2.24kHz

EUT Information List			
HW Version	SW Version	S/N	Performed Test Item
A	0.169	CB512B87M5	RF Conducted Measurement
		CB512B87MH	Radiated Emission
		CB512B87TD	AC Conducted Emission

Note: Above EUT list and accessory list used are electrically identical per declared by manufacturer.

Accessory List	
AC Adapter	Model No. : 1300-7146.1B
	S/N : 5816W09300124
Earphone	Model No. : MH410x
	S/N : 1625A87A0000216
USB Cable	Model No. : 1302-1935.1B
	S/N : 1615A989000D86C

Note: Above the accessories list are used to exercise the EUT during test.

1.4 Modification of EUT

No modifications are made to the EUT during all test items.

1.5 Testing Location

Sporton Lab is accredited to ISO 17025 by Taiwan Accreditation Foundation (TAF code : 1190) and the FCC designation No. TW1022 under the FCC 2.948(e) by Mutual Recognition Agreement (MRA) in FCC Test.

Test Site	SPORTON INTERNATIONAL INC.		
Test Site Location	No. 52, Hwa Ya 1 st Rd., Hwa Ya Technology Park, Kwei-Shan District, Tao Yuan City, Taiwan, R.O.C. TEL: +886-3-3273456 / FAX: +886-3-3284978		
Test Site No.	Sporton Site No.		
	TH03-HY	CO05-HY	03CH11-HY
Test Engineer	William Liao	Arthur Hsieh	JC
Temperature	22~24°C	22~23°C	20~23°C
Relative Humidity	53~55%	50~52%	50~53%

Note: The test site complies with ANSI C63.4 2014 requirement.

Test Site	SPORTON INTERNATIONAL INC.		
Test Site Location	No. 30-2, Dingfu Tsuen, Linkou District, New Taipei City, Taiwan 244, R.O.C. TEL: +886-2-2603-5367 / +886-2-2601-1640 FAX: +886-2-2601-1695		
Test Site No.	Sporton Site No.		
	OS03-LK		
Test Engineer	Eric Shih		
Temperature	22~24°C		
Relative Humidity	54~56%		

Note: The test site complies with ANSI C63.4 2014 requirement.

1.6 Applicable Standards

According to the specifications of the manufacturer, the EUT must comply with the requirements of the following standards:

- ♦ FCC Part 15 Subpart C §15.225
- ♦ ANSI C63.10-2013

2. TEST CONFIGURATION OF EQUIPMENT UNDER TEST

2.1 Descriptions of Test Mode

Investigation has been done on all the possible configurations.

The following table is a list of the test modes shown in this test report.

Test Items	
AC Power Line Conducted Emissions	Field Strength of Fundamental Emissions
20dB Spectrum Bandwidth	Frequency Stability
Radiated Emissions 9kHz~30MHz	Radiated Emissions 30MHz~1GHz

The worst type (type A) declared by manufacturer was used and recorded in this report.

2.2 Connection Diagram of Test System

<AC Conducted Emissions>

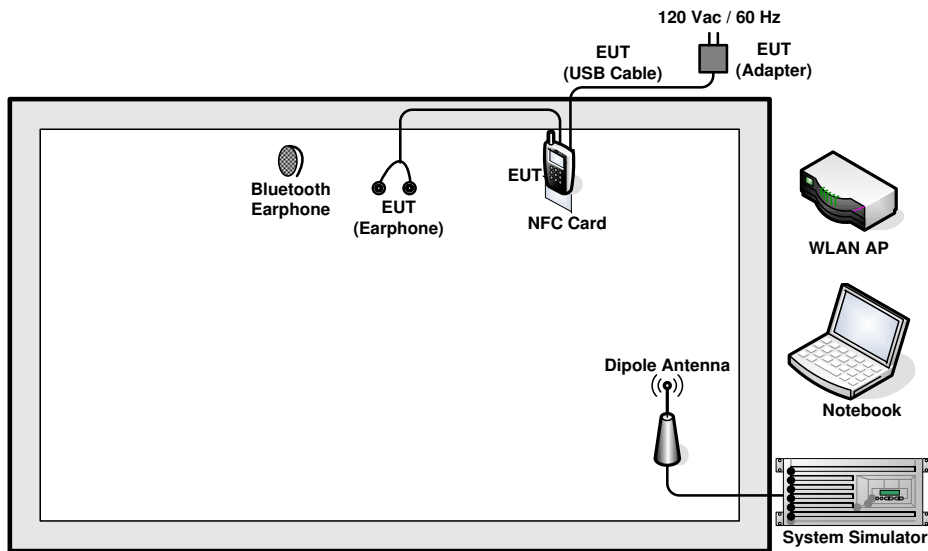

< For Fundamental Emissions and Mask and Radiated Emissions Measurement >

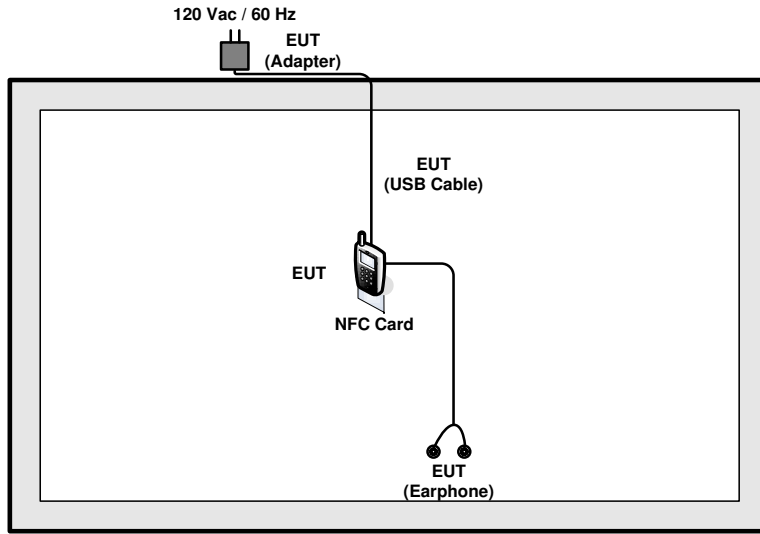

2.3 Table for Supporting Units

Support Unit	Manufacturer	Model	FCC ID
System Simulator	Anritsu	MT8820C	N/A
Bluetooth Earphone	Sony Ericsson	SBH20	PY7-RD0010
WLAN AP	D-Link	DIR-865L	KA2IR865LA1
Notebook	DELL	Latitude E6320	FCC DoC
SD Card	SanDisk	MicroSD HC	FCC DoC
NFC Card	Sony	N/A	N/A

2.4 EUT Operation Test Setup

The EUT was programmed to be in continuously transmitting mode.

3. TEST RESULTS

3.1 AC Power Line Conducted Emissions Measurement

3.1.1 Limit of AC Conducted Emission

For equipment that is designed to be connected to the public utility (AC) power line, the radio frequency voltage that is conducted back onto the AC power line on any frequency or frequencies within the band 150 kHz to 30 MHz shall not exceed the limits in the following table.

Frequency of Emission (MHz)	Conducted Limit (dB μ V)	
	Quasi-Peak	Average
0.15-0.5	66 to 56*	56 to 46*
0.5-5	56	46
5-30	60	50

*Decreases with the logarithm of the frequency.

3.1.2 Measuring Instruments

See list of measuring instruments of this test report.

3.1.3 Test Procedures

1. The EUT was placed 0.4 meter from the conducting wall of the shielding room, and it was kept at least 80 centimeters from any other grounded conducting surface.
2. Connect EUT to the power mains through a line impedance stabilization network (LISN).
3. All the support units are connecting to the other LISN.
4. The LISN provides 50 ohm coupling impedance for the measuring instrument.
5. The FCC states that a 50 ohm, 50 microhenry LISN should be used.
6. Both sides of AC line were checked for maximum conducted interference.
7. The frequency range from 150 kHz to 30 MHz was searched.
8. Set the test-receiver system to Peak Detect Function and specified bandwidth (IF Bandwidth = 9kHz) with Maximum Hold Mode. Then measurement is also conducted by Average Detector and Quasi-Peak Detector Function respectively.

3.1.4 Test setup

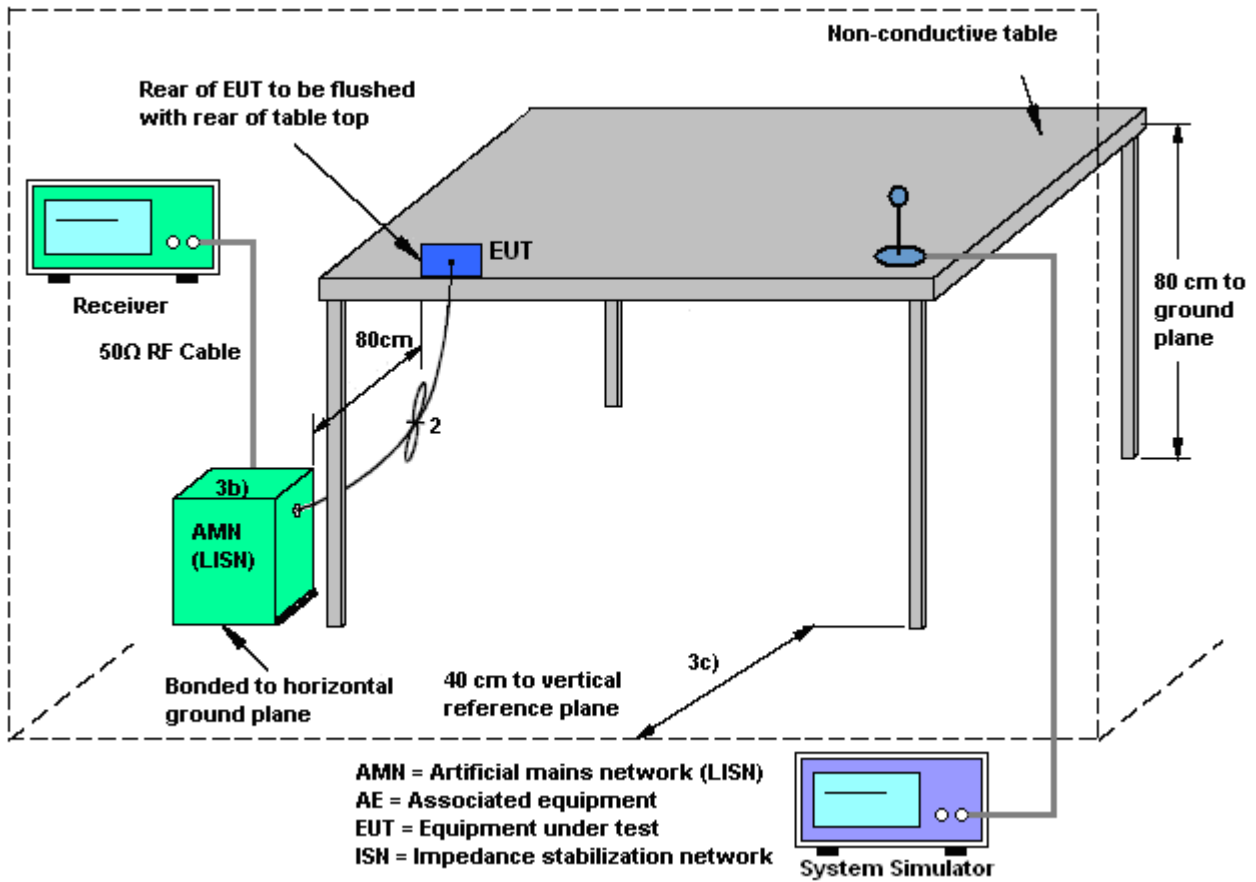

3.1.5 Test Result of AC Conducted Emission

Please refer to Appendix A.

3.2 20dB and 99% OBW Spectrum Bandwidth Measurement

3.2.1 Limit

Intentional radiators must be designed to ensure that the 20dB and 99% emission bandwidth in the specific band 13.553~13.567MHz.

3.2.2 Measuring Instruments

See list of measuring instruments of this test report.

3.2.3 Test Procedures

1. The spectrum analyzer connected via a receive antenna placed near the EUT in peak Max hold mode.
2. The resolution bandwidth of 1 kHz and the video bandwidth of 3 kHz were used.
3. Measured the spectrum width with power higher than 20dB below carrier.
4. Measured the 99% OBW.

3.2.4 Test Setup

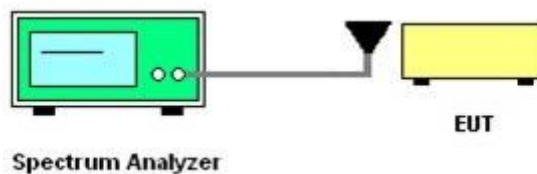

3.2.5 Test Result of Conducted Test Items

Please refer to Appendix B.

3.3 Frequency Stability Measurement

3.3.1 Limit

The frequency tolerance of the carrier signal shall be maintained within +/- 0.01% (100ppm) of the operating frequency over a temperature variation of -20 degrees to +50 degrees C at normal supply voltage, and for a variation in the primary supply voltage from 85% to 115% of the rated supply voltage at a temperature of 20 degrees C. For battery operated equipment, the equipment tests shall be performed using a new battery.

3.3.2 Measuring Instruments

See list of measuring instruments of this test report.

3.3.3 Test Procedures

1. The spectrum analyzer connected via a receive antenna placed near the EUT.
2. EUT have transmitted signal and fixed channelize.
3. Set the spectrum analyzer span to view the entire emissions bandwidth.
4. Set RBW = 1 kHz, VBW = 3 kHz with peak detector and maxhold settings.
5. The f_c is declaring of channel frequency. Then the frequency error formula is $(f_c - f) / f_c \times 10^6$ ppm and the limit is less than ± 100 ppm.
6. Extreme temperature rule is -20°C~50°C.

3.3.4 Test Setup

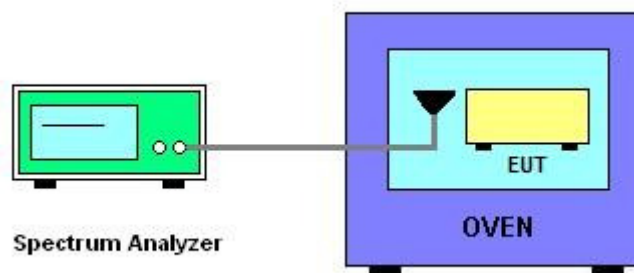

3.3.5 Test Result of Conducted Test Items

Please refer to Appendix B.



3.4 Field Strength of Fundamental Emissions and Mask Measurement

3.4.1 Limit

Rules and specifications	FCC CFR 47 Part 15 section 15.225			
Description	Compliance with the spectrum mask is tested with RBW set to 9kHz.			
Freq. of Emission (MHz)	Field Strength (μV/m) at 30m	Field Strength (dBμV/m) at 30m	Field Strength (dBμV/m) at 10m	Field Strength (dBμV/m) at 3m
1.705~13.110	30	29.5	48.58	69.5
13.110~13.410	106	40.5	59.58	80.5
13.410~13.553	334	50.5	69.58	90.5
13.553~13.567	15848	84.0	103.08	124.0
13.567~13.710	334	50.5	69.58	90.5
13.710~14.010	106	40.5	59.58	80.5
14.010~30.000	30	29.5	48.58	69.5

3.4.2 Measuring Instruments

See list of measuring instruments of this test report.

3.4.3 Test Procedures

1. Configure the EUT according to ANSI C63.10. The EUT was placed on the top of the turntable 0.8 meter above ground. The phase center of the loop receiving antenna mounted antenna tower was placed 3 meters far away from the turntable.
2. Power on the EUT and all the supporting units. The turntable was rotated by 360 degrees to determine the position of the highest radiation.
3. The height of the receiving antenna was fixed at one meter above ground to find the maximum emissions field strength.
4. For Fundamental emissions, use the receiver to measure QP reading.

5. When the radiated emissions limits are expressed in terms of the average value of the emissions, and pulsed operation is employed, the measurement field strength shall be determined by averaging over one complete pulse train, including blanking intervals, as long as the pulse train does not exceed 0.1 seconds. As an alternative (provided the transmitter operates for longer than 0.1 seconds) or in cases where the pulse train exceeds 0.1 seconds, the measured field strength shall be determined from the average absolute voltage during a 0.1 second interval during which the field strength is at its maximum value.
6. Compliance with the spectrum mask is tested with RBW set to 9kHz.
Note: Emission level (dB μ V/m) = 20 log Emission level (μ V/m).
7. OATs and chamber correlation testing had been performed and chamber measured result is the worst case test result.

3.4.4 Test Setup

For radiated emissions below 30MHz

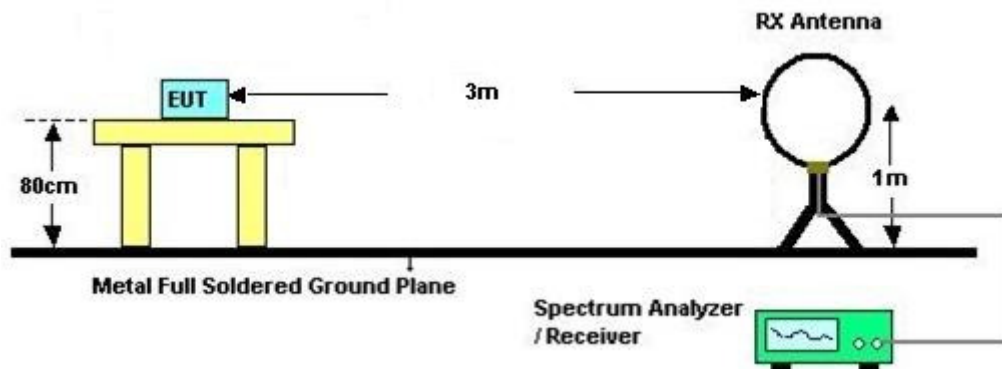

3.4.5 Test Result of Field Strength of Fundamental Emissions and Mask

Please refer to Appendix C.



3.5 Radiated Emissions Measurement

3.5.1 Limit

The field strength of any emissions which appear outside of 13.110 ~14.010MHz band shall not exceed the general radiated emissions limits.

Frequencies (MHz)	Field Strength (µV/m)	Measurement Distance (meters)
0.009~0.490	2400/F(kHz)	300
0.490~1.705	24000/F(kHz)	30
1.705~30.0	30	30
30~88	100	3
88~216	150	3
216~960	200	3
Above 960	500	3

3.5.2 Measuring Instruments

See list of measuring instruments of this test report.

3.5.3 Measuring Instrument Setting

The following table is the setting of receiver.

Receiver Parameter	Setting
Attenuation	Auto
Frequency Range: 9kHz~150kHz	RBW 200Hz for QP
Frequency Range: 150kHz~30MHz	RBW 9kHz for QP
Frequency Range: 30MHz~1000MHz	RBW 120kHz for Peak

Note: The emission limits shown in the above table are based on measurements employing a CISPR quasi-peak detector except for the frequency bands 9-90 kHz, 110-490 kHz. Radiated emission limits in these two bands are based on measurements employing an average detector.



3.5.4 Test Procedures

1. Configure the EUT according to ANSI C63.10. The EUT was placed on the top of the turntable 0.8 meter above ground. The phase center of the receiving antenna mounted on the top of a height-variable antenna tower was placed 3 meters far away from the turntable.
2. Power on the EUT and all the supporting units. The turntable was rotated by 360 degrees to determine the position of the highest radiation.
3. The height of the broadband receiving antenna was varied between one meter and four meters above ground to find the maximum emissions field strength of both horizontal and vertical polarization.
4. For each suspected emissions, the antenna tower was scan (from 1 M to 4 M) and then the turntable was rotated (from 0 degree to 360 degrees) to find the maximum reading.
5. Set the test-receiver system to Peak or CISPR quasi-peak Detect Function with specified bandwidth under Maximum Hold Mode.
6. When the radiated emissions limits are expressed in terms of the average value of the emissions, and pulsed operation is employed, the measurement field strength shall be determined by averaging over one complete pulse train, including blanking intervals, as long as the pulse train does not exceed 0.1 seconds. As an alternative (provided the transmitter operates for longer than 0.1 seconds) or in cases where the pulse train exceeds 0.1 seconds, the measured field strength shall be determined from the average absolute voltage during a 0.1 second interval during which the field strength is at its maximum value.
7. In case the emission is lower than 30MHz, loop antenna has to be used for measurement and the recorded data should be QP measured by receiver.

3.5.5 Test Setup

For radiated emissions below 30MHz

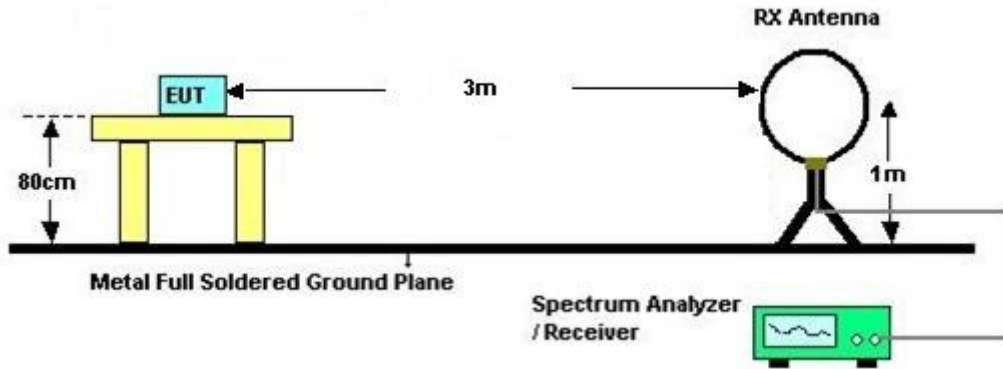

For radiated emissions above 30MHz

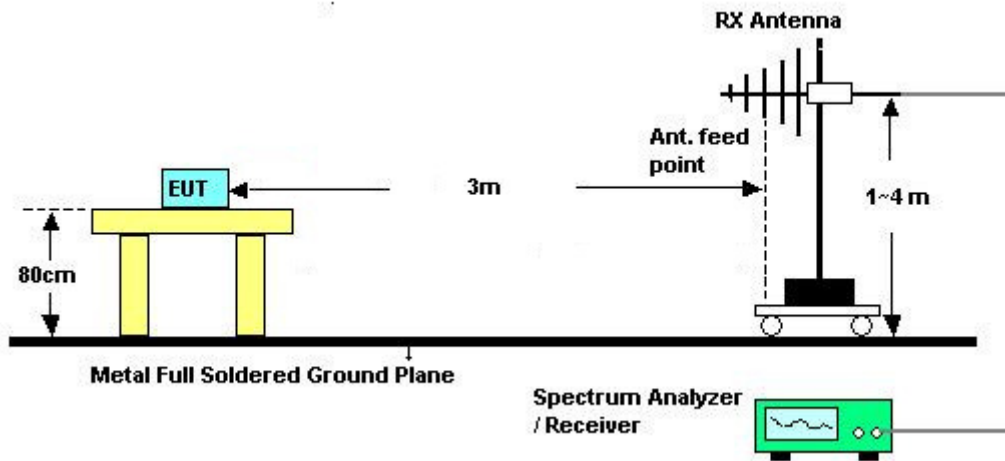

3.5.6 Test Result of Radiated Emissions Measurement

Please refer to Appendix C.



3.6 Antenna Requirements

3.6.1 Standard Applicable

Except for special regulations, the Low-power Radio-frequency Devices must not be equipped with any jacket for installing an antenna with extension cable. An intentional radiator shall be designed to ensure that no antenna other than that furnished by the responsible party shall be used with the device. The use of a permanently attached antenna or of an antenna that uses a unique coupling to the intentional radiator shall be considered sufficient to comply with the provisions of this Section. The manufacturer may design the unit so that the user can replace a broken antenna, but the use of a standard antenna jack or electrical connector is prohibited.

The use of a permanently attached antenna or of an antenna that uses a unique coupling to the intentional radiator shall be considered sufficient to comply with the FCC rule.

3.6.2 Antenna Anti-Replacement Construction

An embedded-in antenna design is used.



4. LIST OF MEASURING EQUIPMENT

Instrument	Manufacturer	Model No.	Serial No.	Characteristics	Calibration Date	Test Date	Due Date	Remark
Hygrometer	Testo	608-H1	34893241	N/A	May 03, 2016	Sep. 02, 2016	May 02, 2017	Conducted (TH03-HY)
Spectrum Analyzer	Rohde & Schwarz	FSP30	101329	9kHz~30GHz	Jun. 27, 2016	Sep. 02, 2016	Jun. 26, 2017	Conducted (TH03-HY)
Temperature Chamber	ESPEC	SU-641	92013721	-30°C ~70°C	Nov. 20, 2015	Sep. 02, 2016	Nov. 19, 2016	Conducted (TH03-HY)
AC Power Source	ChainTek	APC-1000W	N/A	N/A	N/A	Sep. 02, 2016	N/A	Conduction (CO05-HY)
Hygrometer	Testo	608-H1	34913912	N/A	Apr. 19, 2016	Sep. 02, 2016	Apr. 18, 2017	Conduction (CO05-HY)
LISN	Rohde & Schwarz	ENV216	100080	9kHz~30MHz	Dec. 02, 2015	Sep. 02, 2016	Dec. 01, 2016	Conduction (CO05-HY)
LF Cable	HUBER + SUHNER	RG-214/U	LF01	N/A	Jan. 06, 2016	Sep. 02, 2016	Jan. 05, 2017	Conduction (CO05-HY)
EMI Test Receiver	Keysight	N9038A(MXE)	MY54130085	20Hz ~ 8.4GHz	Nov. 04, 2015	Sep. 02, 2016	Nov. 03, 2016	Conduction (CO05-HY)
Loop Antenna	Rohde & Schwarz	HFH2-Z2	100315	9 kHz~30 MHz	Sep. 10, 2015	Sep. 02, 2016	Sep. 09, 2016	Radiation (03CH11-HY)
Bilog Antenna	TESEQ	CBL 6111D	35414	30MHz~1GHz	Nov. 17, 2015	Sep. 02, 2016	Nov. 16, 2016	Radiation (03CH11-HY)
Spectrum Analyzer	Keysight	N9010A	MY54200486	10Hz ~ 44GHZ	Sep. 24, 2015	Sep. 02, 2016	Sep. 23, 2016	Radiation (03CH11-HY)
Controller	EMEC	EM 1000	N/A	Control Turn table & Ant Mast	N/A	Sep. 02, 2016	N/A	Radiation (03CH11-HY)
Antenna Mast	EMEC	AM-BS-4500-B	N/A	1~4m	N/A	Sep. 02, 2016	N/A	Radiation (03CH11-HY)
Turn Table	EMEC	TT 2000	N/A	0~360 Degree	N/A	Sep. 02, 2016	N/A	Radiation (03CH11-HY)
EMI Test Receiver	Agilent	N9038A(MXE)	MY53290053	20Hz to 26.5GHz	Jan. 20, 2016	Sep. 02, 2016	Jan. 19, 2017	Radiation (03CH11-HY)
Loop Cable	Rohde & Schwarz	N/A	N/A	9KHz~30MHz	Dec. 03, 2015	Sep. 02, 2016	Dec. 02, 2016	Radiation (03CH11-HY)
RF Cable	HUBER + SUHNER	SUCOFLEX 104	MY9837/4 MY28419/4 MY28654/4	30MHz~1GHz	Nov. 05, 2015	Sep. 02, 2016	Nov. 04, 2016	Radiation (03CH11-HY)
Preamplifier	COM-POWER	PA-103A	161241	10MHz~1GHz	Mar. 18, 2016	Sep. 02, 2016	Mar. 17, 2017	Radiation (03CH11-HY)



Appendix A. Test Results of Conducted Emission Test

Test Mode :	NFC Tx	Test Voltage :	120Vac / 60Hz
Function Type :	GSM850 Idle + WLAN Link + Bluetooth Link + Earphone + USB Cable + Adapter		

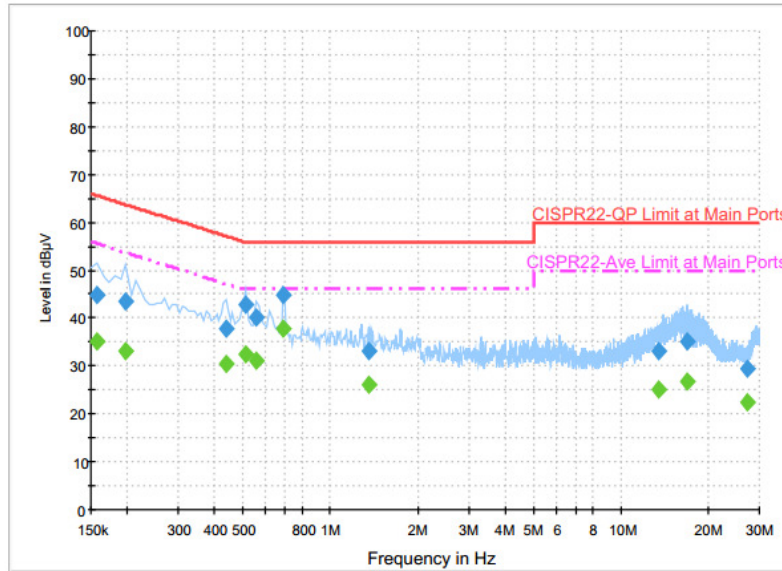

Final Result : Quasi-Peak

Frequency (MHz)	Quasi-Peak (dBµV)	Filter	Line	Corr. (dB)	Margin (dB)	Limit (dBµV)
0.158000	44.8	Off	L1	19.6	20.8	65.6
0.198000	43.3	Off	L1	19.6	20.4	63.7
0.438000	37.9	Off	L1	19.6	19.2	57.1
0.510000	42.7	Off	L1	19.6	13.3	56.0
0.558000	40.3	Off	L1	19.6	15.7	56.0
0.686000	44.8	Off	L1	19.6	11.2	56.0
1.350000	33.2	Off	L1	19.7	22.8	56.0
13.558000	33.1	Off	L1	20.3	26.9	60.0
16.894000	35.2	Off	L1	20.5	24.8	60.0
27.118000	29.3	Off	L1	21.0	30.7	60.0

Final Result : Average

Frequency (MHz)	Average (dBµV)	Filter	Line	Corr. (dB)	Margin (dB)	Limit (dBµV)
0.158000	35.0	Off	L1	19.6	20.6	55.6
0.198000	33.1	Off	L1	19.6	20.6	53.7
0.438000	30.3	Off	L1	19.6	16.8	47.1
0.510000	32.3	Off	L1	19.6	13.7	46.0
0.558000	31.2	Off	L1	19.6	14.8	46.0
0.686000	37.8	Off	L1	19.6	8.2	46.0
1.350000	26.0	Off	L1	19.7	20.0	46.0
13.558000	25.2	Off	L1	20.3	24.8	50.0
16.894000	26.9	Off	L1	20.5	23.1	50.0
27.118000	22.5	Off	L1	21.0	27.5	50.0



Test Mode :	NFC Tx	Test Voltage :	120Vac / 60Hz
Function Type :	GSM850 Idle + WLAN Link + Bluetooth Link + Earphone + USB Cable + Adapter		

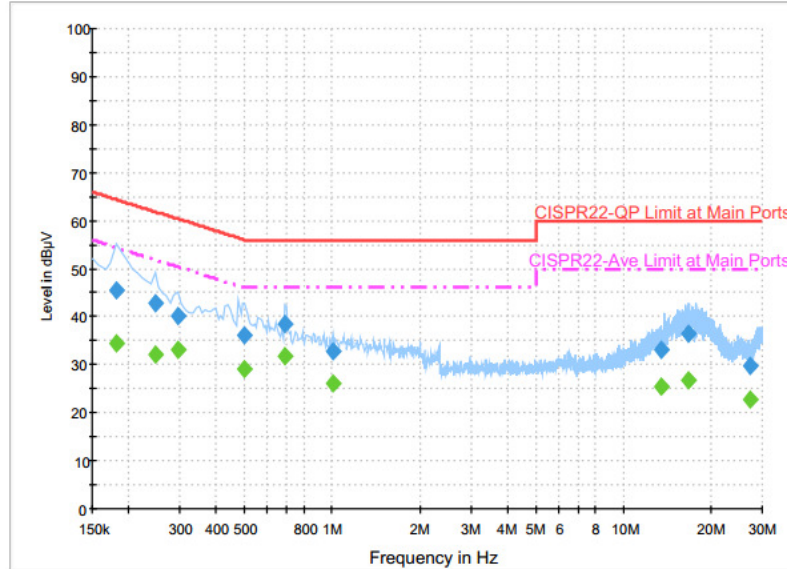

Final Result : Quasi-Peak

Frequency (MHz)	Quasi-Peak (dBµV)	Filter	Line	Corr. (dB)	Margin (dB)	Limit (dBµV)
0.182000	45.5	Off	N	19.6	18.9	64.4
0.246000	42.7	Off	N	19.6	19.2	61.9
0.294000	40.2	Off	N	19.6	20.2	60.4
0.502000	36.0	Off	N	19.6	20.0	56.0
0.686000	38.3	Off	N	19.6	17.7	56.0
1.006000	32.6	Off	N	19.6	23.4	56.0
13.558000	33.1	Off	N	20.4	26.9	60.0
16.790000	36.3	Off	N	20.6	23.7	60.0
27.118000	29.8	Off	N	21.2	30.2	60.0

Final Result : Average

Frequency (MHz)	Average (dBµV)	Filter	Line	Corr. (dB)	Margin (dB)	Limit (dBµV)
0.182000	34.4	Off	N	19.6	20.0	54.4
0.246000	32.0	Off	N	19.6	19.9	51.9
0.294000	33.2	Off	N	19.6	17.2	50.4
0.502000	29.0	Off	N	19.6	17.0	46.0
0.686000	31.8	Off	N	19.6	14.2	46.0
1.006000	26.0	Off	N	19.6	20.0	46.0
13.558000	25.3	Off	N	20.4	24.7	50.0
16.790000	26.8	Off	N	20.6	23.2	50.0
27.118000	22.6	Off	N	21.2	27.4	50.0



Appendix B. Test Results of Conducted Test Items

B1. Test Result of 20dB Spectrum Bandwidth

Test mode	NFC Tx	Test Frequency (MHz)	13.56
Date: 2.SEP.2016 20:42:31		Date: 2.SEP.2016 20:42:56	
20dB Bandwidth (kHz)	2.640	99% OccupiedBW(kHz)	2.240
Frequency range (MHz)	$f_L > 13.553$	13.55866	Test Result
	$f_H < 13.567$	13.56130	Complies



B2. Test Result of Frequency Stability

Voltage vs. Frequency Stability		Temperature vs. Frequency Stability		
Voltage (Vac)	Measurement Frequency (MHz)	Temperature (°C)	Time	Measurement Frequency (MHz)
120	13.559920	-20	0	13.560000
102	13.559920		2	13.560000
138	13.559920		5	13.560000
			10	13.560000
		-10	0	13.560020
			2	13.560020
			5	13.560020
			10	13.560030
		0	0	13.560020
			2	13.560020
			5	13.560020
			10	13.560020
		10	0	13.560030
			2	13.560020
			5	13.560020
			10	13.560020
		20	0	13.559900
			2	13.559920
			5	13.559920
			10	13.559920
		30	0	13.559920
			2	13.559920
			5	13.559920
			10	13.559900
		40	0	13.559920
			2	13.559920
			5	13.559920
			10	13.559910
		50	0	13.559910
			2	13.559910
			5	13.559900
			10	13.559920
Max.Deviation (MHz)	-0.000080	Max.Deviation (MHz)	-0.000100	
Max.Deviation (ppm)	-5.8997	Max.Deviation (ppm)	-7.3746	
Limit	FS < ±100 ppm	Limit	FS < ±100 ppm	
Test Result	PASS	Test Result	PASS	



Appendix C. Test Results of Radiated Test Items

C1. Test Result of Field Strength of Fundamental Emissions

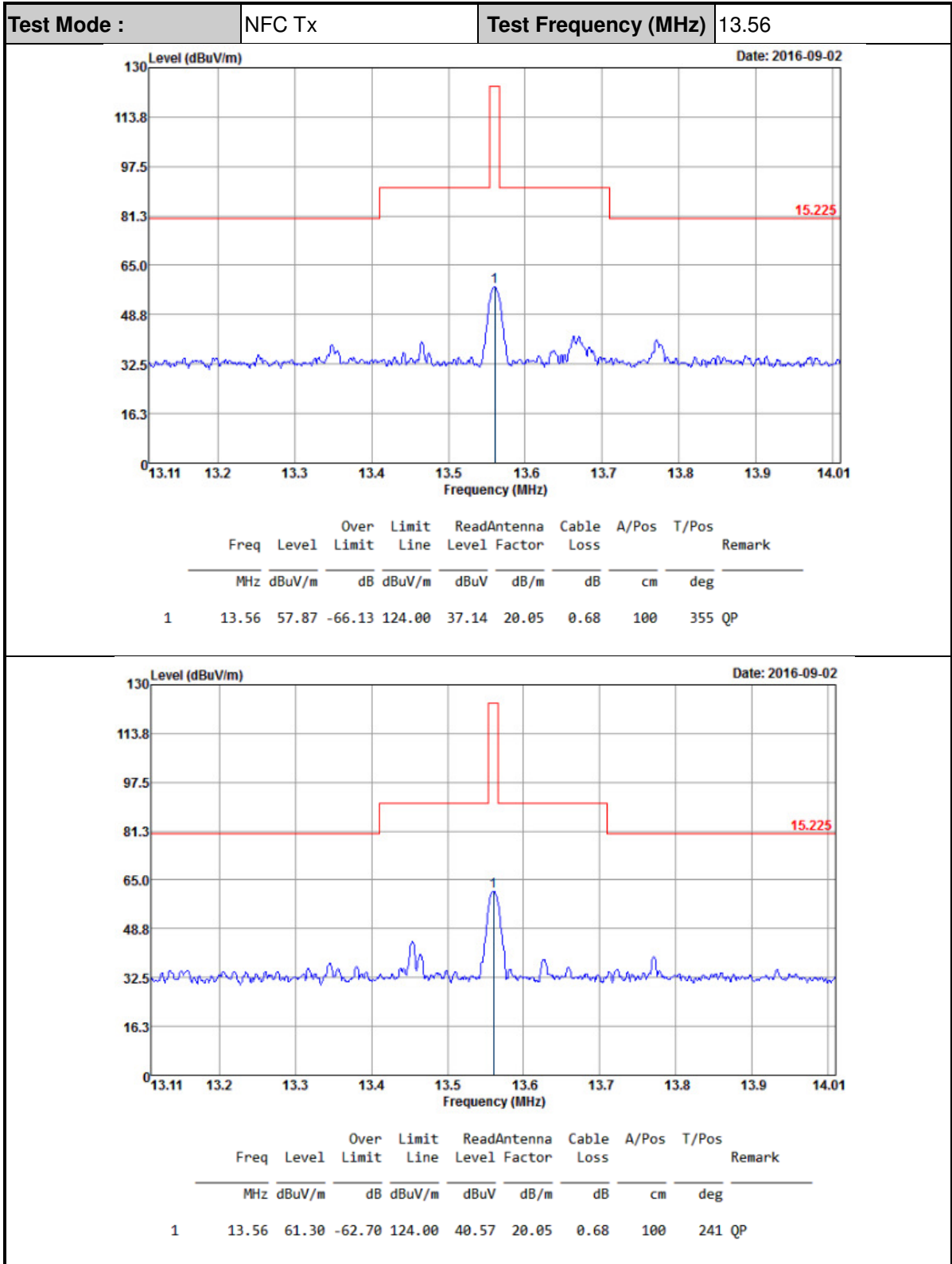



C2. Results of Radiated Spurious Emissions (9 kHz~30MHz)

Test Mode :	NFC Tx	Polarization :	Horizontal
-------------	--------	----------------	------------

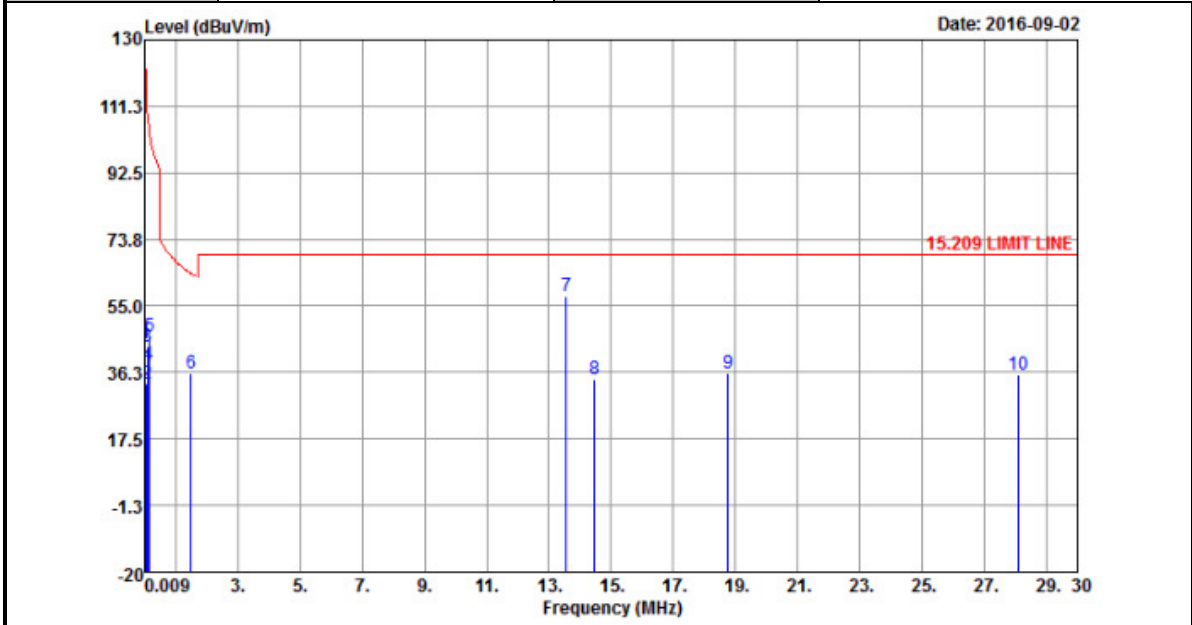

Frequency (MHz)	Level (dBμV/m)	Over Limit (dB)	Limit Line (dBμV/m)	Read Level (dBμV)	Antenna Factor (dB)	Cable Loss (dB)	Ant Pos (cm)	Table Pos (deg)	Remark
0.0193	44.17	-77.72	121.89	23.24	20.25	0.68			Average
0.0633	33.01	-78.57	111.58	12.29	20.04	0.68			Average
0.104	43.43	-63.83	107.26	22.76	19.99	0.68			QP
0.12596	38.67	-66.93	105.6	18.02	19.97	0.68			Average
0.15238	46.41	-57.54	103.95	25.78	19.95	0.68			Average
1.504	35.81	-28.25	64.06	15.2	19.93	0.68	100	204	QP
13.56	57.88	-	-	37.15	20.05	0.68			QP
14.464	34.22	-35.28	69.5	13.49	20.05	0.68			QP
18.754	36.06	-33.44	69.5	15.09	20.29	0.68			QP
28.105	35.73	-33.77	69.5	14.06	20.6	1.07			QP

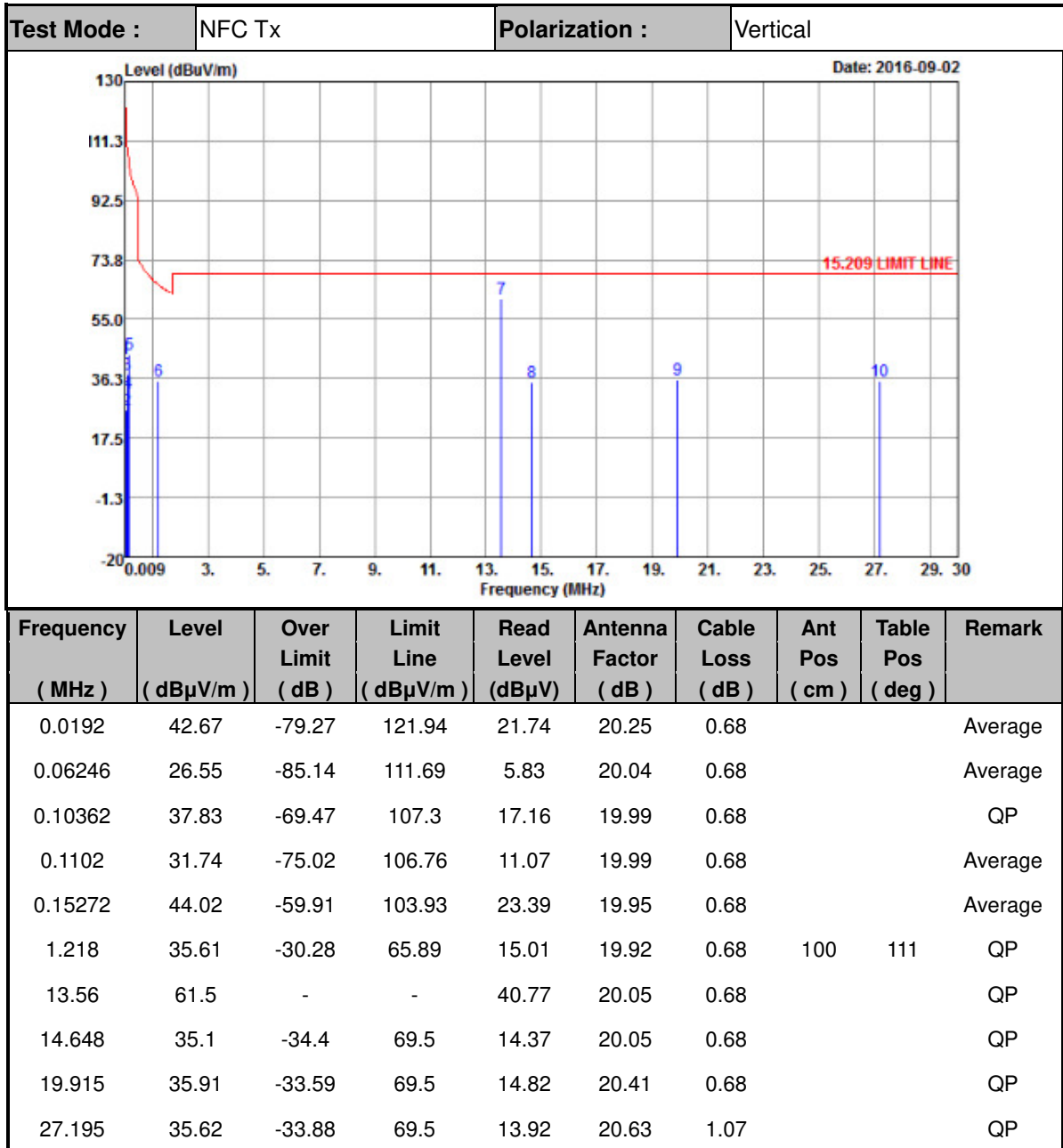

Note:

1. 13.56 MHz is fundamental signal which can be ignored.
2. The amplitude of spurious emissions which are attenuated by more than 20dB below the permissible value has no need to be reported.
3. Distance extrapolation factor = 40 log (specific distance / test distance) (dB);
4. Limit line = specific limits (dBuV) + distance extrapolation factor.



C3. Results of Radiated Spurious Emissions (30MHz~1GHz)

Test Mode :	NFC Tx	Polarization :	Horizontal
-------------	--------	----------------	------------

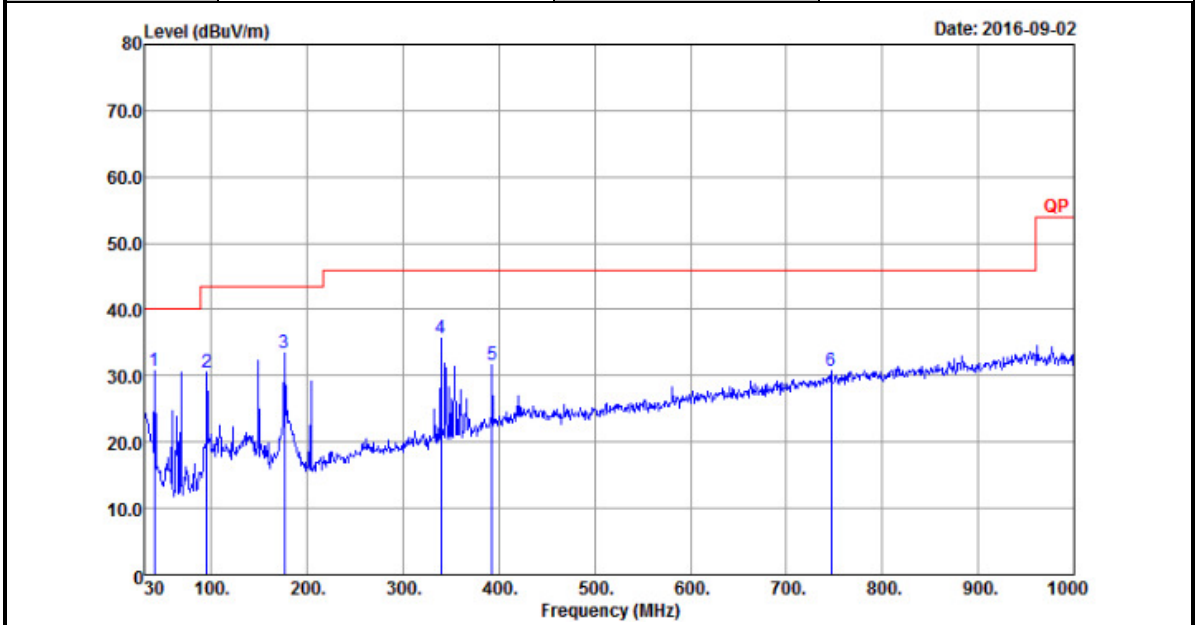

Frequency (MHz)	Level (dB μ V/m)	Over Limit (dB)	Limit Line (dB μ V/m)	Read Level (dB μ V)	Antenna Factor (dB)	Cable Loss (dB)	Preamp Factor (dB)	Ant Pos (cm)	Table Pos (deg)	Remark
40.53	30.67	-9.33	40	41.82	19.74	0.93	31.82	106	89	Peak
94.8	30.59	-12.91	43.5	45.7	15.5	1.17	31.78			Peak
176.34	33.36	-10.14	43.5	48.01	15.45	1.68	31.78			Peak
339.2	35.62	-10.38	46	44.37	20.8	2.23	31.78			Peak
393.1	31.74	-14.26	46	38.74	22.22	2.58	31.8			Peak
746.6	30.68	-15.32	46	31.4	27.64	3.62	31.98			Peak



Test Mode :	NFC Tx	Polarization :	Vertical
-------------	--------	----------------	----------

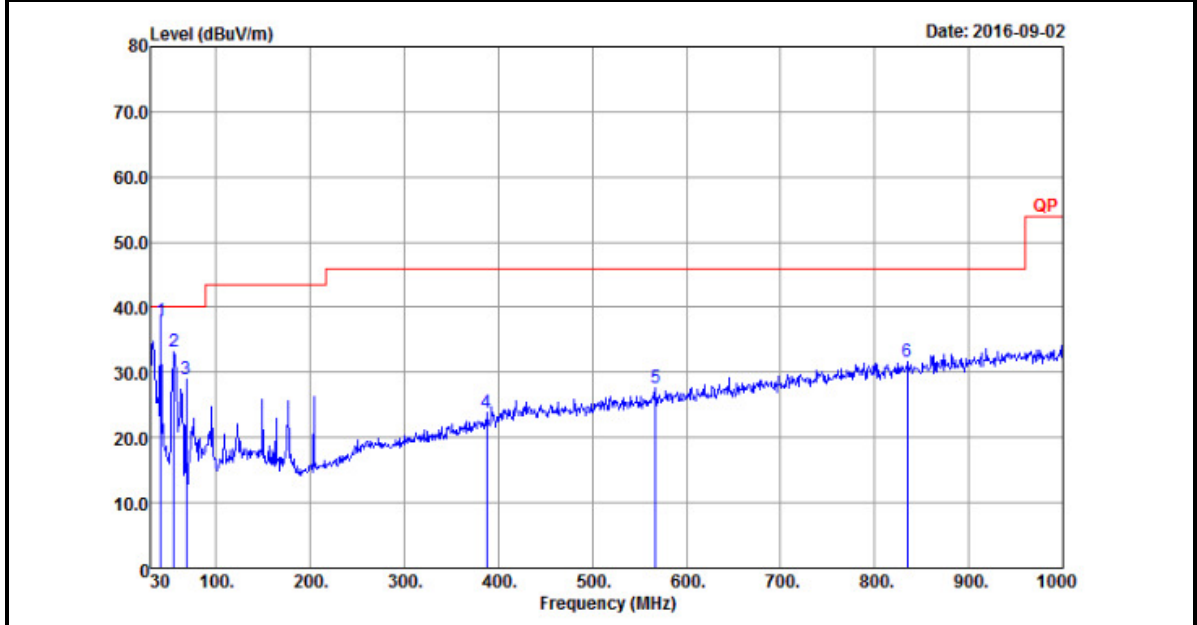

Frequency (MHz)	Level (dBμV/m)	Over Limit (dB)	Limit Line (dBμV/m)	Read Level (dBμV)	Antenna Factor (dB)	Cable Loss (dB)	Preamp Factor (dB)	Ant Pos (cm)	Table Pos (deg)	Remark
40.8	37.92	-2.08	40	49.07	19.74	0.93	31.82	102	198	QP
55.11	33.22	-6.78	40	50.69	13.4	0.93	31.8			Peak
67.8	28.95	-11.05	40	47.27	12.3	1.17	31.79			Peak
387.5	23.84	-22.16	46	30.96	22.09	2.58	31.79			Peak
567.4	27.56	-18.44	46	31.41	25.11	3.03	31.99			Peak
834.8	31.55	-14.45	46	30.81	28.72	3.77	31.75			Peak

Note:

1. The amplitude of spurious emissions which are attenuated by more than 20dB below the permissible value has no need to be reported.
2. Emission level (dBμV/m) = 20 log Emission level (μV/m).
3. Corrected Reading: Antenna Factor + Cable Loss + Read Level - Preamp Factor= Level.



Appendix D. Verification of Radiated Spurious Emissions at open-area test site

D1. Results of Radiated Emissions (9 kHz~30MHz)

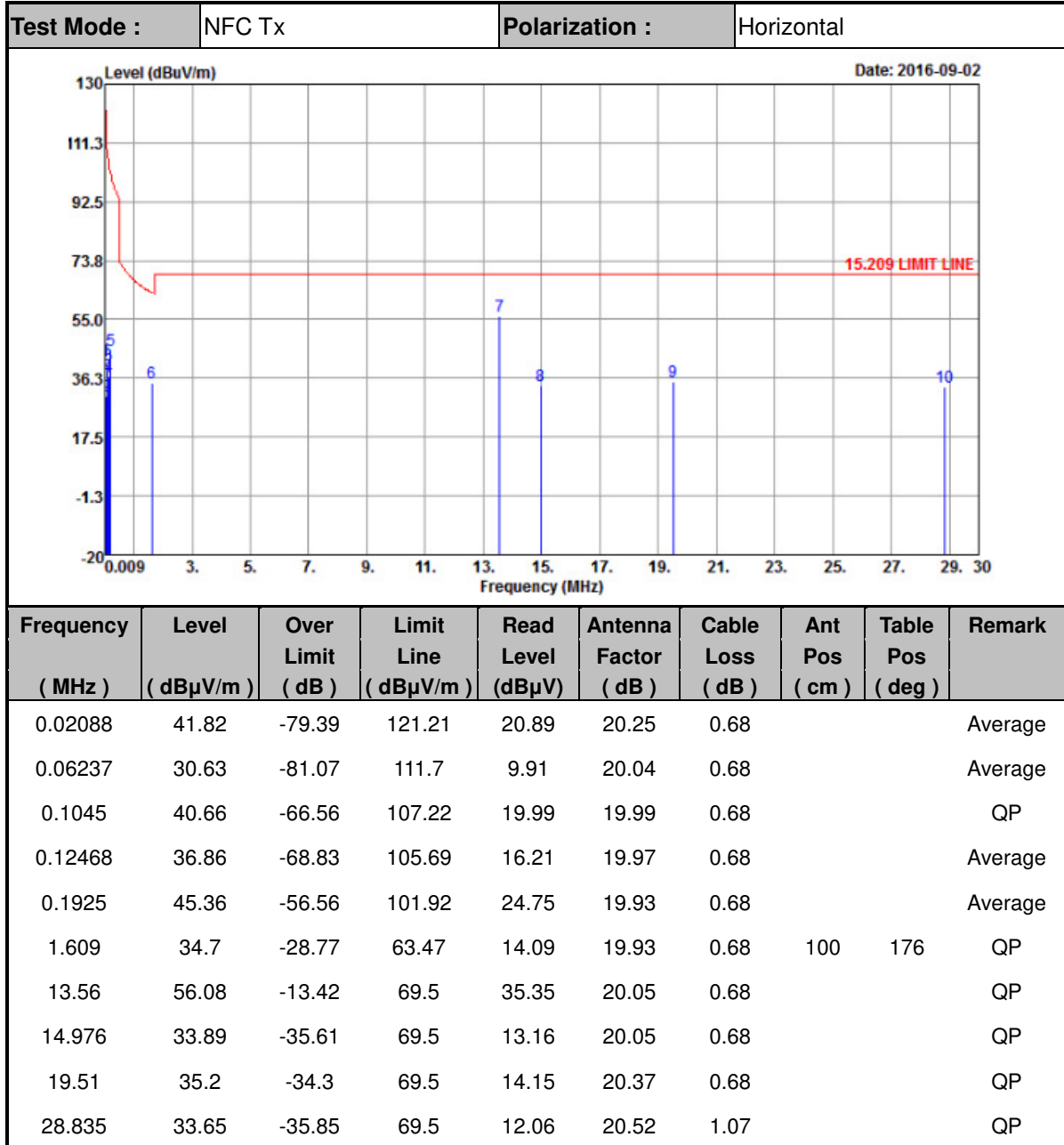

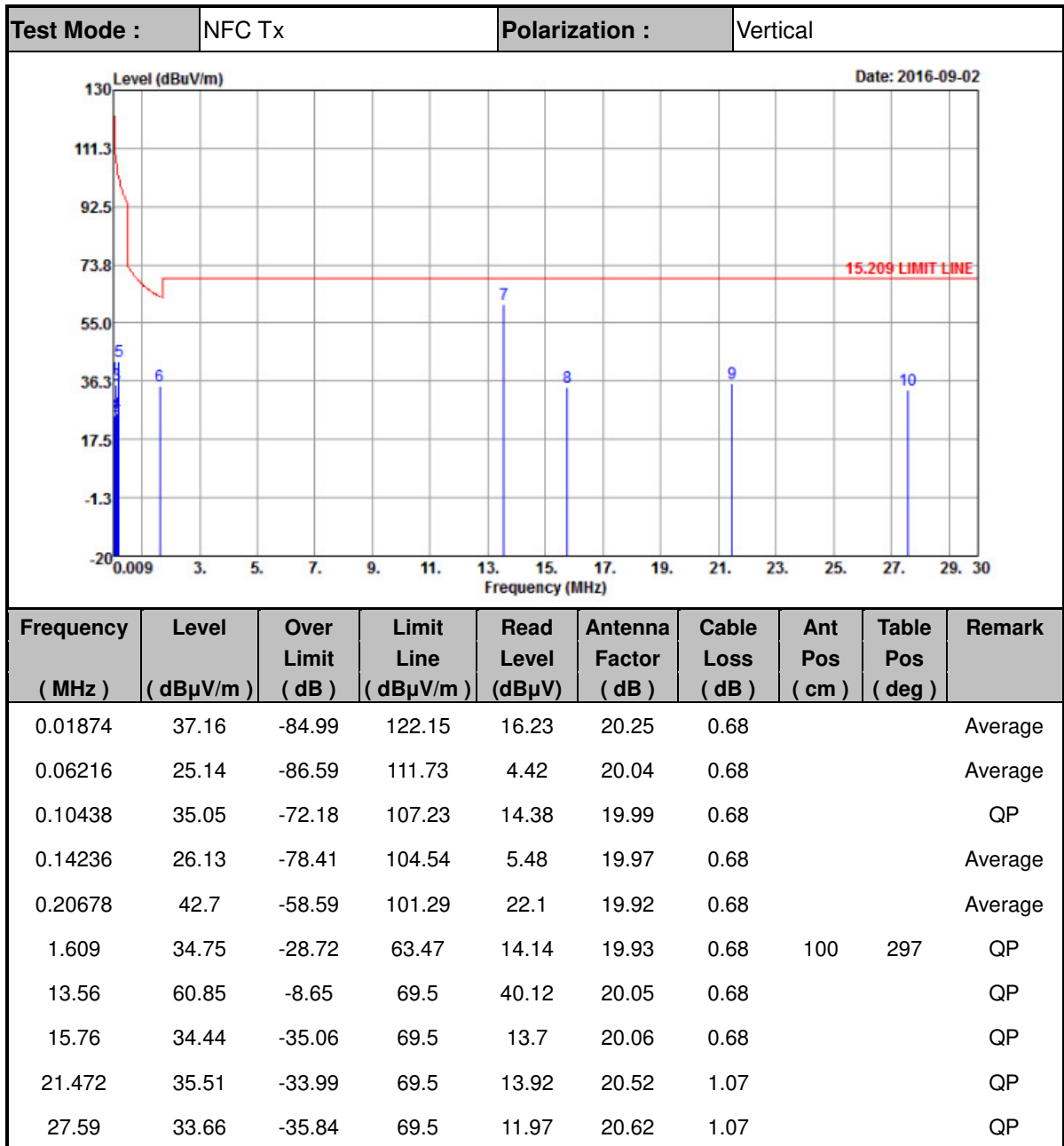

Note:

1. 13.56 MHz is fundamental signal which can be ignored.
2. The amplitude of spurious emissions which are attenuated by more than 20dB below the permissible value has no need to be reported.
3. Distance extrapolation factor = 40 log (specific distance / test distance) (dB);
4. Limit line = specific limits (dBuV) + distance extrapolation factor.
5. The test distance between the receiving antenna and the EUT is 3meter.

**D2. List of Measuring Equipment**

Instrument	Manufacturer	Model No.	Serial No.	Characteristics	Calibration Date	Test Date	Due Date	Remark
Test Receiver	R&S	ESCS 30	836858/024	9 kHz ~ 2.75 GHz	Jun. 24, 2016	Sep. 02, 2016	Jun. 23, 2017	Radiation (OS03-LK)
Loop Antenna	R&S	HFH2-Z2	100315	9 kHz ~ 30MHz	Sep. 10, 2015	Sep. 02, 2016	Sep. 09, 2016	Radiation (OS03-LK)
Turn Table	EMCO	2080	9711-2021	0 ~ 360 degree	N/A	Sep. 02, 2016	N/A	Radiation (OS03-LK)
Hygrometer	TECPEL	DTM-300	TP151707	N/A	May 20, 2016	Sep. 02, 2016	May 19, 2017	Radiation (OS03-LK)
RF Cable	HUBER+SUHNER	SUCOFLEX 104	MY84209521	9kHz~1GHz	Dec. 03, 2015	Sep. 02, 2016	Dec. 02, 2016	Radiation (OS03-LK)
Controller	EMCO	2090	N/A	Control Turn table	N/A	Sep. 02, 2016	N/A	Radiation (OS03-LK)
Test software	N/A	E3	6.2009-8-24 (sporton)	N/A	N/A	Sep. 02, 2016	N/A	Radiation (OS03-LK)