



FCC RF Test Report

APPLICANT : Sony Mobile Communications Inc.
EQUIPMENT : GSM/WCDMA/LTE Phone+Bluetooth, DTS/UNII a/b/g/n and NFC
BRAND NAME : Sony
MODEL NAME : H3361
FCC ID : PY7-35228S
STANDARD : FCC Part 15 Subpart C §15.225
CLASSIFICATION : (DXX) Low Power Communication Device Transmitter

The testing was completed on Aug. 31, 2017. We, SPORTON INTERNATIONAL INC., would like to declare that the tested sample has been evaluated in accordance with the test procedures and has been in compliance with the applicable technical standards.

The test results in this report apply exclusively to the tested model / sample. Without written approval of SPORTON INTERNATIONAL INC., the test report shall not be reproduced except in full.

Reviewed by: Joseph Lin / Supervisor

Approved by: Jones Tsai / Manager



SPORTON INTERNATIONAL INC.

No. 52, Hwa Ya 1st Rd., Hwa Ya Technology Park, Kwei-Shan District, Tao Yuan City, Taiwan, R.O.C.



TABLE OF CONTENTS

REVISION HISTORY.....3

SUMMARY OF THE TEST RESULT4

1. GENERAL INFORMATION.....5

1.1 Applicant..... 5

1.2 Manufacturer 5

1.3 Product Feature of Equipment Under Test 5

1.4 Product Specification of Equipment Under Test 6

1.5 Modification of EUT 6

1.6 Testing Location 7

1.7 Applicable Standards..... 7

2. TEST CONFIGURATION OF EQUIPMENT UNDER TEST8

2.1 Descriptions of Test Mode 8

2.2 Connection Diagram of Test System 8

2.3 Table for Supporting Units 9

2.4 EUT Operation Test Setup 9

3. TEST RESULTS.....10

3.1 AC Power Line Conducted Emissions Measurement 10

3.2 20dB and 99% OBW Spectrum Bandwidth Measurement..... 12

3.3 Frequency Stability Measurement 13

3.4 Field Strength of Fundamental Emissions and Mask Measurement..... 14

3.5 Radiated Emissions Measurement 16

3.6 Antenna Requirements..... 19

4. LIST OF MEASURING EQUIPMENT20

APPENDIX A. TEST RESULTS OF CONDUCTED EMISSION TEST

APPENDIX B. TEST RESULTS OF CONDUCTED TEST ITEMS

B1. Test Result of 20dB Spectrum Bandwidth

B2. Test Result of Frequency Stability

APPENDIX C. TEST RESULTS OF RADIATED TEST ITEMS

C1. Test Result of Field Strength of Fundamental Emissions

C2. Results of Radiated Emissions (9 kHz~30MHz)

C3. Results of Radiated Emissions (30MHz~1GHz)



SUMMARY OF THE TEST RESULT

Applied Standard: 47 CFR FCC Part 15 Subpart C				
Part	FCC Rule	Description of Test	Result	Remark
3.1	15.207	AC Power Line Conducted Emissions	Complies	Under limit 8.20 dB at 3.214MHz
3.2	15.215(c)	20dB Spectrum Bandwidth	Complies	-
	-	99% OBW Spectrum Bandwidth	Complies	-
3.3	15.225(e)	Frequency Stability	Complies	-
3.4	15.225(a)(b)(c)	Field Strength of Fundamental Emissions	Complies	Max level 60.71 dB μ V/m at 13.560 MHz
3.5	15.225(d) 15.209	Radiated Spurious Emissions	Complies	Under limit 5.20 dB at 40.800MHz
3.6	15.203	Antenna Requirements	Complies	-

Test Items	Uncertainty	Remark
AC Power Line Conducted Emissions	± 2.26 dB	Confidence levels of 95%
Radiated Emissions (30MHz~1000MHz)	± 5.20 dB	Confidence levels of 95%



1. GENERAL INFORMATION

1.1 Applicant

Sony Mobile Communications Inc.

4-12-3 Higashi-Shinagawa, Shinagawa-ku, Tokyo, 140-0002, Japan

1.2 Manufacturer

Sony Mobile Communications Inc.

4-12-3 Higashi-Shinagawa, Shinagawa-ku, Tokyo, 140-0002, Japan

1.3 Product Feature of Equipment Under Test

GSM/WCDMA/LTE, Bluetooth, DTS/UNII a/b/g/n, FM Receiver, NFC, and GPS.

Product Specification subjective to this standard	
Antenna Type	Loop Antenna

EUT Information List			
HW Version	SW Version	S/N	Performed Test Item
A	1.8	WUJ01Q229P	RF conducted measurement
		WUJ01Q22BN	Radiated Spurious Emission
		WUJ01Q223T	Conducted Emission



Accessory List	
AC Adapter	Model No. : EP800
	S/N :
	3015W41611569(for radiation spurious emission) 3015W41612282(for conducted emission)
Earphone	Model No. : MH410c
	S/N: N/A
USB Cable	Model No. : UCB20
	S/N : 1635A9100031498

Note:

1. Above EUT list and accessory list used are electrically identical per declared by manufacturer.
2. Above the accessories list are used to exercise the EUT during test.
3. For other wireless features of this EUT, test report will be issued separately.

1.4 Product Specification of Equipment Under Test

Standards-related Product Specification	
Tx/Rx Frequency Range	13.553 ~ 13.567MHz
Channel Number	1
20dBW	2.64KHz
99%OBW	2.24KHz
Type of Modulation	ASK

Remark: The above EUT's information was declared by manufacturer. Please refer to the specifications or user's manual for more detailed description.

1.5 Modification of EUT

No modifications are made to the EUT during all test items.



1.6 Testing Location

Sporton Lab is accredited to ISO 17025 by Taiwan Accreditation Foundation (TAF code : 1190) and the FCC designation No. TW1190 and TW0007 under the FCC 2.948(e) by Mutual Recognition Agreement (MRA) in FCC Test.

Test Site	SPORTON INTERNATIONAL INC.	
Test Site Location	No. 52, Hwa Ya 1 st Rd., Hwa Ya Technology Park, Kwei-Shan District, Tao Yuan City, Taiwan, R.O.C. TEL: +886-3-3273456 / FAX: +886-3-3284978	
Test Site No.	Sporton Site No.	
	TH03-HY	CO05-HY
Test Engineer	Tommy Lee	Shareef Yu , Eric Jeng
Temperature	22~24°C	26~27°C
Relative Humidity	53~55%	58~62%

Note: The test site complies with ANSI C63.4 2014 requirement.

Test Site	SPORTON INTERNATIONAL INC.	
Test Site Location	No.58, Aly. 75, Ln. 564, Wenhua 3rd Rd. Guishan Dist, Taoyuan City, Taiwan (R.O.C.) TEL: +886-3-327-0868 FAX: +886-3-327-0855	
Test Site No.	Sporton Site No.	
	03CH11-HY	
Test Engineer	Jacky Hung	
Temperature	25~26°C	
Relative Humidity	53~55%	

Note: The test site complies with ANSI C63.4 2014 requirement.

1.7 Applicable Standards

According to the specifications of the manufacturer, the EUT must comply with the requirements of the following standards:

- ♦ FCC Part 15 Subpart C §15.225
- ♦ FCC KDB 414788 D01 Radiated Test Site v01
- ♦ ANSI C63.10-2013

2. TEST CONFIGURATION OF EQUIPMENT UNDER TEST

2.1 Descriptions of Test Mode

Investigation has been done on all the possible configurations for searching the worst cases.

The following table is a list of the test modes shown in this test report.

Test Items	
AC Power Line Conducted Emissions	Field Strength of Fundamental Emissions
20dB Spectrum Bandwidth	Frequency Stability
Radiated Emissions 9kHz~30MHz	Radiated Emissions 30MHz~1GHz

The EUT pre-scanned in three NFC type, A, B, F. The worst type (type F) was recorded in this report.

Pre-scanned tests, X, Y, Z in three orthogonal panels to determine the final configuration (Z plane as worst plane) from all possible combinations.

2.2 Connection Diagram of Test System

<AC Conducted Emissions>

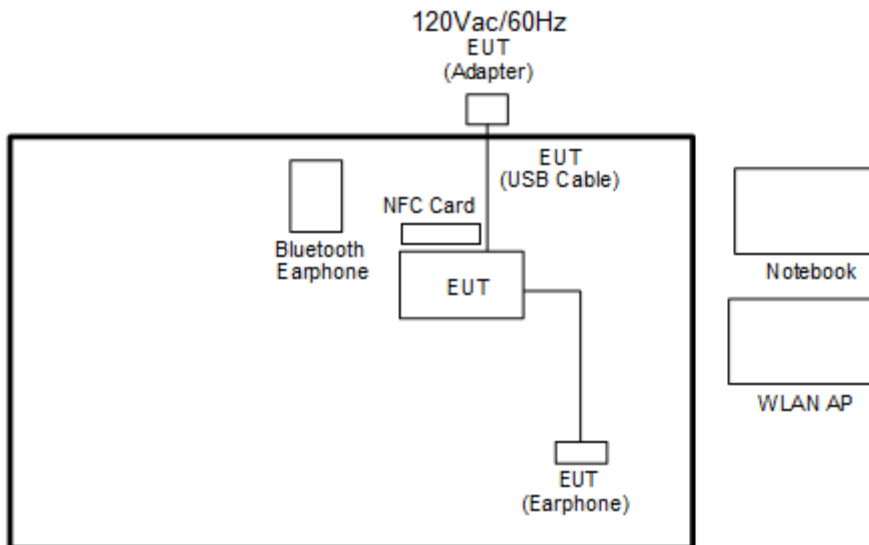

< For Radiated Emissions Measurement >

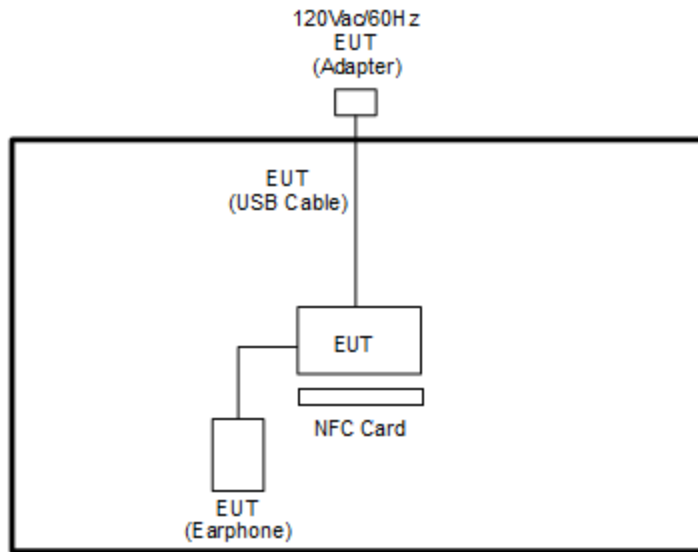

2.3 Table for Supporting Units

Support Unit	Manufacturer	Model	FCC ID
Bluetooth Earphone	Sony	SBH20	PY7-RD0010
WLAN AP	ASUS	RT-AC66U	MSQ-RTAC66U
Notebook	DELL	Latitude E6320	FCC DoC/ Contains FCC ID: QDS-BRCM1054
SD Card	SanDisk	MicroSD HC	FCC DoC
NFC Card	Metro Taipei	Easy Card	N/A

2.4 EUT Operation Test Setup

The EUT was programmed to be in continuously transmitting mode.

The ancillary equipment, NFC card, is used to make the EUT (NFC) continuously transmit at 13.56MHz and is placed around 3 cm gap to the EUT.



3. TEST RESULTS

3.1 AC Power Line Conducted Emissions Measurement

3.1.1 Limit of AC Conducted Emission

For equipment that is designed to be connected to the public utility (AC) power line, the radio frequency voltage that is conducted back onto the AC power line on any frequency or frequencies within the band 150 kHz to 30 MHz shall not exceed the limits in the following table.

Frequency of Emission (MHz)	Conducted Limit (dB μ V)	
	Quasi-Peak	Average
0.15-0.5	66 to 56*	56 to 46*
0.5-5	56	46
5-30	60	50

*Decreases with the logarithm of the frequency.

For terminal test result, the testing follows FCC KDB 174176.

3.1.2 Measuring Instruments

See list of measuring instruments of this test report.

3.1.3 Test Procedures

1. The EUT was placed 0.4 meter from the conducting wall of the shielding room, and it was kept at least 80 centimeters from any other grounded conducting surface.
2. Connect EUT to the power mains through a line impedance stabilization network (LISN).
3. All the support units are connecting to the other LISN.
4. The LISN provides 50 ohm coupling impedance for the measuring instrument.
5. The FCC states that a 50 ohm, 50 microhenry LISN should be used.
6. Both sides of AC line were checked for maximum conducted interference.
7. The frequency range from 150 kHz to 30 MHz was searched.
8. Set the test-receiver system to Peak Detect Function and specified bandwidth (IF Bandwidth = 9kHz) with Maximum Hold Mode. Then measurement is also conducted by Average Detector and Quasi-Peak Detector Function respectively.

3.1.4 Test setup

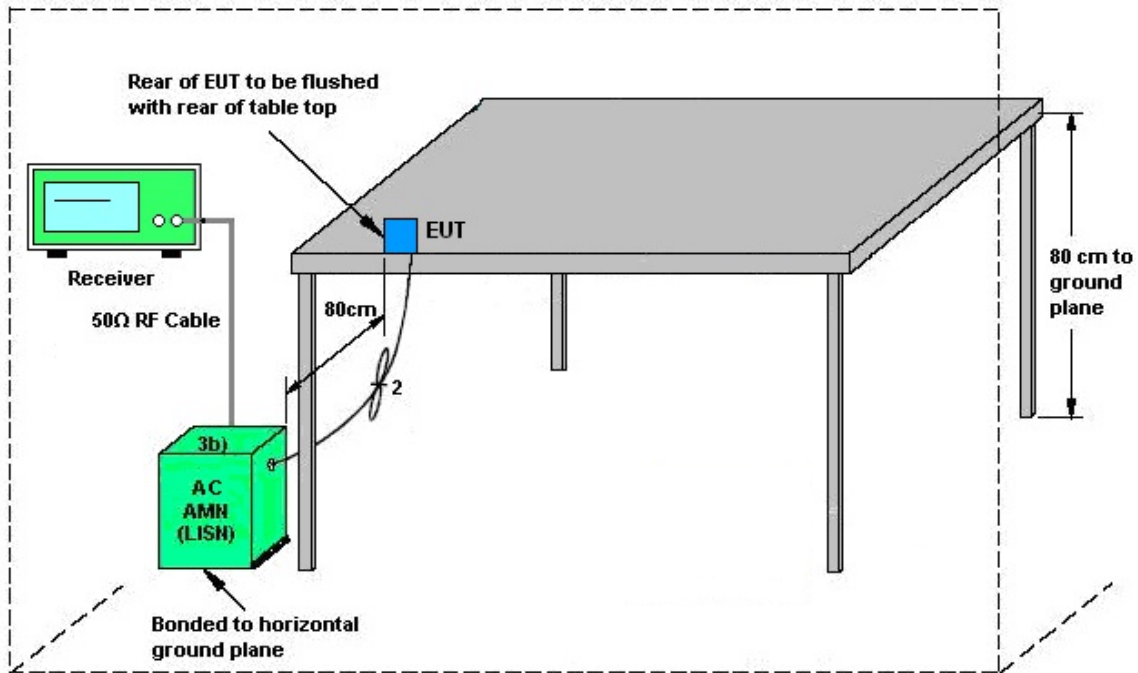

AMN = Artificial mains network (LISN)
 AE = Associated equipment
 EUT = Equipment under test
 ISN = Impedance stabilization network

3.1.5 Test Result of AC Conducted Emission

Please refer to Appendix A.

3.2 20dB and 99% OBW Spectrum Bandwidth Measurement

3.2.1 Limit

Intentional radiators must be designed to ensure that the 20dB and 99% emission bandwidth in the specific band 13.553~13.567MHz.

3.2.2 Measuring Instruments

See list of measuring instruments of this test report.

3.2.3 Test Procedures

1. The spectrum analyzer connected via a receive antenna placed near the EUT in peak Max hold mode.
2. The resolution bandwidth of 1 kHz and the video bandwidth of 3 kHz were used.
3. Measured the spectrum width with power higher than 20dB below carrier.
4. Measured the 99% OBW.

3.2.4 Test Setup



3.2.5 Test Result of Conducted Test Items

Please refer to Appendix B.

3.3 Frequency Stability Measurement

3.3.1 Limit

The frequency tolerance of the carrier signal shall be maintained within +/- 0.01% (100ppm) of the operating frequency over a temperature variation of -20 degrees to +50 degrees C at normal supply voltage, and for a variation in the primary supply voltage from 85% to 115% of the rated supply voltage at a temperature of 20 degrees C. For battery operated equipment, the equipment tests shall be performed using a new battery.

3.3.2 Measuring Instruments

See list of measuring instruments of this test report.

3.3.3 Test Procedures

1. The spectrum analyzer connected via a receive antenna placed near the EUT.
2. EUT have transmitted signal and fixed channelize.
3. Set the spectrum analyzer span to view the entire emissions bandwidth.
4. Set RBW = 1 kHz, VBW = 3 kHz with peak detector and maxhold settings.
5. The f_c is declaring of channel frequency. Then the frequency error formula is $(f_c - f) / f_c \times 10^6$ ppm and the limit is less than ± 100 ppm.
6. Extreme temperature rule is -20°C~50°C.

3.3.4 Test Setup



3.3.5 Test Result of Conducted Test Items

Please refer to Appendix B.



3.4 Field Strength of Fundamental Emissions and Mask Measurement

3.4.1 Limit

Rules and specifications	FCC CFR 47 Part 15 section 15.225			
Description	Compliance with the spectrum mask is tested with RBW set to 9kHz.			
Freq. of Emission (MHz)	Field Strength ($\mu\text{V/m}$) at 30m	Field Strength ($\text{dB}\mu\text{V/m}$) at 30m	Field Strength ($\text{dB}\mu\text{V/m}$) at 10m	Field Strength ($\text{dB}\mu\text{V/m}$) at 3m
1.705~13.110	30	29.5	48.58	69.5
13.110~13.410	106	40.5	59.58	80.5
13.410~13.553	334	50.5	69.58	90.5
13.553~13.567	15848	84.0	103.08	124.0
13.567~13.710	334	50.5	69.58	90.5
13.710~14.010	106	40.5	59.58	80.5
14.010~30.000	30	29.5	48.58	69.5

3.4.2 Measuring Instruments

See list of measuring instruments of this test report.

3.4.3 Test Procedures

1. Configure the EUT according to ANSI C63.10. The EUT was placed on the top of the turntable 0.8 meter above ground. The phase center of the loop receiving antenna mounted antenna tower was placed 3 meters far away from the turntable.
2. Power on the EUT and all the supporting units. The turntable was rotated by 360 degrees to determine the position of the highest radiation.
3. The height of the receiving antenna was fixed at one meter above ground to find the maximum emissions field strength.
4. For Fundamental emissions, use the receiver to measure QP reading.
5. When the radiated emissions limits are expressed in terms of the average value of the emissions, and pulsed operation is employed, the measurement field strength shall be determined by averaging over one complete pulse train, including blanking intervals, as long as the pulse train does not exceed 0.1 seconds. As an alternative (provided the transmitter operates for longer than 0.1 seconds) or in cases where the pulse train exceeds 0.1 seconds, the measured field strength shall be determined from the average absolute voltage during a 0.1 second interval during which the field strength is at its maximum value.
6. Compliance with the spectrum mask is tested with RBW set to 9kHz.

Note: Emission level (dB μ V/m) = 20 log Emission level (μ V/m).

3.4.4 Test Setup

For radiated emissions below 30MHz



3.4.5 Test Result of Field Strength of Fundamental Emissions and Mask

Please refer to Appendix C.



3.5 Radiated Emissions Measurement

3.5.1 Limit

The field strength of any emissions which appear outside of 13.110 ~14.010MHz band shall not exceed the general radiated emissions limits.

Frequencies (MHz)	Field Strength (µV/m)	Measurement Distance (meters)
0.009~0.490	2400/F(kHz)	300
0.490~1.705	24000/F(kHz)	30
1.705~30.0	30	30
30~88	100	3
88~216	150	3
216~960	200	3
Above 960	500	3

3.5.2 Measuring Instruments

See list of measuring instruments of this test report.

3.5.3 Measuring Instrument Setting

The following table is the setting of receiver.

Receiver Parameter	Setting
Attenuation	Auto
Frequency Range: 9kHz~150kHz	RBW 200Hz for QP
Frequency Range: 150kHz~30MHz	RBW 9kHz for QP
Frequency Range: 30MHz~1000MHz	RBW 120kHz for Peak

Note: The emission limits shown in the above table are based on measurements employing a CISPR quasi-peak detector except for the frequency bands 9-90 kHz, 110-490 kHz. Radiated emission limits in these two bands are based on measurements employing an average detector.



3.5.4 Test Procedures

1. Configure the EUT according to ANSI C63.10. The EUT was placed on the top of the turntable 0.8 meter above ground. The phase center of the receiving antenna mounted on the top of a height-variable antenna tower was placed 3 meters far away from the turntable.
2. Power on the EUT and all the supporting units. The turntable was rotated by 360 degrees to determine the position of the highest radiation.
3. The height of the broadband receiving antenna was varied between one meter and four meters above ground to find the maximum emissions field strength of both horizontal and vertical polarization.
4. For each suspected emissions, the antenna tower was scan (from 1 M to 4 M) and then the turntable was rotated (from 0 degree to 360 degrees) to find the maximum reading.
5. Set the test-receiver system to Peak or CISPR quasi-peak Detect Function with specified bandwidth under Maximum Hold Mode.
6. When the radiated emissions limits are expressed in terms of the average value of the emissions, and pulsed operation is employed, the measurement field strength shall be determined by averaging over one complete pulse train, including blanking intervals, as long as the pulse train does not exceed 0.1 seconds. As an alternative (provided the transmitter operates for longer than 0.1 seconds) or in cases where the pulse train exceeds 0.1 seconds, the measured field strength shall be determined from the average absolute voltage during a 0.1 second interval during which the field strength is at its maximum value.
7. In case the emission is lower than 30MHz, loop antenna has to be used for measurement and the recorded data should be QP measured by receiver. Antenna Requirements

3.5.5 Test Setup

For radiated emissions below 30MHz

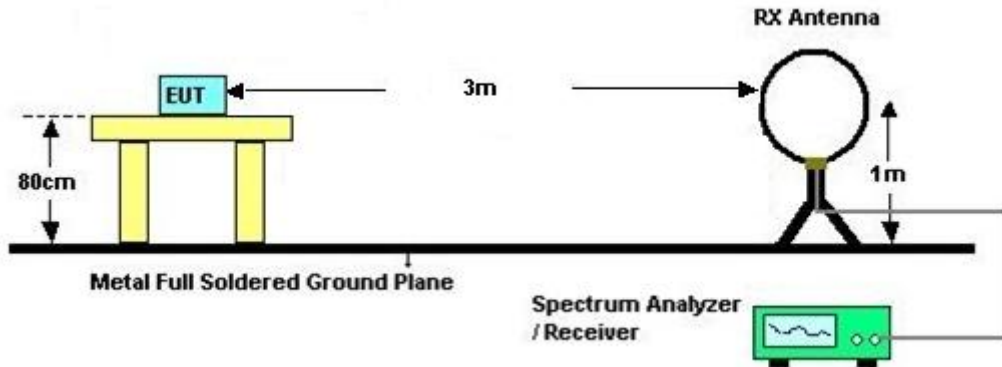

For radiated emissions above 30MHz

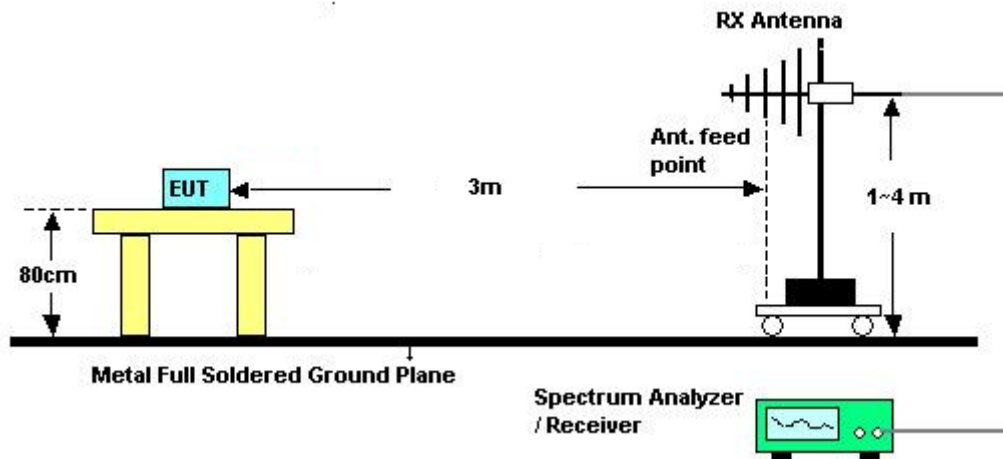

3.5.6 Test Result of Radiated Emissions Measurement

Please refer to Appendix C.

Note: There is a comparison data of both open-field test site and semi-Anechoic chamber, and the result came out very similar.



3.6 Antenna Requirements

3.6.1 Standard Applicable

Except for special regulations, the Low-power Radio-frequency Devices must not be equipped with any jacket for installing an antenna with extension cable. An intentional radiator shall be designed to ensure that no antenna other than that furnished by the responsible party shall be used with the device. The use of a permanently attached antenna or of an antenna that uses a unique coupling to the intentional radiator shall be considered sufficient to comply with the provisions of this Section. The manufacturer may design the unit so that the user can replace a broken antenna, but the use of a standard antenna jack or electrical connector is prohibited.

The use of a permanently attached antenna or of an antenna that uses a unique coupling to the intentional radiator shall be considered sufficient to comply with the rule.

3.6.2 Antenna Anti-Replacement Construction

An embedded-in antenna design is used.



4. LIST OF MEASURING EQUIPMENT

Instrument	Manufacturer	Model No.	Serial No.	Characteristics	Calibration Date	Test Date	Due Date	Remark
AC Power Source	AC POWER	AFC-500W	F104070011	50Hz~60Hz	Dec. 01, 2016	Aug. 31, 2017	Nov. 30, 2017	Conducted (TH03-HY)
Hygrometer	Testo	608-H1	34893241	N/A	Nov. 16, 2016	Aug. 31, 2017	Nov. 15, 2017	Conducted (TH03-HY)
Spectrum Analyzer	Rohde & Schwarz	FSP30	101329	9kHz~30GHz	Jun. 29, 2017	Aug. 31, 2017	Jun. 28, 2018	Conducted (TH03-HY)
Temperature Chamber	ESPEC	SU-641	92013721	-30℃ ~70℃	Nov. 16, 2016	Aug. 31, 2017	Nov. 15, 2017	Conducted (TH03-HY)
AC Power Source	ChainTek	APC-1000W	N/A	N/A	N/A	Aug. 25, 2017 ~ Aug. 30, 2017	N/A	Conduction (CO05-HY)
EMI Test Receiver	Rohde & Schwarz	ESU26	100472	20Hz~26.5GHz	Dec. 29, 2016	Aug. 25, 2017 ~ Aug. 30, 2017	Dec. 28, 2017	Conduction (CO05-HY)
Hygrometer	Testo	608-H1	34913912	N/A	May 02, 2017	Aug. 25, 2017 ~ Aug. 30, 2017	May 01, 2018	Conduction (CO05-HY)
LISN	Rohde & Schwarz	ENV216	100080	9kHz~30MHz	Nov. 29, 2016	Aug. 25, 2017 ~ Aug. 30, 2017	Nov. 28, 2017	Conduction (CO05-HY)
LF Cable	HUBER + SUHNER	RG-214/U	LF01	N/A	Jan. 05, 2017	Aug. 25, 2017 ~ Aug. 30, 2017	Jan. 04, 2018	Conduction (CO05-HY)
Test Software	N/A	EMC32	8.40.0	N/A	N/A	Aug. 25, 2017 ~ Aug. 30, 2017	N/A	Conduction (CO05-HY)
Bilog Antenna	TESEQ	CBL 6111D&N-6-06	35414&AT-N 0602	30MHz~1GHz	Oct. 15, 2016	Aug. 24, 2017~ Aug. 25, 2017	Oct. 14, 2017	Radiation (03CH11-HY)
Loop Antenna	Rohde & Schwarz	HFH2-Z2	100488	9 kHz~30 MHz	Oct. 20, 2016	Aug. 24, 2017~ Aug. 25, 2017	Oct. 19, 2018	Radiation (03CH11-HY)
EMI Test Receiver	Agilent	N9038A(MX E)	MY5329005 3	20Hz to 26.5GHz	Jan. 12, 2017	Aug. 24, 2017~ Aug. 25, 2017	Jan. 11, 2018	Radiation (03CH11-HY)
Amplifier	SONOMA	310N	187312	9kHz~1GHz	Nov. 10, 2016	Aug. 24, 2017~ Aug. 25, 2017	Nov. 09, 2017	Radiation (03CH11-HY)
Spectrum Analyzer	Keysight	N9010A	MY5420048 6	10Hz ~ 44GHz	Oct. 12, 2016	Aug. 24, 2017~ Aug. 25, 2017	Oct. 11, 2017	Radiation (03CH11-HY)
Hygrometer	TECPEL	DTN-303B	TP140325	N/A	Nov. 14, 2016	Aug. 24, 2017~ Aug. 25, 2017	Nov. 13, 2017	Radiation (03CH11-HY)
Filter	Wainwright	WHK20/100 0C7/40SS	SN2	20M High Pass	Nov. 22, 2016	Aug. 24, 2017~ Aug. 25, 2017	Nov. 21, 2017	Radiation (03CH11-HY)
RF Cable	HUBER + SUHNER	SUCOFLEX 104	MY9837/4 MY28419/4 MY28654/4	30MHz~1GHz	Sep. 12, 2016	Aug. 24, 2017~ Aug. 25, 2017	Sep. 11, 2017	Radiation (03CH11-HY)
RF Cable	HUBER + SUHNER	SUCOFLEX 104	MY9837/4	9K-30M	Mar. 20, 2017	Aug. 24, 2017~ Aug. 25, 2017	Mar. 19, 2018	Radiation (03CH11-HY)
Antenna Mast	EMEC	AM-BS-4500 -B	N/A	1~4m	N/A	Aug. 24, 2017~ Aug. 25, 2017	N/A	Radiation (03CH11-HY)
Turn Table	EMEC	TT 2000	N/A	0~360 Degree	N/A	Aug. 24, 2017~ Aug. 25, 2017	N/A	Radiation (03CH11-HY)
Test Software	Audix	E3	6.2009-8-24	N/A	N/A	Aug. 24, 2017~ Aug. 25, 2017	N/A	Radiation (03CH11-HY)

Appendix A. Test Results of Conducted Emission Test

<Original test result with NFC antenna>

Test Mode :	NFC Tx	Test Voltage :	120Vac / 60Hz
Function Type :	Bluetooth Link + WLAN (2.4GHz) Link + NFC Tx + Battery + Earphone + USB Cable (Charging from Adapter)		

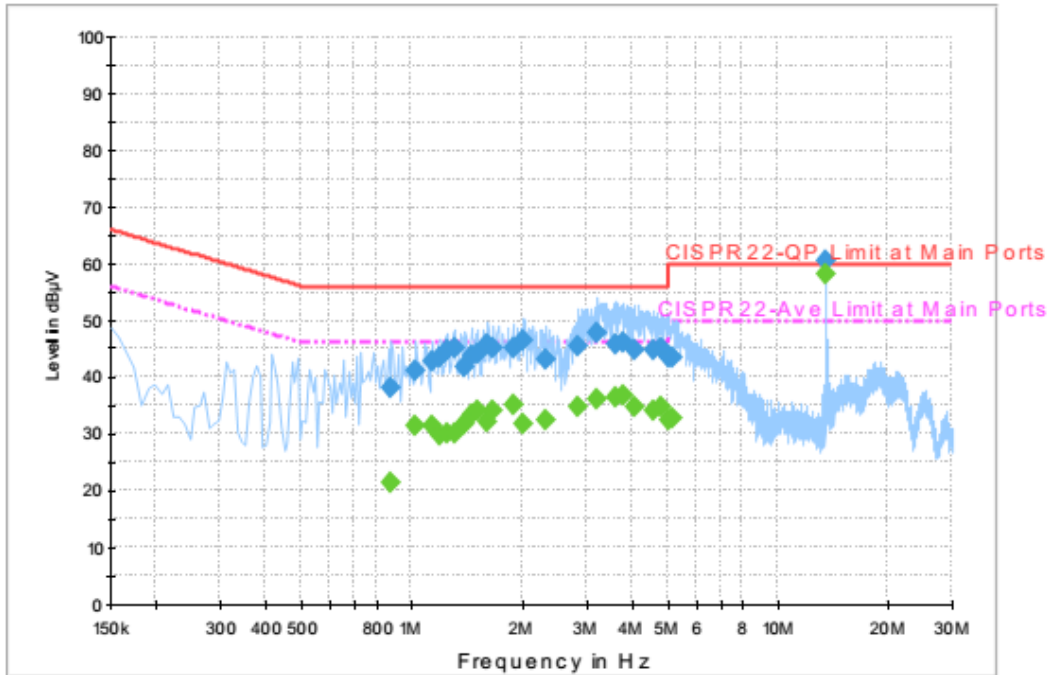

Final Result : Quasi-Peak

Frequency (MHz)	Quasi-Peak (dBµV)	Filter	Line	Corr. (dB)	Margin (dB)	Limit (dBµV)
0.878000	38.2	Off	L1	19.6	17.8	56.0
1.022000	41.1	Off	L1	19.6	14.9	56.0
1.134000	42.9	Off	L1	19.6	13.1	56.0
1.190000	43.6	Off	L1	19.6	12.4	56.0
1.246000	45.0	Off	L1	19.6	11.0	56.0
1.302000	45.0	Off	L1	19.6	11.0	56.0
1.398000	41.8	Off	L1	19.6	14.2	56.0
1.454000	43.8	Off	L1	19.6	12.2	56.0
1.510000	44.1	Off	L1	19.6	11.9	56.0
1.606000	45.9	Off	L1	19.6	10.1	56.0
1.670000	45.2	Off	L1	19.6	10.8	56.0
1.886000	45.1	Off	L1	19.6	10.9	56.0



Test Mode :	NFC Tx	Test Voltage :	120Vac / 60Hz
Function Type :	Bluetooth Link + WLAN (2.4GHz) Link + NFC Tx + Battery + Earphone + USB Cable (Charging from Adapter)		

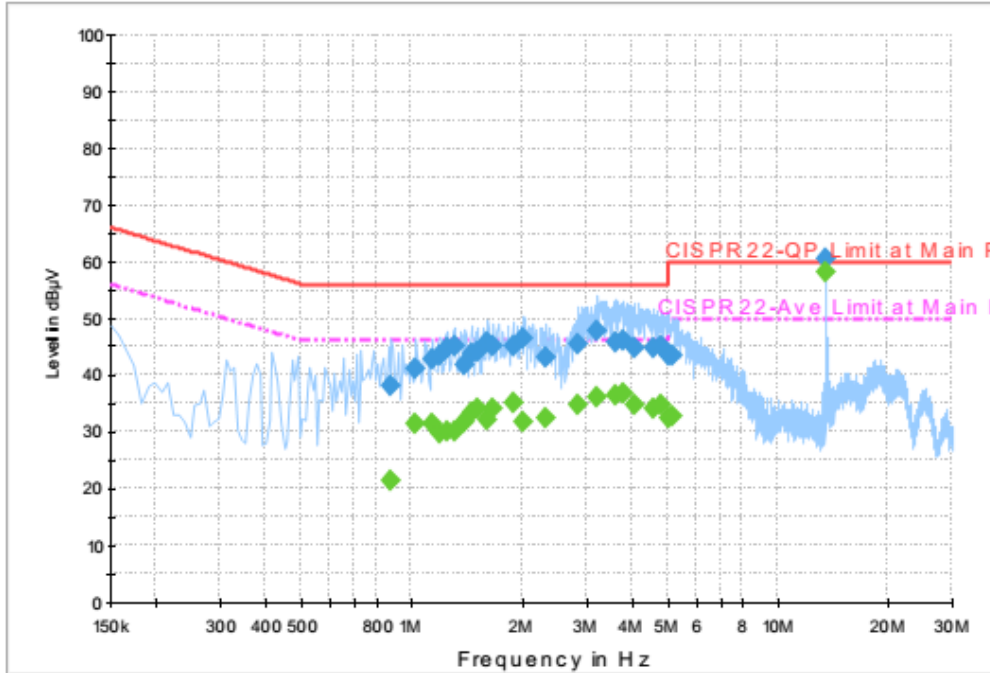

Final Result : Quasi-Peak

Frequency (MHz)	Quasi-Peak (dBµV)	Filter	Line	Corr. (dB)	Margin (dB)	Limit (dBµV)
2.022000	46.6	Off	L1	19.6	9.4	56.0
2.318000	43.0	Off	L1	18.9	13.0	56.0
2.846000	45.5	Off	L1	19.5	10.5	56.0
3.214000	47.8	Off	L1	19.6	8.2	56.0
3.598000	45.7	Off	L1	19.7	10.3	56.0
3.774000	46.0	Off	L1	19.7	10.0	56.0
4.070000	44.7	Off	L1	19.7	11.3	56.0
4.558000	44.8	Off	L1	19.7	11.2	56.0
4.790000	45.0	Off	L1	19.8	11.0	56.0
5.030000	43.4	Off	L1	19.8	16.6	60.0
5.174000	43.4	Off	L1	19.8	16.6	60.0
13.558000	60.5	Off	L1	20.2	-0.5	60.0



Test Mode :	NFC Tx	Test Voltage :	120Vac / 60Hz
Function Type :	Bluetooth Link + WLAN (2.4GHz) Link + NFC Tx + Battery + Earphone + USB Cable (Charging from Adapter)		

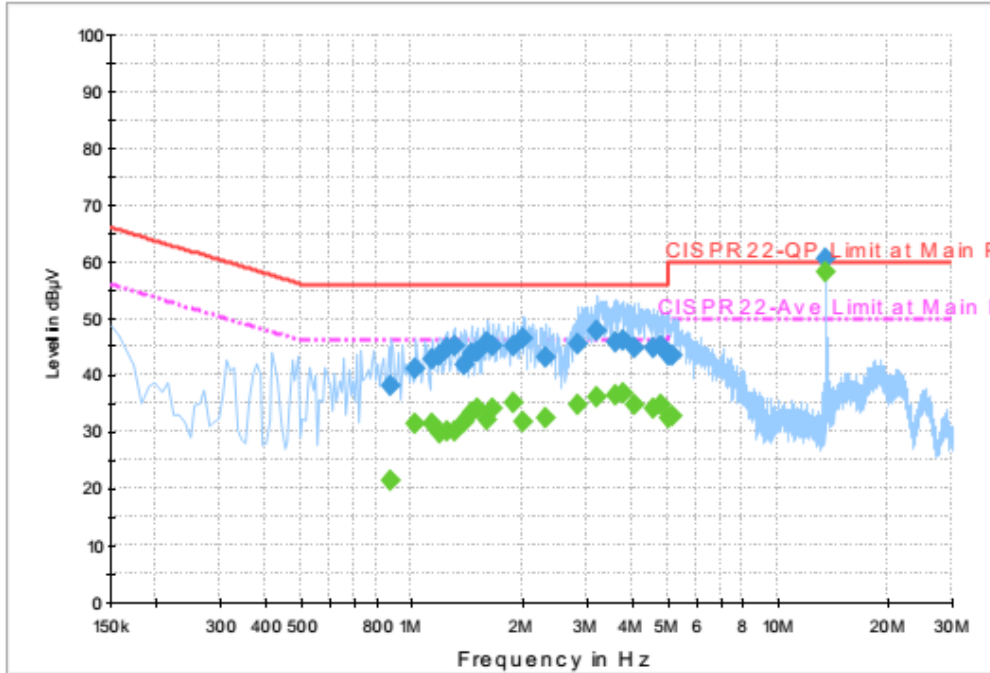

Final Result : Average

Frequency (MHz)	Average (dBµV)	Filter	Line	Corr. (dB)	Margin (dB)	Limit (dBµV)
0.878000	21.3	Off	L1	19.6	24.7	46.0
1.022000	31.3	Off	L1	19.6	14.7	46.0
1.134000	31.4	Off	L1	19.6	14.6	46.0
1.190000	29.7	Off	L1	19.6	16.3	46.0
1.246000	30.1	Off	L1	19.6	15.9	46.0
1.302000	30.2	Off	L1	19.6	15.8	46.0
1.398000	31.8	Off	L1	19.6	14.2	46.0
1.454000	33.4	Off	L1	19.6	12.6	46.0
1.510000	34.2	Off	L1	19.6	11.8	46.0
1.606000	32.1	Off	L1	19.6	13.9	46.0
1.670000	34.2	Off	L1	19.6	11.8	46.0
1.886000	35.1	Off	L1	19.6	10.9	46.0



Test Mode :	NFC Tx	Test Voltage :	120Vac / 60Hz
Function Type :	Bluetooth Link + WLAN (2.4GHz) Link + NFC Tx + Battery + Earphone + USB Cable (Charging from Adapter)		

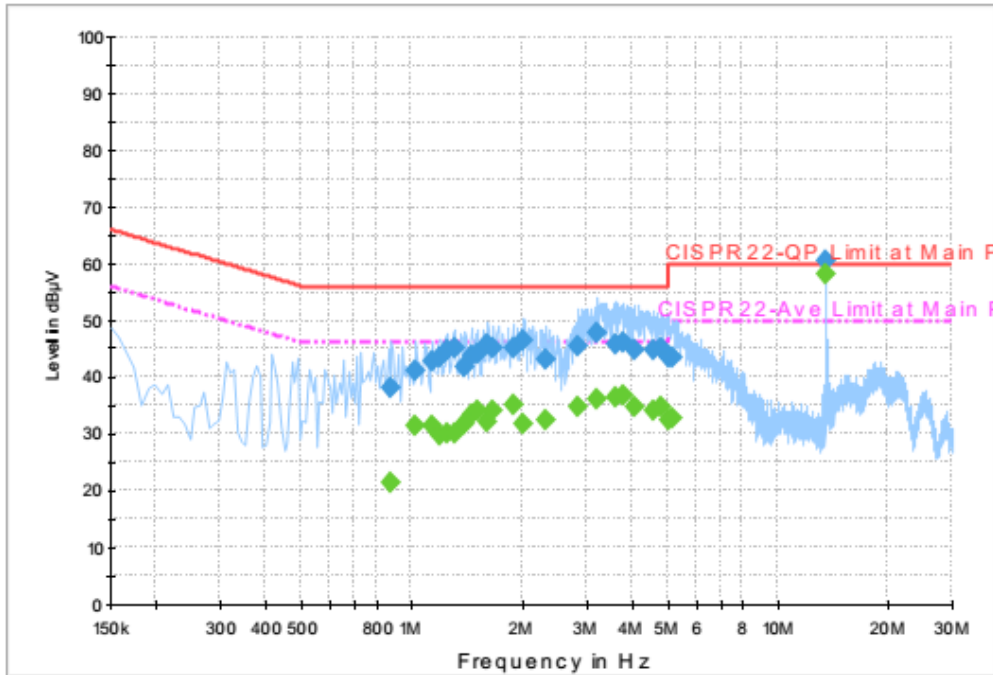

Final Result : Average

Frequency (MHz)	Average (dBµV)	Filter	Line	Corr. (dB)	Margin (dB)	Limit (dBµV)
2.022000	31.8	Off	L1	19.6	14.2	46.0
2.318000	32.5	Off	L1	18.9	13.5	46.0
2.846000	34.8	Off	L1	19.5	11.2	46.0
3.214000	36.0	Off	L1	19.6	10.0	46.0
3.598000	36.4	Off	L1	19.7	9.6	46.0
3.774000	36.8	Off	L1	19.7	9.2	46.0
4.070000	34.8	Off	L1	19.7	11.2	46.0
4.558000	34.0	Off	L1	19.7	12.0	46.0
4.790000	34.8	Off	L1	19.8	11.2	46.0
5.030000	32.5	Off	L1	19.8	17.5	50.0
5.174000	32.9	Off	L1	19.8	17.1	50.0
13.558000	58.1	Off	L1	20.2	-8.1	50.0



Test Mode :	NFC Tx	Test Voltage :	120Vac / 60Hz
Function Type :	Bluetooth Link + WLAN (2.4GHz) Link + NFC Tx + Battery + Earphone + USB Cable (Charging from Adapter)		

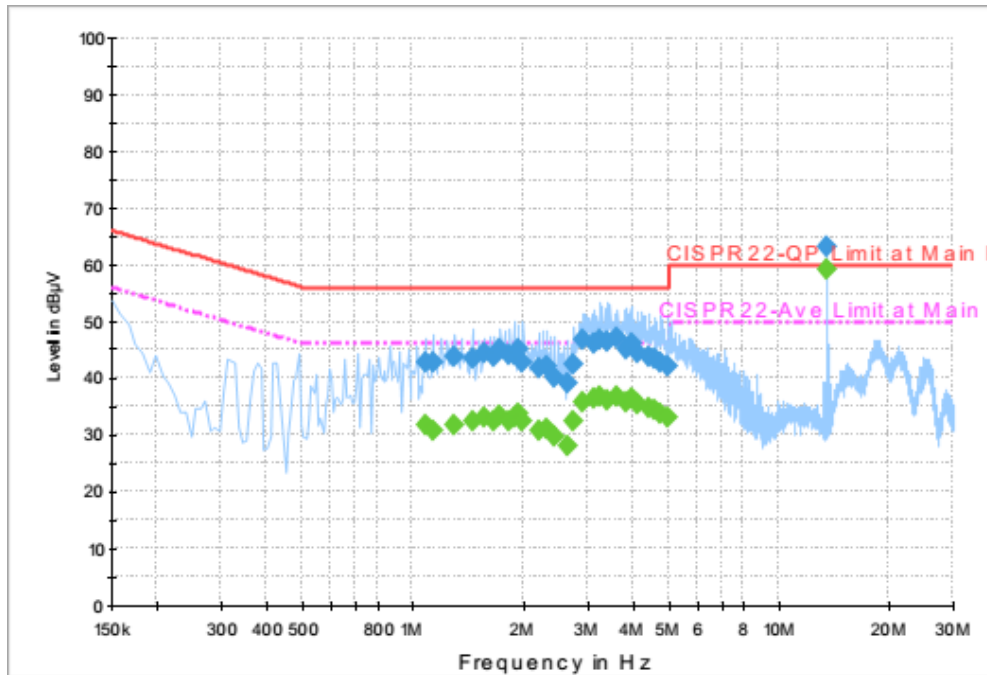

Final Result : Quasi-Peak

Frequency (MHz)	Quasi-Peak (dBµV)	Filter	Line	Corr. (dB)	Margin (dB)	Limit (dBµV)
1.078000	42.8	Off	N	19.6	13.2	56.0
1.134000	42.7	Off	N	19.6	13.3	56.0
1.294000	44.0	Off	N	19.6	12.0	56.0
1.454000	43.3	Off	N	19.6	12.7	56.0
1.566000	44.6	Off	N	19.6	11.4	56.0
1.670000	43.8	Off	N	19.6	12.2	56.0
1.726000	45.1	Off	N	19.6	10.9	56.0
1.838000	44.3	Off	N	19.6	11.7	56.0
1.886000	44.1	Off	N	19.6	11.9	56.0
1.942000	45.0	Off	N	19.6	11.0	56.0
1.990000	43.0	Off	N	19.6	13.0	56.0
2.206000	41.8	Off	N	18.6	14.2	56.0
2.318000	42.2	Off	N	18.9	13.8	56.0
2.422000	40.1	Off	N	19.1	15.9	56.0
2.638000	39.3	Off	N	19.4	16.7	56.0



Test Mode :	NFC Tx	Test Voltage :	120Vac / 60Hz
Function Type :	Bluetooth Link + WLAN (2.4GHz) Link + NFC Tx + Battery + Earphone + USB Cable (Charging from Adapter)		

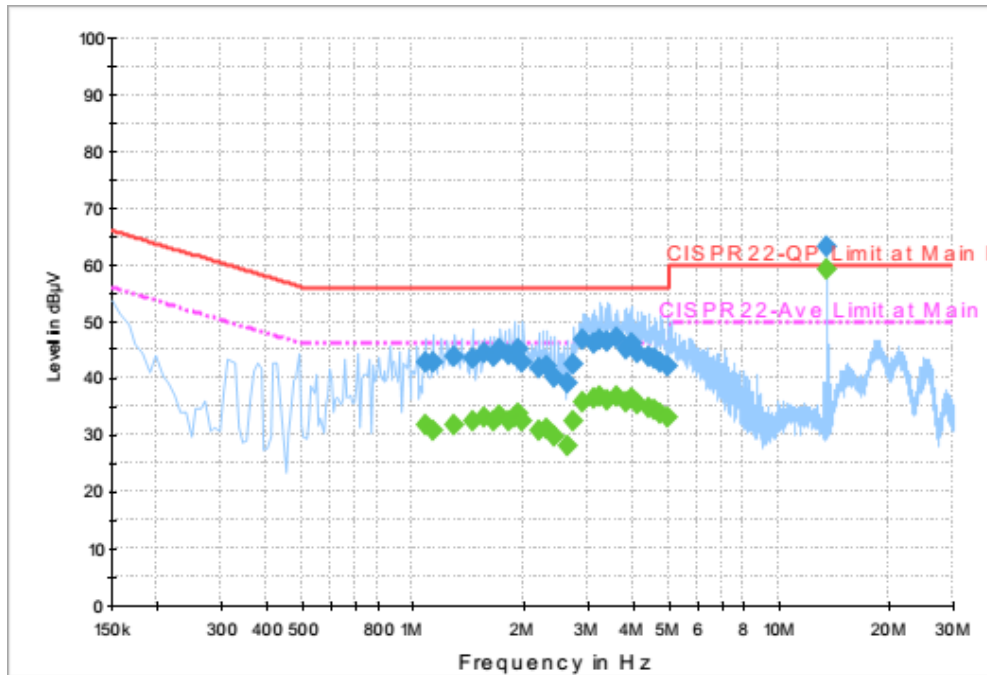

Final Result : Quasi-Peak

Frequency (MHz)	Quasi-Peak (dBµV)	Filter	Line	Corr. (dB)	Margin (dB)	Limit (dBµV)
2.750000	42.6	Off	N	19.4	13.4	56.0
2.918000	46.9	Off	N	19.5	9.1	56.0
3.126000	46.2	Off	N	19.6	9.8	56.0
3.238000	46.8	Off	N	19.6	9.2	56.0
3.398000	46.4	Off	N	19.6	9.6	56.0
3.622000	47.2	Off	N	19.7	8.8	56.0
3.822000	45.3	Off	N	19.7	10.7	56.0
3.942000	46.1	Off	N	19.7	9.9	56.0
4.094000	44.5	Off	N	19.7	11.5	56.0
4.414000	43.8	Off	N	19.7	12.2	56.0
4.582000	43.6	Off	N	19.7	12.4	56.0
4.734000	42.9	Off	N	19.7	13.1	56.0
4.950000	42.0	Off	N	19.8	14.0	56.0
13.558000	63.3	Off	N	20.3	-3.3	60.0



Test Mode :	NFC Tx	Test Voltage :	120Vac / 60Hz
Function Type :	Bluetooth Link + WLAN (2.4GHz) Link + NFC Tx + Battery + Earphone + USB Cable (Charging from Adapter)		

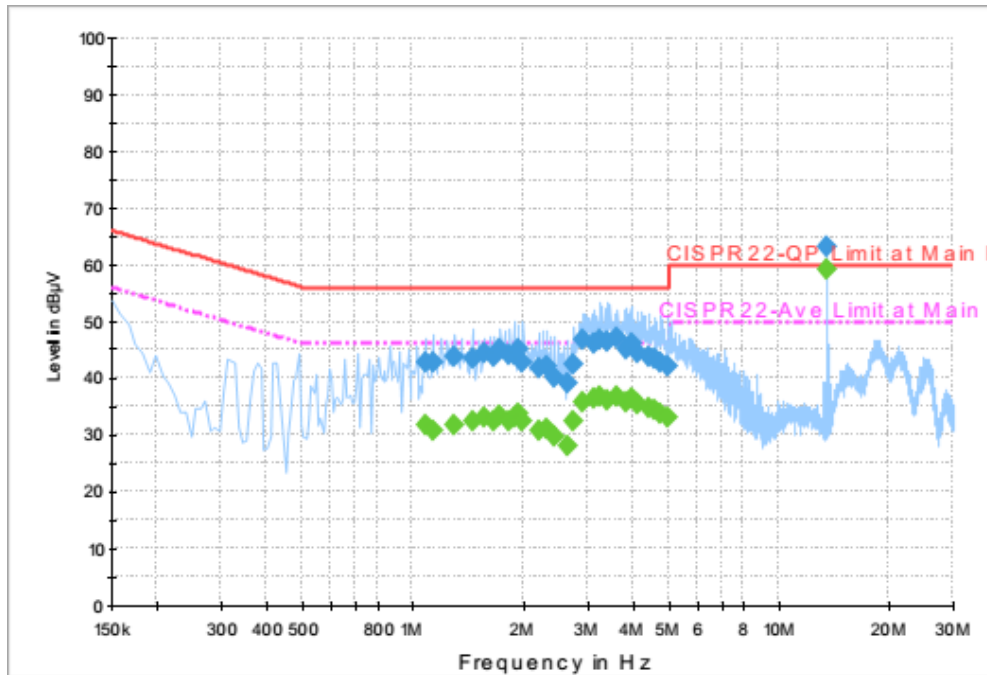

Final Result : Average

Frequency (MHz)	Average (dBµV)	Filter	Line	Corr. (dB)	Margin (dB)	Limit (dBµV)
1.078000	31.7	Off	N	19.6	14.3	46.0
1.134000	30.8	Off	N	19.6	15.2	46.0
1.294000	31.8	Off	N	19.6	14.2	46.0
1.454000	32.5	Off	N	19.6	13.5	46.0
1.566000	33.1	Off	N	19.6	12.9	46.0
1.670000	32.4	Off	N	19.6	13.6	46.0
1.726000	33.3	Off	N	19.6	12.7	46.0
1.838000	32.5	Off	N	19.6	13.5	46.0
1.886000	33.3	Off	N	19.6	12.7	46.0
1.942000	33.9	Off	N	19.6	12.1	46.0
1.990000	32.5	Off	N	19.6	13.5	46.0
2.206000	30.9	Off	N	18.6	15.1	46.0
2.318000	31.1	Off	N	18.9	14.9	46.0
2.422000	29.7	Off	N	19.1	16.3	46.0
2.638000	28.2	Off	N	19.4	17.8	46.0



Test Mode :	NFC Tx	Test Voltage :	120Vac / 60Hz
Function Type :	Bluetooth Link + WLAN (2.4GHz) Link + NFC Tx + Battery + Earphone + USB Cable (Charging from Adapter)		

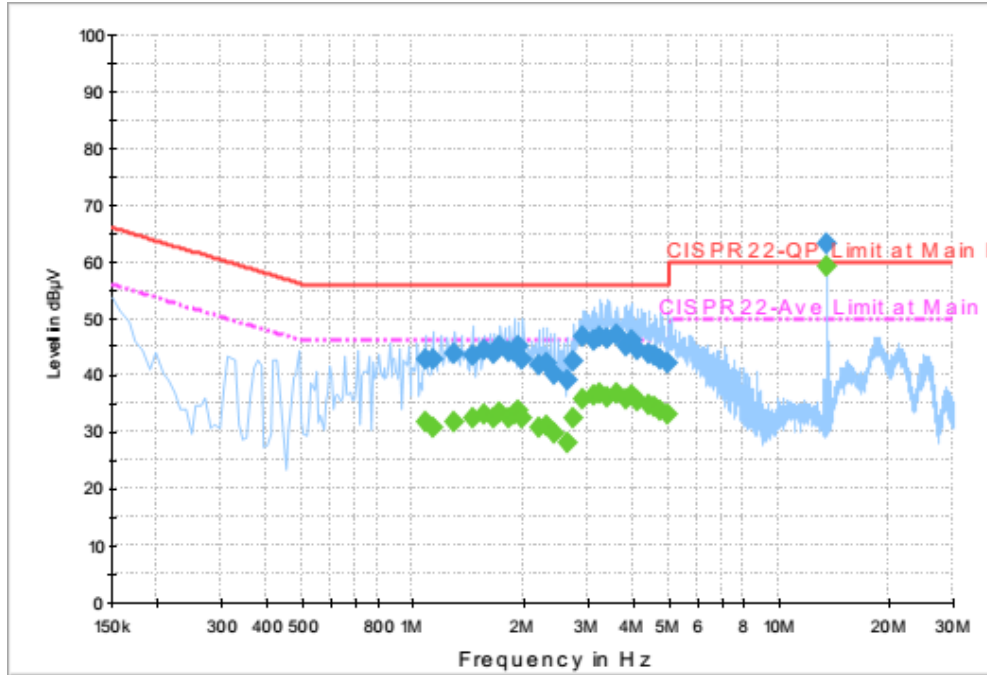

Final Result : Average

Frequency (MHz)	Average (dBµV)	Filter	Line	Corr. (dB)	Margin (dB)	Limit (dBµV)
2.750000	32.3	Off	N	19.4	13.7	46.0
2.918000	35.9	Off	N	19.5	10.1	46.0
3.126000	36.6	Off	N	19.6	9.4	46.0
3.238000	36.6	Off	N	19.6	9.4	46.0
3.398000	36.2	Off	N	19.6	9.8	46.0
3.622000	36.7	Off	N	19.7	9.3	46.0
3.822000	35.6	Off	N	19.7	10.4	46.0
3.942000	36.4	Off	N	19.7	9.6	46.0
4.094000	35.3	Off	N	19.7	10.7	46.0
4.414000	34.8	Off	N	19.7	11.2	46.0
4.582000	34.6	Off	N	19.7	11.4	46.0
4.734000	33.8	Off	N	19.7	12.2	46.0
4.950000	33.1	Off	N	19.8	12.9	46.0
13.558000	59.2	Off	N	20.3	-9.2	50.0



<Terminal test result with dummy load>

Test Mode :	NFC Tx	Test Voltage :	120Vac / 60Hz
Function Type :	Bluetooth Link + WLAN (2.4GHz) Link + NFC Tx + Battery + Earphone + USB Cable (Charging from Adapter)		

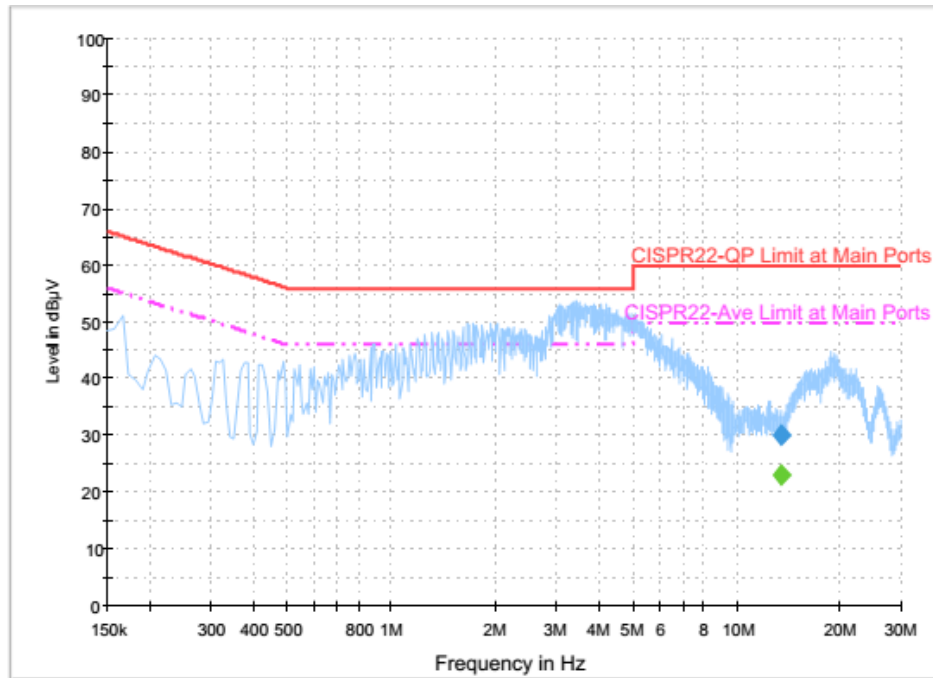

Final Result : Quasi-Peak

Frequency (MHz)	Quasi-Peak (dBµV)	Filter	Line	Corr. (dB)	Margin (dB)	Limit (dBµV)
13.558000	30.0	Off	L1	20.2	30.0	60.0

Final Result : Average

Frequency (MHz)	Average (dBµV)	Filter	Line	Corr. (dB)	Margin (dB)	Limit (dBµV)
13.558000	23.2	Off	L1	20.2	26.8	50.0



Test Mode :	NFC Tx	Test Voltage :	120Vac / 60Hz
Function Type :	Bluetooth Link + WLAN (2.4GHz) Link + NFC Tx + Battery + Earphone + USB Cable (Charging from Adapter)		

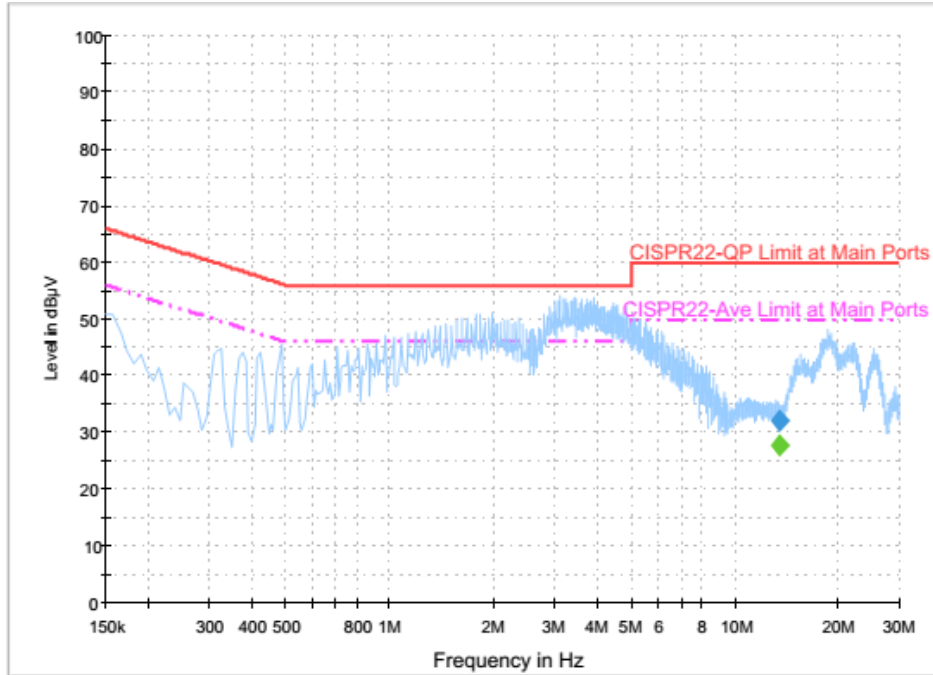

Final Result : Quasi-Peak

Frequency (MHz)	Quasi-Peak (dBµV)	Filter	Line	Corr. (dB)	Margin (dB)	Limit (dBµV)
13.558000	32.2	Off	N	20.3	27.8	60.0

Final Result : Average

Frequency (MHz)	Average (dBµV)	Filter	Line	Corr. (dB)	Margin (dB)	Limit (dBµV)
13.558000	27.7	Off	N	20.3	22.3	50.0

(1) with antenna

Remark: 13.558 MHz is the NFC RF fundamental signal.

(2) with dummy load

Remark: Only the fundamental NFC signal needs to be retested per C63.4.



Appendix B. Test Results of Conducted Test Items

B1. Test Result of 20dB Spectrum Bandwidth

Test mode	NFC Tx	Test Frequency (MHz)	13.56
Date: 31.AUG.2017 10:24:02		Date: 31.AUG.2017 10:31:12	
20dB Bandwidth (kHz)	2.640	99% OccupiedBW(kHz)	2.240
Frequency range (MHz)	$f_L > 13.553$	13.55946	Test Result
	$f_H < 13.567$	13.56210	Complies

Remark:

Because the measured signal is CW adjusting the RBW per C63.10 would not be practical since measured bandwidth will always follow the RBW and the result will be approximately twice the RBW



B2. Test Result of Frequency Stability

B3. Voltage vs. Frequency Stability		Temperature vs. Frequency Stability		
Voltage (Vac)	Measurement Frequency (MHz)	Temperature (°C)	Time	Measurement Frequency (MHz)
120	13.560760	-20	0	13.560980
102	13.560750		2	13.560990
138	13.560760		5	13.560990
			10	13.560990
		-10	0	13.560920
			2	13.560920
			5	13.560920
			10	13.560940
		0	0	13.560940
			2	13.560950
			5	13.560940
			10	13.560940
		10	0	13.560930
			2	13.560920
			5	13.560910
			10	13.560900
		20	0	13.560880
			2	13.560860
			5	13.560860
			10	13.560840
		30	0	13.560820
			2	13.560800
			5	13.560780
			10	13.560760
		40	0	13.560750
			2	13.560740
			5	13.560720
			10	13.560720



Voltage vs. Frequency Stability		Temperature vs. Frequency Stability		
Voltage (Vac)	Measurement Frequency (MHz)	Temperature (°C)	Time	Measurement Frequency (MHz)
		50	0	13.560700
			2	13.560680
			5	13.560670
			10	13.560660
Max.Deviation (MHz)	0.000760	Max.Deviation (MHz)		0.000990
Max.Deviation (ppm)	56.0472	Max.Deviation (ppm)		73.0088
Limit	FS < ±100 ppm	Limit		FS < ±100 ppm
Test Result	PASS	Test Result		PASS



Appendix C. Test Results of Radiated Test Items

C1. Test Result of Field Strength of Fundamental Emissions

Test Mode :	NFC Tx	Test Frequency (MHz)	13.56
--------------------	--------	-----------------------------	-------

Date: 2017-08-24

Site : 03CH11-HY
 Condition : 15.225 3m LOOP_ANT(H) HORIZONTAL
 : RBW:9.000KHz VBW:9.000KHz SWT:Auto
 Project : 782113

Over	Limit	ReadAntenna	Cable	A/Pos	T/Pos	Remark				
Freq	Level	Limit	Line	Level	Factor	Loss	cm	deg		
MHz	dBuV/m	dB	dBuV/m	dBuV	dB/m	dB				
1	13.56	60.71	-63.29	124.00	40.31	20.14	0.26	100	187	QP

Date: 2017-08-24

Site : 03CH11-HY
 Condition : 15.225 3m LOOP_ANT(V) VERTICAL
 : RBW:9.000KHz VBW:9.000KHz SWT:Auto
 Project : 782113

Over	Limit	ReadAntenna	Cable	A/Pos	T/Pos	Remark				
Freq	Level	Limit	Line	Level	Factor	Loss	cm	deg		
MHz	dBuV/m	dB	dBuV/m	dBuV	dB/m	dB				
1	13.56	60.62	-63.38	124.00	40.22	20.14	0.26	100	278	QP



C2. Results of Radiated Spurious Emissions (9 kHz~30MHz)

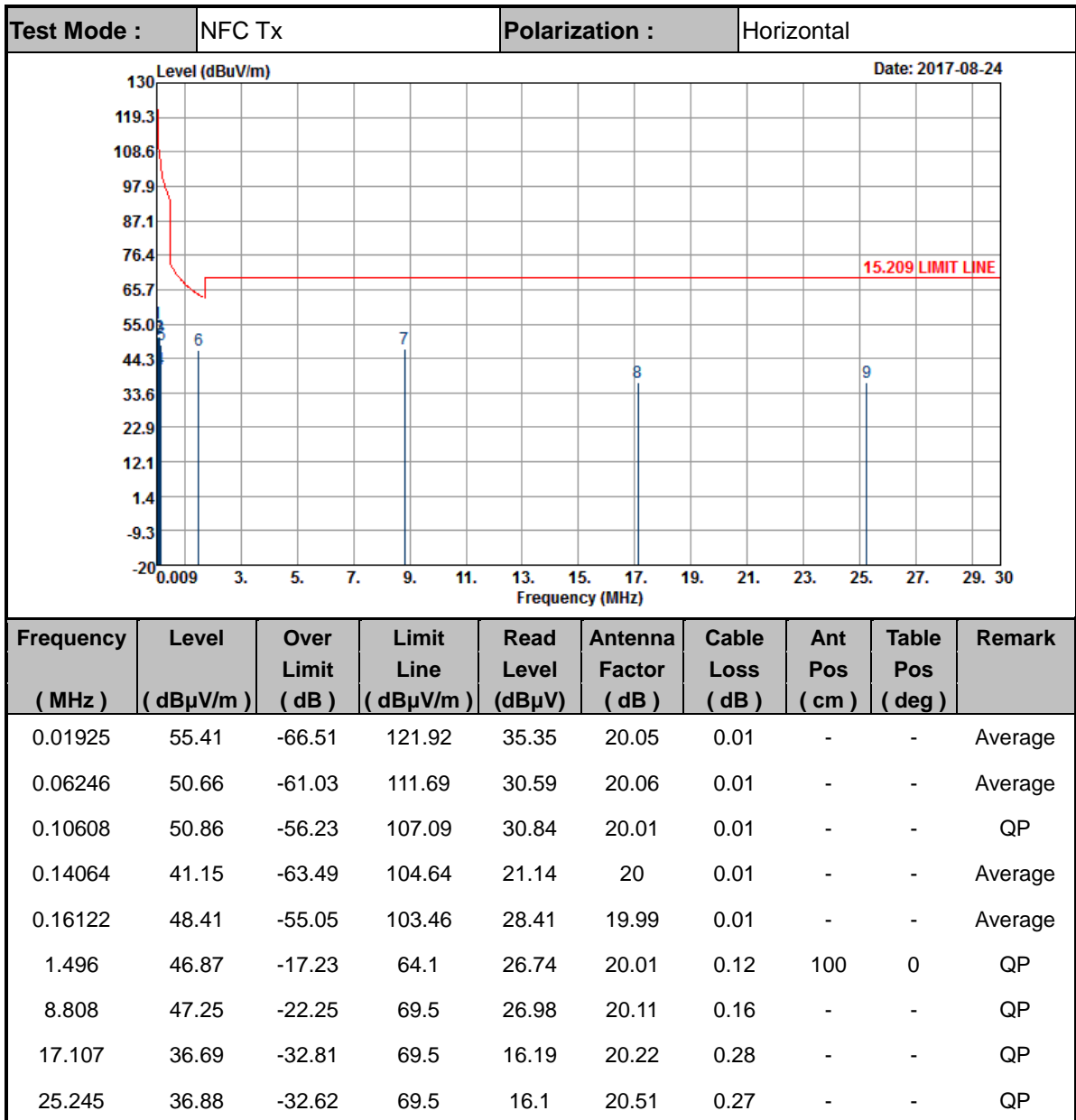

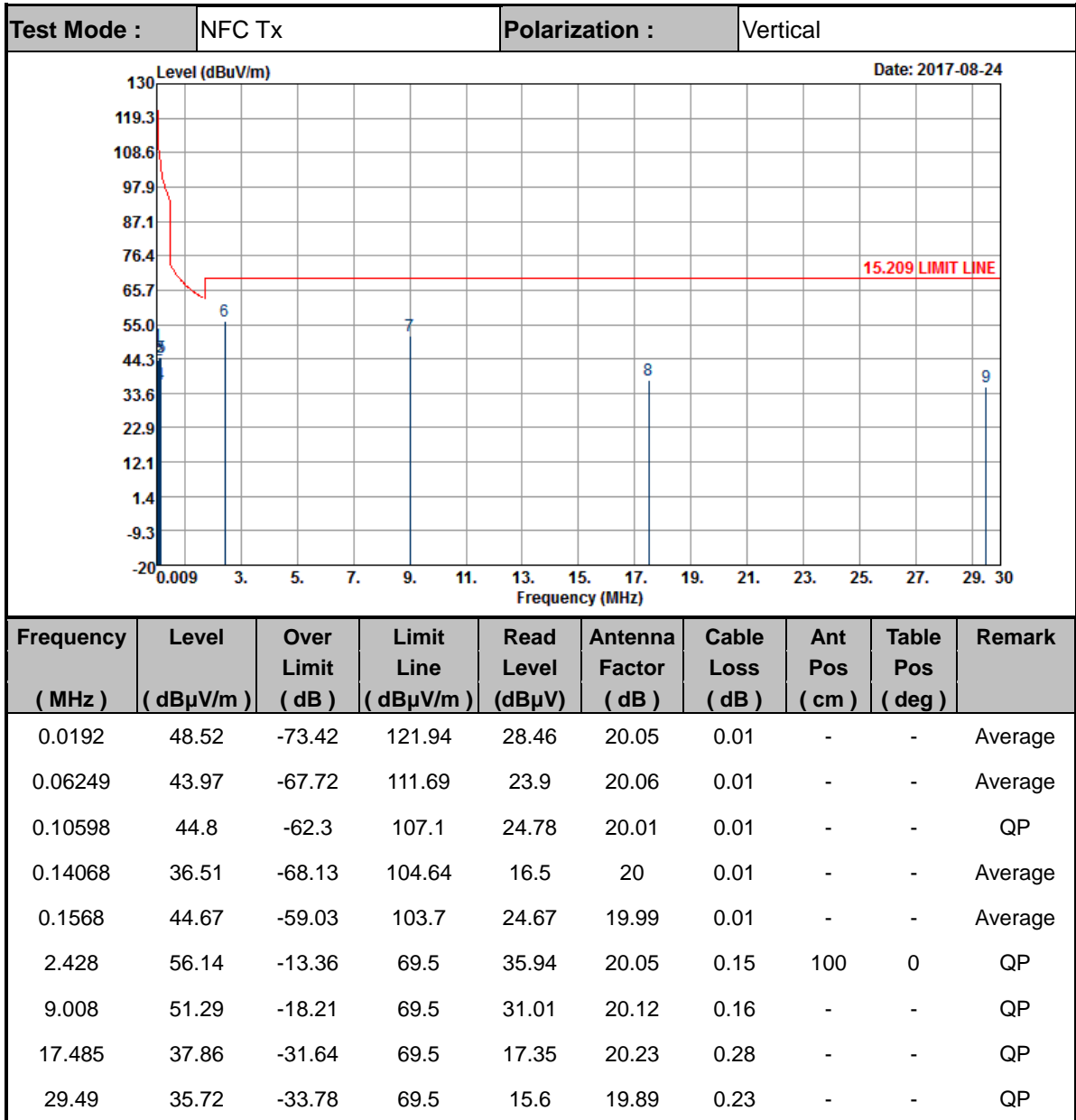

Note:

1. The amplitude of spurious emissions which are attenuated by more than 20dB below the permissible value has no need to be reported.
2. Distance extrapolation factor = 40 log (specific distance / test distance) (dB);
3. Limit line = specific limits (dBuV) + distance extrapolation factor.



C3. Results of Radiated Spurious Emissions (30MHz~1GHz)

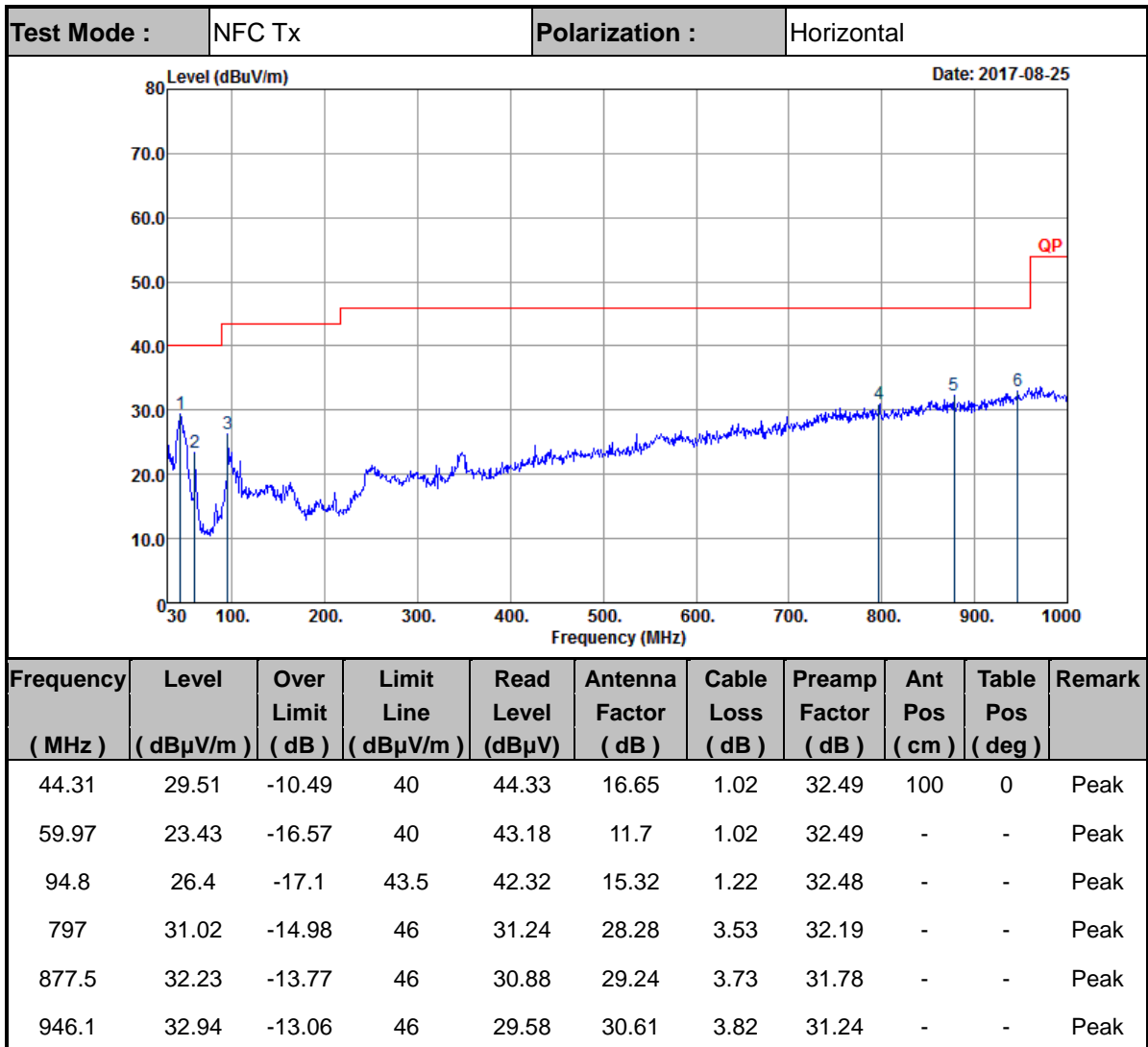

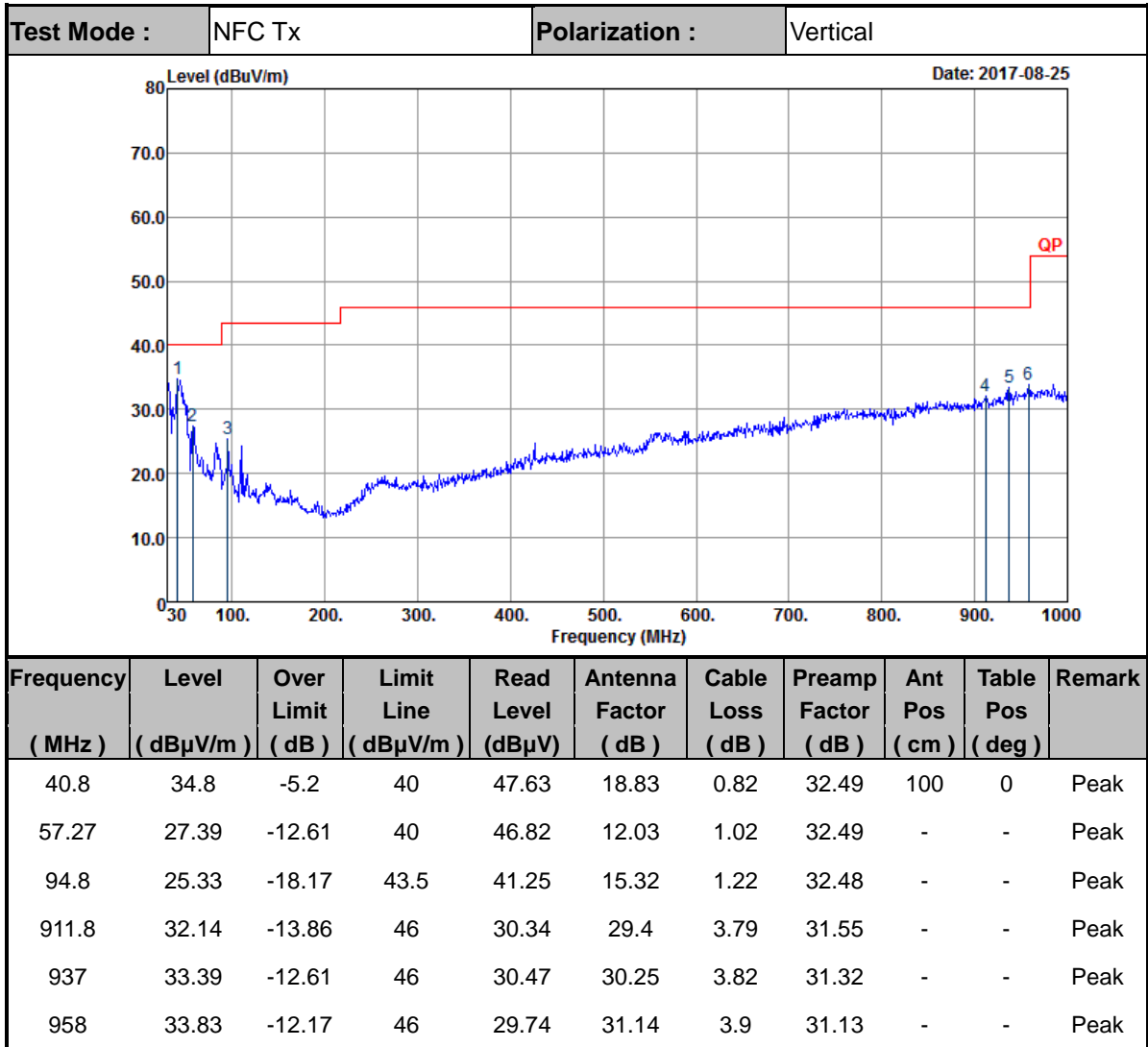

Note:

1. The amplitude of spurious emissions which are attenuated by more than 20dB below the permissible value has no need to be reported.
2. Emission level (dBμV/m) = 20 log Emission level (μV/m).
3. Corrected Reading: Antenna Factor + Cable Loss + Read Level - Preamp Factor= Level.