



# FCC RF Test Report

**APPLICANT** : Sony Mobile Communications Inc.  
**EQUIPMENT** : GSM/WCDMA/LTE Phone+Bluetooth, DTS/UNII  
a/b/g/n and NFC  
**BRAND NAME** : Sony  
**FCC ID** : PY7-35228S  
**STANDARD** : FCC Part 15 Subpart E §15.407  
**CLASSIFICATION** : (NII) Unlicensed National Information Infrastructure

The product was received on Aug. 21, 2017 and testing was completed on Sep. 14, 2017. We, SPORTON INTERNATIONAL INC., would like to declare that the tested sample has been evaluated in accordance with the test procedures and has been in compliance with the applicable technical standards.

The test results in this report apply exclusively to the tested model / sample. Without written approval of SPORTON INTERNATIONAL INC., the test report shall not be reproduced except in full.

Reviewed by: Joseph Lin / Supervisor

Approved by: Jones Tsai / Manager



Testing Laboratory  
1190

## **SPORTON INTERNATIONAL INC.**

No. 52, Hwa Ya 1<sup>st</sup> Rd., Hwa Ya Technology Park, Kwei-Shan District, Tao Yuan City, Taiwan, R.O.C.



# TABLE OF CONTENTS

**REVISION HISTORY..... 3**

**SUMMARY OF TEST RESULT ..... 4**

**1 GENERAL DESCRIPTION ..... 5**

    1.1 Applicant ..... 5

    1.2 Manufacturer ..... 5

    1.3 Product Feature of Equipment Under Test ..... 5

    1.4 Modification of EUT ..... 6

    1.5 Testing Location ..... 7

    1.6 Applicable Standards ..... 7

**2 TEST CONFIGURATION OF EQUIPMENT UNDER TEST ..... 8**

    2.1 Carrier Frequency and Channel ..... 8

    2.2 Test Mode ..... 9

    2.3 Connection Diagram of Test System ..... 10

    2.4 Support Unit used in test configuration and system ..... 11

    2.5 EUT Operation Test Setup ..... 11

    2.6 Measurement Results Explanation Example ..... 11

**3 TEST RESULT ..... 12**

    3.1 6dB and 26dB and 99% Occupied Bandwidth Measurement ..... 12

    3.2 Maximum Conducted Output Power Measurement ..... 15

    3.3 Power Spectral Density Measurement ..... 16

    3.4 Unwanted Emissions Measurement ..... 18

    3.5 AC Conducted Emission Measurement ..... 24

    3.6 Frequency Stability Measurement ..... 26

    3.7 Automatically Discontinue Transmission ..... 27

    3.8 Antenna Requirements ..... 28

**4 LIST OF MEASURING EQUIPMENT ..... 29**

**5 UNCERTAINTY OF EVALUATION ..... 31**

**APPENDIX A. CONDUCTED TEST RESULTS**

**APPENDIX B. AC CONDUCTED EMISSION TEST RESULT**

**APPENDIX C. RADIATED SPURIOUS EMISSION**

**APPENDIX D. RADIATED SPURIOUS EMISSION PLOTS**

**APPENDIX E. DUTY CYCLE PLOTS**



### REVISION HISTORY

REPORT NO.	VERSION	DESCRIPTION	ISSUED DATE
FR782113F	Rev. 01	Initial issue of report	Oct. 30, 2017



### SUMMARY OF TEST RESULT

Report Section	FCC Rule	Description	Limit	Result	Remark
3.1	15.403(i)	6dB, 26dB and 99% Occupied Bandwidth	> 500kHz	Pass	-
3.2	15.407(a)	Maximum Conducted Output Power	≤ 30 dBm	Pass	-
3.3	15.407(a)	Power Spectral Density	≤ 30 dBm/500kHz	Pass	-
3.4	15.407(b)	Unwanted Emissions	15.407(b)(4)(i) & 15.209(a)	Pass	Under limit 4.03 dB at 43.230 MHz
3.5	15.207	AC Conducted Emission	15.207(a)	Pass	Under limit 8.00 dB at 3.014 MHz
3.6	15.407(g)	Frequency Stability	Within Operation Band	Pass	-
3.7	15.407(c)	Automatically Discontinue Transmission	Discontinue Transmission	Pass	-
3.8	15.203 & 15.407(a)	Antenna Requirement	N/A	Pass	-



# 1 General Description

## 1.1 Applicant

**Sony Mobile Communications Inc.**

4-12-3 Higashi-Shinagawa, Shinagawa-ku, Tokyo, 140-0002, Japan

## 1.2 Manufacturer

**Sony Mobile Communications Inc.**

4-12-3 Higashi-Shinagawa, Shinagawa-ku, Tokyo, 140-0002, Japan

## 1.3 Product Feature of Equipment Under Test

GSM/WCDMA/LTE, Bluetooth, DTS/UNII a/b/g/n, FM Receiver, NFC, and GPS.

Standards-related Product Specification	
Antenna Type	PIFA Antenna with gain -0.60 dBi

EUT Information List			
HW Version	SW Version	S/N	Performed Test Item
A	1.8	WUJ01Q223V	RF conducted measurement
		WUJ01Q2211	Radiated Spurious Emission
		WUJ01Q223T	AC Conducted Emission



Accessory List	
AC Adapter	Model Name: EP800
	S/N: 2916W46610569 (for radiated emission) 3015W41612282 (for conducted emission)
Earphone	Model Name: MH410c
	S/N: N/A
USB Cable	Model Name: UCB20
	S/N: 1635A91C00314D8 (for radiated emission) 1635A9100031498 (for conducted emission)

**Note:**

1. Above EUT list and accessory list used are electrically identical per declared by manufacturer.
2. Above the accessories list are used to exercise the EUT during test.
3. For other wireless features of this EUT, test report will be issued separately.

### 1.4 Modification of EUT

No modifications are made to the EUT during all test items.



### 1.5 Testing Location

Sporton Lab is accredited to ISO 17025 by Taiwan Accreditation Foundation (TAF code : 1190) and the FCC designation No. TW1190 and TW0007 under the FCC 2.948(e) by Mutual Recognition Agreement (MRA) in FCC Test.

<b>Test Site</b>	SPORTON INTERNATIONAL INC.	
<b>Test Site Location</b>	No. 52, Hwa Ya 1 <sup>st</sup> Rd., Hwa Ya Technology Park, Kwei-Shan District, Tao Yuan City, Taiwan, R.O.C. TEL: +886-3-327-3456 FAX: +886-3-328-4978	
<b>Test Site No.</b>	<b>Sporton Site No.</b>	
	TH05-HY	CO05-HY

**Note:** The test site complies with ANSI C63.4 2014 requirement.

<b>Test Site</b>	SPORTON INTERNATIONAL INC.	
<b>Test Site Location</b>	No.58, Aly. 75, Ln. 564, Wenhua 3rd Rd. Guishan Dist, Taoyuan City, Taiwan (R.O.C.) TEL: +886-3-327-0868 FAX: +886-3-327-0855	
<b>Test Site No.</b>	<b>Sporton Site No.</b>	
	03CH10-HY	

**Note:** The test site complies with ANSI C63.4 2014 requirement.

### 1.6 Applicable Standards

According to the specifications of the manufacturer, the EUT must comply with the requirements of the following standards:

- ♦ FCC Part 15 Subpart E
- ♦ FCC KDB 789033 D02 General UNII Test Procedures New Rules v01r04.
- ♦ ANSI C63.10-2013

**Remark:**

1. All test items were verified and recorded according to the standards and without any deviation during the test.
2. This EUT has also been tested and complied with the requirements of FCC Part 15, Subpart B, recorded in a separate test report.



## 2 Test Configuration of Equipment Under Test

- a. The EUT has been associated with peripherals and configuration operated in a manner tended to maximize its emission characteristics in a typical application. Frequency range investigated: conduction emission (150 kHz to 30 MHz), radiation emission (9 kHz to the 10th harmonic of the highest fundamental frequency or to 40 GHz, whichever is lower). For radiated measurement, pre-scanned in three orthogonal panels, X, Y, Z. The worst cases (Y plane) were recorded in this report.
  
- b. AC power line Conducted Emission was tested under maximum output power.

### 2.1 Carrier Frequency and Channel

Frequency Band	Channel	Freq. (MHz)	Channel	Freq. (MHz)
5725-5850 MHz Band 4 (U-NII-3)	149	5745	157	5785
	151*	5755	159*	5795
	153	5765	161	5805
	-	-	165	5825

**Note:** The above Frequency and Channel in "\*" were 802.11n HT40.





## 2.2 Test Mode

Final test mode of conducted test items and radiated spurious emissions are considering the modulation and worse data rates as below table.

Modulation	Data Rate
802.11a	6 Mbps
802.11n HT20	MCS0
802.11n HT40	MCS0

Test Cases	
AC Conducted Emission	Mode 1 : Bluetooth Link + WLAN (5GHz) Link + Earphone + Battery + USB Cable (Charging from Adapter)

Ch. #	Band IV : 5725-5850 MHz		
	802.11a	802.11n HT20	802.11n HT40
L Low	149	149	151
M Middle	157	157	-
H High	165	165	159

## 2.3 Connection Diagram of Test System

### <WLAN Tx Mode>

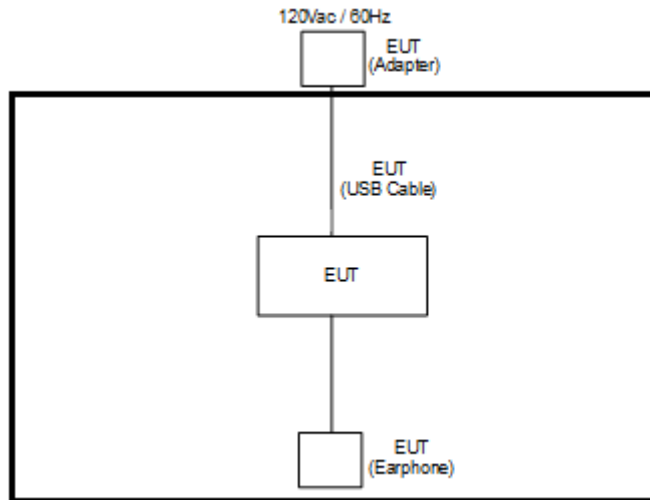

### <AC Conducted Emission Mode>

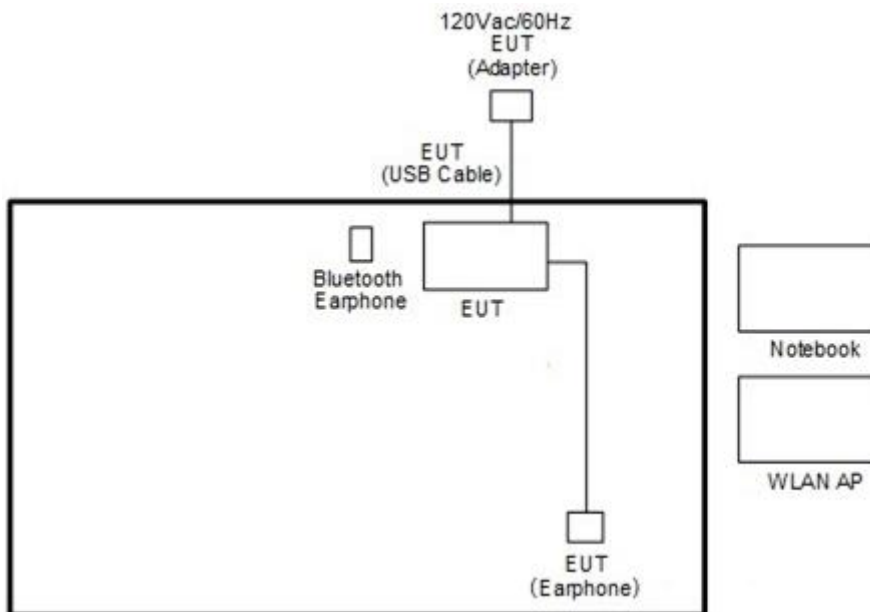



## 2.4 Support Unit used in test configuration and system

Item	Equipment	Trade Name	Model Name	FCC ID	Data Cable	Power Cord
1.	Bluetooth Earphone	Sony	SBH20	PY7-RD0010	N/A	N/A
2.	WLAN AP	ASUS	RT-AC66U	MSQ-RTAC66U	N/A	Unshielded, 1.8 m
3.	Notebook	DELL	Latitude E6320	FCC DoC/ Contains FCC ID: QDS-BRCM1054	N/A	AC I/P: Unshielded, 1.2 m DC O/P: Shielded, 1.8 m
4.	SD Card	SanDisk	MicroSD HC	FCC DoC	N/A	N/A

## 2.5 EUT Operation Test Setup

The RF test items, an engineering test program was provided and enabled to make EUT continuous transmit.

## 2.6 Measurement Results Explanation Example

For all conducted test items:

The offset level is set in the spectrum analyzer to compensate the RF cable loss and attenuator factor between EUT conducted output port and spectrum analyzer. With the offset compensation, the spectrum analyzer reading level is exactly the EUT RF output level.

Example :

The spectrum analyzer offset is derived from RF cable loss and attenuator factor.

*Offset = RF cable loss + attenuator factor.*

Following shows an offset computation example with cable loss 4.2 dB and 10dB attenuator.

$$\begin{aligned}
 \text{Offset(dB)} &= \text{RF cable loss(dB)} + \text{attenuator factor(dB)}. \\
 &= 4.2 + 10 = 14.2 \text{ (dB)}
 \end{aligned}$$

### 3 Test Result

#### 3.1 6dB and 26dB and 99% Occupied Bandwidth Measurement

##### 3.1.1 Description of 6dB and 26dB and 99% Occupied Bandwidth

The minimum 6 dB bandwidth shall be at least 500 kHz.

26dB and 99% Occupied bandwidth are reporting only.

##### 3.1.2 Measuring Instruments

The measuring equipment is listed in the section 4 of this test report.

##### 3.1.3 Test Procedures

1. The testing follows FCC KDB 789033 D02 General UNII Test Procedures New Rules v01r04.  
Section C) Emission bandwidth for the band 5.725-5.85GHz
2. Set RBW = 100kHz.
3. Set the VBW  $\geq 3 \times$  RBW.
4. Detector = Peak.
5. Trace mode = max hold
6. Measure the maximum width of the emission that is 6 dB down from the peak of the emission.
7. Measure and record the results in the test report.

##### 3.1.4 Test Setup

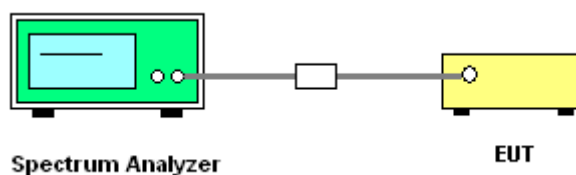



### 3.1.5 Test Result of 6dB Bandwidth

Please refer to Appendix A.

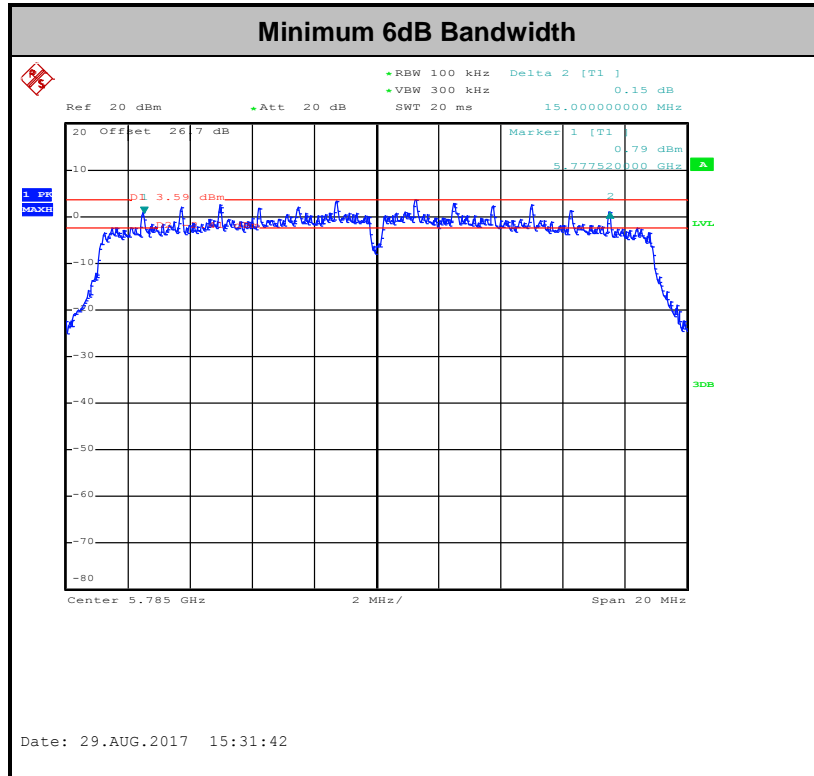

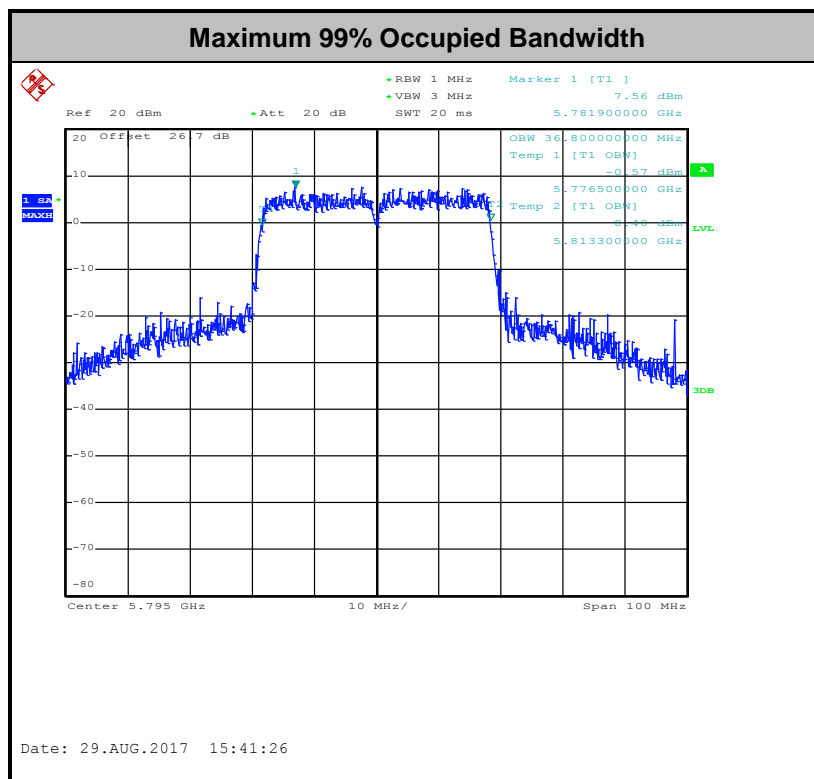
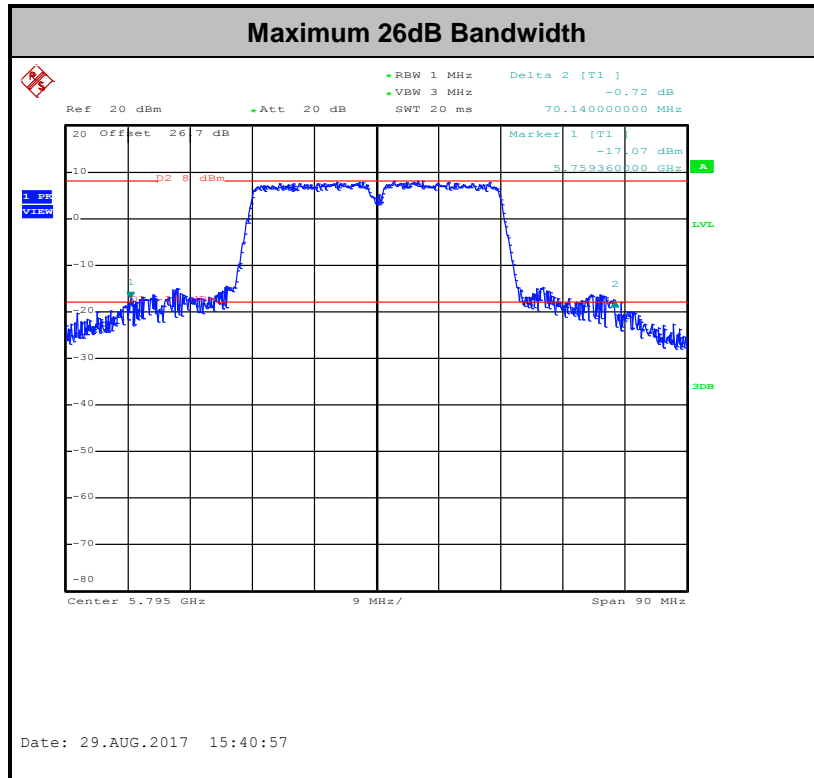

**Note:** The occupied channel bandwidth is maintained within the band of operation for all of the modulations.

## 3.2 Maximum Conducted Output Power Measurement

### 3.2.1 Limit of Maximum Conducted Output Power

For the band 5.725–5.85 GHz, the maximum conducted output power over the frequency band of operation shall not exceed 1 W.

If transmitting antennas of directional gain greater than 6 dBi are used, the peak output power shall be reduced by the amount in dB that the directional gain of the antenna exceeds 6 dBi.

### 3.2.2 Measuring Instruments

The measuring equipment is listed in the section 4 of this test report.

### 3.2.3 Test Procedures

The testing follows Method PM of FCC KDB 789033 D02 General UNII Test Procedures New Rules v01r04.

Method PM (Measurement using an RF average power meter):

1. Measurement is performed using a wideband RF power meter.
2. The EUT is configured to transmit continuously with a consistent duty cycle at its maximum power control level.
3. Measure the average power of the transmitter, and the average power is corrected with duty factor,  $10 \log(1/x)$ , where  $x$  is the duty cycle.

### 3.2.4 Test Setup

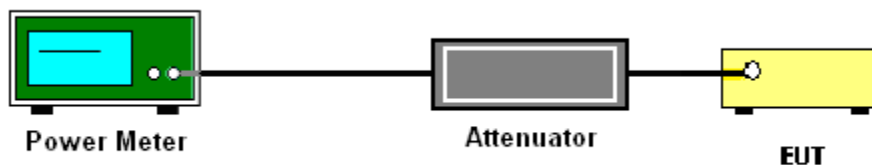

### 3.2.5 Test Result of Maximum Conducted Output Power

Please refer to Appendix A.



### 3.3 Power Spectral Density Measurement

#### 3.3.1 Limit of Power Spectral Density

For the band 5.725–5.85 GHz, the maximum power spectral density shall not exceed 30 dBm in any 500-kHz band.

If transmitting antennas of directional gain greater than 6 dBi are used, the peak output power shall be reduced by the amount in dB that the directional gain of the antenna exceeds 6 dBi.

#### 3.3.2 Measuring Instruments

The measuring equipment is listed in the section 4 of this test report.

#### 3.3.3 Test Procedures

The testing follows FCC KDB 789033 D02 General UNII Test Procedures New Rules v01r04. Section F) Maximum power spectral density.

##### # Method SA-2 #

(trace averaging across on and off times of the EUT transmissions, followed by duty cycle correction).

- Measure the duty cycle.
  - Set span to encompass the entire emission bandwidth (EBW) of the signal.
  - Set RBW = 300 kHz.
  - Set VBW  $\geq$  1 MHz.
  - Number of points in sweep  $\geq$  2 Span / RBW.
  - Sweep time = auto.
  - Detector = RMS
  - Trace average at least 100 traces in power averaging mode.
  - Add  $10 \log(500\text{kHz}/\text{RBW})$  to the test result.
  - Add  $10 \log(1/x)$ , where  $x$  is the duty cycle, to the measured power in order to compute the average power during the actual transmission times. For example, add  $10 \log(1/0.25) = 6$  dB if the duty cycle is 25 percent.
1. The RF output of EUT was connected to the spectrum analyzer by a low loss cable.
  2. Each plot has already offset with cable loss, and attenuator loss. Measure the PPSD and record it.



### 3.3.4 Test Setup

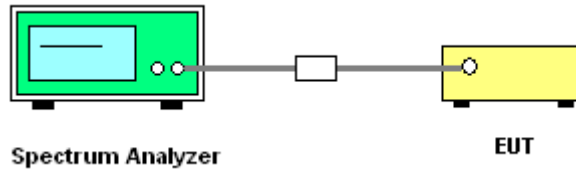

### 3.3.5 Test Result of Power Spectral Density

Please refer to Appendix A.

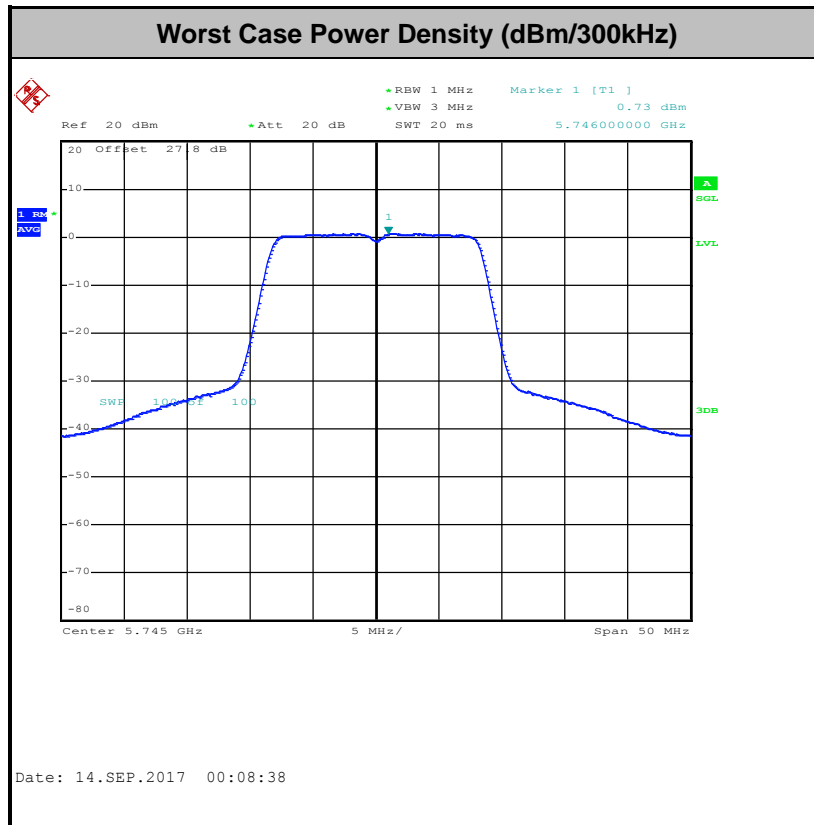



### 3.4 Unwanted Emissions Measurement

This section is to measure unwanted emissions through radiated measurement for band edge spurious emissions and out of band emissions measurement.

#### 3.4.1 Limit of Unwanted Emissions

(1) For transmitters operating in the 5.725-5.85 GHz band:

15.407(b)(4)(i) All emissions shall be limited to a level of -27 dBm/MHz at 75 MHz or more above or below the band edge increasing linearly to 10 dBm/MHz at 25 MHz above or below the band edge, and from 25 MHz above or below the band edge increasing linearly to a level of 15.6 dBm/MHz at 5 MHz above or below the band edge, and from 5 MHz above or below the band edge increasing linearly to a level of 27 dBm/MHz at the band edge.

(2) Unwanted spurious emissions fallen in restricted bands shall comply with the general field strength limits as below table,

Frequency (MHz)	Field Strength (microvolts/meter)	Measurement Distance (meters)
0.009 – 0.490	2400/F(kHz)	300
0.490 – 1.705	24000/F(kHz)	30
1.705 – 30.0	30	30
30 – 88	100	3
88 – 216	150	3
216 - 960	200	3
Above 960	500	3

**Note:** The following formula is used to convert the EIRP to field strength.

$$E = \frac{1000000\sqrt{30P}}{3} \mu\text{V/m, where P is the eirp (Watts)}$$



EIRP (dBm)	Field Strength at 3m (dBµV/m)
-17	78.3
- 27	68.3

(3) KDB789033 D02 v01r04 G)2)c)

- (i) Sections 15.407(b)(1) to (b)(3) specify the unwanted emission limits for the U-NII-1 and U-NII-2 bands. As specified, emissions above 1000 MHz that are outside of the restricted bands are subject to a peak emission limit of -27 dBm/MHz.<sup>3</sup>
- (ii) Section 15.407(b)(4) specifies the unwanted emission limit for the U-NII-3 band. A band emissions mask is specified in Section 15.407(b)(4)(i). The emission limits are in terms of a Peak detector. An alternative to the band emissions mask is specified in Section 15.407(b)(4)(ii). The alternative limits are based on the highest antenna gain specified in the filing. There are also marketing and importation restrictions for the devices using the alternative limit.<sup>4</sup>

**Note 3:** An out-of-band emission that complies with both the average and peak limits of Section 15.209 is not required to satisfy the -27 dBm/MHz peak emission limit.

**Note 4:** Only devices with antenna gains of 10 dBi or less may be approved using the emission limits specified in Section 15.247(d) till March 2, 2018; all other devices operating in this band must use the mask specified in Section 15.407(b)(4)(i).

### 3.4.2 Measuring Instruments

The measuring equipment is listed in the section 4 of this test report.



### **3.4.3 Test Procedures**

1. The testing follows FCC KDB 789033 D02 General UNII Test Procedures New Rules v01r04. Section G) Unwanted emissions measurement.

(1) Procedure for Unwanted Emissions Measurements Below 1000MHz

- RBW = 120 kHz
- VBW = 300 kHz
- Detector = Peak
- Trace mode = max hold

(2) Procedure for Peak Unwanted Emissions Measurements Above 1000 MHz

- RBW = 1 MHz
- VBW  $\geq$  3 MHz
- Detector = Peak
- Sweep time = auto
- Trace mode = max hold

(3) Procedures for Average Unwanted Emissions Measurements Above 1000MHz

- RBW = 1 MHz
- VBW = 10 Hz, when duty cycle is no less than 98 percent.
- VBW  $\geq$  1/T, when duty cycle is less than 98 percent where T is the minimum transmission duration over which the transmitter is on and is transmitting at its maximum power control level for the tested mode of operation.

2. The EUT was placed on a turntable with 0.8 meter for frequency below 1GHz and 1.5 meter for frequency above 1GHz respectively above ground.
3. The EUT was set 3 meters from the interference receiving antenna which was mounted on the top of a variable height antenna tower.
4. The antenna is a broadband antenna and its height is adjusted between one meter and four meters above ground to find the maximum value of the field strength for both horizontal polarization and vertical polarization of the antenna.
5. For each suspected emission, the EUT was arranged to its worst case and then adjust the antenna tower (from 1 m to 4 m) and turntable (from 0 degree to 360 degrees) to find the maximum reading.
6. For testing below 1GHz, if the emission level of the EUT in peak mode was 3 dB lower than the limit specified, then peak values of EUT will be reported, otherwise, the emissions will be repeated one by one using the CISPR quasi-peak method and reported.
7. For testing above 1GHz, the emission level of the EUT in peak mode was 20dB lower than average limit (that means the emission level in average mode also complies with the limit in average mode), then peak values of EUT will be reported, otherwise, the emissions will be measured in average mode again and reported.

### 3.4.4 Test Setup

For radiated emissions below 30MHz

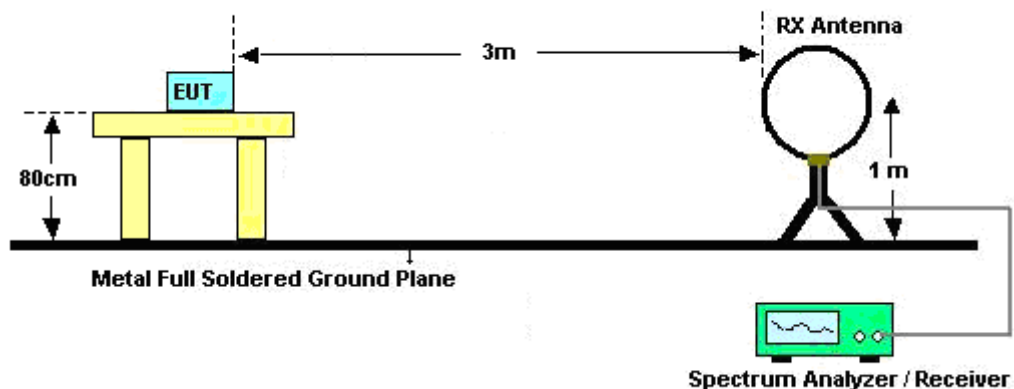

For radiated emissions from 30MHz to 1GHz

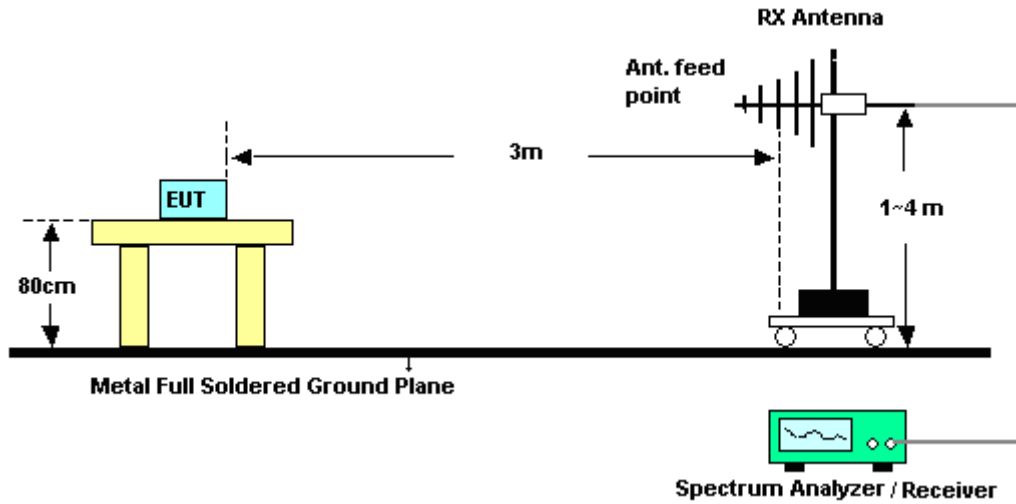

For radiated emissions above 1GHz

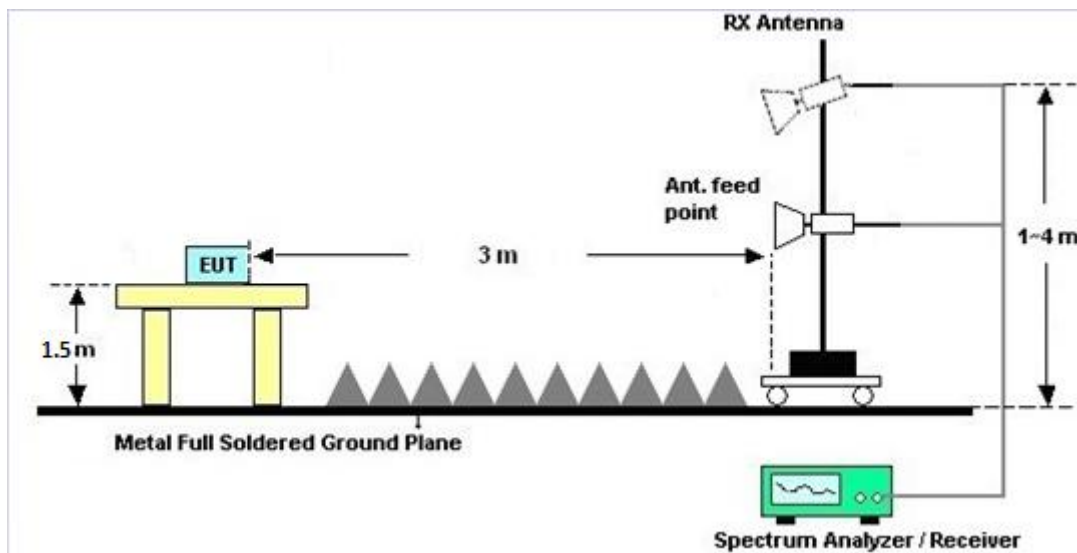



### **3.4.5 Test Results of Radiated Spurious Emissions (9 kHz ~ 30 MHz)**

The low frequency, which started from 9 kHz to 30MHz, was pre-scanned and the result which was 20dB lower than the limit line was not reported.

There is a comparison data of both open-field test site and semi-Anechoic chamber, and the result came out very similar.

### **3.4.6 Test Result of Radiated Spurious at Band Edges**

Please refer to Appendix C and D.

### **3.4.7 Duty Cycle**

Please refer to Appendix E.

### **3.4.8 Test Result of Radiated Spurious Emissions (30MHz ~ 10th Harmonic)**

Please refer to Appendix C and D.



### 3.5 AC Conducted Emission Measurement

#### 3.5.1 Limit of AC Conducted Emission

For equipment that is designed to be connected to the public utility (AC) power line, the radio frequency voltage that is conducted back onto the AC power line on any frequency or frequencies within the band 150 kHz to 30 MHz shall not exceed the limits in the following table.

Frequency of emission (MHz)	Conducted limit (dB $\mu$ V)	
	Quasi-peak	Average
0.15-0.5	66 to 56*	56 to 46*
0.5-5	56	46
5-30	60	50

\*Decreases with the logarithm of the frequency.

#### 3.5.2 Measuring Instruments

The measuring equipment is listed in the section 4 of this test report.

#### 3.5.3 Test Procedures

1. The EUT was placed 0.4 meter from the conducting wall of the shielding room was kept at least 80 centimeters from any other grounded conducting surface.
2. Connect EUT to the power mains through a line impedance stabilization network (LISN).
3. All the support units are connecting to the other LISN.
4. The LISN provides 50 ohm coupling impedance for the measuring instrument.
5. The FCC states that a 50 ohm, 50 microhenry LISN should be used.
6. Both sides of AC line were checked for maximum conducted interference.
7. The frequency range from 150 kHz to 30 MHz was searched.
8. Set the test-receiver system to Peak Detect Function and specified bandwidth with Maximum Hold Mode.



### 3.5.4 Test Setup

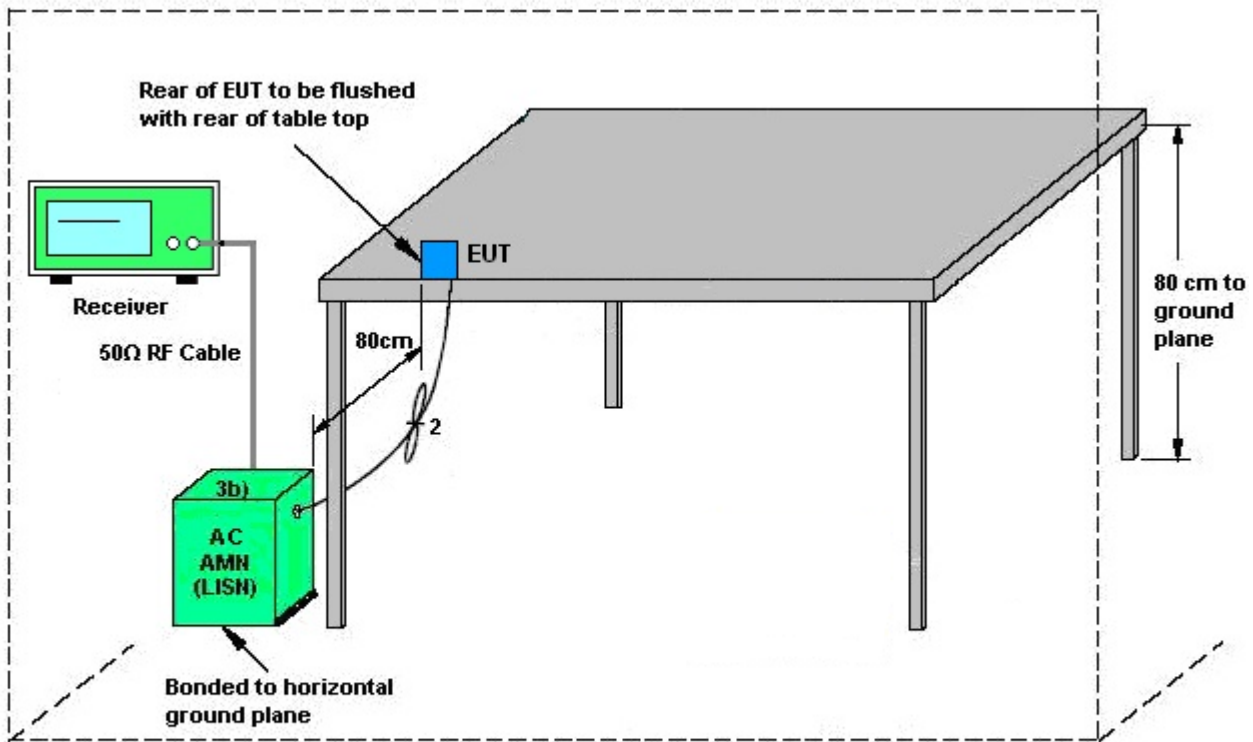

AMN = Artificial mains network (LISN)  
AE = Associated equipment  
EUT = Equipment under test  
ISN = Impedance stabilization network

### 3.5.5 Test Result of AC Conducted Emission

Please refer to Appendix B.

## 3.6 Frequency Stability Measurement

### 3.6.1 Limit of Frequency Stability

Manufacturers of U-NII devices are responsible for ensuring frequency stability such that an emission is maintained within the band of operation under all conditions of normal operation as specified in the user's manual.

### 3.6.2 Measuring Instruments

The measuring equipment is listed in the section 4 of this test report.

### 3.6.3 Test Procedures

1. To ensure emission at the band edge is maintained within the authorized band, those values shall be measured by radiation emissions at upper and lower frequency points, and finally compensated by frequency deviation as procedures below.
2. The EUT was operated at the maximum output power, and connected to the spectrum analyzer, which is set to maximum hold function and peak detector. The peak value of the power envelope was measured and noted. The upper and lower frequency points were respectively measured relatively 10dB lower than the measured peak value.
3. The frequency deviation was calculated by adding the upper frequency point and the lower frequency point divided by two. Those detailed values of frequency deviation are provided in table below.

### 3.6.4 Test Setup



### 3.6.5 Test Result of Frequency Stability

Please refer to Appendix A.



## **3.7 Automatically Discontinue Transmission**

### **3.7.1 Limit of Automatically Discontinue Transmission**

The device shall automatically discontinue transmission in case of either absence of information to transmit or operational failure. These provisions are not intended to preclude the transmission of control or signaling information or the use of repetitive codes used by certain digital technologies to complete frame or burst intervals. Applicants shall include in their application for equipment authorization to describe how this requirement is met.

### **3.7.2 Measuring Instruments**

The measuring equipment is listed in the section 4 of this test report.

### **3.7.3 Test Result of Automatically Discontinue Transmission**

While the EUT is not transmitting any information, the EUT can automatically discontinue transmission and become standby mode for power saving. The EUT can detect the controlling signal of ACK message transmitting from remote device and verify whether it shall resend or discontinue transmission.



## **3.8 Antenna Requirements**

### **3.8.1 Standard Applicable**

If transmitting antenna directional gain is greater than 6 dBi, both the peak transmit power and the peak power spectral density shall be reduced by the amount in dB that the directional gain of the antenna exceeds 6 dBi.

### **3.8.2 Antenna Anti-Replacement Construction**

An embedded-in antenna design is used.

### **3.8.3 Antenna Gain**

The antenna gain is less than 6 dBi. Therefore, it is not necessary to reduce maximum peak output power limit.



## 4 List of Measuring Equipment

Instrument	Manufacturer	Model No.	Serial No.	Characteristics	Calibration Date	Test Date	Due Date	Remark
Power Meter	Anritsu	ML2495A	0932001	N/A	Sep. 29, 2016	Aug. 24, 2017 ~ Sep. 14, 2017	Sep. 28, 2017	Conducted (TH05-HY)
Power Sensor	Anritsu	MA2411B	0846202	300MHz~40GHz	Sep. 29, 2016	Aug. 24, 2017 ~ Sep. 14, 2017	Sep. 28, 2017	Conducted (TH05-HY)
Spectrum Analyzer	Rohde & Schwarz	FSP30	101067	9kHz ~ 30GHz	Nov. 17, 2016	Aug. 24, 2017 ~ Sep. 14, 2017	Nov. 16, 2017	Conducted (TH05-HY)
Hygrometer	TECEPEL	DTM-303B	TP157151	N/A	Mar. 20, 2017	Aug. 24, 2017 ~ Sep. 14, 2017	Mar. 19, 2018	Conducted (TH05-HY)
RF Cable	HUBER + SUHNER	SUCOFLEX 104	MY84209521	1GHz~26GHz	Dec. 02, 2016	Aug. 24, 2017 ~ Sep. 14, 2017	Dec. 01, 2017	Conducted (TH05-HY)
Temperature Chamber	ESPEC	SU-241	92003713	-30°C ~95°C	Jun. 07, 2017	Aug. 24, 2017 ~ Sep. 14, 2017	Jun. 06, 2018	Conducted (TH05-HY)
AC Power Source	ChainTek	APC-1000W	N/A	N/A	N/A	Aug. 26, 2017	N/A	Conduction (CO05-HY)
EMI Test Receiver	Rohde & Schwarz	ESCI 7	100724	9kHz~7GHz	Aug. 30, 2016	Aug. 26, 2017	Aug. 29, 2017	Conduction (CO05-HY)
Hygrometer	Testo	608-H1	34913912	N/A	May 02, 2017	Aug. 26, 2017	May 01, 2018	Conduction (CO05-HY)
LISN	Rohde & Schwarz	ENV216	100080	9kHz~30MHz	Nov. 29, 2016	Aug. 26, 2017	Nov. 28, 2017	Conduction (CO05-HY)
LF Cable	HUBER + SUHNER	RG-214/U	LF01	N/A	Jan. 05, 2017	Aug. 26, 2017	Jan. 04, 2018	Conduction (CO05-HY)
Test Software	N/A	EMC32	8.40.0	N/A	N/A	Aug. 26, 2017	N/A	Conduction (CO05-HY)
Loop Antenna	Rohde & Schwarz	HFH2-Z2	100315	9 kHz~30 MHz	May 15, 2017	Aug. 29, 2017 ~ Sep. 05, 2017	May 14, 2019	Radiation (03CH10-HY)
Bilog Antenna	TESEQ	CBL 6111D&00800 N1D01N-06	35413&02	30MHz~1GHz	Jan. 07, 2017	Aug. 29, 2017 ~ Sep. 05, 2017	Jan. 06, 2018	Radiation (03CH10-HY)
Horn Antenna	SCHWARZBECK	BBHA 9120 D	9120D-1325	1GHz ~ 18GHz	Sep. 30, 2016	Aug. 29, 2017 ~ Sep. 05, 2017	Sep. 29, 2017	Radiation (03CH10-HY)
SHF-EHF Horn Antenna	SCHWARZBECK	BBHA 9170	BBHA917058 4	18GHz- 40GHz	Nov. 08, 2016	Aug. 29, 2017 ~ Sep. 05, 2017	Nov. 07, 2017	Radiation (03CH10-HY)
Spectrum Analyzer	Keysight	N9010A	MY54200485	10Hz ~ 44GHz	Oct. 17, 2016	Aug. 29, 2017 ~ Sep. 05, 2017	Oct. 16, 2017	Radiation (03CH10-HY)
EMI Test Receiver	Agilent	N9038A(MXE)	MY53290045	20Hz to 8.4GHz	Jan. 19, 2017	Aug. 29, 2017 ~ Sep. 05, 2017	Jan. 18, 2018	Radiation (03CH10-HY)
Amplifier	SONOMA	310N	187311	9kHz~1GHz	Oct. 26, 2016	Aug. 29, 2017 ~ Sep. 05, 2017	Oct. 25, 2017	Radiation (03CH10-HY)
Preamplifier	Keysight	83017A	MY53270078	1GHz~26.5GHz	Oct. 26, 2016	Aug. 29, 2017 ~ Sep. 05, 2017	Oct. 25, 2017	Radiation (03CH10-HY)
Preamplifier	MITEQ	TTA1840-35-H G	1871923	18GHz~40GHz, VSWR : 2.5:1 max	Jul. 21, 2017	Aug. 29, 2017 ~ Sep. 05, 2017	Jul. 20, 2018	Radiation (03CH10-HY)
Preamplifier	MITEQ	AMF-7D-0010 1800	2025787	1GHz~18GHz	Feb. 13, 2017	Aug. 29, 2017 ~ Sep. 05, 2017	Feb. 12, 2018	Radiation (03CH10-HY)



Instrument	Manufacturer	Model No.	Serial No.	Characteristics	Calibration Date	Test Date	Due Date	Remark
Hygrometer	TECPEL	DTM-303B	TP140320	N/A	Nov. 14, 2016	Aug. 29, 2017 ~ Sep. 05, 2017	Nov. 13, 2017	Radiation (03CH10-HY)
RF Cable	HUBER + SUHNER	SUCOFLEX 104	MY249564 MY249524 MY283184	25GHz~40GHz	Sep. 30, 2016	Aug. 29, 2017 ~ Sep. 05, 2017	Sep. 29, 2017	Radiation (03CH10-HY)
RF Cable	HUBER + SUHNER	SUCOFLEX 104	MY249564 MY249524 MY283184	30MHz~1GHz	Sep. 30, 2016	Aug. 29, 2017 ~ Sep. 05, 2017	Sep. 29, 2017	Radiation (03CH10-HY)
RF Cable	HUBER + SUHNER	SUCOFLEX 104	MY249564 MY249524 MY283184	1GHz~25GHz	Sep. 30, 2016	Aug. 29, 2017 ~ Sep. 05, 2017	Sep. 29, 2017	Radiation (03CH10-HY)
Controller	EMEC	EM 1000	N/A	Control Turn table & Ant Mast	N/A	Aug. 29, 2017 ~ Sep. 05, 2017	N/A	Radiation (03CH10-HY)
Antenna Mast	EMEC	AM-BS-4500-B	N/A	1~4m	N/A	Aug. 29, 2017 ~ Sep. 05, 2017	N/A	Radiation (03CH10-HY)
Turn Table	EMEC	TT 2200	N/A	0~360 Degree	N/A	Aug. 29, 2017 ~ Sep. 05, 2017	N/A	Radiation (03CH10-HY)
Test Software	Audix	E3	6.2009-8-24	N/A	N/A	Aug. 28, 2017~ Sep. 05, 2017	N/A	Radiation (03CH10-HY)
Filter	Wainwright	WLKS4500-8S S	SN19	4.5G Low Pass	Sep. 19, 2016	Aug. 29, 2017 ~ Sep. 05, 2017	Sep. 18, 2017	Radiation (03CH10-HY)
Filter	Woken	WHKX8-5272. 5-6750-18000- 40ST	SN2	6.75G Highpass	Dec. 08, 2016	Aug. 29, 2017 ~ Sep. 05, 2017	Dec. 07, 2017	Radiation (03CH10-HY)
Filter	Woken	WHKX8-5272. 5-6750-18000- 40ST	SN2	6.75G Highpass	Dec. 08, 2016	Aug. 29, 2017 ~ Sep. 05, 2017	Dec. 07, 2017	Radiation (03CH10-HY)



## 5 Uncertainty of Evaluation

### Uncertainty of Conducted Emission Measurement (150kHz ~ 30MHz)

Measuring Uncertainty for a Level of Confidence of 95% ( $U = 2Uc(y)$ )	2.70
---	------

### Uncertainty of Radiated Emission Measurement (30 MHz ~ 1000 MHz)

Measuring Uncertainty for a Level of Confidence of 95% ( $U = 2Uc(y)$ )	5.60
---	------

### Uncertainty of Radiated Emission Measurement (1000 MHz ~ 18000 MHz)

Measuring Uncertainty for a Level of Confidence of 95% ( $U = 2Uc(y)$ )	5.90
---	------

### Uncertainty of Radiated Emission Measurement (18000 MHz ~ 40000 MHz)

Measuring Uncertainty for a Level of Confidence of 95% ( $U = 2Uc(y)$ )	5.20
---	------

**Appendix A. Test Result of Conducted Test Items**

Test Engineer:	Allen Lin	Temperature:	21~25	°C
Test Date:	2017/8/24~2017/9/14	Relative Humidity:	51~54	%



**TEST RESULTS DATA**  
**6dB and 26dB EBW and 99% OBW**

Band IV									
Mod.	Data Rate	NTX	CH.	Freq. (MHz)	99% Bandwidth (MHz)	26 dB Bandwidth (MHz)	6 dB Bandwidth (MHz)	6dB Bandwidth min. Limit (MHz)	Pass/Fail
11a	6M bps	1	149	5745	17.35	31.25	15.52	0.5	Pass
11a	6Mbps	1	157	5785	17.3	26.2	15.06	0.5	Pass
11a	6Mbps	1	165	5825	17.2	29.55	15.02	0.5	Pass
HT20	MCS 0	1	149	5745	18.2	28.45	15.04	0.5	Pass
HT20	MCS 0	1	157	5785	18.2	30.65	15	0.5	Pass
HT20	MCS 0	1	165	5825	18.2	26.45	15.02	0.5	Pass
HT40	MCS 0	1	151	5755	36.6	65.47	36.04	0.5	Pass
HT40	MCS 0	1	159	5795	36.8	70.14	36.28	0.5	Pass

**TEST RESULTS DATA**  
**Average Power Table**

Band IV										
Mod.	Data Rate	NTX	CH.	Freq. (MHz)	Duty Factor (dB)	Average Conducted Power (dBm)	FCC Conducted Power Limit (dBm)	DG (dBi)		Pass/Fail
11a	6M bps	1	149	5745	0.15	12.96	30.00	-0.60		Pass
11a	6Mbps	1	157	5785	0.15	12.95	30.00	-0.60		Pass
11a	6Mbps	1	165	5825	0.15	12.91	30.00	-0.60		Pass
HT20	MCS 0	1	149	5745	0.13	10.98	30.00	-0.60		Pass
HT20	MCS 0	1	157	5785	0.13	10.84	30.00	-0.60		Pass
HT20	MCS 0	1	165	5825	0.13	10.80	30.00	-0.60		Pass
HT40	MCS 0	1	151	5755	0.23	10.94	30.00	-0.60		Pass
HT40	MCS 0	1	159	5795	0.23	10.93	30.00	-0.60		Pass

**TEST RESULTS DATA**  
**Power Spectral Density**

Band IV										
Mod.	Data Rate	NTX	CH.	Freq. (MHz)	Duty Factor (dB)	10log (500kHz /RBW) Factor (dB)	Average Power Density (dBm/500kHz)	Average PSD Limit (dBm/500kHz)	DG (dBi)	Pass/Fail
11a	6M bps	1	149	5745	0.15	2.22	3.10	30.00	-0.60	Pass
11a	6Mbps	1	157	5785	0.15	2.22	2.49	30.00	-0.60	Pass
11a	6Mbps	1	165	5825	0.15	2.22	2.84	30.00	-0.60	Pass
HT20	MCS 0	1	149	5745	0.13	2.22	0.25	30.00	-0.60	Pass
HT20	MCS 0	1	157	5785	0.13	2.22	0.11	30.00	-0.60	Pass
HT20	MCS 0	1	165	5825	0.13	2.22	0.29	30.00	-0.60	Pass
HT40	MCS 0	1	151	5755	0.23	2.22	-2.43	30.00	-0.60	Pass
HT40	MCS 0	1	159	5795	0.23	2.22	-2.56	30.00	-0.60	Pass

**TEST RESULTS DATA**  
**Frequency Stability**

Band IV										
Mod.	Data Rate	NTX	CH.	Freq. (MHz)	Center Frequency (MHz)	Frequency Deviation (MHz)	Frequency Stability (ppm)	Temperature (°C)	Voltage (V)	Note
11a	6M bps	1	149	5745	5744.975	-0.025	-4.35	50	3.8	
11a	6M bps	1	149	5745	5745.025	0.025	4.35	-30	3.8	
11a	6M bps	1	149	5745	5745.050	0.050	8.70	20	4.2	
11a	6M bps	1	149	5745	5745.025	0.025	4.35	20	3.5	
11a	6M bps	1	149	5745	5745.000	0.000	0.00	20	3.8	



## Appendix B. AC Conducted Emission Test Results

Test Engineer :	Shareef Yu	Temperature :	26~27°C
		Relative Humidity :	58~62%

## EUT Information

Report NO : 782113  
 Test Mode : Mode 1  
 Test Voltage : 120Vac/60Hz  
 Phase : Line

ENV216 Auto Test FCC Power Bar - L

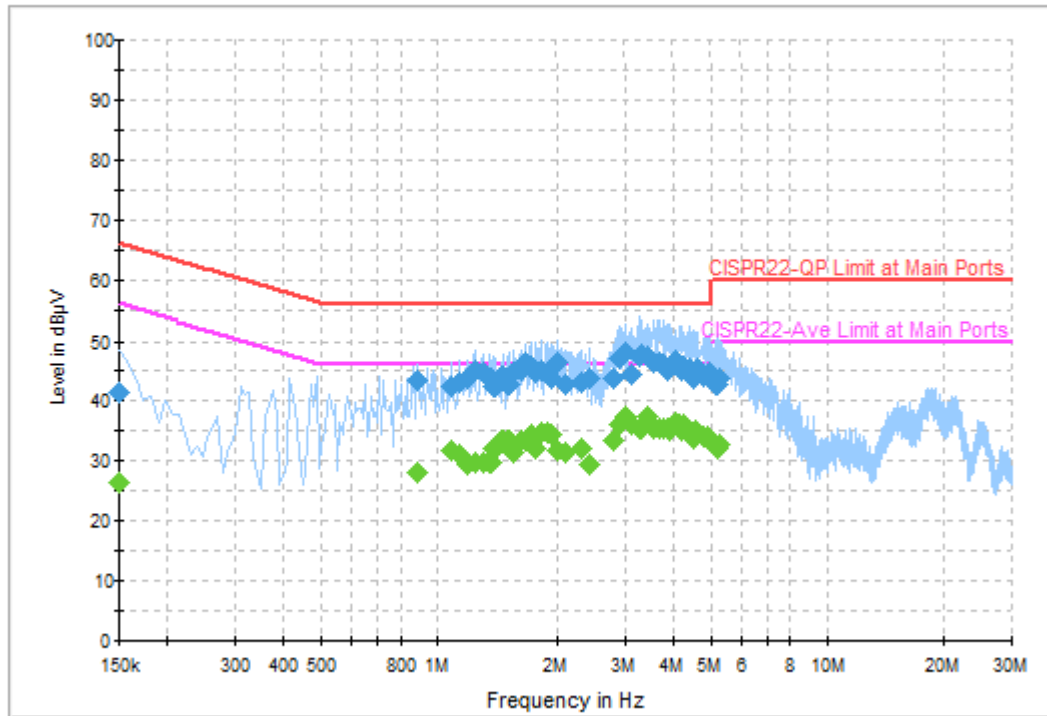

## Final Result 1

Frequency (MHz)	QuasiPeak (dBµV)	Filter	Line	Corr. (dB)	Margin (dB)	Limit (dBµV)
0.150000	41.6	Off	L1	19.6	24.4	66.0
0.886000	43.5	Off	L1	19.5	12.5	56.0
1.078000	42.5	Off	L1	19.5	13.5	56.0
1.134000	43.1	Off	L1	19.5	12.9	56.0
1.190000	43.8	Off	L1	19.5	12.2	56.0
1.246000	45.2	Off	L1	19.5	10.8	56.0
1.302000	44.9	Off	L1	19.5	11.1	56.0
1.358000	43.9	Off	L1	19.5	12.1	56.0
1.398000	42.5	Off	L1	19.5	13.5	56.0
1.454000	44.1	Off	L1	19.5	11.9	56.0
1.502000	42.9	Off	L1	19.5	13.1	56.0
1.550000	44.7	Off	L1	19.5	11.3	56.0
1.614000	45.1	Off	L1	19.6	10.9	56.0
1.662000	46.6	Off	L1	19.5	9.4	56.0
1.718000	45.8	Off	L1	19.5	10.2	56.0
1.766000	44.8	Off	L1	19.6	11.2	56.0
1.830000	45.1	Off	L1	19.6	10.9	56.0
1.886000	45.0	Off	L1	19.5	11.0	56.0
1.934000	43.7	Off	L1	19.6	12.3	56.0
2.022000	46.4	Off	L1	19.6	9.6	56.0
2.102000	42.8	Off	L1	18.0	13.2	56.0
2.318000	43.1	Off	L1	18.8	12.9	56.0
2.438000	43.7	Off	L1	19.1	12.3	56.0
2.790000	43.7	Off	L1	19.4	12.3	56.0
2.902000	47.3	Off	L1	19.4	8.7	56.0

3.014000	48.0	Off	L1	19.5	8.0	56.0
3.134000	44.4	Off	L1	19.5	11.6	56.0
3.262000	47.6	Off	L1	19.5	8.4	56.0
3.318000	47.9	Off	L1	19.5	8.1	56.0
3.446000	47.4	Off	L1	19.5	8.6	56.0
3.574000	46.6	Off	L1	19.6	9.4	56.0
3.678000	46.6	Off	L1	19.6	9.4	56.0
3.798000	46.1	Off	L1	19.6	9.9	56.0
3.854000	45.3	Off	L1	19.6	10.7	56.0
3.902000	45.9	Off	L1	19.6	10.1	56.0
4.038000	46.7	Off	L1	19.6	9.3	56.0
4.142000	46.2	Off	L1	19.6	9.8	56.0
4.214000	45.2	Off	L1	19.6	10.8	56.0
4.254000	45.9	Off	L1	19.6	10.1	56.0
4.422000	45.5	Off	L1	19.6	10.5	56.0
4.502000	43.8	Off	L1	19.6	12.2	56.0
4.574000	45.2	Off	L1	19.6	10.8	56.0
4.630000	45.5	Off	L1	19.6	10.5	56.0
4.782000	44.2	Off	L1	19.6	11.8	56.0
4.902000	44.1	Off	L1	19.6	11.9	56.0
4.950000	44.7	Off	L1	19.6	11.3	56.0
5.126000	42.8	Off	L1	19.6	17.2	60.0
5.182000	42.9	Off	L1	19.6	17.1	60.0
5.278000	43.8	Off	L1	19.6	16.2	60.0

## Final Result 2

Frequency (MHz)	Average (dBμV)	Filter	Line	Corr. (dB)	Margin (dB)	Limit (dBμV)
0.150000	26.3	Off	L1	19.6	29.7	56.0
0.886000	28.0	Off	L1	19.5	18.0	46.0
1.078000	31.8	Off	L1	19.5	14.2	46.0
1.134000	31.0	Off	L1	19.5	15.0	46.0
1.190000	29.3	Off	L1	19.5	16.7	46.0
1.246000	29.7	Off	L1	19.5	16.3	46.0
1.302000	29.9	Off	L1	19.5	16.1	46.0
1.358000	29.8	Off	L1	19.5	16.2	46.0
1.398000	32.0	Off	L1	19.5	14.0	46.0
1.454000	33.4	Off	L1	19.5	12.6	46.0
1.502000	33.4	Off	L1	19.5	12.6	46.0
1.550000	31.3	Off	L1	19.5	14.7	46.0
1.614000	33.4	Off	L1	19.6	12.6	46.0
1.662000	33.4	Off	L1	19.5	12.6	46.0
1.718000	34.4	Off	L1	19.5	11.6	46.0
1.766000	32.1	Off	L1	19.6	13.9	46.0
1.830000	34.6	Off	L1	19.6	11.4	46.0
1.886000	34.6	Off	L1	19.5	11.4	46.0
1.934000	34.5	Off	L1	19.6	11.5	46.0
2.022000	31.9	Off	L1	19.6	14.1	46.0
2.102000	31.5	Off	L1	18.0	14.5	46.0
2.318000	32.2	Off	L1	18.8	13.8	46.0
2.438000	29.5	Off	L1	19.1	16.5	46.0
2.790000	33.3	Off	L1	19.4	12.7	46.0
2.902000	36.0	Off	L1	19.4	10.0	46.0
3.014000	37.4	Off	L1	19.5	8.6	46.0
3.134000	36.0	Off	L1	19.5	10.0	46.0
3.262000	35.6	Off	L1	19.5	10.4	46.0
3.318000	35.4	Off	L1	19.5	10.6	46.0
3.446000	37.5	Off	L1	19.5	8.5	46.0
3.574000	35.3	Off	L1	19.6	10.7	46.0
3.678000	35.4	Off	L1	19.6	10.6	46.0
3.798000	35.3	Off	L1	19.6	10.7	46.0
3.854000	35.5	Off	L1	19.6	10.5	46.0
3.902000	35.3	Off	L1	19.6	10.7	46.0
4.038000	36.3	Off	L1	19.6	9.7	46.0
4.142000	36.1	Off	L1	19.6	9.9	46.0
4.214000	35.1	Off	L1	19.6	10.9	46.0
4.254000	36.0	Off	L1	19.6	10.0	46.0
4.422000	35.1	Off	L1	19.6	10.9	46.0
4.502000	33.7	Off	L1	19.6	12.3	46.0

4.574000	35.0	Off	L1	19.6	11.0	46.0
4.630000	34.8	Off	L1	19.6	11.2	46.0
4.782000	33.9	Off	L1	19.6	12.1	46.0
4.902000	34.1	Off	L1	19.6	11.9	46.0
4.950000	33.6	Off	L1	19.6	12.4	46.0
5.126000	32.5	Off	L1	19.6	17.5	50.0
5.182000	32.3	Off	L1	19.6	17.7	50.0
5.278000	32.7	Off	L1	19.6	17.3	50.0



## EUT Information

Report NO : 782113  
 Test Mode : Mode 1  
 Test Voltage : 120Vac/60Hz  
 Phase : Neutral

ENV216 Auto Test FCC Power Bar - N

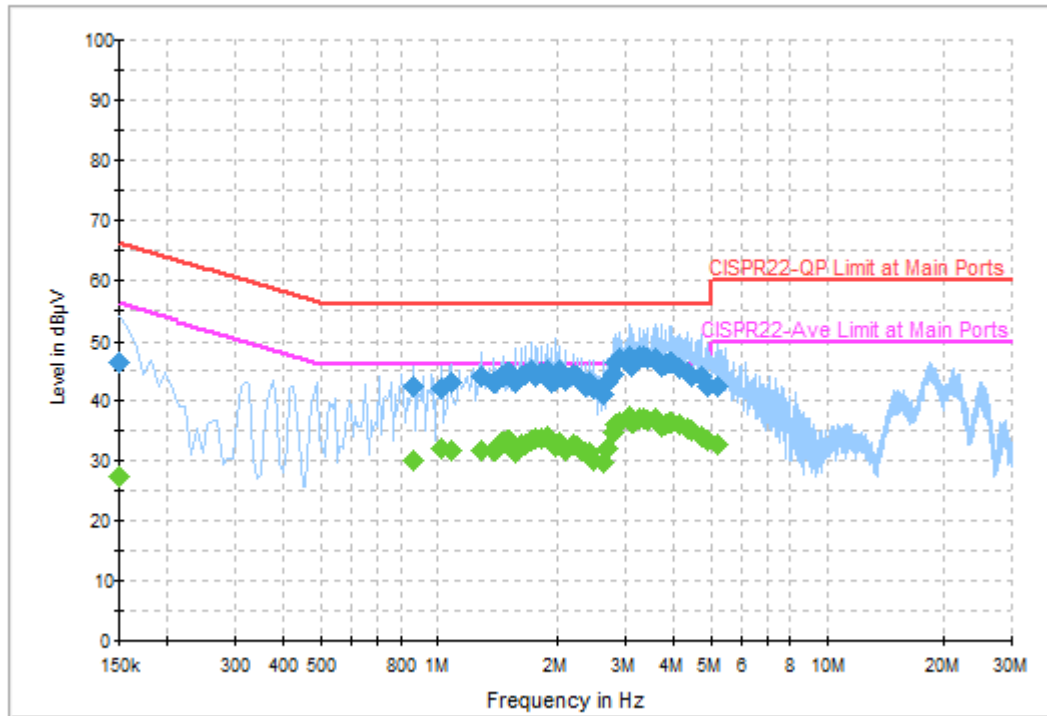

## Final Result 1

Frequency (MHz)	QuasiPeak (dBµV)	Filter	Line	Corr. (dB)	Margin (dB)	Limit (dBµV)
0.150000	46.6	Off	N	19.5	19.4	66.0
0.862000	42.5	Off	N	19.5	13.5	56.0
1.022000	42.2	Off	N	19.5	13.8	56.0
1.078000	43.3	Off	N	19.5	12.7	56.0
1.294000	44.1	Off	N	19.5	11.9	56.0
1.398000	43.0	Off	N	19.5	13.0	56.0
1.454000	44.1	Off	N	19.5	11.9	56.0
1.510000	44.7	Off	N	19.5	11.3	56.0
1.566000	43.0	Off	N	19.5	13.0	56.0
1.614000	44.2	Off	N	19.5	11.8	56.0
1.670000	44.6	Off	N	19.5	11.4	56.0
1.726000	45.1	Off	N	19.5	10.9	56.0
1.774000	44.2	Off	N	19.5	11.8	56.0
1.830000	44.9	Off	N	19.5	11.1	56.0
1.886000	45.1	Off	N	19.5	10.9	56.0
1.934000	43.1	Off	N	19.5	12.9	56.0
1.998000	43.6	Off	N	19.5	12.4	56.0
2.046000	45.0	Off	N	18.8	11.0	56.0
2.102000	43.4	Off	N	18.0	12.6	56.0
2.206000	44.4	Off	N	18.5	11.6	56.0
2.262000	44.3	Off	N	18.7	11.7	56.0
2.318000	43.1	Off	N	18.8	12.9	56.0
2.374000	42.4	Off	N	18.9	13.6	56.0
2.422000	43.2	Off	N	19.0	12.8	56.0
2.478000	42.3	Off	N	19.1	13.7	56.0

2.638000	41.3	Off	N	19.3	14.7	56.0
2.694000	43.1	Off	N	19.3	12.9	56.0
2.798000	44.6	Off	N	19.4	11.4	56.0
2.854000	46.5	Off	N	19.4	9.5	56.0
2.910000	47.1	Off	N	19.4	8.9	56.0
3.070000	47.6	Off	N	19.5	8.4	56.0
3.118000	45.9	Off	N	19.5	10.1	56.0
3.174000	46.9	Off	N	19.5	9.1	56.0
3.286000	47.6	Off	N	19.5	8.4	56.0
3.342000	47.4	Off	N	19.5	8.6	56.0
3.446000	47.0	Off	N	19.5	9.0	56.0
3.606000	47.0	Off	N	19.5	9.0	56.0
3.726000	45.7	Off	N	19.6	10.3	56.0
3.830000	46.1	Off	N	19.6	9.9	56.0
3.934000	46.3	Off	N	19.6	9.7	56.0
3.982000	46.4	Off	N	19.6	9.6	56.0
4.150000	45.6	Off	N	19.6	10.4	56.0
4.366000	44.8	Off	N	19.6	11.2	56.0
4.470000	44.1	Off	N	19.6	11.9	56.0
4.734000	44.1	Off	N	19.6	11.9	56.0
4.910000	42.4	Off	N	19.6	13.6	56.0
5.222000	42.5	Off	N	19.6	17.5	60.0

## Final Result 2

Frequency (MHz)	Average (dBμV)	Filter	Line	Corr. (dB)	Margin (dB)	Limit (dBμV)
0.150000	27.3	Off	N	19.5	28.7	56.0
0.862000	30.2	Off	N	19.5	15.8	46.0
1.022000	32.0	Off	N	19.5	14.0	46.0
1.078000	31.9	Off	N	19.5	14.1	46.0
1.294000	31.8	Off	N	19.5	14.2	46.0
1.398000	31.8	Off	N	19.5	14.2	46.0
1.454000	33.0	Off	N	19.5	13.0	46.0
1.510000	33.4	Off	N	19.5	12.6	46.0
1.566000	31.4	Off	N	19.5	14.6	46.0
1.614000	32.8	Off	N	19.5	13.2	46.0
1.670000	32.9	Off	N	19.5	13.1	46.0
1.726000	33.3	Off	N	19.5	12.7	46.0
1.774000	33.8	Off	N	19.5	12.2	46.0
1.830000	33.6	Off	N	19.5	12.4	46.0
1.886000	34.1	Off	N	19.5	11.9	46.0
1.934000	33.6	Off	N	19.5	12.4	46.0
1.998000	32.4	Off	N	19.5	13.6	46.0
2.046000	33.2	Off	N	18.8	12.8	46.0
2.102000	31.7	Off	N	18.0	14.3	46.0
2.206000	32.7	Off	N	18.5	13.3	46.0
2.262000	32.6	Off	N	18.7	13.4	46.0
2.318000	31.8	Off	N	18.8	14.2	46.0
2.374000	31.3	Off	N	18.9	14.7	46.0
2.422000	31.4	Off	N	19.0	14.6	46.0
2.478000	30.1	Off	N	19.1	15.9	46.0
2.638000	29.6	Off	N	19.3	16.4	46.0
2.694000	32.1	Off	N	19.3	13.9	46.0
2.798000	34.7	Off	N	19.4	11.3	46.0
2.854000	36.0	Off	N	19.4	10.0	46.0
2.910000	36.3	Off	N	19.4	9.7	46.0
3.070000	37.3	Off	N	19.5	8.7	46.0
3.118000	36.4	Off	N	19.5	9.6	46.0
3.174000	36.5	Off	N	19.5	9.5	46.0
3.286000	37.1	Off	N	19.5	8.9	46.0
3.342000	37.0	Off	N	19.5	9.0	46.0
3.446000	36.9	Off	N	19.5	9.1	46.0
3.606000	37.0	Off	N	19.5	9.0	46.0
3.726000	35.7	Off	N	19.6	10.3	46.0
3.830000	36.2	Off	N	19.6	9.8	46.0
3.934000	36.6	Off	N	19.6	9.4	46.0
3.982000	36.5	Off	N	19.6	9.5	46.0
4.150000	36.0	Off	N	19.6	10.0	46.0
4.366000	35.5	Off	N	19.6	10.5	46.0

4.47000	35.0	Off	N	19.6	11.0	46.0
4.73400	34.2	Off	N	19.6	11.8	46.0
4.91000	33.4	Off	N	19.6	12.6	46.0
5.22200	32.9	Off	N	19.6	17.1	50.0



## Appendix C. Radiated Spurious Emission

Test Engineer :	Tsung lee, Stan Hsieh and Kyle Chuang	Temperature :	22~24°C
		Relative Humidity :	43~44%

### Band 4 - 5725~5850MHz

#### WiFi 802.11a (Band Edge @ 3m)

WiFi Ant. 1	Note	Frequency ( MHz )	Level ( dBμV/m )	Over Limit ( dB )	Limit Line ( dBμV/m )	Read Level ( dBμV )	Antenna Factor ( dB/m )	Cable Loss ( dB )	Preamp Factor ( dB )	Ant Pos ( cm )	Table Pos ( deg )	Peak Avg. ( P/A )	Pol. ( H/V )	
802.11a CH 149 5745MHz		5609.4	47.1	-21.1	68.2	40.08	32.67	6.95	32.6	292	7	P	H	
		5670.2	50.85	-32.34	83.19	43.69	32.78	7	32.62	292	7	P	H	
		5720	54.43	-56.37	110.8	47.18	32.86	7.03	32.64	292	7	P	H	
		5724.2	65.61	-54.77	120.38	58.36	32.86	7.03	32.64	292	7	P	H	
	*	5745	102.65	-	-	95.37	32.89	7.04	32.65	292	7	P	H	
	*	5745	95.45	-	-	88.17	32.89	7.04	32.65	292	7	A	H	
														H
														H
			5624.8	48.34	-19.86	68.2	41.29	32.69	6.96	32.6	266	328	P	V
			5695.8	51.01	-51.09	102.1	43.83	32.8	7.01	32.63	266	328	P	V
			5720	54.23	-56.57	110.8	46.98	32.86	7.03	32.64	266	328	P	V
			5724.8	67.95	-53.79	121.74	60.7	32.86	7.03	32.64	266	328	P	V
	*		5745	106.19	-	-	98.91	32.89	7.04	32.65	266	328	P	V
	*		5745	98.7	-	-	91.42	32.89	7.04	32.65	266	328	A	V
														V
													V	



WIFI Ant. 1	Note	Frequency ( MHz )	Level ( dBμV/m )	Over Limit ( dB )	Limit Line ( dBμV/m )	Read Level ( dBμV )	Antenna Factor ( dB/m )	Cable Loss ( dB )	Preamp Factor ( dB )	Ant Pos ( cm )	Table Pos ( deg )	Peak Avg. ( P/A )	Pol. ( H/V )
		5649.8	47.91	-20.29	68.2	40.78	32.75	6.99	32.61	310	7	P	H
		5696.4	48.49	-54.06	102.55	41.31	32.8	7.01	32.63	310	7	P	H
		5718	51.21	-59.03	110.24	43.96	32.86	7.03	32.64	310	7	P	H
		5721.2	48.15	-65.39	113.54	40.9	32.86	7.03	32.64	310	7	P	H
	*	5785	102.92	-	-	95.58	32.94	7.07	32.67	310	7	P	H
	*	5785	95.89	-	-	88.55	32.94	7.07	32.67	310	7	A	H
		5852.6	48.94	-67.33	116.27	41.48	33.05	7.1	32.69	310	7	P	H
		5863.2	49.22	-59.28	108.5	41.73	33.08	7.11	32.7	310	7	P	H
		5905.4	48.43	-34.24	82.67	40.86	33.16	7.12	32.71	310	7	P	H
		5940.4	48.06	-20.14	68.2	40.43	33.22	7.14	32.73	310	7	P	H
													H
													H
<b>802.11a</b>													
<b>CH 157</b>													
<b>5785MHz</b>		5633.2	48.03	-20.17	68.2	40.95	32.72	6.97	32.61	289	307	P	V
		5696.6	48.82	-53.87	102.69	41.64	32.8	7.01	32.63	289	307	P	V
		5706.6	50.33	-56.72	107.05	43.12	32.83	7.02	32.64	289	307	P	V
		5722.6	49.28	-67.45	116.73	42.03	32.86	7.03	32.64	289	307	P	V
	*	5785	106.72	-	-	99.38	32.94	7.07	32.67	289	307	P	V
	*	5785	99.52	-	-	92.18	32.94	7.07	32.67	289	307	A	V
		5851.6	51.68	-66.87	118.55	44.22	33.05	7.1	32.69	289	307	P	V
		5865	51.23	-56.77	108	43.74	33.08	7.11	32.7	289	307	P	V
		5900.6	49.52	-36.7	86.22	41.98	33.13	7.12	32.71	289	307	P	V
		5928.4	48.98	-19.22	68.2	41.38	33.19	7.13	32.72	289	307	P	V
													V
													V



WIFI Ant. 1	Note	Frequency ( MHz )	Level ( dBμV/m )	Over Limit ( dB )	Limit Line ( dBμV/m )	Read Level ( dBμV )	Antenna Factor ( dB/m )	Cable Loss ( dB )	Preamp Factor ( dB )	Ant Pos ( cm )	Table Pos ( deg )	Peak Avg. ( P/A )	Pol. ( H/V )	
802.11a CH 165 5825MHz	*	5825	102.69	-	-	95.26	33.02	7.09	32.68	245	16	P	H	
	*	5825	95.55	-	-	88.12	33.02	7.09	32.68	245	16	A	H	
		5850.2	51.24	-70.5	121.74	43.78	33.05	7.1	32.69	245	16	P	H	
		5864	50.1	-58.18	108.28	42.61	33.08	7.11	32.7	245	16	P	H	
		5903.8	50.78	-33.07	83.85	43.24	33.13	7.12	32.71	245	16	P	H	
		5947.6	48.12	-20.08	68.2	40.49	33.22	7.14	32.73	245	16	P	H	
														H
														H
	*	5825	106.08	-	-	98.65	33.02	7.09	32.68	261	355	P	V	
	*	5825	99.07	-	-	91.64	33.02	7.09	32.68	261	355	A	V	
		5850.2	55.24	-66.5	121.74	47.78	33.05	7.1	32.69	261	355	P	V	
		5855.8	54.6	-55.98	110.58	47.11	33.08	7.1	32.69	261	355	P	V	
		5906	52.98	-29.24	82.22	45.41	33.16	7.12	32.71	261	355	P	V	
		5933.4	51.51	-16.69	68.2	43.9	33.19	7.14	32.72	261	355	P	V	
														V
														V
													V	
<b>Remark</b>	1. No other spurious found. 2. All results are PASS against Peak and Average limit line.													



**Band 4 5725~5850MHz**  
**WIFI 802.11a (Harmonic @ 3m)**

WIFI Ant. 1	Note	Frequency ( MHz )	Level ( dBμV/m )	Over Limit ( dB )	Limit Line ( dBμV/m )	Read Level ( dBμV )	Antenna Factor ( dB/m )	Cable Loss ( dB )	Preamp Factor ( dB )	Ant Pos ( cm )	Table Pos ( deg )	Peak Avg. ( P/A )	Pol. ( H/V )
802.11a CH 149 5745MHz		11490	50.37	-23.63	74	65.15	39.24	10.86	65.39	100	0	P	H
		17235	60.83	-7.37	68.2	69.29	41.15	14.02	64.27	100	0	P	H
													H
													H
		11490	46.5	-27.5	74	61.28	39.24	10.86	65.39	100	0	P	V
		17235	60.49	-7.71	68.2	68.95	41.15	14.02	64.27	100	0	P	V
													V
													V
802.11a CH 157 5785MHz		11570	49.37	-24.63	74	63.97	39.28	10.98	65.37	100	0	P	H
		17355	63.26	-4.94	68.2	71.14	41.52	14.08	64.11	100	0	P	H
													H
													H
		11570	47.87	-26.13	74	62.47	39.28	10.98	65.37	100	0	P	V
		17355	63.24	-4.96	68.2	71.12	41.52	14.08	64.11	100	0	P	V
													V
													V
802.11a CH 165 5825MHz		11650	48.48	-25.52	74	62.8	39.37	11.14	65.34	100	0	P	H
		17475	60.18	-8.02	68.2	67.48	41.89	14.14	63.95	100	0	P	H
													H
													H
		11650	48.7	-25.3	74	63.02	39.37	11.14	65.34	100	0	P	V
		17475	58.57	-9.63	68.2	65.87	41.89	14.14	63.95	100	0	P	V
													V
													V
Remark	1. No other spurious found. 2. All results are PASS against Peak and Average limit line.												



**Band 4 5725~5850MHz**  
**WIFI 802.11n HT20 (Band Edge @ 3m)**

WIFI Ant. 1	Note	Frequency ( MHz )	Level ( dBμV/m )	Over Limit ( dB )	Limit Line ( dBμV/m )	Read Level ( dBμV )	Antenna Factor ( dB/m )	Cable Loss ( dB )	Preamp Factor ( dB )	Ant Pos ( cm )	Table Pos ( deg )	Peak Avg. ( P/A )	Pol. ( H/V )	
802.11n HT20 CH 149 5745MHz		5644	47.04	-21.16	68.2	39.96	32.72	6.97	32.61	309	7	P	H	
		5669.6	49.22	-33.52	82.74	42.06	32.78	7	32.62	309	7	P	H	
		5717	56.06	-53.9	109.96	48.85	32.83	7.02	32.64	309	7	P	H	
		5724.2	68.04	-52.34	120.38	60.79	32.86	7.03	32.64	309	7	P	H	
	*	5745	103.23	-	-	95.95	32.89	7.04	32.65	309	7	P	H	
	*	5745	95.95	-	-	88.67	32.89	7.04	32.65	309	7	A	H	
														H
														H
			5629.8	49.15	-19.05	68.2	42.1	32.69	6.97	32.61	264	0	P	V
			5690.2	51.19	-46.78	97.97	44.01	32.8	7.01	32.63	264	0	P	V
			5713.4	56.89	-52.06	108.95	49.68	32.83	7.02	32.64	264	0	P	V
			5723.8	67.74	-51.72	119.46	60.49	32.86	7.03	32.64	264	0	P	V
	*		5745	106.13	-	-	98.85	32.89	7.04	32.65	264	0	P	V
	*		5745	98.8	-	-	91.52	32.89	7.04	32.65	264	0	A	V
														V
														V





WIFI Ant. 1	Note	Frequency ( MHz )	Level ( dBμV/m )	Over Limit ( dB )	Limit Line ( dBμV/m )	Read Level ( dBμV )	Antenna Factor ( dB/m )	Cable Loss ( dB )	Preamp Factor ( dB )	Ant Pos ( cm )	Table Pos ( deg )	Peak Avg. ( P/A )	Pol. ( H/V )
		5618.8	47.93	-20.27	68.2	40.88	32.69	6.96	32.6	239	18	P	H
		5677.6	48.74	-39.92	88.66	41.58	32.78	7	32.62	239	18	P	H
		5707	50.16	-57	107.16	42.95	32.83	7.02	32.64	239	18	P	H
		5723.4	48.99	-69.56	118.55	41.74	32.86	7.03	32.64	239	18	P	H
	*	5785	103.88	-	-	96.54	32.94	7.07	32.67	239	18	P	H
	*	5785	96.77	-	-	89.43	32.94	7.07	32.67	239	18	A	H
		5851.2	48.42	-71.04	119.46	40.96	33.05	7.1	32.69	239	18	P	H
		5864.6	50.14	-57.97	108.11	42.65	33.08	7.11	32.7	239	18	P	H
		5907	48.64	-32.84	81.48	41.07	33.16	7.12	32.71	239	18	P	H
		5934.8	49.78	-18.42	68.2	42.18	33.19	7.14	32.73	239	18	P	H
802.11n													H
HT20													H
CH 157		5630.4	47.52	-20.68	68.2	40.47	32.69	6.97	32.61	255	359	P	V
5785MHz		5697	51.08	-51.91	102.99	43.9	32.8	7.01	32.63	255	359	P	V
		5704.8	51.54	-55.01	106.55	44.33	32.83	7.02	32.64	255	359	P	V
		5724	50.75	-69.17	119.92	43.5	32.86	7.03	32.64	255	359	P	V
	*	5785	106.55	-	-	99.21	32.94	7.07	32.67	255	359	P	V
	*	5785	99.47	-	-	92.13	32.94	7.07	32.67	255	359	A	V
		5851.6	52.3	-66.25	118.55	44.84	33.05	7.1	32.69	255	359	P	V
		5868.4	51.29	-55.76	107.05	43.8	33.08	7.11	32.7	255	359	P	V
		5878.2	50.36	-52.46	102.82	42.84	33.11	7.11	32.7	255	359	P	V
		5926.8	49.42	-18.78	68.2	41.82	33.19	7.13	32.72	255	359	P	V
													V
													V



WIFI Ant. 1	Note	Frequency ( MHz )	Level ( dBμV/m )	Over Limit ( dB )	Limit Line ( dBμV/m )	Read Level ( dBμV )	Antenna Factor ( dB/m )	Cable Loss ( dB )	Preamp Factor ( dB )	Ant Pos ( cm )	Table Pos ( deg )	Peak Avg. ( P/A )	Pol. ( H/V )	
802.11n HT20 CH 165 5825MHz	*	5825	103.89	-	-	96.46	33.02	7.09	32.68	251	17	P	H	
	*	5825	96.78	-	-	89.35	33.02	7.09	32.68	251	17	A	H	
		5850.2	55.11	-66.63	121.74	47.65	33.05	7.1	32.69	251	17	P	H	
		5859	52.34	-57.34	109.68	44.86	33.08	7.1	32.7	251	17	P	H	
		5908.2	50.9	-29.7	80.6	43.33	33.16	7.12	32.71	251	17	P	H	
		5925	48.86	-19.34	68.2	41.26	33.19	7.13	32.72	251	17	P	H	
														H
														H
	*	5825	106.93	-	-	99.5	33.02	7.09	32.68	260	360	P	V	
	*	5825	99.97	-	-	92.54	33.02	7.09	32.68	260	360	A	V	
		5850.4	59.76	-61.53	121.29	52.3	33.05	7.1	32.69	260	360	P	V	
		5855.4	54.79	-55.9	110.69	47.3	33.08	7.1	32.69	260	360	P	V	
		5890	54.1	-39.97	94.07	46.56	33.13	7.12	32.71	260	360	P	V	
		5927.4	49.87	-18.33	68.2	42.27	33.19	7.13	32.72	260	360	P	V	
														V
														V
<b>Remark</b>	1. No other spurious found. 2. All results are PASS against Peak and Average limit line.													



**Band 4 5725~5850MHz**  
**WIFI 802.11n HT20 (Harmonic @ 3m)**

WIFI Ant. 1	Note	Frequency ( MHz )	Level ( dBμV/m )	Over Limit ( dB )	Limit Line ( dBμV/m )	Read Level ( dBμV )	Antenna Factor ( dB/m )	Cable Loss ( dB )	Preamp Factor ( dB )	Ant Pos ( cm )	Table Pos ( deg )	Peak Avg. ( P/A )	Pol. ( H/V )	
802.11n HT20 CH 149 5745MHz		11490	49.52	-24.48	74	64.3	39.24	10.86	65.39	100	0	P	H	
		17235	62.17	-6.03	68.2	70.63	41.15	14.02	64.27	100	0	P	H	
													H	
													H	
			11490	46.62	-27.38	74	61.4	39.24	10.86	65.39	100	0	P	V
			17235	61.9	-6.3	68.2	70.36	41.15	14.02	64.27	100	0	P	V
														V
802.11n HT20 CH 157 5785MHz		11570	47.21	-26.79	74	61.81	39.28	10.98	65.37	100	0	P	H	
		17355	63.67	-4.53	68.2	71.55	41.52	14.08	64.11	100	0	P	H	
													H	
													H	
			11570	47.41	-26.59	74	62.01	39.28	10.98	65.37	100	0	P	V
			17355	63.61	-4.59	68.2	71.49	41.52	14.08	64.11	100	0	P	V
														V
802.11n HT20 CH 165 5825MHz		11650	50.11	-23.89	74	64.43	39.37	11.14	65.34	100	0	P	H	
		17475	62.73	-5.47	68.2	70.03	41.89	14.14	63.95	100	0	P	H	
													H	
													H	
			11650	47.75	-26.25	74	62.07	39.37	11.14	65.34	100	0	P	V
			17475	56.88	-11.32	68.2	64.18	41.89	14.14	63.95	100	0	P	V
														V
Remark	1. No other spurious found. 2. All results are PASS against Peak and Average limit line.													



**Band 4 5725~5850MHz**  
**WIFI 802.11n HT40 (Band Edge @ 3m)**

WIFI Ant. 1	Note	Frequency ( MHz )	Level ( dBμV/m )	Over Limit ( dB )	Limit Line ( dBμV/m )	Read Level ( dBμV )	Antenna Factor ( dB/m )	Cable Loss ( dB )	Preamp Factor ( dB )	Ant Pos ( cm )	Table Pos ( deg )	Peak Avg. ( P/A )	Pol. ( H/V )
		5618.8	47.91	-20.29	68.2	40.86	32.69	6.96	32.6	308	6	P	H
		5699.4	59.02	-45.74	104.76	51.84	32.8	7.01	32.63	308	6	P	H
		5718.6	68.65	-41.76	110.41	61.4	32.86	7.03	32.64	308	6	P	H
		5724	72.23	-47.69	119.92	64.98	32.86	7.03	32.64	308	6	P	H
	*	5755	100.24	-	-	92.92	32.91	7.06	32.65	308	6	P	H
	*	5755	92.8	-	-	85.48	32.91	7.06	32.65	308	6	A	H
		5851	47.08	-72.84	119.92	39.62	33.05	7.1	32.69	308	6	P	H
		5866.2	48.07	-59.59	107.66	40.58	33.08	7.11	32.7	308	6	P	H
		5908.2	49.34	-31.26	80.6	41.77	33.16	7.12	32.71	308	6	P	H
		5944.4	47.26	-20.94	68.2	39.63	33.22	7.14	32.73	308	6	P	H
<b>802.11n</b>													H
<b>HT40</b>													H
<b>CH 151</b>		5607.6	48.66	-19.54	68.2	41.64	32.67	6.95	32.6	258	0	P	V
<b>5755MHz</b>		5700	57.61	-47.59	105.2	50.42	32.8	7.02	32.63	258	0	P	V
		5719.2	69.98	-40.6	110.58	62.73	32.86	7.03	32.64	258	0	P	V
		5724	72.9	-47.02	119.92	65.65	32.86	7.03	32.64	258	0	P	V
	*	5755	103.67	-	-	96.35	32.91	7.06	32.65	258	0	P	V
	*	5755	96.22	-	-	88.9	32.91	7.06	32.65	258	0	A	V
		5851.2	48.36	-71.1	119.46	40.9	33.05	7.1	32.69	258	0	P	V
		5858.4	49.71	-60.14	109.85	42.23	33.08	7.1	32.7	258	0	P	V
		5880.4	50.09	-51.1	101.19	42.56	33.11	7.12	32.7	258	0	P	V
		5928.4	48.98	-19.22	68.2	41.38	33.19	7.13	32.72	258	0	P	V
													V
													V



WIFI Ant. 1	Note	Frequency ( MHz )	Level ( dBμV/m )	Over Limit ( dB )	Limit Line ( dBμV/m )	Read Level ( dBμV )	Antenna Factor ( dB/m )	Cable Loss ( dB )	Preamp Factor ( dB )	Ant Pos ( cm )	Table Pos ( deg )	Peak Avg. ( P/A )	Pol. ( H/V )
		5648	47.39	-20.81	68.2	40.29	32.72	6.99	32.61	310	8	P	H
		5700	47.75	-57.45	105.2	40.56	32.8	7.02	32.63	310	8	P	H
		5704.4	48.81	-57.62	106.43	41.59	32.83	7.02	32.63	310	8	P	H
		5720.8	47.97	-64.65	112.62	40.72	32.86	7.03	32.64	310	8	P	H
	*	5795	100.42	-	-	93.04	32.97	7.08	32.67	310	8	P	H
	*	5795	92.68	-	-	85.3	32.97	7.08	32.67	310	8	A	H
		5851	50.79	-69.13	119.92	43.33	33.05	7.1	32.69	310	8	P	H
		5867	49.6	-57.84	107.44	42.11	33.08	7.11	32.7	310	8	P	H
		5882.8	47.93	-51.48	99.41	40.4	33.11	7.12	32.7	310	8	P	H
		5943.8	48.68	-19.52	68.2	41.05	33.22	7.14	32.73	310	8	P	H
802.11n													H
HT40													H
CH 159		5634	48.46	-19.74	68.2	41.38	32.72	6.97	32.61	252	360	P	V
5795MHz		5663.2	48.99	-29.01	78	41.87	32.75	6.99	32.62	252	360	P	V
		5716.6	50.41	-59.44	109.85	43.2	32.83	7.02	32.64	252	360	P	V
		5723	52.15	-65.49	117.64	44.9	32.86	7.03	32.64	252	360	P	V
	*	5795	103.91	-	-	96.53	32.97	7.08	32.67	252	360	P	V
	*	5795	96.21	-	-	88.83	32.97	7.08	32.67	252	360	A	V
		5852.2	55.7	-61.48	117.18	48.24	33.05	7.1	32.69	252	360	P	V
		5855.8	52.94	-57.64	110.58	45.45	33.08	7.1	32.69	252	360	P	V
		5878.6	51.4	-51.13	102.53	43.88	33.11	7.11	32.7	252	360	P	V
		5946.8	50.59	-17.61	68.2	42.96	33.22	7.14	32.73	252	360	P	V
													V
													V
Remark	1. No other spurious found. 2. All results are PASS against Peak and Average limit line.												



**Band 4 5725~5850MHz**  
**WIFI 802.11n HT40 (Harmonic @ 3m)**

WIFI Ant. 1	Note	Frequency ( MHz )	Level ( dBµV/m )	Over Limit ( dB )	Limit Line ( dBµV/m )	Read Level ( dBµV )	Antenna Factor ( dB/m )	Cable Loss ( dB )	Preamp Factor ( dB )	Ant Pos ( cm )	Table Pos ( deg )	Peak Avg. ( P/A )	Pol. ( H/V )
802.11n HT40 CH 151 5755MHz		11510	46.87	-27.13	74	61.67	39.2	10.89	65.4	100	0	P	H
		17265	59.11	-9.09	68.2	67.41	41.25	14.04	64.23	100	0	P	H
													H
													H
		11510	45.42	-28.58	74	60.22	39.2	10.89	65.4	100	0	P	V
		17265	55.28	-12.92	68.2	63.58	41.25	14.04	64.23	100	0	P	V
													V
													V
802.11n HT40 CH 159 5795MHz		11590	47.19	-26.81	74	61.73	39.3	11.02	65.37	100	0	P	H
		17385	58.57	-9.63	68.2	66.28	41.63	14.09	64.06	100	0	P	H
													H
													H
		11590	45.75	-28.25	74	60.29	39.3	11.02	65.37	100	0	P	V
		17385	57.78	-10.42	68.2	65.49	41.63	14.09	64.06	100	0	P	V
													V
													V
Remark	1. No other spurious found. 2. All results are PASS against Peak and Average limit line.												



**Emission below 1GHz  
5GHz WIFI 802.11a (LF @ 3m)**

WIFI	Note	Frequency	Level	Over	Limit	Read	Antenna	Cable	Preamp	Ant	Table	Peak	Pol.	
Ant.				Limit	Line	Level	Factor	Loss	Factor	Pos	Pos	Avg.		
1		( MHz )	( dBμV/m )	( dB )	( dBμV/m )	( dBμV )	( dB/m )	( dB )	( dB )	( cm )	( deg )	( P/A )	( H/V )	
5GHz 802.11a LF		43.5	24.53	-15.47	40	39.15	17.33	0.69	32.75			P	H	
		99.93	27.98	-15.52	43.5	43.49	16.05	0.97	32.77			P	H	
		157.44	20.39	-23.11	43.5	34.8	16.74	1.2	32.76			P	H	
		669.6	27.38	-18.62	46	30.85	26.54	2.39	32.99			P	H	
		843.9	30.58	-15.42	46	30.8	29.1	2.65	32.63			P	H	
		951	32.43	-13.57	46	29.82	30.76	2.78	31.74	100	0	P	H	
													H	
													H	
													H	
													H	
													H	
													H	
			31.89	32.09	-7.91	40	40.89	23.34	0.53	32.75			P	V
			43.23	35.97	-4.03	40	50.59	17.33	0.69	32.75	100	0	P	V
			97.5	25.49	-18.01	43.5	41.29	15.76	0.97	32.77			P	V
			673.1	27.79	-18.21	46	31.23	26.57	2.39	32.99			P	V
			821.5	29.86	-16.14	46	31.03	28.32	2.63	32.77			P	V
			940.5	33.45	-12.55	46	31.34	30.4	2.78	31.86			P	V
														V
														V
													V	
													V	
													V	
													V	
<b>Remark</b>	1. No other spurious found. 2. All results are PASS against limit line.													



Emission below 1GHz

5GHz WIFI 802.11n HT20 (LF @ 3m)

WIFI	Note	Frequency	Level	Over	Limit	Read	Antenna	Cable	Preamp	Ant	Table	Peak	Pol.	
Ant.				Limit	Line	Level	Factor	Loss	Factor	Pos	Pos	Avg.		
1		( MHz )	( dBμV/m )	( dB )	( dBμV/m )	( dBμV )	( dB/m )	( dB )	( dB )	( cm )	( deg )	( P/A )	( H/V )	
5GHz 802.11n HT20 LF		31.08	23.01	-16.99	40	31.37	23.78	0.53	32.75			P	H	
		43.77	24.17	-15.83	40	38.78	17.33	0.69	32.74			P	H	
		98.85	28.01	-15.49	43.5	43.66	15.91	0.97	32.77			P	H	
		729.8	30.71	-15.29	46	32.9	27.7	2.48	32.96			P	H	
		858.6	31.22	-14.78	46	31.13	29.29	2.67	32.54			P	H	
		958	32.43	-13.57	46	29.44	31.05	2.79	31.66	100	0	P	H	
													H	
													H	
													H	
													H	
													H	
													H	
			43.23	35.82	-4.18	40	50.44	17.33	0.69	32.75	100	0	P	V
			77.52	25.03	-14.97	40	43.74	13.02	0.86	32.76			P	V
			98.85	25.68	-17.82	43.5	41.33	15.91	0.97	32.77			P	V
			753.6	29.68	-16.32	46	31.24	28.27	2.51	32.94			P	V
			845.3	31.34	-14.66	46	31.54	29.12	2.65	32.63			P	V
			945.4	32.82	-13.18	46	30.46	30.58	2.78	31.8			P	V
													V	
													V	
													V	
													V	
													V	
													V	
Remark	1. No other spurious found. 2. All results are PASS against limit line.													



**Emission below 1GHz**

**5GHz WIFI 802.11n HT40 (LF @ 3m)**

WIFI	Note	Frequency	Level	Over	Limit	Read	Antenna	Cable	Preamp	Ant	Table	Peak	Pol.	
Ant.				Limit	Line	Level	Factor	Loss	Factor	Pos	Pos	Avg.		
1		( MHz )	( dBµV/m )	( dB )	( dBµV/m )	( dBµV )	( dB/m )	( dB )	( dB )	( cm )	( deg )	(P/A)	(H/V)	
<b>5GHz 802.11n HT40 LF</b>		31.35	22.2	-17.8	40	30.56	23.78	0.53	32.75			P	H	
		44.04	24.6	-15.4	40	39.21	17.33	0.69	32.74			P	H	
		100.2	28.31	-15.19	43.5	43.82	16.05	0.97	32.77			P	H	
		742.4	29.64	-16.36	46	31.3	28.18	2.51	32.95			P	H	
		878.2	31.26	-14.74	46	31.12	29.17	2.7	32.42			P	H	
		958.7	32.95	-13.05	46	29.95	31.05	2.79	31.65	100	0	P	H	
													H	
													H	
													H	
													H	
													H	
													H	
													H	
			43.23	35.7	-4.3	40	50.32	17.33	0.69	32.75	100	0	P	V
			77.79	25.57	-14.43	40	44.28	13.02	0.86	32.76			P	V
			98.31	25.29	-18.21	43.5	41.09	15.76	0.97	32.77			P	V
			629.7	27.52	-18.48	46	31.31	26.33	2.29	33			P	V
			746.6	30.95	-15.05	46	32.57	28.22	2.51	32.95			P	V
			957.3	32.77	-13.23	46	29.83	31.01	2.79	31.67			P	V
												V		
												V		
												V		
												V		
												V		
												V		
<b>Remark</b>	1. No other spurious found. 2. All results are PASS against limit line.													



**Note symbol**

*	<b>Fundamental Frequency</b> which can be ignored. However, the level of any unwanted emissions shall not exceed the level of the fundamental frequency.
!	Test result is <b>over limit</b> line.
P/A	<b>Peak</b> or <b>Average</b>
H/V	<b>Horizontal</b> or <b>Vertical</b>



A calculation example for radiated spurious emission is shown as below:

WIFI	Note	Frequency	Level	Over	Limit	Read	Antenna	Cable	Preamp	Ant	Table	Peak	Pol.
Ant.				Limit	Line	Level	Factor	Loss	Factor	Pos	Pos	Avg.	
1		( MHz )	( dBμV/m )	( dB )	( dBμV/m )	( dBμV )	( dB/m )	( dB )	( dB )	( cm )	( deg )	( P/A )	( H/V )
802.11b		2390	55.45	-18.55	74	54.51	32.22	4.58	35.86	103	308	P	H
CH 01													
2412MHz		2390	43.54	-10.46	54	42.6	32.22	4.58	35.86	103	308	A	H

- Level(dBμV/m) =  
Antenna Factor(dB/m) + Cable Loss(dB) + Read Level(dBμV) - Preamp Factor(dB)
- Over Limit(dB) = Level(dBμV/m) – Limit Line(dBμV/m)

**For Peak Limit @ 2390MHz:**

- Level(dBμV/m)  
= Antenna Factor(dB/m) + Cable Loss(dB) + Read Level(dBμV) - Preamp Factor(dB)  
= 32.22(dB/m) + 4.58(dB) + 54.51(dBμV) – 35.86 (dB)  
= 55.45 (dBμV/m)
- Over Limit(dB)  
= Level(dBμV/m) – Limit Line(dBμV/m)  
= 55.45(dBμV/m) – 74(dBμV/m)  
= -18.55(dB)

**For Average Limit @ 2390MHz:**

- Level(dBμV/m)  
= Antenna Factor(dB/m) + Cable Loss(dB) + Read Level(dBμV) - Preamp Factor(dB)  
= 32.22(dB/m) + 4.58(dB) + 42.6(dBμV) – 35.86 (dB)  
= 43.54 (dBμV/m)
- Over Limit(dB)  
= Level(dBμV/m) – Limit Line(dBμV/m)  
= 43.54(dBμV/m) – 54(dBμV/m)  
= -10.46(dB)

Both peak and average measured complies with the limit line, so test result is “PASS”.



## Appendix D. Radiated Spurious Emission Plots

Test Engineer :	Tsung lee, Stan Hsieh and Kyle Chuang	Temperature :	22~24°C
		Relative Humidity :	43~44%

### Note symbol

-L	Low channel location
-R	High channel location



**Band 4 - 5725~5850MHz**  
**WIFI 802.11a (Band Edge @ 3m)**

WIFI	Band 4 5725~5850MHz Band Edge @ 3m	
ANT	802.11a CH149 5745MHz	
1	Horizontal	Fundamental
<b>Peak</b>		



WIFI	Band 4 5725~5850MHz Band Edge @ 3m	
ANT	802.11a CH149 5745MHz	
1	Vertical	Fundamental
Peak	<p>Site : 03CH10-HY Condition : PEAK_BE(B4) 16.24 3m HORN 9120D-HF VERTICAL</p>	<p>Site : 03CH10-HY Condition : PEAK(LNB) 3m HORN 9120D-HF VERTICAL</p>



WIFI	Band 4 5725~5850MHz Band Edge @ 3m	
ANT	802.11a CH157 5785MHz	
1	Horizontal	Fundamental
<p><b>Peak</b></p>		
<p><b>Peak</b></p>		<p><b>Left blank</b></p>



WIFI	Band 4 5725~5850MHz Band Edge @ 3m	
ANT	802.11a CH157 5785MHz	
1	Vertical	Fundamental
Peak	<p>Site : 03CH10-HY Condition : PEAK_BE(B4) 16-24 3m HORN 9120D-HF VERTICAL</p>	<p>Site : 03CH10-HY Condition : PEAK(UINII) 3m HORN 9120D-HF VERTICAL</p>
Peak	<p>Site : 03CH10-HY Condition : PEAK_BE(B4) 16-24 3m HORN 9120D-HF VERTICAL</p>	Left blank





WIFI	Band 4 5725~5850MHz Band Edge @ 3m	
ANT	802.11a CH165 5825MHz	
1	Horizontal	Fundamental
Peak	<p>Site : 03CH10-HY Condition : PEAK_BE(B4) 16.24 3m HORN 9120D-HF HORIZONTAL</p>	<p>Site : 03CH10-HY Condition : PEAK(UN)I 3m HORN 9120D-HF HORIZONTAL</p>



WIFI	Band 4 5725~5850MHz Band Edge @ 3m	
ANT	802.11a CH165 5825MHz	
1	Vertical	Fundamental
Peak	<p>Site : 03CH0-14Y Condition : PEAK_BE(B4) 16.24 3m HORN 9120D-HF VERTICAL</p>	<p>Site : 03CH0-14Y Condition : PEAK(UNII) 3m HORN 9120D-HF VERTICAL</p>



**Band 4 5725~5850MHz**  
**WIFI 802.11n HT20 (Band Edge @ 3m)**

<b>WIFI</b>	<b>Band 4 5725~5850MHz Band Edge @ 3m</b>	
<b>ANT</b>	<b>802.11n HT20 CH149 5745MHz</b>	
<b>1</b>	<b>Horizontal</b>	<b>Fundamental</b>
<b>Peak</b>		



WIFI	Band 4 5725~5850MHz Band Edge @ 3m	
ANT	802.11n HT20 CH149 5745MHz	
1	Vertical	Fundamental
Peak	<p>Site : 03CH10-HY Condition : PEAK_BE(B4) 16.24 3m HORN 9120D-HF VERTICAL</p>	<p>Site : 03CH10-HY Condition : PEAK(UNII) 3m HORN 9120D-HF VERTICAL</p>



WIFI	Band 4 5725~5850MHz Band Edge @ 3m	
ANT	802.11n HT20 CH157 5785MHz	
1	Horizontal	Fundamental
Peak	<p>Site : 03CH10-HY Condition : PEAK_BE(B4)_16-24 3m HORN 9120D-HF HORIZONTAL</p>	<p>Site : 03CH10-HY Condition : PEAK(UNII) 3m HORN 9120D-HF HORIZONTAL</p>
Peak	<p>Site : 03CH10-HY Condition : PEAK_BE(B4)_16-24 3m HORN 9120D-HF HORIZONTAL</p>	Left blank



WIFI	Band 4 5725~5850MHz Band Edge @ 3m	
ANT	802.11n HT20 CH157 5785MHz	
1	Vertical	Fundamental
Peak	<p>Site : 03CH10-HY Condition : PEAK_BE(B4) 16-24 3m HORN 9120D-HF VERTICAL</p>	<p>Site : 03CH10-HY Condition : PEAK(UNIII) 3m HORN 9120D-HF VERTICAL</p>
Peak	<p>Site : 03CH10-HY Condition : PEAK_BE(B4) 16-24 3m HORN 9120D-HF VERTICAL</p>	Left blank

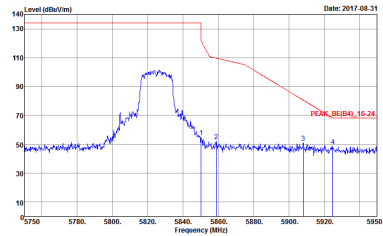
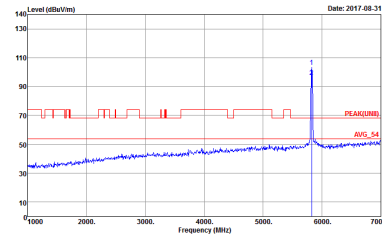

WIFI	Band 4 5725~5850MHz Band Edge @ 3m	
ANT	802.11n HT20 CH165 5825MHz	
1	Horizontal	Fundamental
Peak	 <p>Site : 03CH10-HY Condition : PEAK_BE(B4) 16.24 3m HORN 9120D-HF HORIZONTAL</p>	 <p>Site : 03CH10-HY Condition : PEAK(UIN1) 3m HORN 9120D-HF HORIZONTAL</p>



WIFI	Band 4 5725~5850MHz Band Edge @ 3m	
ANT	802.11n HT20 CH165 5825MHz	
1	Vertical	Fundamental
Peak	<p>Site : 03CH0-11Y Condition : PEAK_BE(B4) 16.24 3m HORN 9120D-HF VERTICAL</p>	<p>Site : 03CH0-11Y Condition : PEAK(UNII) 3m HORN 9120D-HF VERTICAL</p>





**Band 4 5725~5850MHz  
WIFI 802.11n HT40 (Band Edge @ 3m)**

WIFI	Band 4 5725~5850MHz Band Edge @ 3m	
ANT	802.11n HT40 CH151 5755MHz	
1	Horizontal	Fundamental
Peak	<p>Site : 03CH10-HY Condition : PEAK_BE(B4) 16-24 3m HORN 9120D-HF HORIZONTAL</p>	<p>Site : 03CH10-HY Condition : PEAK(LINB) 3m HORN 9120D-HF HORIZONTAL</p>
Peak	<p>Site : 03CH10-HY Condition : PEAK_BE(B4) 16-24 3m HORN 9120D-HF HORIZONTAL</p>	Left blank



WIFI	Band 4 5725~5850MHz Band Edge @ 3m	
ANT	802.11n HT40 CH151 5755MHz	
1	Vertical	Fundamental
Peak	<p>Site : 03CH10-HY Condition : PEAK_BE(B4) 16-24 3m HORN 9120D-HF VERTICAL</p>	<p>Site : 03CH10-HY Condition : PEAK(LNB) 3m HORN 9120D-HF VERTICAL</p>
Peak	<p>Site : 03CH10-HY Condition : PEAK_BE(B4) 16-24 3m HORN 9120D-HF VERTICAL</p>	Left blank



WIFI	Band 4 5725~5850MHz Band Edge @ 3m	
ANT	802.11n HT40 CH159 5795MHz	
1	Horizontal	Fundamental
<p><b>Peak</b></p>		
<p><b>Peak</b></p>		<p><b>Left blank</b></p>



WIFI	Band 4 5725~5850MHz Band Edge @ 3m	
ANT	802.11n HT40 CH159 5795MHz	
1	Vertical	Fundamental
Peak	<p>Site : 03CH10-HY Condition : PEAK_BE(B4)_16-24 3m HORN 9120D-HF VERTICAL</p>	<p>Site : 03CH10-HY Condition : PEAK(UNIII) 3m HORN 9120D-HF VERTICAL</p>
Peak	<p>Site : 03CH10-HY Condition : PEAK_BE(B4)_16-24 3m HORN 9120D-HF VERTICAL</p>	Left blank



**Band 4 - 5725~5850MHz**  
**WIFI 802.11a (Harmonic @ 3m)**

WIFI	Band 4 5725~5850MHz Harmonic @ 3m	
ANT	802.11a CH149 5745MHz	
1	Horizontal	Vertical
Peak Avg.	<p>Site : 03CH10-HY            Condition : PEAKEUNE11 3m HORN 9120D-1HF HORIZONTAL</p>	<p>Site : 03CH10-HY            Condition : PEAKEUNE11 3m HORN 9120D-1HF VERTICAL</p>



<b>WIFI</b>	<b>Band 4 5725~5850MHz Harmonic @ 3m</b>	
<b>ANT</b>	<b>802.11a CH157 5785MHz</b>	
<b>1</b>	<b>Horizontal</b>	<b>Vertical</b>
<b>Peak Avg.</b>	<p>Site : 03CH0-11Y Condition : PEAK(UNII) 3m HORN 9120D-HF HORIZONTAL</p>	<p>Site : 03CH0-11Y Condition : PEAK(UNII) 3m HORN 9120D-HF VERTICAL</p>



WIFI	Band 4 5725~5850MHz Harmonic @ 3m	
ANT	802.11a CH165 5825MHz	
1	Horizontal	Vertical
Peak Avg.	<p>Site : 03CH10-11Y Condition : PEAK(UIN1) 3m HORN 9120D-HF HORIZONTAL</p>	<p>Site : 03CH10-11Y Condition : PEAK(UIN1) 3m HORN 9120D-HF VERTICAL</p>



**Band 4 5725~5850MHz  
WIFI 802.11n HT20 (Harmonic @ 3m)**

<b>WIFI</b>	<b>Band 4 5725~5850MHz Harmonic @ 3m</b>	
<b>ANT</b>	<b>802.11n HT20 CH149 5745MHz</b>	
<b>1</b>	<b>Horizontal</b>	<b>Vertical</b>
<b>Peak Avg.</b>	<p>Site : 03CH10-HY Condition : PEAK(UNII) 3m HORN 9120D-HF HORIZONTAL</p>	<p>Site : 03CH10-HY Condition : PEAK(UNII) 3m HORN 9120D-HF VERTICAL</p>





WIFI	Band 4 5725~5850MHz Harmonic @ 3m	
ANT	802.11n HT20 CH157 5785MHz	
1	Horizontal	Vertical
Peak Avg.	<p>Site : 03CH10-HY Condition : PEAK(UNII) 3m HORN 9120D-HF HORIZONTAL</p>	<p>Site : 03CH10-HY Condition : PEAK(UNII) 3m HORN 9120D-HF VERTICAL</p>



WIFI	Band 4 5725~5850MHz Harmonic @ 3m	
ANT	802.11n HT20 CH165 5825MHz	
1	Horizontal	Vertical
Peak Avg.	<p>Site : 03CH0-HY Condition : PEAKUNEEI 3m HORN 9120D-HF HORIZONTAL</p>	<p>Site : 03CH0-HY Condition : PEAKUNIII 3m HORN 9120D-HF VERTICAL</p>



**Band 4 5725~5850MHz**  
**WIFI 802.11n HT40 (Harmonic @ 3m)**

<b>WIFI</b>	<b>Band 4 5725~5850MHz Harmonic @ 3m</b>	
<b>ANT</b>	<b>802.11n HT40 CH151 5755MHz</b>	
<b>1</b>	<b>Horizontal</b>	<b>Vertical</b>
<b>Peak Avg.</b>	<p>Site : 03CH10-HY          Condition : PEAK(UNII) 3m HORN 9120D-HF HORIZONTAL</p>	<p>Site : 03CH10-HY          Condition : PEAK(UNII) 3m HORN 9120D-HF VERTICAL</p>



WIFI	Band 4 5725~5850MHz Harmonic @ 3m	
ANT	802.11n HT40 CH159 5795MHz	
1	Horizontal	Vertical
Peak Avg.		



Emission below 1GHz  
5GHz WIFI 802.11a (LF)

WIFI	5GHz 5725~5850MHz	
ANT	802.11a LF	
1	Horizontal	Vertical
QP / Peak	<p>Site : 03CH10-HY Condition : QP-3m BE-LOG-6111D-LF HORIZONTAL</p>	<p>Site : 03CH10-HY Condition : QP-3m BE-LOG-6111D-LF VERTICAL</p>

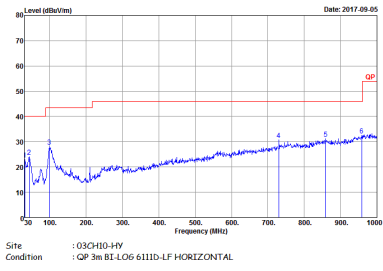
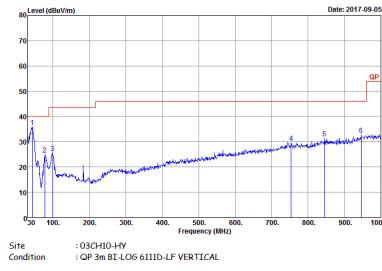

Emission below 1GHz  
5GHz WIFI 802.11n HT20 (LF)

WIFI	5GHz 5725-5850MHz	
ANT	802.11n HT20 LF	
1	Horizontal	Vertical
QP / Peak	 <p>Site : 03CH10-HY Condition : QP-3m BE-LOG-6111D-LF HORIZONTAL</p>	 <p>Site : 03CH10-HY Condition : QP-3m BE-LOG-6111D-LF VERTICAL</p>



Emission below 1GHz  
5GHz WIFI 802.11n HT40 (LF)

WIFI	5GHz 5725~5850MHz	
ANT	802.11n HT40 LF	
1	Horizontal	Vertical
QP / Peak		



### Appendix E. Duty Cycle Plots

Band	Duty Cycle(%)	T(us)	1/T(kHz)	VBW Setting
802.11a	96.53	1390	0.72	1kHz
802.11n HT20	97.04	1310	0.76	1kHz
802.11n HT40	94.74	648	1.54	3kHz

#### 802.11a

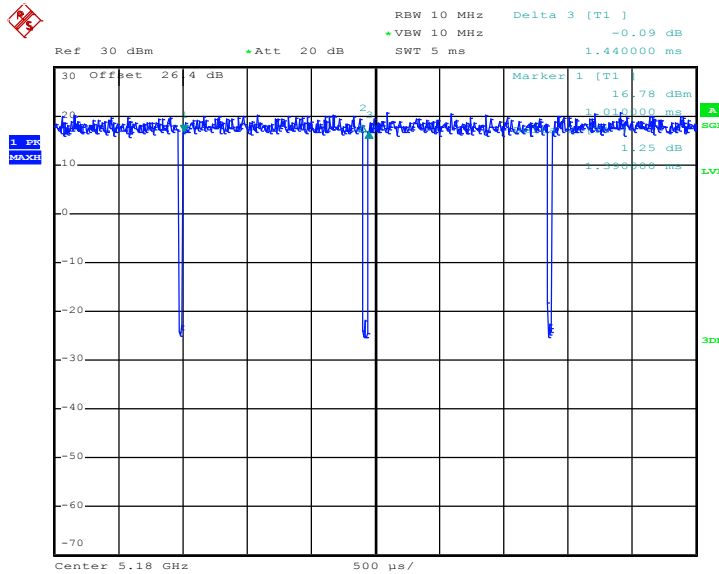

Date: 24.AUG.2017 10:55:28





802.11n HT20

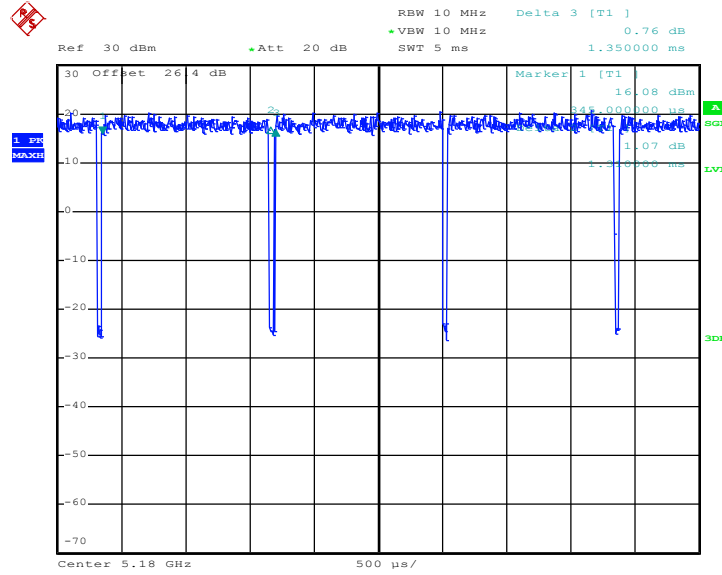

Date: 24.AUG.2017 10:56:16

802.11n HT40

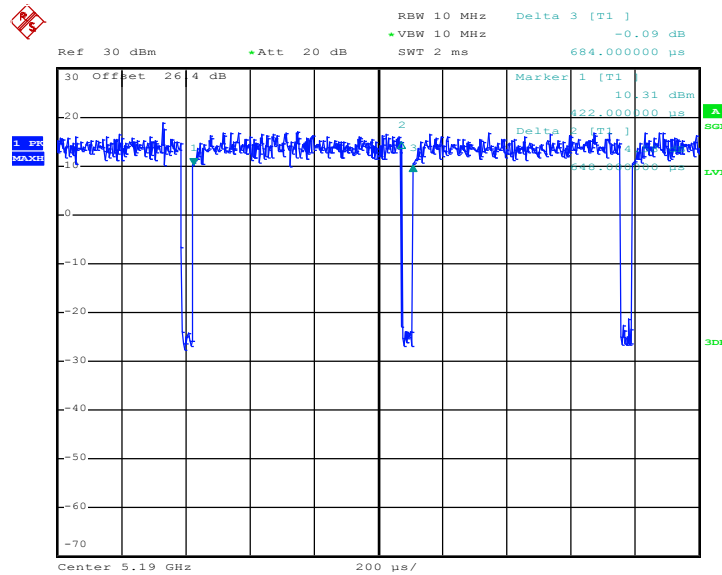

Date: 24.AUG.2017 10:57:19