



FCC RF Test Report

APPLICANT : Sony Mobile Communications Inc.
EQUIPMENT : GSM/WCDMA/LTE Phone+Bluetooth, DTS/UNII
a/b/g/n and NFC
BRAND NAME : Sony
FCC ID : PY7-35228S
STANDARD : FCC Part 15 Subpart E §15.407
CLASSIFICATION : (NII) Unlicensed National Information Infrastructure

The product was received on Aug. 21, 2017 and testing was completed on Sep. 14, 2017. We, SPORTON INTERNATIONAL INC., would like to declare that the tested sample has been evaluated in accordance with the test procedures and has been in compliance with the applicable technical standards.

The test results in this report apply exclusively to the tested model / sample. Without written approval of SPORTON INTERNATIONAL INC., the test report shall not be reproduced except in full.

Reviewed by: Joseph Lin / Supervisor

Approved by: Jones Tsai / Manager



SPORTON INTERNATIONAL INC.

No. 52, Hwa Ya 1st Rd., Hwa Ya Technology Park, Kwei-Shan District, Tao Yuan City, Taiwan, R.O.C.

SPORTON INTERNATIONAL INC.
TEL : 886-3-327-3456
FAX : 886-3-328-4978
FCC ID : PY7-35228S

Page Number : 1 of 33
Report Issued Date : Oct. 30, 2017
Report Version : Rev. 01
Report Template No.: BU5-FR15EWL Version 2.0



TABLE OF CONTENTS

SUMMARY OF TEST RESULT 4

1 GENERAL DESCRIPTION 5

 1.1 Applicant 5

 1.2 Manufacturer 5

 1.3 Product Feature of Equipment Under Test 5

 1.4 Modification of EUT 6

 1.5 Testing Location 7

 1.6 Applicable Standards 7

2 TEST CONFIGURATION OF EQUIPMENT UNDER TEST 8

 2.1 Carrier Frequency Channel 8

 2.2 Test Mode 10

 2.3 Connection Diagram of Test System 11

 2.4 Support Unit used in test configuration and system 12

 2.5 EUT Operation Test Setup 12

 2.6 Measurement Results Explanation Example 12

3 TEST RESULT 13

 3.1 26dB & 99% Occupied Bandwidth Measurement 13

 3.2 Maximum Conducted Output Power Measurement 15

 3.3 Power Spectral Density Measurement 17

 3.4 Unwanted Radiated Emission Measurement 20

 3.5 AC Conducted Emission Measurement 26

 3.6 Frequency Stability Measurement 28

 3.7 Automatically Discontinue Transmission 29

 3.8 Antenna Requirements 30

4 LIST OF MEASURING EQUIPMENTS 31

5 UNCERTAINTY OF EVALUATION 33

APPENDIX A. CONDUCTED TEST RESULTS

APPENDIX B. AC CONDUCTED EMISSION TEST RESULT

APPENDIX C. RADIATED SPURIOUS EMISSION

APPENDIX D. RADIATED SPURIOUS EMISSION PLOTS

APPENDIX E. DUTY CYCLE PLOTS



REVISION HISTORY

REPORT NO.	VERSION	DESCRIPTION	ISSUED DATE
FR782113E	Rev. 01	Initial issue of report	Oct. 30, 2017



SUMMARY OF TEST RESULT

Report Section	FCC Rule	Description	Limit	Result	Remark
3.1	2.1049 15.403(i)	26dB & 99% Bandwidth	-	Pass	-
3.2	15.407(a)	Maximum Conducted Output Power	≤ 24 dBm (depend on band)	Pass	-
3.3	15.407(a)	Power Spectral Density	≤ 11 dBm (depend on band)	Pass	-
3.4	15.407(b)	Unwanted Emissions	15.407(b) 15.209(a)	Pass	Under limit 3.01 dB at 15690.000 MHz
3.5	15.207	AC Conducted Emission	15.207(a)	Pass	Under limit 8.00 dB at 3.014 MHz
3.6	15.407(g)	Frequency Stability	Within Operation Band	Pass	-
3.7	15.407(c)	Automatically Discontinue Transmission	Discontinue Transmission	Pass	-
3.8	15.203 & 15.407(a)	Antenna Requirement	N/A	Pass	-



1 General Description

1.1 Applicant

Sony Mobile Communications Inc.

4-12-3 Higashi-Shinagawa, Shinagawa-ku, Tokyo, 140-0002, Japan

1.2 Manufacturer

Sony Mobile Communications Inc.

4-12-3 Higashi-Shinagawa, Shinagawa-ku, Tokyo, 140-0002, Japan

1.3 Product Feature of Equipment Under Test

GSM/WCDMA/LTE, Bluetooth, DTS/UNII a/b/g/n, FM Receiver, NFC, and GPS.

Standards-related Product Specification	
Antenna Type	PIFA Antenna
Antenna Gain	<5150 MHz ~ 5250 MHz> -1.20 dBi
	<5250 MHz ~ 5350 MHz> -1.40 dBi
	<5470 MHz ~ 5725 MHz> -1.40 dBi
	-1.40 dBi

EUT Information List			
HW Version	SW Version	S/N	Performed Test Item
A	1.8	WUJ01Q223V	RF conducted measurement
		WUJ01Q2211	Radiated Spurious Emission
		WUJ01Q223T	AC Conducted Emission



Accessory List	
AC Adapter	Model Name: EP800
	S/N:
	2916W46610569 (for radiated emission) 3015W41612282 (for conducted emission)
Earphone	Model Name: MH410c
	S/N: N/A
USB Cable	Model Name: UCB20
	S/N:
	1635A91C00314D8 (for radiated emission) 1635A9100031498 (for conducted emission)

Note:

1. Above EUT list and accessory list used are electrically identical per declared by manufacturer.
2. Above the accessories list are used to exercise the EUT during test.
3. For other wireless features of this EUT, test report will be issued separately.

1.4 Modification of EUT

No modifications are made to the EUT during all test items.



1.5 Testing Location

Sporton Lab is accredited to ISO 17025 by Taiwan Accreditation Foundation (TAF code : 1190) and the FCC designation No. TW1190 and TW0007 under the FCC 2.948(e) by Mutual Recognition Agreement (MRA) in FCC Test.

Test Site	SPORTON INTERNATIONAL INC.	
Test Site Location	No. 52, Hwa Ya 1 st Rd., Hwa Ya Technology Park, Kwei-Shan District, Tao Yuan City, Taiwan, R.O.C. TEL: +886-3-327-3456 FAX: +886-3-328-4978	
Test Site No.	Sporton Site No.	
	TH05-HY	CO05-HY

Note: The test site complies with ANSI C63.4 2014 requirement.

Test Site	SPORTON INTERNATIONAL INC.	
Test Site Location	No.58, Aly. 75, Ln. 564, Wenhua 3rd Rd. Guishan Dist, Taoyuan City, Taiwan (R.O.C.) TEL: +886-3-327-0868 FAX: +886-3-327-0855	
Test Site No.	Sporton Site No.	
	03CH10-HY	

Note: The test site complies with ANSI C63.4 2014 requirement.

1.6 Applicable Standards

According to the specifications of the manufacturer, the EUT must comply with the requirements of the following standards:

- ♦ FCC Part 15 Subpart E
- ♦ FCC KDB 789033 D02 General UNII Test Procedures New Rules v01r04.
- ♦ ANSI C63.10-2013

Remark:

1. All test items were verified and recorded according to the standards and without any deviation during the test.
2. This EUT has also been tested and complied with the requirements of FCC Part 15, Subpart B, recorded in a separate test report.



2 Test Configuration of Equipment Under Test

- a. The EUT has been associated with peripherals and configuration operated in a manner tended to maximize its emission characteristics in a typical application. Frequency range investigated: conduction emission (150 kHz to 30 MHz), radiation emission (9 kHz to the 10th harmonic of the highest fundamental frequency or to 40 GHz, whichever is lower). For radiated measurement, pre-scanned in three orthogonal panels, X, Y, Z. The worst cases (X plane) were recorded in this report.
- b. AC power line Conducted Emission was tested under maximum output power.

2.1 Carrier Frequency Channel

Frequency Band	Channel	Freq. (MHz)	Channel	Freq. (MHz)
5150-5250 MHz Band 1 (U-NII-1)	36	5180	44	5220
	38*	5190	46*	5230
	40	5200	48	5240
	-	-		

Frequency Band	Channel	Freq. (MHz)	Channel	Freq. (MHz)
5250-5350 MHz Band 2 (U-NII-2A)	52	5260	60	5300
	54*	5270	62*	5310
	56	5280	64	5320
	-	-		



Frequency Band	Channel	Freq. (MHz)	Channel	Freq. (MHz)
5470-5725 MHz Band 3 (U-NII-2C)	100	5500	112	5560
	102*	5510	116	5580
	104	5520	132	5660
	-	-	134*	5670
	108	5540	136	5680
	110*	5550	140	5700

Frequency Band	Channel	Freq. (MHz)	Channel	Freq. (MHz)
Straddle Channel	-	-	144	5720
	142*	5710		

Note: The above Frequency and Channel in "*" were 802.11n HT40.



2.2 Test Mode

Final test mode of conducted test items and radiated spurious emissions are considering the modulation and worse data rates as below table.

Modulation	Data Rate
802.11a	6 Mbps
802.11n HT20	MCS0
802.11n HT40	MCS0

Test Cases	
AC Conducted Emission	Mode 1 : Bluetooth Link + WLAN (5GHz) Link + Earphone + Battery + USB Cable (Charging from Adapter)

Ch. #		Band I : 5150-5250 MHz	Band II : 5250-5350 MHz	Band III : 5470-5725MHz
		802.11a	802.11a	802.11a
L	Low	36	52	100
M	Middle	44	60	116
H	High	48	64	140
Straddle		-	-	144

Ch. #		Band I : 5150-5250 MHz	Band II : 5250-5350 MHz	Band III : 5470-5725MHz
		802.11n HT20	802.11n HT20	802.11n HT20
L	Low	36	52	100
M	Middle	44	60	116
H	High	48	64	140
Straddle		-	-	144

Ch. #		Band I : 5150-5250 MHz	Band II : 5250-5350 MHz	Band III : 5470-5725MHz
		802.11n HT40	802.11n HT40	802.11n HT40
L	Low	38	54	102
M	Middle	-	-	110
H	High	46	62	134
Straddle		-	-	142

2.3 Connection Diagram of Test System

<WLAN Tx Mode>

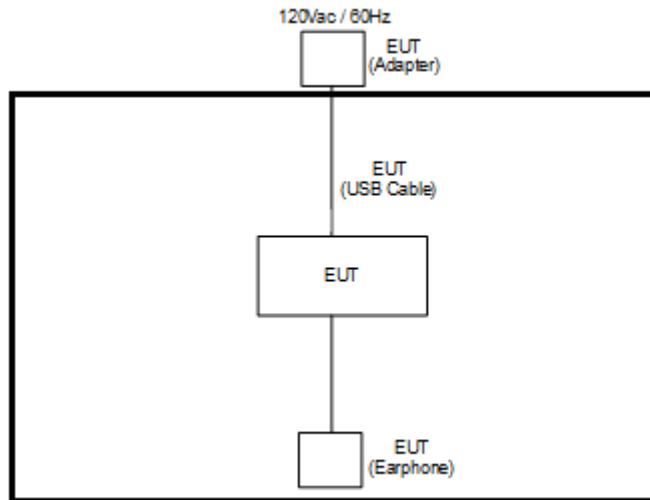

<AC Conducted Emission Mode>

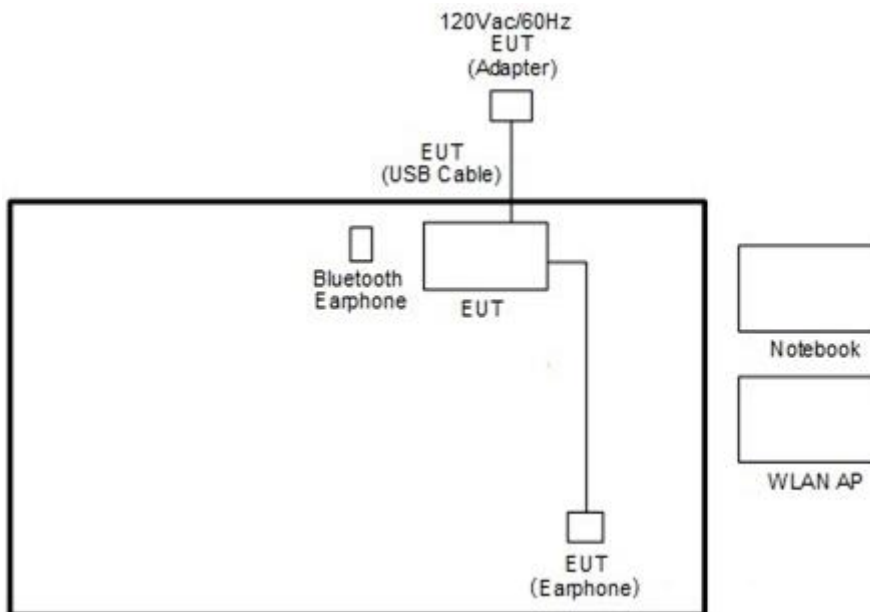



2.4 Support Unit used in test configuration and system

Item	Equipment	Trade Name	Model Name	FCC ID	Data Cable	Power Cord
1.	Bluetooth Earphone	Sony	SBH20	PY7-RD0010	N/A	N/A
2.	WLAN AP	ASUS	RT-AC66U	MSQ-RTAC66U	N/A	Unshielded, 1.8 m
3.	Notebook	DELL	Latitude E6320	FCC DoC/ Contains FCC ID: QDS-BRCM1054	N/A	AC I/P: Unshielded, 1.2 m DC O/P: Shielded, 1.8 m
4.	SD Card	SanDisk	MicroSD HC	FCC DoC	N/A	N/A

2.5 EUT Operation Test Setup

The RF test items, an engineering test program was provided and enabled to make EUT continuous transmit.

2.6 Measurement Results Explanation Example

For all conducted test items:

The offset level is set in the spectrum analyzer to compensate the RF cable loss and attenuator factor between EUT conducted output port and spectrum analyzer. With the offset compensation, the spectrum analyzer reading level is exactly the EUT RF output level.

Example :

The spectrum analyzer offset is derived from RF cable loss and attenuator factor.

Offset = RF cable loss + attenuator factor.

Following shows an offset computation example with cable loss 4.2 dB and 10dB attenuator.

$$\begin{aligned}
 \text{Offset(dB)} &= \text{RF cable loss(dB)} + \text{attenuator factor(dB)}. \\
 &= 4.2 + 10 = 14.2 \text{ (dB)}
 \end{aligned}$$

3 Test Result

3.1 26dB & 99% Occupied Bandwidth Measurement

3.1.1 Description of 26dB & 99% Occupied Bandwidth

This section is for reporting purpose only.

There is no restriction limits for bandwidth.

For Straddle Channel, According to KDB 789033 D02 General UNII Test Procedures New Rules v01r04, If the power and PSD of the devices are uniform and comply with the lower limits specified for the U-NII-2 bands, a single measurement over the entire emission bandwidth can be performed to show compliance.

3.1.2 Measuring Instruments

The measuring equipment is listed in the section 4 of this test report.

3.1.3 Test Procedures

1. The testing follows FCC KDB 789033 D02 General UNII Test Procedures New Rules v01r04. Section C) Emission bandwidth
2. Set RBW = approximately 1% of the emission bandwidth.
3. Set the VBW > RBW.
4. Detector = Peak.
5. Trace mode = max hold
6. Measure the maximum width of the emission that is 26 dB down from the peak of the emission. Compare this with the RBW setting of the analyzer. Readjust RBW and repeat measurement as needed until the RBW/EBW ratio is approximately 1%.
7. For 99% Bandwidth Measurement, the spectrum analyzer's resolution bandwidth (RBW) is set 1MHz and set the Video bandwidth (VBW) $\geq 3 * RBW$.
8. Measure and record the results in the test report.

3.1.4 Test Setup

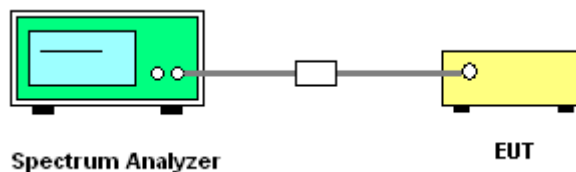



3.1.5 Test Result of 26dB & 99% Occupied Bandwidth Plots

Please refer to Appendix A.

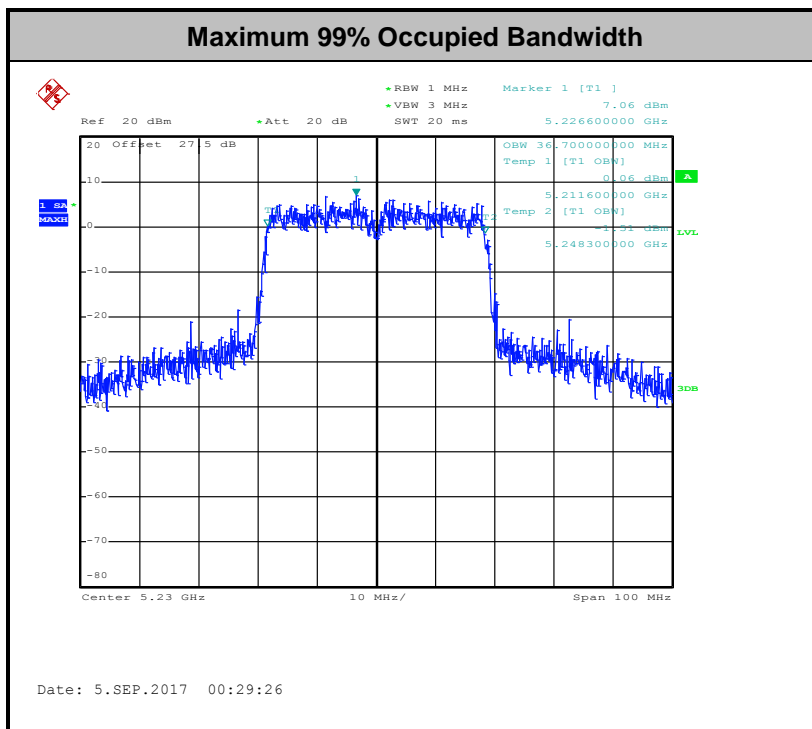
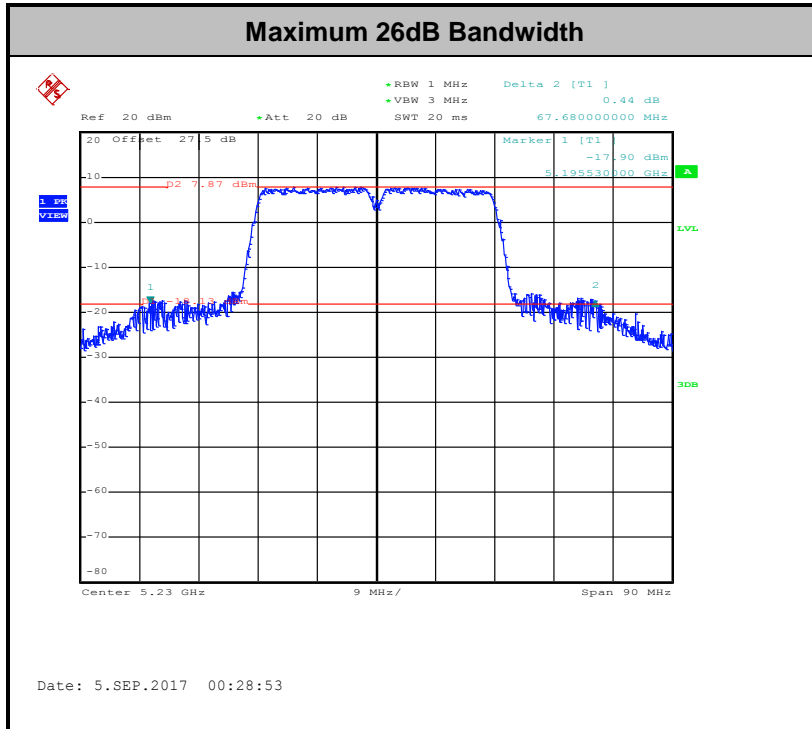

Note : The occupied channel bandwidth is maintained within the band of operation for all of the modulations.



3.2 Maximum Conducted Output Power Measurement

3.2.1 Limit of Maximum Conducted Output Power

<FCC 14-30 CFR 15.407>

For mobile and portable client devices in the 5.15–5.25 GHz band, the maximum conducted output power over the frequency band of operation shall not exceed 250 mW.

For the 5.25–5.725 GHz bands, the maximum conducted output power over the frequency bands of operation shall not exceed the lesser of 250 mW or $11 \text{ dBm} + 10 \log B$, where B is the 26 dB emission bandwidth in megahertz.

If transmitting antennas of directional gain greater than 6 dBi are used, the peak output power shall be reduced by the amount in dB that the directional gain of the antenna exceeds 6 dBi.

Note that U-NII-2 band, devices with a maximum e.i.r.p. greater than 500 mW shall implement TPC in order to have the capability to operate at least 6 dB below the maximum permitted e.i.r.p. of 1 W.

For Straddle Channel, According to KDB 789033 D02 General UNII Test Procedures New Rules v01r04. If the power and PSD of the devices are uniform and comply with the lower limits specified for the U-NII-2 bands, a single measurement over the entire emission bandwidth can be performed to show compliance.

3.2.2 Measuring Instruments

The measuring equipment is listed in the section 4 of this test report.

3.2.3 Test Procedures

The testing follows Method PM of FCC KDB 789033 D02 General UNII Test Procedures New Rules v01r04.

Method PM (Measurement using an RF average power meter):

1. Measurement is performed using a wideband RF power meter.
2. The EUT is configured to transmit continuously with a consistent duty cycle at its maximum power control level.
3. Measure the average power of the transmitter, and the average power is corrected with duty factor, $10 \log(1/x)$, where x is the duty cycle.

3.2.4 Test Setup

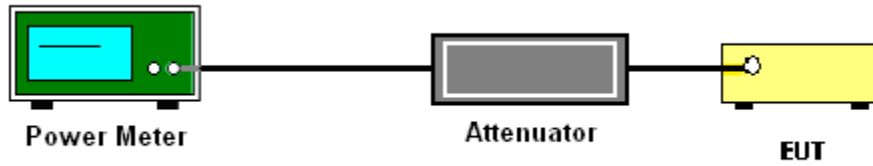

3.2.5 Test Result of Maximum Conducted Output Power

Please refer to Appendix A.



3.3 Power Spectral Density Measurement

3.3.1 Limit of Power Spectral Density

<FCC 14-30 CFR 15.407>

For mobile and portable client devices in the 5.15–5.25 GHz band, the maximum power spectral density shall not exceed 11dBm in any 1 megahertz band.

For the 5.25–5.725 GHz bands, the maximum power spectral density shall not exceed 11 dBm in any 1 megahertz band.

If transmitting antennas of directional gain greater than 6 dBi are used, the peak output power shall be reduced by the amount in dB that the directional gain of the antenna exceeds 6 dBi.

For Straddle Channel, According to KDB 789033 D02 General UNII Test Procedures New Rules v01r04, If the power and PSD of the devices are uniform and comply with the lower limits specified for the U-NII-2 bands, a single measurement over the entire emission bandwidth can be performed to show compliance.

3.3.2 Measuring Instruments

The measuring equipment is listed in the section 4 of this test report.

3.3.3 Test Procedures

The testing follows FCC KDB 789033 D02 General UNII Test Procedures New Rules v01r04.
Section F) Maximum power spectral density.

Method SA-2

(trace averaging across on and off times of the EUT transmissions, followed by duty cycle correction).

1. The testing follows Method SA-2 of FCC KDB 789033 D02 General UNII Test Procedures New Rules v01r04.
 - Measure the duty cycle.
 - Set span to encompass the entire emission bandwidth (EBW) of the signal.
 - Set RBW = 1 MHz.
 - Set VBW \geq 3 MHz.
 - Number of points in sweep \geq 2 Span / RBW.
 - Sweep time = auto.
 - Detector = RMS
 - Trace average at least 100 traces in power averaging mode.
 - Add $10 \log(1/x)$, where x is the duty cycle, to the measured power in order to compute the average power during the actual transmission times. For example, add $10 \log(1/0.25) = 6$ dB if the duty cycle is 25 percent.
2. The RF output of EUT was connected to the spectrum analyzer by a low loss cable.
3. Each plot has already offset with cable loss, and attenuator loss. Measure the PPSD and record it.

3.3.4 Test Setup

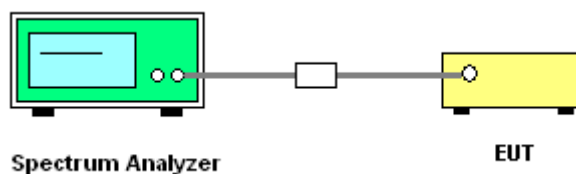



3.3.5 Test Result of Power Spectral Density

Please refer to Appendix A.

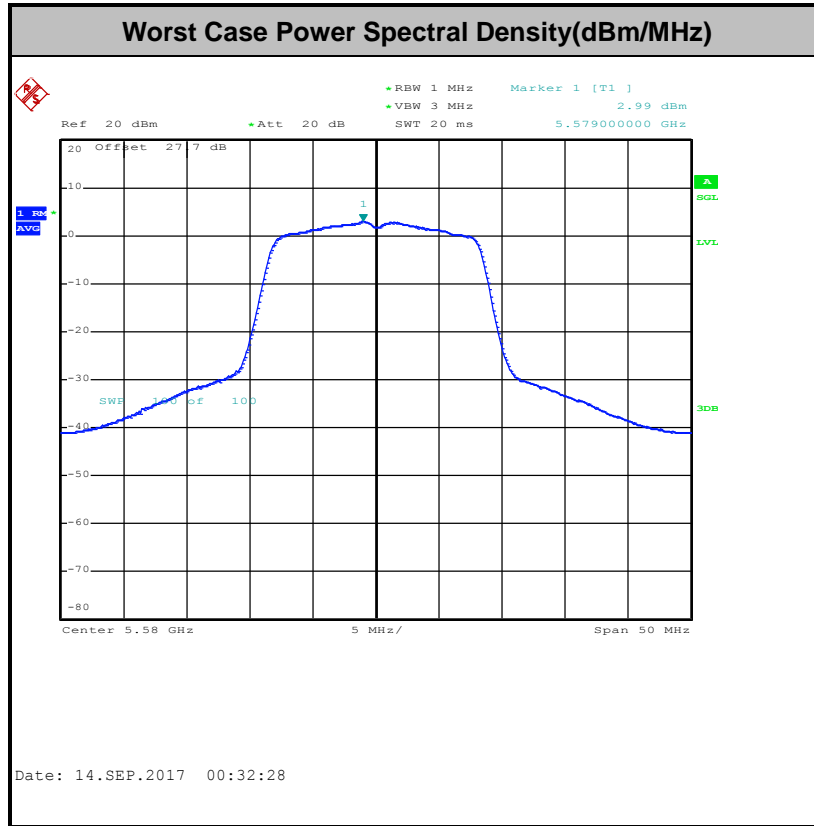

Note: Average Power Density (dB) = Measured value+ Duty Factor



3.4 Unwanted Radiated Emission Measurement

This section is to measure unwanted emissions through radiated measurement for band edge spurious emissions and out of band emissions measurement.

3.4.1 Limit of Unwanted Emissions

- (1) For transmitters operating in the 5150-5250 MHz band: all emissions outside of the 5150-5350 MHz band shall not exceed an EIRP of -27dBm/MHz.

For transmitters operating in the 5250-5350 MHz band: all emissions outside of the 5150-5350 MHz band shall not exceed an EIRP of -27 dBm/MHz. Devices operating in the 5250-5350 MHz band that generate emissions in the 5150-5250 MHz band must meet all applicable technical requirements for operation in the 5150-5250 MHz band (including indoor use) or alternatively meet an out-of-band emission EIRP limit of -27 dBm/MHz in the 5150-5250 MHz band.

For transmitters operating in the 5470-5725MHz band: all emissions outside of the 5470-5725MHz band shall not exceed an EIRP of -27 dBm/MHz.

- (2) Unwanted spurious emissions fallen in restricted bands shall comply with the general field strength limits as below table,

Frequency (MHz)	Field Strength (microvolts/meter)	Measurement Distance (meters)
0.009 – 0.490	2400/F(kHz)	300
0.490 – 1.705	24000/F(kHz)	30
1.705 – 30.0	30	30
30 – 88	100	3
88 – 216	150	3
216 - 960	200	3
Above 960	500	3

Note: The following formula is used to convert the EIRP to field strength.

$$E = \frac{1000000\sqrt{30P}}{3} \mu\text{V/m, where P is the eirp (Watts)}$$



EIRP (dBm)	Field Strength at 3m (dBµV/m)
-17	78.3
- 27	68.3

(3) KDB789033 D02 v01r04 G)2)c)

- (i) Sections 15.407(b)(1) to (b)(3) specify the unwanted emission limits for the U-NII-1 and U-NII-2 bands. As specified, emissions above 1000 MHz that are outside of the restricted bands are subject to a peak emission limit of -27 dBm/MHz.³
- (ii) Section 15.407(b)(4) specifies the unwanted emission limit for the U-NII-3 band. A band emissions mask is specified in Section 15.407(b)(4)(i). The emission limits are in terms of a Peak detector. An alternative to the band emissions mask is specified in Section 15.407(b)(4)(ii). The alternative limits are based on the highest antenna gain specified in the filing. There are also marketing and importation restrictions for the devices using the alternative limit.⁴

Note 3: An out-of-band emission that complies with both the average and peak limits of Section 15.209 is not required to satisfy the -27 dBm/MHz peak emission limit.

Note 4: Only devices with antenna gains of 10 dBi or less may be approved using the emission limits specified in Section 15.247(d) till March 2, 2018; all other devices operating in this band must use the mask specified in Section 15.407(b)(4)(i).

3.4.2 Measuring Instruments

The measuring equipment is listed in the section 4 of this test report.



3.4.3 Test Procedures

1. The testing follows FCC KDB 789033 D02 General UNII Test Procedures New Rules v01r04.
Section G) Unwanted emissions measurement.

(1) Procedure for Unwanted Emissions Measurements Below 1000MHz

- RBW = 120 kHz
- VBW = 300 kHz
- Detector = Peak
- Trace mode = max hold

(2) Procedure for Peak Unwanted Emissions Measurements Above 1000 MHz

- RBW = 1 MHz
- VBW \geq 3 MHz
- Detector = Peak
- Sweep time = auto
- Trace mode = max hold

(3) Procedures for Average Unwanted Emissions Measurements Above 1000MHz

- RBW = 1 MHz
- VBW = 10 Hz, when duty cycle is no less than 98 percent.
- VBW \geq 1/T, when duty cycle is less than 98 percent where T is the minimum transmission duration over which the transmitter is on and is transmitting at its maximum power control level for the tested mode of operation.

2. The EUT was placed on a turntable with 0.8 meter for frequency below 1GHz and 1.5 meter for frequency above 1GHz respectively above ground.
3. The EUT was set 3 meters from the interference receiving antenna which was mounted on the top of a variable height antenna tower.
4. The antenna is a broadband antenna and its height is adjusted between one meter and four meters above ground to find the maximum value of the field strength for both horizontal polarization and vertical polarization of the antenna.
5. For each suspected emission, the EUT was arranged to its worst case and then adjust the antenna tower (from 1 m to 4 m) and turntable (from 0 degree to 360 degrees) to find the maximum reading.
6. For testing below 1GHz, if the emission level of the EUT in peak mode was 3 dB lower than the limit specified, then peak values of EUT will be reported, otherwise, the emissions will be repeated one by one using the CISPR quasi-peak method and reported.
7. For testing above 1GHz, the emission level of the EUT in peak mode was 20dB lower than average limit (that means the emission level in average mode also complies with the limit in average mode), then peak values of EUT will be reported, otherwise, the emissions will be measured in average mode again and reported.

3.4.4 Test Setup

For radiated emissions below 30MHz

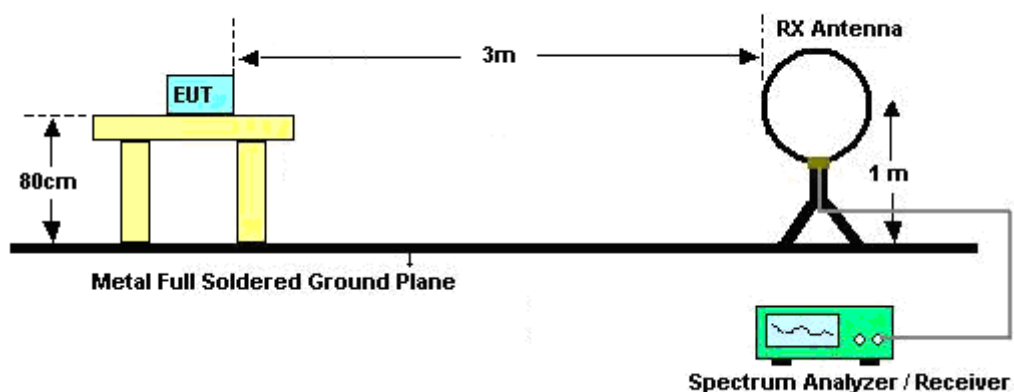

For radiated emissions from 30MHz to 1GHz

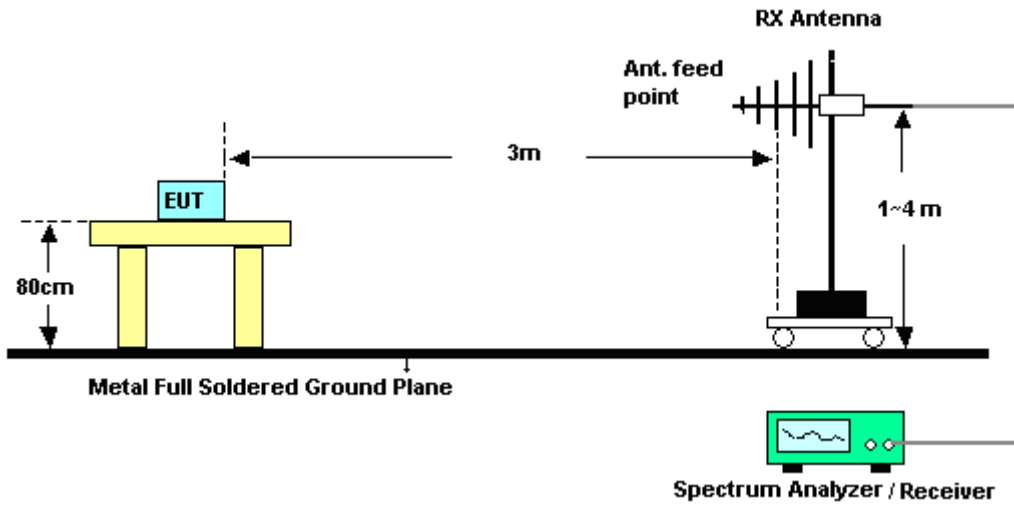

For radiated emissions above 1GHz

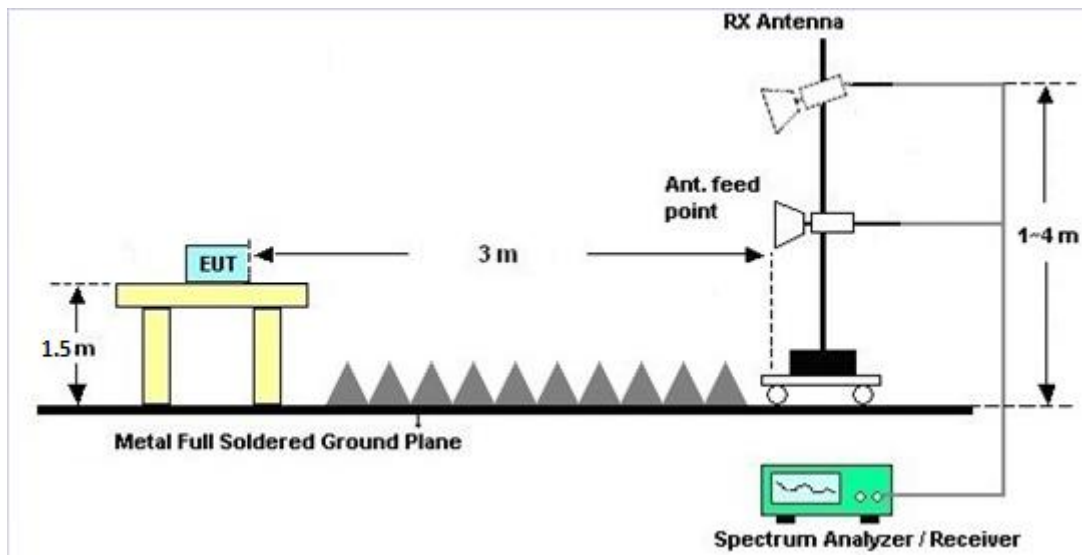



3.4.5 Test Results of Radiated Spurious Emissions (9 kHz ~ 30 MHz)

The low frequency, which started from 9 kHz to 30MHz, was pre-scanned and the result which was 20dB lower than the limit line was not reported.

There is a comparison data of both open-field test site and semi-Anechoic chamber, and the result came out very similar.

3.4.6 Test Result of Radiated Spurious at Band Edges

Please refer to Appendix C and D.

3.4.7 Duty Cycle

Please refer to Appendix E.

3.4.8 Test Result of Radiated Spurious Emissions (30MHz ~ 10th Harmonic)

Please refer to Appendix C and D.



3.5 AC Conducted Emission Measurement

3.5.1 Limit of AC Conducted Emission

For equipment that is designed to be connected to the public utility (AC) power line, the radio frequency voltage that is conducted back onto the AC power line on any frequency or frequencies within the band 150 kHz to 30 MHz shall not exceed the limits in the following table.

Frequency of emission (MHz)	Conducted limit (dB μ V)	
	Quasi-peak	Average
0.15-0.5	66 to 56*	56 to 46*
0.5-5	56	46
5-30	60	50

*Decreases with the logarithm of the frequency.

3.5.2 Measuring Instruments

The measuring equipment is listed in the section 4 of this test report.

3.5.3 Test Procedures

1. The EUT was placed 0.4 meter from the conducting wall of the shielding room was kept at least 80 centimeters from any other grounded conducting surface.
2. Connect EUT to the power mains through a line impedance stabilization network (LISN).
3. All the support units are connecting to the other LISN.
4. The LISN provides 50 ohm coupling impedance for the measuring instrument.
5. The FCC states that a 50 ohm, 50 microhenry LISN should be used.
6. Both sides of AC line were checked for maximum conducted interference.
7. The frequency range from 150 kHz to 30 MHz was searched.
8. Set the test-receiver system to Peak Detect Function and specified bandwidth with Maximum Hold Mode.

3.5.4 Test Setup

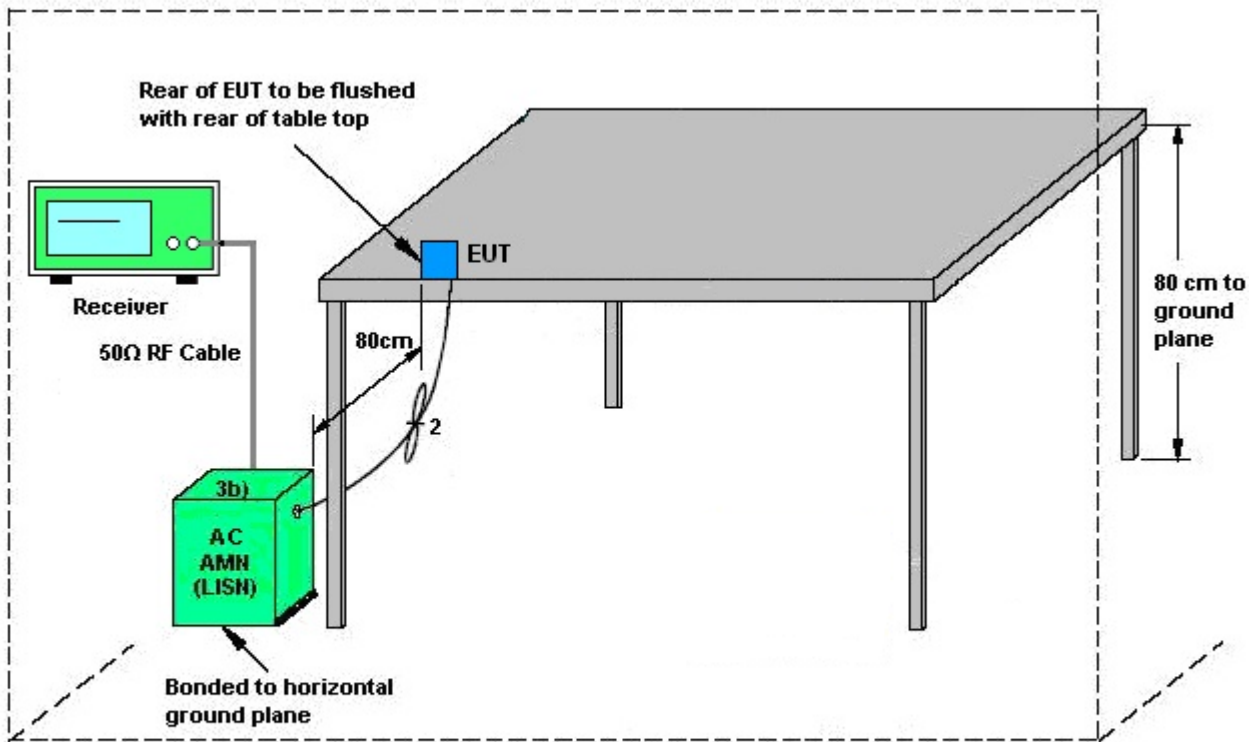

AMN = Artificial mains network (LISN)
AE = Associated equipment
EUT = Equipment under test
ISN = Impedance stabilization network

3.5.5 Test Result of AC Conducted Emission

Please refer to Appendix B.

3.6 Frequency Stability Measurement

3.6.1 Limit of Frequency Stability

Manufacturers of U-NII devices are responsible for ensuring frequency stability such that an emission is maintained within the band of operation under all conditions of normal operation as specified in the user's manual.

3.6.2 Measuring Instruments

The measuring equipment is listed in the section 4 of this test report.

3.6.3 Test Procedures

1. To ensure emission at the band edge is maintained within the authorized band, those values shall be measured by radiation emissions at upper and lower frequency points, and finally compensated by frequency deviation as procedures below.
2. The EUT was operated at the maximum output power, and connected to the spectrum analyzer, which is set to maximum hold function and peak detector. The peak value of the power envelope was measured and noted. The upper and lower frequency points were respectively measured relatively 10dB lower than the measured peak value.
3. The frequency deviation was calculated by adding the upper frequency point and the lower frequency point divided by two. Those detailed values of frequency deviation are provided in table below.

3.6.4 Test Setup

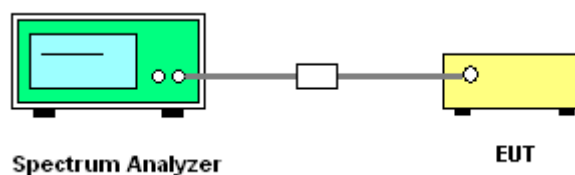

3.6.5 Test Result of Frequency Stability

Please refer to Appendix A.



3.7 Automatically Discontinue Transmission

3.7.1 Limit of Automatically Discontinue Transmission

The device shall automatically discontinue transmission in case of either absence of information to transmit or operational failure. These provisions are not intended to preclude the transmission of control or signaling information or the use of repetitive codes used by certain digital technologies to complete frame or burst intervals. Applicants shall include in their application for equipment authorization to describe how this requirement is met.

3.7.2 Measuring Instruments

The measuring equipment is listed in the section 4 of this test report.

3.7.3 Test Result of Automatically Discontinue Transmission

While the EUT is not transmitting any information, the EUT can automatically discontinue transmission and become standby mode for power saving. The EUT can detect the controlling signal of ACK message transmitting from remote device and verify whether it shall resend or discontinue transmission.



3.8 Antenna Requirements

3.8.1 Standard Applicable

If transmitting antenna directional gain is greater than 6 dBi, both the peak transmit power and the peak power spectral density shall be reduced by the amount in dB that the directional gain of the antenna exceeds 6 dBi.

3.8.2 Antenna Anti-Replacement Construction

An embedded-in antenna design is used.

3.8.3 Antenna Gain

The antenna gain is less than 6 dBi. Therefore, it is not necessary to reduce maximum peak output power limit.



4 List of Measuring Equipments

Instrument	Manufacturer	Model No.	Serial No.	Characteristics	Calibration Date	Test Date	Due Date	Remark
Power Meter	Anritsu	ML2495A	0932001	N/A	Sep. 29, 2016	Aug. 24, 2017 ~ Sep. 14, 2017	Sep. 28, 2017	Conducted (TH05-HY)
Power Sensor	Anritsu	MA2411B	0846202	300MHz~40GHz	Sep. 29, 2016	Aug. 24, 2017 ~ Sep. 14, 2017	Sep. 28, 2017	Conducted (TH05-HY)
Spectrum Analyzer	Rohde & Schwarz	FSP30	101067	9kHz ~ 30GHz	Nov. 17, 2016	Aug. 24, 2017 ~ Sep. 14, 2017	Nov. 16, 2017	Conducted (TH05-HY)
Hygrometer	TECEPEL	DTM-303B	TP157151	N/A	Mar. 20, 2017	Aug. 24, 2017 ~ Sep. 14, 2017	Mar. 19, 2018	Conducted (TH05-HY)
RF Cable	HUBER + SUHNER	SUCOFLEX 104	MY84209521	1GHz~26GHz	Dec. 02, 2016	Aug. 24, 2017 ~ Sep. 14, 2017	Dec. 01, 2017	Conducted (TH05-HY)
Temperature Chamber	ESPEC	SU-241	92003713	-30°C ~95°C	Jun. 07, 2017	Aug. 24, 2017 ~ Sep. 14, 2017	Jun. 06, 2018	Conducted (TH05-HY)
AC Power Source	ChainTek	APC-1000W	N/A	N/A	N/A	Aug. 26, 2017	N/A	Conduction (CO05-HY)
EMI Test Receiver	Rohde & Schwarz	ESCI 7	100724	9kHz~7GHz	Aug. 30, 2016	Aug. 26, 2017	Aug. 29, 2017	Conduction (CO05-HY)
Hygrometer	Testo	608-H1	34913912	N/A	May 02, 2017	Aug. 26, 2017	May 01, 2018	Conduction (CO05-HY)
LISN	Rohde & Schwarz	ENV216	100080	9kHz~30MHz	Nov. 29, 2016	Aug. 26, 2017	Nov. 28, 2017	Conduction (CO05-HY)
LF Cable	HUBER + SUHNER	RG-214/U	LF01	N/A	Jan. 05, 2017	Aug. 26, 2017	Jan. 04, 2018	Conduction (CO05-HY)
Test Software	N/A	EMC32	8.40.0	N/A	N/A	Aug. 26, 2017	N/A	Conduction (CO05-HY)
Loop Antenna	Rohde & Schwarz	HFH2-Z2	100315	9 kHz~30 MHz	May 15, 2017	Aug. 29, 2017 ~ Sep. 05, 2017	May 14, 2019	Radiation (03CH10-HY)
Bilog Antenna	TESEQ	CBL 6111D&00800 N1D01N-06	35413&02	30MHz~1GHz	Jan. 07, 2017	Aug. 29, 2017 ~ Sep. 05, 2017	Jan. 06, 2018	Radiation (03CH10-HY)
Horn Antenna	SCHWARZBECK	BBHA 9120 D	9120D-1325	1GHz ~ 18GHz	Sep. 30, 2016	Aug. 29, 2017 ~ Sep. 05, 2017	Sep. 29, 2017	Radiation (03CH10-HY)
SHF-EHF Horn Antenna	SCHWARZBECK	BBHA 9170	BBHA9170584	18GHz- 40GHz	Nov. 08, 2016	Aug. 29, 2017 ~ Sep. 05, 2017	Nov. 07, 2017	Radiation (03CH10-HY)
Spectrum Analyzer	Keysight	N9010A	MY54200485	10Hz ~ 44GHz	Oct. 17, 2016	Aug. 29, 2017 ~ Sep. 05, 2017	Oct. 16, 2017	Radiation (03CH10-HY)
EMI Test Receiver	Agilent	N9038A(MXE)	MY53290045	20Hz to 8.4GHz	Jan. 19, 2017	Aug. 29, 2017 ~ Sep. 05, 2017	Jan. 18, 2018	Radiation (03CH10-HY)
Amplifier	SONOMA	310N	187311	9kHz~1GHz	Oct. 26, 2016	Aug. 29, 2017 ~ Sep. 05, 2017	Oct. 25, 2017	Radiation (03CH10-HY)
Preamplifier	Keysight	83017A	MY53270078	1GHz~26.5GHz	Oct. 26, 2016	Aug. 29, 2017 ~ Sep. 05, 2017	Oct. 25, 2017	Radiation (03CH10-HY)
Preamplifier	MITEQ	TTA1840-35-HG	1871923	18GHz~40GHz, VSWR : 2.5:1 max	Jul. 21, 2017	Aug. 29, 2017 ~ Sep. 05, 2017	Jul. 20, 2018	Radiation (03CH10-HY)
Preamplifier	MITEQ	AMF-7D-0010 1800	2025787	1GHz~18GHz	Feb. 13, 2017	Aug. 29, 2017 ~ Sep. 05, 2017	Feb. 12, 2018	Radiation (03CH10-HY)



Instrument	Manufacturer	Model No.	Serial No.	Characteristics	Calibration Date	Test Date	Due Date	Remark
Hygrometer	TECPEL	DTM-303B	TP140320	N/A	Nov. 14, 2016	Aug. 29, 2017 ~ Sep. 05, 2017	Nov. 13, 2017	Radiation (03CH10-HY)
RF Cable	HUBER + SUHNER	SUCOFLEX 104	MY249564 MY249524 MY283184	25GHz~40GHz	Sep. 30, 2016	Aug. 29, 2017 ~ Sep. 05, 2017	Sep. 29, 2017	Radiation (03CH10-HY)
RF Cable	HUBER + SUHNER	SUCOFLEX 104	MY249564 MY249524 MY283184	30MHz~1GHz	Sep. 30, 2016	Aug. 29, 2017 ~ Sep. 05, 2017	Sep. 29, 2017	Radiation (03CH10-HY)
RF Cable	HUBER + SUHNER	SUCOFLEX 104	MY249564 MY249524 MY283184	1GHz~25GHz	Sep. 30, 2016	Aug. 29, 2017 ~ Sep. 05, 2017	Sep. 29, 2017	Radiation (03CH10-HY)
Controller	EMEC	EM 1000	N/A	Control Turn table & Ant Mast	N/A	Aug. 29, 2017 ~ Sep. 05, 2017	N/A	Radiation (03CH10-HY)
Antenna Mast	EMEC	AM-BS-4500-B	N/A	1~4m	N/A	Aug. 29, 2017 ~ Sep. 05, 2017	N/A	Radiation (03CH10-HY)
Turn Table	EMEC	TT 2200	N/A	0~360 Degree	N/A	Aug. 29, 2017 ~ Sep. 05, 2017	N/A	Radiation (03CH10-HY)
Test Software	Audix	E3	6.2009-8-24	N/A	N/A	Aug. 28, 2017~ Sep. 05, 2017	N/A	Radiation (03CH10-HY)
Filter	Wainwright	WLKS4500-8S S	SN19	4.5G Low Pass	Sep. 19, 2016	Aug. 29, 2017 ~ Sep. 05, 2017	Sep. 18, 2017	Radiation (03CH10-HY)
Filter	Woken	WHKX8-5272. 5-6750-18000- 40ST	SN2	6.75G Highpass	Dec. 08, 2016	Aug. 29, 2017 ~ Sep. 05, 2017	Dec. 07, 2017	Radiation (03CH10-HY)
Filter	Woken	WHKX8-5272. 5-6750-18000- 40ST	SN2	6.75G Highpass	Dec. 08, 2016	Aug. 29, 2017 ~ Sep. 05, 2017	Dec. 07, 2017	Radiation (03CH10-HY)



5 Uncertainty of Evaluation

Uncertainty of Conducted Emission Measurement (150kHz ~ 30MHz)

Measuring Uncertainty for a Level of Confidence of 95% ($U = 2Uc(y)$)	2.70
---	------

Uncertainty of Radiated Emission Measurement (30 MHz ~ 1000 MHz)

Measuring Uncertainty for a Level of Confidence of 95% ($U = 2Uc(y)$)	5.60
---	------

Uncertainty of Radiated Emission Measurement (1000 MHz ~ 18000 MHz)

Measuring Uncertainty for a Level of Confidence of 95% ($U = 2Uc(y)$)	5.90
---	------

Uncertainty of Radiated Emission Measurement (18000 MHz ~ 40000 MHz)

Measuring Uncertainty for a Level of Confidence of 95% ($U = 2Uc(y)$)	5.20
---	------

Appendix A. Test Result of Conducted Test Items

Test Engineer:	Allen Lin/Shiming Liu	Temperature:	21~25	°C
Test Date:	2017/8/24~2017/9/14	Relative Humidity:	51~54	%

TEST RESULTS DATA
26dB and 99% OBW

Band I										
Mod.	Data Rate	NTX	CH.	Freq. (MHz)	99% Bandwidth (MHz)	26 dB Bandwidth (MHz)	IC 99% Bandwidth Power Limit (dBm)	IC 99% Bandwidth EIRP Limit (dBm)		
11a	6Mbps	1	36	5180	17.50	27.65	-	22.43		
11a	6Mbps	1	44	5220	17.50	25.00	-	22.43		
11a	6Mbps	1	48	5240	17.55	26.80	-	22.44		
HT20	MCS0	1	36	5180	18.55	30.60	-	22.68		
HT20	MCS0	1	44	5220	18.50	29.35	-	22.67		
HT20	MCS0	1	48	5240	18.45	34.60	-	22.66		
HT40	MCS0	1	38	5190	36.60	41.04	-	23.01		
HT40	MCS0	1	46	5230	36.70	67.68	-	23.01		

TEST RESULTS DATA
Average Power Table

FCC Band I										
Mod.	Data Rate	NTX	CH.	Freq. (MHz)	Duty Factor (dB)	Average Conducted Power (dBm)	FCC Conducted Power Limit (dBm)	DG (dBi)		Pass/Fail
11a	6Mbps	1	36	5180	0.15	12.85	24.00	-1.20		Pass
11a	6Mbps	1	44	5220	0.15	12.79	24.00	-1.20		Pass
11a	6Mbps	1	48	5240	0.15	12.55	24.00	-1.20		Pass
HT20	MCS0	1	36	5180	0.13	10.73	24.00	-1.20		Pass
HT20	MCS0	1	44	5220	0.13	10.70	24.00	-1.20		Pass
HT20	MCS0	1	48	5240	0.13	10.68	24.00	-1.20		Pass
HT40	MCS0	1	38	5190	0.23	10.83	24.00	-1.20		Pass
HT40	MCS0	1	46	5230	0.23	10.81	24.00	-1.20		Pass

TEST RESULTS DATA
Power Spectral Density

FCC Band I										
Mod.	Data Rate	NTX	CH.	Freq. (MHz)	Duty Factor (dB)	Average Power Density (dBm/MHz)	Average PSD Limit (dBm/MHz)	DG (dBi)	-	Pass/Fail
11a	6Mbps	1	36	5180	0.15	0.66	11.00	-1.20		Pass
11a	6Mbps	1	44	5220	0.15	0.82	11.00	-1.20		Pass
11a	6Mbps	1	48	5240	0.15	0.49	11.00	-1.20		Pass
HT20	MCS0	1	36	5180	0.13	-1.85	11.00	-1.20		Pass
HT20	MCS0	1	44	5220	0.13	-1.52	11.00	-1.20		Pass
HT20	MCS0	1	48	5240	0.13	-1.58	11.00	-1.20		Pass
HT40	MCS0	1	38	5190	0.23	-4.59	11.00	-1.20		Pass
HT40	MCS0	1	46	5230	0.23	-4.25	11.00	-1.20		Pass

TEST RESULTS DATA
26dB and 99% OBW

Band II										
Mod.	Data Rate	NTX	CH.	Freq. (MHz)	99% Bandwidth (MHz)	26 dB Bandwidth (MHz)	IC 99% Bandwidth Power Limit (dBm)	IC 99% Bandwidth EIRP Limit (dBm)	FCC 26dB Bandwidth Power Limit (dBm)	Note
11a	6M bps	1	52	5260	17.70	22.70	23.48	29.48	23.98	
11a	6M bps	1	60	5300	17.70	25.50	23.48	29.48	23.98	
11a	6M bps	1	64	5320	17.45	26.95	23.42	29.42	23.98	
HT20	MCS 0	1	52	5260	18.50	24.80	23.67	29.67	23.98	
HT20	MCS 0	1	60	5300	18.45	26.90	23.66	29.66	23.98	
HT20	MCS 0	1	64	5320	18.45	21.65	23.66	29.66	23.98	
HT40	MCS 0	1	54	5270	36.30	61.83	23.98	30.00	23.98	
HT40	MCS 0	1	62	5310	36.60	41.04	23.98	30.00	23.98	

TEST RESULTS DATA
Average Power Table

FCC Band II										
Mod.	Data Rate	NTX	CH.	Freq. (MHz)	Duty Factor (dB)	Average Conducted Power (dBm)	FCC Conducted Power Limit (dBm)	DG (dBi)	EIRP Power Limit (dBm)	Pass/Fail
11a	6M bps	1	52	5260	0.15	12.53	23.98	-1.40	26.99	Pass
11a	6M bps	1	60	5300	0.15	12.65	23.98	-1.40	26.99	Pass
11a	6M bps	1	64	5320	0.15	12.75	23.98	-1.40	26.99	Pass
HT20	MCS 0	1	52	5260	0.13	10.58	23.98	-1.40	26.99	Pass
HT20	MCS 0	1	60	5300	0.13	10.65	23.98	-1.40	26.99	Pass
HT20	MCS 0	1	64	5320	0.13	10.72	23.98	-1.40	26.99	Pass
HT40	MCS 0	1	54	5270	0.23	10.74	23.98	-1.40	26.99	Pass
HT40	MCS 0	1	62	5310	0.23	10.73	23.98	-1.40	26.99	Pass

TEST RESULTS DATA
Power Spectral Density

Band II										
Mod.	Data Rate	NTX	CH.	Freq. (MHz)	Duty Factor (dB)	Average Power Density (dBm/MHz)	Average PSD Limit (dBm/MHz)	DG (dBi)		Pass/Fail
11a	6M bps	1	52	5260	0.15	0.70	11.00	-1.40		Pass
11a	6M bps	1	60	5300	0.15	0.78	11.00	-1.40		Pass
11a	6M bps	1	64	5320	0.15	0.89	11.00	-1.40		Pass
HT20	MCS 0	1	52	5260	0.13	-1.82	11.00	-1.40		Pass
HT20	MCS 0	1	60	5300	0.13	-1.78	11.00	-1.40		Pass
HT20	MCS 0	1	64	5320	0.13	-1.59	11.00	-1.40		Pass
HT40	MCS 0	1	54	5270	0.23	-4.31	11.00	-1.40		Pass
HT40	MCS 0	1	62	5310	0.23	-4.35	11.00	-1.40		Pass

TEST RESULTS DATA
26dB and 99% OBW

Band III										
Mod.	Data Rate	NTX	CH.	Freq. (MHz)	99% Bandwidth (MHz)	26 dB Bandwidth (MHz)	IC 99% Bandwidth Power Limit (dBm)	IC 99% Bandwidth EIRP Limit (dBm)	FCC 26dB Bandwidth Power Limit (dBm)	Note
11a	6M bps	1	100	5500	17.30	28.10	23.38	29.38	23.98	
11a	6M bps	1	116	5580	17.45	28.00	23.42	29.42	23.98	
11a	6M bps	1	140	5700	17.50	27.10	23.43	29.43	23.98	
11a	6Mbps	1	144	5720	17.35	25.25	23.39	29.39	23.98	
HT20	MCS 0	1	100	5500	18.30	25.50	23.62	29.62	23.98	
HT20	MCS 0	1	116	5580	18.20	28.75	23.60	29.60	23.98	
HT20	MCS 0	1	140	5700	18.35	29.25	23.64	29.64	23.98	
HT20	MCS0	1	144	5720	18.25	26.40	23.61	29.61	23.98	
HT40	MCS 0	1	102	5510	36.50	66.85	23.98	30.00	23.98	
HT40	MCS 0	1	110	5550	36.20	64.98	23.98	30.00	23.98	
HT40	MCS 0	1	134	5670	36.30	62.88	23.98	30.00	23.98	
HT40	MCS0	1	142	5710	36.40	61.43	23.98	30.00	23.98	

TEST RESULTS DATA
Average Power Table

FCC Band III										
Mod.	Data Rate	NTX	CH.	Freq. (MHz)	Duty Factor (dB)	Average Conducted Power (dBm)	FCC Conducted Power Limit (dBm)	DG (dBi)	EIRP Power Limit (dBm)	Pass/Fail
11a	6M bps	1	100	5500	0.15	12.76	23.98	-1.40	26.99	Pass
11a	6M bps	1	116	5580	0.15	12.74	23.98	-1.40	26.99	Pass
11a	6M bps	1	140	5700	0.15	12.59	23.98	-1.40	26.99	Pass
11a	6M bps	1	144	5720	0.15	12.58	23.98	-1.40	26.99	Pass
HT20	MCS 0	1	100	5500	0.13	10.71	23.98	-1.40	26.99	Pass
HT20	MCS 0	1	116	5580	0.13	10.67	23.98	-1.40	26.99	Pass
HT20	MCS 0	1	140	5700	0.13	10.62	23.98	-1.40	26.99	Pass
HT20	MCS 0	1	144	5720	0.13	10.58	23.98	-1.40	26.99	Pass
HT40	MCS 0	1	102	5510	0.23	10.68	23.98	-1.40	26.99	Pass
HT40	MCS 0	1	110	5550	0.23	10.66	23.98	-1.40	26.99	Pass
HT40	MCS 0	1	134	5670	0.23	10.63	23.98	-1.40	26.99	Pass
HT40	MCS 0	1	142	5710	0.23	10.61	23.98	-1.40	26.99	Pass

TEST RESULTS DATA
Power Spectral Density

Band III										
Mod.	Data Rate	NTX	CH.	Freq. (MHz)	Duty Factor (dB)	Average Power Density (dBm/MHz)	Average PSD Limit (dBm/MHz)	DG (dBi)		Pass/Fail
11a	6M bps	1	100	5500	0.15	2.92	11.00	-1.40		Pass
11a	6M bps	1	116	5580	0.15	3.14	11.00	-1.40		Pass
11a	6M bps	1	140	5700	0.15	0.60	11.00	-1.40		Pass
11a	6Mbps	1	144	5720	0.15	0.84	11.00	-1.40		Pass
HT20	MCS 0	1	100	5500	0.13	-0.47	11.00	-1.40		Pass
HT20	MCS 0	1	116	5580	0.13	-0.85	11.00	-1.40		Pass
HT20	MCS 0	1	140	5700	0.13	-1.88	11.00	-1.40		Pass
HT20	MCS0	1	144	5720	0.13	-1.54	11.00	-1.40		Pass
HT40	MCS 0	1	102	5510	0.23	-3.64	11.00	-1.40		Pass
HT40	MCS 0	1	110	5550	0.23	-3.59	11.00	-1.40		Pass
HT40	MCS 0	1	134	5670	0.23	-4.61	11.00	-1.40		Pass
HT40	MCS0	1	142	5710	0.23	-4.38	11.00	-1.40		Pass

TEST RESULTS DATA
Frequency Stability

Band I										
Mod.	Data Rate	NTX	CH.	Freq. (MHz)	Center Frequency (MHz)	Frequency Deviation (MHz)	Frequency Stability (ppm)	Temperature (°C)	Voltage (V)	Note
11a	6Mbps	1	36	5180	5180.025	0.025	4.83	50	3.8	
11a	6Mbps	1	36	5180	5180.000	0.000	0.00	-30	3.8	
11a	6Mbps	1	36	5180	5180.000	0.000	0.00	20	4.2	
11a	6Mbps	1	36	5180	5179.975	-0.025	-4.83	20	3.5	
11a	6Mbps	1	36	5180	5180.000	0.000	0.00	20	3.8	

Band II										
Mod.	Data Rate	NTX	CH.	Freq. (MHz)	Center Frequency (MHz)	Frequency Deviation (MHz)	Frequency Stability (ppm)	Temperature (°C)	Voltage (V)	Note
11a	6Mbps	1	64	5320	5320.025	0.025	4.70	50	3.8	
11a	6Mbps	1	64	5320	5320.000	0.000	0.00	-30	3.8	
11a	6Mbps	1	64	5320	5320.000	0.000	0.00	20	4.2	
11a	6Mbps	1	64	5320	5320.000	0.000	0.00	20	3.5	
11a	6Mbps	1	64	5320	5320.000	0.000	0.00	20	3.8	

Band III										
Mod.	Data Rate	NTX	CH.	Freq. (MHz)	Center Frequency (MHz)	Frequency Deviation (MHz)	Frequency Stability (ppm)	Temperature (°C)	Voltage (V)	Note
11a	6Mbps	1	100	5500	5500.000	0.000	0.00	50	3.8	
11a	6Mbps	1	100	5500	5500.000	0.000	0.00	-30	3.8	
11a	6Mbps	1	100	5500	5500.000	0.000	0.00	20	4.2	
11a	6Mbps	1	100	5500	5500.025	0.025	4.55	20	3.5	
11a	6Mbps	1	100	5500	5499.950	-0.050	-9.09	20	3.8	



Appendix B. AC Conducted Emission Test Results

Test Engineer :	Shareef Yu	Temperature :	26~27°C
		Relative Humidity :	58~62%

EUT Information

Report NO : 782113
 Test Mode : Mode 1
 Test Voltage : 120Vac/60Hz
 Phase : Line

ENV216 Auto Test FCC Power Bar - L

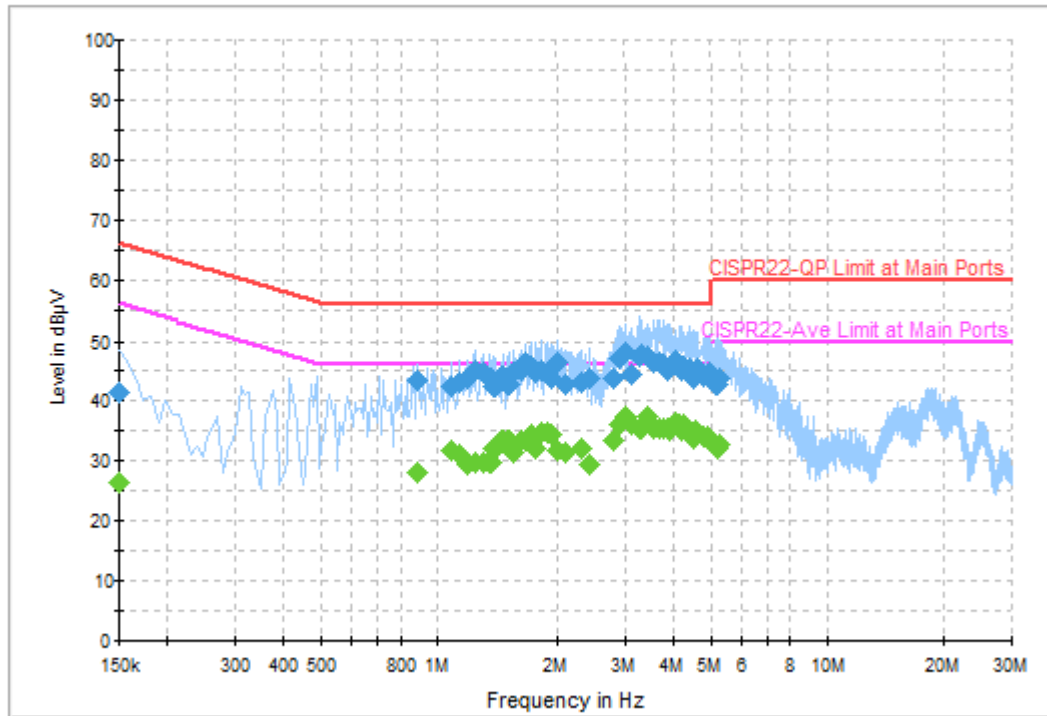

Final Result 1

Frequency (MHz)	QuasiPeak (dBµV)	Filter	Line	Corr. (dB)	Margin (dB)	Limit (dBµV)
0.150000	41.6	Off	L1	19.6	24.4	66.0
0.886000	43.5	Off	L1	19.5	12.5	56.0
1.078000	42.5	Off	L1	19.5	13.5	56.0
1.134000	43.1	Off	L1	19.5	12.9	56.0
1.190000	43.8	Off	L1	19.5	12.2	56.0
1.246000	45.2	Off	L1	19.5	10.8	56.0
1.302000	44.9	Off	L1	19.5	11.1	56.0
1.358000	43.9	Off	L1	19.5	12.1	56.0
1.398000	42.5	Off	L1	19.5	13.5	56.0
1.454000	44.1	Off	L1	19.5	11.9	56.0
1.502000	42.9	Off	L1	19.5	13.1	56.0
1.550000	44.7	Off	L1	19.5	11.3	56.0
1.614000	45.1	Off	L1	19.6	10.9	56.0
1.662000	46.6	Off	L1	19.5	9.4	56.0
1.718000	45.8	Off	L1	19.5	10.2	56.0
1.766000	44.8	Off	L1	19.6	11.2	56.0
1.830000	45.1	Off	L1	19.6	10.9	56.0
1.886000	45.0	Off	L1	19.5	11.0	56.0
1.934000	43.7	Off	L1	19.6	12.3	56.0
2.022000	46.4	Off	L1	19.6	9.6	56.0
2.102000	42.8	Off	L1	18.0	13.2	56.0
2.318000	43.1	Off	L1	18.8	12.9	56.0
2.438000	43.7	Off	L1	19.1	12.3	56.0
2.790000	43.7	Off	L1	19.4	12.3	56.0
2.902000	47.3	Off	L1	19.4	8.7	56.0

3.014000	48.0	Off	L1	19.5	8.0	56.0
3.134000	44.4	Off	L1	19.5	11.6	56.0
3.262000	47.6	Off	L1	19.5	8.4	56.0
3.318000	47.9	Off	L1	19.5	8.1	56.0
3.446000	47.4	Off	L1	19.5	8.6	56.0
3.574000	46.6	Off	L1	19.6	9.4	56.0
3.678000	46.6	Off	L1	19.6	9.4	56.0
3.798000	46.1	Off	L1	19.6	9.9	56.0
3.854000	45.3	Off	L1	19.6	10.7	56.0
3.902000	45.9	Off	L1	19.6	10.1	56.0
4.038000	46.7	Off	L1	19.6	9.3	56.0
4.142000	46.2	Off	L1	19.6	9.8	56.0
4.214000	45.2	Off	L1	19.6	10.8	56.0
4.254000	45.9	Off	L1	19.6	10.1	56.0
4.422000	45.5	Off	L1	19.6	10.5	56.0
4.502000	43.8	Off	L1	19.6	12.2	56.0
4.574000	45.2	Off	L1	19.6	10.8	56.0
4.630000	45.5	Off	L1	19.6	10.5	56.0
4.782000	44.2	Off	L1	19.6	11.8	56.0
4.902000	44.1	Off	L1	19.6	11.9	56.0
4.950000	44.7	Off	L1	19.6	11.3	56.0
5.126000	42.8	Off	L1	19.6	17.2	60.0
5.182000	42.9	Off	L1	19.6	17.1	60.0
5.278000	43.8	Off	L1	19.6	16.2	60.0

Final Result 2

Frequency (MHz)	Average (dBμV)	Filter	Line	Corr. (dB)	Margin (dB)	Limit (dBμV)
0.150000	26.3	Off	L1	19.6	29.7	56.0
0.886000	28.0	Off	L1	19.5	18.0	46.0
1.078000	31.8	Off	L1	19.5	14.2	46.0
1.134000	31.0	Off	L1	19.5	15.0	46.0
1.190000	29.3	Off	L1	19.5	16.7	46.0
1.246000	29.7	Off	L1	19.5	16.3	46.0
1.302000	29.9	Off	L1	19.5	16.1	46.0
1.358000	29.8	Off	L1	19.5	16.2	46.0
1.398000	32.0	Off	L1	19.5	14.0	46.0
1.454000	33.4	Off	L1	19.5	12.6	46.0
1.502000	33.4	Off	L1	19.5	12.6	46.0
1.550000	31.3	Off	L1	19.5	14.7	46.0
1.614000	33.4	Off	L1	19.6	12.6	46.0
1.662000	33.4	Off	L1	19.5	12.6	46.0
1.718000	34.4	Off	L1	19.5	11.6	46.0
1.766000	32.1	Off	L1	19.6	13.9	46.0
1.830000	34.6	Off	L1	19.6	11.4	46.0
1.886000	34.6	Off	L1	19.5	11.4	46.0
1.934000	34.5	Off	L1	19.6	11.5	46.0
2.022000	31.9	Off	L1	19.6	14.1	46.0
2.102000	31.5	Off	L1	18.0	14.5	46.0
2.318000	32.2	Off	L1	18.8	13.8	46.0
2.438000	29.5	Off	L1	19.1	16.5	46.0
2.790000	33.3	Off	L1	19.4	12.7	46.0
2.902000	36.0	Off	L1	19.4	10.0	46.0
3.014000	37.4	Off	L1	19.5	8.6	46.0
3.134000	36.0	Off	L1	19.5	10.0	46.0
3.262000	35.6	Off	L1	19.5	10.4	46.0
3.318000	35.4	Off	L1	19.5	10.6	46.0
3.446000	37.5	Off	L1	19.5	8.5	46.0
3.574000	35.3	Off	L1	19.6	10.7	46.0
3.678000	35.4	Off	L1	19.6	10.6	46.0
3.798000	35.3	Off	L1	19.6	10.7	46.0
3.854000	35.5	Off	L1	19.6	10.5	46.0
3.902000	35.3	Off	L1	19.6	10.7	46.0
4.038000	36.3	Off	L1	19.6	9.7	46.0
4.142000	36.1	Off	L1	19.6	9.9	46.0
4.214000	35.1	Off	L1	19.6	10.9	46.0
4.254000	36.0	Off	L1	19.6	10.0	46.0
4.422000	35.1	Off	L1	19.6	10.9	46.0
4.502000	33.7	Off	L1	19.6	12.3	46.0

4.574000	35.0	Off	L1	19.6	11.0	46.0
4.630000	34.8	Off	L1	19.6	11.2	46.0
4.782000	33.9	Off	L1	19.6	12.1	46.0
4.902000	34.1	Off	L1	19.6	11.9	46.0
4.950000	33.6	Off	L1	19.6	12.4	46.0
5.126000	32.5	Off	L1	19.6	17.5	50.0
5.182000	32.3	Off	L1	19.6	17.7	50.0
5.278000	32.7	Off	L1	19.6	17.3	50.0

EUT Information

Report NO : 782113
 Test Mode : Mode 1
 Test Voltage : 120Vac/60Hz
 Phase : Neutral

ENV216 Auto Test FCC Power Bar - N

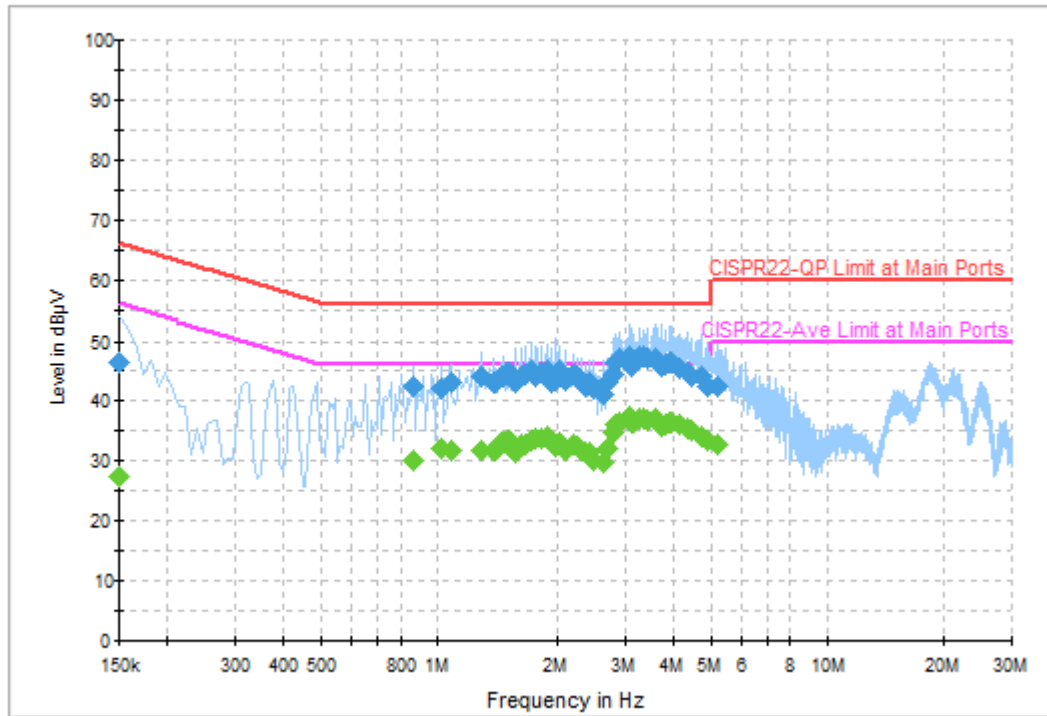

Final Result 1

Frequency (MHz)	QuasiPeak (dBµV)	Filter	Line	Corr. (dB)	Margin (dB)	Limit (dBµV)
0.150000	46.6	Off	N	19.5	19.4	66.0
0.862000	42.5	Off	N	19.5	13.5	56.0
1.022000	42.2	Off	N	19.5	13.8	56.0
1.078000	43.3	Off	N	19.5	12.7	56.0
1.294000	44.1	Off	N	19.5	11.9	56.0
1.398000	43.0	Off	N	19.5	13.0	56.0
1.454000	44.1	Off	N	19.5	11.9	56.0
1.510000	44.7	Off	N	19.5	11.3	56.0
1.566000	43.0	Off	N	19.5	13.0	56.0
1.614000	44.2	Off	N	19.5	11.8	56.0
1.670000	44.6	Off	N	19.5	11.4	56.0
1.726000	45.1	Off	N	19.5	10.9	56.0
1.774000	44.2	Off	N	19.5	11.8	56.0
1.830000	44.9	Off	N	19.5	11.1	56.0
1.886000	45.1	Off	N	19.5	10.9	56.0
1.934000	43.1	Off	N	19.5	12.9	56.0
1.998000	43.6	Off	N	19.5	12.4	56.0
2.046000	45.0	Off	N	18.8	11.0	56.0
2.102000	43.4	Off	N	18.0	12.6	56.0
2.206000	44.4	Off	N	18.5	11.6	56.0
2.262000	44.3	Off	N	18.7	11.7	56.0
2.318000	43.1	Off	N	18.8	12.9	56.0
2.374000	42.4	Off	N	18.9	13.6	56.0
2.422000	43.2	Off	N	19.0	12.8	56.0
2.478000	42.3	Off	N	19.1	13.7	56.0

2.638000	41.3	Off	N	19.3	14.7	56.0
2.694000	43.1	Off	N	19.3	12.9	56.0
2.798000	44.6	Off	N	19.4	11.4	56.0
2.854000	46.5	Off	N	19.4	9.5	56.0
2.910000	47.1	Off	N	19.4	8.9	56.0
3.070000	47.6	Off	N	19.5	8.4	56.0
3.118000	45.9	Off	N	19.5	10.1	56.0
3.174000	46.9	Off	N	19.5	9.1	56.0
3.286000	47.6	Off	N	19.5	8.4	56.0
3.342000	47.4	Off	N	19.5	8.6	56.0
3.446000	47.0	Off	N	19.5	9.0	56.0
3.606000	47.0	Off	N	19.5	9.0	56.0
3.726000	45.7	Off	N	19.6	10.3	56.0
3.830000	46.1	Off	N	19.6	9.9	56.0
3.934000	46.3	Off	N	19.6	9.7	56.0
3.982000	46.4	Off	N	19.6	9.6	56.0
4.150000	45.6	Off	N	19.6	10.4	56.0
4.366000	44.8	Off	N	19.6	11.2	56.0
4.470000	44.1	Off	N	19.6	11.9	56.0
4.734000	44.1	Off	N	19.6	11.9	56.0
4.910000	42.4	Off	N	19.6	13.6	56.0
5.222000	42.5	Off	N	19.6	17.5	60.0

Final Result 2

Frequency (MHz)	Average (dBμV)	Filter	Line	Corr. (dB)	Margin (dB)	Limit (dBμV)
0.150000	27.3	Off	N	19.5	28.7	56.0
0.862000	30.2	Off	N	19.5	15.8	46.0
1.022000	32.0	Off	N	19.5	14.0	46.0
1.078000	31.9	Off	N	19.5	14.1	46.0
1.294000	31.8	Off	N	19.5	14.2	46.0
1.398000	31.8	Off	N	19.5	14.2	46.0
1.454000	33.0	Off	N	19.5	13.0	46.0
1.510000	33.4	Off	N	19.5	12.6	46.0
1.566000	31.4	Off	N	19.5	14.6	46.0
1.614000	32.8	Off	N	19.5	13.2	46.0
1.670000	32.9	Off	N	19.5	13.1	46.0
1.726000	33.3	Off	N	19.5	12.7	46.0
1.774000	33.8	Off	N	19.5	12.2	46.0
1.830000	33.6	Off	N	19.5	12.4	46.0
1.886000	34.1	Off	N	19.5	11.9	46.0
1.934000	33.6	Off	N	19.5	12.4	46.0
1.998000	32.4	Off	N	19.5	13.6	46.0
2.046000	33.2	Off	N	18.8	12.8	46.0
2.102000	31.7	Off	N	18.0	14.3	46.0
2.206000	32.7	Off	N	18.5	13.3	46.0
2.262000	32.6	Off	N	18.7	13.4	46.0
2.318000	31.8	Off	N	18.8	14.2	46.0
2.374000	31.3	Off	N	18.9	14.7	46.0
2.422000	31.4	Off	N	19.0	14.6	46.0
2.478000	30.1	Off	N	19.1	15.9	46.0
2.638000	29.6	Off	N	19.3	16.4	46.0
2.694000	32.1	Off	N	19.3	13.9	46.0
2.798000	34.7	Off	N	19.4	11.3	46.0
2.854000	36.0	Off	N	19.4	10.0	46.0
2.910000	36.3	Off	N	19.4	9.7	46.0
3.070000	37.3	Off	N	19.5	8.7	46.0
3.118000	36.4	Off	N	19.5	9.6	46.0
3.174000	36.5	Off	N	19.5	9.5	46.0
3.286000	37.1	Off	N	19.5	8.9	46.0
3.342000	37.0	Off	N	19.5	9.0	46.0
3.446000	36.9	Off	N	19.5	9.1	46.0
3.606000	37.0	Off	N	19.5	9.0	46.0
3.726000	35.7	Off	N	19.6	10.3	46.0
3.830000	36.2	Off	N	19.6	9.8	46.0
3.934000	36.6	Off	N	19.6	9.4	46.0
3.982000	36.5	Off	N	19.6	9.5	46.0
4.150000	36.0	Off	N	19.6	10.0	46.0
4.366000	35.5	Off	N	19.6	10.5	46.0

4.47000	35.0	Off	N	19.6	11.0	46.0
4.73400	34.2	Off	N	19.6	11.8	46.0
4.91000	33.4	Off	N	19.6	12.6	46.0
5.22200	32.9	Off	N	19.6	17.1	50.0



Appendix C. Radiated Spurious Emission

Test Engineer :	Tsung lee, Stan Hsieh and Kyle Chuang	Temperature :	22~24°C
		Relative Humidity :	43~44%

Band 1 - 5150~5250MHz

WIFI 802.11a (Band Edge @ 3m)

WIFI Ant. 1	Note	Frequency (MHz)	Level (dBμV/m)	Over Limit (dB)	Limit Line (dBμV/m)	Read Level (dBμV)	Antenna Factor (dB/m)	Cable Loss (dB)	Preamp Factor (dB)	Ant Pos (cm)	Table Pos (deg)	Peak Avg. (P/A)	Pol. (H/V)	
802.11a CH 36 5180MHz		5149.76	53.92	-20.08	74	47.35	32.5	6.61	32.54	100	242	P	H	
		5149.5	45.89	-8.11	54	39.32	32.5	6.61	32.54	100	242	A	H	
	*	5180	107.43	-	-	100.83	32.5	6.64	32.54	100	242	P	H	
	*	5180	100.2	-	-	93.6	32.5	6.64	32.54	100	242	A	H	
													H	
													H	
			5024.96	48.89	-25.11	74	42.4	32.5	6.52	32.53	380	96	P	V
			5150	42.18	-11.82	54	35.61	32.5	6.61	32.54	380	96	A	V
	*		5180	103.4	-	-	96.8	32.5	6.64	32.54	380	96	P	V
	*		5180	96.45	-	-	89.85	32.5	6.64	32.54	380	96	A	V
													V	
													V	
802.11a CH 44 5220MHz		5127.14	49.24	-24.76	74	42.68	32.5	6.6	32.54	100	224	P	H	
		5140.14	42.61	-11.39	54	36.05	32.5	6.6	32.54	100	224	A	H	
	*	5220	105.12	-	-	98.49	32.5	6.67	32.54	100	224	P	H	
	*	5220	97.33	-	-	90.7	32.5	6.67	32.54	100	224	A	H	
			5399.52	47.05	-26.95	74	40.28	32.5	6.82	32.55	100	224	P	H
			5372.08	39.44	-14.56	54	32.69	32.5	6.79	32.54	100	224	A	H
			5103.22	48.51	-25.49	74	41.97	32.5	6.57	32.53	378	90	P	V
			5140.14	40.89	-13.11	54	34.33	32.5	6.6	32.54	378	90	A	V
	*		5220	104.66	-	-	98.03	32.5	6.67	32.54	378	90	P	V
	*		5220	96.69	-	-	90.06	32.5	6.67	32.54	378	90	A	V
			5401.48	48.8	-25.2	74	42.03	32.5	6.82	32.55	378	90	P	V
			5372.08	40.11	-13.89	54	33.36	32.5	6.79	32.54	378	90	A	V



802.11a CH 48 5240MHz		5149.5	48.56	-25.44	74	41.99	32.5	6.61	32.54	111	115	P	H
		5150	40.21	-13.79	54	33.64	32.5	6.61	32.54	111	115	A	H
	*	5240	105.09	-	-	98.45	32.5	6.68	32.54	111	115	P	H
	*	5240	97.44	-	-	90.8	32.5	6.68	32.54	111	115	A	H
		5398.12	48.11	-25.89	74	41.34	32.5	6.82	32.55	111	115	P	H
		5392.52	40.14	-13.86	54	33.39	32.5	6.8	32.55	111	115	A	H
		5119.08	49.18	-24.82	74	42.63	32.5	6.59	32.54	395	91	P	V
		5087.62	39.57	-14.43	54	33.04	32.5	6.56	32.53	395	91	A	V
	*	5240	102.9	-	-	96.26	32.5	6.68	32.54	395	91	P	V
	*	5240	95.58	-	-	88.94	32.5	6.68	32.54	395	91	A	V
		5431.44	47.27	-26.73	74	40.48	32.5	6.84	32.55	395	91	P	V
		5392.52	39.28	-14.72	54	32.53	32.5	6.8	32.55	395	91	A	V
Remark	1. No other spurious found. 2. All results are PASS against Peak and Average limit line.												



Band 1 5150~5250MHz
WIFI 802.11a (Harmonic @ 3m)

WIFI Ant. 1	Note	Frequency (MHz)	Level (dBμV/m)	Over Limit (dB)	Limit Line (dBμV/m)	Read Level (dBμV)	Antenna Factor (dB/m)	Cable Loss (dB)	Preamp Factor (dB)	Ant Pos (cm)	Table Pos (deg)	Peak Avg. (P/A)	Pol. (H/V)
802.11a CH 36 5180MHz		10360	45.64	-28.36	74	61.1	38.87	10.33	65.2	100	0	P	H
		15540	60.99	-13.01	74	72.12	38.49	13.6	63.98	100	259	P	H
		15540	50.57	-3.43	54	61.7	38.49	13.6	63.98	100	259	A	H
													H
		10360	46.19	-27.81	74	61.65	38.87	10.33	65.2	100	0	P	V
		15540	59.51	-14.49	74	70.64	38.49	13.6	63.98	106	70	P	V
		15540	50.11	-3.89	54	61.24	38.49	13.6	63.98	106	70	A	V
802.11a CH 44 5220MHz		10440	44.78	-29.22	74	60.22	38.93	10.29	65.2	100	0	P	H
		15660	60.68	-13.32	74	72.01	38.44	13.72	64.24	100	258	P	H
		15660	50.44	-3.56	54	61.77	38.44	13.72	64.24	100	258	A	H
													H
		10440	45.51	-28.49	74	60.95	38.93	10.29	65.2	100	0	P	V
		15660	55.38	-18.62	74	66.71	38.44	13.72	64.24	110	72	P	V
		15660	46.25	-7.75	54	57.58	38.44	13.72	64.24	110	72	A	V
802.11a CH 48 5240MHz		10480	45.84	-28.16	74	61.26	38.98	10.26	65.2	100	0	P	H
		15720	60.68	-13.32	74	72.15	38.41	13.77	64.39	100	260	P	H
		15720	50.76	-3.24	54	62.23	38.41	13.77	64.39	100	260	A	H
													H
		10480	45.89	-28.11	74	61.31	38.98	10.26	65.2	100	0	P	V
		15720	55.68	-18.32	74	67.15	38.41	13.77	64.39	107	73	P	V
		15720	46.62	-7.38	54	58.09	38.41	13.77	64.39	107	73	A	V
Remark	1. No other spurious found. 2. All results are PASS against Peak and Average limit line.												



Band 1 5150~5250MHz
WIFI 802.11n HT20 (Band Edge @ 3m)

WIFI Ant. 1	Note	Frequency (MHz)	Level (dBμV/m)	Over Limit (dB)	Limit Line (dBμV/m)	Read Level (dBμV)	Antenna Factor (dB/m)	Cable Loss (dB)	Preamp Factor (dB)	Ant Pos (cm)	Table Pos (deg)	Peak Avg. (P/A)	Pol. (H/V)	
802.11n HT20 CH 36 5180MHz		5133.38	52.55	-21.45	74	45.99	32.5	6.6	32.54	100	117	P	H	
		5148.46	45.31	-8.69	54	38.74	32.5	6.61	32.54	100	117	A	H	
	*	5180	105.72	-	-	99.12	32.5	6.64	32.54	100	117	P	H	
	*	5180	98.18	-	-	91.58	32.5	6.64	32.54	100	117	A	H	
													H	
														H
			5140.14	49.24	-24.76	74	42.68	32.5	6.6	32.54	341	101	P	V
			5150	42.62	-11.38	54	36.05	32.5	6.61	32.54	341	101	A	V
		*	5180	103.95	-	-	97.35	32.5	6.64	32.54	341	101	P	V
		*	5180	96.35	-	-	89.75	32.5	6.64	32.54	341	101	A	V
													V	
													V	
802.11n HT20 CH 44 5220MHz		5148.72	51.4	-22.6	74	44.83	32.5	6.61	32.54	100	115	P	H	
		5139.88	44.38	-9.62	54	37.82	32.5	6.6	32.54	100	115	A	H	
	*	5220	105.68	-	-	99.05	32.5	6.67	32.54	100	115	P	H	
	*	5220	98.58	-	-	91.95	32.5	6.67	32.54	100	115	A	H	
			5372.08	48.44	-25.56	74	41.69	32.5	6.79	32.54	100	115	P	H
			5371.52	41.51	-12.49	54	34.76	32.5	6.79	32.54	100	115	A	H
			5115.96	48.71	-25.29	74	42.15	32.5	6.59	32.53	378	90	P	V
			5140.14	40.8	-13.2	54	34.24	32.5	6.6	32.54	378	90	A	V
		*	5220	104.49	-	-	97.86	32.5	6.67	32.54	378	90	P	V
		*	5220	96.9	-	-	90.27	32.5	6.67	32.54	378	90	A	V
		5373.48	47.18	-26.82	74	40.44	32.5	6.79	32.55	378	90	P	V	
		5371.52	40.51	-13.49	54	33.76	32.5	6.79	32.54	378	90	A	V	



802.11n HT20 CH 48 5240MHz		5136.76	49.9	-24.1	74	43.34	32.5	6.6	32.54	100	115	P	H
		5146.38	41.74	-12.26	54	35.17	32.5	6.61	32.54	100	115	A	H
	*	5240	106.26	-	-	99.62	32.5	6.68	32.54	100	115	P	H
	*	5240	98.82	-	-	92.18	32.5	6.68	32.54	100	115	A	H
		5407.64	48.91	-25.09	74	42.14	32.5	6.82	32.55	100	115	P	H
		5391.4	41.01	-12.99	54	34.26	32.5	6.8	32.55	100	115	A	H
		5122.98	47.93	-26.07	74	41.38	32.5	6.59	32.54	397	90	P	V
		5087.36	40.29	-13.71	54	33.76	32.5	6.56	32.53	397	90	A	V
	*	5240	103.94	-	-	97.3	32.5	6.68	32.54	397	90	P	V
	*	5240	97.06	-	-	90.42	32.5	6.68	32.54	397	90	A	V
		5355.84	47.42	-26.58	74	40.69	32.5	6.77	32.54	397	90	P	V
		5392.24	40.47	-13.53	54	33.72	32.5	6.8	32.55	397	90	A	V
Remark	1. No other spurious found. 2. All results are PASS against Peak and Average limit line.												



Band 1 5150~5250MHz
WIFI 802.11n HT20 (Harmonic @ 3m)

WIFI Ant. 1	Note	Frequency (MHz)	Level (dBμV/m)	Over Limit (dB)	Limit Line (dBμV/m)	Read Level (dBμV)	Antenna Factor (dB/m)	Cable Loss (dB)	Preamp Factor (dB)	Ant Pos (cm)	Table Pos (deg)	Peak Avg. (P/A)	Pol. (H/V)	
802.11n HT20 CH 36 5180MHz		10360	46.28	-27.72	74	61.74	38.87	10.33	65.2	100	0	P	H	
		15540	61.06	-12.94	74	72.19	38.49	13.6	63.98	100	259	P	H	
		15540	50.73	-3.27	54	61.86	38.49	13.6	63.98	100	259	A	H	
													H	
			10360	45.05	-28.95	74	60.51	38.87	10.33	65.2	100	0	P	V
			15540	60.37	-13.63	74	71.5	38.49	13.6	63.98	110	77	P	V
			15540	50.48	-3.52	54	61.61	38.49	13.6	63.98	110	77	A	V
													V	
802.11n HT20 CH 44 5220MHz		10440	45.63	-28.37	74	61.07	38.93	10.29	65.2	100	0	P	H	
		15660	61.32	-12.68	74	72.65	38.44	13.72	64.24	100	257	P	H	
		15660	50.85	-3.15	54	62.18	38.44	13.72	64.24	100	257	A	H	
													H	
			10440	44.9	-29.1	74	60.34	38.93	10.29	65.2	100	0	P	V
			15660	60.19	-13.81	74	71.52	38.44	13.72	64.24	113	71	P	V
			15660	49.41	-4.59	54	60.74	38.44	13.72	64.24	113	71	A	V
													V	
802.11n HT20 CH 48 5240MHz		10480	46.49	-27.51	74	61.91	38.98	10.26	65.2	100	0	P	H	
		15720	60.77	-13.23	74	72.24	38.41	13.77	64.39	100	257	P	H	
		15720	50.79	-3.21	54	62.26	38.41	13.77	64.39	100	257	A	H	
													H	
			10480	46.37	-27.63	74	61.79	38.98	10.26	65.2	100	0	P	V
			15720	59	-15	74	70.47	38.41	13.77	64.39	106	75	P	V
			15720	48.94	-5.06	54	60.41	38.41	13.77	64.39	106	75	A	V
													V	
Remark	1. No other spurious found. 2. All results are PASS against Peak and Average limit line.													



Band 1 5150~5250MHz
WIFI 802.11n HT40 (Band Edge @ 3m)

WIFI Ant. 1	Note	Frequency (MHz)	Level (dBμV/m)	Over Limit (dB)	Limit Line (dBμV/m)	Read Level (dBμV)	Antenna Factor (dB/m)	Cable Loss (dB)	Preamp Factor (dB)	Ant Pos (cm)	Table Pos (deg)	Peak Avg. (P/A)	Pol. (H/V)	
802.11n HT40 CH 38 5190MHz		5146.12	57.62	-16.38	74	51.05	32.5	6.61	32.54	100	240	P	H	
		5150	50.47	-3.53	54	43.9	32.5	6.61	32.54	100	240	A	H	
	*	5190	100.54	-	-	93.94	32.5	6.64	32.54	100	240	P	H	
	*	5190	94.4	-	-	87.8	32.5	6.64	32.54	100	240	A	H	
		5444.32	47.68	-26.32	74	40.89	32.5	6.84	32.55	100	240	P	H	
		5367.6	39.7	-14.3	54	32.95	32.5	6.79	32.54	100	240	A	H	
		5147.94	51.73	-22.27	74	45.16	32.5	6.61	32.54	400	101	P	V	
		5148.98	44.28	-9.72	54	37.71	32.5	6.61	32.54	400	101	A	V	
	*	5190	98.5	-	-	91.9	32.5	6.64	32.54	400	101	P	V	
	*	5190	91.47	-	-	84.87	32.5	6.64	32.54	400	101	A	V	
		5430.04	47.2	-26.8	74	40.41	32.5	6.84	32.55	400	101	P	V	
		5365.92	39.44	-14.56	54	32.69	32.5	6.79	32.54	400	101	A	V	
	802.11n HT40 CH 46 5230MHz		5149.5	51.1	-22.9	74	44.53	32.5	6.61	32.54	100	242	P	H
			5149.24	42.87	-11.13	54	36.3	32.5	6.61	32.54	100	242	A	H
*		5230	104.42	-	-	97.79	32.5	6.67	32.54	100	242	P	H	
*		5230	97.87	-	-	91.24	32.5	6.67	32.54	100	242	A	H	
		5379.36	47.83	-26.17	74	41.08	32.5	6.8	32.55	100	242	P	H	
		5377.4	41.47	-12.53	54	34.72	32.5	6.8	32.55	100	242	A	H	
		5129.48	48.91	-25.09	74	42.35	32.5	6.6	32.54	392	97	P	V	
		5084.24	41.1	-12.9	54	34.57	32.5	6.56	32.53	392	97	A	V	
*		5230	101.91	-	-	95.28	32.5	6.67	32.54	392	97	P	V	
*		5230	95	-	-	88.37	32.5	6.67	32.54	392	97	A	V	
	5350.24	47.47	-26.53	74	40.74	32.5	6.77	32.54	392	97	P	V		
	5377.12	41.2	-12.8	54	34.45	32.5	6.8	32.55	392	97	A	V		
Remark	1. No other spurious found. 2. All results are PASS against Peak and Average limit line.													



Band 1 5150~5250MHz
WIFI 802.11n HT40 (Harmonic @ 3m)

WIFI Ant. 1	Note	Frequency (MHz)	Level (dBμV/m)	Over Limit (dB)	Limit Line (dBμV/m)	Read Level (dBμV)	Antenna Factor (dB/m)	Cable Loss (dB)	Preamp Factor (dB)	Ant Pos (cm)	Table Pos (deg)	Peak Avg. (P/A)	Pol. (H/V)	
802.11n HT40 CH 38 5190MHz		10380	48.27	-25.73	74	63.73	38.88	10.32	65.2	100	0	P	H	
		15570	45.82	-28.18	74	57.01	38.47	13.64	64.05	100	0	P	H	
													H	
													H	
			10380	45.58	-28.42	74	61.04	38.88	10.32	65.2	100	0	P	V
			15570	45.48	-28.52	74	56.67	38.47	13.64	64.05	100	0	P	V
														V
802.11n HT40 CH 46 5230MHz		10460	45.26	-28.74	74	60.69	38.95	10.28	65.2	100	0	P	H	
		15690	60.29	-13.71	74	71.71	38.42	13.74	64.32	100	272	P	H	
		15690	50.99	-3.01	54	62.41	38.42	13.74	64.32	100	272	A	H	
													H	
			10460	46.36	-27.64	74	61.79	38.95	10.28	65.2	100	0	P	V
			15690	56.81	-17.19	74	68.23	38.42	13.74	64.32	105	77	P	V
			15690	48.27	-5.73	54	59.69	38.42	13.74	64.32	105	77	A	V
													V	
Remark	1. No other spurious found. 2. All results are PASS against Peak and Average limit line.													



Band 2 - 5250~5350MHz
WIFI 802.11a (Band Edge @ 3m)

WIFI	Note	Frequency	Level	Over	Limit	Read	Antenna	Cable	Preamp	Ant	Table	Peak	Pol.
Ant.				Limit	Line	Level	Factor	Loss	Factor	Pos	Pos	Avg.	
1		(MHz)	(dBμV/m)	(dB)	(dBμV/m)	(dBμV)	(dB/m)	(dB)	(dB)	(cm)	(deg)	(P/A)	(H/V)
802.11a CH 52 5260MHz		5141.44	47.53	-26.47	74	40.97	32.5	6.6	32.54	100	224	P	H
		5107.1	40.41	-13.59	54	33.85	32.5	6.59	32.53	100	224	A	H
	*	5260	104.12	-	-	97.46	32.5	6.7	32.54	100	224	P	H
	*	5260	96.27	-	-	89.61	32.5	6.7	32.54	100	224	A	H
		5350.32	48.14	-25.86	74	41.41	32.5	6.77	32.54	100	224	P	H
		5352.24	39.62	-14.38	54	32.89	32.5	6.77	32.54	100	224	A	H
		5123.08	48.11	-25.89	74	41.56	32.5	6.59	32.54	393	89	P	V
		5107.78	39.33	-14.67	54	32.77	32.5	6.59	32.53	393	89	A	V
	*	5260	102.46	-	-	95.8	32.5	6.7	32.54	393	89	P	V
	*	5260	95.37	-	-	88.71	32.5	6.7	32.54	393	89	A	V
		5353.44	47.12	-26.88	74	40.39	32.5	6.77	32.54	393	89	P	V
		5412.24	39.37	-14.63	54	32.59	32.5	6.83	32.55	393	89	A	V
802.11a CH 60 5300MHz		5146.54	47.7	-26.3	74	41.13	32.5	6.61	32.54	100	118	P	H
		5147.22	40.62	-13.38	54	34.05	32.5	6.61	32.54	100	118	A	H
	*	5300	104.14	-	-	97.45	32.5	6.73	32.54	100	118	P	H
	*	5300	96.77	-	-	90.08	32.5	6.73	32.54	100	118	A	H
		5350.8	49.68	-24.32	74	42.95	32.5	6.77	32.54	100	118	P	H
		5380.08	42	-12	54	35.25	32.5	6.8	32.55	100	118	A	H
		5042.84	47.29	-26.71	74	40.78	32.5	6.54	32.53	389	81	P	V
		5147.56	39.68	-14.32	54	33.11	32.5	6.61	32.54	389	81	A	V
	*	5300	102.22	-	-	95.53	32.5	6.73	32.54	389	81	P	V
	*	5300	95.66	-	-	88.97	32.5	6.73	32.54	389	81	A	V
		5350.08	49.27	-24.73	74	42.54	32.5	6.77	32.54	389	81	P	V
		5351.04	40.8	-13.2	54	34.07	32.5	6.77	32.54	389	81	A	V



802.11a CH 64 5320MHz	*	5320	106.19	-	-	99.49	32.5	6.74	32.54	100	234	P	H
	*	5320	98.27	-	-	91.57	32.5	6.74	32.54	100	234	A	H
		5362.88	50.83	-23.17	74	44.08	32.5	6.79	32.54	100	234	P	H
		5350.56	43.71	-10.29	54	36.98	32.5	6.77	32.54	100	234	A	H
													H
													H
	*	5320	104.43	-	-	97.73	32.5	6.74	32.54	381	96	P	V
	*	5320	96.87	-	-	90.17	32.5	6.74	32.54	381	96	A	V
		5354.08	47.95	-26.05	74	41.22	32.5	6.77	32.54	381	96	P	V
		5350.08	41.36	-12.64	54	34.63	32.5	6.77	32.54	381	96	A	V
													V
													V
Remark	1. No other spurious found. 2. All results are PASS against Peak and Average limit line.												



Band 2 5250~5350MHz
WIFI 802.11a (Harmonic @ 3m)

WIFI Ant. 1	Note	Frequency (MHz)	Level (dBμV/m)	Over Limit (dB)	Limit Line (dBμV/m)	Read Level (dBμV)	Antenna Factor (dB/m)	Cable Loss (dB)	Preamp Factor (dB)	Ant Pos (cm)	Table Pos (deg)	Peak Avg. (P/A)	Pol. (H/V)
802.11a CH 52 5260MHz		10520	44.24	-29.76	74	59.61	39.05	10.24	65.2	100	0	P	H
		15780	60.04	-13.96	74	71.6	38.39	13.82	64.51	100	258	P	H
		15780	50.72	-3.28	54	62.28	38.39	13.82	64.51	100	258	A	H
													H
		10520	43.98	-30.02	74	59.35	39.05	10.24	65.2	100	0	P	V
		15780	55.41	-18.59	74	66.97	38.39	13.82	64.51	108	72	P	V
		15780	46.16	-7.84	54	57.72	38.39	13.82	64.51	108	72	A	V
802.11a CH 60 5300MHz		10600	44.21	-29.79	74	59.34	39.31	10.2	65.18	100	0	P	H
		15900	60.32	-13.68	74	72.08	38.34	13.94	64.77	100	261	P	H
		15900	50.21	-3.79	54	61.97	38.34	13.94	64.77	100	261	A	H
													H
		10600	45.2	-28.8	74	60.33	39.31	10.2	65.18	100	0	P	V
		15900	58.35	-15.65	74	70.11	38.34	13.94	64.77	105	73	P	V
		15900	48.7	-5.3	54	60.46	38.34	13.94	64.77	105	73	A	V
802.11a CH 64 5320MHz		10640	44.33	-29.67	74	59.37	39.41	10.19	65.17	100	0	P	H
		15960	59.66	-14.34	74	71.56	38.31	13.99	64.92	100	266	P	H
		15960	50.85	-3.15	54	62.75	38.31	13.99	64.92	100	266	A	H
													H
		10640	44.57	-29.43	74	59.61	39.41	10.19	65.17	100	0	P	V
		15960	60.8	-13.2	74	72.7	38.31	13.99	64.92	109	76	P	V
		15960	50.53	-3.47	54	62.43	38.31	13.99	64.92	109	76	A	V
Remark	1. No other spurious found. 2. All results are PASS against Peak and Average limit line.												



Band 2 5250~5350MHz
WIFI 802.11n HT20 (Band Edge @ 3m)

WIFI Ant. 1	Note	Frequency (MHz)	Level (dBμV/m)	Over Limit (dB)	Limit Line (dBμV/m)	Read Level (dBμV)	Antenna Factor (dB/m)	Cable Loss (dB)	Preamp Factor (dB)	Ant Pos (cm)	Table Pos (deg)	Peak Avg. (P/A)	Pol. (H/V)
802.11n HT20 CH 52 5260MHz		5016.32	48.61	-25.39	74	42.13	32.5	6.51	32.53	100	113	P	H
		5108.46	40.15	-13.85	54	33.59	32.5	6.59	32.53	100	113	A	H
	*	5260	103.39	-	-	96.73	32.5	6.7	32.54	100	113	P	H
	*	5260	96.77	-	-	90.11	32.5	6.7	32.54	100	113	A	H
		5359.2	49.47	-24.53	74	42.72	32.5	6.79	32.54	100	113	P	H
		5354.16	40	-14	54	33.27	32.5	6.77	32.54	100	113	A	H
		5073.1	47.25	-26.75	74	40.72	32.5	6.56	32.53	374	82	P	V
		5107.44	39.48	-14.52	54	32.92	32.5	6.59	32.53	374	82	A	V
	*	5260	102.42	-	-	95.76	32.5	6.7	32.54	374	82	P	V
	*	5260	94.94	-	-	88.28	32.5	6.7	32.54	374	82	A	V
		5384.16	46.9	-27.1	74	40.15	32.5	6.8	32.55	374	82	P	V
		5412.72	39.45	-14.55	54	32.67	32.5	6.83	32.55	374	82	A	V
802.11n HT20 CH 60 5300MHz		5040.46	48.57	-25.43	74	42.06	32.5	6.54	32.53	100	117	P	H
		5148.24	40.69	-13.31	54	34.12	32.5	6.61	32.54	100	117	A	H
	*	5300	105.12	-	-	98.43	32.5	6.73	32.54	100	117	P	H
	*	5300	97.42	-	-	90.73	32.5	6.73	32.54	100	117	A	H
		5371.68	50.11	-23.89	74	43.36	32.5	6.79	32.54	100	117	P	H
		5380.08	42.94	-11.06	54	36.19	32.5	6.8	32.55	100	117	A	H
		5071.74	48.59	-25.41	74	42.06	32.5	6.56	32.53	349	82	P	V
		5147.56	39.92	-14.08	54	33.35	32.5	6.61	32.54	349	82	A	V
	*	5300	103.08	-	-	96.39	32.5	6.73	32.54	349	82	P	V
	*	5300	96.04	-	-	89.35	32.5	6.73	32.54	349	82	A	V
	5364.96	48.69	-25.31	74	41.94	32.5	6.79	32.54	349	82	P	V	
	5380.08	40.69	-13.31	54	33.94	32.5	6.8	32.55	349	82	A	V	



802.11n HT20 CH 64 5320MHz	*	5320	102.36	-	-	95.66	32.5	6.74	32.54	100	116	P	H
	*	5320	94.91	-	-	88.21	32.5	6.74	32.54	100	116	A	H
		5352.16	50.77	-23.23	74	44.04	32.5	6.77	32.54	100	116	P	H
		5350.72	42.3	-11.7	54	35.57	32.5	6.77	32.54	100	116	A	H
													H
													H
	*	5320	101.02	-	-	94.32	32.5	6.74	32.54	344	83	P	V
	*	5320	93.34	-	-	86.64	32.5	6.74	32.54	344	83	A	V
		5351.36	49.65	-24.35	74	42.92	32.5	6.77	32.54	344	83	P	V
		5350.56	41.74	-12.26	54	35.01	32.5	6.77	32.54	344	83	A	V
													V
													V
Remark	1. No other spurious found. 2. All results are PASS against Peak and Average limit line.												



Band 2 5250~5350MHz
WIFI 802.11n HT20 (Harmonic @ 3m)

WIFI Ant. 1	Note	Frequency (MHz)	Level (dBμV/m)	Over Limit (dB)	Limit Line (dBμV/m)	Read Level (dBμV)	Antenna Factor (dB/m)	Cable Loss (dB)	Preamp Factor (dB)	Ant Pos (cm)	Table Pos (deg)	Peak Avg. (P/A)	Pol. (H/V)	
802.11n HT20 CH 52 5260MHz		10520	44.23	-29.77	74	59.6	39.05	10.24	65.2	100	0	P	H	
		15780	60.36	-13.64	74	71.92	38.39	13.82	64.51	100	256	P	H	
		15780	50.08	-3.92	54	61.64	38.39	13.82	64.51	100	256	A	H	
													H	
			10520	44.19	-29.81	74	59.56	39.05	10.24	65.2	100	0	P	V
			15780	57.83	-16.17	74	69.39	38.39	13.82	64.51	104	76	P	V
			15780	47.18	-6.82	54	58.74	38.39	13.82	64.51	104	76	A	V
													V	
802.11n HT20 CH 60 5300MHz		10600	44.9	-29.1	74	60.03	39.31	10.2	65.18	100	0	P	H	
		15900	61.37	-12.63	74	73.13	38.34	13.94	64.77	100	258	P	H	
		15900	50.94	-3.06	54	62.7	38.34	13.94	64.77	100	258	A	H	
													H	
			10600	44.57	-29.43	74	59.7	39.31	10.2	65.18	100	0	P	V
			15900	60.3	-13.7	74	72.06	38.34	13.94	64.77	115	74	P	V
			15900	49.91	-4.09	54	61.67	38.34	13.94	64.77	115	74	A	V
													V	
802.11n HT20 CH 64 5320MHz		10640	45.66	-28.34	74	60.7	39.41	10.19	65.17	100	0	P	H	
		15960	53.95	-20.05	74	65.85	38.31	13.99	64.92	100	257	P	H	
		15960	44.06	-9.94	54	55.96	38.31	13.99	64.92	100	257	A	H	
													H	
			10640	45.38	-28.62	74	60.42	39.41	10.19	65.17	100	0	P	V
			15960	59.66	-14.34	74	71.56	38.31	13.99	64.92	114	76	P	V
			15960	50.96	-3.04	54	62.86	38.31	13.99	64.92	114	76	A	V
													V	
Remark	1. No other spurious found. 2. All results are PASS against Peak and Average limit line.													



Band 2 5250~5350MHz
WIFI 802.11n HT40 (Band Edge @ 3m)

WIFI Ant. 1	Note	Frequency (MHz)	Level (dBμV/m)	Over Limit (dB)	Limit Line (dBμV/m)	Read Level (dBμV)	Antenna Factor (dB/m)	Cable Loss (dB)	Preamp Factor (dB)	Ant Pos (cm)	Table Pos (deg)	Peak Avg. (P/A)	Pol. (H/V)
802.11n HT40 CH 54 5270MHz		5122.06	48.72	-25.28	74	42.17	32.5	6.59	32.54	100	245	P	H
		5121.72	42.02	-11.98	54	35.47	32.5	6.59	32.54	100	245	A	H
	*	5270	104.81	-	-	98.14	32.5	6.71	32.54	100	245	P	H
	*	5270	98.25	-	-	91.58	32.5	6.71	32.54	100	245	A	H
		5376.96	49.71	-24.29	74	42.96	32.5	6.8	32.55	100	245	P	H
		5355.36	42.65	-11.35	54	35.92	32.5	6.77	32.54	100	245	A	H
		5122.74	47.69	-26.31	74	41.14	32.5	6.59	32.54	386	96	P	V
		5118.32	41.21	-12.79	54	34.66	32.5	6.59	32.54	386	96	A	V
	*	5270	102.94	-	-	96.27	32.5	6.71	32.54	386	96	P	V
	*	5270	95.93	-	-	89.26	32.5	6.71	32.54	386	96	A	V
		5417.52	48.36	-25.64	74	41.58	32.5	6.83	32.55	386	96	P	V
		5415.12	40.67	-13.33	54	33.89	32.5	6.83	32.55	386	96	A	V
802.11n HT40 CH 62 5310MHz		5117.3	47.59	-26.41	74	41.03	32.5	6.59	32.53	100	260	P	H
		5137.36	39.75	-14.25	54	33.19	32.5	6.6	32.54	100	260	A	H
	*	5310	100.96	-	-	94.26	32.5	6.74	32.54	100	260	P	H
	*	5310	93.54	-	-	86.84	32.5	6.74	32.54	100	260	A	H
		5350.56	59.07	-14.93	74	52.34	32.5	6.77	32.54	100	260	P	H
		5350.08	50.23	-3.77	54	43.5	32.5	6.77	32.54	100	260	A	H
		5141.1	47.44	-26.56	74	40.88	32.5	6.6	32.54	385	94	P	V
		5140.08	39.9	-14.1	54	33.34	32.5	6.6	32.54	385	94	A	V
	*	5310	98.81	-	-	92.11	32.5	6.74	32.54	385	94	P	V
	*	5310	91.68	-	-	84.98	32.5	6.74	32.54	385	94	A	V
	5351.28	55.08	-18.92	74	48.35	32.5	6.77	32.54	385	94	P	V	
	5350.08	47.09	-6.91	54	40.36	32.5	6.77	32.54	385	94	A	V	
Remark	1. No other spurious found. 2. All results are PASS against Peak and Average limit line.												



Band 2 5250~5350MHz
WIFI 802.11n HT40 (Harmonic @ 3m)

WIFI Ant. 1	Note	Frequency (MHz)	Level (dBμV/m)	Over Limit (dB)	Limit Line (dBμV/m)	Read Level (dBμV)	Antenna Factor (dB/m)	Cable Loss (dB)	Preamp Factor (dB)	Ant Pos (cm)	Table Pos (deg)	Peak Avg. (P/A)	Pol. (H/V)
802.11n HT40 CH 54 5270MHz		10540	45.21	-28.79	74	60.53	39.1	10.23	65.19			P	H
		15810	57.9	-16.1	74	69.51	38.38	13.85	64.58	100	256	P	H
		15810	50.55	-3.45	54	62.16	38.38	13.85	64.58	100	256	A	H
													H
		10540	46.01	-27.99	74	61.33	39.1	10.23	65.19			P	V
		15810	54.35	-19.65	74	65.96	38.38	13.85	64.58	114	75	P	V
		15810	49.1	-4.9	54	60.71	38.38	13.85	64.58	114	75	A	V
													V
802.11n HT40 CH 62 5310MHz		10620	45.03	-28.97	74	60.12	39.36	10.2	65.18	100	0	P	H
		15930	47.25	-26.75	74	59.07	38.33	13.97	64.85	100	0	P	H
													H
													H
		10620	45.34	-28.66	74	60.43	39.36	10.2	65.18	100	0	P	V
		15930	47.17	-26.83	74	58.99	38.33	13.97	64.85	100	0	P	V
													V
Remark	1. No other spurious found. 2. All results are PASS against Peak and Average limit line.												



Band 3 - 5470~5725MHz
WIFI 802.11a (Band Edge @ 3m)

WIFI	Note	Frequency	Level	Over	Limit	Read	Antenna	Cable	Preamp	Ant	Table	Peak	Pol.	
Ant.				Limit	Line	Level	Factor	Loss	Factor	Pos	Pos	Avg.		
1		(MHz)	(dBμV/m)	(dB)	(dBμV/m)	(dBμV)	(dB/m)	(dB)	(dB)	(cm)	(deg)	(P/A)	(H/V)	
802.11a CH 100 5500MHz		5451.44	53.21	-20.79	74	46.4	32.5	6.86	32.55	105	222	P	H	
		5469.68	45.78	-8.22	54	38.96	32.5	6.87	32.55	105	222	A	H	
	*	5500	105.5	-	-	98.67	32.5	6.88	32.55	105	222	P	H	
	*	5500	98.84	-	-	92.01	32.5	6.88	32.55	105	222	A	H	
													H	
													H	
			5470	49.74	-24.26	74	42.92	32.5	6.87	32.55	396	95	P	V
			5470	42.95	-11.05	54	36.13	32.5	6.87	32.55	396	95	A	V
	*		5500	104.6	-	-	97.77	32.5	6.88	32.55	396	95	P	V
	*		5500	97.45	-	-	90.62	32.5	6.88	32.55	396	95	A	V
														V
														V
802.11a CH 116 5580MHz		5367.52	48.78	-25.22	74	42.03	32.5	6.79	32.54	100	221	P	H	
		5427.04	40.74	-13.26	54	33.96	32.5	6.83	32.55	100	221	A	H	
	*	5580	105.06	-	-	98.1	32.61	6.94	32.59	100	221	P	H	
	*	5580	98.58	-	-	91.62	32.61	6.94	32.59	100	221	A	H	
			5754.29	48.08	-25.92	74	40.76	32.91	7.06	32.65	100	221	P	H
			5749.565	41.94	-12.06	54	34.66	32.89	7.04	32.65	100	221	A	H
			5378.8	47.86	-26.14	74	41.11	32.5	6.8	32.55	387	93	P	V
			5428	40.44	-13.56	54	33.66	32.5	6.83	32.55	387	93	A	V
	*		5580	103.24	-	-	96.28	32.61	6.94	32.59	387	93	P	V
	*		5580	96.03	-	-	89.07	32.61	6.94	32.59	387	93	A	V
			5748.935	51.27	-22.73	74	43.99	32.89	7.04	32.65	387	93	P	V
			5739.485	44.22	-9.78	54	36.94	32.89	7.04	32.65	387	93	A	V



802.11a CH 140 5700MHz	*	5700	105.74	-	-	98.55	32.8	7.02	32.63	101	223	P	H
	*	5700	97.56	-	-	90.37	32.8	7.02	32.63	101	223	A	H
		5728.6	55.7	-18.3	74	48.45	32.86	7.03	32.64	101	223	P	H
		5725.4	46.24	-7.76	54	38.99	32.86	7.03	32.64	101	223	A	H
													H
													H
	*	5700	100.4	-	-	93.21	32.8	7.02	32.63	391	92	P	V
	*	5700	94.56	-	-	87.37	32.8	7.02	32.63	391	92	A	V
		5739	48.91	-25.09	74	41.63	32.89	7.04	32.65	391	92	P	V
		5725	41.59	-12.41	54	34.34	32.86	7.03	32.64	391	92	A	V
													V
													V
Remark	1. No other spurious found. 2. All results are PASS against Peak and Average limit line.												



Band 3 - 5470~5725MHz
WIFI 802.11a (Harmonic @ 3m)

WIFI Ant. 1	Note	Frequency (MHz)	Level (dBμV/m)	Over Limit (dB)	Limit Line (dBμV/m)	Read Level (dBμV)	Antenna Factor (dB/m)	Cable Loss (dB)	Preamp Factor (dB)	Ant Pos (cm)	Table Pos (deg)	Peak Avg. (P/A)	Pol. (H/V)	
802.11a CH 100 5500MHz		11000	47.59	-26.41	74	61.67	40.5	10	65.1	100	0	P	H	
		16500	63.75	-4.45	68.2	75.29	38.9	13.97	65.1	100	0	P	H	
													H	
													H	
			11000	47.81	-26.19	74	61.89	40.5	10	65.1	100	0	P	V
			16500	62.94	-5.26	68.2	74.48	38.9	13.97	65.1	100	0	P	V
														V
														V
802.11a CH 116 5580MHz		11160	46.82	-27.18	74	61.15	40.07	10.28	65.2	100	0	P	H	
		16740	63.68	-4.52	68.2	74.31	39.62	13.94	64.86	100	0	P	H	
													H	
													H	
			11160	47.6	-26.4	74	61.93	40.07	10.28	65.2	100	0	P	V
			16740	61.34	-6.86	68.2	71.97	39.62	13.94	64.86	100	0	P	V
														V
														V
802.11a CH 140 5700MHz		11400	47.79	-26.21	74	62.45	39.46	10.71	65.34	100	0	P	H	
		17100	62.66	-5.54	68.2	71.79	40.72	13.96	64.46	100	0	P	H	
													H	
													H	
			11400	49.75	-24.25	74	64.41	39.46	10.71	65.34	100	0	P	V
			17100	57.22	-10.98	68.2	66.35	40.72	13.96	64.46	100	0	P	V
														V
														V
Remark	1. No other spurious found. 2. All results are PASS against Peak and Average limit line.													



Band 3 - 5470~5725MHz
WIFI 802.11n HT20 (Band Edge @ 3m)

WIFI Ant. 1	Note	Frequency (MHz)	Level (dBμV/m)	Over Limit (dB)	Limit Line (dBμV/m)	Read Level (dBμV)	Antenna Factor (dB/m)	Cable Loss (dB)	Preamp Factor (dB)	Ant Pos (cm)	Table Pos (deg)	Peak Avg. (P/A)	Pol. (H/V)	
802.11n HT20 CH 100 5500MHz		5455.76	52.51	-21.49	74	45.7	32.5	6.86	32.55	107	214	P	H	
		5469.84	45.19	-8.81	54	38.37	32.5	6.87	32.55	107	214	A	H	
	*	5500	105.06	-	-	98.23	32.5	6.88	32.55	107	214	P	H	
	*	5500	98.49	-	-	91.66	32.5	6.88	32.55	107	214	A	H	
													H	
														H
			5462.8	49.87	-24.13	74	43.06	32.5	6.86	32.55	388	93	P	V
			5470	42.59	-11.41	54	35.77	32.5	6.87	32.55	388	93	A	V
		*	5500	103.23	-	-	96.4	32.5	6.88	32.55	388	93	P	V
		*	5500	96.3	-	-	89.47	32.5	6.88	32.55	388	93	A	V
														V
														V
802.11n HT20 CH 116 5580MHz		5457.76	48.22	-25.78	74	41.41	32.5	6.86	32.55	100	219	P	H	
		5428.24	41.06	-12.94	54	34.28	32.5	6.83	32.55	100	219	A	H	
		*	5580	105.45	-	-	98.49	32.61	6.94	32.59	100	219	P	H
		*	5580	99.04	-	-	92.08	32.61	6.94	32.59	100	219	A	H
			5731.925	47.35	-26.65	74	40.11	32.86	7.03	32.65	100	219	P	H
			5731.61	39.99	-14.01	54	32.75	32.86	7.03	32.65	100	219	A	H
			5464.72	47.83	-26.17	74	41.02	32.5	6.86	32.55	365	86	P	V
			5428.24	40.34	-13.66	54	33.56	32.5	6.83	32.55	365	86	A	V
		*	5580	103.22	-	-	96.26	32.61	6.94	32.59	365	86	P	V
		*	5580	96.08	-	-	89.12	32.61	6.94	32.59	365	86	A	V
			5759.015	46.98	-27.02	74	39.67	32.91	7.06	32.66	365	86	P	V
			5740.115	43.47	-10.53	54	36.19	32.89	7.04	32.65	365	86	A	V



802.11n HT20 CH 140 5700MHz	*	5700	105.63	-	-	98.44	32.8	7.02	32.63	100	230	P	H
	*	5700	97.92	-	-	90.73	32.8	7.02	32.63	100	230	A	H
		5726.12	62.54	-11.46	74	55.29	32.86	7.03	32.64	100	230	P	H
		5725	48.61	-5.39	54	41.36	32.86	7.03	32.64	100	230	A	H
													H
													H
	*	5700	101.67	-	-	94.48	32.8	7.02	32.63	388	91	P	V
	*	5700	95.59	-	-	88.4	32.8	7.02	32.63	388	91	A	V
		5725.24	53.2	-20.8	74	45.95	32.86	7.03	32.64	388	91	P	V
		5725	44.42	-9.58	54	37.17	32.86	7.03	32.64	388	91	A	V
													V
													V
Remark	1. No other spurious found. 2. All results are PASS against Peak and Average limit line.												



Band 3 - 5470~5725MHz
WIFI 802.11n HT20 (Harmonic @ 3m)

WIFI Ant. 1	Note	Frequency (MHz)	Level (dBμV/m)	Over Limit (dB)	Limit Line (dBμV/m)	Read Level (dBμV)	Antenna Factor (dB/m)	Cable Loss (dB)	Preamp Factor (dB)	Ant Pos (cm)	Table Pos (deg)	Peak Avg. (P/A)	Pol. (H/V)	
802.11n HT20 CH 100 5500MHz		11000	47.26	-26.74	74	61.34	40.5	10	65.1	100	0	P	H	
		16500	64.68	-3.52	68.2	76.22	38.9	13.97	65.1	100	268	P	H	
													H	
													H	
			11000	48.14	-25.86	74	62.22	40.5	10	65.1	100	0	P	V
			16500	61.76	-6.44	68.2	73.3	38.9	13.97	65.1	109	74	P	V
														V
802.11n HT20 CH 116 5580MHz		11160	46.74	-27.26	74	61.07	40.07	10.28	65.2	100	0	P	H	
		16740	62.71	-5.49	68.2	73.34	39.62	13.94	64.86	100	0	P	H	
													H	
													H	
			11160	46.53	-27.47	74	60.86	40.07	10.28	65.2	100	0	P	V
			16740	59.07	-9.13	68.2	69.7	39.62	13.94	64.86	100	0	P	V
														V
802.11n HT20 CH 140 5700MHz		11400	46.68	-27.32	74	61.34	39.46	10.71	65.34	100	0	P	H	
		17100	61.94	-6.26	68.2	71.07	40.72	13.96	64.46	100	0	P	H	
													H	
													H	
			11400	49.18	-24.82	74	63.84	39.46	10.71	65.34	100	0	P	V
			17100	56.01	-12.19	68.2	65.14	40.72	13.96	64.46	100	0	P	V
														V
Remark	1. No other spurious found.													
	2. All results are PASS against Peak and Average limit line.													



**Band 3 - 5470~5725MHz
WIFI 802.11n HT40 (Band Edge @ 3m)**

WIFI Ant. 1	Note	Frequency (MHz)	Level (dBμV/m)	Over Limit (dB)	Limit Line (dBμV/m)	Read Level (dBμV)	Antenna Factor (dB/m)	Cable Loss (dB)	Preamp Factor (dB)	Ant Pos (cm)	Table Pos (deg)	Peak Avg. (P/A)	Pol. (H/V)
802.11n HT40 CH 102 5510MHz		5459.55	62.45	-11.55	74	55.64	32.5	6.86	32.55	100	217	P	H
		5470	65.18	-3.02	68.2	58.36	32.5	6.87	32.55	100	217	P	H
		5459.9	50.71	-3.29	54	43.9	32.5	6.86	32.55	100	217	A	H
	*	5510	102.76	-	-	95.93	32.5	6.89	32.56	100	217	P	H
	*	5510	95.84	-	-	89.01	32.5	6.89	32.56	100	217	A	H
		5727.83	48.58	-19.62	68.2	41.33	32.86	7.03	32.64	100	217	P	H
		5454.3	52.91	-21.09	74	46.1	32.5	6.86	32.55	396	95	P	V
		5467.6	62.55	-5.65	68.2	55.73	32.5	6.87	32.55	396	95	P	V
		5459.55	45.25	-8.75	54	38.44	32.5	6.86	32.55	396	95	A	V
	*	5510	99.45	-	-	92.62	32.5	6.89	32.56	396	95	P	V
	*	5510	93.61	-	-	86.78	32.5	6.89	32.56	396	95	A	V
		5753.03	49.11	-19.09	68.2	41.81	32.91	7.04	32.65	396	95	P	V
802.11n HT40 CH 110 5550MHz		5465.5	49.22	-24.78	74	42.41	32.5	6.86	32.55	100	219	P	H
		5469.35	42.86	-11.14	54	36.04	32.5	6.87	32.55	100	219	A	H
	*	5550	102.47	-	-	95.55	32.58	6.91	32.57	100	219	P	H
	*	5550	96.05	-	-	89.13	32.58	6.91	32.57	100	219	A	H
		5749.565	47.95	-26.05	74	40.67	32.89	7.04	32.65	100	219	P	H
		5753.03	44	-10	54	36.7	32.91	7.04	32.65	100	219	A	H
		5428.05	48.56	-25.44	74	41.78	32.5	6.83	32.55	391	92	P	V
		5402.15	41.3	-12.7	54	34.53	32.5	6.82	32.55	391	92	A	V
	*	5550	99.84	-	-	92.92	32.58	6.91	32.57	391	92	P	V
	*	5550	93.35	-	-	86.43	32.58	6.91	32.57	391	92	A	V
		5732.87	47.98	-26.02	74	40.74	32.86	7.03	32.65	391	92	P	V
		5748.935	40.75	-13.25	54	33.47	32.89	7.04	32.65	391	92	A	V



802.11n HT40 CH 134 5670MHz		5374.15	46.97	-27.03	74	40.23	32.5	6.79	32.55	100	221	P	H
		5457.45	39.5	-14.5	54	32.69	32.5	6.86	32.55	100	221	A	H
	*	5670	102.93	-	-	95.77	32.78	7	32.62	100	221	P	H
	*	5670	95.79	-	-	88.63	32.78	7	32.62	100	221	A	H
		5725	53.22	-20.78	74	45.97	32.86	7.03	32.64	100	221	P	H
		5726.255	45.61	-8.39	54	38.36	32.86	7.03	32.64	100	221	A	H
		5398.65	46.6	-27.4	74	39.83	32.5	6.82	32.55	393	94	P	V
		5370.65	39.02	-14.98	54	32.27	32.5	6.79	32.54	393	94	A	V
	*	5670	99.71	-	-	92.55	32.78	7	32.62	393	94	P	V
	*	5670	91.61	-	-	84.45	32.78	7	32.62	393	94	A	V
		5759.645	48.01	-25.99	74	40.7	32.91	7.06	32.66	393	94	P	V
		5726.57	40.65	-13.35	54	33.4	32.86	7.03	32.64	393	94	A	V
Remark	1. No other spurious found. 2. All results are PASS against Peak and Average limit line.												



Band 3 - 5470~5725MHz
WIFI 802.11n HT40 (Harmonic @ 3m)

WIFI Ant. 1	Note	Frequency (MHz)	Level (dBµV/m)	Over Limit (dB)	Limit Line (dBµV/m)	Read Level (dBµV)	Antenna Factor (dB/m)	Cable Loss (dB)	Preamp Factor (dB)	Ant Pos (cm)	Table Pos (deg)	Peak Avg. (P/A)	Pol. (H/V)	
802.11n HT40 CH 102 5510MHz		11020	46.93	-27.07	74	61	40.46	10.06	65.11	100	0	P	H	
		16530	60.64	-7.56	68.2	72.05	39	13.97	65.07	100	0	P	H	
													H	
													H	
			11020	47.81	-26.19	74	61.88	40.46	10.06	65.11	100	0	P	V
			16530	52.62	-15.58	68.2	64.03	39	13.97	65.07	100	0	P	V
														V
802.11n HT40 CH 110 5550MHz		11100	46.91	-27.09	74	61.13	40.24	10.18	65.16	100	0	P	H	
		16650	60.52	-7.68	68.2	71.46	39.37	13.95	64.94	100	0	P	H	
													H	
													H	
			11100	47.66	-26.34	74	61.88	40.24	10.18	65.16	100	0	P	V
			16650	56.09	-12.11	68.2	67.03	39.37	13.95	64.94	100	0	P	V
														V
802.11n HT40 CH 134 5670MHz		11340	46.99	-27.01	74	61.56	39.63	10.58	65.3	100	0	P	H	
		17010	62	-6.2	68.2	71.56	40.45	13.92	64.58	100	0	P	H	
													H	
													H	
			11340	47.03	-26.97	74	61.6	39.63	10.58	65.3	100	0	P	V
			17010	56.87	-11.33	68.2	66.43	40.45	13.92	64.58	100	0	P	V
														V
Remark	1. No other spurious found.													
	2. All results are PASS against Peak and Average limit line.													



Band 3 - Straddle Channel
WIFI 802.11a (Band Edge @ 3m)

WIFI	Note	Frequency	Level	Over	Limit	Read	Antenna	Cable	Preamp	Ant	Table	Peak	Pol.
Ant.				Limit	Line	Level	Factor	Loss	Factor	Pos	Pos	Avg.	
1		(MHz)	(dBμV/m)	(dB)	(dBμV/m)	(dBμV)	(dB/m)	(dB)	(dB)	(cm)	(deg)	(P/A)	(H/V)
802.11a CH 144 5720MHz	*	5720	104.74	-	-	97.49	32.86	7.03	32.64	100	215	P	H
	*	5720	98.07	-	-	90.82	32.86	7.03	32.64	100	215	A	H
													H
													H
													H
													H
	*	5720	100.33	-	-	93.08	32.86	7.03	32.64	365	84	P	V
	*	5720	94.44	-	-	87.19	32.86	7.03	32.64	365	84	A	V
													V
													V
													V
	Remark	1. No other spurious found. 2. All results are PASS against Peak and Average limit line.											



Band 3 - Straddle Channel
WIFI 802.11a (Harmonic @ 3m)

WIFI Ant. 1	Note	Frequency (MHz)	Level (dBµV/m)	Over Limit (dB)	Limit Line (dBµV/m)	Read Level (dBµV)	Antenna Factor (dB/m)	Cable Loss (dB)	Preamp Factor (dB)	Ant Pos (cm)	Table Pos (deg)	Peak Avg. (P/A)	Pol. (H/V)	
802.11a CH 144 5720MHz		11440	47.93	-26.07	74	62.64	39.37	10.77	65.36	100	0	P	H	
		17160	64.59	-3.61	68.2	73.4	40.93	13.99	64.37	100	0	P	H	
													H	
													H	
			11440	51.32	-22.68	74	66.03	39.37	10.77	65.36	100	0	P	V
			17160	61.52	-6.68	68.2	70.33	40.93	13.99	64.37	100	0	P	V
														V
														V
Remark	1. No other spurious found. 2. All results are PASS against Peak and Average limit line.													



Band 3 - Straddle Channel
WIFI 802.11n HT20 (Band Edge @ 3m)

WIFI Ant. 1	Note	Frequency (MHz)	Level (dBμV/m)	Over Limit (dB)	Limit Line (dBμV/m)	Read Level (dBμV)	Antenna Factor (dB/m)	Cable Loss (dB)	Preamp Factor (dB)	Ant Pos (cm)	Table Pos (deg)	Peak Avg. (P/A)	Pol. (H/V)
802.11n HT20 CH 144 5720MHz	*	5720	105.05	-	-	97.8	32.86	7.03	32.64	100	214	P	H
	*	5720	97.85	-	-	90.6	32.86	7.03	32.64	100	214	A	H
													H
													H
													H
													H
	*	5720	100.08	-	-	92.83	32.86	7.03	32.64	385	84	P	V
	*	5720	93.88	-	-	86.63	32.86	7.03	32.64	385	84	A	V
													V
													V
												V	
												V	
Remark	1. No other spurious found. 2. All results are PASS against Peak and Average limit line.												



Band 3 - Straddle Channel
WIFI 802.11n HT20 (Harmonic @ 3m)

WIFI Ant. 1	Note	Frequency (MHz)	Level (dBμV/m)	Over Limit (dB)	Limit Line (dBμV/m)	Read Level (dBμV)	Antenna Factor (dB/m)	Cable Loss (dB)	Preamp Factor (dB)	Ant Pos (cm)	Table Pos (deg)	Peak Avg. (P/A)	Pol. (H/V)	
802.11n HT20 CH 144 5720MHz		11440	47.13	-26.87	74	61.84	39.37	10.77	65.36	100	0	P	H	
		17160	61.94	-6.26	68.2	70.75	40.93	13.99	64.37	100	0	P	H	
													H	
													H	
			11440	48.93	-25.07	74	63.64	39.37	10.77	65.36	100	0	P	V
			17160	54.95	-13.25	68.2	63.76	40.93	13.99	64.37	100	0	P	V
														V
														V
Remark	1. No other spurious found. 2. All results are PASS against Peak and Average limit line.													



**Band 3 - Straddle Channel
WIFI 802.11n HT40 (Band Edge @ 3m)**

WIFI Ant. 1	Note	Frequency (MHz)	Level (dBμV/m)	Over Limit (dB)	Limit Line (dBμV/m)	Read Level (dBμV)	Antenna Factor (dB/m)	Cable Loss (dB)	Preamp Factor (dB)	Ant Pos (cm)	Table Pos (deg)	Peak Avg. (P/A)	Pol. (H/V)
802.11n HT40 CH 142 5710MHz	*	5710	102.34	-	-	95.13	32.83	7.02	32.64	100	223	P	H
	*	5710	94.84	-	-	87.63	32.83	7.02	32.64	100	223	A	H
													H
													H
													H
													H
	*	5710	99.05	-	-	91.84	32.83	7.02	32.64	387	86	P	V
	*	5710	91.2	-	-	83.99	32.83	7.02	32.64	387	86	A	V
													V
													V
												V	
												V	
Remark	1. No other spurious found. 2. All results are PASS against Peak and Average limit line.												



Band 3 - Straddle Channel
WIFI 802.11n HT40 (Harmonic @ 3m)

WIFI Ant. 1	Note	Frequency (MHz)	Level (dBμV/m)	Over Limit (dB)	Limit Line (dBμV/m)	Read Level (dBμV)	Antenna Factor (dB/m)	Cable Loss (dB)	Preamp Factor (dB)	Ant Pos (cm)	Table Pos (deg)	Peak Avg. (P/A)	Pol. (H/V)	
802.11n HT40 CH 142 5710MHz		11420	46.54	-27.46	74	61.22	39.42	10.74	65.35	100	0	P	H	
		17130	59.97	-8.23	68.2	68.92	40.83	13.98	64.41	100	0	P	H	
													H	
													H	
			11420	48.9	-25.1	74	63.58	39.42	10.74	65.35	100	0	P	V
			17130	54.9	-13.3	68.2	63.85	40.83	13.98	64.41	100	0	P	V
														V
													V	
Remark	1. No other spurious found. 2. All results are PASS against Peak and Average limit line.													



Emission below 1GHz

WIFI 802.11a (LF @ 3m)

WIFI	Note	Frequency	Level	Over	Limit	Read	Antenna	Cable	Preamp	Ant	Table	Peak	Pol.	
Ant.				Limit	Line	Level	Factor	Loss	Factor	Pos	Pos	Avg.		
1		(MHz)	(dBμV/m)	(dB)	(dBμV/m)	(dBμV)	(dB/m)	(dB)	(dB)	(cm)	(deg)	(P/A)	(H/V)	
802.11a LF		41.07	23.53	-16.47	40	36.58	18.9	0.69	32.75			P	H	
		98.31	25.53	-17.97	43.5	41.33	15.76	0.97	32.77			P	H	
		131.79	25.45	-18.05	43.5	39.27	17.52	1.12	32.76			P	H	
		558.3	27.37	-18.63	46	31.43	26.12	2.18	32.95			P	H	
		745.9	29.38	-16.62	46	31.01	28.21	2.51	32.95			P	H	
		958.7	32.72	-13.28	46	29.72	31.05	2.79	31.65	100	0	P	H	
													H	
													H	
													H	
													H	
													H	
													H	
													H	
			31.62	30.91	-9.09	40	39.71	23.34	0.53	32.75			P	V
			40.8	35.29	-4.71	40	48.34	18.9	0.69	32.75	100	0	P	V
			97.5	28.74	-14.76	43.5	44.54	15.76	0.97	32.77			P	V
			568.8	27.13	-18.87	46	31.36	25.94	2.21	32.96			P	V
			767.6	30.14	-15.86	46	31.6	28.32	2.54	32.93			P	V
			951	32.38	-13.62	46	29.77	30.76	2.78	31.74			P	V
													V	
												V		
												V		
												V		
												V		
												V		
Remark	1. No other spurious found. 2. All results are PASS against limit line.													



Emission below 1GHz
WIFI 802.11n HT20 (LF @ 3m)

WIFI	Note	Frequency	Level	Over	Limit	Read	Antenna	Cable	Preamp	Ant	Table	Peak	Pol.	
Ant.				Limit	Line	Level	Factor	Loss	Factor	Pos	Pos	Avg.		
1		(MHz)	(dBμV/m)	(dB)	(dBμV/m)	(dBμV)	(dB/m)	(dB)	(dB)	(cm)	(deg)	(P/A)	(H/V)	
802.11n HT20 LF		41.34	23.65	-16.35	40	37.22	18.38	0.69	32.75			P	H	
		98.31	24.95	-18.55	43.5	40.75	15.76	0.97	32.77			P	H	
		133.95	25.79	-17.71	43.5	39.64	17.48	1.12	32.76			P	H	
		617.1	27.53	-18.47	46	31.63	26.03	2.29	33			P	H	
		835.5	30.99	-15.01	46	31.52	28.86	2.65	32.69			P	H	
		956.6	32.6	-13.4	46	29.69	30.98	2.79	31.67	100	0	P	H	
														H
														H
														H
														H
														H
														H
			41.61	35.77	-4.23	40	49.34	18.38	0.69	32.75	100	0	P	V
			77.79	25.77	-14.23	40	44.48	13.02	0.86	32.76			P	V
			96.96	28.94	-14.56	43.5	44.88	15.62	0.97	32.77			P	V
			685	28.57	-17.43	46	31.95	26.63	2.39	32.99			P	V
			840.4	30.69	-15.31	46	30.99	29.05	2.65	32.66			P	V
			956.6	32.77	-13.23	46	29.86	30.98	2.79	31.67			P	V
														V
														V
													V	
													V	
													V	
													V	
													V	
Remark	1. No other spurious found. 2. All results are PASS against limit line.													



Emission below 1GHz
WIFI 802.11n HT40 (LF @ 3m)

WIFI	Note	Frequency	Level	Over	Limit	Read	Antenna	Cable	Preamp	Ant	Table	Peak	Pol.	
Ant.				Limit	Line	Level	Factor	Loss	Factor	Pos	Pos	Avg.		
1		(MHz)	(dBμV/m)	(dB)	(dBμV/m)	(dBμV)	(dB/m)	(dB)	(dB)	(cm)	(deg)	(P/A)	(H/V)	
802.11n HT40 LF		40.8	23.65	-16.35	40	36.7	18.9	0.69	32.75			P	H	
		98.58	25.16	-18.34	43.5	40.81	15.91	0.97	32.77			P	H	
		128.28	25.91	-17.59	43.5	39.81	17.54	1.04	32.76			P	H	
		733.3	29.2	-16.8	46	31.22	27.87	2.48	32.96			P	H	
		838.3	31.16	-14.84	46	31.55	28.97	2.65	32.67			P	H	
		958	32.86	-13.14	46	29.87	31.05	2.79	31.66	100	0	P	H	
														H
														H
														H
														H
														H
														H
			42.15	35.76	-4.24	40	49.86	17.85	0.69	32.75	100	0	P	V
			78.06	25.83	-14.17	40	44.4	13.15	0.86	32.76			P	V
			96.96	27.93	-15.57	43.5	43.87	15.62	0.97	32.77			P	V
			638.8	27.36	-18.64	46	30.89	26.56	2.32	33			P	V
			763.4	29.24	-16.76	46	30.7	28.32	2.54	32.93			P	V
			951.7	33.06	-12.94	46	30.41	30.79	2.78	31.73			P	V
														V
														V
													V	
													V	
													V	
													V	
													V	
Remark	1. No other spurious found. 2. All results are PASS against limit line.													



Note symbol

*	Fundamental Frequency which can be ignored. However, the level of any unwanted emissions shall not exceed the level of the fundamental frequency.
!	Test result is over limit line.
P/A	Peak or Average
H/V	Horizontal or Vertical



A calculation example for radiated spurious emission is shown as below:

WIFI	Note	Frequency	Level	Over	Limit	Read	Antenna	Cable	Preamp	Ant	Table	Peak	Pol.
Ant.				Limit	Line	Level	Factor	Loss	Factor	Pos	Pos	Avg.	
1		(MHz)	(dBμV/m)	(dB)	(dBμV/m)	(dBμV)	(dB/m)	(dB)	(dB)	(cm)	(deg)	(P/A)	(H/V)
802.11b		2390	55.45	-18.55	74	54.51	32.22	4.58	35.86	103	308	P	H
CH 01													
2412MHz		2390	43.54	-10.46	54	42.6	32.22	4.58	35.86	103	308	A	H

- Level(dBμV/m) =
Antenna Factor(dB/m) + Cable Loss(dB) + Read Level(dBμV) - Preamp Factor(dB)
- Over Limit(dB) = Level(dBμV/m) – Limit Line(dBμV/m)

For Peak Limit @ 2390MHz:

- Level(dBμV/m)
= Antenna Factor(dB/m) + Cable Loss(dB) + Read Level(dBμV) - Preamp Factor(dB)
= 32.22(dB/m) + 4.58(dB) + 54.51(dBμV) – 35.86 (dB)
= 55.45 (dBμV/m)
- Over Limit(dB)
= Level(dBμV/m) – Limit Line(dBμV/m)
= 55.45(dBμV/m) – 74(dBμV/m)
= -18.55(dB)

For Average Limit @ 2390MHz:

- Level(dBμV/m)
= Antenna Factor(dB/m) + Cable Loss(dB) + Read Level(dBμV) - Preamp Factor(dB)
= 32.22(dB/m) + 4.58(dB) + 42.6(dBμV) – 35.86 (dB)
= 43.54 (dBμV/m)
- Over Limit(dB)
= Level(dBμV/m) – Limit Line(dBμV/m)
= 43.54(dBμV/m) – 54(dBμV/m)
= -10.46(dB)

Both peak and average measured complies with the limit line, so test result is “PASS”.



Appendix D. Radiated Spurious Emission

Test Engineer :	Tsung lee, Stan Hsieh and Kyle Chuang	Temperature :	22~24°C
		Relative Humidity :	43~44%

Note symbol

-L	Low channel location
-R	High channel location

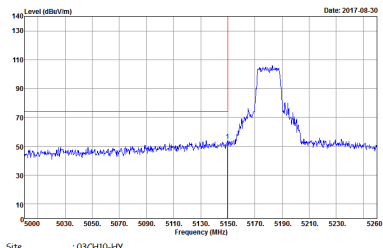
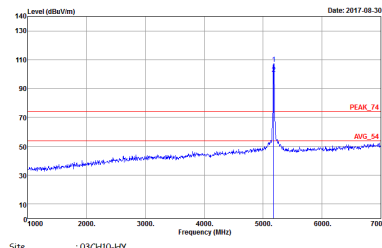
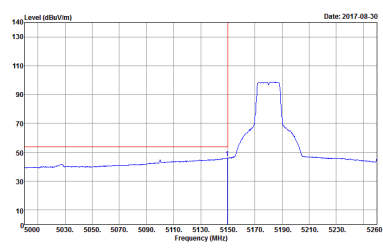

Band 1 - 5150~5250MHz
WIFI 802.11a (Band Edge @ 3m)

WIFI	Band 1 5150~5250MHz Band Edge @ 3m	
ANT	802.11a CH36 5180MHz	
1	Horizontal	Fundamental
Peak	 <p>Site : 03CH10-HY Condition : PEAK BE 74 3m HORN 9120D-HF HORIZONTAL</p>	 <p>Site : 03CH10-HY Condition : PEAK 74 3m HORN 9120D-HF HORIZONTAL</p>
Avg.	 <p>Site : 03CH10-HY Condition : AVG BE 54 3m HORN 9120D-HF HORIZONTAL</p>	Left blank



WIFI	Band 1 5150~5250MHz Band Edge @ 3m	
ANT	802.11a CH36 5180MHz	
1	Vertical	Fundamental
Peak	<p>Site : 03CH10-HY Condition : PEAK BE 74 3m HORN 9120D-HF VERTICAL</p>	<p>Site : 03CH10-HY Condition : PEAK 74 3m HORN 9120D-HF VERTICAL</p>
Avg.	<p>Site : 03CH10-HY Condition : AVG BE 54 3m HORN 9120D-HF VERTICAL</p>	Left blank



WIFI	Band 1 5150~5250MHz Band Edge @ 3m	
ANT	802.11a CH44 5220MHz - L	
1	Horizontal	Fundamental
Peak	<p>Site : 03CH10-HY Condition : PEAK BE 74 3m HORN 9120D-HF HORIZONTAL</p>	<p>Site : 03CH10-HY Condition : PEAK 74 3m HORN 9120D-HF HORIZONTAL</p>
Avg.	<p>Site : 03CH10-HY Condition : AVG BE 54 3m HORN 9120D-HF HORIZONTAL</p>	Left blank



WIFI	Band 1 5150~5250MHz Band Edge @ 3m	
ANT	802.11a CH44 5220MHz - R	
1	Horizontal	Fundamental
<p>Peak</p>		<p>Left blank</p>
<p>Avg.</p>		<p>Left blank</p>

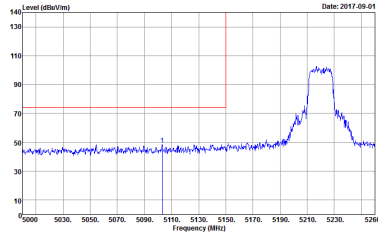
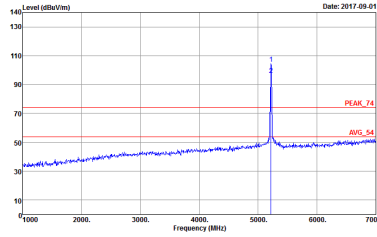
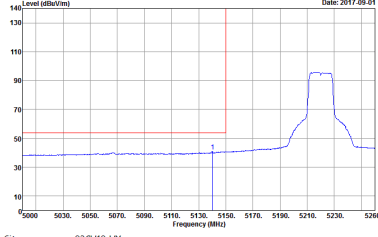

WIFI	Band 1 5150~5250MHz Band Edge @ 3m	
ANT	802.11a CH44 5220MHz - L	
1	Vertical	Fundamental
Peak	 <p>Site : 03CH10-HY Condition : PEAK BE 74 3m HORN 9120D-HF VERTICAL</p>	 <p>Site : 03CH10-HY Condition : PEAK 74 3m HORN 9120D-HF VERTICAL</p>
Avg.	 <p>Site : 03CH10-HY Condition : AVG BE 54 3m HORN 9120D-HF VERTICAL</p>	Left blank



WIFI	Band 1 5150~5250MHz Band Edge @ 3m	
ANT	802.11a CH44 5220MHz - R	
1	Vertical	Fundamental
<p>Peak</p>		<p>Left blank</p>
<p>Avg.</p>		<p>Left blank</p>



WIFI	Band 1 5150~5250MHz Band Edge @ 3m	
ANT	802.11a CH48 5240MHz - L	
1	Horizontal	Fundamental
Peak	<p>Site : 03CH10-HY Condition : PEAK BE 74 3m HORN 9120D-HF HORIZONTAL</p>	<p>Site : 03CH10-HY Condition : PEAK 74 3m HORN 9120D-HF HORIZONTAL</p>
Avg.	<p>Site : 03CH10-HY Condition : AVG BE 54 3m HORN 9120D-HF HORIZONTAL</p>	Left blank

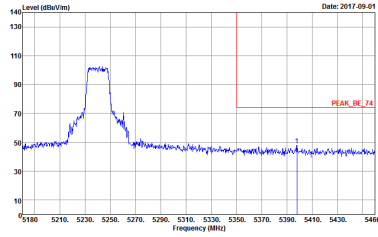
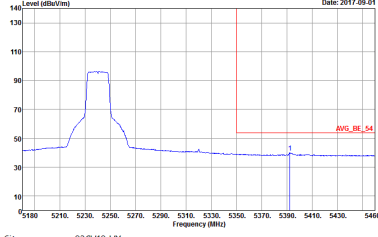

WIFI	Band 1 5150~5250MHz Band Edge @ 3m	
ANT	802.11a CH48 5240MHz - R	
1	Horizontal	Fundamental
<p>Peak</p>	 <p>Site : 03CH10-HY Condition : PEAK_BE_74 3m HORN 9120D-HF HORIZONTAL</p>	<p>Left blank</p>
<p>Avg.</p>	 <p>Site : 03CH10-HY Condition : AVG_BE_54 3m HORN 9120D-HF HORIZONTAL</p>	<p>Left blank</p>

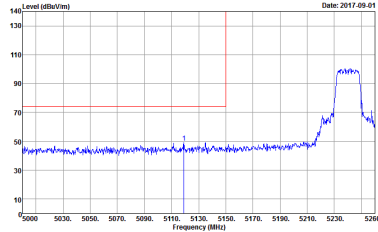
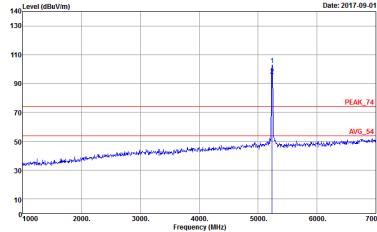
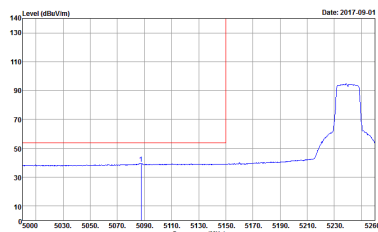

WIFI	Band 1 5150~5250MHz Band Edge @ 3m	
ANT	802.11a CH48 5240MHz - L	
1	Vertical	Fundamental
<p>Peak</p>	 <p>Site : 03CH10-HY Condition : PEAK BE 74 3m HORN 9120D-HF VERTICAL</p>	 <p>Site : 03CH10-HY Condition : PEAK 74 3m HORN 9120D-HF VERTICAL</p>
<p>Avg.</p>	 <p>Site : 03CH10-HY Condition : AVG BE 54 3m HORN 9120D-HF VERTICAL</p>	<p>Left blank</p>



WIFI	Band 1 5150~5250MHz Band Edge @ 3m	
ANT	802.11a CH48 5240MHz - R	
1	Vertical	Fundamental
<p>Peak</p>		<p>Left blank</p>
<p>Avg.</p>		<p>Left blank</p>

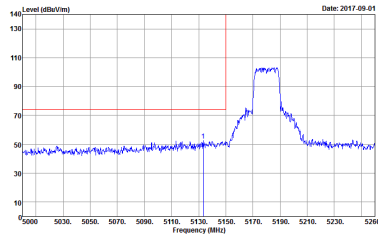
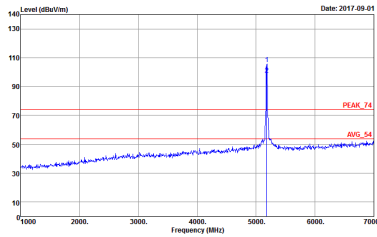
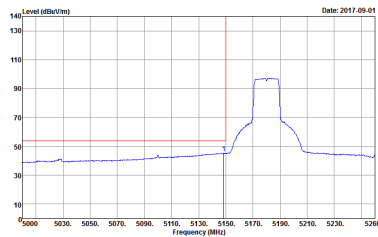

**Band 1 5150~5250MHz
WIFI 802.11n HT20 (Band Edge @ 3m)**

WIFI	Band 1 5150~5250MHz Band Edge @ 3m	
ANT	802.11n HT20 CH36 5180MHz	
1	Horizontal	Fundamental
Peak	 <p>Site : 03CH10-HY Condition : PEAK BE 74 3m HORN 9120D-HF HORIZONTAL</p>	 <p>Site : 03CH10-HY Condition : PEAK 74 3m HORN 9120D-HF HORIZONTAL</p>
Avg.	 <p>Site : 03CH10-HY Condition : AVG BE 54 3m HORN 9120D-HF HORIZONTAL</p>	Left blank



WIFI	Band 1 5150~5250MHz Band Edge @ 3m	
ANT	802.11n HT20 CH36 5180MHz	
1	Vertical	Fundamental
<p>Peak</p>	<p>Site : 03CH10-HY Condition : PEAK BE 74 3m HORN 9120D-HF VERTICAL</p>	<p>Site : 03CH10-HY Condition : PEAK 74 3m HORN 9120D-HF VERTICAL</p>
<p>Avg.</p>	<p>Site : 03CH10-HY Condition : AVG BE 54 3m HORN 9120D-HF VERTICAL</p>	<p>Left blank</p>

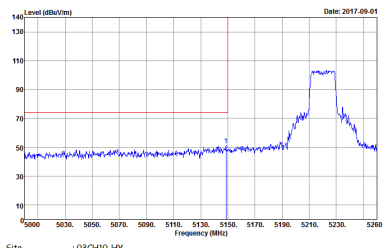
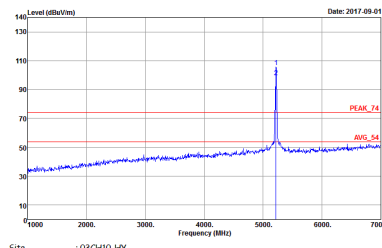
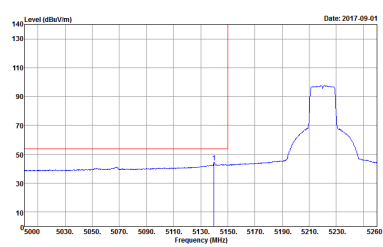

WIFI	Band 1 5150~5250MHz Band Edge @ 3m	
ANT	802.11n HT20 CH44 5220MHz - L	
1	Horizontal	Fundamental
Peak	 <p>Site : 03CH10-HY Condition : PEAK BE 74 3m HORN 9120D-HF HORIZONTAL</p>	 <p>Site : 03CH10-HY Condition : PEAK 74 3m HORN 9120D-HF HORIZONTAL</p>
Avg.	 <p>Site : 03CH10-HY Condition : AVG BE 54 3m HORN 9120D-HF HORIZONTAL</p>	Left blank

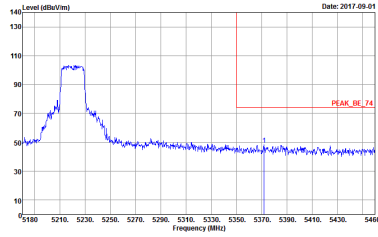
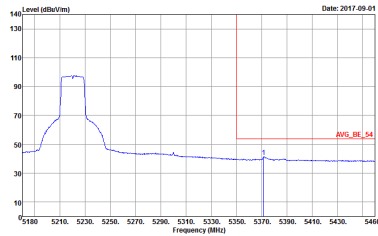

WIFI	Band 1 5150~5250MHz Band Edge @ 3m	
ANT	802.11n HT20 CH44 5220MHz - R	
1	Horizontal	Fundamental
<p>Peak</p>	 <p>Site : 03CH10-HY Condition : PEAK_BE_74 3m HORN 9120D-HF HORIZONTAL</p>	<p>Left blank</p>
<p>Avg.</p>	 <p>Site : 03CH10-HY Condition : AVG_BE_54 3m HORN 9120D-HF HORIZONTAL</p>	<p>Left blank</p>



WIFI	Band 1 5150~5250MHz Band Edge @ 3m	
ANT	802.11n HT20 CH44 5220MHz - L	
1	Vertical	Fundamental
<p>Peak</p>	<p>Site : 03CH10-HY Condition : PEAK BE 74 3m HORN 9120D-HF VERTICAL</p>	<p>Site : 03CH10-HY Condition : PEAK 74 3m HORN 9120D-HF VERTICAL</p>
<p>Avg.</p>	<p>Site : 03CH10-HY Condition : AVG BE 54 3m HORN 9120D-HF VERTICAL</p>	<p>Left blank</p>



WIFI	Band 1 5150~5250MHz Band Edge @ 3m	
ANT	802.11n HT20 CH44 5220MHz - R	
1	Vertical	Fundamental
<p>Peak</p>		<p>Left blank</p>
<p>Avg.</p>		<p>Left blank</p>

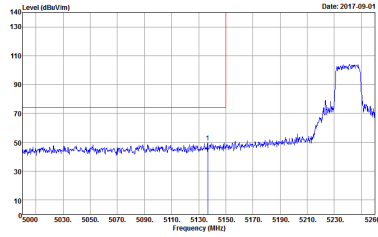
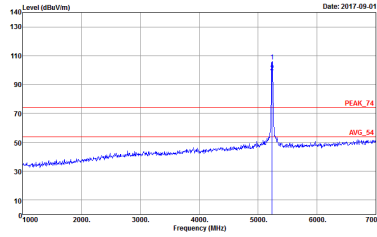
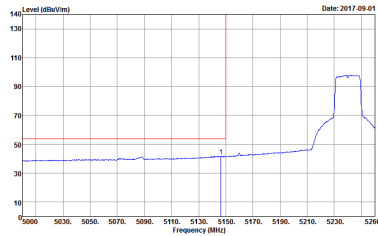

WIFI	Band 1 5150~5250MHz Band Edge @ 3m	
ANT	802.11n HT20 CH48 5240MHz - L	
1	Horizontal	Fundamental
<p>Peak</p>	 <p>Site : 03CH10-HY Condition : PEAK BE 74 3m HORN 9120D-HF HORIZONTAL</p>	 <p>Site : 03CH10-HY Condition : PEAK 74 3m HORN 9120D-HF HORIZONTAL</p>
<p>Avg.</p>	 <p>Site : 03CH10-HY Condition : AVG BE 54 3m HORN 9120D-HF HORIZONTAL</p>	<p>Left blank</p>

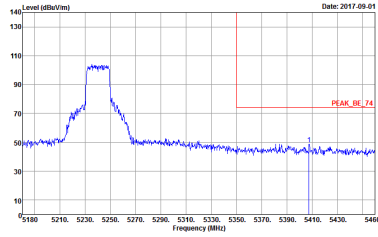
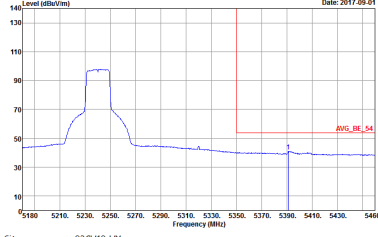

WIFI	Band 1 5150~5250MHz Band Edge @ 3m	
ANT	802.11n HT20 CH48 5240MHz - R	
1	Horizontal	Fundamental
<p>Peak</p>	 <p>Site : 03CH10-HY Condition : PEAK_BE_74 3m HORN 9120D-HF HORIZONTAL</p>	<p>Left blank</p>
<p>Avg.</p>	 <p>Site : 03CH10-HY Condition : AVG_BE_54 3m HORN 9120D-HF HORIZONTAL</p>	<p>Left blank</p>

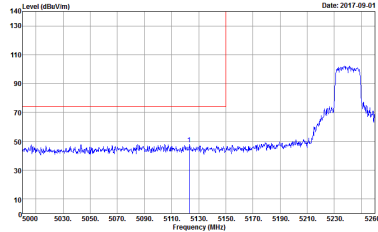
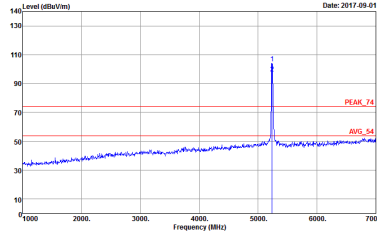
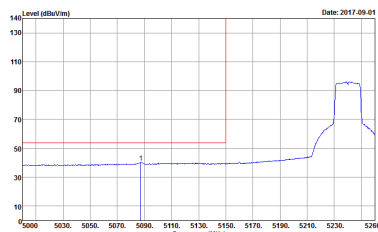

WIFI	Band 1 5150~5250MHz Band Edge @ 3m	
ANT	802.11n HT20 CH48 5240MHz - L	
1	Vertical	Fundamental
Peak	 <p>Site : 03CH10-HY Condition : PEAK BE 74 3m HORN 9120D-HF VERTICAL</p>	 <p>Site : 03CH10-HY Condition : PEAK 74 3m HORN 9120D-HF VERTICAL</p>
Avg.	 <p>Site : 03CH10-HY Condition : AVG BE 54 3m HORN 9120D-HF VERTICAL</p>	Left blank



WIFI	Band 1 5150~5250MHz Band Edge @ 3m	
ANT	802.11n HT20 CH48 5240MHz - R	
1	Vertical	Fundamental
<p>Peak</p>		<p>Left blank</p>
<p>Avg.</p>		<p>Left blank</p>



**Band 1 5150~5250MHz
WIFI 802.11n HT40 (Band Edge @ 3m)**

WIFI	Band 1 5150~5250MHz Band Edge @ 3m	
ANT	802.11n HT40 CH38 5190MHz - L	
1	Horizontal	Fundamental
Peak	<p>Site : 03CH10-HY Condition : PEAK BE 74 3m HORN 9120D-HF HORIZONTAL</p>	<p>Site : 03CH10-HY Condition : PEAK 74 3m HORN 9120D-HF HORIZONTAL</p>
Avg.	<p>Site : 03CH10-HY Condition : AVG BE 54 3m HORN 9120D-HF HORIZONTAL</p>	Left blank



WIFI	Band 1 5150~5250MHz Band Edge @ 3m	
ANT	802.11n HT40 CH38 5190MHz - R	
1	Horizontal	Fundamental
<p>Peak</p>		<p>Left blank</p>
<p>Avg.</p>		<p>Left blank</p>



WIFI	Band 1 5150~5250MHz Band Edge @ 3m	
ANT	802.11n HT40 CH38 5190MHz - L	
1	Vertical	Fundamental
Peak	<p>Site : 03CH10-HY Condition : PEAK BE 74 3m HORN 9120D-HF VERTICAL</p>	<p>Site : 03CH10-HY Condition : PEAK 74 3m HORN 9120D-HF VERTICAL</p>
Avg.	<p>Site : 03CH10-HY Condition : AVG BE 54 3m HORN 9120D-HF VERTICAL</p>	Left blank

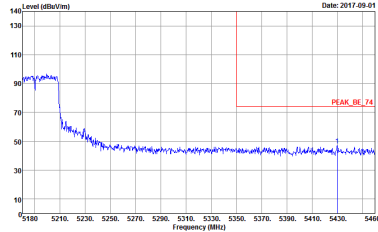
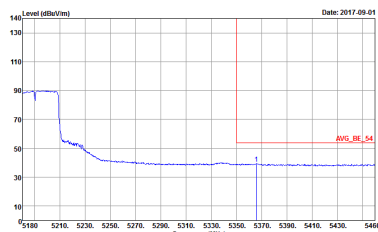

WIFI	Band 1 5150~5250MHz Band Edge @ 3m	
ANT	802.11n HT40 CH38 5190MHz - R	
1	Vertical	Fundamental
<p>Peak</p>	 <p>Site : 03CH10-HY Condition : PEAK_BE_74 3m HORN 9120D-HF VERTICAL</p>	<p>Left blank</p>
<p>Avg.</p>	 <p>Site : 03CH10-HY Condition : AVG_BE_54 3m HORN 9120D-HF VERTICAL</p>	<p>Left blank</p>

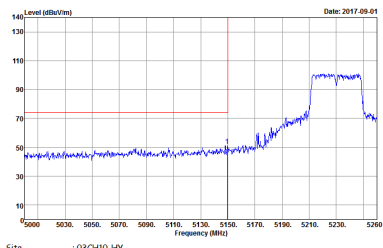
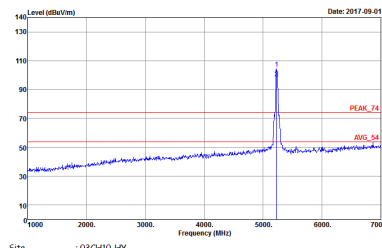
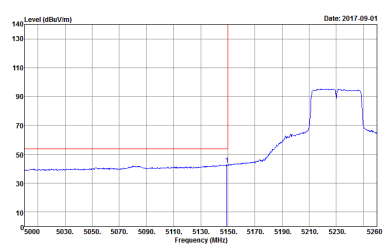

WIFI	Band 1 5150~5250MHz Band Edge @ 3m	
ANT	802.11n HT40 CH46 5230MHz - L	
1	Horizontal	Fundamental
<p>Peak</p>	 <p>Site : 03CH10-HY Condition : PEAK BE 74 3m HORN 9120D-HF HORIZONTAL</p>	 <p>Site : 03CH10-HY Condition : PEAK 74 3m HORN 9120D-HF HORIZONTAL</p>
<p>Avg.</p>	 <p>Site : 03CH10-HY Condition : AVG BE 54 3m HORN 9120D-HF HORIZONTAL</p>	<p>Left blank</p>



WIFI	Band 1 5150~5250MHz Band Edge @ 3m	
ANT	802.11n HT40 CH46 5230MHz - R	
1	Horizontal	Fundamental
<p>Peak</p>	<p>Site : 03CH10-HY Condition : PEAK_BE_74 3m HORN 9120D-HF HORIZONTAL</p>	<p>Left blank</p>
<p>Avg.</p>	<p>Site : 03CH10-HY Condition : AVG_BE_54 3m HORN 9120D-HF HORIZONTAL</p>	<p>Left blank</p>



WIFI	Band 1 5150~5250MHz Band Edge @ 3m	
ANT	802.11n HT40 CH46 5230MHz - L	
1	Vertical	Fundamental
Peak	<p>Site : 03CH10-HY Condition : PEAK BE 74 3m HORN 9120D-HF VERTICAL</p>	<p>Site : 03CH10-HY Condition : PEAK 74 3m HORN 9120D-HF VERTICAL</p>
Avg.	<p>Site : 03CH10-HY Condition : AVG BE 54 3m HORN 9120D-HF VERTICAL</p>	Left blank

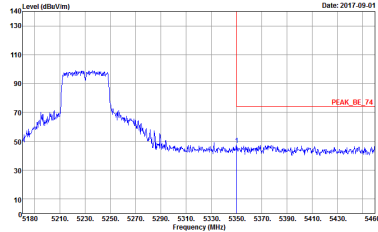
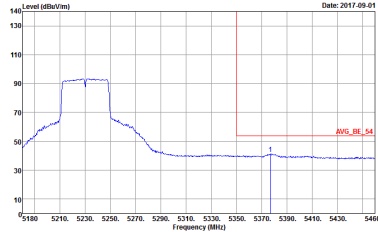

WIFI	Band 1 5150~5250MHz Band Edge @ 3m	
ANT	802.11n HT40 CH46 5230MHz - R	
1	Vertical	Fundamental
<p>Peak</p>	 <p>Site : 03CH10-HY Condition : PEAK BE 74 3m HORN 9120D-HF VERTICAL</p>	<p>Left blank</p>
<p>Avg.</p>	 <p>Site : 03CH10-HY Condition : AVG BE 54 3m HORN 9120D-HF VERTICAL</p>	<p>Left blank</p>



Band 1 - 5150~5250MHz
WIFI 802.11a (Harmonic @ 3m)

WIFI	Band 1 5150~5250MHz Harmonic @ 3m	
ANT	802.11a CH36 5180MHz	
1	Horizontal	Vertical
Peak Avg.	<p>Site : 03CH10-HY Condition : PEAK 74 3m HORN 9120D-HF HORIZONTAL</p>	<p>Site : 03CH10-HY Condition : PEAK 74 3m HORN 9120D-HF VERTICAL</p>



WIFI	Band 1 5150~5250MHz Harmonic @ 3m	
ANT	802.11a CH44 5220MHz	
1	Horizontal	Vertical
Peak Avg.	<p>Site : 03CH10-HY Condition : PEAK 74 3m HORN 9120D-HF HORIZONTAL</p>	<p>Site : 03CH10-HY Condition : PEAK 74 3m HORN 9120D-HF VERTICAL</p>



WIFI	Band 1 5150~5250MHz Harmonic @ 3m	
ANT	802.11a CH48 5240MHz	
1	Horizontal	Vertical
Peak Avg.	<p>Site : 03CH10-HY Condition : PEAK 74 3m HORN 9120D-HF HORIZONTAL</p>	<p>Site : 03CH10-HY Condition : PEAK 74 3m HORN 9120D-HF VERTICAL</p>



Band 1 5150~5250MHz
WIFI 802.11n HT20 (Harmonic @ 3m)

WIFI	Band 1 5150~5250MHz Harmonic @ 3m	
ANT	802.11n HT20 CH36 5180MHz	
1	Horizontal	Vertical
Peak Avg.	<p>Site : 03CH10-HY Condition : PEAK 74 3m HORN 9120D-HF HORIZONTAL</p>	<p>Site : 03CH10-HY Condition : PEAK 74 3m HORN 9120D-HF VERTICAL</p>



WIFI	Band 1 5150~5250MHz Harmonic @ 3m	
ANT	802.11n HT20 CH44 5220MHz	
1	Horizontal	Vertical
Peak Avg.	<p>Site : 03CH10-HY Condition : PEAK 74 3m HORN 9120D-HF HORIZONTAL</p>	<p>Site : 03CH10-HY Condition : PEAK 74 3m HORN 9120D-HF VERTICAL</p>



WIFI	Band 1 5150~5250MHz Harmonic @ 3m	
ANT	802.11n HT20 CH48 5240MHz	
1	Horizontal	Vertical
Peak Avg.	<p>Site : 03CH10-HY Condition : PEAK 74 3m HORN 9120D-HF HORIZONTAL</p>	<p>Site : 03CH10-HY Condition : PEAK 74 3m HORN 9120D-HF VERTICAL</p>



**Band 1 5150~5250MHz
WIFI 802.11n HT40 (Harmonic @ 3m)**

WIFI	Band 1 5150~5250MHz Harmonic @ 3m	
ANT	802.11n HT40 CH38 5190MHz	
1	Horizontal	Vertical
Peak Avg.	<p>Site : 03CH10-HY Condition : PEAK 74 3m HORN 9120D-HF HORIZONTAL</p>	<p>Site : 03CH10-HY Condition : PEAK 74 3m HORN 9120D-HF VERTICAL</p>



WIFI	Band 1 5150~5250MHz Harmonic @ 3m	
ANT	802.11n HT40 CH46 5230MHz	
1	Horizontal	Vertical
Peak Avg.	<p>Site : 03CH10-HY Condition : PEAK 74 3m HORN 9120D-HF VERTICAL</p>	<p>Site : 03CH10-HY Condition : PEAK 74 3m HORN 9120D-HF VERTICAL</p>



Band 2 - 5250~5350MHz
WIFI 802.11a (Band Edge @ 3m)

WIFI	Band 2 5250~5350MHz Band Edge @ 3m	
ANT	802.11a CH52 5260MHz - L	
1	Horizontal	Fundamental
Peak	<p>Site : 03CH10-HY Condition : PEAK BE 74 3m HORN 9120D-HF HORIZONTAL</p>	<p>Site : 03CH10-HY Condition : PEAK 74 3m HORN 9120D-HF HORIZONTAL</p>
Avg.	<p>Site : 03CH10-HY Condition : AVG BE 54 3m HORN 9120D-HF HORIZONTAL</p>	Left blank



WIFI	Band 2 5250~5350MHz Band Edge @ 3m	
ANT	802.11a CH52 5260MHz - R	
1	Horizontal	Fundamental
Peak	<p>Site : 03CH10-HY Condition : PEAK_BE_74 3m HORN 9120D-HF HORIZONTAL</p>	Left blank
Avg.	<p>Site : 03CH10-HY Condition : AVG_BE_54 3m HORN 9120D-HF HORIZONTAL</p>	Left blank



WIFI	Band 2 5250~5350MHz Band Edge @ 3m	
ANT	802.11a CH52 5260MHz - L	
1	Vertical	Fundamental
Peak	<p>Site : 03CH10-HY Condition : PEAK BE 74 3m HORN 9120D-HF VERTICAL</p>	<p>Site : 03CH10-HY Condition : PEAK 74 3m HORN 9120D-HF VERTICAL</p>
Avg.	<p>Site : 03CH10-HY Condition : AVG BE 54 3m HORN 9120D-HF VERTICAL</p>	Left blank



WIFI	Band 2 5250~5350MHz Band Edge @ 3m	
ANT	802.11a CH52 5260MHz - R	
1	Vertical	Fundamental
<p>Peak</p>		<p>Left blank</p>
<p>Avg.</p>		<p>Left blank</p>



WIFI	Band 2 5250~5350MHz Band Edge @ 3m	
ANT	802.11a CH60 5300MHz - L	
1	Horizontal	Fundamental
Peak	<p>Site : 03CH10-HY Condition : PEAK BE 74 3m HORN 9120D-HF HORIZONTAL</p>	<p>Site : 03CH10-HY Condition : PEAK 74 3m HORN 9120D-HF HORIZONTAL</p>
Avg.	<p>Site : 03CH10-HY Condition : AVG BE 54 3m HORN 9120D-HF HORIZONTAL</p>	Left blank



WIFI	Band 2 5250~5350MHz Band Edge @ 3m	
ANT	802.11a CH60 5300MHz - R	
1	Horizontal	Fundamental
<p>Peak</p>		<p>Left blank</p>
<p>Avg.</p>		<p>Left blank</p>



WIFI	Band 2 5250~5350MHz Band Edge @ 3m	
ANT	802.11a CH60 5300MHz - L	
1	Vertical	Fundamental
Peak	<p>Site : 03CH10-HY Condition : PEAK BE 74 3m HORN 9120D-HF VERTICAL</p>	<p>Site : 03CH10-HY Condition : PEAK 74 3m HORN 9120D-HF VERTICAL</p>
Avg.	<p>Site : 03CH10-HY Condition : AVG BE 54 3m HORN 9120D-HF VERTICAL</p>	Left blank

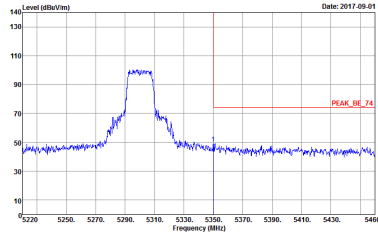
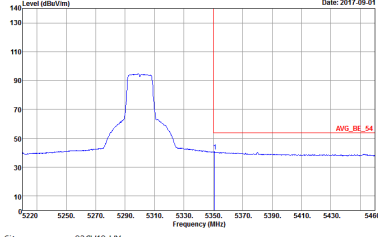

WIFI	Band 2 5250~5350MHz Band Edge @ 3m	
ANT	802.11a CH60 5300MHz - R	
1	Vertical	Fundamental
<p>Peak</p>	 <p>Site : 03CH10-HY Condition : PEAK_BE_74 3m HORN 9120D-HF VERTICAL</p>	<p>Left blank</p>
<p>Avg.</p>	 <p>Site : 03CH10-HY Condition : AVG_BE_54 3m HORN 9120D-HF VERTICAL</p>	<p>Left blank</p>



WIFI	Band 2 5250~5350MHz Band Edge @ 3m	
ANT	802.11a CH64 5320MHz	
1	Horizontal	Fundamental
<p>Peak</p>	<p>Site : 03CH10-HY Condition : PEAK_BE_74 3m HORN 9120D-HF HORIZONTAL</p>	<p>Site : 03CH10-HY Condition : PEAK_74 3m HORN 9120D-HF HORIZONTAL</p>
<p>Avg.</p>	<p>Site : 03CH10-HY Condition : AVG_BE_54 3m HORN 9120D-HF HORIZONTAL</p>	<p>Left blank</p>

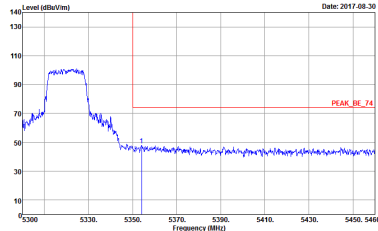
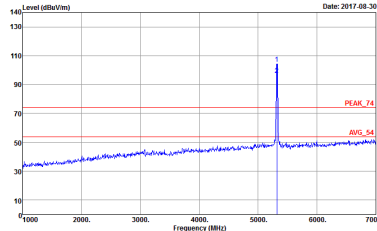
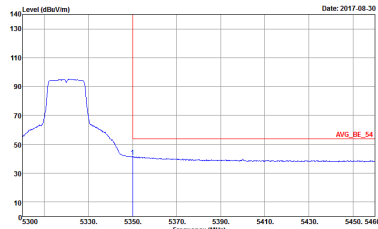

WIFI	Band 2 5250~5350MHz Band Edge @ 3m	
ANT	802.11a CH64 5320MHz	
1	Vertical	Fundamental
<p>Peak</p>	 <p>Site : 03CH10-HY Condition : PEAK_BE_74 3m HORN 9120D-HF VERTICAL</p>	 <p>Site : 03CH10-HY Condition : PEAK_74 3m HORN 9120D-HF VERTICAL</p>
<p>Avg.</p>	 <p>Site : 03CH10-HY Condition : AVG_BE_54 3m HORN 9120D-HF VERTICAL</p>	<p>Left blank</p>



Band 2 5250~5350MHz
WIFI 802.11n HT20 (Band Edge @ 3m)

Table with 2 columns (WIFI, ANT) and 2 rows (Peak, Avg.). The 'Peak' row contains 'Horizontal' and 'Fundamental' plots. The 'Avg.' row contains a plot and 'Left blank'.



WIFI	Band 2 5250~5350MHz Band Edge @ 3m	
ANT	802.11n HT20 CH52 5260MHz - R	
1	Horizontal	Fundamental
<p>Peak</p>	<p>Site : 03CH10-HY Condition : PEAK BE 74 3m HORN 9120D-HF HORIZONTAL</p>	<p>Left blank</p>
<p>Avg.</p>	<p>Site : 03CH10-HY Condition : AVG BE 54 3m HORN 9120D-HF HORIZONTAL</p>	<p>Left blank</p>



WIFI	Band 2 5250~5350MHz Band Edge @ 3m	
ANT	802.11n HT20 CH52 5260MHz - L	
1	Vertical	Fundamental
Peak	<p>Site : 03CH10-HY Condition : PEAK BE 74 3m HORN 9120D-HF VERTICAL</p>	<p>Site : 03CH10-HY Condition : PEAK 74 3m HORN 9120D-HF VERTICAL</p>
Avg.	<p>Site : 03CH10-HY Condition : AVG BE 54 3m HORN 9120D-HF VERTICAL</p>	Left blank



WIFI	Band 2 5250~5350MHz Band Edge @ 3m	
ANT	802.11n HT20 CH52 5260MHz - R	
1	Vertical	Fundamental
Peak	<p>Site : 03CH10-HY Condition : PEAK BE 74 3m HORN 9120D-HF VERTICAL</p>	Left blank
Avg.	<p>Site : 03CH10-HY Condition : AVG BE 54 3m HORN 9120D-HF VERTICAL</p>	Left blank

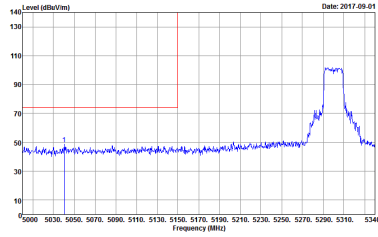
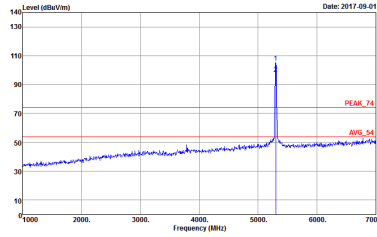
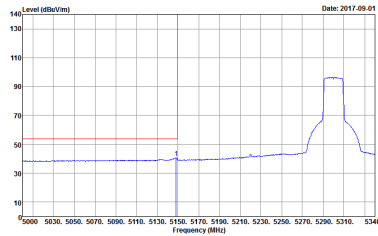

WIFI	Band 2 5250~5350MHz Band Edge @ 3m	
ANT	802.11n HT20 CH60 5300MHz - L	
1	Horizontal	Fundamental
<p>Peak</p>	 <p>Site : 03CH10-HY Condition : PEAK BE 74 3m HORN 9120D-HF HORIZONTAL</p>	 <p>Site : 03CH10-HY Condition : PEAK 74 3m HORN 9120D-HF HORIZONTAL</p>
<p>Avg.</p>	 <p>Site : 03CH10-HY Condition : AVG BE 54 3m HORN 9120D-HF HORIZONTAL</p>	<p>Left blank</p>



WIFI	Band 2 5250~5350MHz Band Edge @ 3m	
ANT	802.11n HT20 CH60 5300MHz - R	
1	Horizontal	Vertical
<p>Peak</p>	<p>Site : 03CH10-HY Condition : PEAK_BE_74 3m HORN 9120D-HF HORIZONTAL</p>	<p>Left blank</p>
<p>Avg.</p>	<p>Site : 03CH10-HY Condition : AVG_BE_54 3m HORN 9120D-HF HORIZONTAL</p>	<p>Left blank</p>



WIFI	Band 2 5250~5350MHz Band Edge @ 3m	
ANT	802.11n HT20 CH60 5300MHz - L	
1	Vertical	Fundamental
Peak	<p>Site : 03CH10-HY Condition : PEAK BE 74 3m HORN 9120D-HF VERTICAL</p>	<p>Site : 03CH10-HY Condition : PEAK 74 3m HORN 9120D-HF VERTICAL</p>
Avg.	<p>Site : 03CH10-HY Condition : AVG BE 54 3m HORN 9120D-HF VERTICAL</p>	Left blank

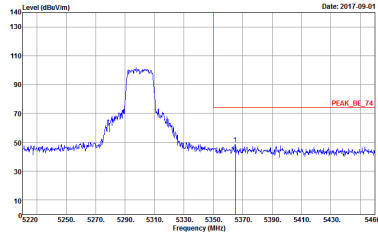
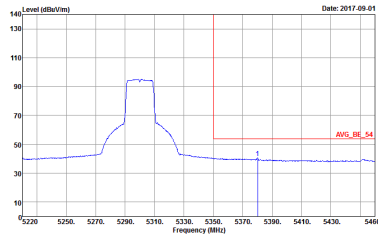

WIFI	Band 2 5250~5350MHz Band Edge @ 3m	
ANT	802.11n HT20 CH60 5300MHz - R	
1	Vertical	Fundamental
<p>Peak</p>	 <p>Site : 03CH10-HY Condition : PEAK_BE_74 3m HORN 9120D-HF VERTICAL</p>	<p>Left blank</p>
<p>Avg.</p>	 <p>Site : 03CH10-HY Condition : AVG_BE_54 3m HORN 9120D-HF VERTICAL</p>	<p>Left blank</p>

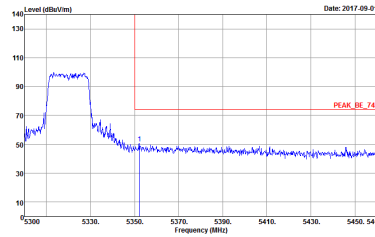
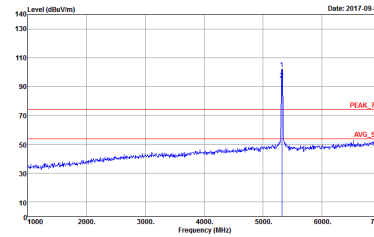
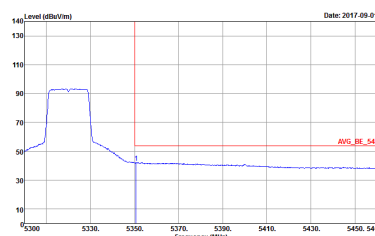

WIFI	Band 2 5250~5350MHz Band Edge @ 3m	
ANT	802.11n HT20 CH64 5320MHz	
1	Horizontal	Fundamental
<p>Peak</p>	 <p>Site : 03CH10-HY Condition : PEAK_BE_74 3m HORN 9120D-HF HORIZONTAL</p>	 <p>Site : 03CH10-HY Condition : PEAK_74 3m HORN 9120D-HF HORIZONTAL</p>
<p>Avg.</p>	 <p>Site : 03CH10-HY Condition : AVG_BE_54 3m HORN 9120D-HF HORIZONTAL</p>	<p>Left blank</p>



WIFI	Band 2 5250~5350MHz Band Edge @ 3m	
ANT	802.11n HT20 CH64 5320MHz	
1	Vertical	Fundamental
Peak	<p>Site : 03CH10-HY Condition : PEAK BE 74 3m HORN 9120D-HF VERTICAL</p>	<p>Site : 03CH10-HY Condition : PEAK 74 3m HORN 9120D-HF VERTICAL</p>
Avg.	<p>Site : 03CH10-HY Condition : AVG BE 54 3m HORN 9120D-HF VERTICAL</p>	Left blank

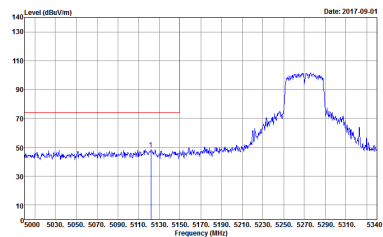
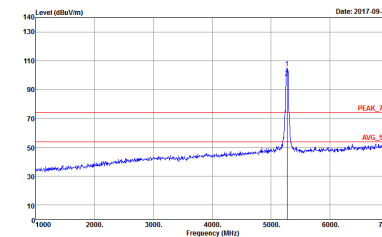
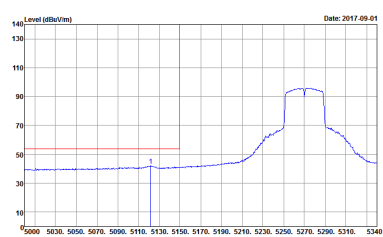

**Band 2 5250~5350MHz
WIFI 802.11n HT40 (Band Edge @ 3m)**

WIFI	Band 2 5250~5350MHz Band Edge @ 3m	
ANT	802.11n HT40 CH54 5270 MHz - L	
1	Horizontal	Fundamental
Peak	 <p>Site : 03CH10-HY Condition : PEAK BE 74 3m HORN 9120D-HF HORIZONTAL</p>	 <p>Site : 03CH10-HY Condition : PEAK 74 3m HORN 9120D-HF HORIZONTAL</p>
Avg.	 <p>Site : 03CH10-HY Condition : AVG BE 54 3m HORN 9120D-HF HORIZONTAL</p>	Left blank



WIFI	Band 2 5250~5350MHz Band Edge @ 3m	
ANT	802.11n HT40 CH54 5270 MHz - R	
1	Horizontal	Fundamental
<p>Peak</p>	<p>Site : 03CH10-HY Condition : PEAK_BE_74 3m HORN 9120D-HF HORIZONTAL</p>	<p>Left blank</p>
<p>Avg.</p>	<p>Site : 03CH10-HY Condition : AVG_BE_54 3m HORN 9120D-HF HORIZONTAL</p>	<p>Left blank</p>

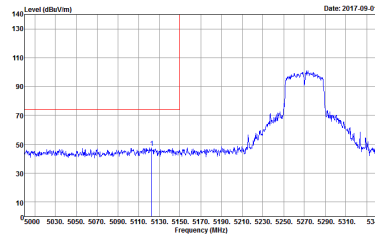
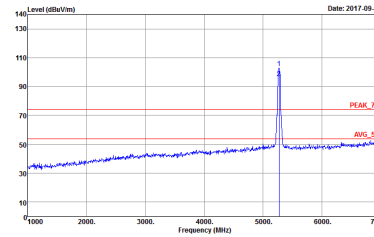
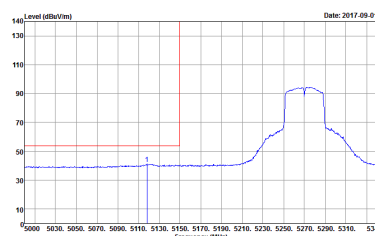

WIFI	Band 2 5250~5350MHz Band Edge @ 3m	
ANT	802.11n HT40 CH54 5270 MHz - L	
1	Vertical	Vertical
Peak	 <p>Site : 03CH10-HY Condition : PEAK BE 74 3m HORN 9120D-HF VERTICAL</p>	 <p>Site : 03CH10-HY Condition : PEAK 74 3m HORN 9120D-HF VERTICAL</p>
Avg.	 <p>Site : 03CH10-HY Condition : AVG BE 54 3m HORN 9120D-HF VERTICAL</p>	Left blank

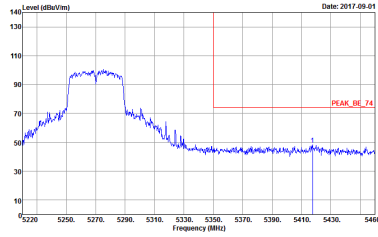
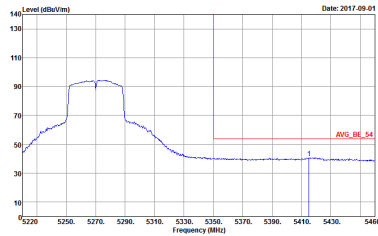

WIFI	Band 2 5250~5350MHz Band Edge @ 3m	
ANT	802.11n HT40 CH54 5270 MHz - R	
1	Vertical	Vertical
<p>Peak</p>	 <p>Site : 03CH10-HY Condition : PEAK_BE 74 3m HORN 9120D-HF VERTICAL</p>	<p>Left blank</p>
<p>Avg.</p>	 <p>Site : 03CH10-HY Condition : AVG_BE 54 3m HORN 9120D-HF VERTICAL</p>	<p>Left blank</p>

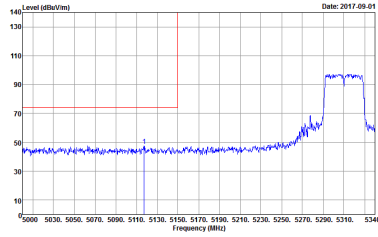
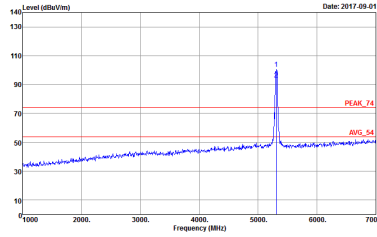
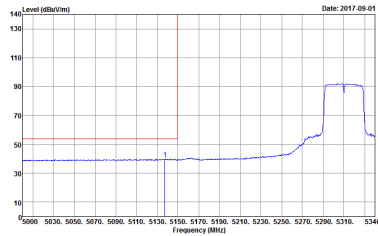

WIFI	Band 2 5250~5350MHz Band Edge @ 3m	
ANT	802.11n HT40 CH62 5310 MHz - L	
1	Horizontal	Fundamental
<p>Peak</p>	 <p>Site : 03CH10-HY Condition : PEAK BE 74 3m HORN 9120D-HF HORIZONTAL</p>	 <p>Site : 03CH10-HY Condition : PEAK 74 3m HORN 9120D-HF HORIZONTAL</p>
<p>Avg.</p>	 <p>Site : 03CH10-HY Condition : AVG BE 54 3m HORN 9120D-HF HORIZONTAL</p>	<p>Left blank</p>



WIFI	Band 2 5250~5350MHz Band Edge @ 3m	
ANT	802.11n HT40 CH62 5310 MHz - R	
1	Horizontal	Fundamental
<p>Peak</p>	<p>Site : 03CH10-HY Condition : PEAK_BE_74 3m HORN 9120D-HF HORIZONTAL</p>	<p>Left blank</p>
<p>Avg.</p>	<p>Site : 03CH10-HY Condition : AVG_BE_54 3m HORN 9120D-HF HORIZONTAL</p>	<p>Left blank</p>



WIFI	Band 2 5250~5350MHz Band Edge @ 3m	
ANT	802.11n HT40 CH62 5310 MHz - L	
1	Vertical	Fundamental
Peak	<p>Site : 03CH10-HY Condition : PEAK BE 74 3m HORN 9120D-HF VERTICAL</p>	<p>Site : 03CH10-HY Condition : PEAK 74 3m HORN 9120D-HF VERTICAL</p>
Avg.	<p>Site : 03CH10-HY Condition : AVG BE 54 3m HORN 9120D-HF VERTICAL</p>	Left blank

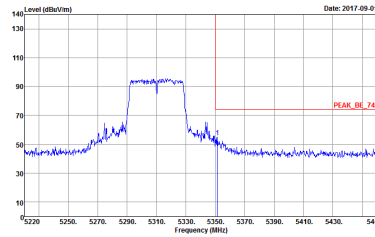
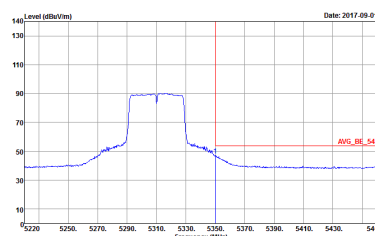

WIFI	Band 2 5250~5350MHz Band Edge @ 3m	
ANT	802.11n HT40 CH62 5310 MHz - R	
1	Vertical	Fundamental
<p>Peak</p>	 <p>Site : 03CH10-HY Condition : PEAK_BE_74 3m HORN 9120D-HF VERTICAL</p>	<p>Left blank</p>
<p>Avg.</p>	 <p>Site : 03CH10-HY Condition : AVG_BE_54 3m HORN 9120D-HF VERTICAL</p>	<p>Left blank</p>



Band 2 - 5250~5350MHz
WIFI 802.11a (Harmonic @ 3m)

WIFI	Band 2 5250~5350MHz Harmonic @ 3m	
ANT	802.11a CH52 5260MHz	
1	Horizontal	Vertical
Peak Avg.	<p>Site : 03CH10-HY Condition : PEAK 74 3m HORN 9120D-HF HORIZONTAL</p>	<p>Site : 03CH10-HY Condition : PEAK 74 3m HORN 9120D-HF VERTICAL</p>



WIFI	Band 2 5250~5350MHz Harmonic @ 3m	
ANT	802.11a CH60 5300MHz	
1	Horizontal	Vertical
Peak Avg.	<p>Site : 03CH0-HY Condition : PEAK 74 3m HORN 9120D-HF HORIZONTAL</p>	<p>Site : 03CH0-HY Condition : PEAK 74 3m HORN 9120D-HF VERTICAL</p>



WIFI	Band 2 5250~5350MHz Harmonic @ 3m	
ANT	802.11a CH64 5320MHz	
1	Horizontal	Vertical
Peak Avg.	<p>Site : 03CH0-HY Condition : PEAK 74 3m HORN 9120D-HF HORIZONTAL</p>	<p>Site : 03CH0-HY Condition : PEAK 74 3m HORN 9120D-HF VERTICAL</p>



Band 2 5250~5350MHz
WIFI 802.11n HT20 (Harmonic @ 3m)

WIFI	Band 2 5250~5350MHz Harmonic @ 3m	
ANT	802.11n HT20 CH52 5260MHz	
1	Horizontal	Vertical
Peak Avg.	<p>Site : 03CH10-HY Condition : PEAK 74 3m HORN 9120D-HF HORIZONTAL</p>	<p>Site : 03CH10-HY Condition : PEAK 74 3m HORN 9120D-HF VERTICAL</p>

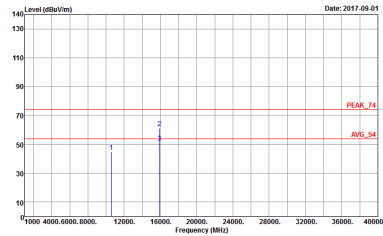
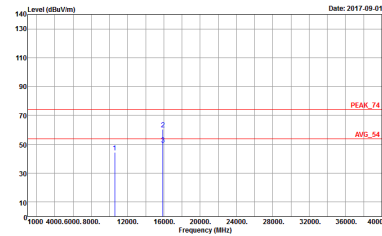

WIFI	Band 2 5250~5350MHz Harmonic @ 3m	
ANT	802.11n HT20 CH60 5300MHz	
1	Horizontal	Vertical
Peak Avg.	 <p>Site : 03CH10-111 Condition : PEAK 74 3m HORN 9120D-HF HORIZONTAL</p>	 <p>Site : 03CH10-111 Condition : PEAK 74 3m HORN 9120D-HF VERTICAL</p>



WIFI	Band 2 5250~5350MHz Harmonic @ 3m	
ANT	802.11n HT20 CH64 5320MHz	
1	Horizontal	Vertical
Peak Avg.	<p>Site : 03CH10-HY Condition : PEAK 74 3m HORN 9120D-HF HORIZONTAL</p>	<p>Site : 03CH10-HY Condition : PEAK 74 3m HORN 9120D-HF VERTICAL</p>



**Band 2 5250~5350MHz
WIFI 802.11n HT40 (Harmonic @ 3m)**

WIFI	Band 2 5250~5350MHz Harmonic @ 3m	
ANT	802.11n HT40 CH54 5270 MHz	
1	Horizontal	Vertical
Peak Avg.	<p>Site : 03CH10-HY Condition : PEAK 74 3m HORN 9120D-HF HORIZONTAL</p>	<p>Site : 03CH10-HY Condition : PEAK 74 3m HORN 9120D-HF VERTICAL</p>



WIFI	Band 2 5250~5350MHz Harmonic @ 3m	
ANT	802.11n HT40 CH62 5310 MHz	
1	Horizontal	Vertical
Peak Avg.	<p>Site : 03CH0-HY Condition : PEAK 74 3m HORN 9120D-HF HORIZONTAL</p>	<p>Site : 03CH0-HY Condition : PEAK 74 3m HORN 9120D-HF VERTICAL</p>



Band 3 - 5470~5725MHz
WIFI 802.11a (Band Edge @ 3m)

WIFI	Band 3 5470~5725MHz Band Edge @ 3m	
ANT	802.11a CH100 5500MHz	
1	Horizontal	Fundamental
Peak	<p>Site : 03CH10-HY Condition : PEAK BE 74 3m HORN 9120D-HF HORIZONTAL</p>	<p>Site : 03CH10-HY Condition : PEAK 74 3m HORN 9120D-HF HORIZONTAL</p>
Avg.	<p>Site : 03CH10-HY Condition : AVG BE 54 3m HORN 9120D-HF HORIZONTAL</p>	Left blank



WIFI	Band 3 5470~5725MHz Band Edge @ 3m	
ANT	802.11a CH100 5500MHz	
1	Vertical	Fundamental
Peak	<p>Site : 03CH10-HY Condition : PEAK BE 74 3m HORN 9120D-HF VERTICAL</p>	<p>Site : 03CH10-HY Condition : PEAK 74 3m HORN 9120D-HF VERTICAL</p>
Avg.	<p>Site : 03CH10-HY Condition : AVG BE 54 3m HORN 9120D-HF VERTICAL</p>	Left blank

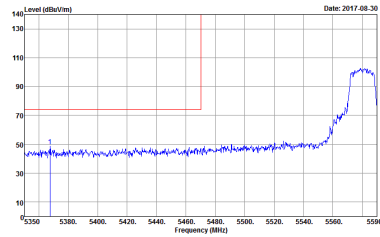
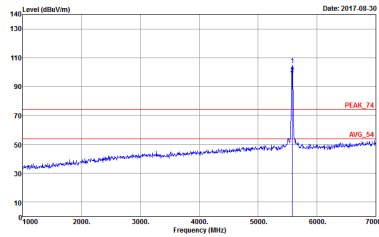
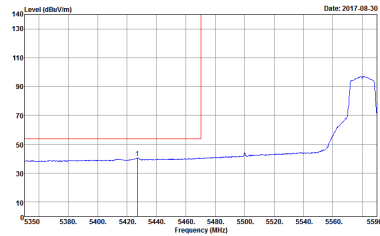

WIFI	Band 3 5470~5725MHz Band Edge @ 3m	
ANT	802.11a CH116 5580MHz - L	
1	Horizontal	Fundamental
<p>Peak</p>	 <p>Site : 03CH10-HY Condition : PEAK BE 74 3m HORN 9120D-HF HORIZONTAL</p>	 <p>Site : 03CH10-HY Condition : PEAK 74 3m HORN 9120D-HF HORIZONTAL</p>
<p>Avg.</p>	 <p>Site : 03CH10-HY Condition : AVG BE 54 3m HORN 9120D-HF HORIZONTAL</p>	<p>Left blank</p>



WIFI	Band 3 5470~5725MHz Band Edge @ 3m	
ANT	802.11a CH116 5580MHz - R	
1	Horizontal	Fundamental
Peak	<p>Site : 03CH10-HY Condition : PEAK_BE_74 3m HORN 9120D-HF HORIZONTAL</p>	Left blank
Avg.	<p>Site : 03CH10-HY Condition : AVG_BE_54 3m HORN 9120D-HF HORIZONTAL</p>	Left blank



WIFI	Band 3 5470~5725MHz Band Edge @ 3m	
ANT	802.11a CH116 5580MHz - L	
1	Vertical	Fundamental
Peak	<p>Site : 03CH10-HY Condition : PEAK BE 74 3m HORN 9120D-HF VERTICAL</p>	<p>Site : 03CH10-HY Condition : PEAK 74 3m HORN 9120D-HF VERTICAL</p>
Avg.	<p>Site : 03CH10-HY Condition : AVG BE 54 3m HORN 9120D-HF VERTICAL</p>	Left blank

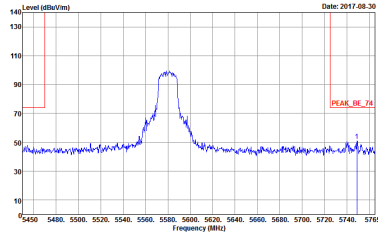
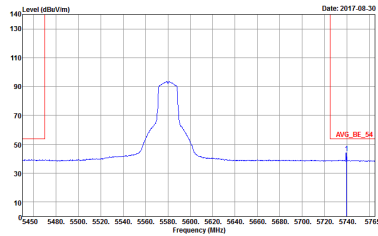

WIFI	Band 3 5470~5725MHz Band Edge @ 3m	
ANT	802.11a CH116 5580MHz - R	
1	Vertical	Fundamental
<p>Peak</p>	 <p>Site : 03CH10-HY Condition : PEAK_BE_74 3m HORN 9120D-HF VERTICAL</p>	<p>Left blank</p>
<p>Avg.</p>	 <p>Site : 03CH10-HY Condition : AVG_BE_54 3m HORN 9120D-HF VERTICAL</p>	<p>Left blank</p>



WIFI	Band 3 5470~5725MHz Band Edge @ 3m	
ANT	802.11a CH140 5700MHz	
1	Horizontal	Fundamental
Peak	<p>Site : 03CH10-HY Condition : PEAK_BE_74 3m HORN 9120D-HF HORIZONTAL</p>	<p>Site : 03CH10-HY Condition : PEAK_74 3m HORN 9120D-HF HORIZONTAL</p>
Avg.	<p>Site : 03CH10-HY Condition : AVG_BE_54 3m HORN 9120D-HF HORIZONTAL</p>	Left blank

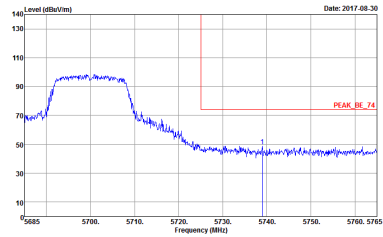
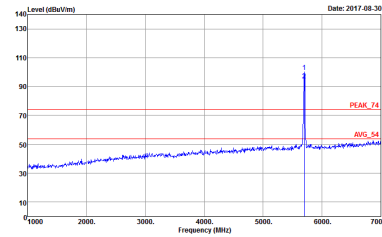
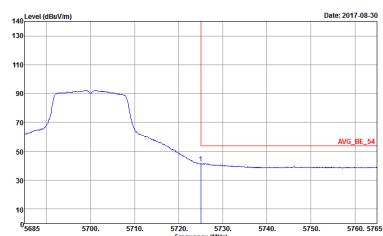

WIFI	Band 3 5470~5725MHz Band Edge @ 3m	
ANT	802.11a CH140 5700MHz	
1	Vertical	Fundamental
<p>Peak</p>	 <p>Site : 03CH10-HY Condition : PEAK_BE_74 3m HORN 9120D-HF VERTICAL</p>	 <p>Site : 03CH10-HY Condition : PEAK_74 3m HORN 9120D-HF VERTICAL</p>
<p>Avg.</p>	 <p>Site : 03CH10-HY Condition : AVG_BE_54 3m HORN 9120D-HF VERTICAL</p>	<p>Left blank</p>



**Band 3 5470~5725MHz
WIFI 802.11n HT20 (Band Edge @ 3m)**

WIFI	Band 3 5470~5725MHz Band Edge @ 3m	
ANT	802.11n HT20 CH100 5500MHz	
1	Horizontal	Fundamental
Peak	<p>Site : 03CH10-HY Condition : PEAK BE 74 3m HORN 9120D-HF HORIZONTAL</p>	<p>Site : 03CH10-HY Condition : PEAK 74 3m HORN 9120D-HF HORIZONTAL</p>
Avg.	<p>Site : 03CH10-HY Condition : AVG BE 54 3m HORN 9120D-HF HORIZONTAL</p>	<p align="center">Left blank</p>



WIFI	Band 3 5470~5725MHz Band Edge @ 3m	
ANT	802.11n HT20 CH100 5500MHz	
1	Vertical	Fundamental
Peak	<p>Site : 03CH10-HY Condition : PEAK BE 74 3m HORN 9120D-HF VERTICAL</p>	<p>Site : 03CH10-HY Condition : PEAK 74 3m HORN 9120D-HF VERTICAL</p>
Avg.	<p>Site : 03CH10-HY Condition : AVG BE 54 3m HORN 9120D-HF VERTICAL</p>	Left blank

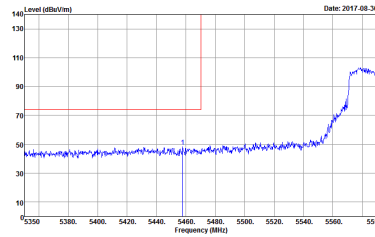
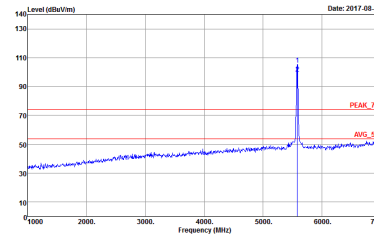
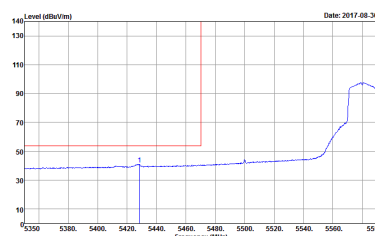

WIFI	Band 3 5470~5725MHz Band Edge @ 3m	
ANT	802.11n HT20 CH116 5580MHz - L	
1	Horizontal	Fundamental
<p>Peak</p>	 <p>Site : 03CH10-HY Condition : PEAK BE 74 3m HORN 9120D-HF HORIZONTAL</p>	 <p>Site : 03CH10-HY Condition : PEAK 74 3m HORN 9120D-HF HORIZONTAL</p>
<p>Avg.</p>	 <p>Site : 03CH10-HY Condition : AVG BE 54 3m HORN 9120D-HF HORIZONTAL</p>	<p>Left blank</p>

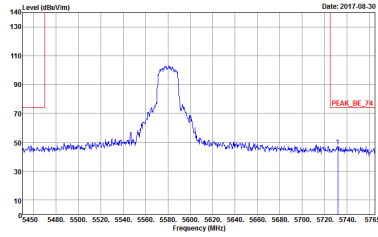
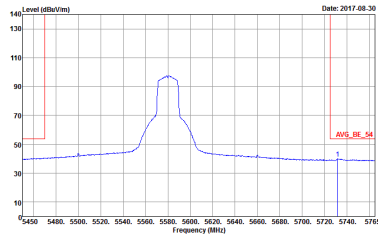

WIFI	Band 3 5470~5725MHz Band Edge @ 3m	
ANT	802.11n HT20 CH116 5580MHz - R	
1	Horizontal	Fundamental
<p>Peak</p>	 <p>Site : 03CH10-HY Condition : PEAK_BE_74 3m HORN 9120D-HF HORIZONTAL</p>	<p>Left blank</p>
<p>Avg.</p>	 <p>Site : 03CH10-HY Condition : AVG_BE_54 3m HORN 9120D-HF HORIZONTAL</p>	<p>Left blank</p>



WIFI	Band 3 5470~5725MHz Band Edge @ 3m	
ANT	802.11n HT20 CH116 5580MHz - L	
1	Vertical	Fundamental
Peak	<p>Site : 03CH10-HY Condition : PEAK BE 74 3m HORN 9120D-HF VERTICAL</p>	<p>Site : 03CH10-HY Condition : PEAK 74 3m HORN 9120D-HF VERTICAL</p>
Avg.	<p>Site : 03CH10-HY Condition : AVG BE 54 3m HORN 9120D-HF VERTICAL</p>	Left blank

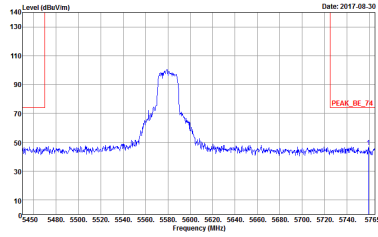
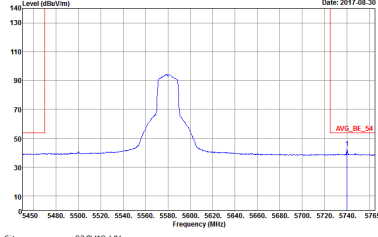

WIFI	Band 3 5470~5725MHz Band Edge @ 3m	
ANT	802.11n HT20 CH116 5580MHz - R	
1	Vertical	Fundamental
<p>Peak</p>	 <p>Site : 03CH10-HY Condition : PEAK_BE_74 3m HORN 9120D-HF VERTICAL</p>	<p>Left blank</p>
<p>Avg.</p>	 <p>Site : 03CH10-HY Condition : AVG_BE_54 3m HORN 9120D-HF VERTICAL</p>	<p>Left blank</p>



WIFI	Band 3 5470~5725MHz Band Edge @ 3m	
ANT	802.11n HT20 CH140 5700MHz	
1	Horizontal	Fundamental
<p>Peak</p>	<p>Site : 03CH10-HY Condition : PEAK BE 74 3m HORN 9120D-HF HORIZONTAL</p>	<p>Site : 03CH10-HY Condition : PEAK 74 3m HORN 9120D-HF HORIZONTAL</p>
<p>Avg.</p>	<p>Site : 03CH10-HY Condition : AVG BE 54 3m HORN 9120D-HF HORIZONTAL</p>	<p>Left blank</p>

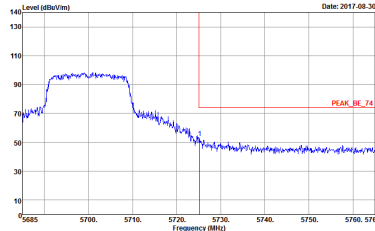
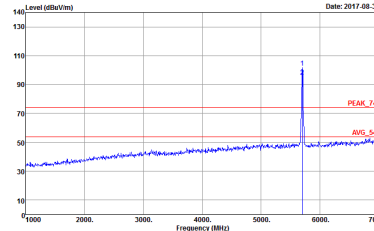
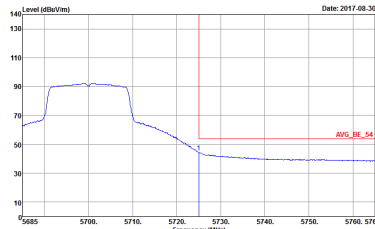

WIFI	Band 3 5470~5725MHz Band Edge @ 3m	
ANT	802.11n HT20 CH140 5700MHz	
1	Vertical	Fundamental
<p>Peak.</p>	 <p>Site : 03CH10-HY Condition : PEAK_BE_74 3m HORN 9120D-HF VERTICAL</p>	 <p>Site : 03CH10-HY Condition : PEAK_74 3m HORN 9120D-HF VERTICAL</p>
<p>Avg.</p>	 <p>Site : 03CH10-HY Condition : AVG_BE_54 3m HORN 9120D-HF VERTICAL</p>	<p>Left blank</p>

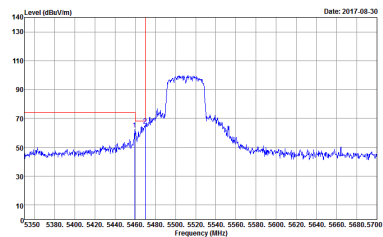
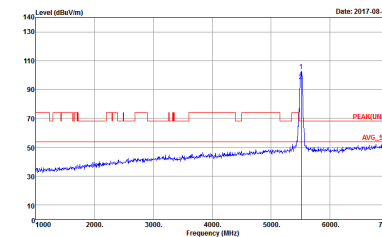
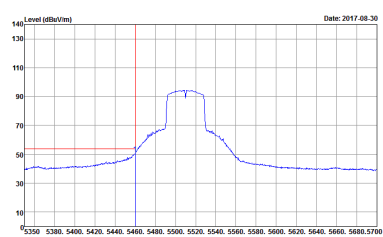

Band 3 5470~5725MHz
WIFI 802.11n HT40 (Band Edge @ 3m)

WIFI	Band 3 5470~5725MHz Band Edge @ 3m	
ANT	802.11n HT40 CH102 5510MHz - L	
1	Horizontal	Fundamental
Peak	 <p>Site : 03CH10-HY Condition : PEAK BE(LUNII) B3 3m HORN 9120D-HF HORIZONTAL</p>	 <p>Site : 03CH10-HY Condition : PEAK(LUNII) 3m HORN 9120D-HF HORIZONTAL</p>
Avg.	 <p>Site : 03CH10-HY Condition : AVG BE(LUNII) B3 3m HORN 9120D-HF HORIZONTAL</p>	Left blank

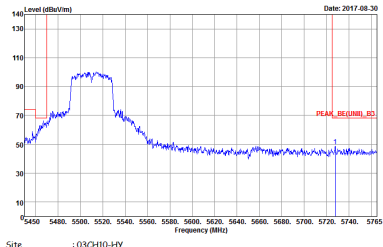

WIFI	Band 3 5470~5725MHz Band Edge @ 3m	
ANT	802.11n HT40 CH102 5510MHz - R	
1	Horizontal	Fundamental
Peak	 <p>Site : 03CH10-11V Condition : PEAK_BE(UNIT) B3 3m HORN 91200-1HF HORIZONTAL</p>	Left blank

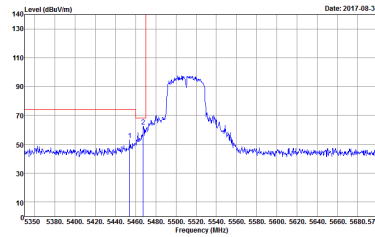
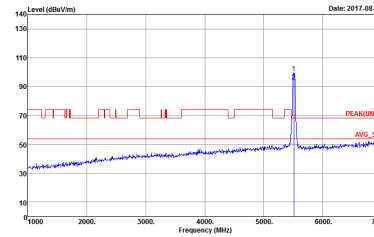
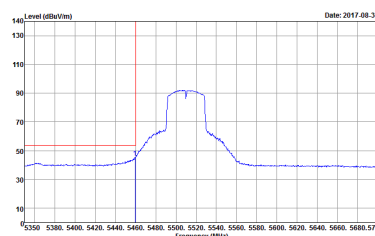

WIFI	Band 3 5470~5725MHz Band Edge @ 3m	
ANT	802.11n HT40 CH102 5510MHz - L	
1	Vertical	Fundamental
Peak	 <p>Site : 03CH10-HY Condition : PEAK BE(UNII) B3 3m HORN 9120D-HF VERTICAL</p>	 <p>Site : 03CH10-HY Condition : PEAK(UNII) 3m HORN 9120D-HF VERTICAL</p>
Avg.	 <p>Site : 03CH10-HY Condition : AVG BE(UNII) B3 3m HORN 9120D-HF VERTICAL</p>	Left blank

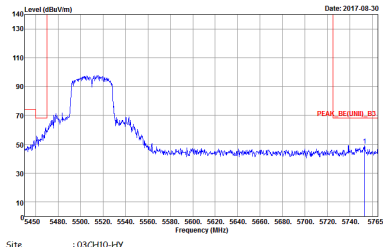

WIFI	Band 3 5470~5725MHz Band Edge @ 3m	
ANT	802.11n HT40 CH102 5510MHz - R	
1	Vertical	Fundamental
Peak	 <p>Site : 03CH10-1# Condition : PEAK_BE(UINII)_B3 3m HORN 9120D-HF VERTICAL</p>	Left blank



WIFI	Band 3 5470~5725MHz Band Edge @ 3m	
ANT	802.11n HT40 CH110 5550MHz - L	
1	Horizontal	Fundamental
Peak	<p>Site : 03CH10-HY Condition : PEAK BE 74 3m HORN 9120D-HF HORIZONTAL</p>	<p>Site : 03CH10-HY Condition : PEAK 74 3m HORN 9120D-HF HORIZONTAL</p>
Avg.	<p>Site : 03CH10-HY Condition : AVG BE 54 3m HORN 9120D-HF HORIZONTAL</p>	Left blank

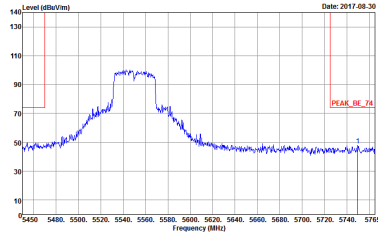
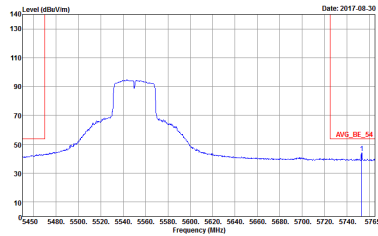

WIFI	Band 3 5470~5725MHz Band Edge @ 3m	
ANT	802.11n HT40 CH110 5550MHz - R	
1	Horizontal	Fundamental
<p>Peak</p>	 <p>Site : 03CH10-HY Condition : PEAK_BE_74 3m HORN 9120D-HF HORIZONTAL</p>	<p>Left blank</p>
<p>Avg.</p>	 <p>Site : 03CH10-HY Condition : AVG_BE_54 3m HORN 9120D-HF HORIZONTAL</p>	<p>Left blank</p>



WIFI	Band 3 5470~5725MHz Band Edge @ 3m	
ANT	802.11n HT40 CH110 5550MHz - L	
1	Vertical	Fundamental
<p>Peak</p>		
<p>Avg.</p>		<p>Left blank</p>



WIFI	Band 3 5470~5725MHz Band Edge @ 3m	
ANT	802.11n HT40 CH110 5550MHz - R	
1	Vertical	Fundamental
Peak	<p>Site : 03CH10-HY Condition : PEAK_BE_74 3m HORN 9120D-HF VERTICAL</p>	Left blank
Avg.	<p>Site : 03CH10-HY Condition : AVG_BE_54 3m HORN 9120D-HF VERTICAL</p>	Left blank



WIFI	Band 3 5470~5725MHz Band Edge @ 3m	
ANT	802.11n HT40 CH134 5670MHz - L	
1	Horizontal	Fundamental
Peak	<p>Site : 03CH10-HY Condition : PEAK BE 74 3m HORN 9120D-HF HORIZONTAL</p>	<p>Site : 03CH10-HY Condition : PEAK 74 3m HORN 9120D-HF HORIZONTAL</p>
Avg.	<p>Site : 03CH10-HY Condition : AVG BE 54 3m HORN 9120D-HF HORIZONTAL</p>	Left blank

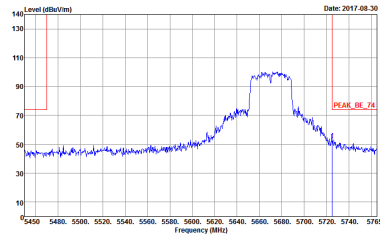
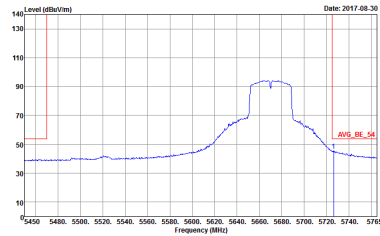

WIFI	Band 3 5470~5725MHz Band Edge @ 3m	
ANT	802.11n HT40 CH134 5670MHz - R	
1	Horizontal	Fundamental
<p>Peak</p>	 <p>Site : 03CH10-HY Condition : PEAK_BE_74 3m HORN 9120D-HF HORIZONTAL</p>	<p>Left blank</p>
<p>Avg.</p>	 <p>Site : 03CH10-HY Condition : AVG_BE_54 3m HORN 9120D-HF HORIZONTAL</p>	<p>Left blank</p>



WIFI	Band 3 5470~5725MHz Band Edge @ 3m	
ANT	802.11n HT40 CH134 5670MHz - L	
1	Vertical	Fundamental
Peak	<p>Site : 03CH10-HY Condition : PEAK BE 74 3m HORN 9120D-HF VERTICAL</p>	<p>Site : 03CH10-HY Condition : PEAK 74 3m HORN 9120D-HF VERTICAL</p>
Avg.	<p>Site : 03CH10-HY Condition : AVG BE 54 3m HORN 9120D-HF VERTICAL</p>	Left blank

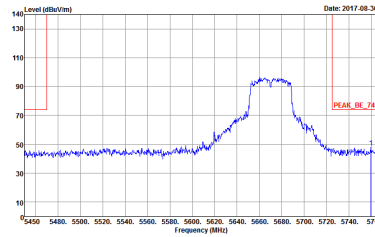
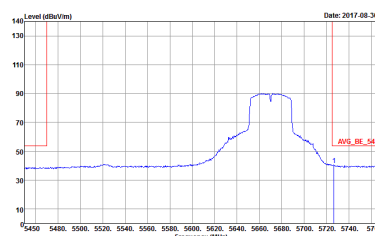

WIFI	Band 3 5470~5725MHz Band Edge @ 3m	
ANT	802.11n HT40 CH134 5670MHz - R	
1	Vertical	Fundamental
<p>Peak</p>	 <p>Site : 03CH10-HY Condition : PEAK_BE_74 3m HORN 9120D-HF VERTICAL</p>	<p>Left blank</p>
<p>Avg.</p>	 <p>Site : 03CH10-HY Condition : AVG_BE_54 3m HORN 9120D-HF VERTICAL</p>	<p>Left blank</p>



Band 3 - 5470~5725MHz
WIFI 802.11a (Harmonic @ 3m)

WIFI	Band 3 5470~5725MHz Harmonic @ 3m	
ANT	802.11a CH100 5500MHz	
1	Horizontal	Vertical
Peak Avg.	<p>Site : 03CH10-HY Condition : PEAK(UMB) 3m HORN 9120D-1HF HORIZONTAL</p>	<p>Site : 03CH10-HY Condition : PEAK(UMB) 3m HORN 9120D-1HF VERTICAL</p>

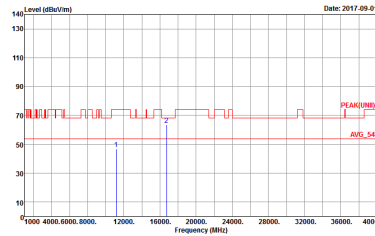
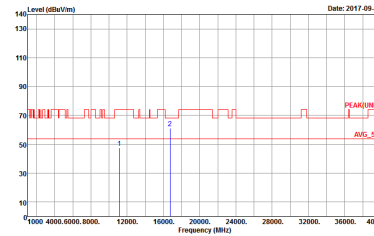

WIFI	Band 3 5470~5725MHz Harmonic @ 3m	
ANT	802.11a CH116 5580MHz	
1	Horizontal	Vertical
Peak Avg.	 <p>Site : 03CH10-HY Condition : PEAK(UIN1) 3m HORN 9120D-HF HORIZONTAL</p>	 <p>Site : 03CH10-HY Condition : PEAK(UIN1) 3m HORN 9120D-HF VERTICAL</p>



WIFI	Band 3 5470~5725MHz Harmonic @ 3m	
ANT	802.11a CH140 5700MHz	
1	Horizontal	Vertical
Peak Avg.		



Band 3 5470~5725MHz
WIFI 802.11n HT20 (Harmonic @ 3m)

WIFI	Band 3 5470~5725MHz Harmonic @ 3m	
ANT	802.11n HT20 CH100 5500MHz	
1	Horizontal	Vertical
Peak Avg.	<p>Site : 03CH10-HY Condition : PEAK(UNII) 3m HORN 9120D-HF HORIZONTAL</p>	<p>Site : 03CH10-HY Condition : PEAK(UNII) 3m HORN 9120D-HF VERTICAL</p>

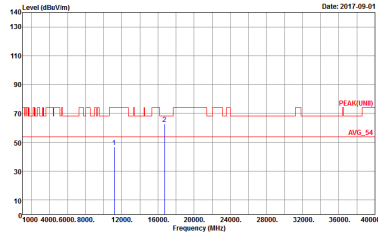
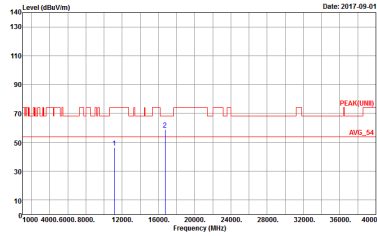

WIFI	Band 3 5470~5725MHz Harmonic @ 3m	
ANT	802.11n HT20 CH116 5580MHz	
1	Horizontal	Vertical
Peak Avg.	 <p>Site : 03CH10-HY Condition : PEAK(UNII) 3m HORN 9120D-HF HORIZONTAL</p>	 <p>Site : 03CH10-HY Condition : PEAK(UNII) 3m HORN 9120D-HF VERTICAL</p>



WIFI	Band 3 5470~5725MHz Harmonic @ 3m	
ANT	802.11n HT20 CH140 5700MHz	
1	Horizontal	Vertical
Peak Avg.	<p>Site : 03CH10-HY Condition : PEAK(UNII) 3m HORN 9120D-HF HORIZONTAL</p>	<p>Site : 03CH10-HY Condition : PEAK(UNII) 3m HORN 9120D-HF VERTICAL</p>



**Band 3 5470~5725MHz
WIFI 802.11n HT40 (Harmonic @ 3m)**

WIFI	Band 3 5470~5725MHz Harmonic @ 3m	
ANT	802.11n HT40 CH102 5510MHz	
1	Horizontal	Vertical
Peak Avg.	<p>Site : 03CH10-HY Condition : PEAK(UNII) 3m HORN 9120D-HF HORIZONTAL</p>	<p>Site : 03CH10-HY Condition : PEAK(UNII) 3m HORN 9120D-HF VERTICAL</p>



WIFI	Band 3 5470~5725MHz Harmonic @ 3m	
ANT	802.11n HT40 CH110 5550MHz	
1	Horizontal	Vertical
Peak Avg.	<p>Site : 03CH10-HY Condition : PEAK(UNII) 3m HORN 9120D-HF HORIZONTAL</p>	<p>Site : 03CH10-HY Condition : PEAK(UNII) 3m HORN 9120D-HF VERTICAL</p>

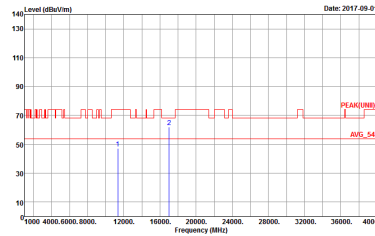
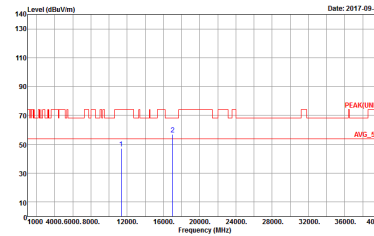

WIFI	Band 3 5470~5725MHz Harmonic @ 3m	
ANT	802.11n HT40 CH134 5670MHz	
1	Horizontal	Vertical
Peak Avg.	 <p>Site : 03CH10-HY Condition : PEAK(UNII) 3m HORN 9120D-HF HORIZONTAL</p>	 <p>Site : 03CH10-HY Condition : PEAK(UNII) 3m HORN 9120D-HF VERTICAL</p>



Band 3 - Straddle Channel
WIFI 802.11a (Fundamental @ 3m)

WIFI	Band 3 Straddle Channel Fundamental @ 3m	
ANT	802.11a CH144 5720MHz	
1	Horizontal	Vertical
Peak Avg.	<p>Site : 03CH10-HY Condition : PEAK_74 3m HORN 9120D-HF HORIZONTAL</p>	<p>Site : 03CH10-HY Condition : PEAK_74 3m HORN 9120D-HF VERTICAL</p>



**Band 3 – Straddle Channel
WIFI 802.11n HT20 (Fundamental @ 3m)**

WIFI	Band 3 Straddle Channel Fundamental @ 3m	
ANT	802.11n HT20 CH144 5720MHz	
1	Horizontal	Vertical
Peak Avg.	<p>Site : 03CH10-HY Condition : PEAK 74 3m HORN 9120D-HF HORIZONTAL</p>	<p>Site : 03CH10-HY Condition : PEAK 74 3m HORN 9120D-HF VERTICAL</p>



Band 3 – Straddle Channel
WIFI 802.11n HT40 (Fundamental @ 3m)

WIFI	Band 3 Straddle Channel Fundamental @ 3m	
ANT	802.11n HT40 CH142 5710MHz	
1	Horizontal	Vertical
Peak Avg.	<p>Site : 03CH10-HY Condition : PEAK 74 3m HORN 9120D-HF HORIZONTAL</p>	<p>Site : 03CH10-HY Condition : PEAK 74 3m HORN 9120D-HF VERTICAL</p>



Band 3 - Straddle Channel
WIFI 802.11a (Harmonic @ 3m)

WIFI	Band 3 Straddle Channel Harmonic @ 3m	
ANT	802.11a CH144 5720MHz	
1	Horizontal	Vertical
Peak Avg.	<p>Site : 03CH10-HY Condition : PEAKEUNE11 3m HORN 9120D-1HF HORIZONTAL</p>	<p>Site : 03CH10-HY Condition : PEAKEUNE11 3m HORN 9120D-1HF VERTICAL</p>



**Band 3 – Straddle Channel
WIFI 802.11n HT20 (Harmonic @ 3m)**

WIFI	Band 3 Straddle Channel Harmonic @ 3m	
ANT	802.11n HT20 CH144 5720MHz	
1	Horizontal	Vertical
Peak Avg.	<p>Site : 03CH10-HY Condition : PEAK(UNII) 3m HORN 9120D-HF HORIZONTAL</p>	<p>Site : 03CH10-HY Condition : PEAK(UNII) 3m HORN 9120D-HF VERTICAL</p>



**Band 3 – Straddle Channel
WIFI 802.11n HT40 (Harmonic @ 3m)**

WIFI	Band 3 Straddle Channel Harmonic @ 3m	
ANT	802.11n HT40 CH142 5710MHz	
1	Horizontal	Vertical
Peak Avg.	<p>Site : 03CH10-HY Condition : PEAK(UNII) 3m HORN 9120D-HF HORIZONTAL</p>	<p>Site : 03CH10-HY Condition : PEAK(UNII) 3m HORN 9120D-HF VERTICAL</p>



Emission below 1GHz
5GHz WIFI 802.11a (LF)

WIFI	5GHz WIFI	
ANT	802.11a LF	
1	Horizontal	Vertical
QP / Peak	<p>Site : 03CH10-HY Condition : QP-3m BE-LOG-6111D-LF HORIZONTAL</p>	<p>Site : 03CH10-HY Condition : QP-3m BE-LOG-6111D-LF VERTICAL</p>



Emission below 1GHz
5GHz WIFI 802.11n HT20 (LF)

WIFI	5GHz WIFI	
ANT	802.11n HT20 LF	
1	Horizontal	Vertical
QP / Peak	<p>Site : 03CH10-HY Condition : QP-3m BE-LOG-6111D-LF HORIZONTAL</p>	<p>Site : 03CH10-HY Condition : QP-3m BE-LOG-6111D-LF VERTICAL</p>



Emission below 1GHz
5GHz WIFI 802.11n HT40 (LF)

WIFI	5GHz WIFI	
ANT	802.11n HT40 LF	
1	Horizontal	Vertical
QP / Peak	<p>Site : 03CH10-HY Condition : QP-3m BE-LOG-6111D-LF HORIZONTAL</p>	<p>Site : 03CH10-HY Condition : QP-3m BE-LOG-6111D-LF VERTICAL</p>



Appendix E. Duty Cycle Plots

Band	Duty Cycle(%)	T(us)	1/T(kHz)	VBW Setting	Duty Factor(dB)
802.11a	96.53	1390	0.72	1kHz	0.15
802.11n HT20	97.04	1310	0.76	1kHz	0.13
802.11n HT40	94.74	648	1.54	3kHz	0.23

802.11a

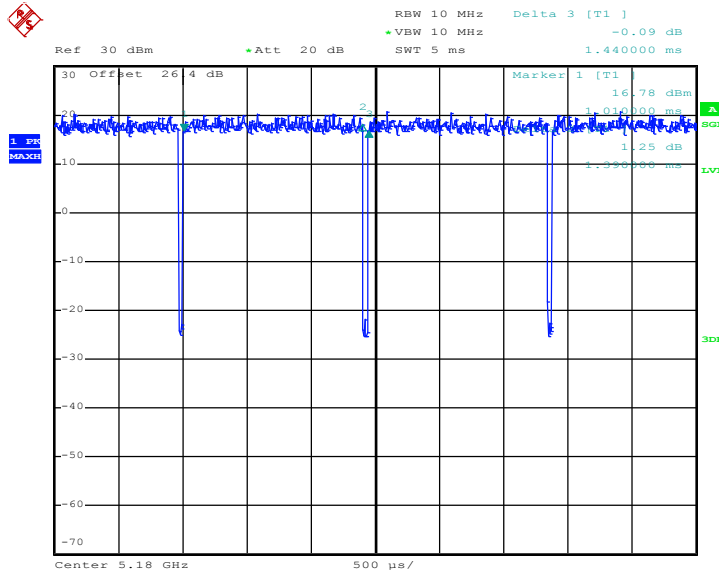

Date: 24.AUG.2017 10:55:28



802.11n HT20

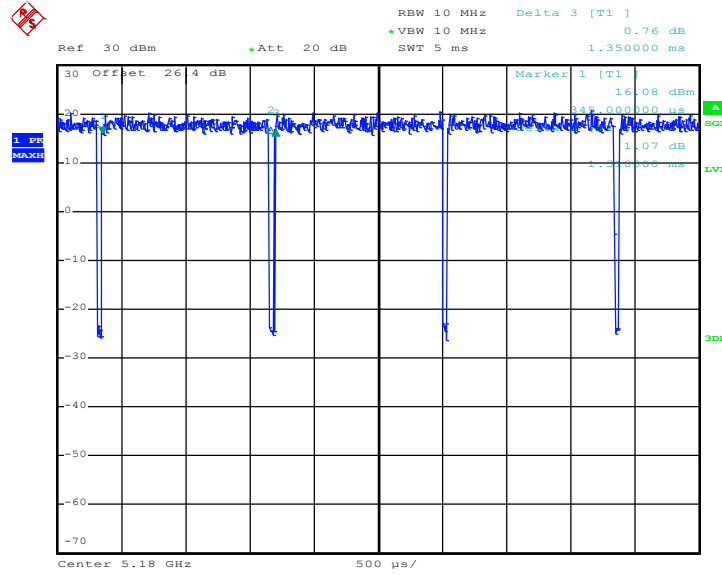

Date: 24.AUG.2017 10:56:16

802.11n HT40

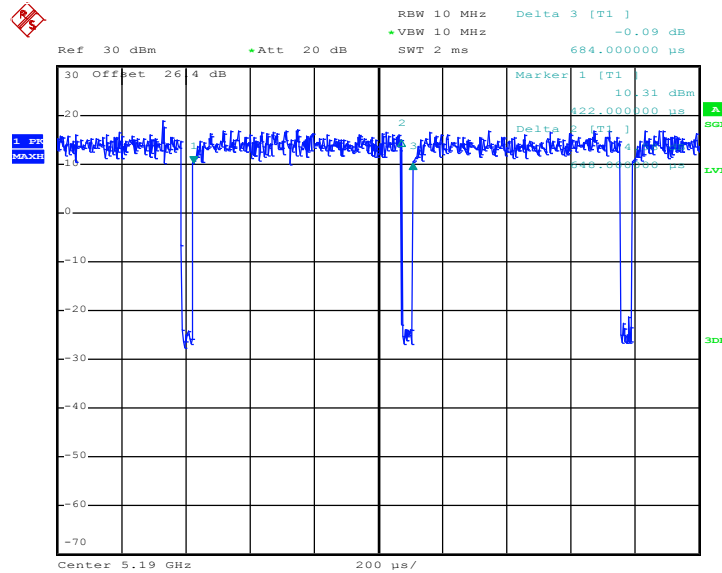

Date: 24.AUG.2017 10:57:19