

# Hearing Aid Compatibility (HAC) RF Emissions Test Report

APPLICANT : Sony Mobile Communications Inc.  
BRAND NAME : Sony  
FCC ID : PY7-22032B  
STANDARD : FCC 47 CFR §20.19  
ANSI C63.19-2011

We, SPORTON INTERNATIONAL INC., would like to declare that the tested sample has been evaluated in accordance with the procedures and had been in compliance with the applicable technical standards.

The test results in this report apply exclusively to the tested model / sample. Without written approval of SPORTON INTERNATIONAL INC., the test report shall not be reproduced except in full.

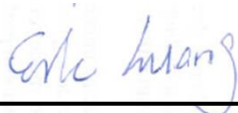

Reviewed by: Eric Huang / Manager



Approved by: Jones Tsai / Manager



**SPORTON INTERNATIONAL INC.**

No.52, Hwa Ya 1st Rd., Hwa Ya Technology Park, Kwei-Shan District, Taoyuan City, Taiwan (R.O.C.)



Table of Contents

1. Attestation of Test Results ..... 4
2. Administration Data ..... 4
3. Equipment Under Test Information ..... 5
3.1 General Information ..... 5
3.2 Air Interface and Operating Mode ..... 6
3.3 Applied Standards ..... 6
4. HAC RF Emission ..... 7
5. Measurement System Specification ..... 8
5.1 Test Arch Phantom ..... 8
5.2 E-Field Probe System ..... 9
E-Field Probe Specification ..... 9
Probe Tip Description: ..... 9
5.3 System Hardware ..... 9
5.4 Data Storage and Evaluation ..... 10
5.5 Test Equipment List ..... 11
6. Measurement System Validation ..... 12
6.1 Purpose of System Performance Check ..... 12
6.2 System Setup ..... 12
6.3 Verification Results ..... 13
7. RF Emissions Test Procedure ..... 14
8. Modulation Interference Factor ..... 17
9. Low-power Exemption ..... 18
10. Conducted RF Output Power (Unit: dBm) ..... 19
11. HAC RF Emission Test Results ..... 19
12. Uncertainty Assessment ..... 20
13. References ..... 22

- Appendix A. Plots of System Performance Check
Appendix B. Plots of RF Emission Measurement
Appendix C. DASYS Calibration Certificate
Appendix D. Test Setup Photos



### Revision History

REPORT NO.	VERSION	DESCRIPTION	ISSUED DATE
HA782204A	Rev. 01	Initial issue of report	Oct. 31, 2017
HA782204A	Rev. 02	Updated section 6.3	Nov. 20, 2017



### 1. Attestation of Test Results

Applicant Name	Sony Mobile Communications Inc.
Equipment Name	GSM/WCDMA/LTE Phone+Bluetooth, DTS/UNII a/b/g/n and NFC
Brand Name	Sony
FCC ID	PY7-22032B
S / N	WUJ01Q2CQE
HW Version	A
SW Version	1.8
EUT Stage	Production Unit
Exposure category	General Population/Uncontrolled Exposure
HAC Rating	M3
Date Tested	2017/09/20
Test Result	Pass

This device is compliance with HAC limits specified in guidelines FCC 47 CFR §20.19 and ANSI Standard ANSI C63.19.

### 2. Administration Data

Sporton Lab is accredited to ISO 17025 by Taiwan Accreditation Foundation (TAF code: 1190) and the FCC designation No. TW1190 under the FCC 2.948(e) by Mutual Recognition Agreement (MRA) in FCC test.

Testing Laboratory	
Test Site	SPORTON INTERNATIONAL INC.
Test Site Location	No.52, Hwa Ya 1st Rd., Hwa Ya Technology Park, Kwei-Shan District, Taoyuan City, Taiwan (R.O.C.) TEL: +886-3-327-3456 FAX: +886-3-328-4978
Test Site No.	Sporton Site No. : <b>SAR04-HY</b>
Applicant	
Company Name	Sony Mobile Communications Inc.
Address	4-12-3 Higashi-Shinagawa, Shinagawa-ku, Tokyo, 140-0002, Japan
Manufacturer	
Company Name	Sony Mobile Communications Inc.
Address	4-12-3 Higashi-Shinagawa, Shinagawa-ku, Tokyo, 140-0002, Japan



### 3. Equipment Under Test Information

#### 3.1 General Information

Wireless Technologies	Frequency	Operating Mode	
GSM	850 1900	<ul style="list-style-type: none"> <li>· GSM Voice</li> <li>· GPRS (GMSK)</li> <li>· EDGE (8PSK)</li> </ul>	Multi-Slot Class: Class 12
	Does device support dual transfer mode? (No)		
W-CDMA (UMTS)	Band 2 Band 4 Band 5	<ul style="list-style-type: none"> <li>· AMR / RMC 12.2Kbps</li> <li>· HSDPA</li> <li>· HSUPA</li> <li>· DC-HSDPA</li> </ul>	
LTE	Band 2 Band 4 Band 5 Band 7 Band 12 Band 13 Band 17	<ul style="list-style-type: none"> <li>· QPSK</li> <li>· 16QAM</li> </ul>	
WiFi	2.4GHz: 2412 MHz ~ 2462 MHz	<ul style="list-style-type: none"> <li>· 11b</li> <li>· 11g</li> <li>· 11n (HT20)</li> </ul>	
	5GHz: 5.2GHz: 5180 MHz ~ 5240 MHz 5.3GHz: 5260 MHz ~ 5320 MHz 5.5GHz: 5500 MHz ~ 5720 MHz 5.8GHz: 5745 MHz ~ 5825 MHz	<ul style="list-style-type: none"> <li>· 11a</li> <li>· 11n (HT20)</li> <li>· 11n (HT40)</li> </ul>	
Bluetooth	2.4GHz	<ul style="list-style-type: none"> <li>· BR / EDR / LE</li> </ul>	
NFC	13.56MHz	<ul style="list-style-type: none"> <li>· ASK</li> </ul>	



**3.2 Air Interface and Operating Mode**

Air Interface	Band MHz	Type	C63.19 Tested	Simultaneous Transmitter	OTT	Power Reduction
GSM	850	VO	Yes	WLAN, BT	NA	No
	1900			WLAN, BT	NA	No
	GPRS/EDGE	DT	No	WLAN, BT	Yes	No
WCDMA	850	VO	Yes <sup>(1)</sup>	WLAN, BT	NA	No
	1750			WLAN, BT	NA	No
	1900			WLAN, BT	NA	No
	HSPA	DT	No	WLAN, BT	Yes	No
LTE	Band 2	DT	No	WLAN, BT	Yes	No
	Band 4			WLAN, BT		No
	Band 5			WLAN, BT		No
	Band 7			WLAN, BT		No
	Band 12			WLAN, BT		No
	Band 13			WLAN, BT		No
	Band 17			WLAN, BT		No
WLAN	2450	DT	No	GSM,WCDMA,LTE	Yes	No
	5200			GSM,WCDMA,LTE		No
	5300			GSM,WCDMA,LTE		No
	5500			GSM ,WCDMA,LTE		No
	5800			GSM ,WCDMA,LTE		No
BT	2450	DT	No	GSM ,WCDMA,LTE	NA	No

VO=CMRS Voice Service  
DT=Digital Transport

Remark:

- WCDMA is exempted from testing by low power exemption that its average antenna input power plus its MIF is  $\leq 17$  dBm, and is rated as M4

**3.3 Applied Standards**

- FCC CFR47 Part 20.19
- ANSI C63.19 2011-version
- FCC KDB 285076 D01 HAC Guidance v04r01
- FCC KDB 285076 D02 T Coil testing for CMRS IP v02



#### 4. HAC RF Emission

FCC wireless hearing aid compatibility rules ensure that consumers with hearing loss are able to access wireless communications services through a wide selection of handsets without experiencing disabling radio frequency (RF) interference or other technical obstacles.

To define and measure the hearing aid compatibility of handsets, in CFR47 part 20.19 ANSI C63.19 is referenced. A handset is considered hearing aid-compatible for acoustic coupling if it meets a rating of at least M3 under ANSI C63.19, and A handset is considered hearing aid compatible for inductive coupling if it meets a rating of at least T3.

According to ANSI C63.19 2011 version, for acoustic coupling, the RF electric field emissions of wireless communication devices should be measured and rated according to the emission level as below.

Emission Categories	E-field emissions	
	<960Mhz	>960Mhz
M1	50 to 55 dB (V/m)	40 to 45 dB (V/m)
M2	45 to 50 dB (V/m)	35 to 40 dB (V/m)
M3	40 to 45 dB (V/m)	30 to 35 dB (V/m)
M4	<40 dB (V/m)	<30 dB (V/m)

Table 4.1 Telephone near-field categories in linear units

### 5. Measurement System Specification

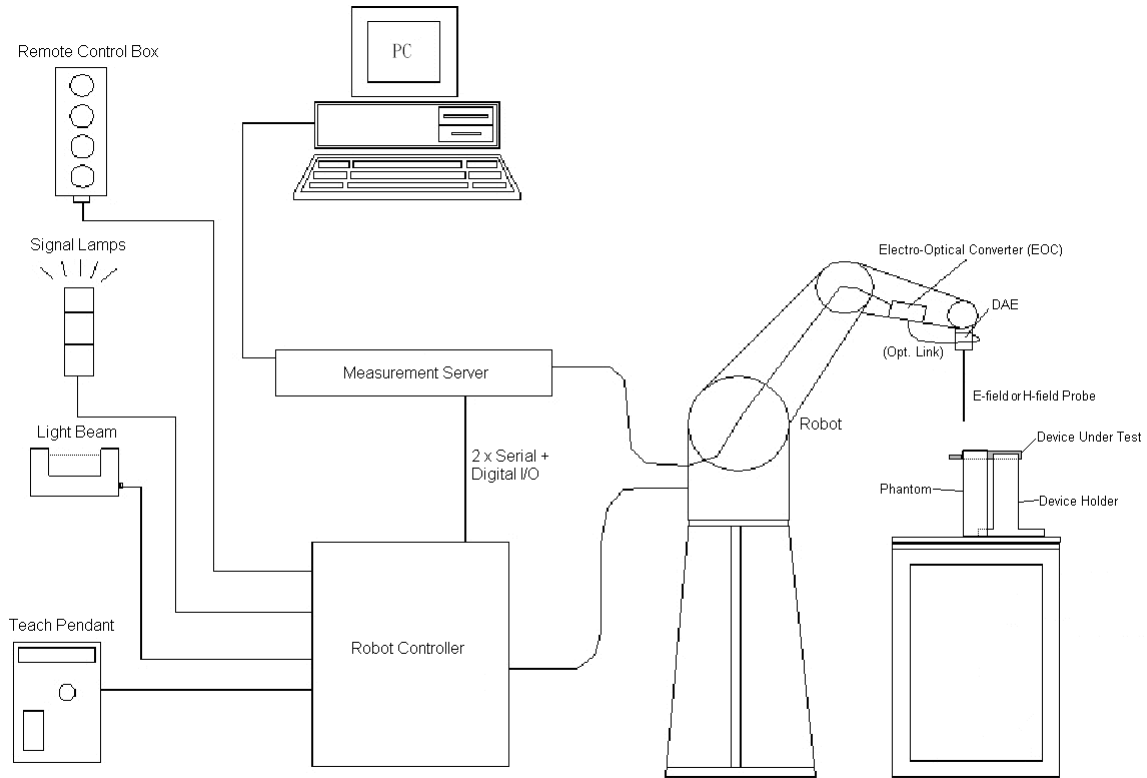

Fig 5.1 SPEAG DASY5 System Configurations

#### 5.1 Test Arch Phantom

<p><b>Construction :</b></p>	<p>Enables easy and well defined positioning of the phone and validation dipoles as well as simple teaching of the robot.</p>	
<p><b>Dimensions :</b></p>	<p>370x 370 x 370 mm</p>	

Fig 5.8 Photo of Arch Phantom



**5.2 E-Field Probe System**

**E-Field Probe Specification  
<ER3DV6>**

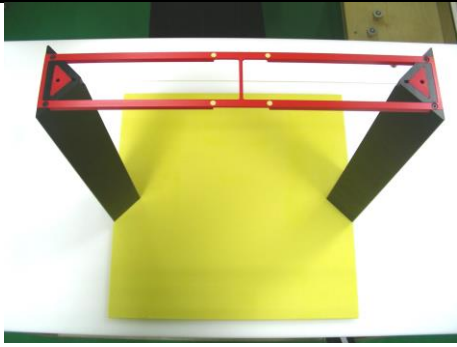
<b>Construction</b>	One dipole parallel, two dipoles normal to probe axis Built-in shielding against static charges
<b>Calibration</b>	In air from 100 MHz to 3.0 GHz (absolute accuracy $\pm 6.0\%$ , $k=2$ )
<b>Frequency</b>	100 MHz to 6 GHz; Linearity: $\pm 2.0$ dB (100 MHz to 3 GHz)
<b>Directivity</b>	$\pm 0.2$ dB in air (rotation around probe axis) $\pm 0.4$ dB in air (rotation normal to probe axis)
<b>Dynamic Range</b>	2 V/m to 1000 V/m (M3 or better device readings fall well below diode compression point)
<b>Linearity</b>	$\pm 0.2$ dB
<b>Dimensions</b>	Overall length: 330 mm (Tip: 16 mm) Tip diameter: 8 mm (Body: 12 mm) Distance from probe tip to dipole centers: 2.5 mm



**Fig 5.2 Photo of E-field Probe**

**Probe Tip Description:**

HAC field measurements take place in the close near field with high gradients. Increasing the measuring distance from the source will generally decrease the measured field values (in case of the validation dipole approx. 10% per mm).

**5.3 System Hardware**

<b>DAE</b>
The data acquisition electronics (DAE) consists of a highly sensitive electrometer-grade preamplifier with auto-zeroing, a channel and gain-switching multiplexer, a fast 16 bit AD-converter and a command decoder and control logic unit.
<b>Robot</b>
The SPEAG DASY system uses the high precision robots (DASY5: TX90XL) type from Stäubli SA (France). For the 6-axis controller system, the robot controller version (DASY5: CS8c) from Stäubli is used.

**5.4 Data Storage and Evaluation**

The DASY software stores the assessed data from the data acquisition electronics as raw data (in microvolt readings from the probe sensors), together with all the necessary software parameters for the data evaluation (probe calibration data, and device frequency and modulation data) in measurement files.

<b>Probe parameters :</b>	- Sensitivity	Norm <sub>i</sub> , a <sub>i0</sub> , a <sub>i1</sub> , a <sub>i2</sub>
	- Conversion factor	ConvF <sub>i</sub>
	- Diode compression point	dcp <sub>i</sub>
<b>Device parameters :</b>	- Frequency	f
	- Crest factor	cf
<b>Media parameters :</b>	- Conductivity	σ
	- Density	ρ

The formula for each channel can be given as :

$$V_i = U_i + U_i^2 \cdot \frac{cf}{dcp_i}$$

- with V<sub>i</sub> = compensated signal of channel i, (i = x, y, z)
- U<sub>i</sub> = input signal of channel i, (i = x, y, z)
- cf = crest factor of exciting field (DASY parameter)
- dcp<sub>i</sub> = diode compression point (DASY parameter)

From the compensated input signals, the primary field data for each channel can be evaluated :

$$\text{E-field Probes : } E_i = \sqrt{\frac{V_i}{\text{Norm}_i \cdot \text{ConvF}}}$$

- with V<sub>i</sub> = compensated signal of channel i, (i = x, y, z)
- Norm<sub>i</sub> = sensor sensitivity of channel i, (i = x, y, z), μV/(V/m)<sup>2</sup> for E-field Probes
- ConvF = sensitivity enhancement in solution
- f = carrier frequency [GHz]
- E<sub>i</sub> = electric field strength of channel i in V/m

The RSS value of the field components gives the total field strength (Hermitian magnitude) :

$$E_{tot} = \sqrt{E_x^2 + E_y^2 + E_z^2}$$

The primary field data are used to calculate the derived field units.



5.5 Test Equipment List

Manufacturer	Name of Equipment	Type/Model	Serial Number	Calibration	
				Last Cal.	Due Date
SPEAG	835MHz Calibration Dipole	CD835V3	1045	Sep. 27, 2016	Sep. 26, 2017
SPEAG	1880MHz Calibration Dipole	CD1880V3	1038	Sep. 27, 2016	Sep. 26, 2017
SPEAG	Data Acquisition Electronics	DAE4	1399	Nov. 17, 2016	Nov. 16, 2017
SPEAG	Isotropic E-Field Probe	ER3DV6	2358	Jan. 19, 2017	Jan. 18, 2018
WonDer	Thermometer	WD-5016	TM642-1	Mar. 17, 2017	Mar. 16, 2018
SPEAG	Test Arch Phantom	N/A	N/A	NCR	NCR
SPEAG	Phone Positioner	N/A	N/A	NCR	NCR
Anritsu	Power Meter	ML2495A	1419002	May. 15, 2017	May. 14, 2018
Anritsu	Power Sensor	MA2411B	1339124	May. 15, 2017	May. 14, 2018
Anritsu	Signal Generator	MG3710A	6201502524	Dec. 09, 2016	Dec. 08, 2017
R&S	Base Station	CMW500	116160	Mar. 08, 2017	Mar. 07, 2018
R&S	Base Station	CMU200	116457	May. 23, 2017	May. 22, 2018
ATM	Dual Directional Coupler	C122H-10	P610410z-02	NCR	NCR
Woken	Attenuator	WK0602-XX	N/A	NCR	NCR
Mini-Circuits	Power Amplifier	ZVE-8G+	D120604	Mar. 09, 2017	Mar. 08, 2018
Mini-Circuits	Power Amplifier	ZHL-42W+	QA1344002	Mar. 09, 2017	Mar. 08, 2018

Table 5.1 Test Equipment List

Note:

- 1. NCR: "No-Calibration Required"

## 6. Measurement System Validation

Each DASY system is equipped with one or more system validation kits. These units, together with the predefined measurement procedures within the DASY software, enable the user to conduct the system performance check and system validation. System validation kit includes a dipole, tripod holder to fix it underneath the test Arch and a corresponding distance holder.

### 6.1 Purpose of System Performance Check

The system performance check verifies that the system operates within its specifications. System and operator errors can be detected and corrected. It is recommended that the system performance check be performed prior to any usage of the system in order to guarantee reproducible results. The system performance check uses normal HAC measurements in a simplified setup with a well characterized source. This setup was selected to give a high sensitivity to all parameters that might fail or vary over time. The system check does not intend to replace the calibration of the components, but indicates situations where the system uncertainty is exceeded due to drift or failure.

### 6.2 System Setup

1. In the simplified setup for system evaluation, the EUT is replaced by a calibrated dipole and the power source is replaced by a continuous wave which comes from a signal generator.
2. The center point of the probe element(s) is 15mm from the closest surface of the dipole elements.
3. The calibrated dipole must be placed beneath the arch phantom. The equipment setup is shown below:

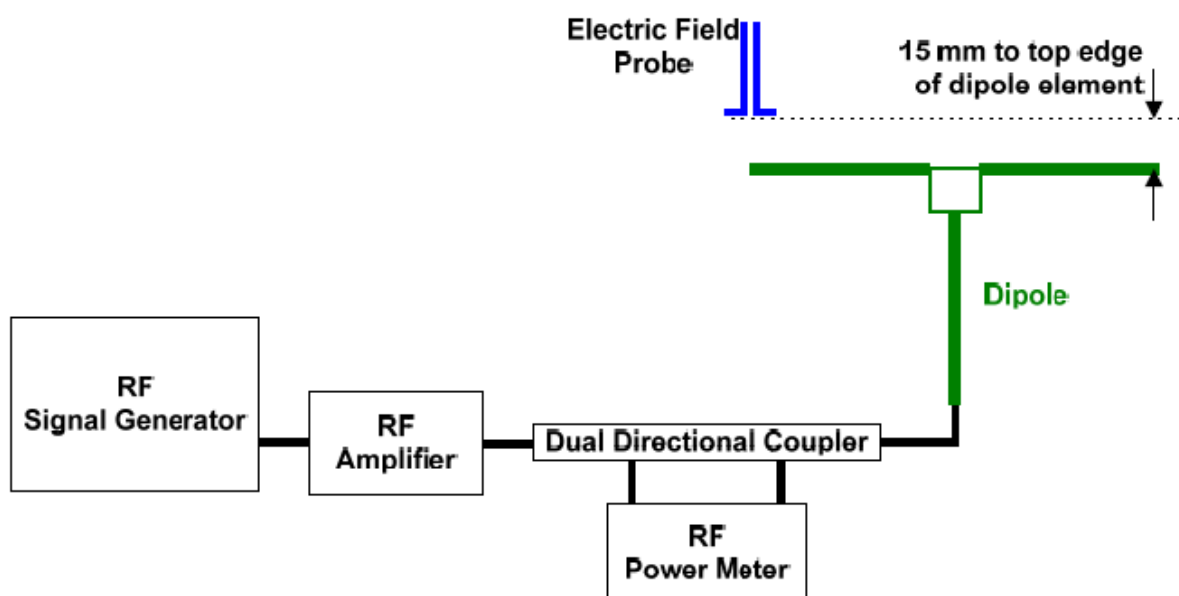
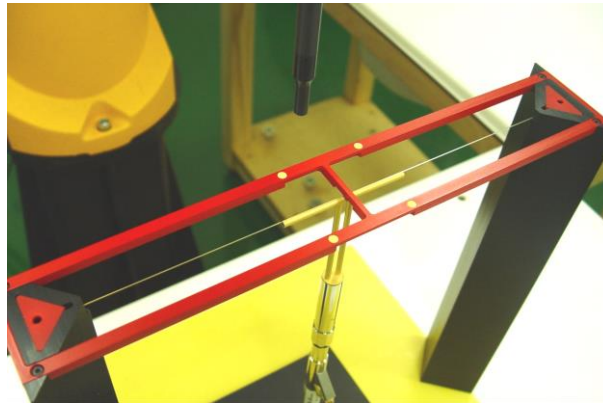

Fig. 6.1 System Validation Setup

The output power on dipole port must be calibrated to 20dBm (100mW) before dipole is connected.



**Fig 7.2 Dipole Setup**

**6.3 Verification Results**

Comparing to the original E-field value provided by SPEAG, the verification data should be within its specification of 25 %. Table 6.1 shows the target value and measured value. The table below indicates the system performance check can meet the variation criterion and the plots can be referred to appendix A of this report.

Frequency (MHz)	Input Power (dBm)	Target Value (V/m)	E-Field above high end (V/m)	E-Field above low end (V/m)	Average Value (V/m)	Deviation (%)	Date
835	20	106.1	113.8	108.8	111.3	4.90	Sep 20, 2017
1880	20	89.8	87.94	88.77	88.355	-1.61	Sep 20, 2017

**Table 6.1 Test Results of System Validation**

**Note: Deviation = ((Average E-field Value) - (Target value)) / (Target value) \* 100%**



## 7. RF Emissions Test Procedure

Referenced from ANSI C63.19 -2011 section 5.5.1

- a) Confirm the proper operation of the field probe, probe measurement system, and other instrumentation and the positioning system.
- b) Position the WD in its intended test position.
- c) Set the WD to transmit a fixed and repeatable combination of signal power and modulation characteristic that is representative of the worst case (highest interference potential) encountered in normal use. Transiently occurring start-up, changeover, or termination conditions, or other operations likely to occur less than 1% of the time during normal operation, may be excluded from consideration.
- d) The center sub-grid shall be centered on the T-Coil mode perpendicular measurement point or the acoustic output, as appropriate. Locate the field probe at the initial test position in the 50 mm by 50 mm grid, which is contained in the measurement plane, refer to illustrated in Figure 8.2. If the field alignment method is used, align the probe for maximum field reception.
- e) Record the reading at the output of the measurement system.
- f) Scan the entire 50 mm by 50 mm region in equality spaced increments and record the reading at each measurement point, The distance between measurement points shall be sufficient to assure the identification of the maximum reading.
- g) Identify the five contiguous sub-grids around the center sub-grid whose maximum reading is the lowest of all available choices. This eliminates the three sub-grids with the maximum readings. Thus, the six areas to be used to determine the WD's highest emissions are identified.
- h) Identify the maximum reading within the non-excluded sub-grids identified in step g).
- i) *Indirect measurement method*  
The RF audio interference level in dB (V/m) is obtained by adding the MIF (in dB) to the maximum steady-state rms field-strength reading, in dB (V/m)
- j) Compare this RF audio interference level with the categories in ANSI C63.19-2011 clause 8 and record the resulting WD category rating.
- k) For the T-Coil mode M-rating assessment, determine whether the chosen perpendicular measurement point is contained in an included sub-grid of the first scan. If so, then a second scan is not necessary. The first scan and resultant category rating may be used for the T-Coil mode M rating.

Otherwise, repeat step a) through step i), with the grid shifted so that it is centered on the perpendicular measurement point. Record the WD category rating.

### Test Instructions

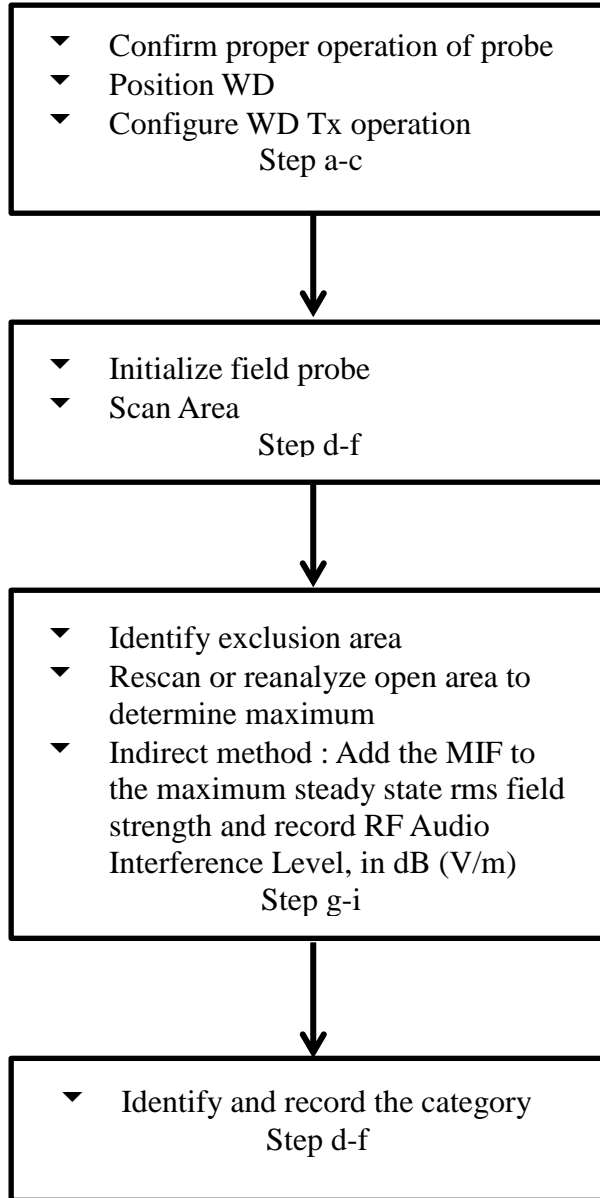

Fig 8.1 Flow Chart of HAC RF Emission



Fig 8.2 EUT reference and plane for HAC RF emission measurements

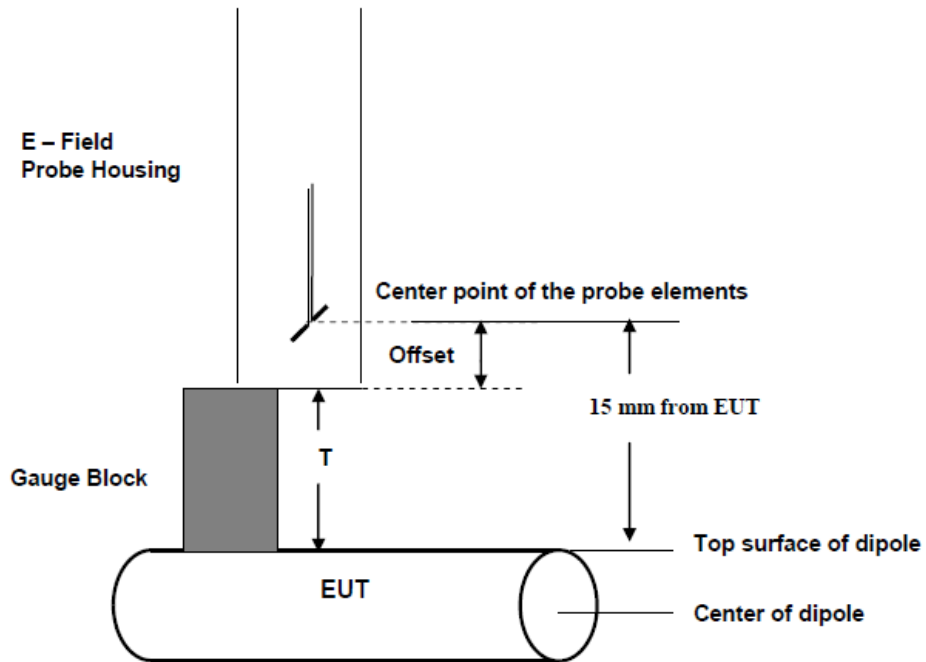

Fig. 8.3 Gauge block with E-field probe





## **8. Modulation Interference Factor**

The HAC Standard ANSI C63.19-2011 defines a new scaling using the Modulation Interference Factor (MIF).

For any specific fixed and repeatable modulated signal, a modulation interference factor (MIF, expressed in dB) may be developed that relates its interference potential to its steady-state rms signal level or average power level. This factor is a function only of the audio-frequency amplitude modulation characteristics of the signal and is the same for field-strength and conducted power measurements. It is important to emphasize that the MIF is valid only for a specific repeatable audio-frequency amplitude modulation characteristic. Any change in modulation characteristic requires determination and application of a new MIF

The Modulation Interference factor (MIF, in dB) is added to the measured average E-field (in dBV/m) and converts it to the RF Audio Interference level (in dBV/m). This level considers the audible amplitude modulation components in the RF E-field. CW fields without amplitude modulation are assumed to not interfere with the hearing aid electronics. Modulations without time slots and low fluctuations at low frequencies have low MIF values, TDMA modulations with narrow transmission and repetition rates of few 100 Hz have high MIF values and give similar classifications as ANSI C63.19-2011.

ER3D, EF3D and EU2D E-field probes have a bandwidth <10 kHz and can therefore not evaluate the RF envelope in the full audio band. DASY52 is therefore using the indirect measurement method according to ANSI C63.19-2011 which is the primary method. These near field probes read the averaged E-field measurement. Especially for the new high peak-to-average (PAR) signal types, the probes shall be linearized by PMR calibration in order to not overestimate the field reading. Probe Modulation Response (PMR) calibration linearizes the probe response over its dynamic range for specific modulations which are characterized by their UID and result in an uncertainty specified in the probe calibration certificate. The MIF is characteristic for a given waveform envelope and can be used as a constant conversion factor if the probe has been PMR calibrated.

The evaluation method for the MIF is defined in ANSI C63.19-2011 section D.7. An RMS demodulated RF signal is fed to a spectral filter (similar to an A weighting filter) and forwarded to a temporal filter acting as a quasi-peak detector. The averaged output of these filtering is scaled to a 1 kHz 80% AM signal as reference. MIF measurement requires additional instrumentation and is not well suited for evaluation by the end user with reasonable uncertainty. It may alternatively be determined through analysis and simulation, because it is constant and characteristic for a communication signal. DASY52 uses well-defined signals for PMR calibration. The MIF of these signals has been determined by simulation and it is automatically applied.



MIF values applied in this test report were provided by the HAC equipment provider, SPEAG, and the values are listed below

UID	Communication System Name	MIF(dB)
10021	GSM-FDD(TDMA,GMSK)	3.63
10011	UMTS-FDD(WCDMA)	-27.23

The MIF measurement uncertainty is estimated as follows, declared by HAC equipment provider SPEAG, for modulation frequencies from slotted waveforms with fundamental frequency and at least 2 harmonics within 10 kHz:

- i) 0.2 dB for MIF: -7 to +5 dB,
- ii) 0.5 dB for MIF: -13 to +11 dB
- iii) 1 dB for MIF: > -20 dB

### 9. Low-power Exemption

#### <Max Tune-up Limit>

Mode		Average Power (dBm)
GSM	GSM850	34.00
	GSM1900	31.00
WCDMA	Band II	22.50
	Band IV	25.00
	Band V	25.00

#### <Low Power Exemption>

Air Interface	Max Average Antenna Input Power (dBm)	Worst Case MIF (dB)	Power + MIF(dB)	C63.19 test required
GSM850	34.00	3.63	37.63	Yes
GSM1900	31.00	3.63	34.63	Yes
WCDMA	25.00	-27.23	-2.23	No

#### General Note:

- According to ANSI C63.19 2011-version, for WWAN RF air interface technology of a device is exempt from testing when its average antenna input power plus its MIF is  $\leq 17$  dBm for any of its operating modes.
- HAC RF rating is M4 for the air interface which meets the low power exemption.



**10. Conducted RF Output Power (Unit: dBm)**

Average Antenna Input Power(dBm)						
Band	GSM850			GSM1900		
Channel	128	189	251	512	661	810
Frequency (MHz)	824.2	836.4	848.8	1850.2	1880.0	1909.8
GSM (GMSK, 1 Tx slot)	33.25	33.30	33.35	30.54	30.76	30.51

**11. HAC RF Emission Test Results**

Emission Categories	E-field emissions	
	< 960Mhz	> 960Mhz
M1	50 to 55 dB (V/m)	40 to 45 dB (V/m)
M2	45 to 50 dB (V/m)	35 to 40 dB (V/m)
M3	40 to 45 dB (V/m)	30 to 35 dB (V/m)
M4	<40 dB (V/m)	<30 dB (V/m)

Plot No.	Air Interface	Mode	Channel	Average Antenna Input Power (dBm)	MIF	E-Field (dBV/m)	Margin to FCC M3 limit (dB)	E-Field M Rating
1	GSM850	Voice	128	33.25	3.63	36.16	8.84	M4
2	GSM850	Voice	189	33.30	3.63	36.92	8.08	M4
3	GSM850	Voice	251	33.35	3.63	36.62	8.38	M4
4	GSM1900	Voice	512	30.54	3.63	30.44	4.56	M3
5	GSM1900	Voice	661	30.76	3.63	29.75	5.25	M4
6	GSM1900	Voice	810	30.51	3.63	29.93	5.07	M4
WCDMA		According to sectin9 low power exemption, the RF Emission measurement is not required for WCDMA operation						M4

**Remark:**

1. The HAC measurement system applies MIF value onto the measured RMS E-field, which is indirect method in ANSI C63.19 2011 version, and reports the RF audio interference level.
2. The uncertainty is 0.2dB of MIF ranges from -7dB to +5dB. GSM850 band with rating M4, GSM1900 band with rating M3 would not be affected considering the MIF uncertainty.
3. There is special HAC mode software on this EUT.

Test Engineer : Bevis Chang.



## **12. Uncertainty Assessment**

The component of uncertainty may generally be categorized according to the methods used to evaluate them. The evaluation of uncertainty by the statistical analysis of a series of observations is termed a Type A evaluation of uncertainty. The evaluation of uncertainty by means other than the statistical analysis of a series of observation is termed a Type B evaluation of uncertainty. Each component of uncertainty, however evaluated, is represented by an estimated standard deviation, termed standard uncertainty, which is determined by the positive square root of the estimated variance.

The combined standard uncertainty of the measurement result represents the estimated standard deviation of the result. It is obtained by combining the individual standard uncertainties of both Type A and Type B evaluation using the usual “root-sum-squares” (RSS) methods of combining standard deviations by taking the positive square root of the estimated variances. Expanded uncertainty is a measure of uncertainty that defines an interval about the measurement result within which the measured value is confidently believed to lie. It is obtained by multiplying the combined standard uncertainty by a coverage factor. For purpose of this document, a coverage factor two is used, which corresponds to confidence interval of about 95 %. The DASY uncertainty Budget is showed in Table 12.1.



Error Description	Uncertainty Value (±%)	Probability Distribution	Divisor	Ci (E)	Standard Uncertainty (E)
<b>Measurement System</b>					
Probe Calibration	5.1	Normal	1	1	± 5.1 %
Axial Isotropy	4.7	Rectangular	√3	1	± 2.7 %
Sensor Displacement	16.5	Rectangular	√3	1	± 9.5 %
Boundary Effects	2.4	Rectangular	√3	1	± 1.4 %
Phantom Boundary Effects	7.2	Rectangular	√3	1	± 4.1 %
Linearity	4.7	Rectangular	√3	1	± 2.7 %
Scaling with PMR Calibration	10.0	Rectangular	√3	1	± 5.77 %
System Detection Limit	1.0	Rectangular	√3	1	± 0.6 %
Readout Electronics	0.3	Normal	1	1	± 0.3 %
Response Time	0.8	Rectangular	√3	1	± 0.5 %
Integration Time	2.6	Rectangular	√3	1	± 1.5 %
RF Ambient Conditions	3.0	Rectangular	√3	1	± 1.7 %
RF Reflections	12.0	Rectangular	√3	1	± 6.9 %
Probe Positioner	1.2	Rectangular	√3	1	± 0.7 %
Probe Positioning	4.7	Rectangular	√3	1	± 2.7 %
Extrap. and Interpolation	1.0	Rectangular	√3	1	± 0.6 %
<b>Test Sample Related</b>					
Device Positioning Vertical	4.7	Rectangular	√3	1	± 2.7 %
Device Positioning Lateral	1.0	Rectangular	√3	1	± 0.6 %
Device Holder and Phantom	2.4	Rectangular	√3	1	± 1.4 %
Power Drift	5.0	Rectangular	√3	1	± 2.9 %
<b>Phantom and Setup Related</b>					
Phantom Thickness	2.4	Rectangular	√3	1	± 1.4 %
<b>Combined Standard Uncertainty</b>					± 16.30 %
<b>Coverage Factor for 95 %</b>					K = 2
<b>Expanded Std. Uncertainty on Power</b>					± 32.6 %
<b>Expanded Std. Uncertainty on Field</b>					± 16.3 %

**Table 12.1 Uncertainty Budget of HAC free field assessment**

**Remark:**

Worst-Case uncertainty budget for HAC free field assessment according to ANSIC63.19 [1], [2]. The budget is valid for the frequency range 700 MHz - 3 GHz and represents a worst case analysis.



### **13. References**

- [1] ANSI C63.19-2011, "American National Standard for Methods of Measurement of Compatibility between Wireless Communications Devices and Hearing Aids", 27 May 2011.
- [2] FCC KDB 285076 D01v04r01, "Equipment Authorization Guidance for Hearing Aid Compatibility", Apr 2016
- [3] FCC KDB 285076 D02v02, "Guidance for Performing T-Coil tests for Air Interfaces Supporting Voice over IP", Apr 2016
- [4] SPEAG DASY System Handbook