



CERTIFICATION TEST REPORT

Report Number. : 11785223-E8V2

Applicant : SONY MOBILE COMMUNICATIONS INC.
4-12-3 HIGASHI-SHINAGAWA,
SHINAGAWA -KU,TOKYO, 140-0002, JAPAN

FCC ID : PY7-65365K

EUT Description : GSM/WCDMA/LTE Phone with BT,DTS/UNII a/b/g/n/ac, GPS & NFC

Test Standard(s) : FCC 47 CFR PART 15 SUBPART B

Date Of Issue:

August 01, 2017

Prepared by:

UL Verification Services Inc.
47173 Benicia Street
Fremont, CA 94538, U.S.A.
TEL: (510) 771-1000
FAX: (510) 661-0888



NVLAP LAB CODE 200065-0

Revision History

<u>Rev.</u>	<u>Issue Date</u>	<u>Revisions</u>	<u>Revised By</u>
V1	07/14/17	Initial Issue	D. Corona
V2	08/01/17	Updated Section 5.1, 6.1 & 6.2	D. Corona

TABLE OF CONTENTS

1. ATTESTATION OF TEST RESULTS	4
2. TEST METHODOLOGY.....	5
3. FACILITIES AND ACCREDITATION	5
4. CALIBRATION AND UNCERTAINTY	5
4.1. MEASURING INSTRUMENT CALIBRATION.....	5
4.2. SAMPLE CALCULATION.....	5
4.3. MEASUREMENT UNCERTAINTY	6
5. EQUIPMENT UNDER TEST	7
5.1. DESCRIPTION OF EUT.....	7
5.2. TEST CONFIGURATIONS.....	7
5.3. MODE(S) OF OPERATION.....	7
5.4. SOFTWARE AND FIRMWARE	7
5.5. MODIFICATIONS.....	7
5.6. DETAILS OF TESTED SYSTEM.....	8
Charging Mode.....	10
6. APPLICABLE EMISSIONS LIMITS AND TEST RESULTS	11
6.1. EMISSIONS TEST AND MEASUREMENT EQUIPMENT.....	11
6.2. RADIATED EMISSIONS LIMITS AND RESULTS.....	12
6.2.1. RADIATED EMISSIONS 30 TO 1000 MHz (SYNC MODE).....	13
6.2.2. RADIATED EMISSIONS 1GHz to 18GHz (SYNC MODE).....	15
6.2.3. RADIATED EMISSIONS 18 to 26 GHz (SYNC MODE).....	17
6.2.4. RADIATED EMISSIONS 26 to 40 GHz (SYNC MODE).....	19
6.2.5. RADIATED EMISSIONS 30 TO 1000 MHz (CHARGING MODE)	21
6.2.6. RADIATED EMISSIONS 1GHz to 18GHz (CHARGING MODE)	23
6.2.7. RADIATED EMISSIONS 18 to 26 GHz (CHARGING MODE)	25
6.2.8. RADIATED EMISSIONS 26 to 40 GHz (CHARGING MODE)	27
6.3. AC MAINS LINE CONDUCTED EMISSIONS.....	29
6.3.1. RESULTS- SYNC MODE	30
6.3.2. RESULTS- CHARGING MODE	32
7. SETUP PHOTOS.....	34

1. ATTESTATION OF TEST RESULTS

COMPANY NAME: SONY MOBILE COMMUNICATIONS, INC.
EUT DESCRIPTION: GSM/WCDMA/LTE Phone with BT, DTS/UNII a/b/g/n/ac, GPS & NFC.
SERIAL NUMBER: BH9000FB81
DATE TESTED: June 07 – July 11, 2017

APPLICABLE STANDARDS	
STANDARD	TEST RESULTS
FCC 47 CFR PART 15 SUBPART B	Pass

UL Verification Services Inc. tested the above equipment in accordance with the requirements set forth in the above standards. All indications of Pass/Fail in this report are opinions expressed by UL Verification Services Inc. based on interpretations and/or observations of test results. Measurement Uncertainties were not taken into account and are published for informational purposes only. The test results show that the equipment tested is capable of demonstrating compliance with the requirements as documented in this report.

Note: The results documented in this report apply only to the tested sample, under the conditions and modes of operation as described herein. This document may not be altered or revised in any way unless done so by UL Verification Services Inc. and all revisions are duly noted in the revisions section. Any alteration of this document not carried out by UL Verification Services Inc. will constitute fraud and shall nullify the document. This report must not be used by the client to claim product certification, approval, or endorsement by NVLAP, NIST, any agency of the Federal Government, or any agency of any government.

Approved and released for
UL Verification Services Inc. by:



DAN CORONIA
CONSUMER TECHNOLOGY DIVISION
WISE PROJECT LEAD
UL VERIFICATION SERVICES INC

Prepared by:



GLENN ESCANO
CONSUMER TECHNOLOGY DIVISION
WISE LAB ENGINEER
UL VERIFICATION SERVICES INC

2. TEST METHODOLOGY

The tests documented in this report were performed in accordance with ANSI C63.4-2014.

3. FACILITIES AND ACCREDITATION

The test sites and measurement facilities used to collect data are located at 47173 and 47266 Benicia Street, Fremont, California, USA. Line conducted emissions are measured only at the 47173 address. The following table identifies which facilities were utilized for radiated emission measurements documented in this report. Specific facilities are also identified in the test results sections.

47173 Benicia Street	47266 Benicia Street
<input checked="" type="checkbox"/> Chamber A(IC: 2324B-1)	<input type="checkbox"/> Chamber D(IC: 22541-1)
<input type="checkbox"/> Chamber B(IC: 2324B-2)	<input type="checkbox"/> Chamber E(IC: 22541-2)
<input checked="" type="checkbox"/> Chamber C(IC: 2324B-3)	<input type="checkbox"/> Chamber F(IC: 22541-3)
	<input type="checkbox"/> Chamber G(IC: 22541-4)
	<input type="checkbox"/> Chamber H(IC: 22541-5)

The above test sites and facilities are covered under FCC Test Firm Registration # 208313. UL Verification Services Inc. is accredited by NVLAP, Laboratory Code 200065-0. Chambers A through C are covered under Industry Canada company address code 2324B with site numbers 2324B -1 through 2324B-3, respectively. Chambers D through H are covered under Industry Canada company address code 22541 with site numbers 22541 -1 through 22541-5, respectively.

4. CALIBRATION AND UNCERTAINTY

4.1. MEASURING INSTRUMENT CALIBRATION

The measuring equipment utilized to perform the tests documented in this report has been calibrated in accordance with the manufacturer's recommendations, and is traceable to recognized national standards.

4.2. SAMPLE CALCULATION

Where relevant, the following sample calculation is provided:

$$\begin{aligned} \text{Field Strength (dBuV/m)} &= \text{Measured Voltage (dBuV)} + \text{Antenna Factor (dB/m)} + \\ &\text{Cable Loss (dB)} - \text{Preamp Gain (dB)} \\ 36.5 \text{ dBuV} + 18.7 \text{ dB/m} + 0.6 \text{ dB} - 26.9 \text{ dB} &= 28.9 \text{ dBuV/m} \end{aligned}$$

4.3. MEASUREMENT UNCERTAINTY

Where relevant, the following measurement uncertainty levels have been estimated for tests performed on the apparatus:

Parameter	Uncertainty
Worst Case Conducted Disturbance, 9KHz to 0.15 MHz	3.84 dB
Worst Case Conducted Disturbance, 0.15 to 30 MHz	3.65 dB
Worst Case Radiated Disturbance, 9KHz to 30 MHz	3.15 dB
Worst Case Radiated Disturbance, 30 to 1000 MHz	5.36 dB
Worst Case Radiated Disturbance, 1000 to 18000 MHz	4.32 dB
Worst Case Radiated Disturbance, 18000 to 26000 MHz	4.45 dB
Worst Case Radiated Disturbance, 26000 to 40000 MHz	5.24 dB

Uncertainty figures are valid to a confidence level of 95%.

5. EQUIPMENT UNDER TEST

5.1. DESCRIPTION OF EUT

The EUT is a GSM/WCDMA/LTE Phone with BT, DTS/UNII a/b/g/n/ac, GPS & NFC.

GENERAL INFORMATION

Highest frequency generated or used by the EUT	5825MHz
--	---------

5.2. TEST CONFIGURATIONS

The following configuration was tested:

EUT Configuration	Description
1	Laptop Sync Mode - The EUT was configured as table top equipment. The EUT is installed in a typical configuration. The EUT is connected to a laptop via USB, is charging and transferring data via the laptop.
2	Charging - The EUT was configured as table top equipment. The EUT is installed in a typical configuration. The EUT is connected to an AC adapter for charging and in a functional mode.

5.3. MODE(S) OF OPERATION

Mode	Description
Sync mode	Data transfer; Sync video file from laptop to EUT and continued playing video during testing.
Charging Mode	Charging with supplied USB charger. EUT and its charger shall be on back edge of table, with charger connected to extension cord.

5.4. SOFTWARE AND FIRMWARE

The software version installed in the EUT during testing was 0.274.

5.5. MODIFICATIONS

No modifications were made during testing.

5.6. DETAILS OF TESTED SYSTEM

SUPPORT EQUIPMENT & PERIPHERALS

Support Equipment List				
Description	Manufacturer	Model	Serial Number	FCC ID
Laptop	Lenovo	2349CW5	PB05HPL	DoC
Earphone	Sony	N/A	N/A	N/A
AC Adapter	Lenovo	ADLX90NLT2A	11S45N0307ZLZ436RDM2	N/A
Mouse	Logitech	M-U0026	1304HS02AX68	N/A
Keyboard	Lenovo	KU-0225	54Y9400	N/A
Switch	Netgear	FS105 v2	1D52163304A74	DoC
AC Adapter	Netgear	FA-0751000SUA	332-10154-01	N/A

I/O CABLES

I/O Cable List						
Cable No	Port	# of identical ports	Connector Type	Cable Type	Cable Length (m)	Remarks
1	DC Power	2	Power	Shielded	1.2m	N/A
2	Audio	1	Mini-Jack	Unshielded	1m	N/A
3	USB	1	Mini-USB	Shielded	0.9 m	UCB20 cable from EUT to Laptop
3	USB	2	USB	Shielded	2m	From laptop to keyboard & mouse
4	AC Power	2	IEC	Unshielded	1m	N/A
5	Ethernet	1	RJ45	Unshielded	2m	N/A

TEST SETUP

The EUT is installed in a typical configuration. Test software exercised the EUT.

SETUP DIAGRAM

Sync Mode

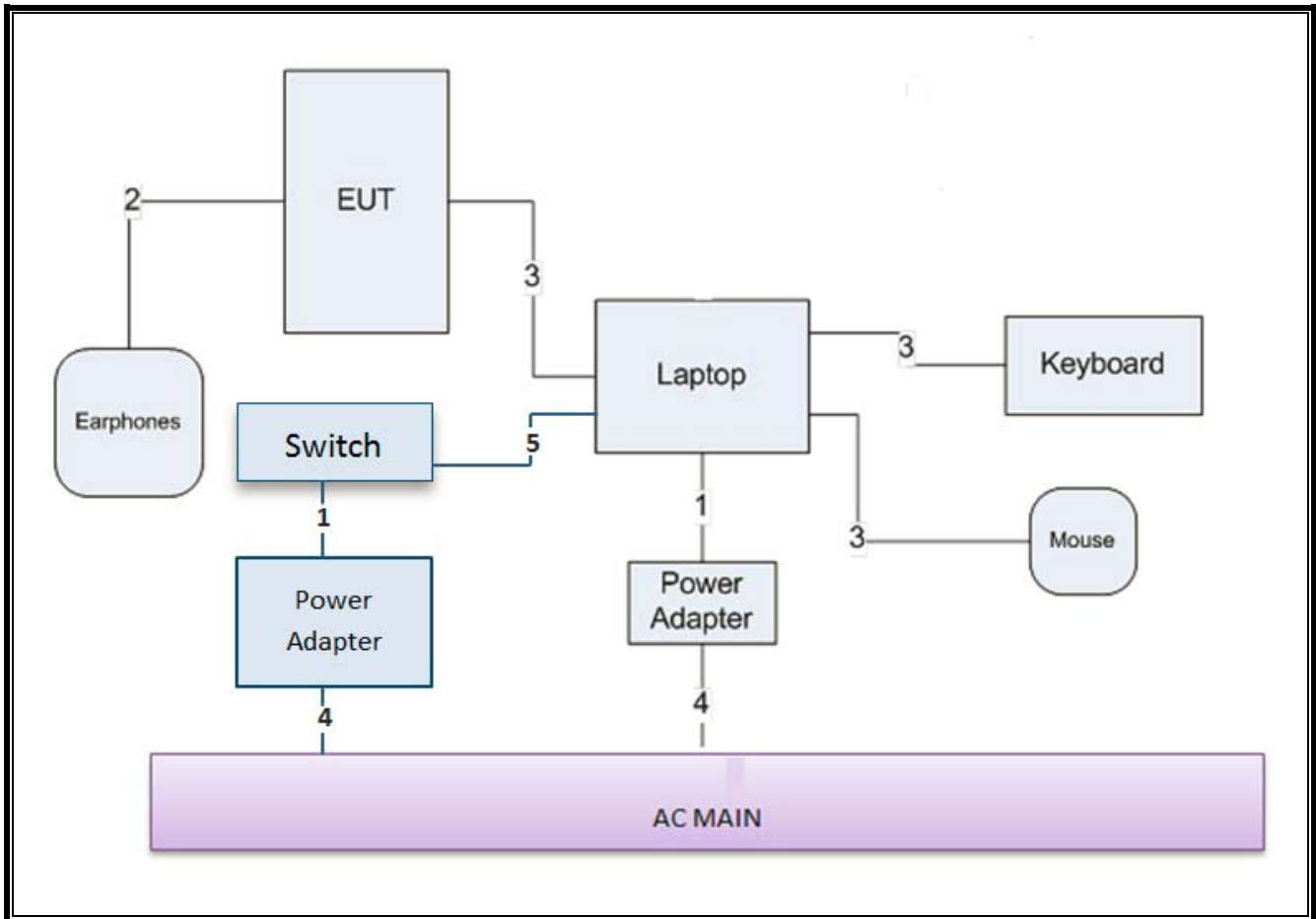

Charging Mode

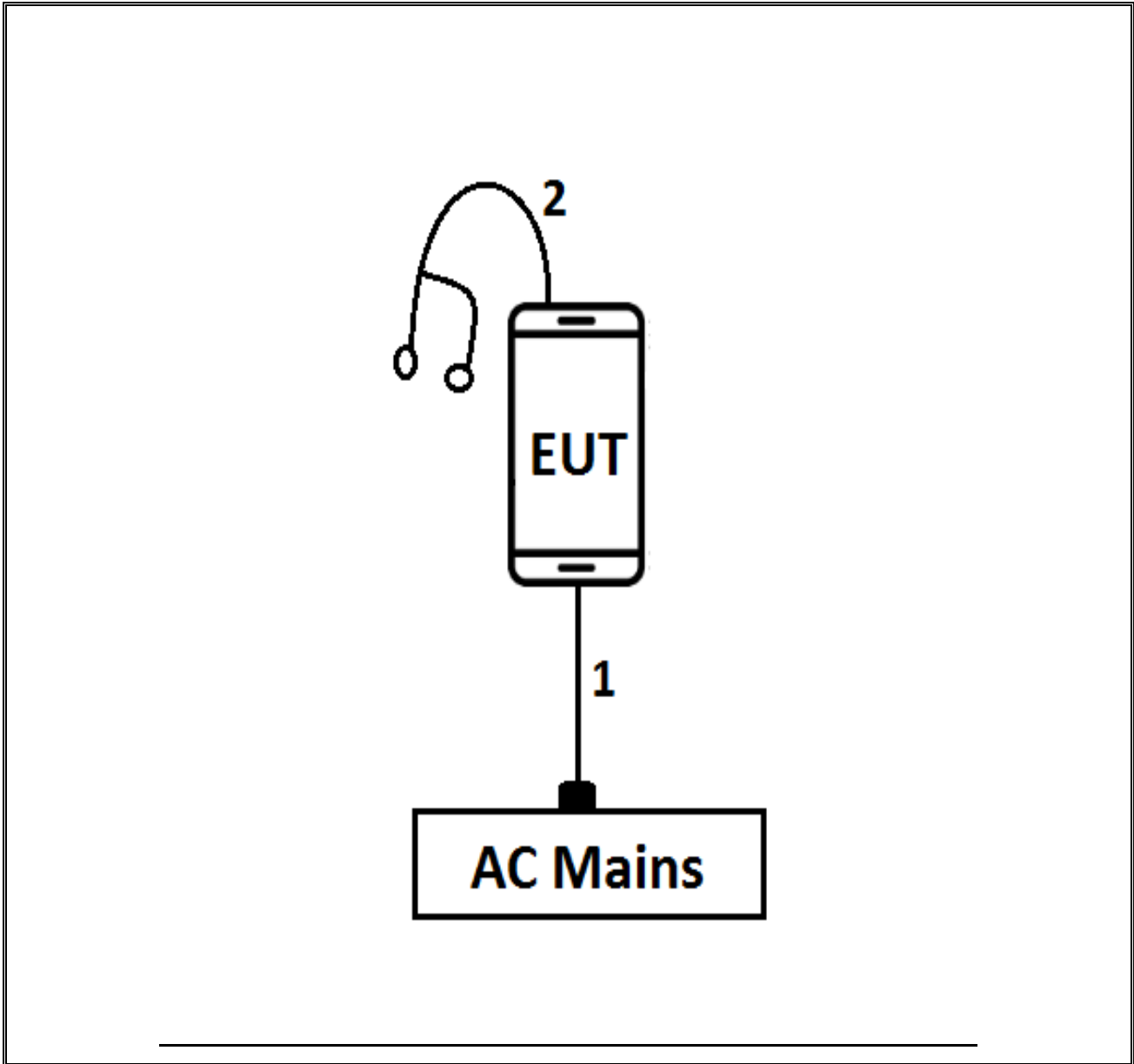

6. APPLICABLE EMISSIONS LIMITS AND TEST RESULTS

6.1. EMISSIONS TEST AND MEASUREMENT EQUIPMENT

The following test and measurement equipment was utilized for the tests documented in this report:

Test Equipment List					
Description	Manufacturer	Model	T Number	Cal Date	Cal Due
Amplifier, 1 to 18 GHz	Miteq	AFS43-00101800-25-S-42	493	02/15/17	02/15/18
Amplifier, 1 to 8 GHz	Miteq	AMF-4D-01000800-30-29P	1170	04/28/17	04/28/18
Amplifier, 10KHz to 1GHz, 32dB	Keysight	8447D	300	11/10/16	11/10/17
Antenna, Broadband Hybrid, 30MHz to 2000MHz	Sunol Sciences	JB3	130	09/23/16	09/23/17
PXA Spectrum Analyzer, 3Hz to 44GHz	Agilent	N9030A	1466	04/11/17	04/11/18
EMI Reciever	Rohde & Schwarz	ESR-EMI	1436	01/06/17	01/06/18
LISN	FISCHER	FCC-LISN-50/250-25-2-01	1310	06/08/17	06/08/18
18 - 26.5 GHz Horn Antenna	Seavey Division	MWH-1826/B	449	06/12/17	06/12/18
26.5 - 40 GHz Horn Antenna	ARA	MWH-2640/B	446	06/12/17	06/12/18
Pre-Amp 1-26.5 GHz	Agilent	8449B	404	07/05/16	07/05/17
Pre-Amp, 26-40GHz	MITEQ	NSP4000-SP2	88	04/29/17	04/29/2018
Spectrum Analyzer	Agilent	8564E	106	09/07/16	09/07/17

Test Software List			
Description	Manufacturer	Model	Version
Radiated Software	UL	UL EMC	Ver 9.5, Dec 01, 2016

6.2. RADIATED EMISSIONS LIMITS AND RESULTS

LIMIT

FCC Part 15 Subpart B

§15.109 (a) Except for Class A digital devices, the field strength of radiated emissions from unintentional radiators at a distance of 3 meters shall not exceed the following values:

Limits for radiated disturbance of Class B ITE at measuring distance of 3 m		
Frequency range (MHz)	Field Strength Limit (uV/m)	Quasi-Peak Limit (dBuV/m)
30 to 88	100	40
88 to 216	150	43.5
216 to 960	200	46
Above 960 MHz	500	54
Note: The lower limit shall apply at the transition frequency.		
Frequency (MHz)	Peak (dBuV/m) Limit	Average (dBuV/m) Limit
Above 1000	74	54

TEST PROCEDURE

ANSI C63.4: 2014

The highest frequency generated or used in the EUT is 5.8 GHz therefore the frequency range was investigated from 30 MHz to 40 GHz.

Highest frequency generated or used in the device or on which the device operates or tunes (MHz)	Upper frequency of measurement range (MHz)
Below 108	1000
108-500	2000
500-1000	5000
Above 1000	5 th harmonic of the highest frequency or 40 GHz, whichever is lower

RESULTS

6.2.1. RADIATED EMISSIONS 30 TO 1000 MHz (SYNC MODE)

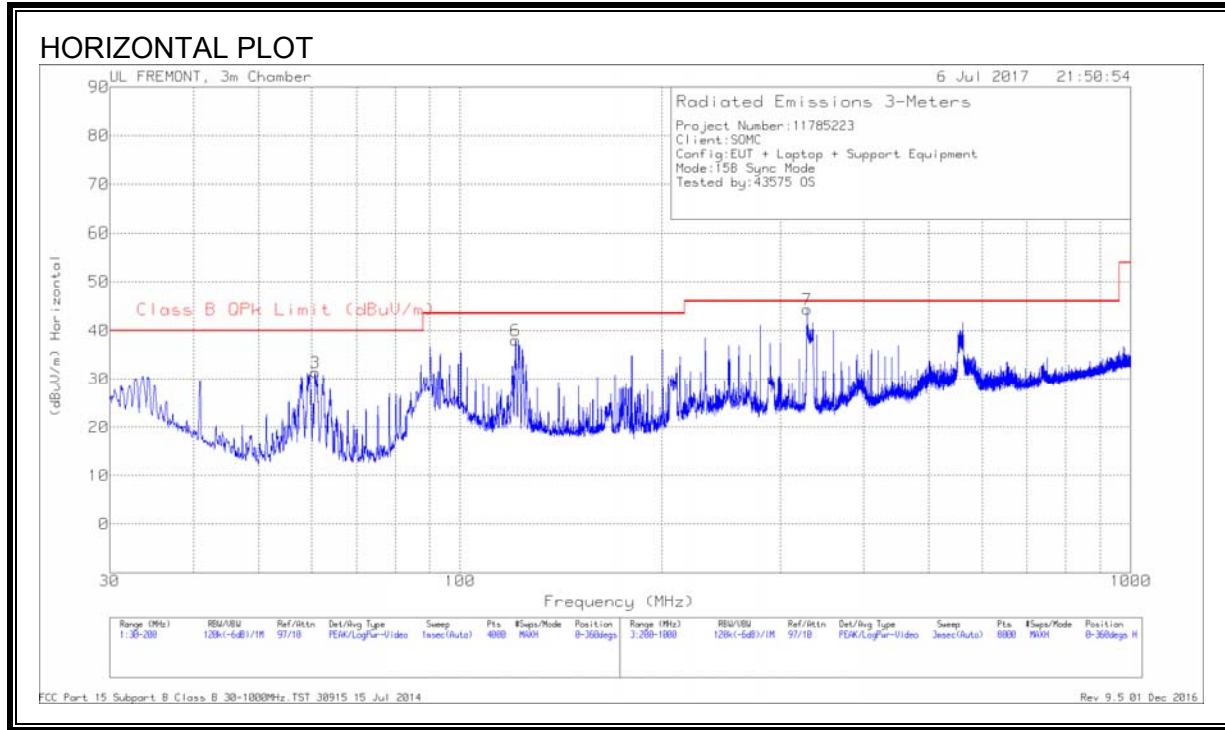

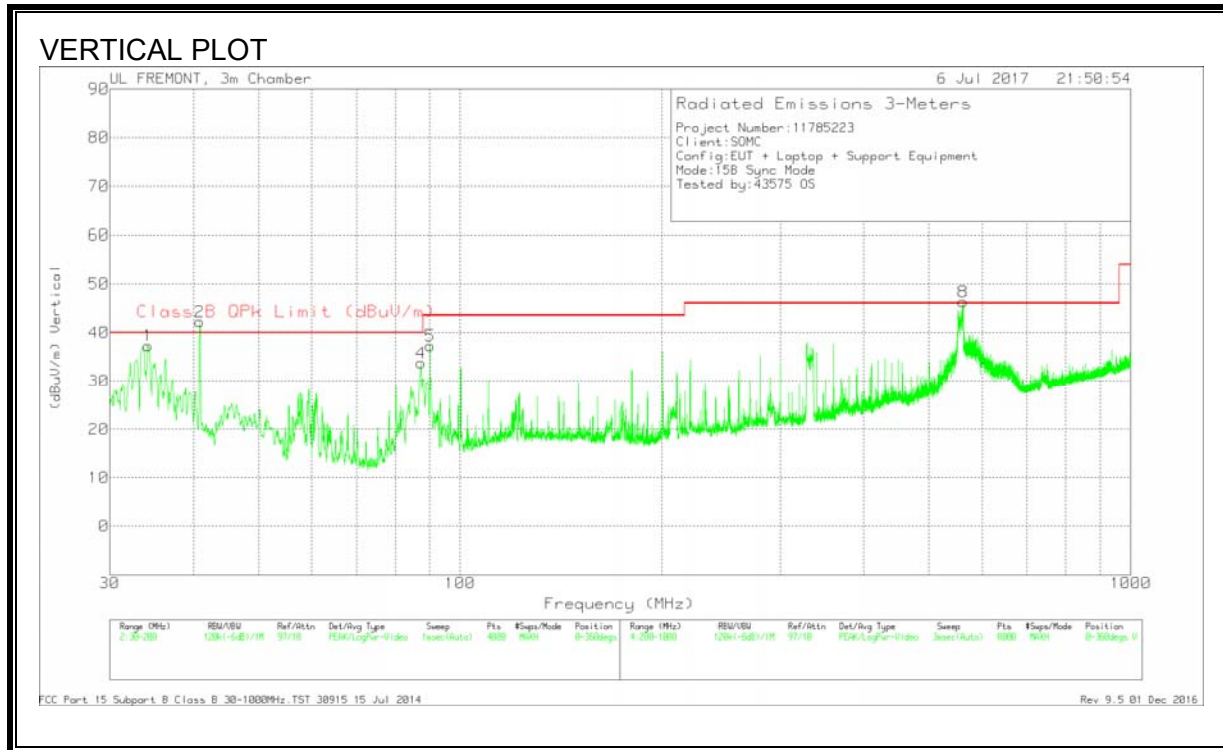

HORIZONTAL AND VERTICAL DATA

Radiated Emissions

Marker	Frequency (MHz)	Meter Reading (dBuV)	Det	AF T408 (dB/m)	Amp/Cbl (dB)	Corrected Reading (dBuV/m)	Class B QPK Limit (dBuV/m)	Margin (dB)	Azimuth (Degs)	Height (cm)	Polarity
1	33.9844	36.27	Qp	22.1	-27.2	31.17	40	-8.83	47	101	V
2	40.807	21.9	Qp	17.3	-27.1	12.1	40	-27.9	250	153	V
3	60.7355	46.56	Pk	11.6	-26.8	31.36	40	-8.64	0-360	400	H
4	87.3899	48.94	Pk	11.3	-26.5	33.74	40	-6.26	0-360	100	V
5	90.1956	51.99	Pk	11.7	-26.4	37.29	43.52	-6.23	0-360	100	V
6	120.752	37.71	Qp	17.7	-26	29.41	43.52	-14.11	18	238	H
7	329.2363	41.28	Qp	17.9	-24.3	34.88	46.02	-11.14	74	224	H
8	562.3355	34.26	Qp	22.3	-24.5	32.06	46.02	-13.96	359	102	V

Pk - Peak detector

Qp - Quasi-Peak detector

6.2.2. RADIATED EMISSIONS 1GHz to 18GHz (SYNC MODE)

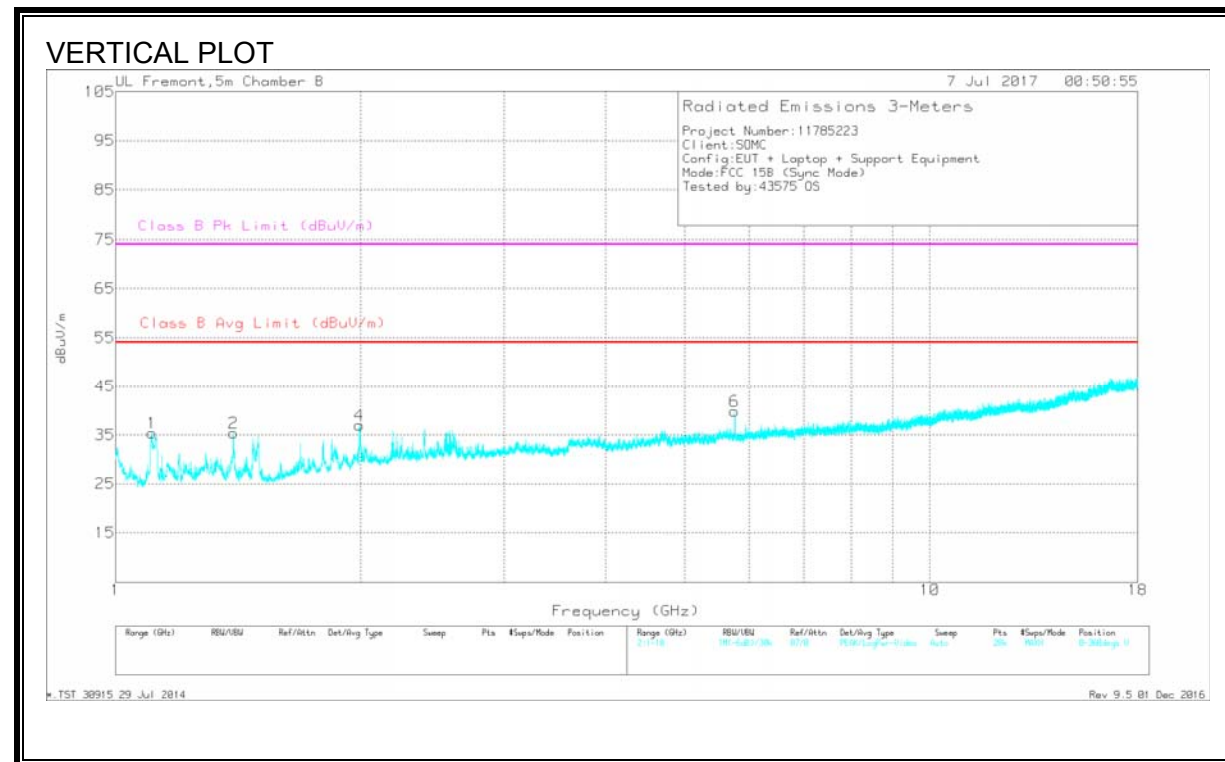
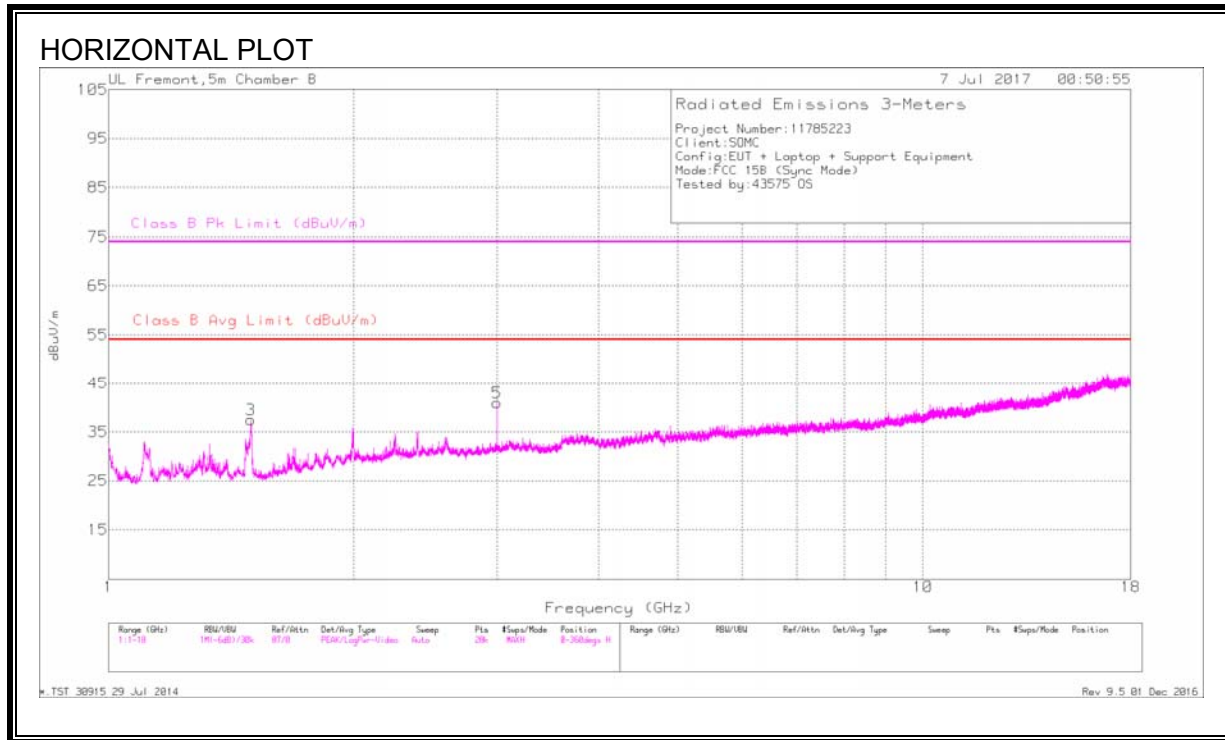

HORIZONTAL AND VERTICAL DATA

Radiated Emissions

Frequency (GHz)	Meter Reading (dBuV)	Det	AF T863 (dB/m)	Amp/Cbl (dB)	Corrected Reading dBuV/m	Class B Avg Limit (dBuV/m)	Av(CISPR)Margin (dB)	Class B Pk Limit (dBuV/m)	Margin (dB)	Azimuth (Degs)	Height (cm)	Polarity
1.111	44.6	Pk	27.6	-34.3	37.9	-	-	74	-36.1	69	340	V
1.111	29.8	Av	27.6	-34.3	23.1	54	-30.9	-	-	69	340	V
1.395	52.78	Pk	28.2	-33.8	47.18	-	-	74	-26.82	71	138	V
1.395	29.11	Av	28.2	-33.8	23.51	54	-30.49	-	-	71	138	V
1.494	52.91	Pk	28.2	-33.5	47.61	-	-	74	-26.39	120	115	H
1.494	28.31	Av	28.2	-33.5	23.01	54	-30.99	-	-	120	115	H
1.993	45.65	Pk	31.3	-32.9	44.05	-	-	74	-29.95	209	178	V
1.993	26.99	Av	31.3	-32.9	25.39	54	-28.61	-	-	209	178	V
3	46.51	Pk	32.8	-31.4	47.91	-	-	74	-26.09	77	387	H
3	26.61	Av	32.8	-31.4	28.01	54	-25.99	-	-	77	387	H
5.76	41.5	Pk	35	-29.5	47	-	-	74	-27	2	173	V
5.76	34.35	Av	35	-29.5	39.85	54	-14.15	-	-	2	173	V

Pk - Peak detector

Av - Average detection

6.2.3. RADIATED EMISSIONS 18 to 26 GHz (SYNC MODE)

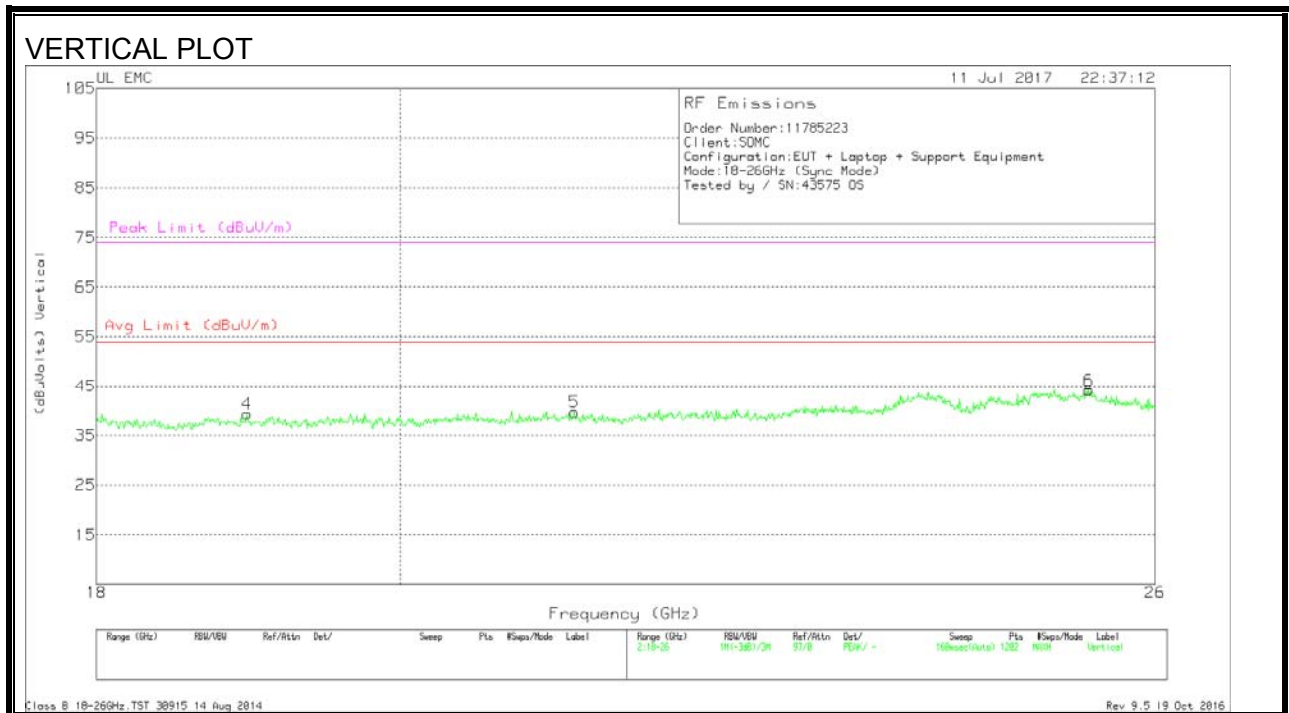
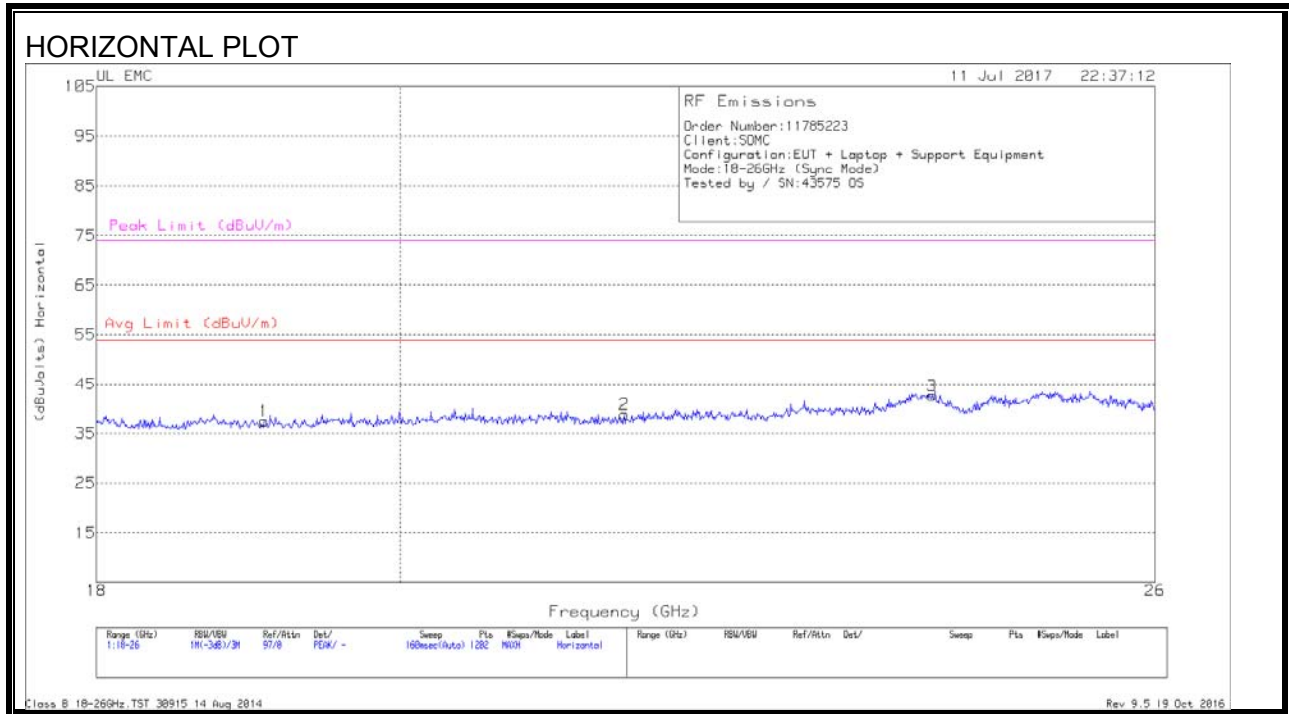

HORIZONTAL AND VERTICAL DATA

Trace Markers

Marker	Frequency (GHz)	Meter Reading (dBuV)	Det	T449 AF (dB/m)	Amp/Cbl (dB)	Dist Corr (dB)	Corrected Reading (dBuVolts)	Avg Limit (dBuV/m)	Margin (dB)	Peak Limit (dBuV/m)	PK Margin (dB)
1	19.079	39.4	Pk	32.5	-24.9	-9.5	37.5	54	-16.5	74	-36.5
2	21.624	40.33	Pk	33.2	-25.2	-9.5	38.83	54	-15.17	74	-35.17
3	24.062	42.77	Pk	33.9	-24.5	-9.5	42.67	54	-11.33	74	-31.33
4	18.966	41.63	Pk	32.4	-25.2	-9.5	39.33	54	-14.67	74	-34.67
5	21.251	41.57	Pk	33	-25.4	-9.5	39.67	54	-14.33	74	-34.33
6	25.407	43.67	Pk	34.4	-24.4	-9.5	44.17	54	-9.83	74	-29.83

Pk - Peak detector

6.2.4. RADIATED EMISSIONS 26 to 40 GHz (SYNC MODE)

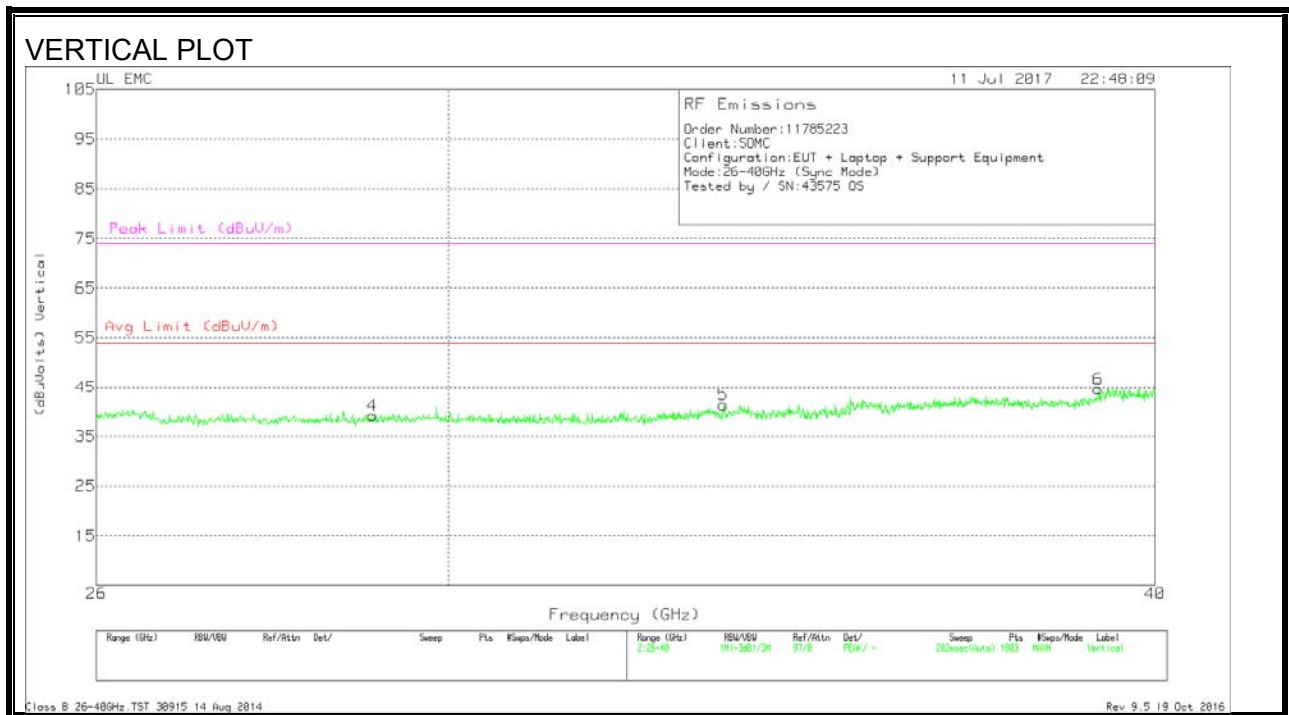
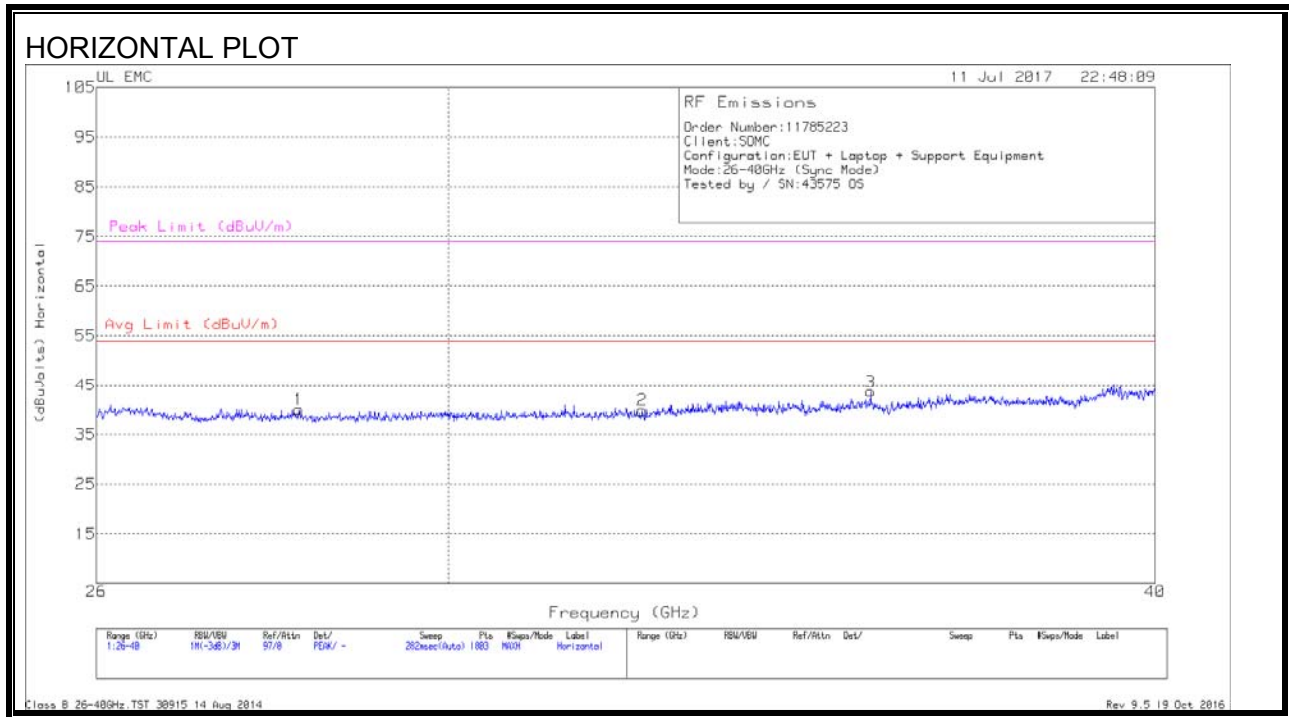

HORIZONTAL AND VERTICAL DATA

Trace Markers

Marker	Frequency (GHz)	Meter Reading (dBuV)	Det	T90 AF (dB/m)	Amp/Cbl (dB)	Dist Corr (dB)	Corrected Reading (dBuVolts)	Avg Limit (dBuV/m)	Margin (dB)	Peak Limit (dBuV/m)	PK Margin (dB)
1	28.23	45.6	Pk	35.9	-32	-9.5	40	54	-14	74	-34
2	32.464	46.33	Pk	36.2	-33.2	-9.5	39.83	54	-14.17	74	-34.17
3	35.626	49.67	Pk	37.6	-34.1	-9.5	43.67	54	-10.33	74	-30.33
4	29.092	45.37	Pk	35.9	-32.6	-9.5	39.17	54	-14.83	74	-34.83
5	33.552	47.33	Pk	37	-33.5	-9.5	41.33	54	-12.67	74	-32.67
6	39.083	49.17	Pk	37.7	-32.7	-9.5	44.67	54	-9.33	74	-29.33

Pk - Peak detector

6.2.5. RADIATED EMISSIONS 30 TO 1000 MHz (CHARGING MODE)

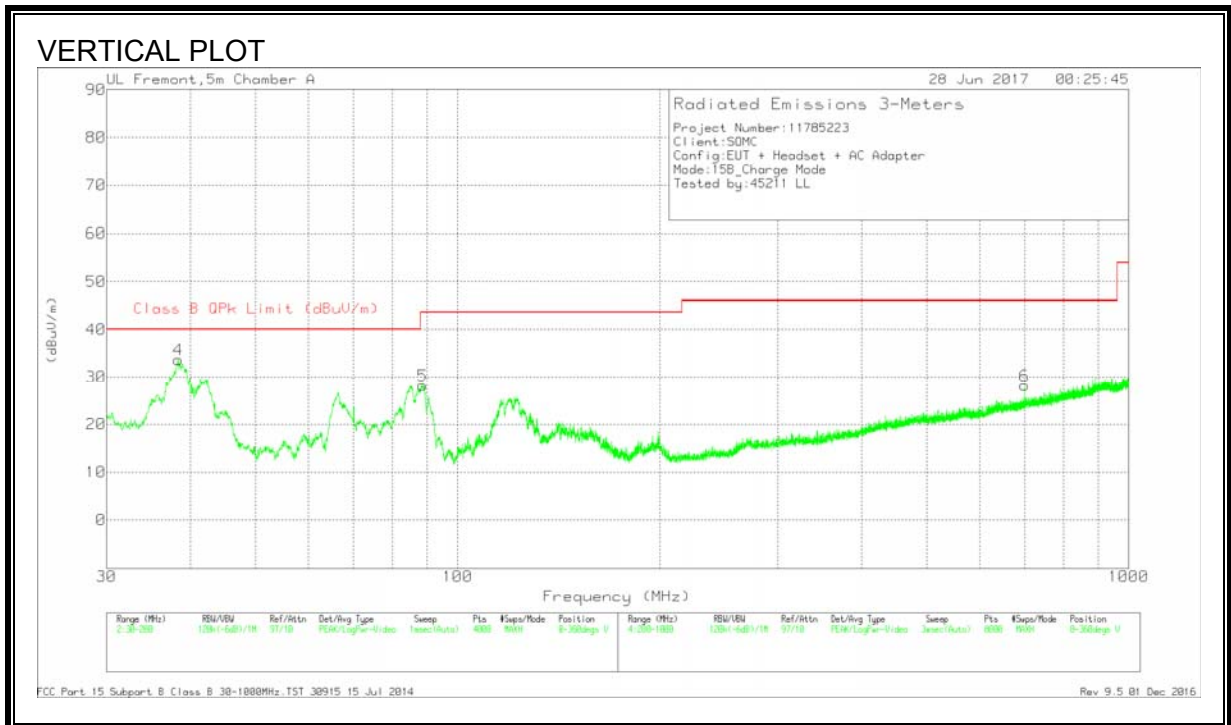
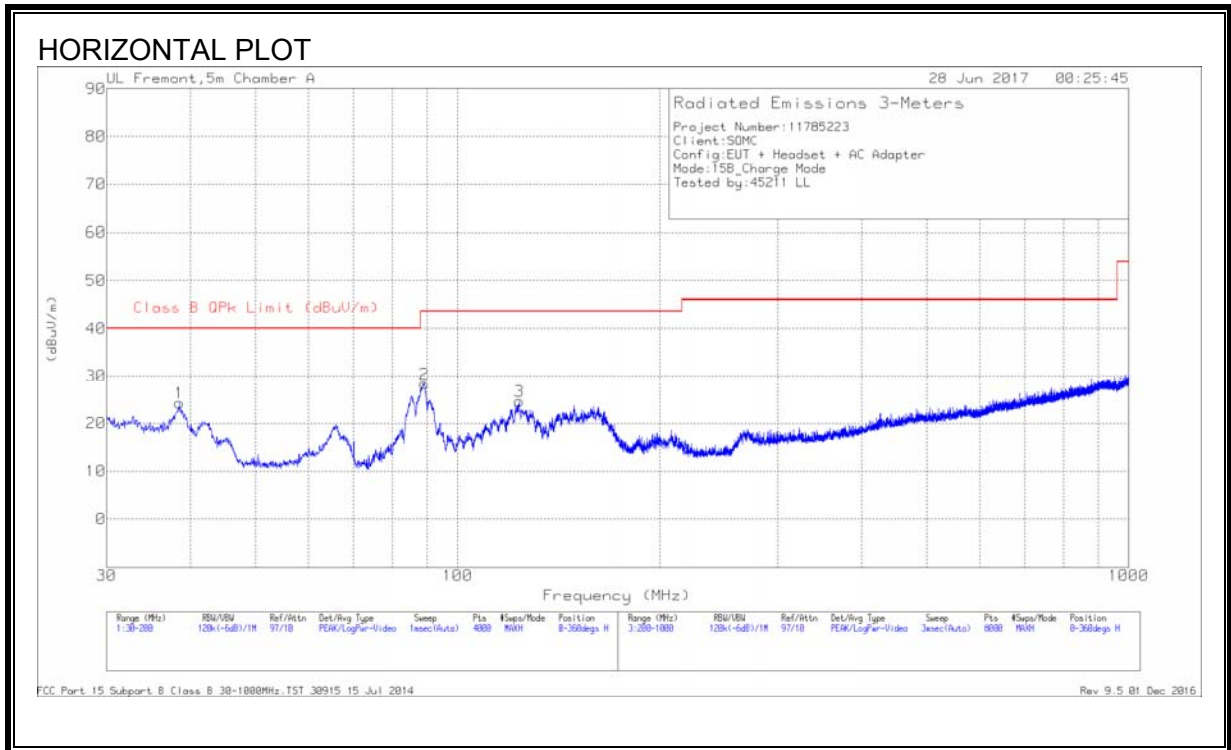

HORIZONTAL AND VERTICAL DATA

Radiated Emissions

Marker	Frequency (MHz)	Meter Reading (dBuV)	Det	AF T130 (dB/m)	Amp/Cbl (dB/m)	Corrected Reading (dBuV/m)	Class B QPk Limit (dBuV/m)	Margin (dB)	Azimuth (Degs)	Height (cm)	Polarity
4	38.3322	45.63	Pk	19.2	-31.1	33.73	40	-6.27	0-360	100	V
1	38.5022	36.34	Pk	19	-31.1	24.24	40	-15.76	0-360	400	H
5	88.7077	47.22	Pk	11.6	-30.6	28.22	43.52	-15.3	0-360	100	V
2	89.2178	47.36	Pk	11.6	-30.6	28.36	43.52	-15.16	0-360	200	H
3	123.6092	37.21	Pk	17.9	-30.4	24.71	43.52	-18.81	0-360	200	H
6	699.865	32.27	Pk	24.2	-28.3	28.17	46.02	-17.85	0-360	100	V

Qp - Quasi-Peak detector

6.2.6. RADIATED EMISSIONS 1GHz to 18GHz (CHARGING MODE)

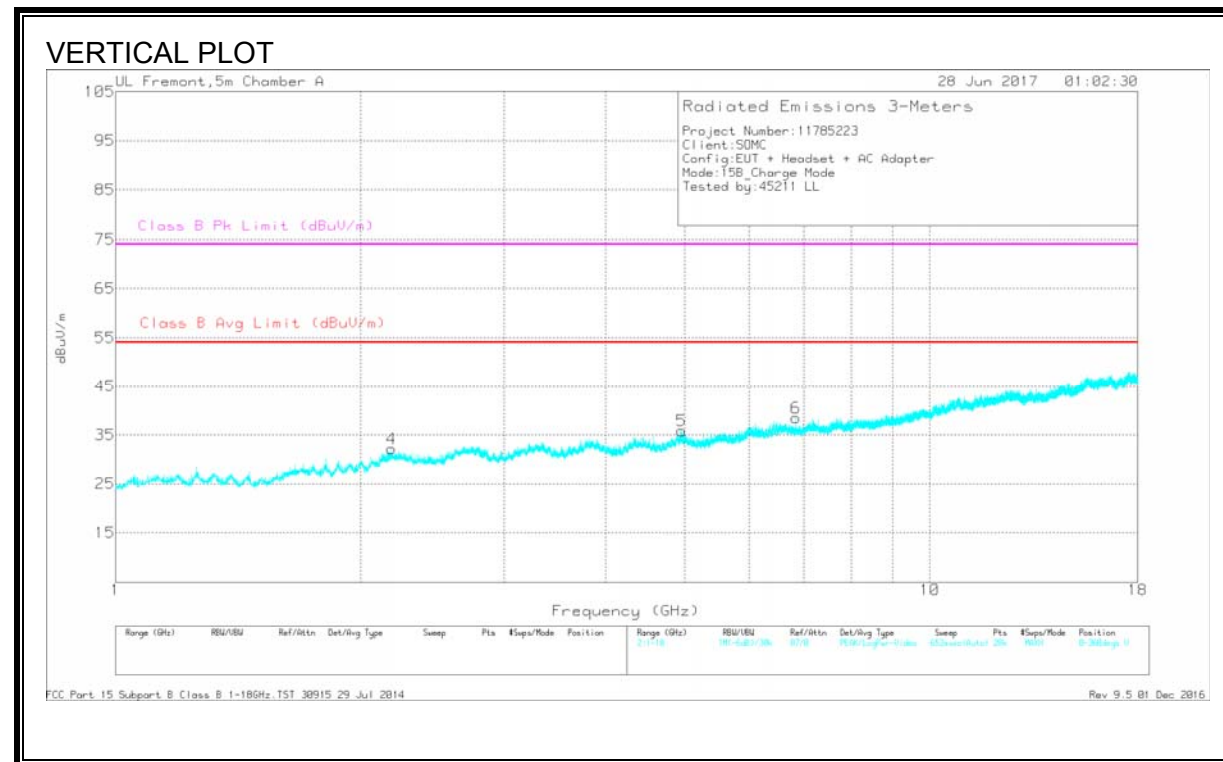
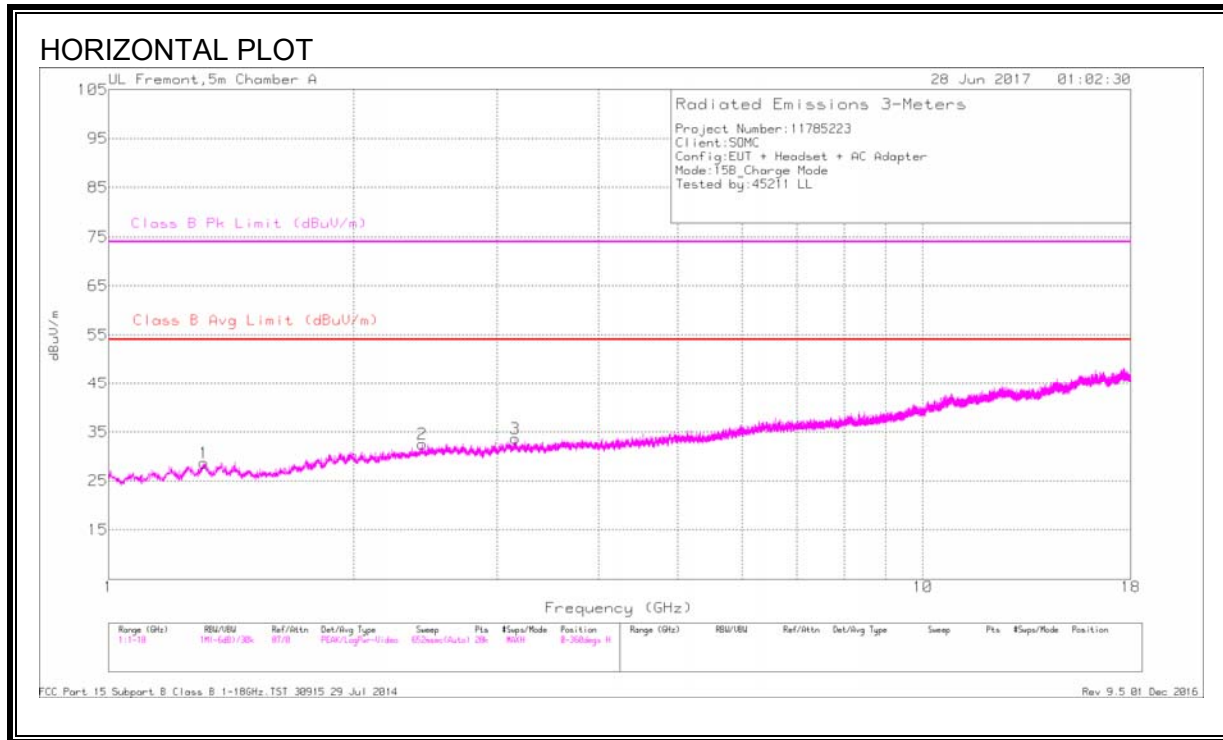

HORIZONTAL AND VERTICAL DATA

Radiated Emissions

Frequency (GHz)	Meter Reading (dBuV)	Det	AF T711 (dB/m)	Amp/Cbl (dB)	Corrected Reading dBuV/m	Class B Avg Limit (dBuV/m)	Margin (dB)	Class B Pk Limit (dBuV/m)	Margin (dB)	Azimuth (Degs)	Height (cm)	Polarity
1.309	27.64	Av	29.5	-33.3	23.84	54	-30.16	-	-	216	360	H
1.309	39.8	Pk	29.5	-33.3	36	-	-	74	-38	216	360	H
2.184	39.09	Pk	31.5	-32	38.59	-	-	74	-35.41	34	200	V
2.184	26.32	Av	31.5	-32	25.82	54	-28.18	-	-	34	200	V
2.424	38.95	Pk	32.3	-31.6	39.65	-	-	74	-34.35	256	102	H
2.424	26.23	Av	32.3	-31.6	26.93	54	-27.07	-	-	256	102	H
3.156	38.9	Pk	33	-30.4	41.5	-	-	74	-32.5	132	102	H
3.156	25.58	Av	33	-30.4	28.18	54	-25.82	-	-	132	102	H
4.953	37.61	Pk	34.1	-28.3	43.41	-	-	74	-30.59	228	200	V
4.953	23.95	Av	34.1	-28.3	29.75	54	-24.25	-	-	228	200	V
6.845	34.74	Pk	35.5	-24.5	45.74	-	-	74	-28.26	346	200	V
6.845	21.56	Av	35.5	-24.5	32.56	54	-21.44	-	-	346	200	V

Pk - Peak detector
 Av - Average detection

6.2.7. RADIATED EMISSIONS 18 to 26 GHz (CHARGING MODE)

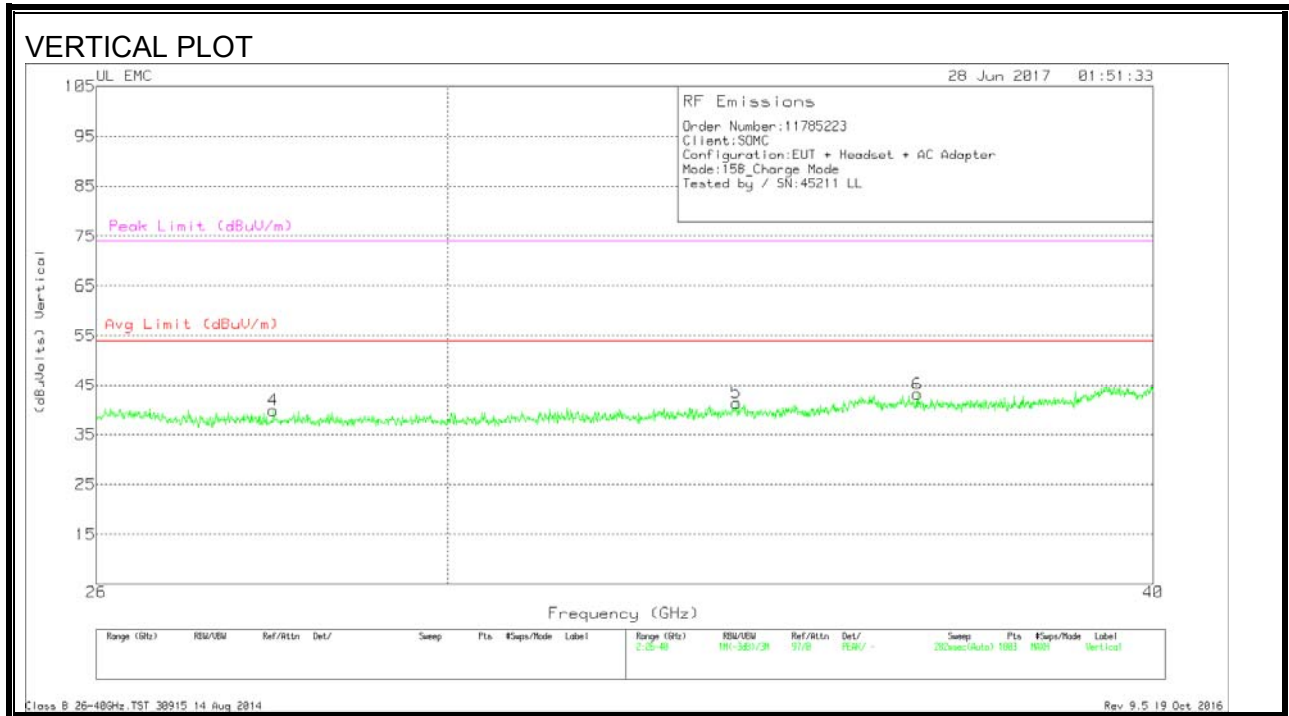
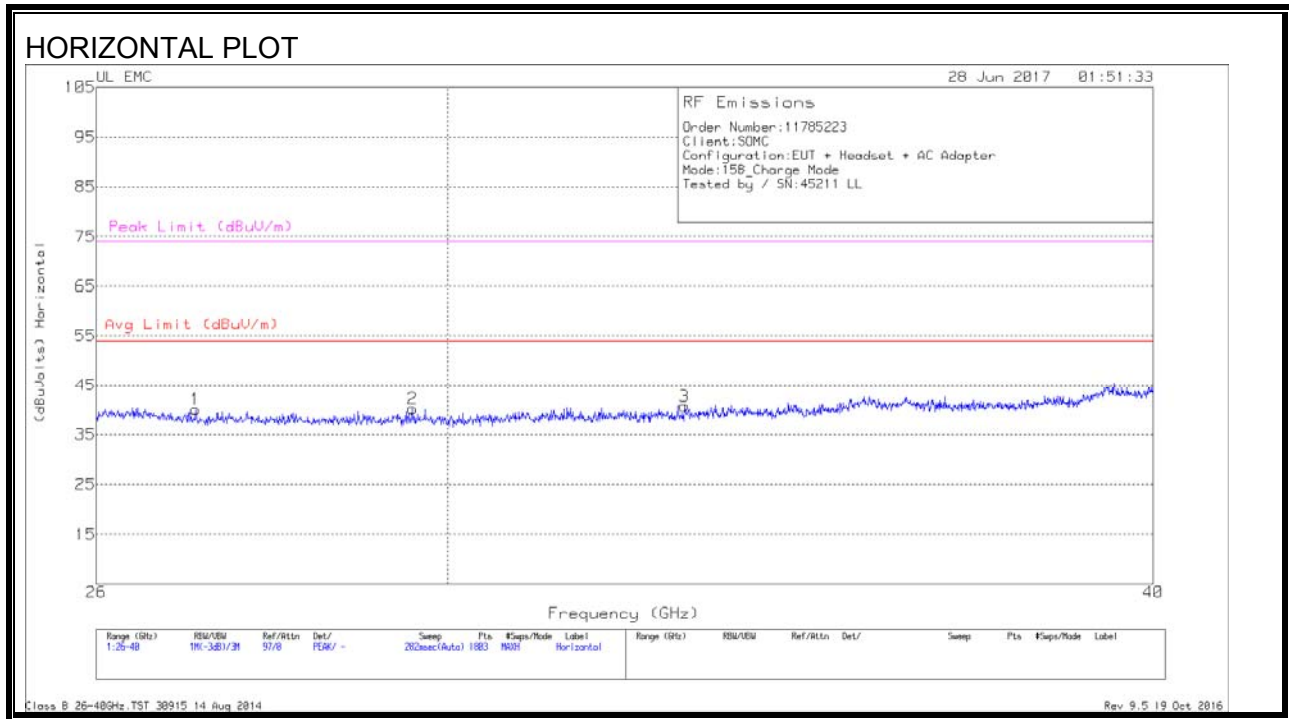

HORIZONTAL AND VERTICAL DATA

Trace Markers

Marker	Frequency (GHz)	Meter Reading (dBuV)	Det	T90 AF (dB/m)	Amp/Cbl (dB)	Dist Corr (dB)	Corrected Reading (dBuVolts)	Avg Limit (dBuV/m)	Margin (dB)	Peak Limit (dBuV/m)	PK Margin (dB)
1	27.072	45.3	Pk	35.5	-31.3	-9.5	40	54	-14	74	-34
2	29.574	46.37	Pk	36	-32.7	-9.5	40.17	54	-13.83	74	-33.83
3	33.039	46.77	Pk	36.7	-33.3	-9.5	40.67	54	-13.33	74	-33.33
4	27.942	45.73	Pk	35.8	-32.2	-9.5	39.83	54	-14.17	74	-34.17
5	33.754	47.53	Pk	36.8	-33.5	-9.5	41.33	54	-12.67	74	-32.67
6	36.333	50.17	Pk	37.2	-34.7	-9.5	43.17	54	-10.83	74	-30.83

Pk - Peak detector

6.2.8. RADIATED EMISSIONS 26 to 40 GHz (CHARGING MODE)

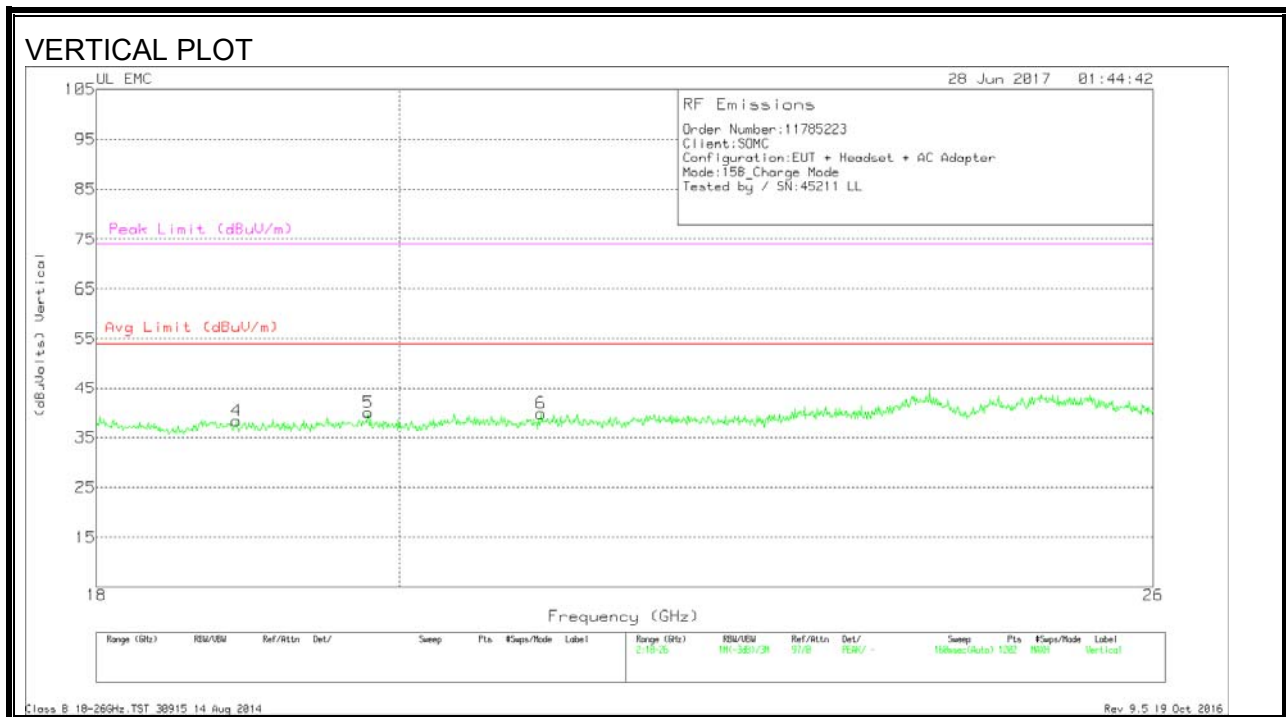
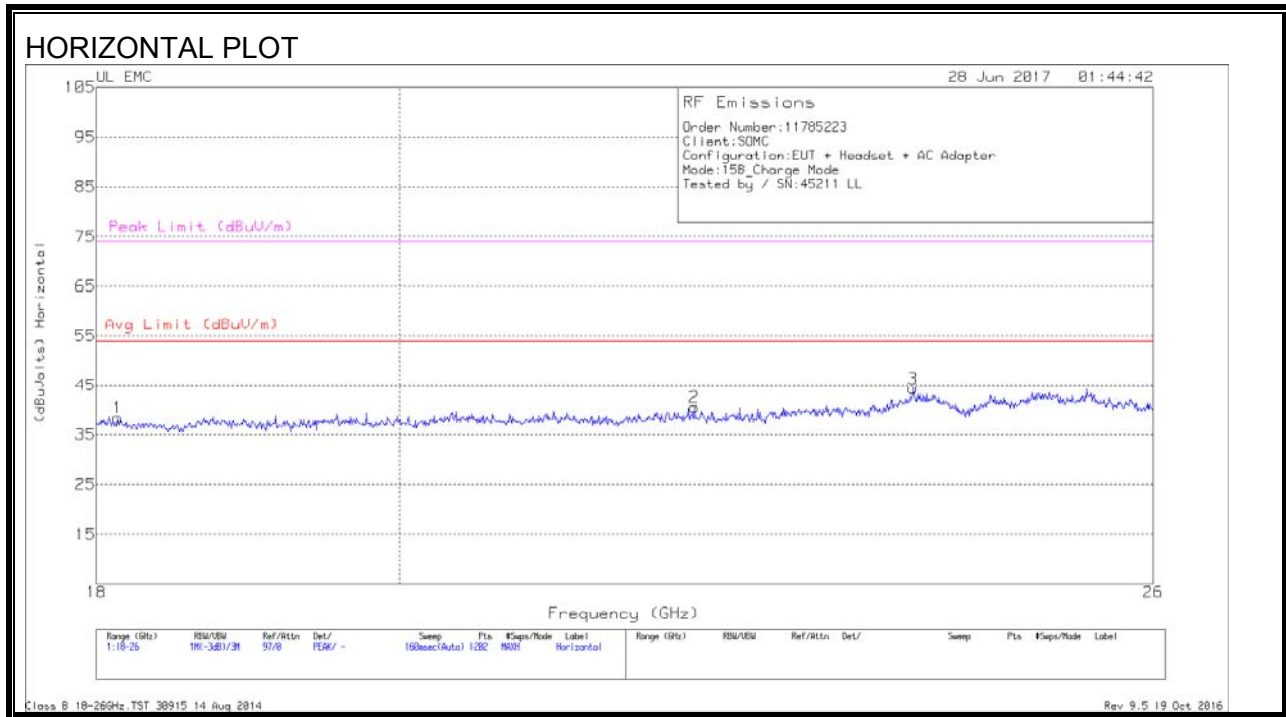

HORIZONTAL AND VERTICAL DATA

Trace Markers

Marker	Frequency (GHz)	Meter Reading (dBuV)	Det	T449 AF (dB/m)	Amp/Cbl (dB)	Dist Corr (dB)	Corrected Reading (dBuVolts)	Avg Limit (dBuV/m)	Margin (dB)	Peak Limit (dBuV/m)	PK Margin (dB)
1	18.133	41.23	Pk	32.3	-25.7	-9.5	38.33	54	-15.67	74	-35.67
2	22.163	41.3	Pk	33.4	-24.7	-9.5	40.5	54	-13.5	74	-33.5
3	23.915	43.83	Pk	33.9	-23.9	-9.5	44.33	54	-9.67	74	-29.67
4	18.899	40.83	Pk	32.4	-25.4	-9.5	38.33	54	-15.67	74	-35.67
5	19.785	41.5	Pk	32.7	-24.7	-9.5	40	54	-14	74	-34
6	21.011	41.73	Pk	33.2	-25.6	-9.5	39.83	54	-14.17	74	-34.17

Pk - Peak detector

6.3. AC MAINS LINE CONDUCTED EMISSIONS

TEST PROCEDURE

ANSI C63.4: 2014

LIMIT

§15.107 (a) Except for Class A digital devices, for equipment that is designed to be connected to the public utility (AC) power line, the radio frequency voltage that is conducted back onto the AC power line on any frequency or frequencies within the band 150 kHz to 30 MHz shall not exceed the limits in the following table, as measured using a 50 μ H/50 ohms line impedance stabilization network (LISN). Compliance with the provisions of this paragraph shall be based on the measurement of the radio frequency voltage between each power line and ground at the power terminal. The lower limit applies at the band edges.

Frequency range (MHz)	Limits (dB μ V)	
	Quasi-peak	Average
0.15 to 0.50	66 to 56	56 to 46
0.50 to 5	56	46
5 to 30	60	50

Notes:
1. The lower limit shall apply at the transition frequencies
2. The limit decreases linearly with the logarithm of the frequency in the range 0.15 MHz to 0.50 MHz

6.3.1. RESULTS- SYNC MODE

6 WORST EMISSIONS

Line-L1 .15 - 30MHz

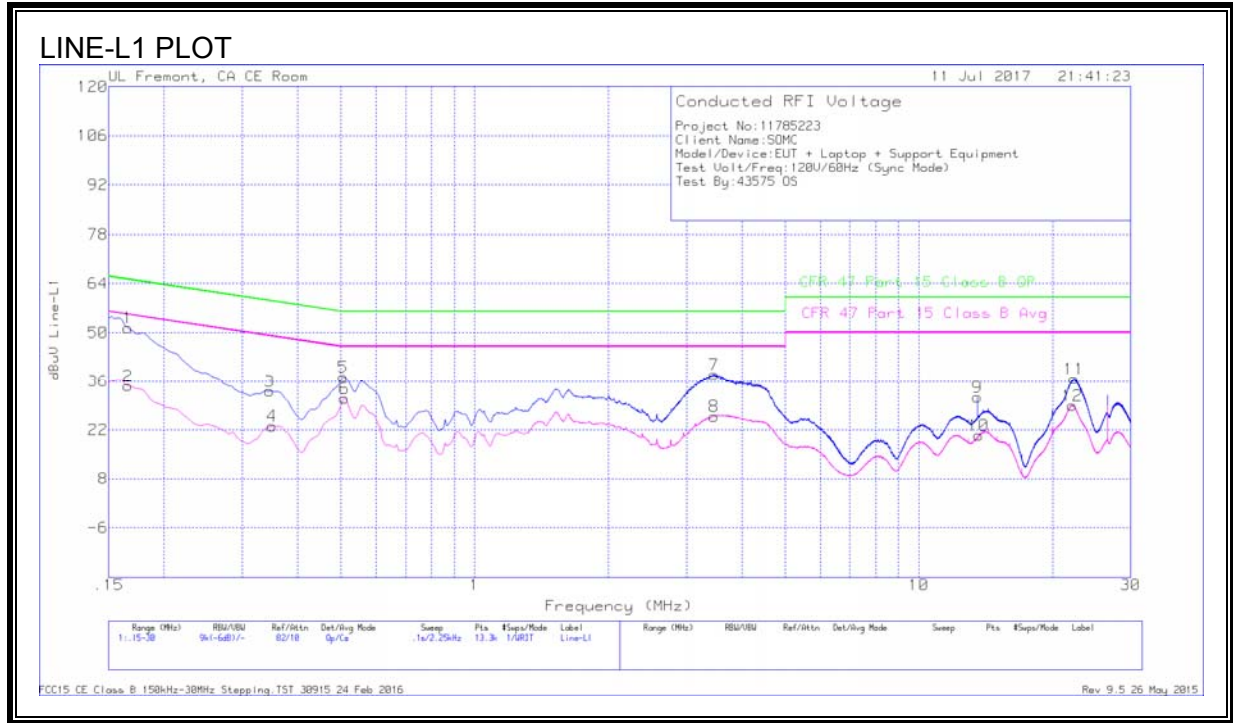

Range 1: Line-L1 .15 - 30MHz

Marker	Frequency (MHz)	Meter Reading (dBuV)	Det	LISN L1	LC Cables C1&C3	Limiter (dB)	Corrected Reading dBuV	CFR 47 Part 15 Class B QP	QP Margin (dB)	CFR 47 Part 15 Class B Avg	Av(CISPR) Margin (dB)
1	.16575	41.12	Qp	.1	0	10.1	51.32	65.17	-13.85	-	-
2	.16575	24.44	Ca	.1	0	10.1	34.64	-	-	55.17	-20.53
3	.34575	22.87	Qp	0	.1	10.1	33.07	59.06	-25.99	-	-
4	.35025	12.94	Ca	0	.1	10.1	23.14	-	-	48.96	-25.82
5	.5055	27.03	Qp	0	.1	10.1	37.23	56	-18.77	-	-
6	.51	20.89	Ca	0	.1	10.1	31.09	-	-	46	-14.91
7	3.45638	27.75	Qp	0	.1	10.1	37.95	56	-18.05	-	-
8	3.462	15.72	Ca	0	.1	10.1	25.92	-	-	46	-20.08
9	13.56	20.86	Qp	.1	.2	10.2	31.36	60	-28.64	-	-
10	13.641	9.87	Ca	.1	.2	10.2	20.37	-	-	50	-29.63
11	22.38	25.95	Qp	.1	.3	10.4	36.75	60	-23.25	-	-
12	22.155	18.22	Ca	.1	.3	10.4	29.02	-	-	50	-20.98

Qp - Quasi-Peak detector
 Ca - CISPR average detection

Line-L2 .15 - 30MHz

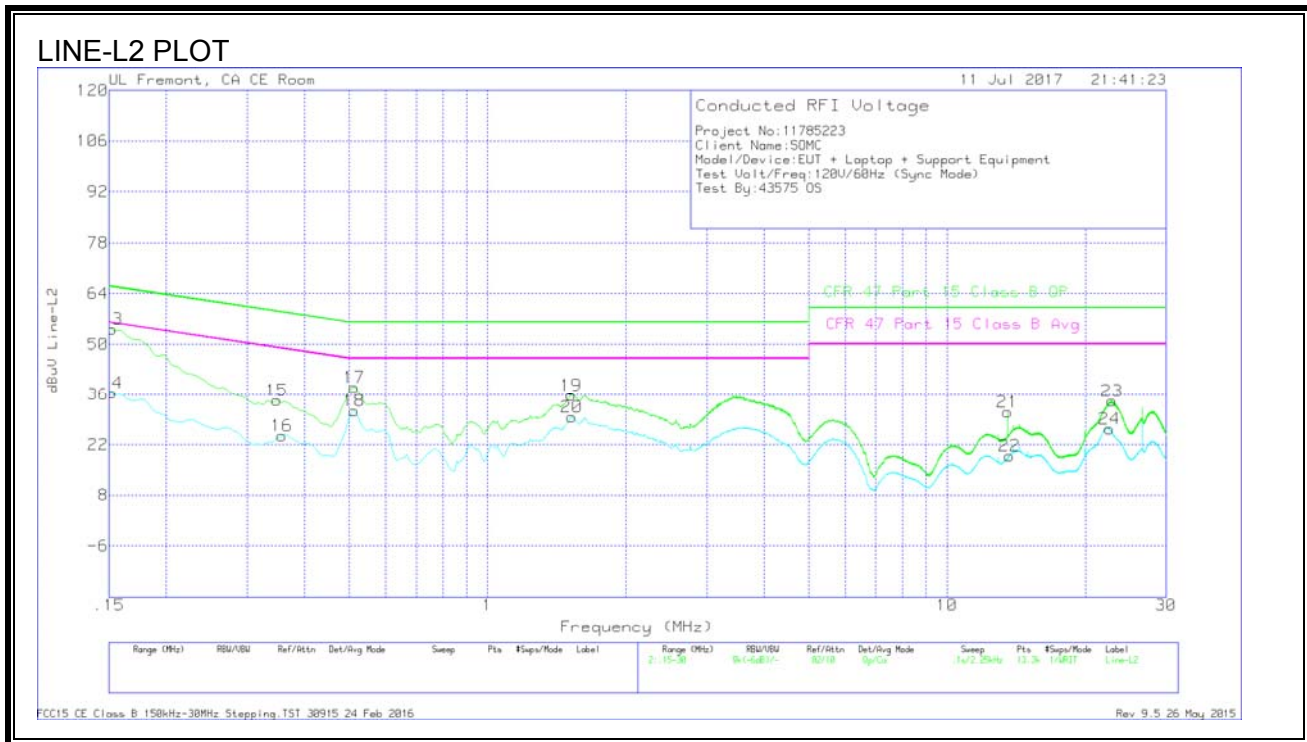

Range 2: Line-L2 .15 - 30MHz

Marker	Frequency (MHz)	Meter Reading (dBuV)	Det	LISN L2	LC Cables C2&C3	Limiter (dB)	Corrected Reading dBuV	CFR 47 Part 15 Class B QP	QP Margin (dB)	CFR 47 Part 15 Class B Avg	Av(CISPR) Margin (dB)
13	.15225	44.06	Qp	0	0	10.1	54.16	65.88	-11.72	-	-
14	.15225	26.32	Ca	0	0	10.1	36.42	-	-	55.88	-19.46
15	.348	24.21	Qp	0	.1	10.1	34.41	59.01	-24.6	-	-
16	.357	14.18	Ca	0	.1	10.1	24.38	-	-	48.8	-24.42
17	.51225	27.74	Qp	0	.1	10.1	37.94	56	-18.06	-	-
18	.51225	21.22	Ca	0	.1	10.1	31.42	-	-	46	-14.58
19	1.52025	25.62	Qp	0	.1	10.1	35.82	56	-20.18	-	-
20	1.527	19.53	Ca	0	.1	10.1	29.73	-	-	46	-16.27
21	13.56	20.49	Qp	.1	.2	10.2	30.99	60	-29.01	-	-
22	13.668	8.34	Ca	.1	.2	10.2	18.84	-	-	50	-31.16
23	22.89075	23.41	Qp	0	.3	10.4	34.11	60	-25.89	-	-
24	22.56675	15.61	Ca	0	.3	10.4	26.31	-	-	50	-23.69

Qp - Quasi-Peak detector
 Ca - CISPR average detection

6.3.2. RESULTS- CHARGING MODE

6 WORST EMISSIONS

Line-L1 .15 - 30MHz

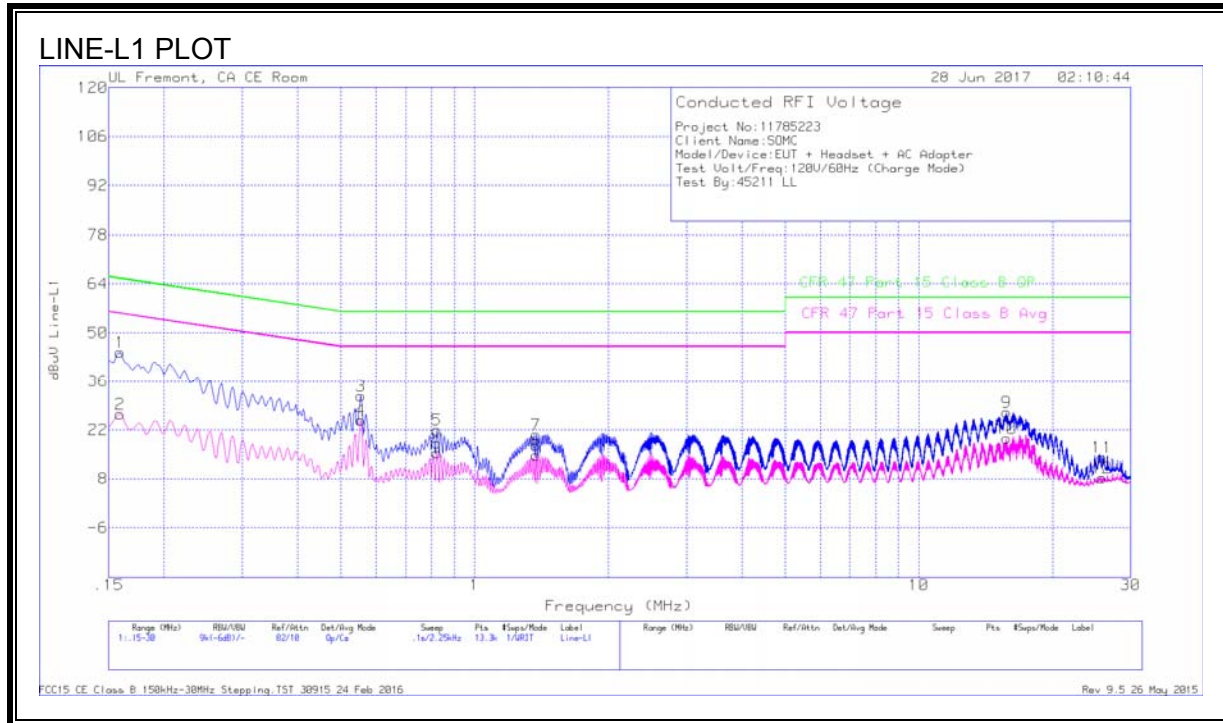

Range 1: Line-L1 .15 - 30MHz

Marker	Frequency (MHz)	Meter Reading (dBuV)	Det	LISN L1	LC Cables C1&C3	Limiter (dB)	Corrected Reading dBuV	CFR 47 Part 15 Class B QP	QP Margin (dB)	CFR 47 Part 15 Class B Avg	Av(CISPR) Margin (dB)
1	.159	34.17	Qp	.1	.1	10.1	44.47	65.52	-21.05	-	-
2	.159	16.3	Ca	.1	.1	10.1	26.6	-	-	55.52	-28.92
3	.555	21.47	Qp	0	.1	10.1	31.67	56	-24.33	-	-
4	.555	14.55	Ca	0	.1	10.1	24.75	-	-	46	-21.25
5	.82275	11.73	Qp	0	.1	10.1	21.93	56	-34.07	-	-
6	.82275	5.25	Ca	0	.1	10.1	15.45	-	-	46	-30.55
7	1.37625	10.38	Qp	0	.1	10.1	20.58	56	-35.42	-	-
8	1.37625	4.48	Ca	0	.1	10.1	14.68	-	-	46	-31.32
9	15.75825	16.61	Qp	0	.2	10.3	27.11	60	-32.89	-	-
10	15.75825	9.16	Ca	0	.2	10.3	19.66	-	-	50	-30.34
11	25.881	3.37	Qp	.1	.3	10.5	14.27	60	-45.73	-	-
12	25.881	-2.55	Ca	.1	.3	10.5	8.35	-	-	50	-41.65

Qp - Quasi-Peak detector
 Ca - CISPR average detection

Line-L2 .15 - 30MHz

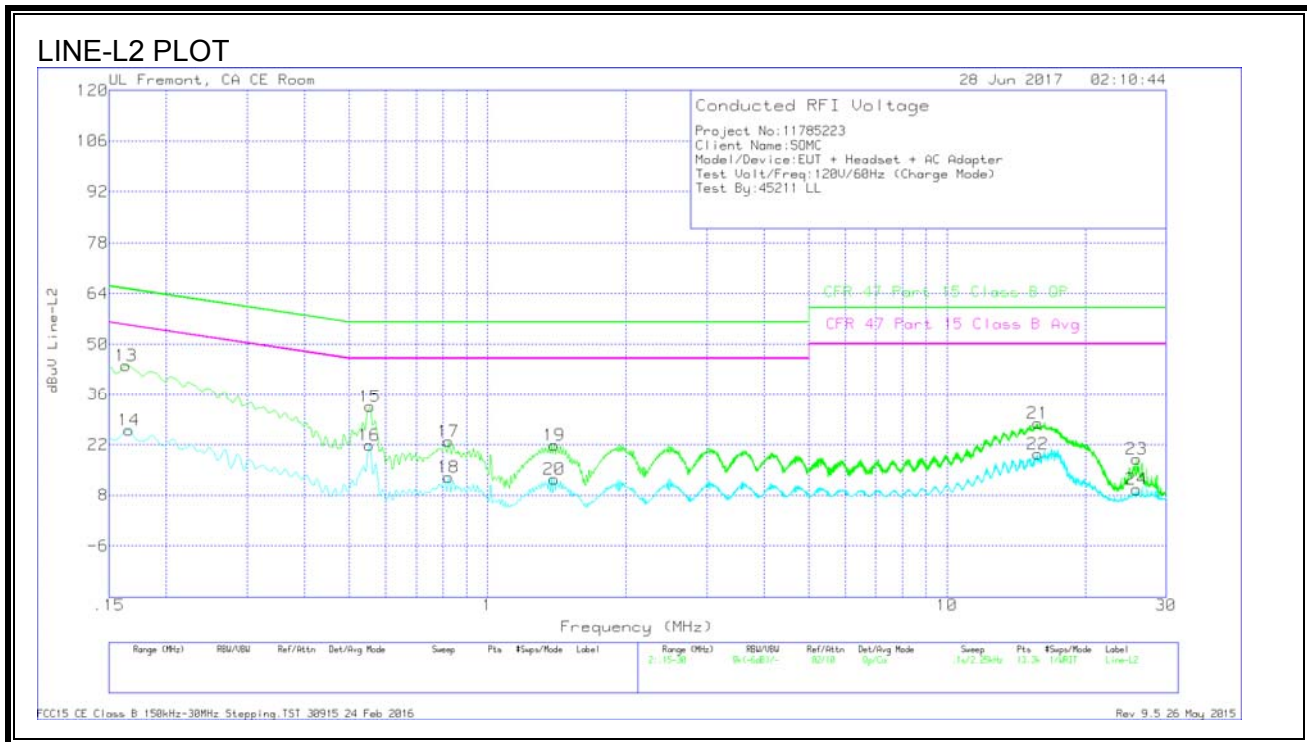

Range 2: Line-L2 .15 - 30MHz

Marker	Frequency (MHz)	Meter Reading (dBuV)	Det	LISN L2	LC Cables C2&C3	Limiter (dB)	Corrected Reading dBuV	CFR 47 Part 15 Class B QP	QP Margin (dB)	CFR 47 Part 15 Class B Avg	Av(CISPR) Margin (dB)
13	.1635	33.85	Qp	0	.1	10.1	44.05	65.28	-21.23	-	-
14	.16575	15.84	Ca	0	0	10.1	25.94	-	-	55.17	-29.23
15	.555	22.34	Qp	0	.1	10.1	32.54	56	-23.46	-	-
16	.55275	11.64	Ca	0	.1	10.1	21.84	-	-	46	-24.16
17	.82275	12.61	Qp	0	.1	10.1	22.81	56	-33.19	-	-
18	.82275	2.76	Ca	0	.1	10.1	12.96	-	-	46	-33.04
19	1.3965	11.59	Qp	0	.1	10.1	21.79	56	-34.21	-	-
20	1.3965	2.21	Ca	0	.1	10.1	12.41	-	-	46	-33.59
21	15.75825	17.49	Qp	0	.2	10.3	27.99	60	-32.01	-	-
22	15.75825	8.83	Ca	0	.2	10.3	19.33	-	-	50	-30.67
23	25.87875	7.11	Qp	.1	.3	10.5	18.01	60	-41.99	-	-
24	25.87875	-1.31	Ca	.1	.3	10.5	9.59	-	-	50	-40.41

Qp - Quasi-Peak detector
 Ca - CISPR average detection