



UL LLC
12 Laboratory Dr.
Research Triangle Park, NC
27709

www.ul.com/emc
(919) 549-1400

Report Number: 16J23633-E8V2
Project Number: 16J23633
Date: 8/17/2016
FCC ID: PY7-29752M

Electromagnetic Compatibility Test Report

For

**SONY MOBILE COMMUNICATIONS, INC.
4-12-3 HIGASHI-SHINAGAWA,
SHINAGAWA -KU, TOKYO, 140-0002, JAPAN**

Copyright © 2016 UL LLC

UL LLC authorizes the above-named company to reproduce this Report provided it is reproduced in its entirety.

Project Number: 16J23633-E8V2
FCC ID: PY7-29752M
Client Name: SOMC

Page 2 of 35

Issued: 8/17/2016

Test Report Details

Tests Performed By: **UL LLC**
12 Laboratory Dr.
Research Triangle Park, NC 27709

Tests Performed For: **Sony Mobile Communications, Inc.**
4-12-3 HIGASHI-SHINAGAWA,
SHINAGAWA -KU,TOKYO, 140-0002, JAPAN

Test Report Date: **8/16/2016**

Product Type: **GSM/WCDMA/LTE Phone with BT, BLE, DTS/UNII a/b/g/n/ac & NFC**

Product standards **CFR 47 FCC Part 15 Subpart B: 2015**

FCC ID: **PY7-29752M**

Sample Serial Number: **CB512AP84D**

EUT Category: **ITE**

Testing Start Date: **2016-07-27**

Date Testing Complete: **2016-08-16**

Overall Results: Compliant

UL LLC reports apply only to the specific samples tested under stated test conditions. All samples tested were in good operating condition throughout the entire test program. It is the manufacturer's responsibility to assure that additional production units of this model are manufactured with identical electrical and mechanical components. UL LLC shall have no liability for any deductions, inferences or generalizations drawn by the client or others from UL LLC issued reports. This report must not be used by the client to claim product certification, approval, or endorsement by NVLAP, NIST, any agency of the Federal Government, or any agency of any government.

This report may contain test results that are not covered by the NVLAP or A2LA accreditation. The scope of accreditation is limited to the specific tests that are listed on the NVLAP and/or A2LA websites referenced at the end of this report.

Report Directory

1.0	GENERAL - Product Description.....	4
1.1	Equipment Description	4
1.2	Equipment Marking Plate	4
1.3	Device Configuration During Test	5
1.3.1	Equipment Used During Test:.....	5
1.3.2	Input/Output Ports:.....	6
1.3.3	EUT Internal Operating Frequencies:	6
1.3.4	Power Interface:.....	6
1.4	Block Diagram:.....	7
1.5	EUT Configurations	9
1.6	EUT Operation Modes	9
1.7	Rational for EUT Configuration	9
2.0	Summary	10
2.1	Deviations from standard test methods	10
2.2	Device Modifications Necessary for Compliance	10
2.3	Reference Standards	11
2.4	Results Summary	11
3.0	Calibration of Equipment Used for Measurement	12
4.0	EMISSIONS TEST RESULTS.....	12
4.1	Test Conditions and Results – MAINS TERMINAL – CONDUCTED EMISSIONS	13
4.2	Test Conditions and Results – RADIATED EMISSIONS.....	21
Appendix A	35
	Accreditations and Authorizations	35

Report Revision History

Revision Date	Description	Revised By	Revision Reviewed By
2016-08-17	AC line conducted performed in sync mode with ENET connected to laptop.	B. Kiewra	J. Moser

1.0 GENERAL - Product Description

1.1 Equipment Description

GSM/WCDMA/LTE Phone with BT, BLE, DTS/UNII a/b/g/n/ac & NFC

1.2 Equipment Marking Plate

None

1.3 Device Configuration During Test

1.3.1 Equipment Used During Test:

Use	Product Type	Manufacturer	Model	Comments
EUT	Phone	Sony Mobile Communication	FCC ID: PY7-PM0940	SN - 2312492
AE	Laptop	Lenovo	T450	TYPE 20BU-S04K00 S/N PC-0A2UQU 16/01
AE	AC Adapter	Lenovo	ADLX65NCC2A	SN's: 11S45N0263Z1ZS995256HR 11S36200284ZZ1005255WE
AE	Mouse	Logitech	B100	M/N: M-U0026 P/N: 810-002149 S/N: 1451HS05PWZ8
AE	Keyboard	Logitech	Internet 350 Keyboard	M/N: Y-US76A P/N: 820-000172 PID: SC70812
Note1: EUT - Equipment Under Test, AE - Auxiliary/Associated Equipment, or SIM - Simulator (Not Subjected to Test)				
Note 2: Laptop Ethernet was plugged into facility wall jack that was connected to facility switch, running ping session.				

1.3.2 Input/Output Ports:

I/O Cable List						
Cable No	Port	# of identical ports	Connector Type	Cable Type	Cable Length (m)	Remarks
1	DC Power	2	Power	Shielded	1.2m	N/A
2	Audio	1	Mini-Jack	Unshielded	1m	N/A
3	USB	1	Mini-USB	Shielded	0.9 m	UCB16 cable from EUT to Laptop
3	USB	2	USB	Shielded	2m	From laptop to keyboard & mouse
4	AC Power	2	IEC	Unshielded	1m	N/A
5	Ethernet	1	RJ45	Unshielded	2m	N/A

1.3.3 EUT Internal Operating Frequencies:

Frequency (MHz)	Description
5825	Highest Channel in 5.8G Band.

1.3.4 Power Interface:

Mode # /Rated	Voltage (V)	Current (A)	Power (W)	Frequency (DC/AC-Hz)	Phases (#)	Comments
Rated	100-240	-	-	50-60	1	NA
1	120	-	-	60	1	NA

1.4 Block Diagram:

The diagram below illustrates the configuration of the equipment above.

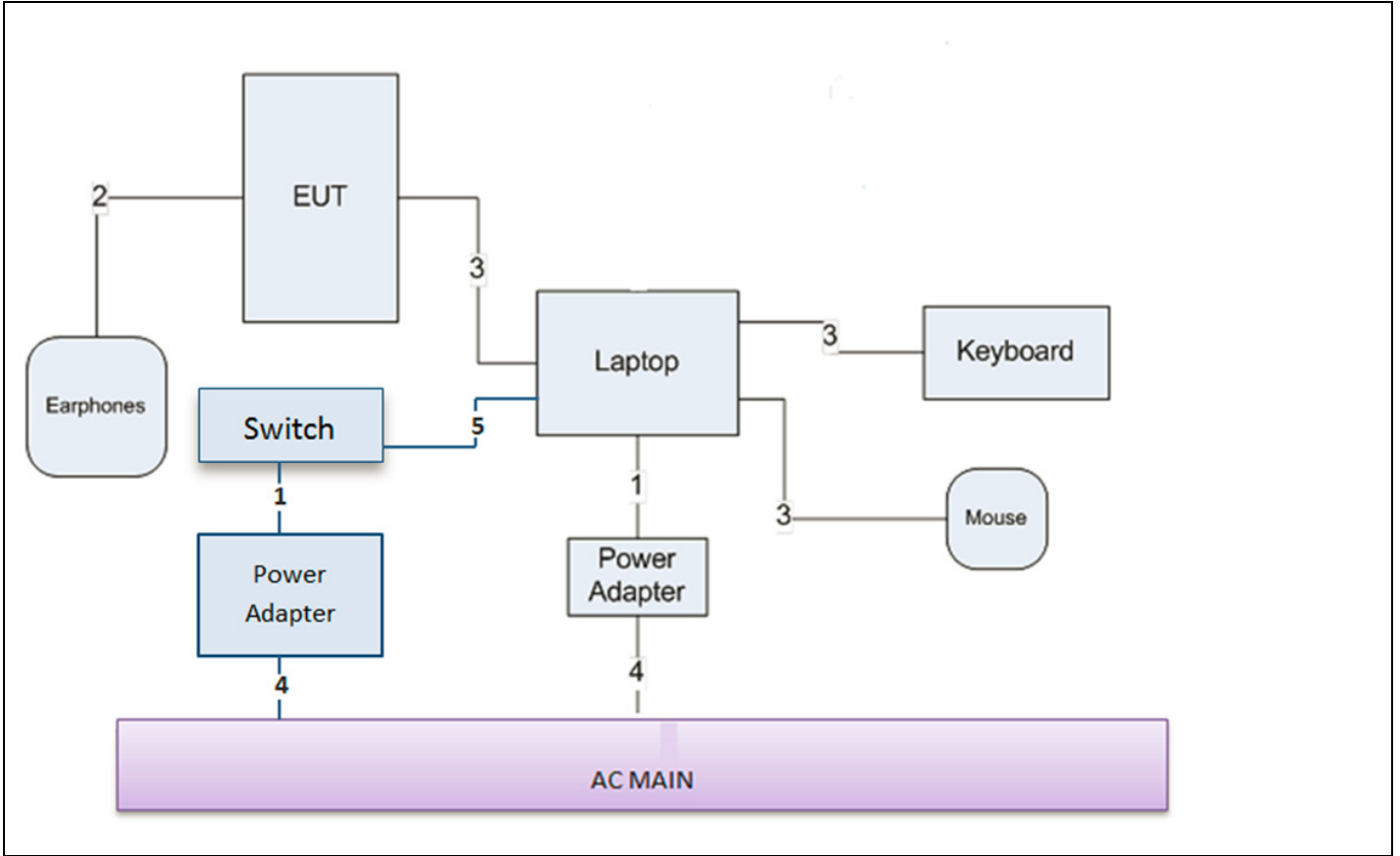

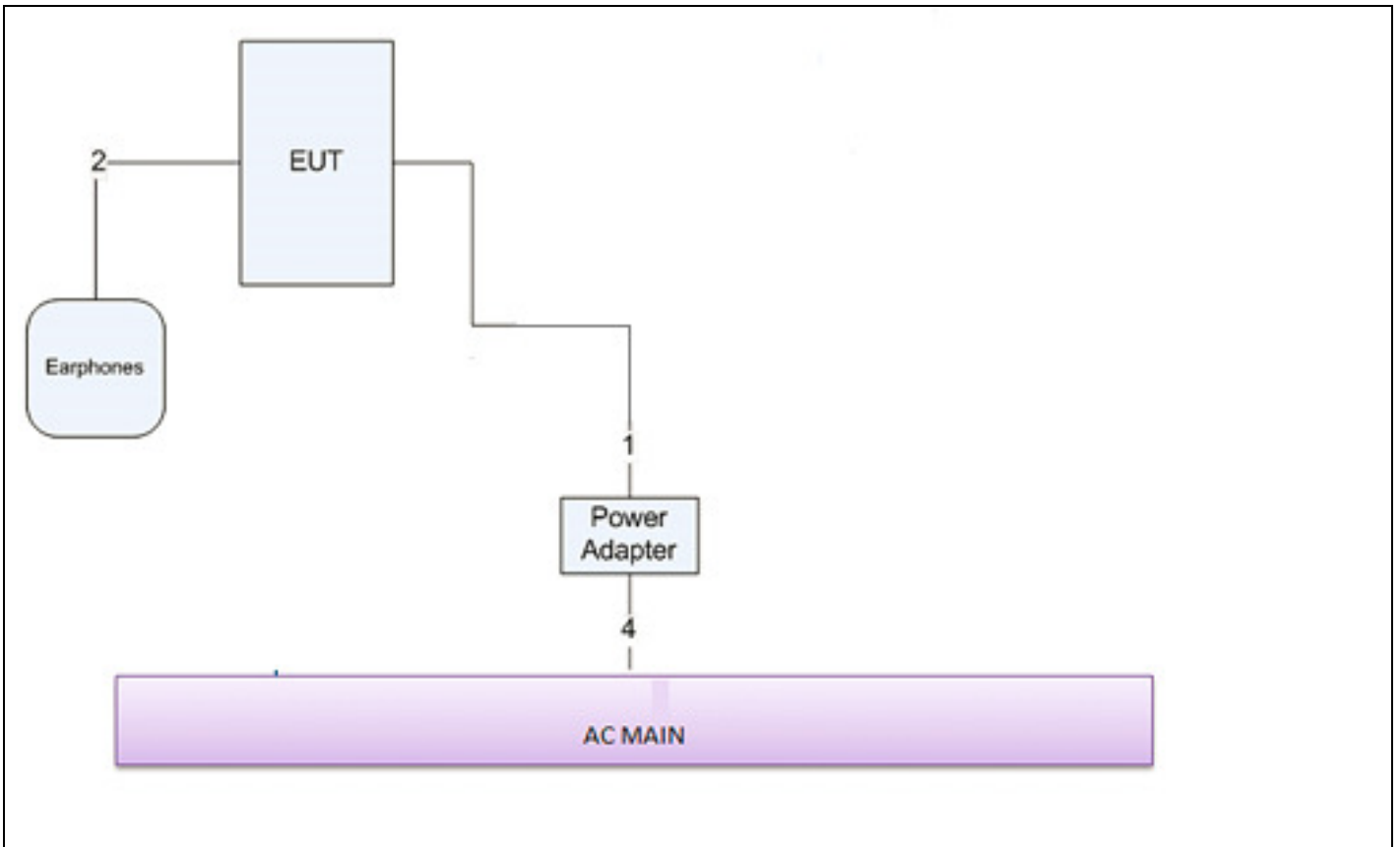

1.5 EUT Configurations

Mode #	Description
1	Charging - The EUT was configured as table top equipment. The EUT is installed in a typical configuration. The EUT is connected to an AC adapter for charging and in a functional mode.
2	Laptop Sync Mode - The EUT was configured as table top equipment. The EUT is installed in a typical configuration. The EUT is connected to a laptop via USB, is charging and transferring data via the laptop.

1.6 EUT Operation Modes

Mode #	Description
1	Test software exercised the EUT.

1.7 Rational for EUT Configuration

Mode #	Description
1	The selected EUT configuration was chosen to maximize emissions

2.0 Summary

The tests listed in the Summary of Testing section of this report have been performed and the results recorded by UL LLC in accordance with the procedures stated in each test requirement and specification. The applicant determined the list of tests performed were applicable to the Equipment Under Test. As a result, the subject product has been verified to comply or not comply as noted in the Summary of Testing with each test specification. The test results relate only to the items tested.

2.1 Deviations from standard test methods

None

2.2 Device Modifications Necessary for Compliance

None

2.3 Reference Standards

Standard Number	Standard Name	Standard Date
47 CFR Part 15, Subpart B	Radio Frequency Devices – Unintentional Radiators	2015

2.4 Results Summary

This product is considered Class B.

Requirement – Test	Result (Compliant / Non-Compliant)*
Conducted Emissions - Mains	Compliant
Radiated Emissions	Compliant

Test Engineer:



Brian Kiewra
EMC Engineer
UL – Consumer Technology Division

Reviewer:



Jeff Moser
EMC Program Manager
UL – Consumer Technology Division

Any information and documentation involving UL Mark services are provided on behalf of UL LLC (UL) or any authorized licensee of UL.

3.0 Calibration of Equipment Used for Measurement

All test equipment and test accessories are calibrated on a regular basis. The maximum time between calibrations is one year or the manufacturers' recommendation, whichever is less.

All test equipment calibrations are traceable to the National Institute of Standards and Technology (NIST); therefore, all test data recorded in this report is traceable to NIST.

4.0 EMISSIONS TEST RESULTS

The emissions tests were performed according to following regulations:

----- United States -----

Code of Federal Regulations Title 47	Part 15, Subpart B, Radio Frequency Devices
--------------------------------------	---

Unless specified otherwise in the individual Methods, the tests shall be conducted under the following ambient conditions. Confirmation of these conditions shall be verified at the time the test is conducted.

Ambient Temperature, °C	22.5 ± 2.5	Relative Humidity, %	45 ± 15	Barometric Pressure, mBar	950 ± 150
-------------------------	------------	----------------------	---------	---------------------------	-----------

Measurement Uncertainty (Check here:

Test	Uncertainty
Conducted Emissions (0.150-30MHz)	+/- 3.65dB
Radiated Emissions (30-1000 MHz)	+/- 5.36dB
Radiated Emissions (1-40 GHz)	+/- 5.24dB

Note – The above values represent worst-case for each frequency range.

Sample Calculations

Radiated Field Strength and Conducted Emissions data contained within this report is calculated on the following basis:

$$\begin{aligned} \text{Field Strength (dBuV/m)} &= \text{Meter Reading (dBuV)} + \text{AF (dB/m)} - \text{Gain (dB)} + \text{Cable Loss (dB)} \\ \text{Conducted Voltage (dBuV)} &= \text{Meter Reading (dBuV)} + \text{Cable Loss (dB)} + \text{LISN IL (dB)} \\ \text{Conducted Current (dBuA)} &= \text{Meter Reading (dBuV)} + \text{Cable Loss (dB)} - \text{Transducer Factor (dBohms)} \end{aligned}$$

4.1 Test Conditions and Results – MAINS TERMINAL – CONDUCTED EMISSIONS

Test Description	Measurements were made on a ground plane. All power was connected to the system through Artificial Mains Network (AMN). Conducted voltage measurements on mains lines were made at the output of the AMN.	
Basic Standard	FCC Part 15, Subparts A & B in conjunction with ANSI C63.4:2014	
UL LPG	80-EM-S0026	
	Frequency range on each side of line	Measurement Point
Fully configured sample scanned over the following frequency range	150kHz to 30MHz	Mains
Limits - Class B		
Frequency (MHz)	Limit (dB μ V)	
	Quasi-Peak	Average
0.15-0.5	66 to 56	56 to 46
0.5-5	56	46
5-30	60	50
Supplementary information: None		

Table 1 Conducted Emissions EUT Configuration Settings

Power Interface Mode #	EUT Configurations Mode #	EUT Operation Mode #
1 (120V)	1 (Charging) 2 (Sync)	1
Supplementary information: None		

Table 2 Conducted Emissions Test Equipment

Test Equipment Used - Line-Conducted Emissions – Voltage (Morrisville – Conducted 1)

Equipment ID	Description	Manufacturer	Model Number	Last Cal.	Next Cal.
CBL077	Coax cable, RG223, N-male to BNC-male, 20-ft.	Pasternack	PE3476-240	2016-06-15	2017-06-30
LISN003	LISN, 50-ohm/50-uH, 2-conductor, 25A	Fischer Custom Com.	FCC-LISN-50-25-2-01-550V	2015-08-24	2016-08-31
LISN008	LISN, 50-ohm/50-uH, 2-conductor, 25A (For support gear only.)	Solar Electronics	8012-50-R-24-BNC	2015-09-03	2016-09-30
MM0167	Multi-meter	Agilent	U1232A	2015-08-17	2016-08-31
PRE0101521 (75141)	EMI Test Receiver 9kHz-7GHz	Rohde & Schwarz	ESCI 7	2015-08-26	2016-08-31
TL001	Transient Limiter, 0.009-30MHz	Com-Power	LIT-930A	2016-06-09	2017-06-30
PS214	AC Power Source	Elgar	CW2501M (s/n 1523A02396)	NA	NA
PS215	AC Power Source	Elgar	CW2501M (s/n 1523A02397)	NA	NA
SOFTEMI	EMI Software	UL	Version 9.5	NA	NA
	Miscellaneous (if needed)				
HI0078	Temp/Humid/Pressure Meter	Springfield Precision	PreciseTemp	2016-06-13	2017-06-13
ATA220	ISN for Unshielded Balanced Pairs	Teseq, Inc.	ISN T8	2015-08-24	2016-08-31
TN0129	ISN for Shielded Balanced Pairs	Teseq, Inc.	ISN ST08	2015-08-24	2016-08-31
TN0145	ISN for Cat-6 Unshielded Balanced Pairs	Teseq, Inc.	ISN T8-Cat6	2015-08-25	2016-08-31
CDECABLE001	ANSI C63.4 1m extension cable.	UL	Per Annex B of ANSI C63.4	2016-06-04	2017-06-30

Figure 3 Conducted Emissions Graph – Line 1 Charging

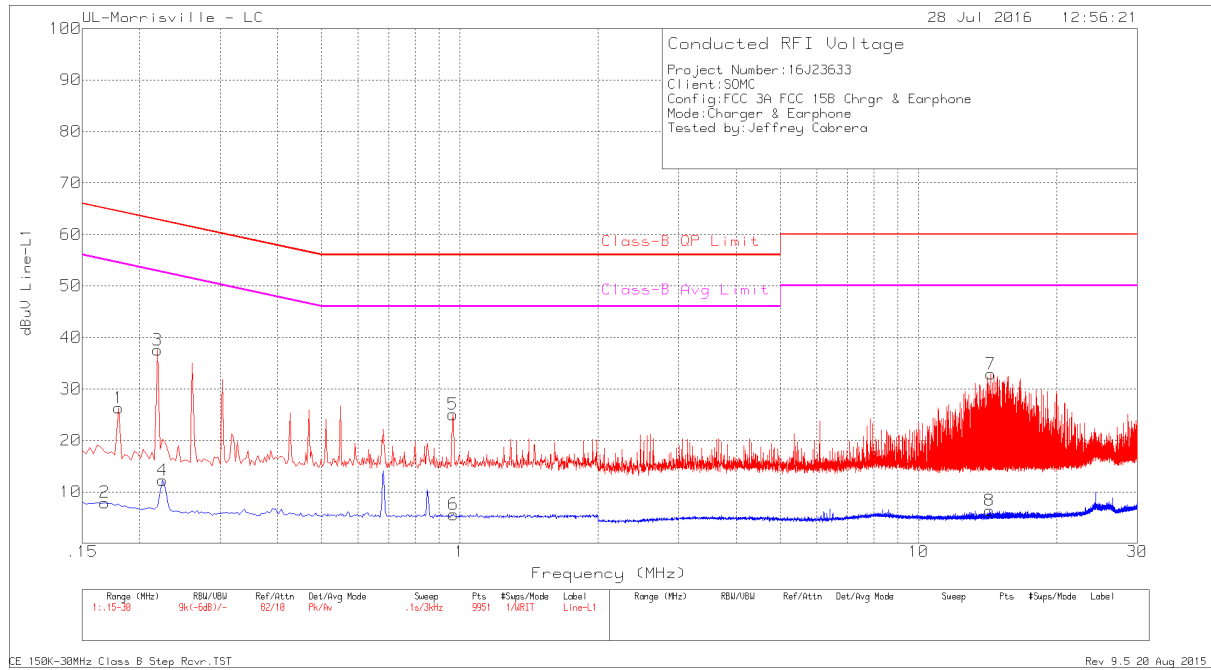

Table 3 Conducted Emissions Data Points – Line 1 Charging

Range 1: Line-L1 .15 - 30MHz										
Marker	Frequency (MHz)	Meter Reading (dBuV)	Det	LISN VCF [dB]	Cbl/Limiter (dB)	Corrected Reading dBuV	Class-B QP Limit	Margin (dB)	Class-B Avg Limit	Margin (dB)
1	.18	16.11	Pk	.2	10	26.31	64.49	-38.18	-	-
2	.168	-2.29	Av	.2	10	7.91	-	-	55.06	-47.15
3	.219	27.44	Pk	.1	10	37.54	62.86	-25.32	-	-
4	.225	2.12	Av	.1	10	12.22	-	-	52.63	-40.41
5	.966	15.04	Pk	0	10	25.04	56	-30.96	-	-
6	.969	-4.39	Av	0	10	5.61	-	-	46	-40.39
7	14.388	22.28	Pk	.2	10.4	32.88	60	-27.12	-	-
8	14.304	-4.22	Av	.2	10.4	6.38	-	-	50	-43.62

Pk - Peak detector
 Av - Average detection

Figure 4 Conducted Emissions Graph – Line 2 Charging

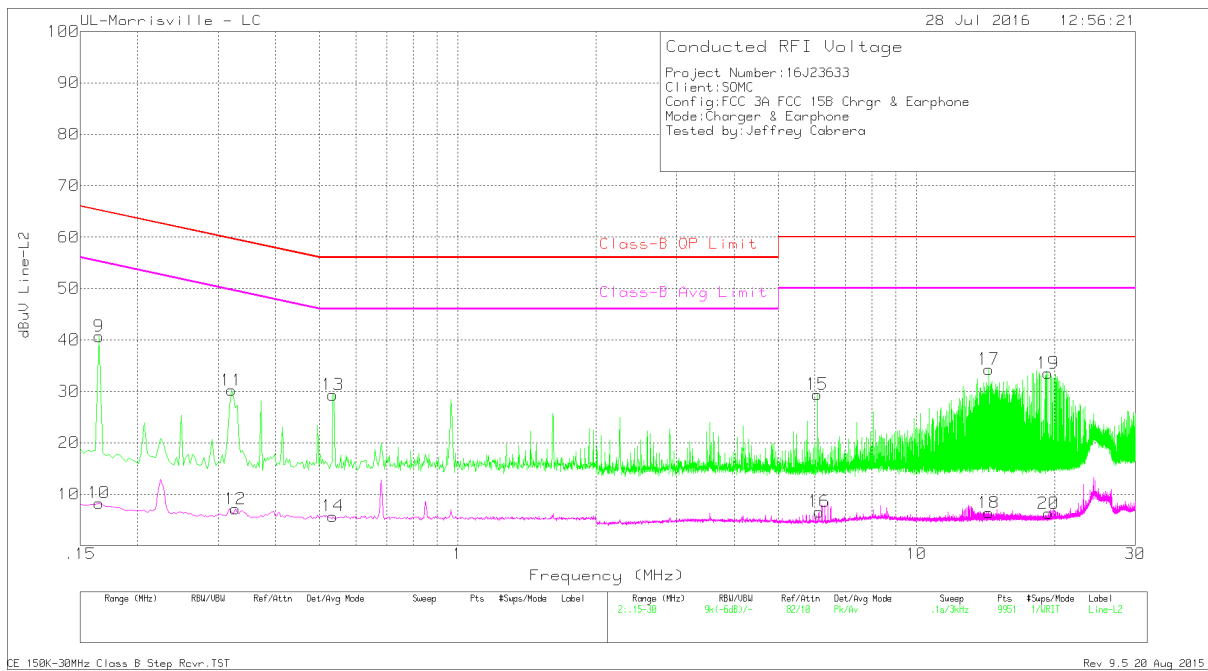

Table 4 Conducted Emissions Data Points – Line 2 Charging

Range 2: Line-L2 .15 - 30MHz										
Marker	Frequency (MHz)	Meter Reading (dBuV)	Det	LISN VCF [dB]	Cbl/Limiter (dB)	Corrected Reading dBuV	Class-B QP Limit	Margin (dB)	Class-B Avg Limit	Margin (dB)
9	.165	30.48	Pk	.2	10	40.68	65.21	-24.53	-	-
10	.165	-1.92	Av	.2	10	8.28	-	-	55.21	-46.93
11	.321	20.08	Pk	.1	10	30.18	59.68	-29.5	-	-
12	.327	-2.99	Av	.1	10	7.11	-	-	49.53	-42.42
13	.534	19.31	Pk	0	10	29.31	56	-26.69	-	-
14	.534	-4.29	Av	0	10	5.71	-	-	46	-40.29
15	6.075	19.08	Pk	.1	10.2	29.38	60	-30.62	-	-
16	6.129	-3.73	Av	.1	10.2	6.57	-	-	50	-43.43
17	14.367	23.77	Pk	.1	10.4	34.27	60	-25.73	-	-
18	14.367	-4.1	Av	.1	10.4	6.4	-	-	50	-43.6
19	19.362	22.83	Pk	.2	10.5	33.53	60	-26.47	-	-
20	19.413	-4.43	Av	.2	10.5	6.27	-	-	50	-43.73

Pk - Peak detector
 Av - Average detection

Figure 5 Conducted Emissions Graph – Line 1 Sync Mode (Laptop)

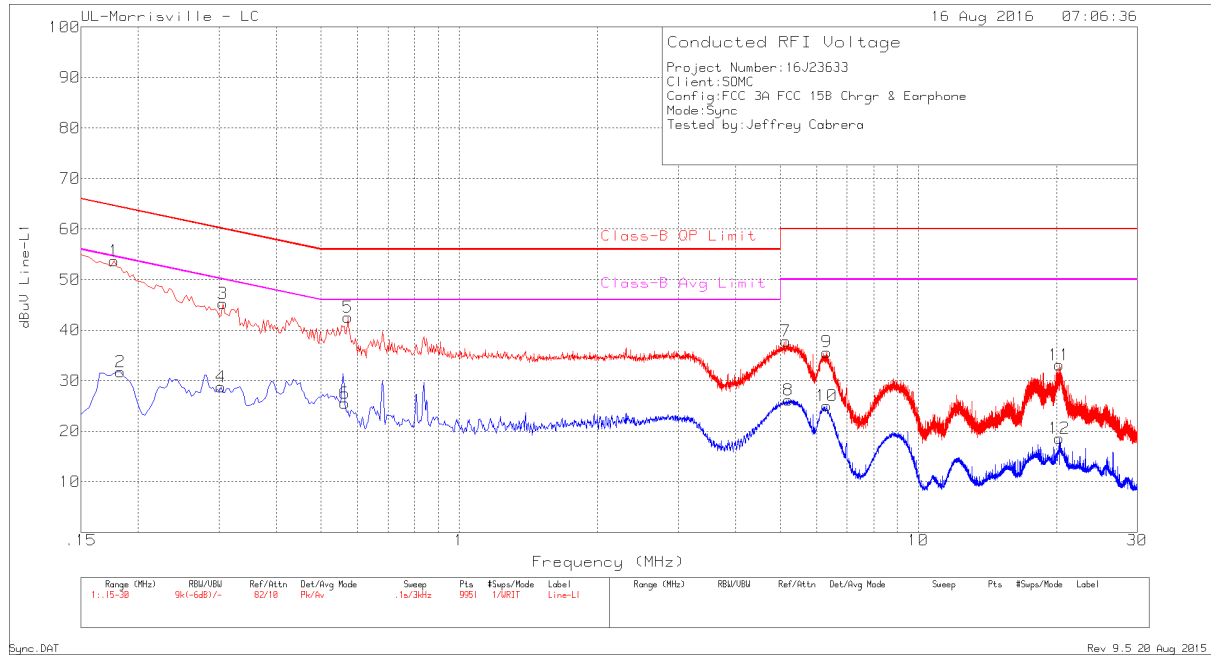

Table 5 Conducted Emissions Data Points – Line 1 Sync Mode (Laptop)

Range 1: Line-L1 .15 - 30MHz										
Marker	Frequency (MHz)	Meter Reading (dBuV)	Det	LISN VCF [dB]	Cbl/Limiter (dB)	Corrected Reading dBuV	Class-B QP Limit	Margin (dB)	Class-B Avg Limit	Margin (dB)
1	.177	43.54	Pk	.2	10	53.74	64.63	-10.89	-	-
2	.183	21.54	Av	.2	10	31.74	-	-	54.35	-22.61
3	.306	35.22	Pk	.1	10	45.32	60.08	-14.76	-	-
4	.303	18.71	Av	.1	10	28.81	-	-	50.16	-21.35
5	.573	32.41	Pk	.1	10	42.51	56	-13.49	-	-
6	.564	15.48	Av	.1	10	25.58	-	-	46	-20.42
7	5.145	27.58	Pk	.1	10.2	37.88	60	-22.12	-	-
8	5.208	15.88	Av	.1	10.2	26.18	-	-	50	-23.82
9	6.327	25.36	Pk	.1	10.2	35.66	60	-24.34	-	-
10	6.324	14.8	Av	.1	10.2	25.1	-	-	50	-24.9
11	20.268	22.22	Pk	.3	10.6	33.12	60	-26.88	-	-
12	20.259	7.67	Av	.3	10.6	18.57	-	-	50	-31.43

Pk - Peak detector
 Av - Average detection

Figure 6 Conducted Emissions Graph – Line 2 Sync Mode (Laptop)

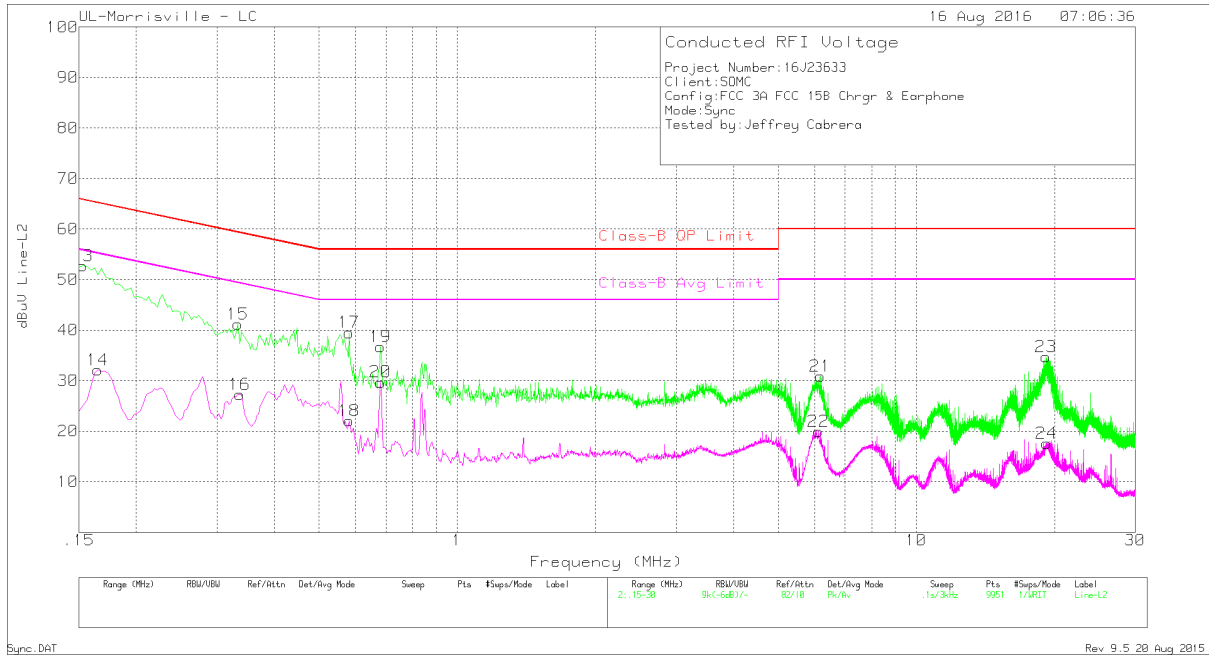

Table 6 Conducted Emissions Data Points – Line 2 Sync Mode (Laptop)

Range 2: Line-L2 .15 - 30MHz										
Marker	Frequency (MHz)	Meter Reading (dBuV)	Det	LISN VCF [dB]	Cbi/Limiter (dB)	Corrected Reading dBuV	Class-B QP Limit	Margin (dB)	Class-B Avg Limit	Margin (dB)
13	.153	42.51	Pk	.2	10	52.71	65.84	-13.13	-	-
14	.165	21.96	Av	.2	10	32.16	-	-	55.21	-23.05
15	.333	31.05	Pk	.1	10	41.15	59.38	-18.23	-	-
16	.336	17.23	Av	.1	10	27.33	-	-	49.3	-21.97
17	.582	29.51	Pk	0	10	39.51	56	-16.49	-	-
18	.582	12.08	Av	0	10	22.08	-	-	46	-23.92
19	.681	26.72	Pk	0	10	36.72	56	-19.28	-	-
20	.681	19.7	Av	0	10	29.7	-	-	46	-16.3
21	6.183	20.54	Pk	.1	10.2	30.84	60	-29.16	-	-
22	6.132	9.68	Av	.1	10.2	19.98	-	-	50	-30.02
23	19.152	23.99	Pk	.2	10.5	34.69	60	-25.31	-	-
24	19.239	6.89	Av	.2	10.5	17.59	-	-	50	-32.41

Pk - Peak detector
 Av - Average detection

4.2 Test Conditions and Results – RADIATED EMISSIONS

Test Description	Measurements were made in a 10-meter semi-anechoic chamber that complies to CISPR 16/ANSI C63.4. Preliminary (peak) measurements were performed at an antenna to EUT separation distance of 10-meter. The EUT was rotated 360° about its azimuth with the receive antenna located at various heights in both horizontal and vertical polarities. Final measurements (quasi-peak or average as noted) were then performed by rotating the EUT 360° and adjusting the receive antenna height from 1 to 4-meters. All frequencies were investigated in both horizontal and vertical antenna polarity, where applicable.	
Basic Standard	FCC Part 15, Subparts A & B in conjunction with ANSI C63.4:2003	
UL LPG	80-EM-S0029	
	Frequency range	Measurement Point
Fully configured sample scanned over the following frequency range	30MHz – 1GHz	3 meter – Class B
	1-18 GHz	3 meter
	18-40 GHz	3 meter
Limits - Class B		
Frequency (MHz)	Limit (dBµV/m)	
	Quasi-Peak	Average
30-88	40	NA
88-216	43.5	NA
216-960	46	NA
960-1000	54	NA
1,000-18,000	NA	54
18,000-40,000	NA	54

Table 7 Radiated Emissions EUT Configuration Settings

Power Interface Mode #	EUT Configurations Mode #	EUT Operation Mode #
1 (120V)	1 (Charging) 2 (Sync)	1
Supplementary information: None		

Table 8 Radiated Emissions Test Equipment

Test Equipment Used - Radiated Disturbance Emissions Test Equipment (Morrisville - South Chamber)

Equip. ID	Description	Manufacturer	Model Number	Last Cal.	Next Cal.
	0.009-30MHz	(Loop Ant.)			
AT0079	Active Loop Antenna	ETS-Lindgren	6502	2015-12-08	2016-12-31
	30-1000 MHz				
AT0074	Hybrid Broadband Antenna	Sunol Sciences Corp.	JB3	2016-06-07	2017-06-30
	1-18 GHz				
AT0069	Double-Ridged Waveguide Horn Antenna, 1 to 18 GHz	ETS Lindgren	3117	2016-03-07	2017-03-31
	18-40 GHz				
AT0076	Horn Antenna, 18-26.5GHz	ARA	MWH-1826/B	2015-08-27	2016-08-31
AT0077	Horn Antenna, 26-40GHz	ARA	MWH-2640/B	2015-08-27	2016-08-31
	Gain-Loss Chains				
S-SAC01	Gain-loss string: 0.009-30MHz	Various	Various	2015-10-07	2016-10-31
S-SAC02	Gain-loss string: 30-1000MHz	Various	Various	2016-06-26	2017-06-30
S-SAC03	Gain-loss string: 1-18GHz	Various	Various	2015-08-22	2016-08-31
S-SAC04	Gain-loss string: 18-40GHz	Various	Various	2016-02-29	2017-02-28
	Receiver & Software				
SA0025	Spectrum Analyzer	Agilent	N9030A	2016-03-17	2017-03-31
SA0026 (18-40GHz RSE)	Spectrum Analyzer	Agilent	N9030A	2016-02-24	2017-02-28
SOFTEMI	EMI Software	UL	Version 9.5	NA	NA
HI0050	Temp/Humid/Pressure Meter	Cole-Parmer	99760-00	2015-07-01	2016-07-31

Figure 11 Radiated Emissions Graph – 30-1000 MHz Charging

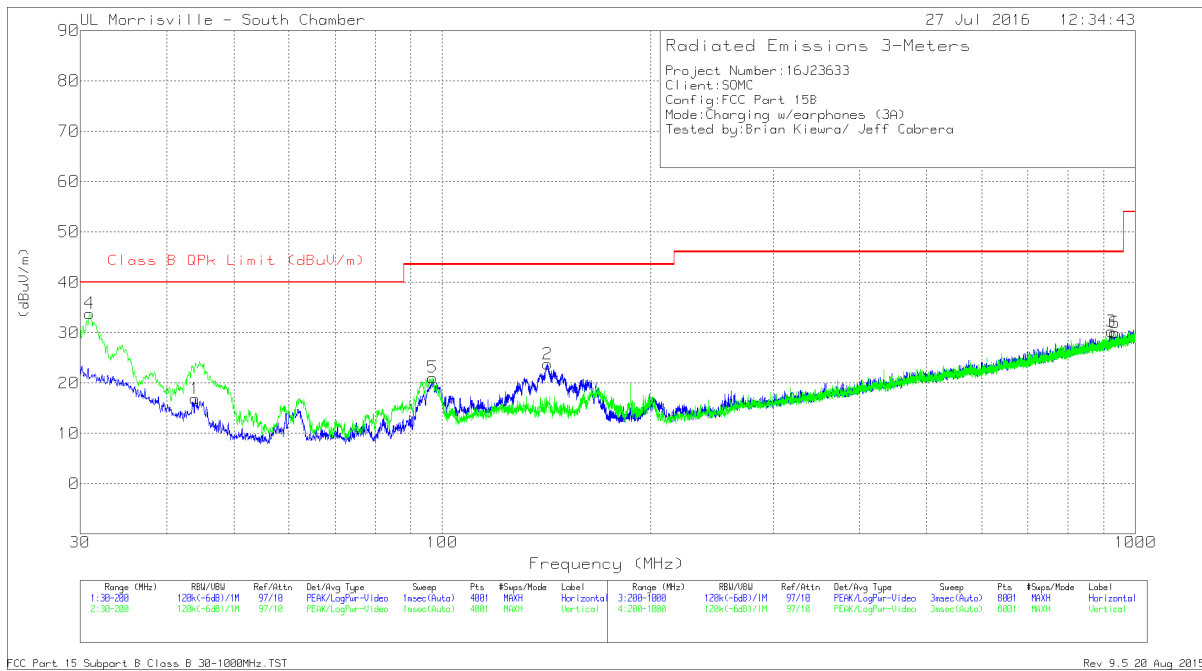

Table 9 Radiated Emissions Data Points - 30-1000 MHz Charging

Marker	Frequency (MHz)	Meter Reading (dBuV)	Det	AT0074 AF (dB/m)	Amp/Cbl (dB)	Corrected Reading (dBuV/m)	Class B QPk Limit (dBuV/m)	Margin (dB)	Azimuth (Degs)	Height (cm)	Polarity
1	43.9825	32.99	Pk	15.5	-31.6	16.89	40	-23.11	0-360	399	H
2	141.86	37.15	Pk	17.3	-30.7	23.75	43.52	-19.77	0-360	199	H
3	924.2	29.98	Pk	27.1	-26.8	30.28	46.02	-15.74	0-360	102	H
4	30.9775	40.41	Pk	25.2	-31.8	33.81	40	-6.19	0-360	102	V
5	96.81	38.78	Pk	13.3	-31	21.08	43.52	-22.44	0-360	102	V
6	934.2	29.42	Pk	27.3	-26.7	30.02	46.02	-16	0-360	299	V

Pk - Peak detector

Figure 12 Radiated Emissions Graph – 30-1000 MHz Sync

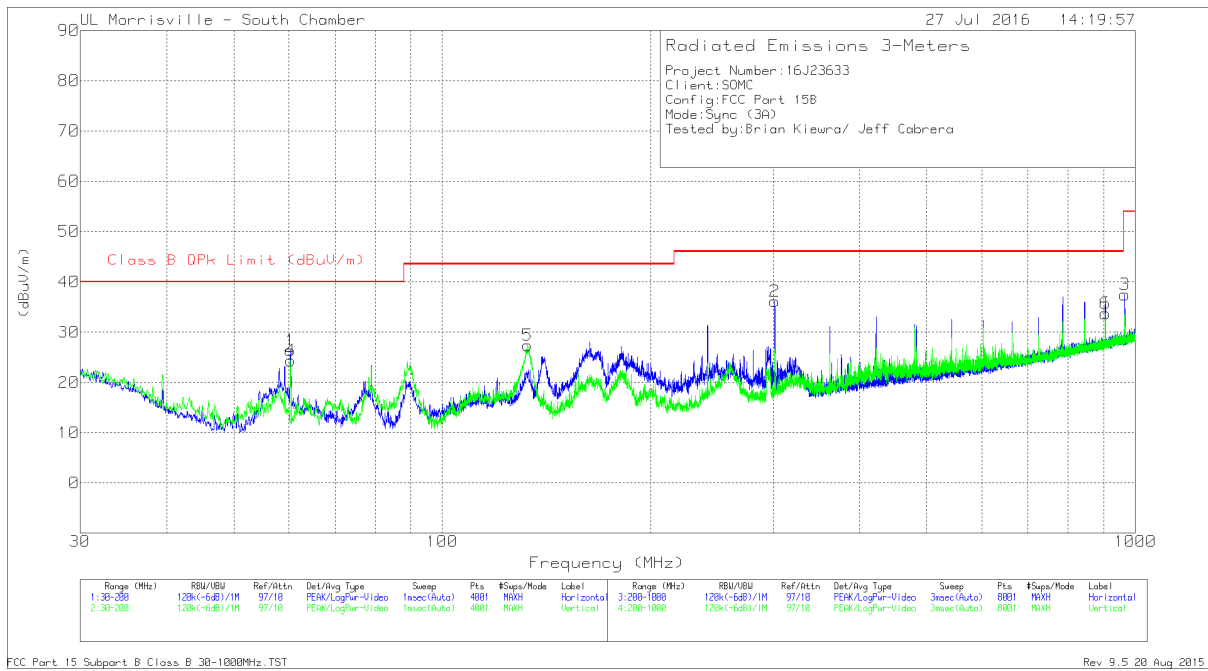

Table 10 Radiated Emissions Data Points - 30-1000 MHz Sync

Marker	Frequency (MHz)	Meter Reading (dBuV)	Det	AT0074 AF (dB/m)	Amp/Cbl (dB)	Corrected Reading (dBuV/m)	Class B QPk Limit (dBuV/m)	Margin (dB)	Azimuth (Degs)	Height (cm)	Polarity
1	60.345	45.88	Pk	11.9	-31.4	26.38	40	-13.62	0-360	400	H
2	301.8	47.64	Pk	18.1	-29.6	36.14	46.02	-9.88	0-360	102	H
3	965.8	36.27	Pk	27.4	-26.2	37.47	53.97	-16.5	0-360	102	H
4	60.3875	43.86	Pk	11.9	-31.4	24.36	40	-15.64	0-360	102	V
5	132.7225	40.06	Pk	18	-30.7	27.36	43.52	-16.16	0-360	102	V
6	905.4	33.92	Pk	26.8	-27	33.72	46.02	-12.3	0-360	102	V

Pk - Peak detector

Figure 13 Radiated Emissions Graph – 1-18 GHz Charging

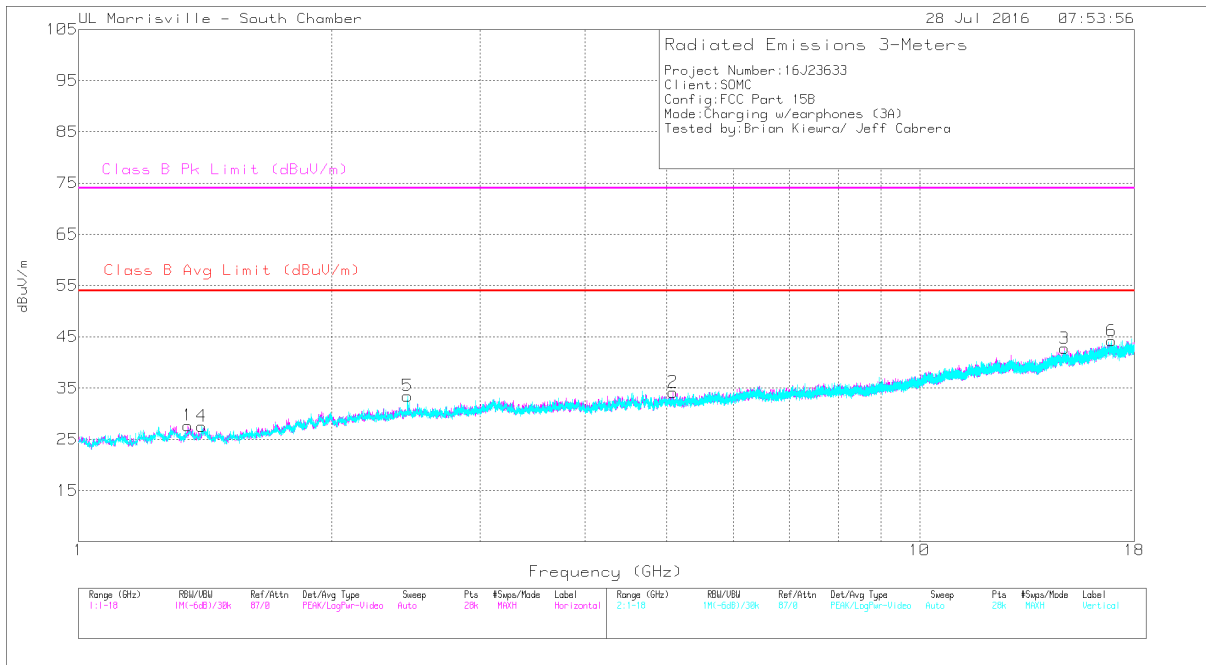

Table 11 Radiated Emissions Data Points – 1-18 GHz Charging

Marker	Frequency (GHz)	Meter Reading (dBuV)	Det	AF AT0069 (dB/m)	Amp/Cbl (dB)	Corrected Reading dBuV/m	Class B Avg Limit (dBuV/m)	Margin (dB)	Class B Pk Limit (dBuV/m)	Margin (dB)	Azimuth (Degs)	Height (cm)	Polarity
1	1.347	41.8	Pk	28.8	-35.6	35	54	-19	74	-39	41	103	H
	1.349	29.67	Av	28.8	-35.6	22.87	54	-31.13	-	-	41	103	H
2	5.086	39.53	Pk	34	-32.3	41.23	54	-12.77	74	-32.77	160	103	H
	5.086	27.39	Av	34	-32.3	29.09	54	-24.91	-	-	160	103	H
3	14.86	34.15	Pk	39.8	-24.6	49.35	54	-4.65	74	-24.65	79	199	H
	14.863	22.49	Av	39.8	-24.6	37.69	54	-16.31	-	-	79	199	H
4	1.401	42.39	Pk	28.8	-35.6	35.59	54	-18.41	74	-38.41	284	104	V
	1.403	29.64	Av	28.8	-35.6	22.84	54	-31.16	-	-	284	104	V
5	2.459	41.69	Pk	32.3	-34.7	39.29	54	-14.71	74	-34.71	77	198	V
	2.46	29.27	Av	32.3	-34.7	26.87	54	-27.13	-	-	77	198	V
6	16.922	34.6	Pk	41.6	-25.5	50.7	54	-3.3	74	-23.3	253	198	V
	16.923	22.89	Av	41.6	-25.5	38.99	54	-15.01	-	-	253	198	V

Pk - Peak detector
 Av - Average detection

Figure 14 Radiated Emissions Graph – 1-18 GHz Sync

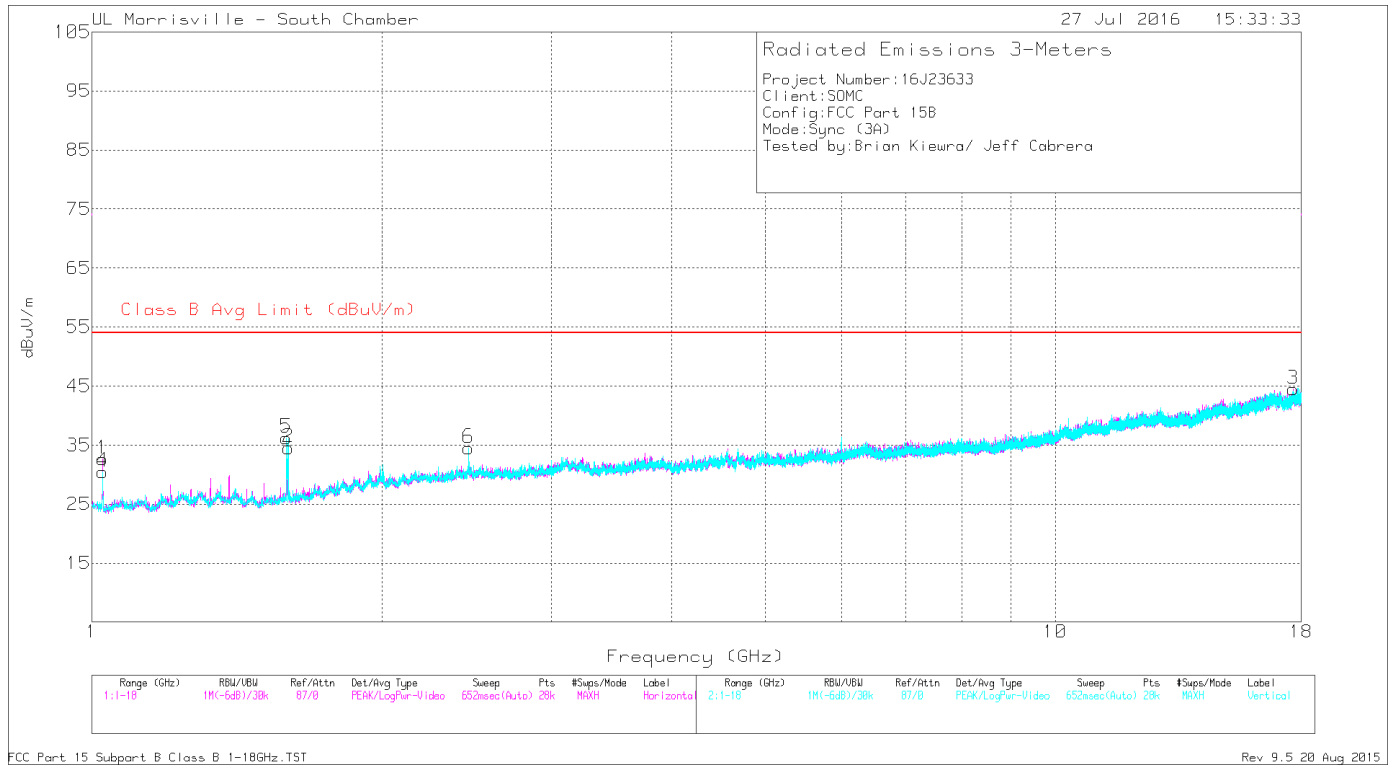

Table 12 Radiated Emissions Data Points – 1-18 GHz Sync

Marker	Frequency (GHz)	Meter Reading (dBuV)	Det	AF AT0069 (dB/m)	Amp/Cbl (dB)	Corrected Reading dBuV/m	Class B Avg Limit (dBuV/m)	Margin (dB)	Class B Pk Limit (dBuV/m)	Margin (dB)	Azimuth (Degs)	Height (cm)	Polarity
1	1.029	44.72	Pk	27.4	-36.1	36.02	54	-17.98	74	-37.98	297	104	H
	1.024	29.57	Av	27.4	-36.1	20.87	54	-33.13	-	-	291	104	H
2	1.599	53.22	Pk	28.3	-35.4	46.12	54	-7.88	74	-27.88	24	125	H
	1.598	30.69	Av	28.3	-35.3	23.69	54	-30.31	-	-	24	125	H
3	17.658	34.05	Pk	41.2	-23.2	52.05	54	-1.95	74	-21.95	16	175	H
	17.659	21.67	Av	41.2	-23.2	39.67	54	-14.33	-	-	16	175	H
4	1.028	42	Pk	27.4	-36.1	33.3	54	-20.7	74	-40.7	13	198	V
	1.024	29.52	Av	27.4	-36.1	20.82	54	-33.18	-	-	13	198	V
5	1.593	55.45	Pk	28.3	-35.3	48.45	54	-5.55	74	-25.55	216	104	V
	1.594	31.25	Av	28.3	-35.3	24.25	54	-29.75	-	-	216	104	V
6	2.462	41.91	Pk	32.3	-34.7	39.51	54	-14.49	74	-34.49	278	198	V
	2.46	29.42	Av	32.3	-34.7	27.02	54	-26.98	-	-	278	198	V

Pk - Peak detector
 Av - Average detection

Figure 15 Radiated Emissions Graph – 18-26 GHz Charging

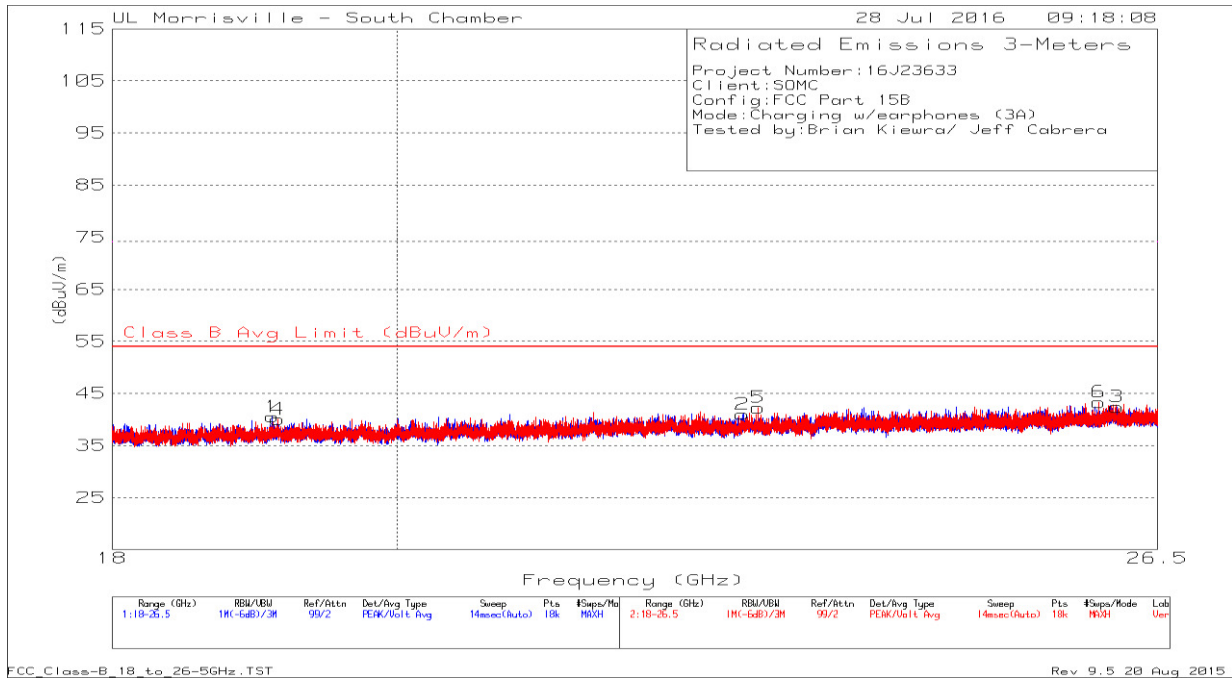

Table 13 Radiated Emissions Data Points – 18-26 GHz Charging

Marker	Frequency (GHz)	Meter Reading (dBuV)	Det	AF AT0076 (dB/m)	Amp/Cbl (dB)	Corrected Reading (dBuV/m)	Class B Avg Limit (dBuV/m)	Margin (dB)	Azimuth (Degs)	Height (cm)	Polarity
1	19.098	48.33	Pk	32.9	-40.7	40.53	54	-13.47	0-360	149	H
2	22.728	46.41	Pk	34.1	-39.5	41.01	54	-12.99	0-360	299	H
3	26.105	45.01	Pk	35	-37.6	42.41	54	-11.59	0-360	299	H
4	19.135	47.83	Pk	32.9	-40.7	40.03	54	-13.97	0-360	102	V
5	22.861	47.87	Pk	33.8	-39.4	42.27	54	-11.73	0-360	102	V
6	25.932	46.41	Pk	34.6	-37.7	43.31	54	-10.69	0-360	299	V

Pk - Peak detector

Figure 16 Radiated Emissions Graph – 18-26 GHz Sync

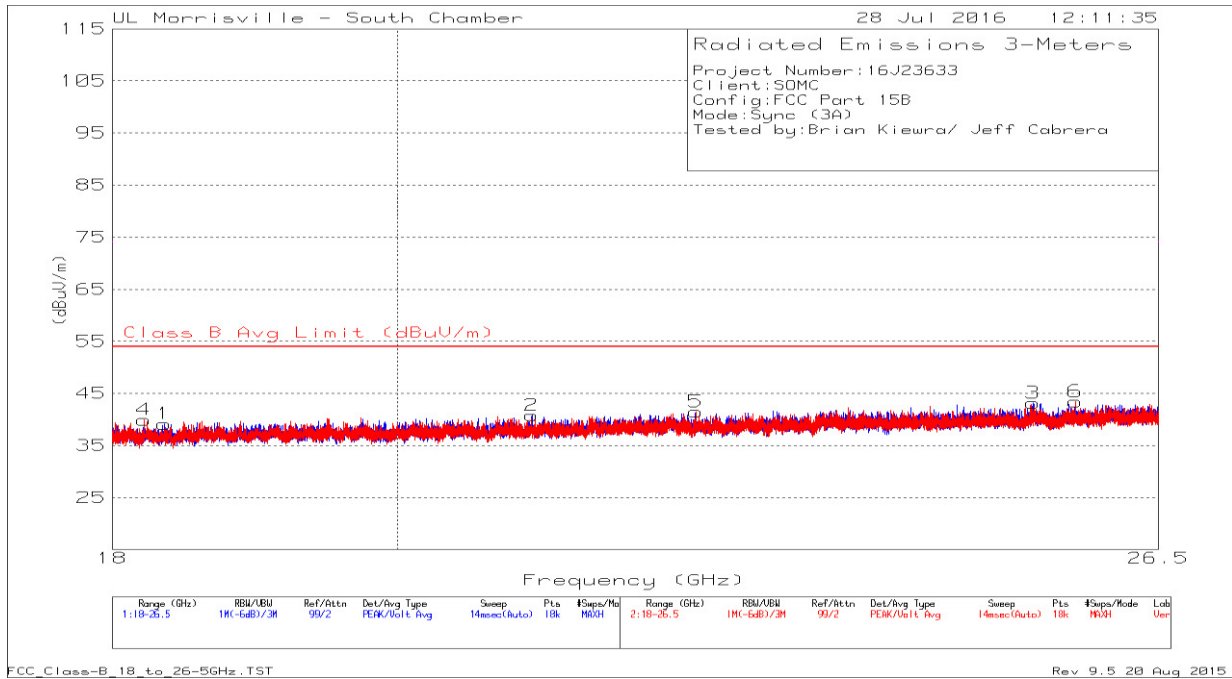

Table 14 Radiated Emissions Data Points – 18-26 GHz Sync

Marker	Frequency (GHz)	Meter Reading (dBuV)	Det	AF AT0076 (dB/m)	Amp/Cbl (dB)	Corrected Reading (dBuV/m)	Class B Avg Limit (dBuV/m)	Margin (dB)	Azimuth (Degs)	Height (cm)	Polarity
1	18.348	47.46	Pk	32.5	-40.8	39.16	54	-14.84	0-360	199	H
2	21.021	47.39	Pk	33.4	-40	40.79	54	-13.21	0-360	199	H
3	25.299	46.55	Pk	34.9	-38.3	43.15	54	-10.85	0-360	250	H
4	18.211	48.32	Pk	32.5	-40.9	39.92	54	-14.08	0-360	252	V
5	22.335	47.08	Pk	33.9	-39.5	41.48	54	-12.52	0-360	151	V
6	25.698	46.22	Pk	35	-37.8	43.42	54	-10.58	0-360	151	V

Pk - Peak detector

Figure 17 Radiated Emissions Graph – 26-40 GHz Charging

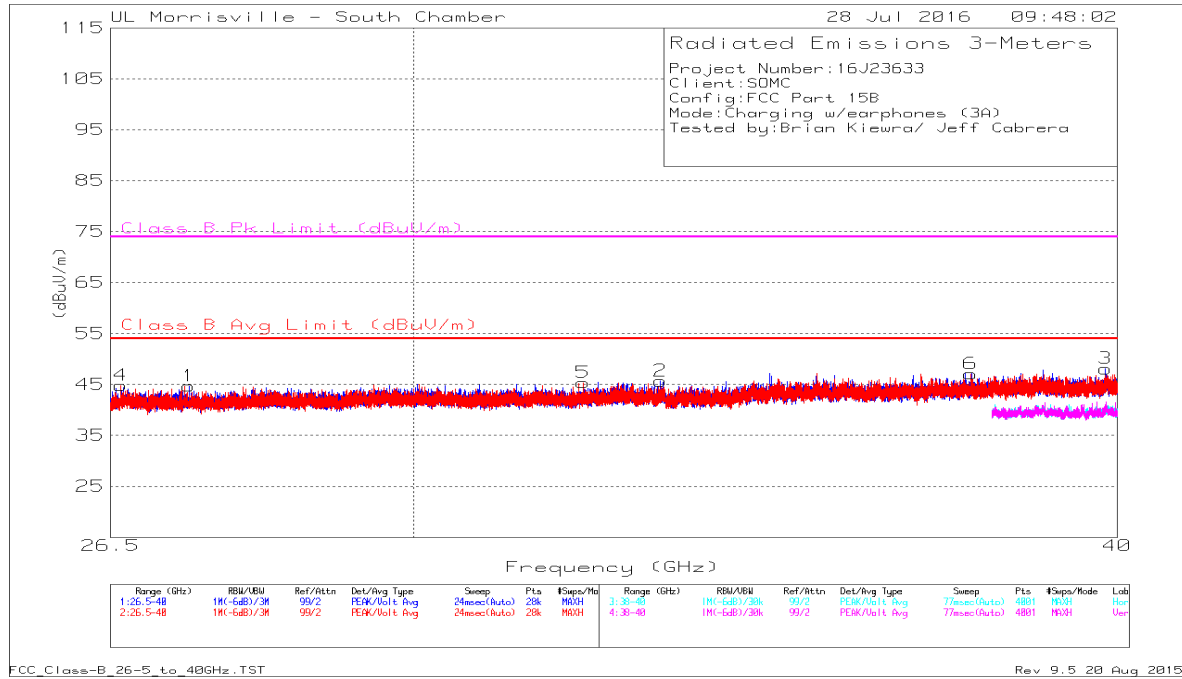

Table 15 Radiated Emissions Data Points – 18-40 GHz Charging

Marker	Frequency (GHz)	Meter Reading (dBuV)	Det	AF AT0077 (dB/m)	Amp/Cbl (dB)	Corrected Reading (dBuV/m)	Class B Avg Limit (dBuV/m)	Margin (dB)	Class B Pk Limit (dBuV/m)	Margin (dB)	Azimuth (Degs)	Height (cm)	Polarity
1	27.363	45.8	Pk	35.8	-36.9	44.7	54	-9.3	74	-29.3	0-360	102	H
2	33.184	44.78	Pk	37	-36.1	45.68	54	-8.32	74	-28.32	0-360	102	H
3	39.811	45.12	Pk	38.5	-35.5	48.12	54	-5.88	74	-25.88	0-360	199	H
4	26.613	46.32	Pk	35.7	-37.2	44.82	54	-9.18	74	-29.18	0-360	202	V
5	32.15	44.05	Pk	36.5	-35.2	45.35	54	-8.65	74	-28.65	0-360	299	V
6	37.671	46.07	Pk	37.9	-36.9	47.07	54	-6.93	74	-26.93	0-360	152	V

Pk - Peak detector

Figure 18 Radiated Emissions Graph – 26-40 GHz Sync

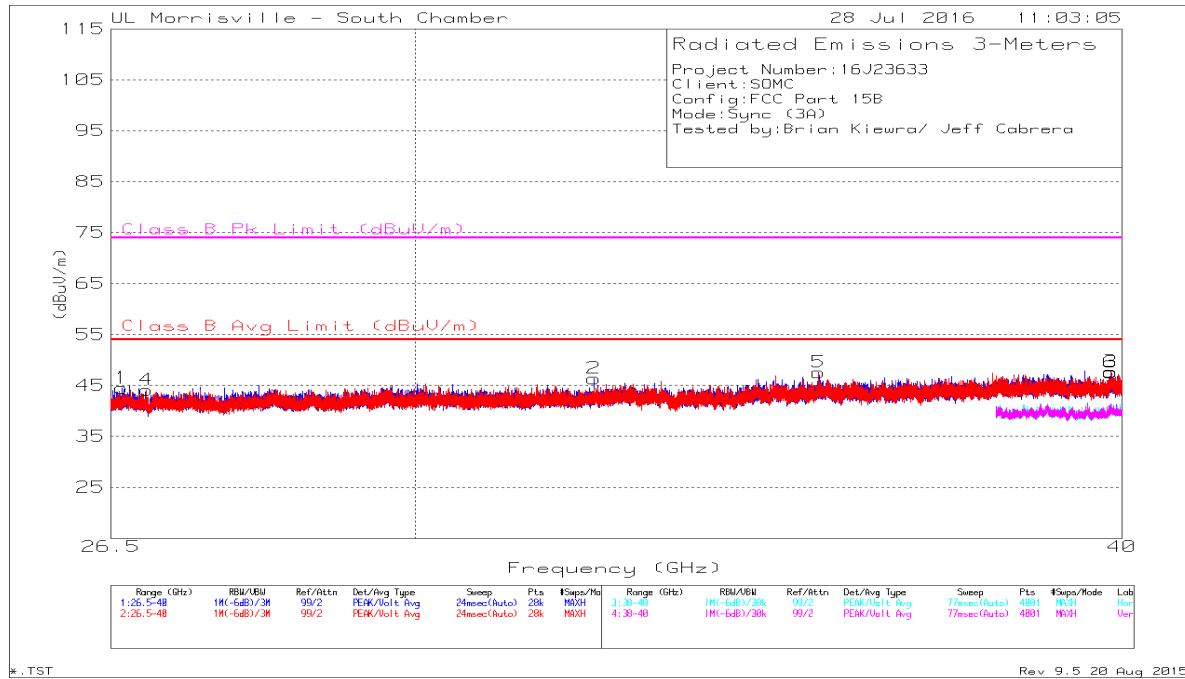

Table 16 Radiated Emissions Data Points – 18-40 GHz Sync

Marker	Frequency (GHz)	Meter Reading (dBuV)	Det	AF AT0077 (dB/m)	Amp/Cbl (dB)	Corrected Reading (dBuV/m)	Class B Avg Limit (dBuV/m)	Margin (dB)	Class B Pk Limit (dBuV/m)	Margin (dB)	Azimuth (Degs)	Height (cm)	Polarity
1	26.617	45.97	Pk	35.7	-37.2	44.47	54	-9.53	74	-29.53	0-360	299	H
2	32.26	45.19	Pk	36.6	-35.4	46.39	54	-7.61	74	-27.61	0-360	102	H
3	39.821	44.61	Pk	38.5	-35.4	47.71	54	-6.29	74	-26.29	0-360	299	H
4	26.888	45.33	Pk	35.8	-37	44.13	54	-9.87	74	-29.87	0-360	151	V
5	35.353	46.69	Pk	37.5	-36.6	47.59	54	-6.41	74	-26.41	0-360	102	V
6	39.815	44.49	Pk	38.5	-35.4	47.59	54	-6.41	74	-26.41	0-360	201	V

Pk - Peak detector

Appendix A

Accreditations and Authorizations



NVLAP Lab code: 200246-0

NVLAP: The National Institute of Standards and Technology (NIST) administers the National Voluntary Laboratory Accreditation Program (NVLAP). NVLAP is comprised of laboratory accreditation programs (LAPs) which are established on the basis of requests and demonstrated need. Each LAP includes specific calibration and/or test standards and related methods and protocols assembled to satisfy the unique needs for accreditation in a field of testing or calibration. NVLAP accredits public and private laboratories based on evaluation of their technical qualifications and competence to carry out specific calibrations or tests. Accreditation criteria are established in accordance with the U.S. Code of Federal Regulations (CFR, Title 15, Part 285), NVLAP Procedures and General Requirements, and encompass the requirements of ISO/IEC 17025. For a full scope listing see <http://www.nist.gov/nvlap/>



FCC: Details of the measurement facilities used for these tests have been filed with the Federal Communications Commission's Laboratory in Columbia, Maryland (Ref. No. 91039).



Industry Canada Industrie Canada

Industry of Canada: Accredited by Industry Canada for performance of radiated measurements. Our test site complies with RSP-100, Issue 7, Section 3.3. File #: IC 2180C



VCCI: Accepted as an Associate Member to the VCCI. The measurement facilities detailed in this test report have been registered in accordance with Regulations for Voluntary Control Measures, Article 8. Registration Nos.:

- Test Station 5 (Location A): G-246
- All Other Test Stations: A-0046



ICASA: ICASA (Independent Communications Authority of South Africa) has appointed UL as a Designated Test Laboratory to test Telecommunications equipment for type approval in compliance with CISPR 22 to assist in fulfilling its mandate under section 54(1) of the Telecommunications Act, 1996 (Act 103 of 1996).



NIST/CAB: Validated by the European Commission as a U.S. Conformity Assessment Body (CAB) of the U.S.-EU Mutual Recognition Agreement (MRA) for the Electromagnetic Compatibility - Council Directive 2004/108/EC, Annex III. Also validated for the Telecommunication Equipment-Council Directive 99/5/EC, Annex III and IV, Identification Number: 0983.

NIST/CAB: Provisioned to act as a U.S. Conformity Assessment Body (CAB) under Appendix B, Phase I Procedures, of the Asia Pacific Economic Cooperation (APEC) MRA between the American Institute in Taiwan (AIT) and the United States. Our laboratory is considered qualified to test equipment subject to the applicable EMC regulations of the Chinese Taipei Bureau of Standards, Metrology and Inspection (BSMI) which require testing to CNS 13438 (CISPR 22).

NIST/CAB: Recognized by the Infocomm Development Authority of Singapore (IDA) under the Asia Pacific Economic Cooperation Mutual Recognition Agreement (APEC MRA). Our laboratory is provisionally designated to act as a Conformity Assessment Body (CAB) under Appendix B, Phase I Procedures, of the APEC MRA. Our scope of designation includes IDA TS EMC (CISPR 22).