



FCC RADIO TEST REPORT

FCC ID : PY7-26726G
Equipment : GSM/WCDMA/LTE/5G Phone with BT, DTS/UNII a/b/g/n/ac/ax, GPS, WPC and NFC
Brand Name : Sony
Applicant : Sony Corporation
1-7-1 Konan Minato-ku Tokyo, 108-0075 Japan
Manufacturer : Sony Corporation
1-7-1 Konan Minato-ku Tokyo, 108-0075 Japan
Standard : FCC 47 CFR Part 2, 22(H), 27

The product was received on Dec. 22, 2020 and testing was started from Feb. 14, 2021 and completed on Mar. 02, 2021. We, Sporton International Inc. EMC & Wireless Communications Laboratory, would like to declare that the tested sample has been evaluated in accordance with the test procedures given in ANSI / TIA-603-E and has been in compliance with the applicable technical standards.

The test results in this report apply exclusively to the tested model / sample. Without written approval of Sporton International Inc. EMC & Wireless Communications Laboratory, the test report shall not be reproduced except in full.

Louis Wu

Approved by: Louis Wu

Sporton International Inc. EMC & Wireless Communications Laboratory

No. 52, Huaya 1st Rd., Guishan Dist., Taoyuan City 333, Taiwan (R.O.C.)



Table of Contents

History of this test report..... 3

Summary of Test Result..... 4

1 General Description 6

 1.1 Product Feature of Equipment Under Test..... 6

 1.2 Modification of EUT 6

 1.3 Emission Designator 7

 1.4 Testing Location 9

 1.5 Applicable Standards 10

2 Test Configuration of Equipment Under Test 11

 2.1 Test Mode 11

 2.2 Connection Diagram of Test System 14

 2.3 Support Unit used in test configuration and system 15

 2.4 Measurement Results Explanation Example 15

 2.5 Frequency List of Low/Middle/High Channels 16

3 Conducted Test Items 18

 3.1 Measuring Instruments 18

 3.2 Conducted Output Power and ERP/EIRP 19

 3.3 Peak-to-Average Ratio 20

 3.4 Occupied Bandwidth 21

 3.5 Conducted Band Edge 22

 3.6 Conducted Spurious Emission 24

 3.7 Frequency Stability 25

4 Radiated Test Items 26

 4.1 Measuring Instruments 26

 4.2 Radiated Spurious Emission Measurement 28

5 List of Measuring Equipment..... 29

6 Uncertainty of Evaluation 30

Appendix A. Test Results of Conducted Test

Appendix B. Test Results of ERP/EIRP and Radiated Test



History of this test report

Report No.	Version	Description	Issued Date
FG0D2215B	01	Initial issue of report	Mar. 31, 2021
FG0D2215B	02	1. Add description in Modification of EUT 2. Add remark description in Test Mode	Apr. 07, 2021



Summary of Test Result

Report Clause	Ref Std. Clause	Test Items	Result (PASS/FAIL)	Remark
3.2	§2.1046	Conducted Output Power	Reporting only	-
	§22.913 (a)(2)	Effective Radiated Power (Band 5)	Pass	
	§27.50 (b)(10) §27.50 (c)(10)	Effective Radiated Power (Band 12) (Band 13) (Band 17)		
	§27.50 (h)(2)	Equivalent Isotropic Radiated Power (Band 7) (Band 41)		
	§27.50 (d)(4)	Equivalent Isotropic Radiated Power (Band 4)		
3.3	§27.50 (d)(5)	Peak-to-Average Ratio	Pass	-
3.4	§2.1049	Occupied Bandwidth	Reporting only	-
3.5	§2.1051 §22.917 (a) §27.53 (c)(2)(4) §27.53 (g) §27.53 (h)	Conducted Band Edge Measurement (Band 4) (Band 5) (Band 12) (Band 13) (Band 17)	Pass	-
	§2.1051 §27.53 (m)(4)	Conducted Band Edge Measurement (Band 7) (Band 41)		
3.6	§2.1051 §22.917 (a) §27.53 (c)(2) §27.53 (g) §27.53 (h)	Conducted Spurious Emission (Band 4) (Band 5) (Band 12) (Band 13) (Band 17)	Pass	-
	§2.1051 §27.53 (m)(4)	Conducted Spurious Emission (Band 7) (Band 41)		
3.7	§2.1055 §22.355 §27.54	Frequency Stability Temperature & Voltage	Pass	-



Report Clause	Ref Std. Clause	Test Items	Result (PASS/FAIL)	Remark
4.2	§2.1053 §22.917 (a) §27.53 (c)(2) §27.53 (f) §27.53 (g) §27.53 (h)	Radiated Spurious Emission (Band 4) (Band 5) (Band 12) (Band 13) (Band 17)	Pass	Under limit 18.76 dB at 10332.000 MHz
	§2.1051 §27.53 (m)(4)	Radiated Spurious Emission (Band 7) (Band 41)		

Declaration of Conformity:

The test results with all measurement uncertainty excluded are presented in accordance with the regulation limits or requirements declared by manufacturers.

Comments and Explanations:

The declared of product specification for EUT presented in the report are provided by the manufacturer, and the manufacturer takes all the responsibilities for the accuracy of product specification.

Reviewed by: Wii Chang

Report Producer: Celery Wei



1 General Description

1.1 Product Feature of Equipment Under Test

GSM/WCDMA/LTE, Bluetooth, DTS/UNII a/b/g/n/ac/ax, NFC, FM Receiver, WPC/WPT, and GNSS.

Product Specification subjective to this standard	
Antenna Type	Loop Antenna
Antenna Gain	LTE Band 4: -2.02dBi LTE Band 5: -2.07dBi LTE Band 7: -2.02dBi LTE Band 12: -4.76dBi LTE Band 13: -2.48dBi LTE Band 17: -4.76dBi LTE Band 41: -1.09dBi

Remark: The above EUT's information was declared by manufacturer. Please refer to Comments and Explanations in report summary.

EUT Information List			
HW Version	SW Version	S/N	Performed Test Item
A	0.302	QV7200BK6F	Conducted Measurement
	0.400	QV7200336F	Radiated Spurious Emission
	0.325	QV7200385Z	ERP Test

Accessory List	
AC Adapter	Model Name : XQZ-UC1
	S/N: 0020W51300095
Earphone	Model Name : STH40D
	S/N : N/A
USB Cable	Model Name : XQZ-UB1
	S/N : N/A
Wireless Charger	Model Name : F7U050
	S/N : 26S10EHC828473

Note:

- Above EUT list used are electrically identical per declared by manufacturer.
- Above the accessories list are used to exercise the EUT during test, and the serial number of each type of accessories is listed in each section of this report. .
- For other wireless features of this EUT, test report will be issued separately.

1.2 Modification of EUT

No modifications are made to the EUT during all test items.



1.3 Emission Designator

LTE Band 4		QPSK			16QAM			64QAM		
BW (MHz)	Frequency Range (MHz)	Emission Designator (99%OBW)	Frequency Tolerance (ppm)	Maximum EIRP(W)	Emission Designator (99%OBW)	Frequency Tolerance (ppm)	Maximum EIRP(W)	Emission Designator (99%OBW)	Frequency Tolerance (ppm)	Maximum EIRP(W)
1.4	1710.7~1754.3	1M09G7D	-	0.0661	1M09W7D	-	0.0631	1M09W7D	-	0.0621
3	1711.5~1753.5	2M70G7D	-	0.0678	2M73W7D	-	0.0641	2M72W7D	-	0.0631
5	1712.5~1752.5	4M50G7D	-	0.0675	4M49W7D	-	0.0637	4M49W7D	-	0.0624
10	1715.0~1750.0	9M05G7D	0.0068	0.0687	9M01W7D	-	0.0649	8M99W7D	-	0.0640
15	1717.5~1747.5	13M4G7D	-	0.0681	13M5W7D	-	0.0649	13M4W7D	-	0.0631
20	1720.0~1745.0	17M9G7D	-	0.0689	17M8W7D	-	0.0653	17M8W7D	-	0.0632
LTE Band 5		QPSK			16QAM			64QAM		
BW (MHz)	Frequency Range (MHz)	Emission Designator (99%OBW)	Frequency Tolerance (ppm)	Maximum ERP(W)	Emission Designator (99%OBW)	Frequency Tolerance (ppm)	Maximum ERP(W)	Emission Designator (99%OBW)	Frequency Tolerance (ppm)	Maximum ERP(W)
1.4	824.7 ~ 848.3	1M09G7D	-	0.1007	1M10W7D	-	0.0857	1M09W7D	-	0.0675
3	825.5 ~ 847.5	2M73G7D	-	0.1019	2M70W7D	-	0.0875	2M72W7D	-	0.0684
5	826.5 ~ 846.5	4M47G7D	-	0.1012	4M49W7D	-	0.0881	4M51W7D	-	0.0692
10	829.0 ~ 844.0	8M99G7D	0.0139	0.1021	8M99W7D	-	0.0873	8M99W7D	-	0.0676
LTE Band 7		QPSK			16QAM			64QAM		
BW (MHz)	Frequency Range (MHz)	Emission Designator (99%OBW)	Frequency Tolerance (ppm)	Maximum EIRP(W)	Emission Designator (99%OBW)	Frequency Tolerance (ppm)	Maximum EIRP(W)	Emission Designator (99%OBW)	Frequency Tolerance (ppm)	Maximum EIRP(W)
5	2502.5 ~ 2567.5	4M49G7D	-	0.0700	4M50W7D	-	0.0656	4M50W7D	-	0.0652
10	2505.0 ~ 2565.0	9M03G7D	0.0040	0.0708	9M05W7D	-	0.0671	9M01W7D	-	0.0653
15	2507.5 ~ 2562.5	13M5G7D	-	0.0718	13M4W7D	-	0.0665	13M5W7D	-	0.0655
20	2510.0 ~ 2560.0	17M9G7D	-	0.0719	17M9W7D	-	0.0664	17M9W7D	-	0.0653
LTE Band 12		QPSK			16QAM			64QAM		
BW (MHz)	Frequency Range (MHz)	Emission Designator (99%OBW)	Frequency Tolerance (ppm)	Maximum ERP(W)	Emission Designator (99%OBW)	Frequency Tolerance (ppm)	Maximum ERP(W)	Emission Designator (99%OBW)	Frequency Tolerance (ppm)	Maximum ERP(W)
1.4	699.7 ~ 715.3	1M09G7D	-	0.0557	1M09W7D	-	0.0481	1M09W7D	-	0.0374
3	700.5 ~ 714.5	2M72G7D	-	0.0564	2M73W7D	-	0.0482	2M73W7D	-	0.0384
5	701.5 ~ 713.5	4M53G7D	-	0.0564	4M46W7D	-	0.0483	4M50W7D	-	0.0377
10	704.0 ~ 711.0	9M07G7D	0.0204	0.0569	8M99W7D	-	0.0488	9M03W7D	-	0.0370



LTE Band 13		QPSK			16QAM			64QAM		
BW (MHz)	Frequency Range (MHz)	Emission Designator (99%OBW)	Frequency Tolerance (ppm)	Maximum ERP(W)	Emission Designator (99%OBW)	Frequency Tolerance (ppm)	Maximum ERP(W)	Emission Designator (99%OBW)	Frequency Tolerance (ppm)	Maximum EIRP(W)
5	779.5 ~ 784.5	4M51G7D	-	0.0951	4M49W7D	-	0.0813	4M49W7D	-	0.0640
10	782.0	8M99G7D	0.0238	0.0953	9M07W7D	-	0.0807	9M01W7D	-	0.0634
LTE Band 17		QPSK			16QAM			64QAM		
BW (MHz)	Frequency Range (MHz)	Emission Designator (99%OBW)	Frequency Tolerance (ppm)	Maximum EIRP(W)	Emission Designator (99%OBW)	Frequency Tolerance (ppm)	Maximum EIRP(W)	Emission Designator (99%OBW)	Frequency Tolerance (ppm)	Maximum EIRP(W)
5	706.5~713.5	-	-	0.0568	-	-	0.0484	-	-	0.0376
10	709.0~711.0	-	-	0.0569	-	-	0.0485	-	-	0.0377
LTE Band 41		QPSK			16QAM			64QAM		
BW (MHz)	Frequency Range (MHz)	Emission Designator (99%OBW)	Frequency Tolerance (ppm)	Maximum EIRP(W)	Emission Designator (99%OBW)	Frequency Tolerance (ppm)	Maximum EIRP(W)	Emission Designator (99%OBW)	Frequency Tolerance (ppm)	Maximum EIRP(W)
5	2498.5 ~ 2687.5	4M50G7D	-	0.0741	4M50W7D	-	0.0684	4M45W7D	-	0.0670
10	2501.0 ~ 2685.0	9M05G7D	0.0037	0.0741	9M05W7D	-	0.0668	8M99W7D	-	0.0673
15	2503.5 ~ 2682.5	13M5G7D	-	0.0738	13M4W7D	-	0.0664	13M4W7D	-	0.0662
20	2506.0 ~ 2680.0	17M9G7D	-	0.0743	17M8W7D	-	0.0662	17M9W7D	-	0.0665



1.4 Testing Location

Test Site	Sporton International Inc. EMC & Wireless Communications Laboratory
Test Site Location	No.52, Huaya 1st Rd., Guishan & Dist., Taoyuan City 333, Taiwan (R.O.C.) TEL: +886-3-327-3456 FAX: +886-3-328-4978
Test Site No.	Sporton Site No. TH05-HY
Test Engineer	Bryant Liu
Temperature	23~25°C
Relative Humidity	54~56%

Test Site	Sporton International Inc. Wensan Laboratory
Test Site Location	No.58, Aly. 75, Ln. 564, Wenhua 3rd, Rd., Guishan Dist., Taoyuan City 333010, Taiwan (R.O.C.) TEL: +886-3-327-0868 FAX: +886-3-327-0855
Test Site No.	Sporton Site No. 03CH12-HY (TAF Code: 3786)
Test Engineer	Jack Cheng, Lance Chiang and Chuan Chu
Temperature	22~26°C
Relative Humidity	52~62%
Remark	The Radiated Emission Test item subcontracted to Sporton International Inc. Wensan Laboratory

Note: The test site complies with ANSI C63.4 2014 requirement.

FCC Designation No.: TW1190 and TW0007



1.5 Applicable Standards

According to the specifications of the manufacturer, the EUT must comply with the requirements of the following standards:

- ♦ ANSI C63.26-2015
- ♦ ANSI / TIA-603-E
- ♦ FCC 47 CFR Part 2, 22(H), 27
- ♦ FCC KDB 971168 D01 Power Meas. License Digital Systems v03r01
- ♦ FCC KDB 412172 D01 Determining ERP and EIRP v01r01
- ♦ FCC KDB 414788 D01 Radiated Test Site v01r01.

Remark:

1. All test items were verified and recorded according to the standards and without any deviation during the test.
2. This EUT has also been tested and complied with the requirements of FCC Part 15, Subpart B, recorded in a separate test report.
3. The TAF code is not including all the FCC KDB listed without accreditation.



2 Test Configuration of Equipment Under Test

2.1 Test Mode

Antenna port conducted and radiated test items listed below are performed according to KDB 971168 D01 Power Meas. License Digital Systems v03r01 with maximum output power.

For radiated measurement, pre-scanned in three orthogonal panels, X, Y, Z. The worst cases (X Plane for Band 13; Y Plane with Accessory for Band 4; Z Plane with Accessory for Band 5, 7, 12, 41 and WPC Charging Mode) were recorded in this report.

Test Items	Band	Bandwidth (MHz)						Modulation			RB #			Test Channel		
		1.4	3	5	10	15	20	QPSK	16QAM	64QAM	1	Half	Full	L	M	H
Max. Output Power	4	v	v	v	v	v	v	v	v	v	v	v	v	v	v	v
	5	v	v	v	v	-	-	v	v	v	v	v	v	v	v	v
	7	-	-	v	v	v	v	v	v	v	v	v	v	v	v	v
	12	v	v	v	v	-	-	v	v	v	v	v	v	v	v	v
	13	-	-	v	v	-	-	v	v	v	v	v	v	v	v	v
	17	-	-	v	v	-	-	v	v	v	v	v	v	v	v	v
	41	-	-	v	v	v	v	v	v	v	v	v	v	v	v	v
Peak-to-Average Ratio	4						v	v	v	v	v		v		v	
	5				v	-	-	v	v	v	v		v		v	
	7	-	-				v	v	v	v	v		v		v	
	12				v	-	-	v	v	v	v		v		v	
	13	-	-		v	-	-	v	v	v	v		v		v	
	17	Cover by LTE Band 12														
	41	-	-				v	v	v	v	v		v		v	
26dB and 99% Bandwidth	4	v	v	v	v	v	v	v	v	v			v		v	
	5	v	v	v	v	-	-	v	v	v			v		v	
	7	-	-	v	v	v	v	v	v	v			v		v	
	12	v	v	v	v	-	-	v	v	v			v		v	
	13	-	-	v	v	-	-	v	v	v			v		v	
	17	Cover by LTE Band 12														
	41	-	-	v	v	v	v	v	v	v			v		v	



Test Items	Band	Bandwidth (MHz)						Modulation			RB #			Test Channel		
		1.4	3	5	10	15	20	QPSK	16QAM	64QAM	1	Half	Full	L	M	H
Conducted Band Edge	4	v	v	v	v	v	v	v	v	v	v		v	v		v
	5	v	v	v	v	-	-	v	v	v	v		v	v		v
	7	-	-	v	v	v	v	v	v	v	v		v	v		v
	12	v	v	v	v	-	-	v	v	v	v		v	v		v
	13	-	-	v	v	-	-	v	v	v	v		v	v		v
	17	Cover by LTE Band 12														
	41	-	-	v	v	v	v	v	v	v	v		v	v		v
Conducted Spurious Emission	4	v	v	v	v	v	v	v			v			v	v	v
	5	v	v	v	v	-	-	v			v			v	v	v
	7	-	-	v	v	v	v	v			v			v	v	v
	12	v	v	v	v	-	-	v			v			v	v	v
	13	-	-	v	v	-	-	v			v			v	v	v
	17	Cover by LTE Band 12														
	41	-	-	v	v	v	v	v			v			v	v	v
Frequency Stability	4				v			v					v		v	
	5				v	-	-	v					v		v	
	7	-	-		v			v					v		v	
	12				v	-	-	v					v		v	
	13	-	-		v	-	-	v					v		v	
	17	Cover by LTE Band 12														
	41	-	-		v			v					v		v	



Test Items	Band	Bandwidth (MHz)						Modulation			RB #			Test Channel		
		1.4	3	5	10	15	20	QPSK	16QAM	64QAM	1	Half	Full	L	M	H
E.R.P / E.I.R.P	4	v	v	v	v	v	v	v	v	v	Max Power					
	5	v	v	v	v	-	-	v	v	v						
	7	-	-	v	v	v	v	v	v	v						
	12	v	v	v	v	-	-	v	v	v						
	13	-	-	v	v	-	-	v	v	v						
	17	-	-	v	v	-	-	v	v	v						
	41			v	v	v	v	v	v	v						
Radiated Spurious Emission	4	Worst Case										v	v	v		
	5	Worst Case										v	v	v		
	7	Worst Case										v	v	v		
	12	Worst Case										v	v	v		
	13	Worst Case										v	v	v		
	17	Cover by LTE Band 12										v	v	v		
	41	Worst Case										v	v	v		
Remark	<ol style="list-style-type: none"> The mark "v" means that this configuration is chosen for testing The mark "-" means that this bandwidth is not supported. The device is investigated from 30MHz to 10 times of fundamental signal for radiated spurious emission test under different RB size/offset and modulations in exploratory test. Subsequently, only the worst case emissions are reported. Wider operating range bandwidth and modulation the same covers narrower one when the power is higher or the same. We have evaluated simultaneous transmissions modes and determined no new significant emissions are observed. 															

2.2 Connection Diagram of Test System

<EUT With Accessory>

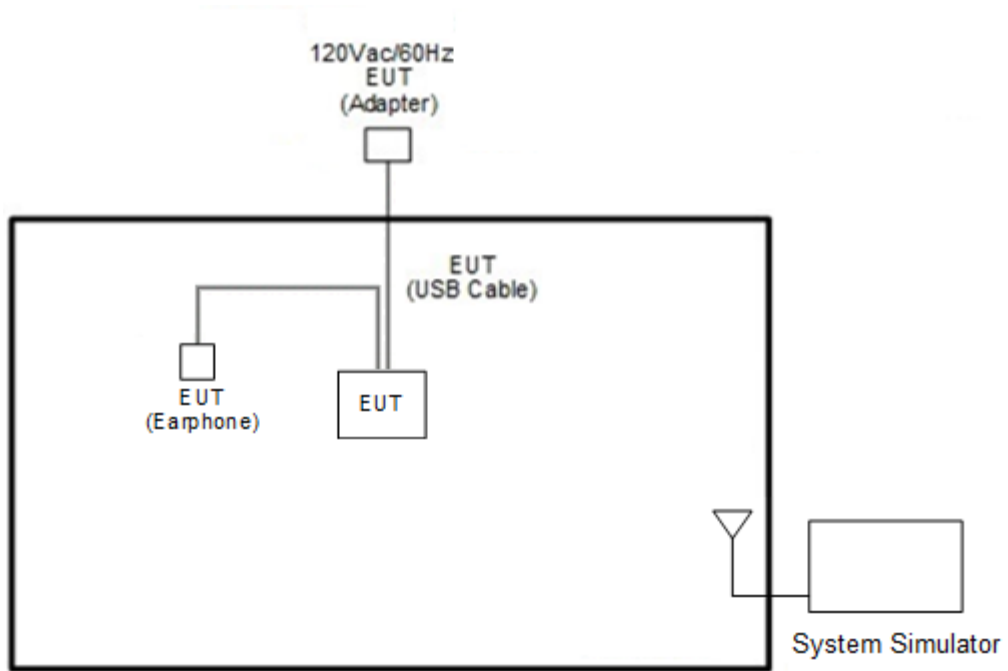

<EUT Without Accessory>



<WPC Charging Mode>

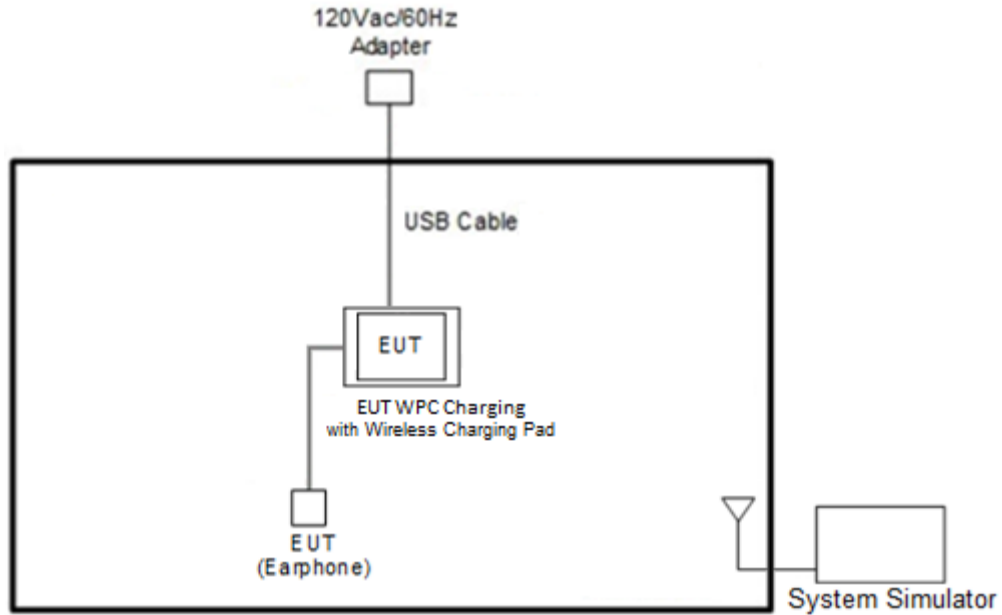

2.3 Support Unit used in test configuration and system

Item	Equipment	Brand Name	Model No.	FCC ID	Data Cable	Power Cord
1.	System Simulator	Anritsu	MT8820C	N/A	N/A	Unshielded, 1.8 m

2.4 Measurement Results Explanation Example

For all conducted test items:

The offset level is set in the spectrum analyzer to compensate the RF cable loss and attenuator factor between EUT conducted output port and spectrum analyzer. With the offset compensation, the spectrum analyzer reading level is exactly the EUT RF output level.

The spectrum analyzer offset is derived from RF cable loss and attenuator factor.

$$Offset = RF\ cable\ loss + attenuator\ factor.$$

Following shows an offset computation example with cable loss 4.2 dB and 10dB attenuator.

Example :

$$Offset(dB) = RF\ cable\ loss(dB) + attenuator\ factor(dB).$$

$$= 4.2 + 10 = 14.2 (dB)$$



2.5 Frequency List of Low/Middle/High Channels

LTE Band 4 Channel and Frequency List				
BW [MHz]	Channel/Frequency(MHz)	Lowest	Middle	Highest
20	Channel	20050	20175	20300
	Frequency	1720	1732.5	1745
15	Channel	20025	20175	20325
	Frequency	1717.5	1732.5	1747.5
10	Channel	20000	20175	20350
	Frequency	1715	1732.5	1750
5	Channel	19975	20175	20375
	Frequency	1712.5	1732.5	1752.5
3	Channel	19965	20175	20385
	Frequency	1711.5	1732.5	1753.5
1.4	Channel	19957	20175	20393
	Frequency	1710.7	1732.5	1754.3

LTE Band 5 Channel and Frequency List				
BW [MHz]	Channel/Frequency(MHz)	Lowest	Middle	Highest
10	Channel	20450	20525	20600
	Frequency	829	836.5	844
5	Channel	20425	20525	20625
	Frequency	826.5	836.5	846.5
3	Channel	20415	20525	20635
	Frequency	825.5	836.5	847.5
1.4	Channel	20407	20525	20643
	Frequency	824.7	836.5	848.3

LTE Band 7 Channel and Frequency List				
BW [MHz]	Channel/Frequency(MHz)	Lowest	Middle	Highest
20	Channel	20850	21100	21350
	Frequency	2510	2535	2560
15	Channel	20825	21100	21375
	Frequency	2507.5	2535	2562.5
10	Channel	20800	21100	21400
	Frequency	2505	2535	2565
5	Channel	20775	21100	21425
	Frequency	2502.5	2535	2567.5



LTE Band 12 Channel and Frequency List				
BW [MHz]	Channel/Frequency(MHz)	Lowest	Middle	Highest
10	Channel	23060	23095	23130
	Frequency	704	707.5	711
5	Channel	23035	23095	23155
	Frequency	701.5	707.5	713.5
3	Channel	23025	23095	23165
	Frequency	700.5	707.5	714.5
1.4	Channel	23017	23095	23173
	Frequency	699.7	707.5	715.3

LTE Band 13 Channel and Frequency List				
BW [MHz]	Channel/Frequency(MHz)	Lowest	Middle	Highest
10	Channel	-	23230	-
	Frequency	-	782	-
5	Channel	23205	23230	23255
	Frequency	779.5	782	784.5

LTE Band 17 Channel and Frequency List				
BW [MHz]	Channel/Frequency(MHz)	Lowest	Middle	Highest
10	Channel	23780	23790	23800
	Frequency	709	710	711
5	Channel	23755	23790	23825
	Frequency	706.5	710	713.5

LTE Band 41 Channel and Frequency List				
BW [MHz]	Channel/Frequency(MHz)	Lowest	Middle	Highest
20	Channel	39750	40620	41490
	Frequency	2506.0	2593.0	2680.0
15	Channel	39725	40620	41515
	Frequency	2503.5	2593.0	2682.5
10	Channel	39700	40620	41540
	Frequency	2501.0	2593.0	2685.0
5	Channel	39675	40620	41565
	Frequency	2498.5	2593.0	2687.5

3 Conducted Test Items

3.1 Measuring Instruments

See list of measuring instruments of this test report.

3.1.1 Test Setup

3.1.2 Conducted Output Power

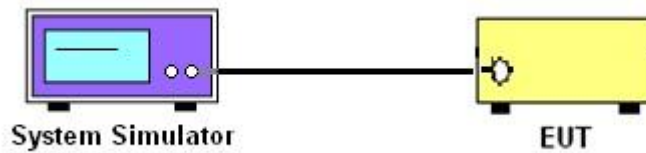

3.1.3 Peak-to-Average Ratio, Occupied Bandwidth ,Conducted Band-Edge and Conducted Spurious Emission

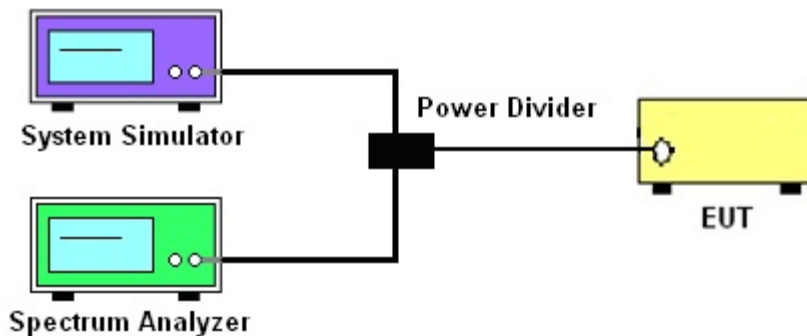

3.1.4 Frequency Stability



3.1.5 Test Result of Conducted Test

Please refer to Appendix A.



3.2 Conducted Output Power and ERP/EIRP

3.2.1 Description of the Conducted Output Power Measurement and ERP/EIRP Measurement

A system simulator was used to establish communication with the EUT. Its parameters were set to force the EUT transmitting at maximum output power. The measured power in the radio frequency on the transmitter output terminals shall be reported.

The ERP of mobile transmitters must not exceed 7 Watts for LTE Band 5

The ERP of mobile transmitters must not exceed 3 Watts for LTE Band 12 and Band 13 and Band 17

The EIRP of mobile transmitters must not exceed 2 Watts for LTE Band 7 and Band 41

The EIRP of mobile transmitters must not exceed 1 Watts for LTE Band 4

According to KDB 412172 D01 Power Approach,

$EIRP = P_T + G_T - L_C$, $ERP = EIRP - 2.15$, where

P_T = transmitter output power in dBm

G_T = gain of the transmitting antenna in dBi

L_C = signal attenuation in the connecting cable between the transmitter and antenna in dB

3.2.2 Test Procedures

1. The transmitter output port was connected to the system simulator.
2. Set EUT at maximum power through the system simulator.
3. Select lowest, middle, and highest channels for each band and different modulation.
4. Measure and record the power level from the system simulator.



3.3 Peak-to-Average Ratio

3.3.1 Description of the PAR Measurement

Power Complementary Cumulative Distribution Function (CCDF) curves provide a means for characterizing the power peaks of a digitally modulated signal on a statistical basis. A CCDF curve depicts the probability of the peak signal amplitude exceeding the average power level. Most contemporary measurement instrumentation include the capability to produce CCDF curves for an input signal provided that the instrument's resolution bandwidth can be set wide enough to accommodate the entire input signal bandwidth. In measuring transmissions in this band using an average power technique, the peak-to-average ratio (PAR) of the transmission may not exceed 13 dB.

3.3.2 Test Procedures

The testing follows ANSI C63.26-2015 Section 5.2.6

1. The EUT was connected to spectrum and system simulator via a power divider.
2. Set the CCDF (Complementary Cumulative Distribution Function) option in spectrum analyzer.
3. The highest RF powers were measured and recorded the maximum PAPR level associated with a probability of 0.1 %.
4. Record the deviation as Peak to Average Ratio.



3.4 Occupied Bandwidth

3.4.1 Description of Occupied Bandwidth Measurement

The occupied bandwidth is the width of a frequency band such that, below the lower and above the upper frequency limits, the mean powers emitted are each equal to a specified percentage 0.5% of the total mean transmitted power.

The 26 dB emission bandwidth is defined as the frequency range between two points, one above and one below the carrier frequency, at which the spectral density of the emission is attenuated 26 dB below the maximum in-band spectral density of the modulated signal. Spectral density (power per unit bandwidth) is to be measured with a detector of resolution bandwidth equal to approximately 1.0% of the emission bandwidth.

3.4.2 Test Procedures

The testing follows ANSI C63.26-2015 Section 5.4.3 (26dB) and Section 5.4.4 (99OB)

1. The EUT was connected to spectrum analyzer and system simulator via a power divider.
2. The spectrum analyzer center frequency is set to the nominal EUT channel center frequency. The span range for the spectrum analyzer shall be between two and five times the anticipated OBW.
3. The nominal resolution bandwidth (RBW) shall be in the range of 1 to 5 % of the anticipated OBW, and the VBW shall be at least 3 times the RBW.
4. Set the detection mode to peak, and the trace mode to max hold.
5. Determine the reference value: Set the EUT to transmit a modulated signal. Allow the trace to stabilize. Set the spectrum analyzer marker to the highest level of the displayed trace.
(this is the reference value)
6. Determine the “-26 dB down amplitude” as equal to (Reference Value – X).
7. Place two markers, one at the lowest and the other at the highest frequency of the envelope of the spectral display such that each marker is at or slightly below the “-X dB down amplitude” determined in step 6. If a marker is below this “-X dB down amplitude” value it shall be placed as close as possible to this value. The OBW is the positive frequency difference between the two markers.
8. Use the 99 % power bandwidth function of the spectrum analyzer and report the measured bandwidth.



3.5 Conducted Band Edge

3.5.1 Description of Conducted Band Edge Measurement

22.917(a)

For operations in the 824 – 849 MHz band, the FCC limit is $43 + 10\log_{10}(P[\text{Watts}])$ dB below the transmitter power $P(\text{Watts})$ in a 100kHz bandwidth. However, in the 1MHz bands immediately outside and adjacent to the licensee's frequency block, a resolution bandwidth of at least one percent of the emission bandwidth of the fundamental emission of the transmitter may be employed.

27.53 (c)

For operations in the 776-788 MHz band, the FCC limit is $43 + 10\log_{10}(P[\text{Watts}])$ dB below the transmitter power $P(\text{Watts})$ in a 100 kHz bandwidth. However, in the 100 kHz bands immediately outside and adjacent to the frequency block, a resolution bandwidth of at least 30 kHz may be employed. In addition, the power of any unwanted emissions in any 6.25 kHz bandwidth for all frequencies between 763-775 MHz and 793-806 MHz shall be attenuated below the transmitter power, P (dBW), by at least $65 + 10 \log_{10} p(\text{watts})$, dB, for mobile and portable equipment.

27.53 (g)

For operations in the 600MHz band and 698-746 MHz band, the FCC limit is $43 + 10\log_{10}(P[\text{Watts}])$ dB below the transmitter power $P(\text{Watts})$ in a 100 kHz bandwidth. However, in the 100 kilohertz bands immediately outside and adjacent to a licensee's frequency block, a resolution bandwidth of at least 30 kHz may be employed.

27.53 (h)

For operations in the 1710 – 1755 MHz band, 1755-1780 MHz, the FCC limit is $43 + 10\log_{10}(P[\text{Watts}])$ dB below the transmitter power $P(\text{Watts})$ in a 1 MHz bandwidth. However, in the 1MHz bands immediately outside and adjacent to the licensee's frequency block, a resolution bandwidth of at least one percent of the emission bandwidth of the fundamental emission of the transmitter may be employed.

**27.53(m)(4)**

For mobile digital stations, the attenuation factor shall be not less than $40 + 10 \log (P)$ dB on all frequencies between the channel edge and 5 megahertz from the channel edge, $43 + 10 \log (P)$ dB on all frequencies between 5 megahertz and X megahertz from the channel edge, and $55 + 10 \log (P)$ dB on all frequencies more than X megahertz from the channel edge, where X is the greater of 6 megahertz or the actual emission bandwidth as defined in paragraph (m)(6) of this section. In addition, the attenuation factor shall not be less that $43 + 10 \log (P)$ dB on all frequencies between 2490.5 MHz and 2496 MHz and $55 + 10 \log (P)$ dB at or below 2490.5 MHz. Mobile Satellite Service licensees operating on frequencies below 2495 MHz may also submit a documented interference complaint against BRS licensees operating on channel BRS Channel 1 on the same terms and conditions as adjacent channel BRS or EBS licensees.

3.5.2 Test Procedures

The testing follows FCC KDB 971168 D01 v03r01 Section 6.1.

1. The EUT was connected to spectrum analyzer and system simulator via a power divider.
2. The band edges of low and high channels for the highest RF powers were measured.
3. Set RBW \geq 1% EBW in the 1MHz band immediately outside and adjacent to the band edge.
4. Beyond the 1 MHz band from the band edge, RBW=1MHz was used.
5. Set spectrum analyzer with RMS detector.
6. The RF fundamental frequency should be excluded against the limit line in the operating frequency band.
7. Checked that all the results comply with the emission limit line.

The limit line is derived from $43 + 10\log(P)$ dB below the transmitter power P(Watts)

For LTE Band 7, 41

The other 40 dB, and 55 dB have additionally applied same calculation above.



3.6 Conducted Spurious Emission

3.6.1 Description of Conducted Spurious Emission Measurement

The power of any emission outside of the authorized operating frequency ranges must be lower than the transmitter power (P) by a factor of at least $43 + 10 \log (P)$ dB.

For LTE Band 7, 41

The power of any emission outside of the authorized operating frequency ranges must be lower than the transmitter power (P) by a factor of at least $55 + 10 \log (P)$ dB.

It is measured by means of a calibrated spectrum analyzer and scanned from 30 MHz up to a frequency including its 10th harmonic.

3.6.2 Test Procedures

The testing follows FCC KDB 971168 D01 v03r01 Section 6.1.

1. The EUT was connected to spectrum analyzer and system simulator via a power divider.
2. The RF output of EUT was connected to the spectrum analyzer by RF cable and attenuator.
The path loss was compensated to the results for each measurement.
3. The middle channel for the highest RF power within the transmitting frequency was measured.
4. The conducted spurious emission for the whole frequency range was taken.
5. Make the measurement with the spectrum analyzer's RBW = 1MHz, VBW = 3MHz.
6. Set spectrum analyzer with RMS detector.
7. Taking the record of maximum spurious emission.
8. The RF fundamental frequency should be excluded against the limit line in the operating frequency band.
9. The limit line is derived from $43 + 10\log(P)$ dB below the transmitter power P(Watts)
For LTE Band 7, 41
The limit line is derived from $55 + 10\log(P)$ dB below the transmitter power P(Watts)



3.7 Frequency Stability

3.7.1 Description of Frequency Stability Measurement

22.355

The frequency stability shall be measured by variation of ambient temperature and variation of primary supply voltage to ensure that the fundamental emission stays within the authorized frequency block. The frequency stability of the transmitter shall be maintained within $\pm 0.00025\%$ ($\pm 2.5\text{ppm}$) of the center frequency.

27.54

The frequency stability shall be sufficient to ensure that the fundamental emission stays within the authorized frequency block.

3.7.2 Test Procedures for Temperature Variation

The testing follows FCC KDB 971168 D01 v03r01 Section 9.0.

1. The EUT was set up in the thermal chamber and connected with the system simulator.
2. With power OFF, the temperature was decreased to -30°C and the EUT was stabilized before testing. Power was applied and the maximum change in frequency was recorded within one minute.
3. With power OFF, the temperature was raised in 10°C step up to 50°C . The EUT was stabilized at each step for at least half an hour. Power was applied and the maximum frequency change was recorded within one minute.

3.7.3 Test Procedures for Voltage Variation

The testing follows FCC KDB 971168 D01 v03r01 Section 9.0.

1. The EUT was placed in a temperature chamber at $20\pm 5^{\circ}\text{C}$ and connected with the system simulator.
2. The power supply voltage to the EUT was varied from 85% to 115% of the nominal value measured at the input to the EUT.
3. The variation in frequency was measured for the worst case.

4 Radiated Test Items

4.1 Measuring Instruments

See list of measuring instruments of this test report.

4.1.1 Test Setup

For radiated test below 30MHz



For radiated test from 30MHz to 1GHz



For radiated test above 1GHz

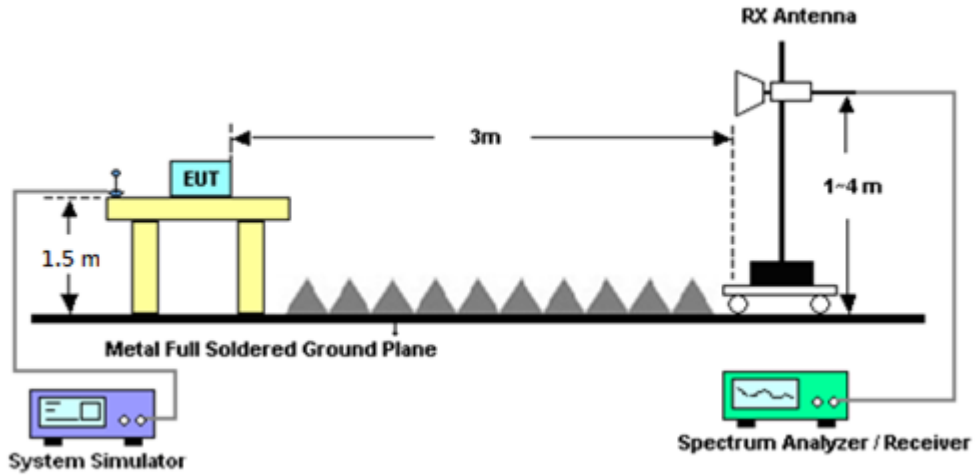

4.1.2 Test Result of Radiated Test

Please refer to Appendix B.

Note:

The low frequency, which started from 9 kHz to 30MHz, was pre-scanned and the result which was 20dB lower than the limit line was not reported.

There is a comparison data of both open-field test site and alternative test site - semi-Anechoic chamber according to 414788 D01 Radiated Test Site v01r01, and the result came out very similar.



4.2 Radiated Spurious Emission Measurement

4.2.1 Description of Radiated Spurious Emission Measurement

The radiated spurious emission was measured by substitution method according to ANSI / TIA-603-E. The power of any emission outside of the authorized operating frequency ranges must be attenuated below the transmitter power (P) by a factor of at least $43 + 10 \log (P)$ dB.

For LTE Band 7, 41

The power of any emission outside of the authorized operating frequency ranges must be attenuated below the transmitter power (P) by a factor of at least $55 + 10 \log (P)$ dB.

For LTE Band 13

For operations in the 746-758 MHz, 775-788 MHz, and 805-806 MHz bands, emissions in the band 1559-1610 MHz shall be limited to -70 dBW/MHz equivalent isotropically radiated power (EIRP) for wideband signals, and -80 dBW EIRP for discrete emissions of less than 700 Hz bandwidth.

The spectrum is scanned from 30 MHz up to a frequency including its 10th harmonic.

4.2.2 Test Procedures

The testing follows FCC KDB 971168 D01 v03r01 Section 7 and ANSI / TIA-603-E Section 2.2.12.

1. The EUT was placed on a turntable with 0.8 meter for frequency below 1GHz and 1.5 meter for frequency above 1GHz respectively above ground.
2. The EUT was set 3 meters from the receiving antenna, which was mounted on the antenna tower.
3. The table was rotated 360 degrees to determine the position of the highest spurious emission.
4. The height of the receiving antenna is varied between one meter and four meters to search the maximum spurious emission for both horizontal and vertical polarizations.
5. Make the measurement with the spectrum analyzer's RBW = 1MHz, VBW = 3MHz, taking the record of maximum spurious emission.
6. A horn antenna was substituted in place of the EUT and was driven by a signal generator.
7. Tune the output power of signal generator to the same emission level with EUT maximum spurious emission.
8. Taking the record of output power at antenna port.
9. Repeat step 7 to step 8 for another polarization.
10. The RF fundamental frequency should be excluded against the limit line in the operating frequency band.

The limit line is derived from $43 + 10\log(P)$ dB below the transmitter power P(Watts)

For LTE Band 7, 41

The limit line is derived from $55 + 10\log(P)$ dB below the transmitter power P(Watts)

EIRP (dBm) = S.G. Power – Tx Cable Loss + Tx Antenna Gain

ERP (dBm) = EIRP - 2.15



5 List of Measuring Equipment

Instrument	Brand Name	Model No.	Serial No.	Characteristics	Calibration Date	Test Date	Due Date	Remark
Loop Antenna	Rohde & Schwarz	HFH2-Z2	100488	9 kHz~30 MHz	Jul. 14, 2020	Feb. 14, 2021~ Feb. 15, 2021	Jul. 13, 2021	Radiation (03CH12-HY)
Bilog Antenna	TESEQ	CBL 6111D & 00800N1D01N -06	40103 & 07	30MHz~1GHz	Apr. 29, 2020	Feb. 14, 2021~ Feb. 15, 2021	Apr. 28, 2021	Radiation (03CH12-HY)
Horn Antenna	SCHWARZBE CK	BBHA 9120 D	9120D-1328	1GHz~18GHz	Nov. 23, 2020	Feb. 14, 2021~ Feb. 15, 2021	Nov. 22, 2021	Radiation (03CH12-HY)
Horn Antenna	SCHWARZBE CK	BBHA 9120D	9120D-1212	1GHz ~ 18GHz	May 20, 2020	Feb. 14, 2021~ Feb. 15, 2021	May 19, 2021	Radiation (03CH12-HY)
SHF-EHF Horn Antenna	SCHWARZBE CK	BBHA 9170	00993	18GHz~40GHz	Dec. 19, 2020	Feb. 14, 2021~ Feb. 15, 2021	Dec. 18, 2021	Radiation (03CH12-HY)
SHF-EHF Horn Antenna	SCHWARZBE CK	BBHA 9170	BBHA917057 6	18GHz~40GHz	May 22, 2020	Feb. 14, 2021~ Feb. 15, 2021	May 21, 2021	Radiation (03CH12-HY)
Preamplifier	COM-POWER	PA-103	161075	10MHz~1GHz	Mar. 25, 2020	Feb. 14, 2021~ Feb. 15, 2021	Mar. 24, 2021	Radiation (03CH12-HY)
Preamplifier	Keysight	83017A	MY57280120	1GHz~26.5GHz	Jul. 20, 2020	Feb. 14, 2021~ Feb. 15, 2021	Jul. 19, 2021	Radiation (03CH12-HY)
Preamplifier	E-INSTRUME NT TECH LTD.	ERA-100M-18 G-56-01-A70	EC1900249	1GHz~18GHz	Dec. 05, 2020	Feb. 14, 2021~ Feb. 15, 2021	Dec. 04, 2021	Radiation (03CH12-HY)
Preamplifier	EMEC	EM18G40G	060801	18GHz~40GHz	Jun. 15, 2020	Feb. 14, 2021~ Feb. 15, 2021	Jun. 14, 2021	Radiation (03CH12-HY)
Spectrum Analyzer	Agilent	N9010A	MY53470118	10Hz~44GHz	Sep. 14, 2020	Feb. 14, 2021~ Feb. 15, 2021	Sep. 13, 2021	Radiation (03CH12-HY)
Signal Generator	Rohde & Schwarz	SMB100A	101107	100kHz~40GHz	Dec. 04, 2020	Feb. 14, 2021~ Feb. 15, 2021	Dec. 03, 2021	Radiation (03CH12-HY)
RF Cable	HUBER + SUHNER	SUCOFLEX 104	MY9837/4PE	9kHz~30MHz	Mar. 12, 2020	Feb. 14, 2021~ Feb. 15, 2021	Mar. 11, 2021	Radiation (03CH12-HY)
RF Cable	HUBER + SUHNER	SUCOFLEX 126E	0058/126E	30MHz~18GHz	Dec. 11, 2020	Feb. 14, 2021~ Feb. 15, 2021	Dec. 10, 2021	Radiation (03CH12-HY)
RF Cable	HUBER + SUHNER	SUCOFLEX 102	505134/2	30MHz~40GHz	Feb. 25, 2020	Feb. 14, 2021~ Feb. 15, 2021	Feb. 24, 2021	Radiation (03CH12-HY)
RF Cable	HUBER + SUHNER	SUCOFLEX 102	800740/2	30MHz~40GHz	Feb. 25, 2020	Feb. 14, 2021~ Feb. 15, 2021	Feb. 24, 2021	Radiation (03CH12-HY)
Hygrometer	TECPEL	DTM-303B	TP140349	N/A	Oct. 02, 2020	Feb. 14, 2021~ Feb. 15, 2021	Oct. 01, 2021	Radiation (03CH12-HY)
Controller	EMEC	EM1000	N/A	Control Turn table & Ant Mast	N/A	Feb. 14, 2021~ Feb. 15, 2021	N/A	Radiation (03CH12-HY)
Antenna Mast	EMEC	AM-BS-4500-B	N/A	1m~4m	N/A	Feb. 14, 2021~ Feb. 15, 2021	N/A	Radiation (03CH12-HY)
Turn Table	EMEC	TT2000	N/A	0~360 Degree	N/A	Feb. 14, 2021~ Feb. 15, 2021	N/A	Radiation (03CH12-HY)
Software	Audix	E3 6.2009-8-24	RK-000989	N/A	N/A	Feb. 14, 2021~ Feb. 15, 2021	N/A	Radiation (03CH12-HY)
Base Station (Measure)	Anritsu	MT8821C	6262002534 1	N/A	Jul. 12, 2020	Feb. 23, 2021~ Mar. 02, 2021	Jul. 11, 2021	Conducted (TH05-HY)
Spectrum Analyzer	Rohde & Schwarz	FSV40	101397	10Hz~40GHz	Nov. 27, 2020	Feb. 23, 2021~ Mar. 02, 2021	Nov. 26, 2021	Conducted (TH05-HY)
Thermal Chamber	Ten Billion	TTH-D3SP	TBN-930701	N/A	Aug. 05, 2020	Feb. 23, 2021~ Mar. 02, 2021	Aug. 04, 2021	Conducted (TH05-HY)
Programmable Power Supply	GW Instek	PSS-2005	EL890094	1V~20V 0.5A~5A	Oct. 05, 2020	Feb. 23, 2021~ Mar. 02, 2021	Oct. 04, 2021	Conducted (TH05-HY)
Coupler	Warison	20dB 25W SMA Directional Coupler	#B	1-18GHz	Jan. 09, 2021	Feb. 23, 2021~ Mar. 02, 2021	Jan. 08, 2022	Conducted (TH05-HY)



6 Uncertainty of Evaluation

Uncertainty of Radiated Emission Measurement (30 MHz ~ 1000 MHz)

Measuring Uncertainty for a Level of Confidence of 95% ($U = 2Uc(y)$)	3.07
---	------

Uncertainty of Radiated Emission Measurement (1 GHz ~ 18 GHz)

Measuring Uncertainty for a Level of Confidence of 95% ($U = 2Uc(y)$)	3.21
---	------

Uncertainty of Radiated Emission Measurement (18 GHz ~ 40 GHz)

Measuring Uncertainty for a Level of Confidence of 95% ($U = 2Uc(y)$)	3.80
---	------



Appendix A. Test Results of Conducted Test

Conducted Output Power(Average power)

LTE Band 4 Maximum Average Power [dBm]						
BW [MHz]	RB Size	RB Offset	Mod	Lowest	Middle	Highest
20	1	0	QPSK	20.11	20.18	20.32
20	1	49		19.97	20.11	20.15
20	1	99		20.06	20.07	20.15
20	50	0		20.23	20.31	20.40
20	50	24		20.22	20.26	20.30
20	50	50		20.14	20.26	20.29
20	100	0		20.15	20.27	20.26
20	1	0	16-QAM	19.98	20.03	20.17
20	1	49		19.84	19.99	20.05
20	1	99		19.87	19.96	20.03
20	50	0		19.68	19.82	19.86
20	50	24		19.70	19.74	19.80
20	50	50		19.64	19.76	19.81
20	100	0		19.67	19.73	19.79
20	1	0	64-QAM	19.81	19.86	20.03
20	1	49		19.70	19.88	19.90
20	1	99		19.83	19.83	19.94
20	50	0		19.70	19.84	19.91
20	50	24		19.72	19.79	19.83
20	50	50		19.66	19.81	19.84
20	100	0		19.73	19.78	19.83
15	1	0	QPSK	20.11	20.21	20.32
15	1	37		19.97	20.13	20.16
15	1	74		20.07	20.12	20.15
15	36	0		20.11	20.30	20.33
15	36	20		20.19	20.23	20.35
15	36	39		20.13	20.26	20.30
15	75	0		20.17	20.24	20.25
15	1	0	16-QAM	19.94	20.02	20.14
15	1	37		19.80	19.95	19.99
15	1	74		19.88	19.95	19.98
15	36	0		19.63	19.80	19.86
15	36	20		19.65	19.74	19.84
15	36	39		19.63	19.75	19.82
15	75	0		19.67	19.74	19.78
15	1	0	64-QAM	19.83	19.85	20.02
15	1	37		19.73	19.90	19.94
15	1	74		19.80	19.82	19.92
15	36	0		19.68	19.86	19.89
15	36	20		19.69	19.78	19.88
15	36	39		19.65	19.82	19.84
15	75	0		19.68	19.77	19.80



LTE Band 4 Maximum Average Power [dBm]						
BW [MHz]	RB Size	RB Offset	Mod	Lowest	Middle	Highest
10	1	0	QPSK	20.06	20.14	20.26
10	1	25		19.97	20.15	20.23
10	1	49		19.99	20.17	20.20
10	25	0		20.13	20.22	20.26
10	25	12		20.14	20.25	20.29
10	25	25		20.15	20.35	20.39
10	50	0		20.14	20.27	20.29
10	1	0	16-QAM	19.91	20.03	20.11
10	1	25		19.87	20.07	20.14
10	1	49		19.89	20.04	20.12
10	25	0		19.62	19.72	19.79
10	25	12		19.65	19.76	19.86
10	25	25		19.65	19.82	19.91
10	50	0		19.66	19.75	19.82
10	1	0	64-QAM	19.85	19.87	19.98
10	1	25		19.83	20.01	20.08
10	1	49		19.80	19.98	20.01
10	25	0		19.66	19.76	19.85
10	25	12		19.70	19.80	19.89
10	25	25		19.64	19.88	19.95
10	50	0		19.67	19.79	19.84
5	1	0	QPSK	19.99	20.04	20.18
5	1	12		20.02	20.18	20.24
5	1	24		19.98	20.22	20.22
5	12	0		20.07	20.18	20.30
5	12	7		20.12	20.24	20.31
5	12	13		20.04	20.23	20.31
5	25	0		20.05	20.21	20.31
5	1	0	16-QAM	19.81	19.88	20.03
5	1	12		19.81	19.93	20.00
5	1	24		19.81	20.00	20.06
5	12	0		19.59	19.68	19.85
5	12	7		19.61	19.79	19.84
5	12	13		19.63	19.80	19.86
5	25	0		19.57	19.71	19.81
5	1	0	64-QAM	19.75	19.86	19.97
5	1	12		19.73	19.91	19.96
5	1	24		19.78	19.93	19.94
5	12	0		19.62	19.76	19.88
5	12	7		19.70	19.84	19.92
5	12	13		19.64	19.84	19.91
5	25	0		19.60	19.71	19.87



LTE Band 4 Maximum Average Power [dBm]						
BW [MHz]	RB Size	RB Offset	Mod	Lowest	Middle	Highest
3	1	0	QPSK	20.01	20.06	20.21
3	1	8		20.04	20.20	20.26
3	1	14		20.00	20.17	20.22
3	8	0		20.06	20.18	20.30
3	8	4		20.09	20.31	20.33
3	8	7		20.07	20.26	20.31
3	15	0		20.06	20.16	20.30
3	1	0	16-QAM	19.82	19.92	20.08
3	1	8		19.94	20.03	20.09
3	1	14		19.84	20.01	20.09
3	8	0		19.66	19.77	19.86
3	8	4		19.71	19.84	19.92
3	8	7		19.67	19.82	19.87
3	15	0		19.66	19.76	19.85
3	1	0	64-QAM	19.76	19.86	19.96
3	1	8		19.82	20.01	20.02
3	1	14		19.81	19.93	19.98
3	8	0		19.66	19.74	19.87
3	8	4		19.68	19.89	19.92
3	8	7		19.65	19.80	19.92
3	15	0		19.63	19.77	19.88
1.4	1	0	QPSK	19.90	20.03	20.11
1.4	1	3		20.01	20.16	20.20
1.4	1	5		19.94	20.11	20.13
1.4	3	0		19.94	20.04	20.15
1.4	3	1		19.96	20.15	20.18
1.4	3	3		19.96	20.10	20.15
1.4	6	0		20.02	20.11	20.22
1.4	1	0	16-QAM	19.74	19.83	19.93
1.4	1	3		19.81	19.97	20.02
1.4	1	5		19.75	19.93	19.91
1.4	3	0		19.55	19.62	19.73
1.4	3	1		19.61	19.73	19.77
1.4	3	3		19.57	19.66	19.73
1.4	6	0		19.57	19.71	19.79
1.4	1	0	64-QAM	19.67	19.80	19.90
1.4	1	3		19.76	19.92	19.95
1.4	1	5		19.71	19.84	19.88
1.4	3	0		19.65	19.79	19.86
1.4	3	1		19.71	19.89	19.91
1.4	3	3		19.69	19.84	19.86
1.4	6	0		19.55	19.68	19.73



LTE Band 5 Maximum Average Power [dBm]						
BW [MHz]	RB Size	RB Offset	Mod	Lowest	Middle	Highest
10	1	0	QPSK	24.31	24.25	24.23
10	1	25		24.14	24.19	24.21
10	1	49		24.18	24.23	24.16
10	25	0		23.26	23.28	23.31
10	25	12		23.33	23.30	23.31
10	25	25		23.34	23.31	23.33
10	50	0		23.35	23.28	23.30
10	1	0	16-QAM	23.63	23.56	23.58
10	1	25		23.56	23.58	23.60
10	1	49		23.58	23.59	23.53
10	25	0		22.26	22.29	22.29
10	25	12		22.35	22.31	22.31
10	25	25		22.31	22.31	22.34
10	50	0		22.35	22.28	22.30
10	1	0	64-QAM	22.52	22.42	22.43
10	1	25		22.51	22.49	22.22
10	1	49		22.17	21.56	21.69
10	25	0		21.29	21.34	21.35
10	25	12		21.38	21.30	21.30
10	25	25		21.34	21.38	20.77
10	50	0		21.35	21.29	21.24
5	1	0	QPSK	24.27	24.26	24.23
5	1	12		24.24	24.26	24.22
5	1	24		24.20	24.22	24.10
5	12	0		23.37	23.33	23.32
5	12	7		23.35	23.36	23.31
5	12	13		23.28	23.30	23.30
5	25	0		23.32	23.29	23.29
5	1	0	16-QAM	23.67	23.60	23.67
5	1	12		23.58	23.59	23.55
5	1	24		23.57	23.54	23.45
5	12	0		22.38	22.34	22.38
5	12	7		22.36	22.37	22.34
5	12	13		22.30	22.33	22.33
5	25	0		22.32	22.28	22.32
5	1	0	64-QAM	22.62	22.44	22.07
5	1	12		22.53	22.50	21.80
5	1	24		22.50	21.77	21.51
5	12	0		21.43	21.30	20.89
5	12	7		21.37	21.37	20.74
5	12	13		21.33	21.36	20.67
5	25	0		21.37	21.34	20.73



LTE Band 5 Maximum Average Power [dBm]						
BW [MHz]	RB Size	RB Offset	Mod	Lowest	Middle	Highest
3	1	0	QPSK	24.30	24.24	24.28
3	1	8		24.27	24.30	24.30
3	1	14		24.16	24.20	24.19
3	8	0		23.31	23.30	23.27
3	8	4		23.31	23.38	23.35
3	8	7		23.27	23.30	23.30
3	15	0		23.31	23.32	23.26
3	1	0	16-QAM	23.61	23.53	23.60
3	1	8		23.64	23.63	23.57
3	1	14		23.47	23.55	23.47
3	8	0		22.39	22.37	22.35
3	8	4		22.40	22.43	22.41
3	8	7		22.35	22.36	22.34
3	15	0		22.34	22.36	22.28
3	1	0	64-QAM	22.53	22.36	21.70
3	1	8		22.57	22.49	21.70
3	1	14		22.47	22.11	21.50
3	8	0		21.42	21.33	20.61
3	8	4		21.38	21.41	20.65
3	8	7		21.32	21.34	20.72
3	15	0		21.36	21.38	20.65
1.4	1	0	QPSK	24.19	24.11	24.14
1.4	1	3		24.21	24.21	24.18
1.4	1	5		24.14	24.13	24.09
1.4	3	0		24.21	24.14	24.16
1.4	3	1		24.25	24.18	24.19
1.4	3	3		24.17	24.16	24.16
1.4	6	0		23.25	23.25	23.22
1.4	1	0	16-QAM	23.52	23.44	23.51
1.4	1	3		23.54	23.55	23.52
1.4	1	5		23.43	23.48	23.42
1.4	3	0		23.30	23.22	23.23
1.4	3	1		23.34	23.27	23.29
1.4	3	3		23.27	23.23	23.20
1.4	6	0		22.32	22.34	22.32
1.4	1	0	64-QAM	22.47	22.38	21.74
1.4	1	3		22.51	22.49	21.78
1.4	1	5		22.40	22.39	21.68
1.4	3	0		22.40	22.35	21.76
1.4	3	1		22.44	22.37	21.89
1.4	3	3		22.38	22.37	21.86
1.4	6	0		21.31	21.28	20.78



LTE Band 7 Maximum Average Power [dBm]						
BW [MHz]	RB Size	RB Offset	Mod	Lowest	Middle	Highest
20	1	0	QPSK	20.20	20.23	20.34
20	1	49		20.26	20.28	20.41
20	1	99		20.29	20.32	20.45
20	50	0		20.30	20.32	20.45
20	50	24		20.42	20.43	20.59
20	50	50		20.41	20.42	20.56
20	100	0		20.42	20.42	20.50
20	1	0	16-QAM	20.04	20.05	20.17
20	1	49		20.12	20.09	20.24
20	1	99		20.16	20.20	20.24
20	50	0		19.80	19.83	19.96
20	50	24		19.89	19.94	20.07
20	50	50		19.92	19.94	20.09
20	100	0		19.90	19.91	19.97
20	1	0	64-QAM	19.87	19.92	20.01
20	1	49		19.99	19.94	20.11
20	1	99		20.03	20.07	20.17
20	50	0		19.84	19.85	19.97
20	50	24		19.97	19.98	20.12
20	50	50		19.96	19.97	20.10
20	100	0		19.94	19.93	19.98
15	1	0	QPSK	20.22	20.26	20.41
15	1	37		20.27	20.26	20.41
15	1	74		20.32	20.32	20.48
15	36	0		20.26	20.32	20.50
15	36	20		20.40	20.41	20.51
15	36	39		20.40	20.43	20.58
15	75	0		20.40	20.40	20.48
15	1	0	16-QAM	20.02	20.03	20.25
15	1	37		20.13	20.09	20.24
15	1	74		20.14	20.14	20.25
15	36	0		19.80	19.81	19.96
15	36	20		19.89	19.92	19.98
15	36	39		19.90	19.91	20.05
15	75	0		19.89	19.91	19.97
15	1	0	64-QAM	19.93	19.95	20.07
15	1	37		19.99	20.01	20.18
15	1	74		20.04	20.04	20.15
15	36	0		19.83	19.86	20.03
15	36	20		19.94	19.95	20.04
15	36	39		19.96	19.97	20.10
15	75	0		19.91	19.92	20.00



LTE Band 7 Maximum Average Power [dBm]						
BW [MHz]	RB Size	RB Offset	Mod	Lowest	Middle	Highest
10	1	0	QPSK	20.17	20.16	20.31
10	1	25		20.13	20.17	20.32
10	1	49		20.22	20.24	20.36
10	25	0		20.30	20.28	20.44
10	25	12		20.34	20.39	20.45
10	25	25		20.34	20.37	20.52
10	50	0		20.35	20.39	20.44
10	1	0	16-QAM	20.01	20.04	20.23
10	1	25		20.02	20.05	20.23
10	1	49		20.07	20.08	20.29
10	25	0		19.81	19.77	19.98
10	25	12		19.84	19.87	19.98
10	25	25		19.83	19.85	20.06
10	50	0		19.85	19.90	19.99
10	1	0	64-QAM	19.94	19.90	20.05
10	1	25		19.93	20.01	20.17
10	1	49		20.03	20.01	20.14
10	25	0		19.84	19.83	19.96
10	25	12		19.88	19.92	20.02
10	25	25		19.88	19.90	20.05
10	50	0		19.88	19.91	20.01
5	1	0	QPSK	20.14	20.12	20.36
5	1	12		20.18	20.24	20.39
5	1	24		20.17	20.22	20.35
5	12	0		20.29	20.28	20.45
5	12	7		20.27	20.34	20.47
5	12	13		20.31	20.37	20.47
5	25	0		20.26	20.32	20.45
5	1	0	16-QAM	19.97	19.95	20.19
5	1	12		19.96	20.01	20.18
5	1	24		19.98	20.02	20.19
5	12	0		19.81	19.81	20.02
5	12	7		19.78	19.84	20.04
5	12	13		19.80	19.84	20.00
5	25	0		19.80	19.86	20.00
5	1	0	64-QAM	19.90	19.93	20.14
5	1	12		19.87	19.95	20.12
5	1	24		19.90	19.95	20.16
5	12	0		19.87	19.83	20.04
5	12	7		19.88	19.93	20.06
5	12	13		19.86	19.91	20.06
5	25	0		19.80	19.84	20.03



LTE Band 12 Maximum Average Power [dBm]						
BW [MHz]	RB Size	RB Offset	Mod	Lowest	Middle	Highest
10	1	0	QPSK	24.36	24.33	24.33
10	1	25		24.34	24.36	24.34
10	1	49		24.46	24.37	24.35
10	25	0		23.43	23.46	23.46
10	25	12		23.49	23.46	23.47
10	25	25		23.53	23.52	23.51
10	50	0		23.50	23.46	23.47
10	1	0	16-QAM	23.74	23.69	23.67
10	1	25		23.71	23.75	23.73
10	1	49		23.79	23.68	23.70
10	25	0		22.41	22.46	22.44
10	25	12		22.52	22.47	22.44
10	25	25		22.49	22.50	22.49
10	50	0		22.52	22.45	22.46
10	1	0	64-QAM	21.72	22.14	22.59
10	1	25		21.96	22.37	22.57
10	1	49		22.32	21.86	21.86
10	25	0		20.46	20.89	21.50
10	25	12		20.70	21.47	21.40
10	25	25		21.24	21.53	20.93
10	50	0		20.95	21.34	21.31
5	1	0	QPSK	24.15	24.38	24.35
5	1	12		24.38	24.42	24.41
5	1	24		24.38	24.41	24.39
5	12	0		23.31	23.48	23.46
5	12	7		23.45	23.53	23.44
5	12	13		23.46	23.48	23.44
5	25	0		23.44	23.43	23.44
5	1	0	16-QAM	23.48	23.74	23.68
5	1	12		23.65	23.75	23.66
5	1	24		23.69	23.74	23.66
5	12	0		22.34	22.53	22.49
5	12	7		22.48	22.55	22.45
5	12	13		22.48	22.51	22.43
5	25	0		22.41	22.47	22.45
5	1	0	64-QAM	21.38	22.19	22.37
5	1	12		21.64	22.67	21.81
5	1	24		21.60	22.51	21.72
5	12	0		20.10	21.00	20.70
5	12	7		20.51	21.55	20.73
5	12	13		20.53	21.54	20.51
5	25	0		20.39	21.49	20.59



LTE Band 12 Maximum Average Power [dBm]						
BW [MHz]	RB Size	RB Offset	Mod	Lowest	Middle	Highest
3	1	0	QPSK	24.14	24.42	24.37
3	1	8		24.33	24.42	24.34
3	1	14		24.27	24.38	24.27
3	8	0		23.34	23.46	23.41
3	8	4		23.51	23.52	23.43
3	8	7		23.43	23.47	23.37
3	15	0		23.37	23.46	23.41
3	1	0	16-QAM	23.41	23.74	23.71
3	1	8		23.65	23.73	23.71
3	1	14		23.62	23.73	23.60
3	8	0		22.44	22.52	22.49
3	8	4		22.51	22.56	22.48
3	8	7		22.48	22.51	22.44
3	15	0		22.36	22.47	22.44
3	1	0	64-QAM	21.49	22.55	21.78
3	1	8		21.71	22.75	21.68
3	1	14		21.66	22.71	21.57
3	8	0		20.35	21.55	20.44
3	8	4		20.57	21.59	20.51
3	8	7		20.54	21.51	20.43
3	15	0		20.49	21.38	20.48
1.4	1	0	QPSK	24.11	24.25	24.24
1.4	1	3		24.23	24.37	24.33
1.4	1	5		24.16	24.29	24.26
1.4	3	0		24.16	24.31	24.27
1.4	3	1		24.25	24.32	24.31
1.4	3	3		24.18	24.35	24.27
1.4	6	0		23.33	23.41	23.33
1.4	1	0	16-QAM	23.44	23.61	23.50
1.4	1	3		23.56	23.73	23.61
1.4	1	5		23.43	23.64	23.49
1.4	3	0		23.20	23.39	23.23
1.4	3	1		23.22	23.42	23.24
1.4	3	3		23.23	23.42	23.31
1.4	6	0		22.35	22.48	22.33
1.4	1	0	64-QAM	21.41	22.54	21.39
1.4	1	3		21.55	22.64	21.85
1.4	1	5		22.17	22.57	21.83
1.4	3	0		21.40	22.49	21.32
1.4	3	1		21.46	22.55	21.45
1.4	3	3		21.44	22.56	21.44
1.4	6	0		20.34	21.44	20.34



LTE Band 13 Maximum Average Power [dBm]						
BW [MHz]	RB Size	RB Offset	Mod	Lowest	Middle	Highest
10	1	0	QPSK		24.28	
10	1	25			24.42	
10	1	49			24.34	
10	25	0			23.42	
10	25	12			23.39	
10	25	25			23.48	
10	50	0			23.43	
10	1	0	16-QAM	-	23.61	-
10	1	25			23.69	
10	1	49			23.70	
10	25	0			22.36	
10	25	12			22.44	
10	25	25			22.43	
10	50	0			22.40	
10	1	0	64-QAM		21.54	
10	1	25			22.65	
10	1	49			22.27	
10	25	0			20.32	
10	25	12			21.30	
10	25	25			21.51	
10	50	0			21.25	
5	1	0	QPSK	24.24	24.24	24.30
5	1	12		24.29	24.34	24.41
5	1	24		24.37	24.31	24.37
5	12	0		23.36	23.43	23.44
5	12	7		23.02	23.43	23.41
5	12	13		23.47	23.48	23.46
5	25	0		23.38	23.39	23.42
5	1	0	16-QAM	23.27	23.61	23.65
5	1	12		23.55	23.73	23.71
5	1	24		23.71	23.70	23.70
5	12	0		22.15	22.47	22.47
5	12	7		22.09	22.46	22.43
5	12	13		22.49	22.49	22.46
5	25	0		22.31	22.47	22.44
5	1	0	64-QAM	21.07	21.47	22.61
5	1	12		21.47	22.65	22.64
5	1	24		22.69	22.66	22.18
5	12	0		20.15	20.71	21.51
5	12	7		20.14	21.47	21.42
5	12	13		20.58	21.51	20.97
5	25	0		20.26	21.21	21.34



LTE Band 17 Maximum Average Power [dBm]						
BW [MHz]	RB Size	RB Offset	Mod	Lowest	Middle	Highest
10	1	0	QPSK	24.34	24.32	24.30
10	1	25		24.35	24.34	24.34
10	1	49		24.42	24.46	24.41
10	25	0		23.37	23.36	23.39
10	25	12		23.45	23.45	23.47
10	25	25		23.55	23.55	23.55
10	50	0		23.51	23.51	23.44
10	1	0	16-QAM	23.72	23.66	23.71
10	1	25		23.74	23.75	23.72
10	1	49		23.75	23.77	23.76
10	25	0		22.41	22.39	22.38
10	25	12		22.45	22.47	22.47
10	25	25		22.48	22.52	22.52
10	50	0		22.51	22.50	22.42
10	1	0	64-QAM	22.09	22.45	22.53
10	1	25		22.66	22.67	22.48
10	1	49		21.92	21.90	21.99
10	25	0		21.34	21.44	21.43
10	25	12		21.47	21.50	21.42
10	25	25		21.41	21.16	20.96
10	50	0		21.37	21.35	21.32
5	1	0	QPSK	24.38	24.30	24.34
5	1	12		24.42	24.41	24.41
5	1	24		24.45	24.45	24.41
5	12	0		23.44	23.43	23.44
5	12	7		23.51	23.52	23.53
5	12	13		23.52	23.51	23.46
5	25	0		23.48	23.43	23.45
5	1	0	16-QAM	23.70	23.64	23.65
5	1	12		23.67	23.67	23.67
5	1	24		23.75	23.76	23.70
5	12	0		22.49	22.45	22.46
5	12	7		22.55	22.53	22.56
5	12	13		22.51	22.53	22.44
5	25	0		22.52	22.46	22.46
5	1	0	64-QAM	21.90	22.64	22.12
5	1	12		22.42	22.66	21.97
5	1	24		22.43	22.21	21.77
5	12	0		20.91	21.48	20.95
5	12	7		21.43	21.58	20.72
5	12	13		21.56	21.32	20.49
5	25	0		21.24	21.46	20.71



LTE Band 41 Maximum Average Power [dBm]						
BW [MHz]	RB Size	RB Offset	Mod	Lowest	Middle	Highest
20	1	0	QPSK	19.18	19.68	19.53
20	1	49		19.13	19.57	19.44
20	1	99		19.11	19.67	19.47
20	50	0		19.25	19.67	19.53
20	50	24		19.31	19.75	19.53
20	50	50		19.33	19.80	19.59
20	100	0		19.32	19.76	19.54
20	1	0	16-QAM	18.78	19.17	19.14
20	1	49		18.72	19.17	19.03
20	1	99		18.72	19.25	19.02
20	50	0		18.75	19.22	19.09
20	50	24		18.84	19.30	19.07
20	50	50		18.83	19.29	19.12
20	100	0		18.83	19.27	19.05
20	1	0	64-QAM	18.44	18.90	18.74
20	1	49		18.42	18.89	18.72
20	1	99		18.36	19.00	18.64
20	50	0		18.80	19.23	19.10
20	50	24		18.86	19.32	19.08
20	50	50		18.83	19.29	19.13
20	100	0		18.86	19.29	19.06
15	1	0	QPSK	19.17	19.58	19.46
15	1	37		19.13	19.55	19.44
15	1	74		19.17	19.70	19.54
15	36	0		19.26	19.68	19.52
15	36	20		19.32	19.74	19.50
15	36	39		19.30	19.74	19.58
15	75	0		19.34	19.77	19.51
15	1	0	16-QAM	18.80	19.18	19.08
15	1	37		18.71	19.13	19.01
15	1	74		18.79	19.31	19.11
15	36	0		18.72	19.17	19.00
15	36	20		18.76	19.22	18.97
15	36	39		18.74	19.24	19.03
15	75	0		18.83	19.27	19.04
15	1	0	64-QAM	18.46	18.87	18.74
15	1	37		18.47	18.90	18.75
15	1	74		18.45	19.04	18.75
15	36	0		18.79	19.22	19.06
15	36	20		18.83	19.28	19.05
15	36	39		18.82	19.28	19.12
15	75	0		18.83	19.30	19.05



LTE Band 41 Maximum Average Power [dBm]						
BW [MHz]	RB Size	RB Offset	Mod	Lowest	Middle	Highest
10	1	0	QPSK	19.28	19.66	19.49
10	1	25		19.26	19.70	19.54
10	1	49		19.27	19.71	19.52
10	25	0		19.36	19.72	19.55
10	25	12		19.38	19.79	19.66
10	25	25		19.35	19.79	19.62
10	50	0		19.36	19.79	19.56
10	1	0	16-QAM	18.92	19.24	19.17
10	1	25		18.88	19.27	19.12
10	1	49		18.85	19.26	19.10
10	25	0		18.86	19.21	19.08
10	25	12		18.89	19.33	19.18
10	25	25		18.86	19.30	19.12
10	50	0		18.89	19.34	19.08
10	1	0	64-QAM	18.57	18.87	18.76
10	1	25		18.57	18.99	18.83
10	1	49		18.51	18.94	18.71
10	25	0		18.92	19.29	19.14
10	25	12		18.95	19.37	19.27
10	25	25		18.91	19.36	19.20
10	50	0		18.87	19.32	19.08
5	1	0	QPSK	19.21	19.58	19.48
5	1	12		19.23	19.67	19.53
5	1	24		19.20	19.59	19.41
5	12	0		19.36	19.73	19.64
5	12	7		19.40	19.79	19.68
5	12	13		19.35	19.79	19.62
5	25	0		19.35	19.77	19.63
5	1	0	16-QAM	18.90	19.30	19.17
5	1	12		18.96	19.44	19.33
5	1	24		18.89	19.36	19.21
5	12	0		18.85	19.22	19.10
5	12	7		18.88	19.32	19.13
5	12	13		18.83	19.29	19.09
5	25	0		18.86	19.31	19.13
5	1	0	64-QAM	18.58	18.92	18.85
5	1	12		18.58	19.01	18.90
5	1	24		18.61	19.02	18.88
5	12	0		18.90	19.22	19.16
5	12	7		18.91	19.32	19.21
5	12	13		18.87	19.29	19.17
5	25	0		18.90	19.35	19.19



LTE Band 4

Peak-to-Average Ratio

Mode	LTE Band 4 / 20MHz				
Mod.	QPSK	16QAM	64QAM	256QAM	Limit: 13dB
RB Size	Full RB	Full RB	Full RB	Full RB	Result
Middle CH	4.81	5.83	6.43	-	PASS

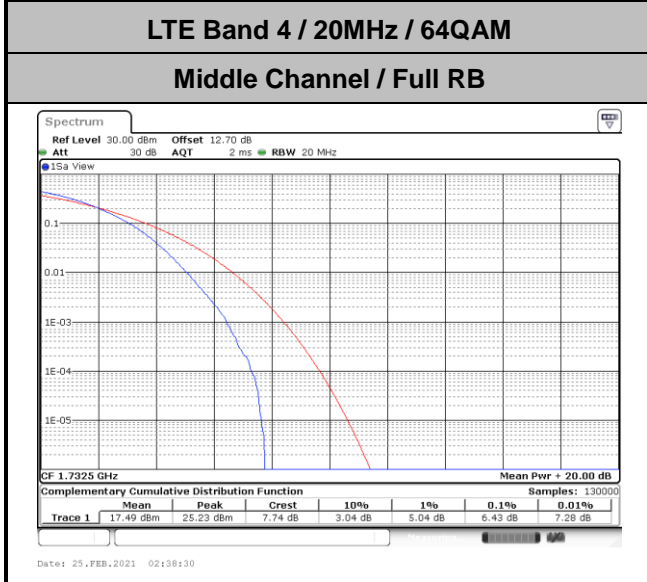
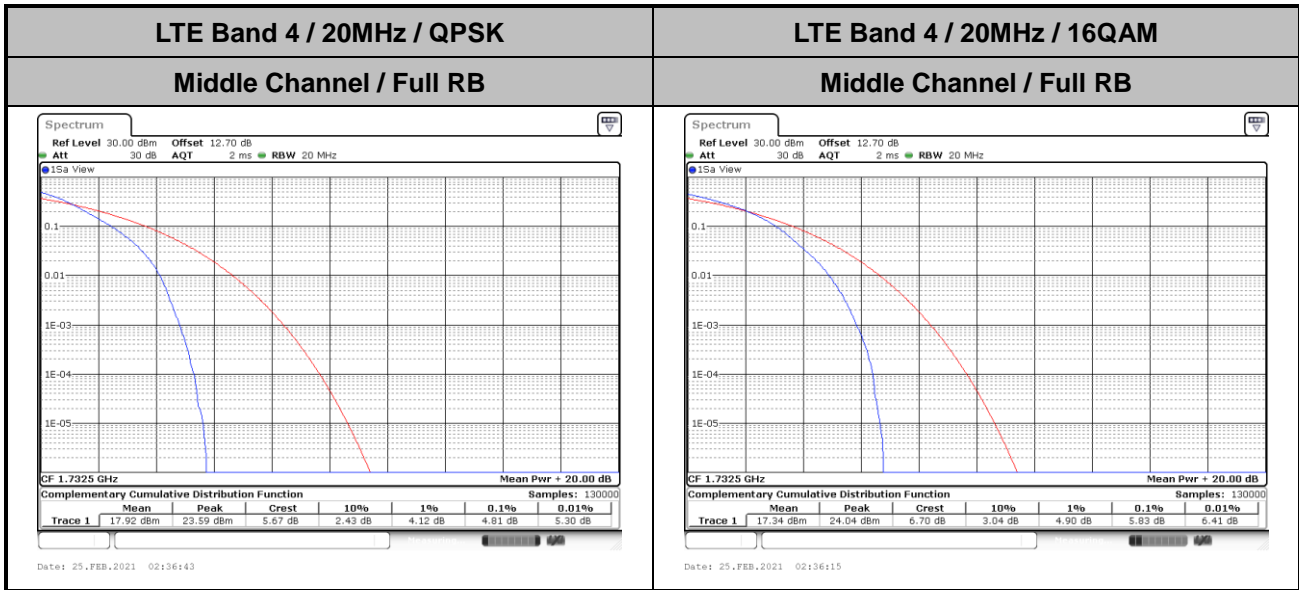



26dB Bandwidth

Mode	LTE Band 4 : 26dB BW(MHz)											
BW	1.4MHz		3MHz		5MHz		10MHz		15MHz		20MHz	
Mod.	QPSK	16QAM	QPSK	16QAM	QPSK	16QAM	QPSK	16QAM	QPSK	16QAM	QPSK	16QAM
Middle CH	1.21	1.23	3.02	3.03	4.93	4.95	9.85	9.71	14.42	14.66	18.78	18.70
Mode	LTE Band 4 : 26dB BW(MHz)											
BW	1.4MHz		3MHz		5MHz		10MHz		15MHz		20MHz	
Mod.	64QAM	256 QAM	64QAM	256 QAM	64QAM	256 QAM	64QAM	256 QAM	64QAM	256 QAM	64QAM	256 QAM
Middle CH	1.23	-	2.99	-	4.83	-	9.79	-	14.54	-	18.86	-



LTE Band 4

Middle Channel / 1.4MHz / QPSK

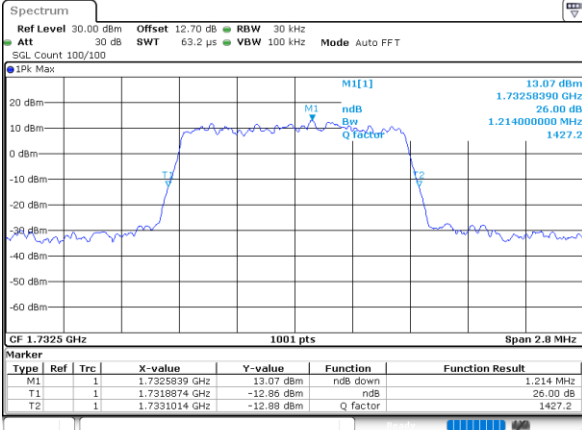

Date: 23.FEB.2021 20:05:54

Middle Channel / 1.4MHz / 16QAM

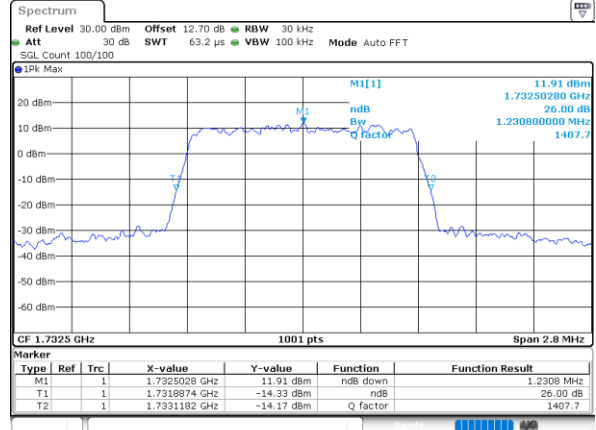

Date: 23.FEB.2021 20:06:20

Middle Channel / 3MHz / QPSK

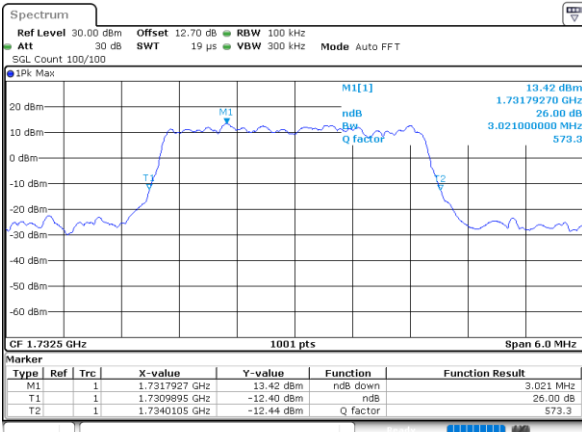

Date: 23.FEB.2021 21:08:59

Middle Channel / 3MHz / 16QAM

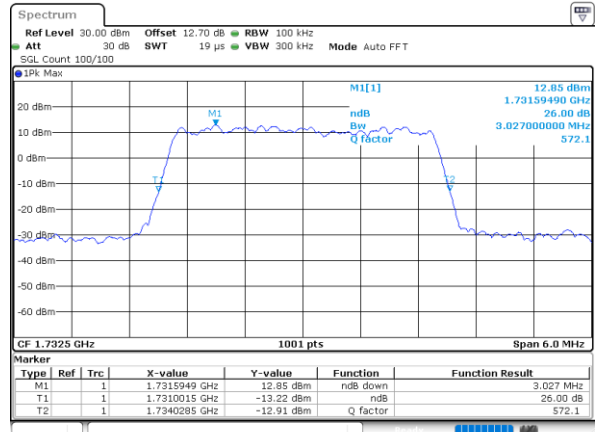

Date: 23.FEB.2021 21:09:25

Middle Channel / 5MHz / QPSK

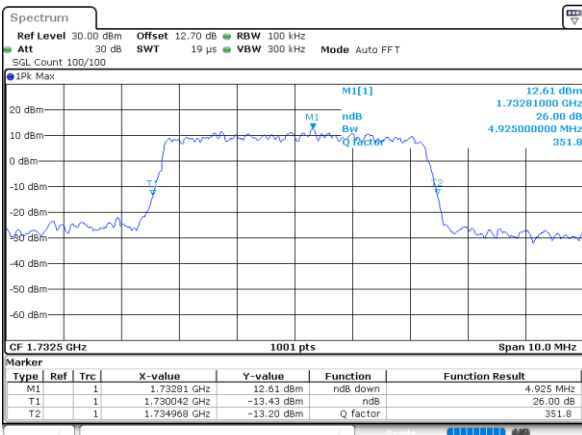

Date: 24.FEB.2021 20:11:46

Middle Channel / 5MHz / 16QAM

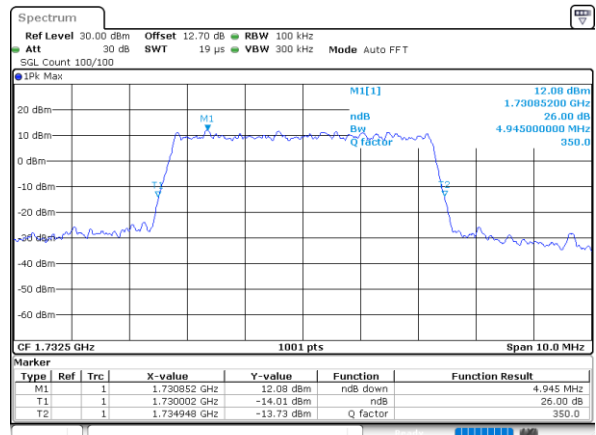

Date: 24.FEB.2021 21:45:32



LTE Band 4

Middle Channel / 10MHz / QPSK

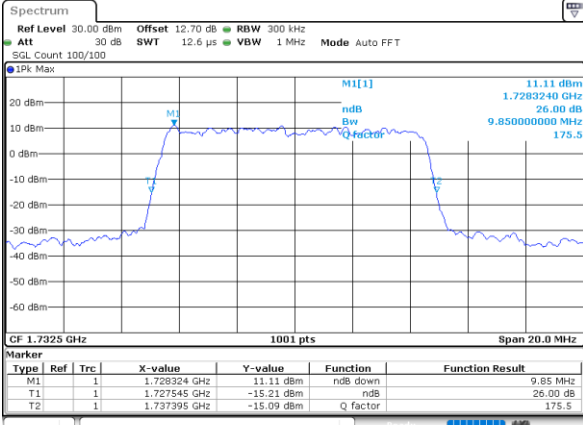

Date: 24.FEB.2021 22:21:30

Middle Channel / 10MHz / 16QAM

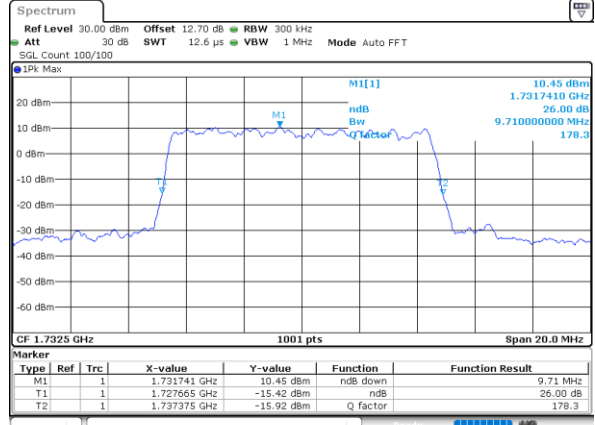

Date: 24.FEB.2021 22:22:03

Middle Channel / 15MHz / QPSK

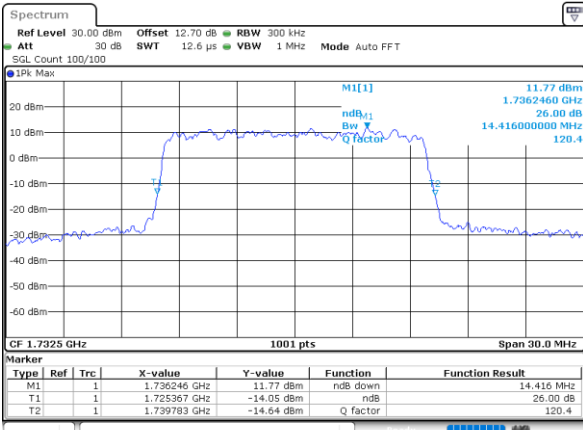

Date: 25.FEB.2021 01:46:57

Middle Channel / 15MHz / 16QAM

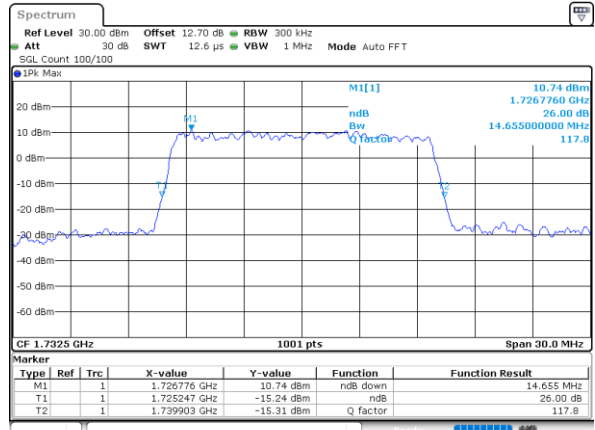

Date: 25.FEB.2021 01:47:23

Middle Channel / 20MHz / QPSK

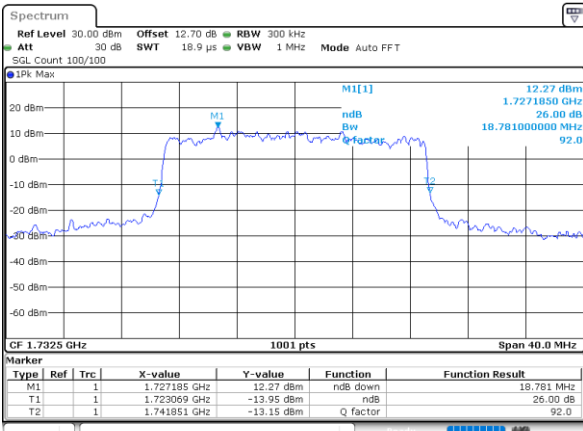

Date: 25.FEB.2021 02:15:46

Middle Channel / 20MHz / 16QAM

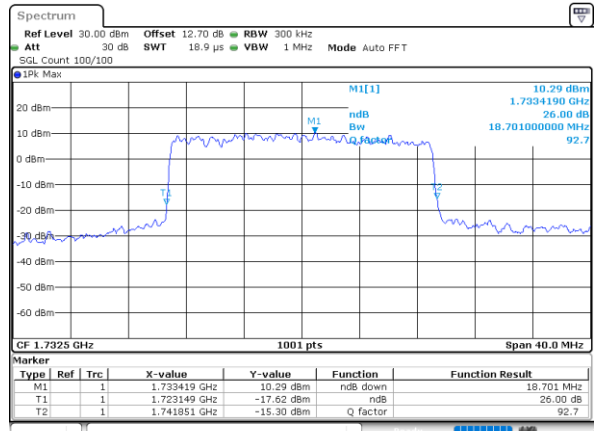

Date: 25.FEB.2021 02:16:11



LTE Band 4

Middle Channel / 1.4MHz / 64QAM

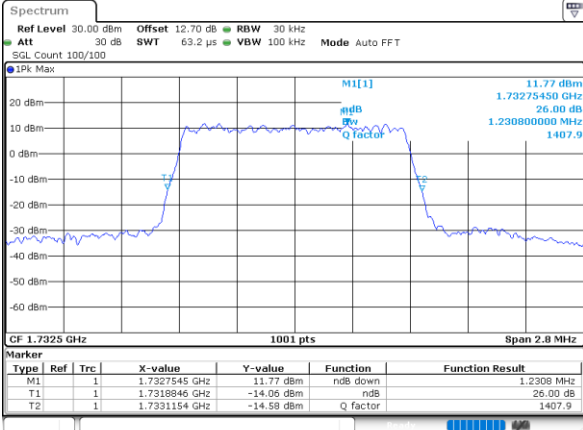

Date: 23.FEB.2021 20:32:25

Middle Channel / 3MHz / 64QAM

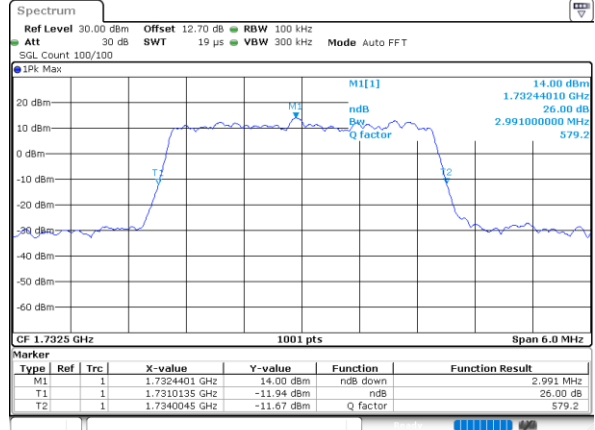

Date: 23.FEB.2021 21:22:07

Middle Channel / 5MHz / 64QAM

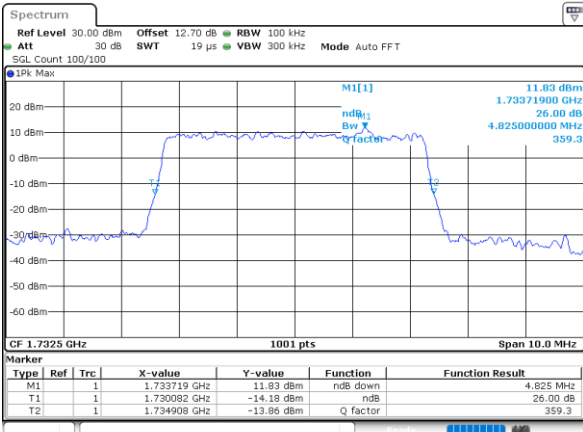

Date: 24.FEB.2021 01:42:48

Middle Channel / 10MHz / 64QAM

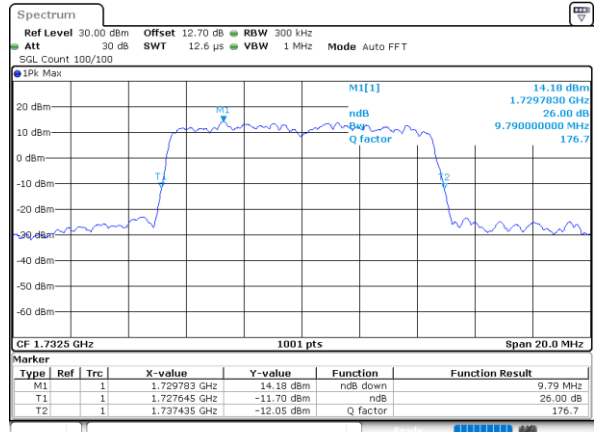

Date: 24.FEB.2021 23:32:23

Middle Channel / 15MHz / 64QAM

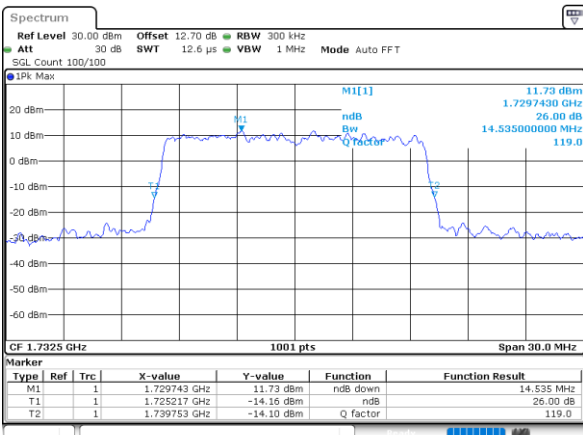

Date: 25.FEB.2021 01:58:01

Middle Channel / 20MHz / 64QAM

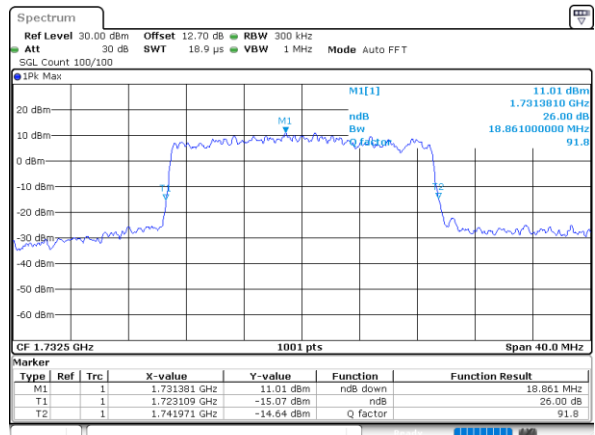

Date: 25.FEB.2021 02:30:12



Occupied Bandwidth

Mode	LTE Band 4 : 99%OBW(MHz)											
BW	1.4MHz		3MHz		5MHz		10MHz		15MHz		20MHz	
Mod.	QPSK	16QAM	QPSK	16QAM	QPSK	16QAM	QPSK	16QAM	QPSK	16QAM	QPSK	16QAM
Middle CH	1.09	1.09	2.70	2.73	4.50	4.49	9.05	9.01	13.43	13.46	17.86	17.78
Mode	LTE Band 4 : 99%OBW(MHz)											
BW	1.4MHz		3MHz		5MHz		10MHz		15MHz		20MHz	
Mod.	64QAM	256 QAM	64QAM	256 QAM	64QAM	256 QAM	64QAM	256 QAM	64QAM	256 QAM	64QAM	256 QAM
Middle CH	1.09	-	2.72	-	4.49	-	8.99	-	13.37	-	17.82	-



LTE Band 4

Middle Channel / 1.4MHz / QPSK

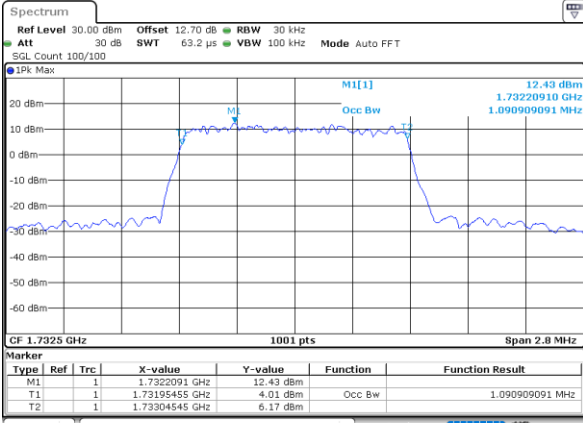

Date: 23.FEB.2021 20:05:00

Middle Channel / 1.4MHz / 16QAM

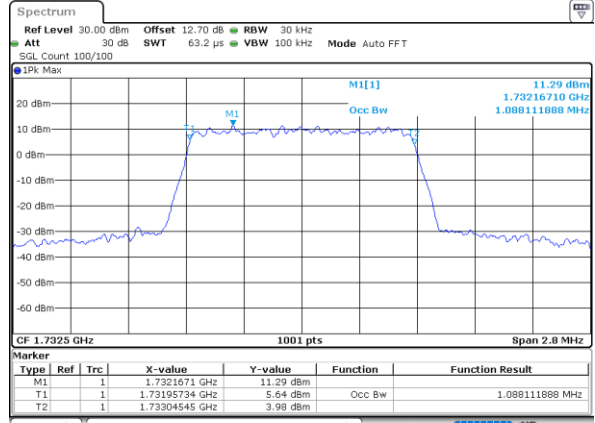

Date: 23.FEB.2021 20:05:27

Middle Channel / 3MHz / QPSK

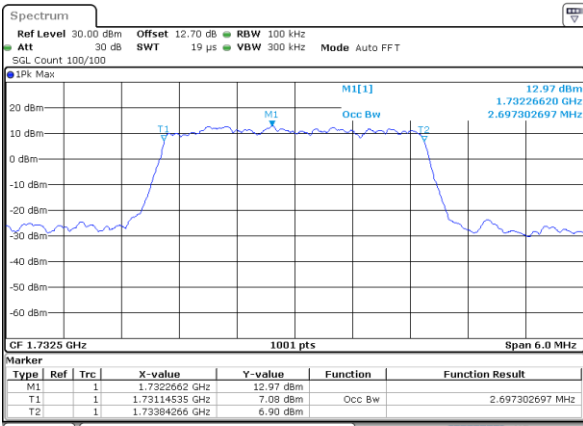

Date: 23.FEB.2021 21:08:04

Middle Channel / 3MHz / 16QAM

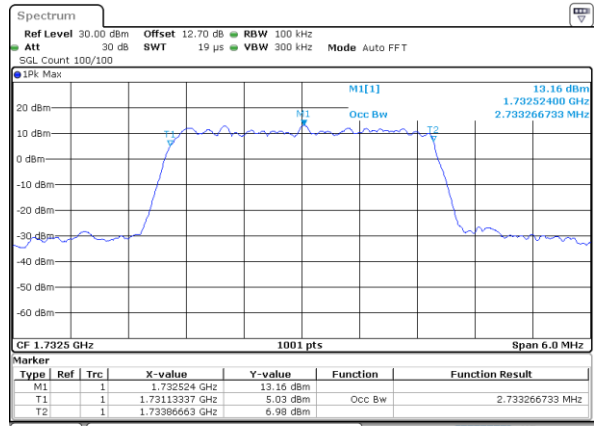

Date: 23.FEB.2021 21:08:32

Middle Channel / 5MHz / QPSK

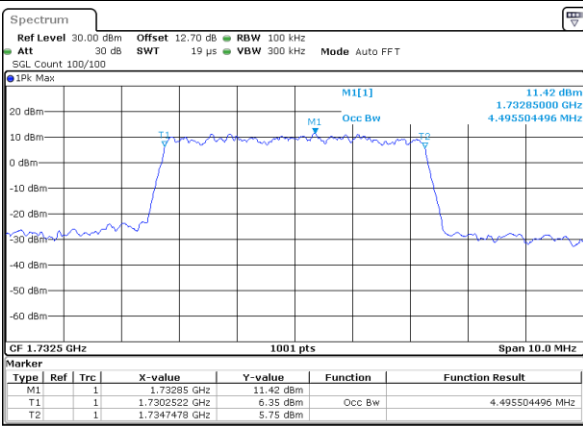

Date: 24.FEB.2021 20:10:51

Middle Channel / 5MHz / 16QAM

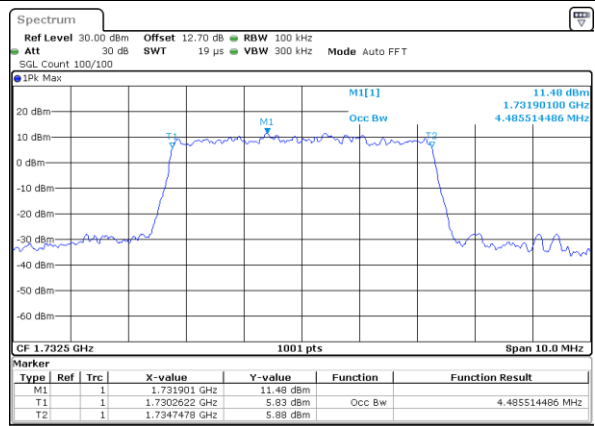

Date: 24.FEB.2021 20:11:18



LTE Band 4

Middle Channel / 10MHz / QPSK

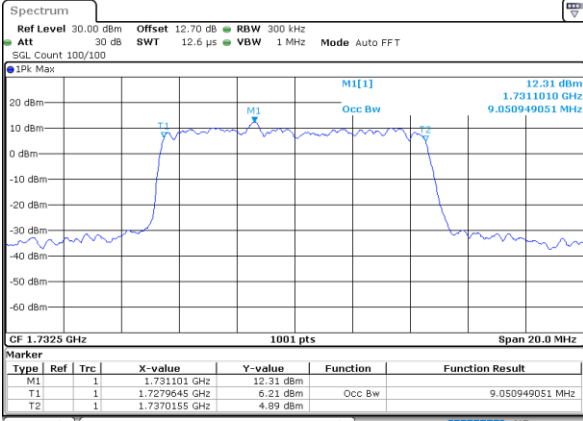

Date: 24.FEB.2021 22:20:43

Middle Channel / 10MHz / 16QAM

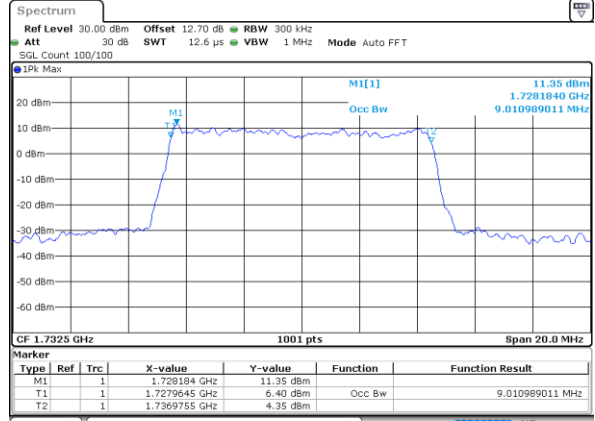

Date: 24.FEB.2021 22:21:11

Middle Channel / 15MHz / QPSK

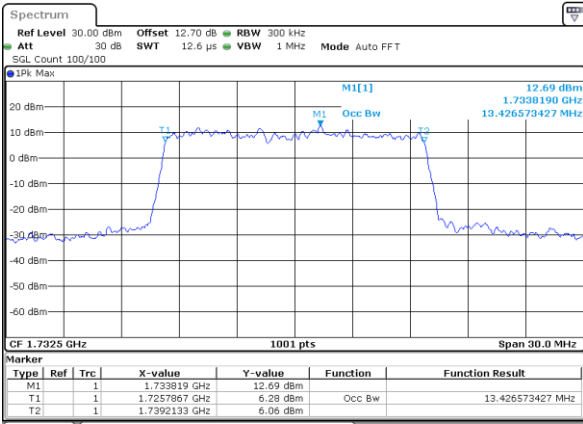

Date: 25.FEB.2021 01:46:03

Middle Channel / 15MHz / 16QAM

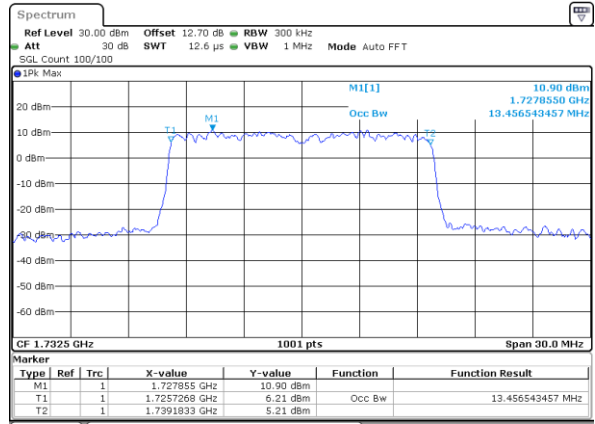

Date: 25.FEB.2021 01:46:30

Middle Channel / 20MHz / QPSK

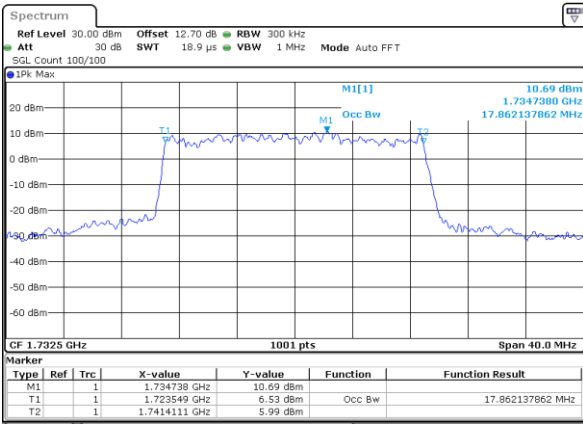

Date: 25.FEB.2021 02:14:51

Middle Channel / 20MHz / 16QAM

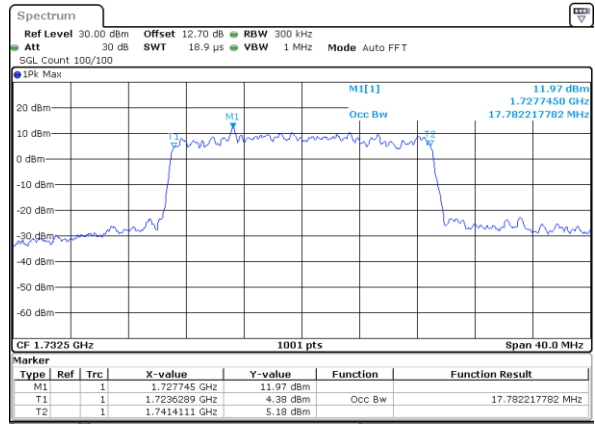

Date: 25.FEB.2021 02:15:18



LTE Band 4

Middle Channel / 1.4MHz / 64QAM

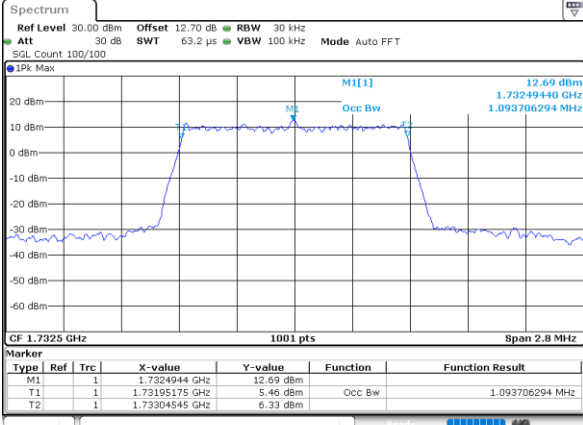

Date: 23.FEB.2021 20:32:09

Middle Channel / 3MHz / 64QAM

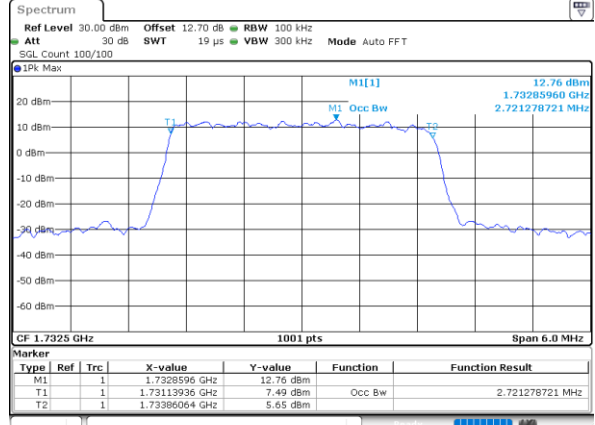

Date: 23.FEB.2021 21:12:151

Middle Channel / 5MHz / 64QAM

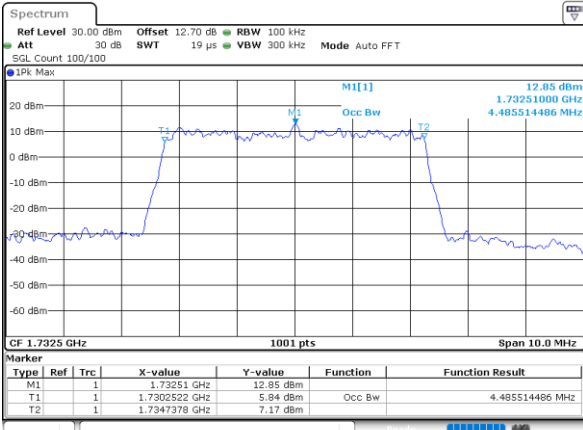

Date: 24.FEB.2021 01:42:32

Middle Channel / 10MHz / 64QAM

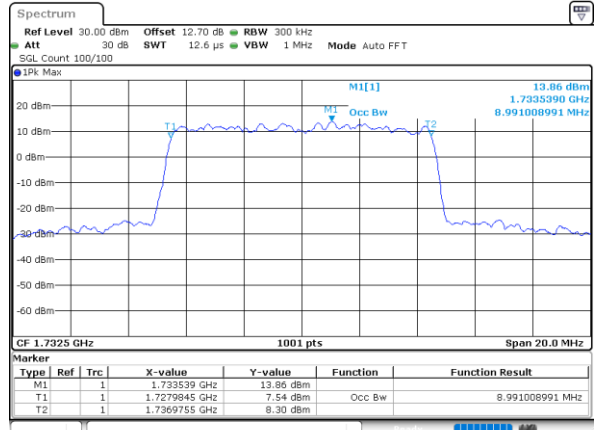

Date: 24.FEB.2021 23:32:107

Middle Channel / 15MHz / 64QAM

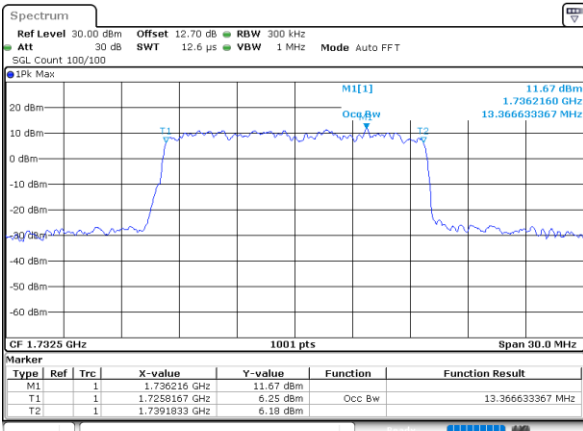

Date: 25.FEB.2021 01:57:45

Middle Channel / 20MHz / 64QAM

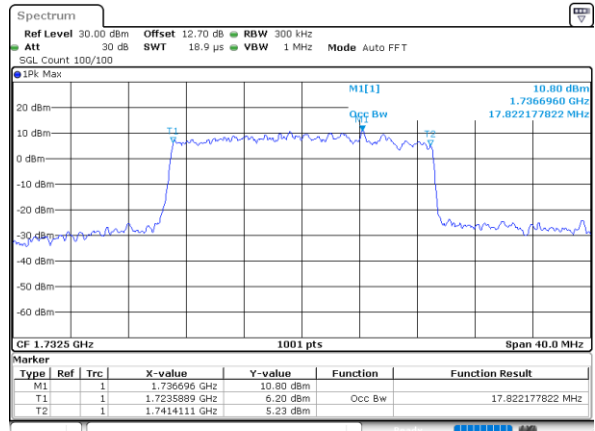

Date: 25.FEB.2021 02:12:556



Conducted Band Edge

LTE Band 4 / 1.4MHz / QPSK

Lowest Band Edge / 1RB

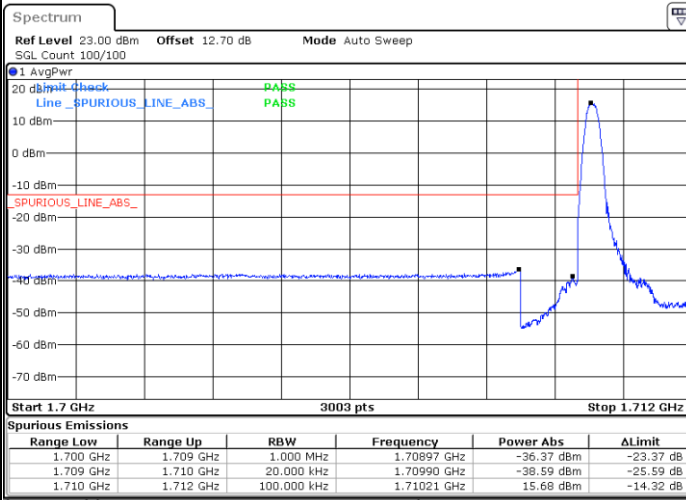

Date: 23.FEB.2021 20:00:17

Highest Band Edge / 1RB

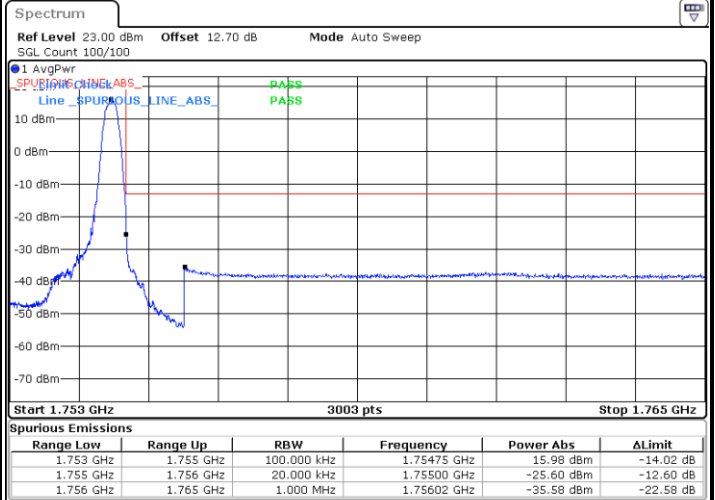

Date: 23.FEB.2021 20:15:16

Lowest Band Edge / Full RB

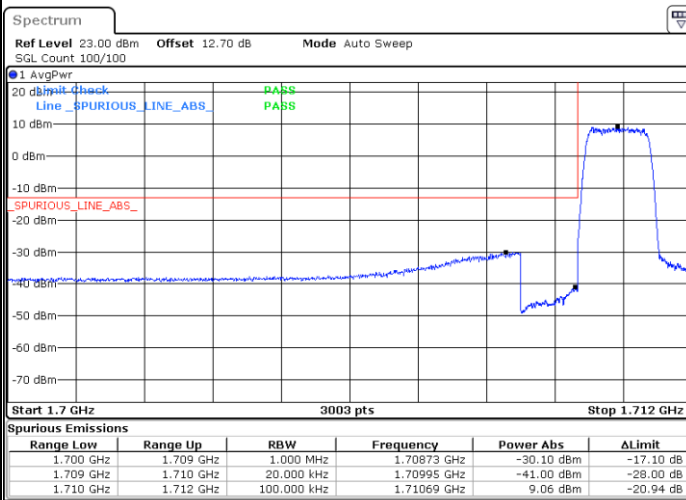

Date: 23.FEB.2021 20:02:07

Highest Band Edge / Full RB

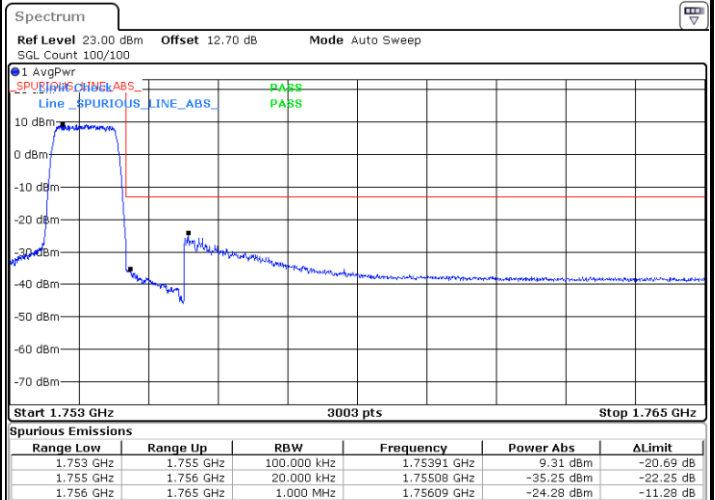

Date: 23.FEB.2021 20:17:05



LTE Band 4 / 1.4MHz / 16QAM

Lowest Band Edge / 1 RB

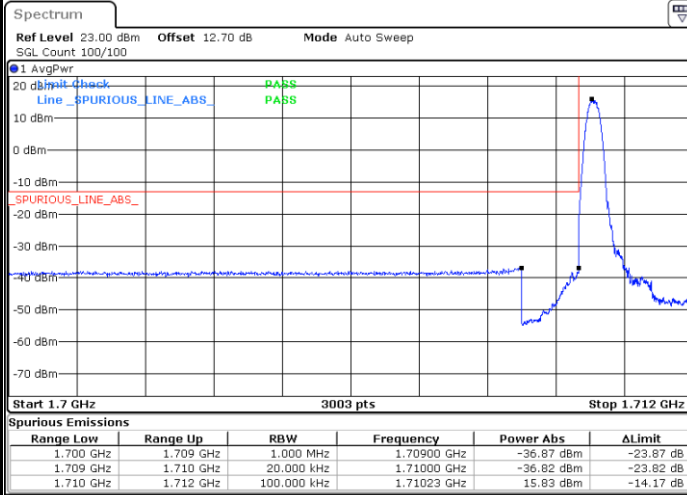

Date: 23.FEB.2021 20:01:12

Highest Band Edge / 1 RB

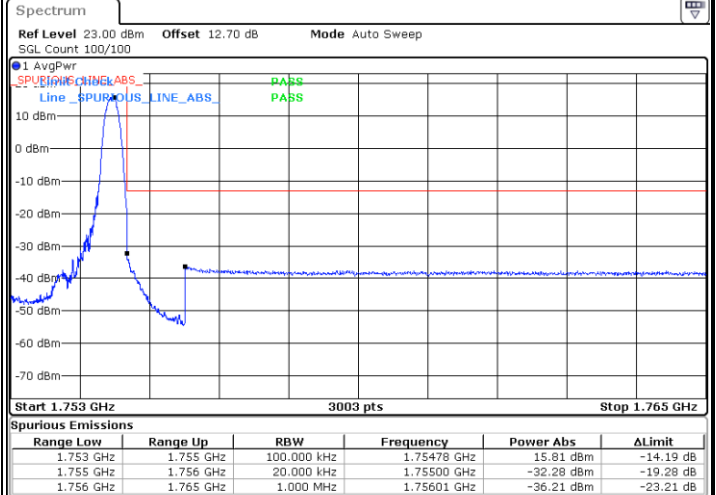

Date: 23.FEB.2021 20:16:11

Lowest Band Edge / Full RB

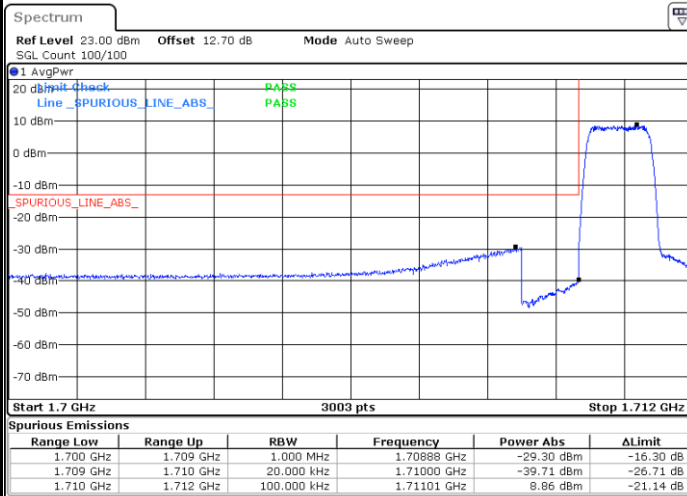

Date: 23.FEB.2021 20:03:01

Highest Band Edge / Full RB

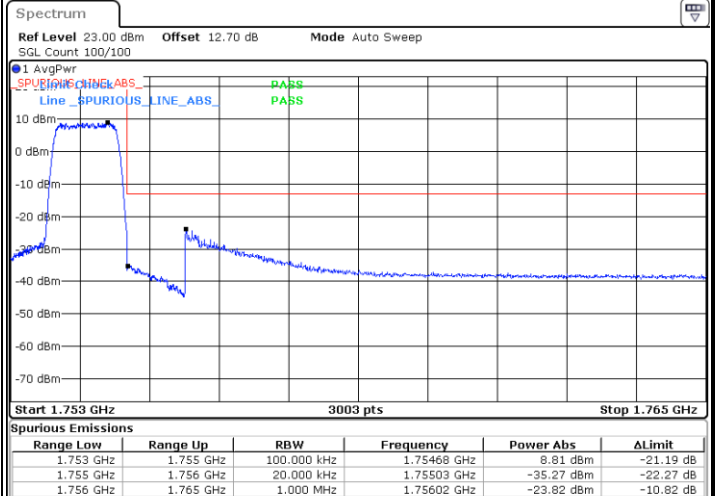

Date: 23.FEB.2021 20:18:00



LTE Band 4 / 1.4MHz / 64QAM

Lowest Band Edge / 1 RB

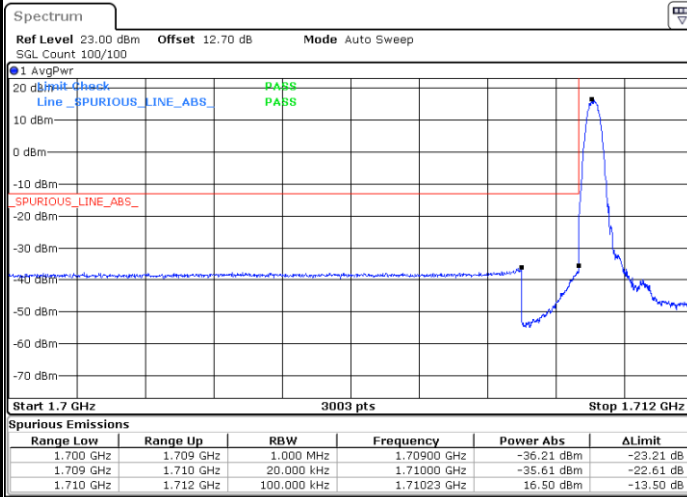

Date: 23.FEB.2021 20:30:10

Highest Band Edge / 1 RB

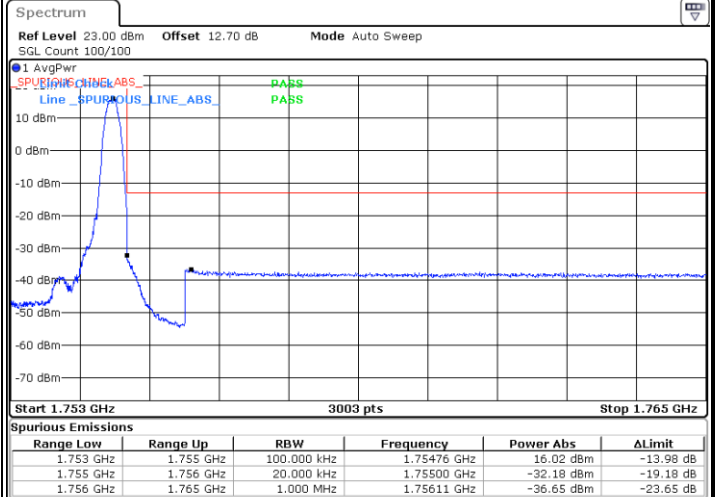

Date: 23.FEB.2021 20:37:40

Lowest Band Edge / Full RB

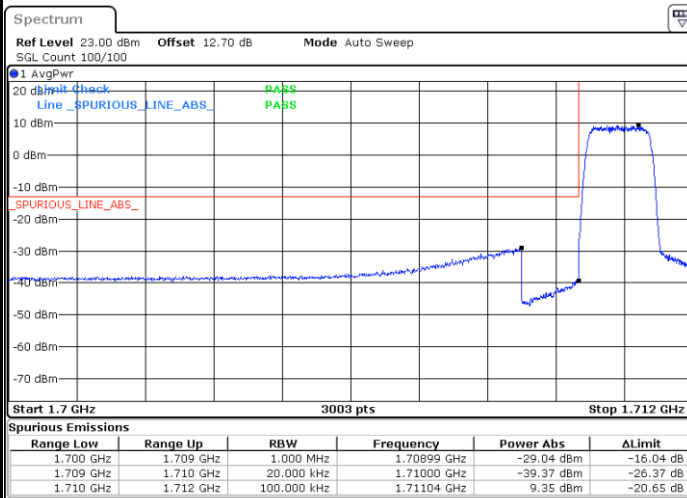

Date: 23.FEB.2021 20:31:05

Highest Band Edge / Full RB

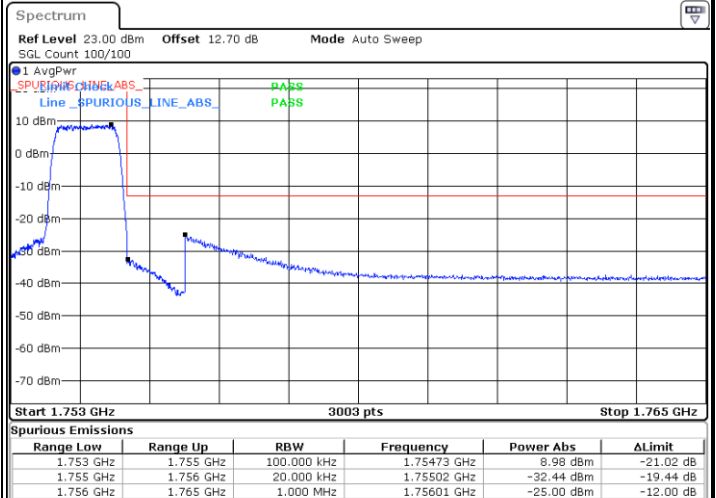

Date: 23.FEB.2021 20:38:34



LTE Band 4 / 3MHz / QPSK

Lowest Band Edge / 1RB

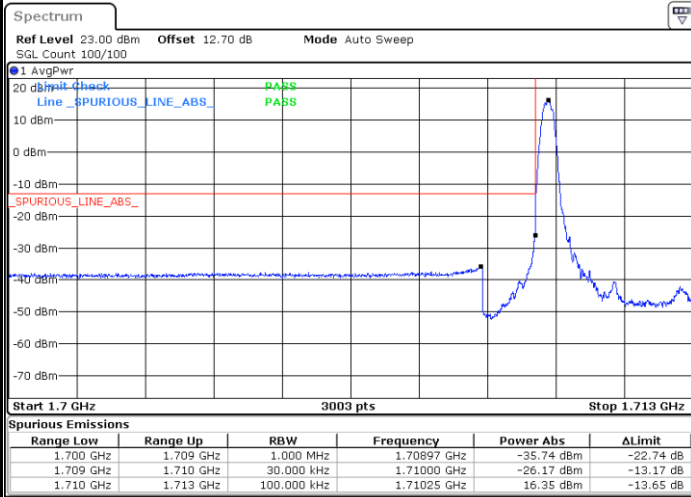

Date: 23.FEB.2021 21:02:17

Highest Band Edge / 1 RB

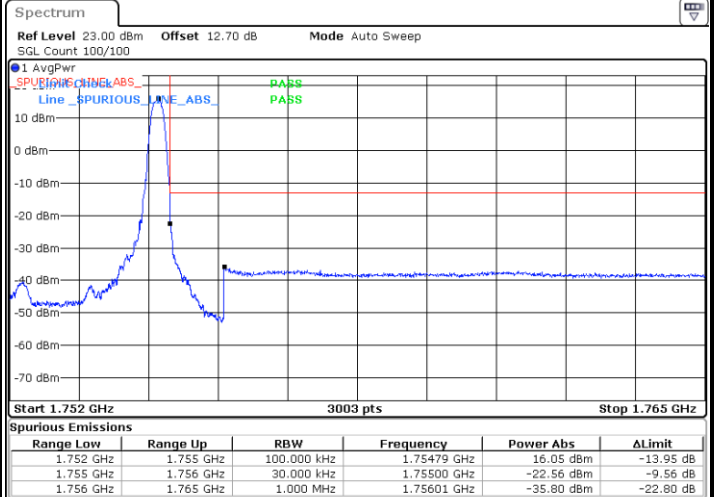

Date: 23.FEB.2021 21:13:36

Lowest Band Edge / Full RB

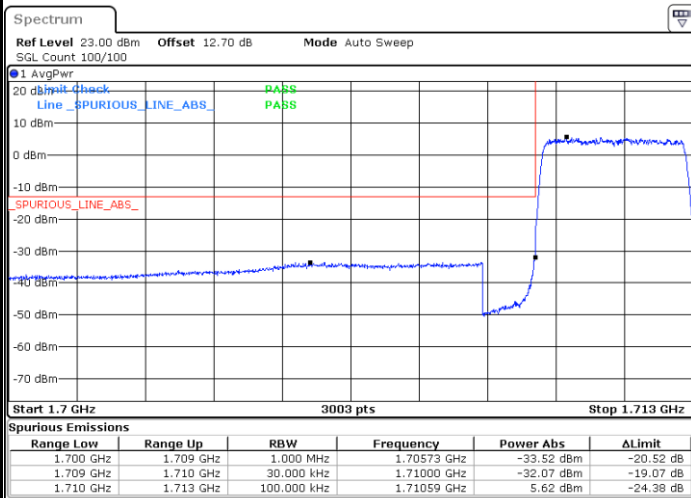

Date: 23.FEB.2021 21:04:06

Highest Band Edge / Full RB

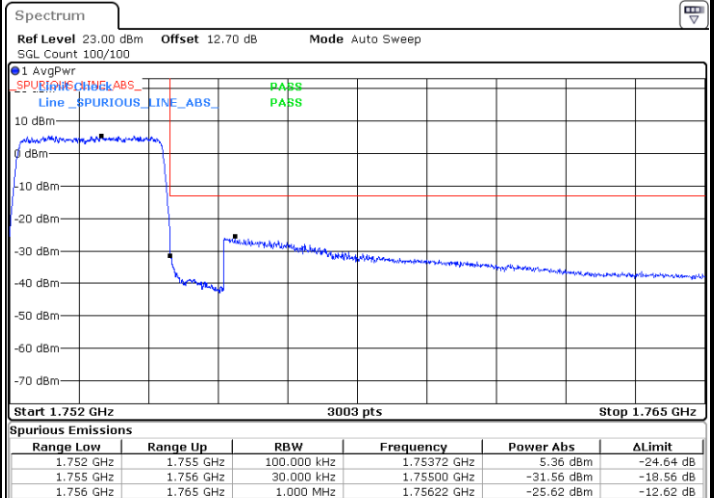

Date: 23.FEB.2021 21:15:25



LTE Band 4 / 3MHz / 16QAM

Lowest Band Edge / 1 RB

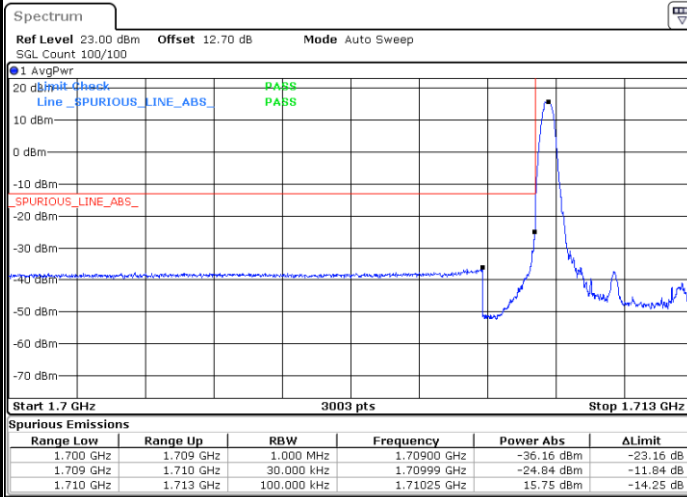

Date: 23.FEB.2021 21:03:12

Highest Band Edge / 1 RB

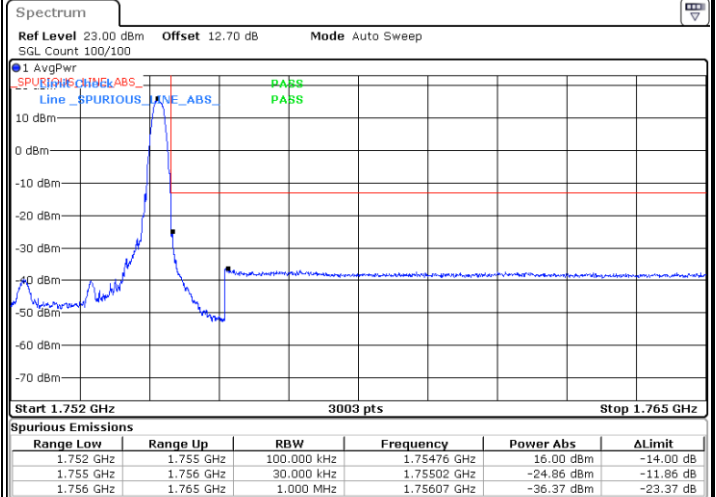

Date: 23.FEB.2021 21:14:31

Lowest Band Edge / Full RB

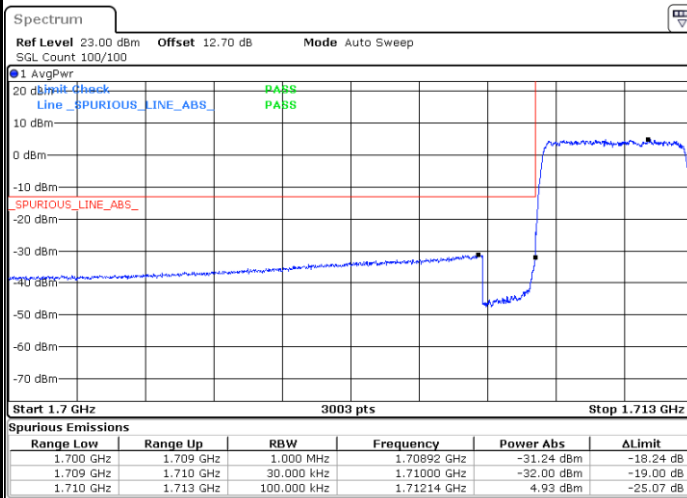

Date: 23.FEB.2021 21:05:01

Highest Band Edge / Full RB

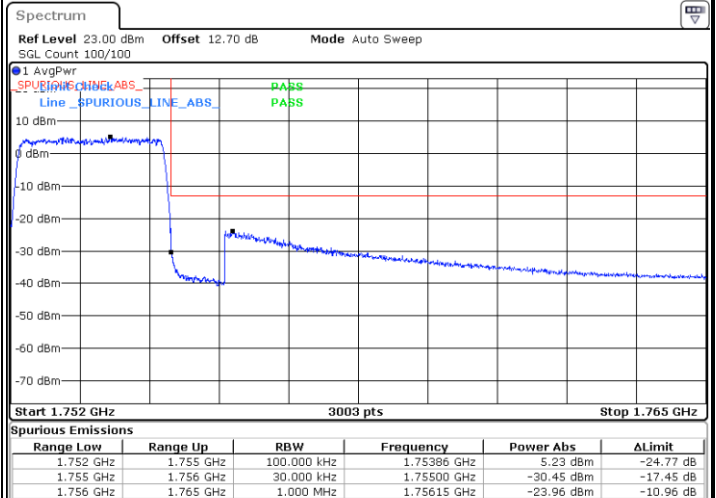

Date: 23.FEB.2021 21:16:20



LTE Band 4 / 3MHz / 64QAM

Lowest Band Edge / 1 RB

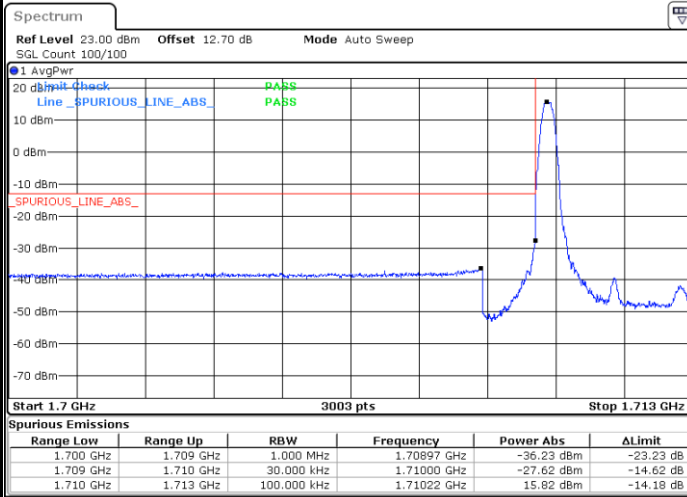

Date: 23.FEB.2021 21:19:52

Highest Band Edge / 1 RB

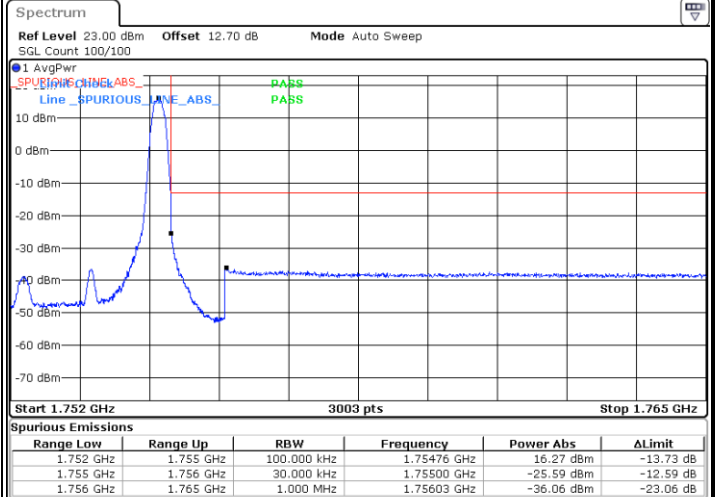

Date: 23.FEB.2021 21:23:41

Lowest Band Edge / Full RB

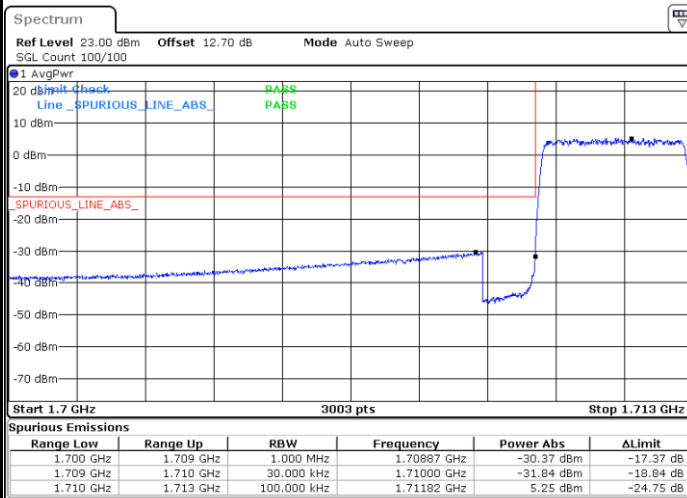

Date: 23.FEB.2021 21:20:47

Highest Band Edge / Full RB

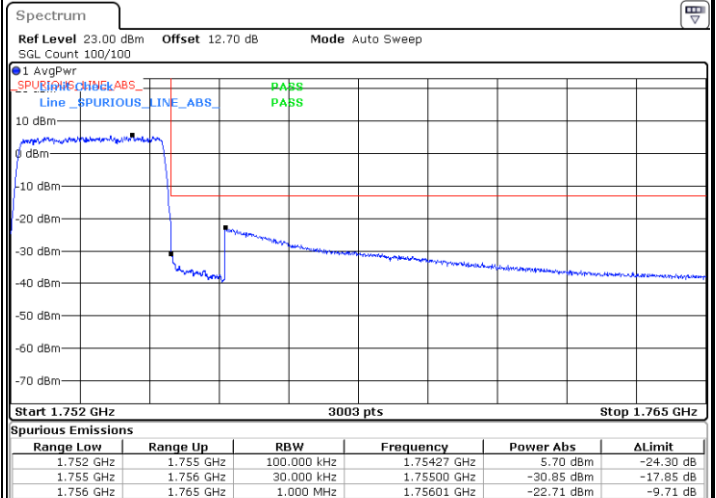

Date: 23.FEB.2021 21:24:35



LTE Band 4 / 5MHz / QPSK

Lowest Band Edge / 1 RB

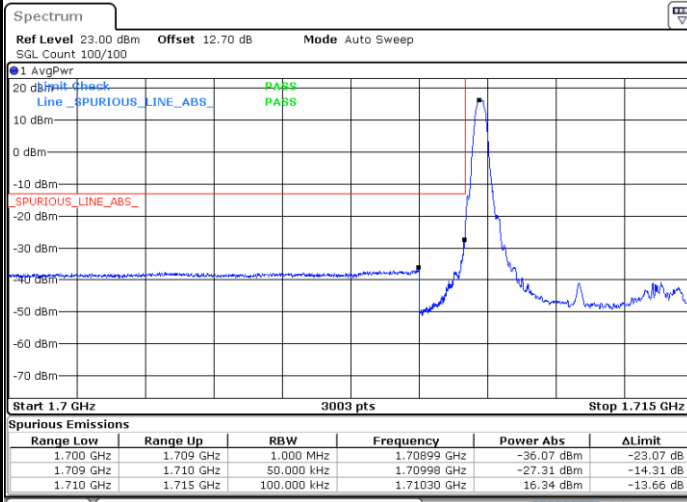

Date: 24.FEB.2021 01:46:58

Highest Band Edge / 1 RB

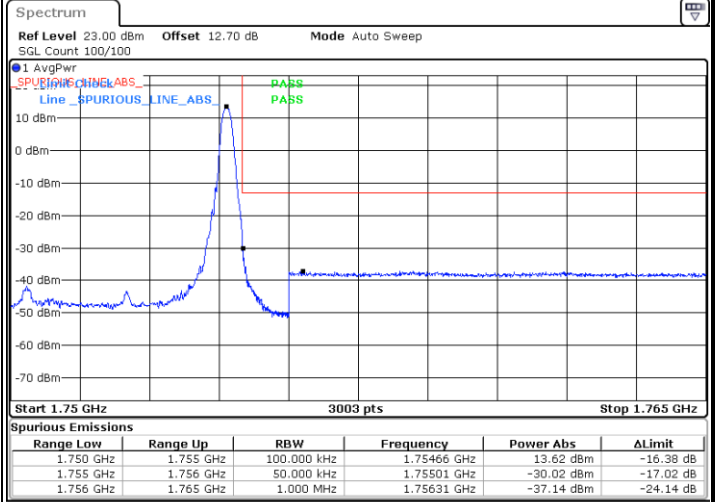

Date: 24.FEB.2021 22:11:00

Lowest Band Edge / Full RB

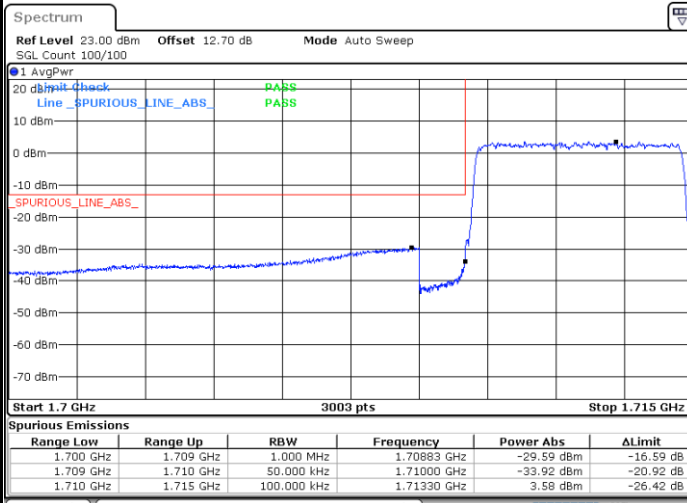

Date: 24.FEB.2021 20:09:02

Highest Band Edge / Full RB

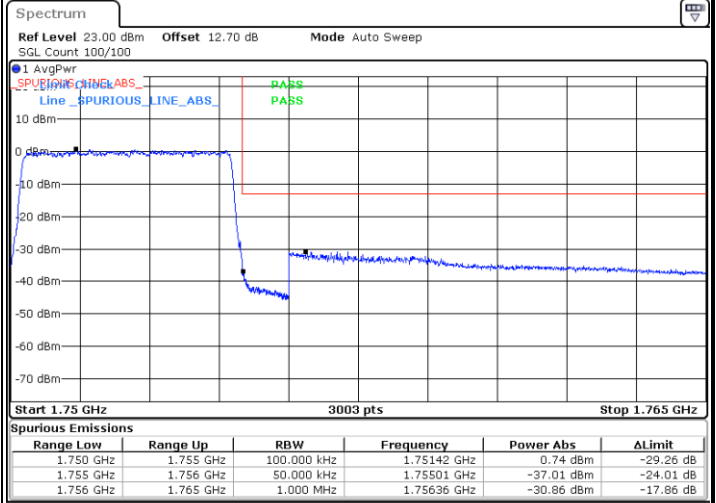

Date: 24.FEB.2021 22:11:59



LTE Band 4 / 5MHz / 16QAM

Lowest Band Edge / 1RB

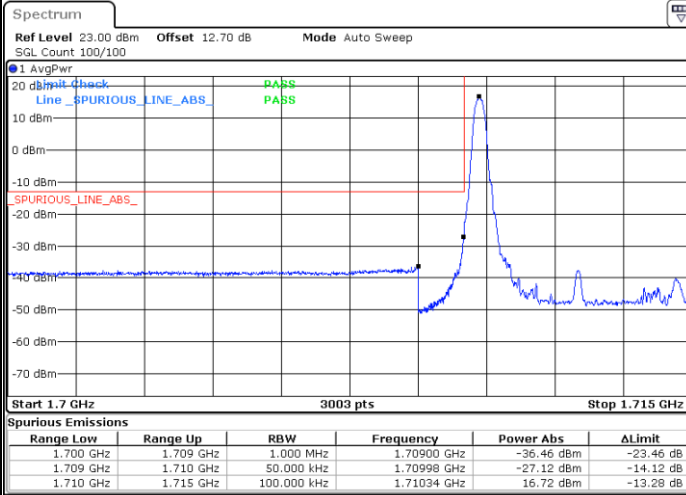

Date: 24.FEB.2021 01:47:26

Highest Band Edge / 1 RB

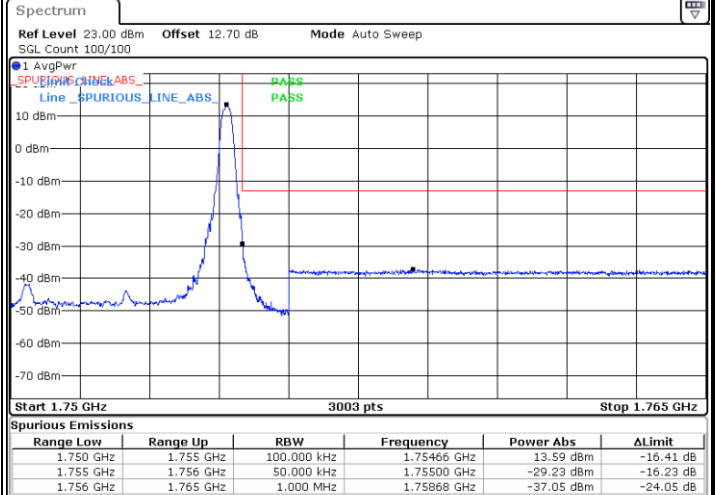

Date: 24.FEB.2021 22:11:30

Lowest Band Edge / Full RB

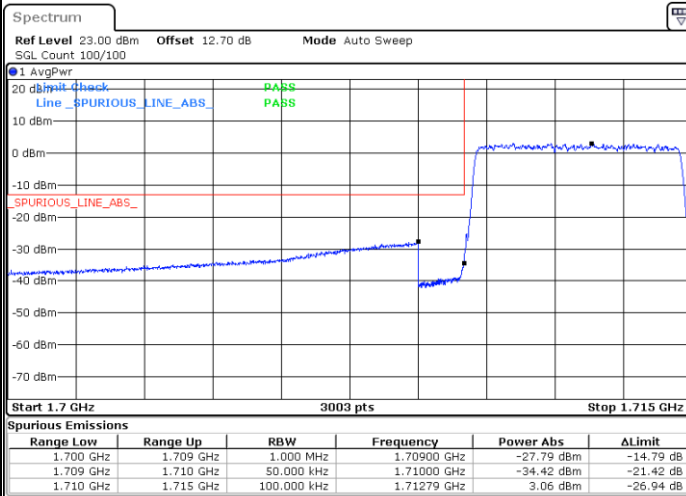

Date: 24.FEB.2021 20:09:32

Highest Band Edge / Full RB

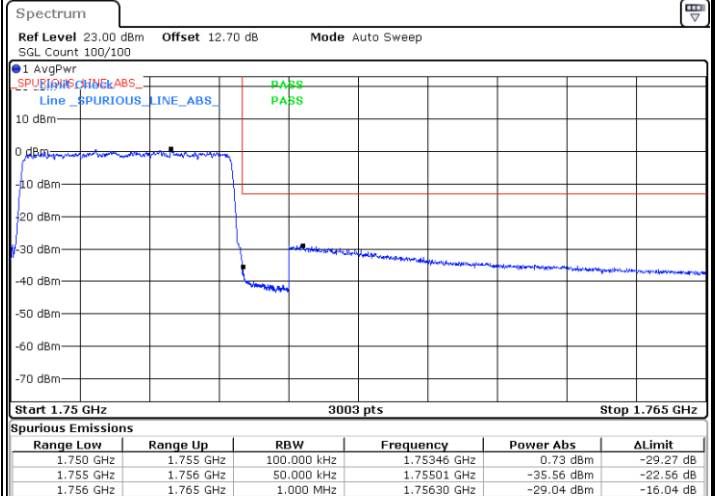

Date: 24.FEB.2021 22:12:28



LTE Band 4 / 5MHz / 64QAM

Lowest Band Edge / 1RB

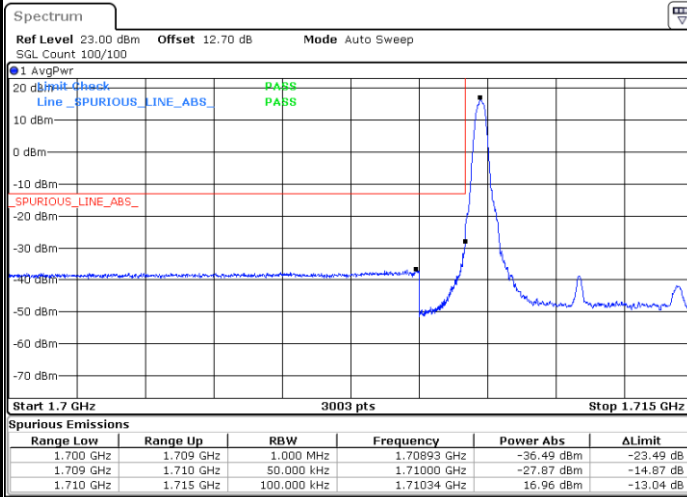

Date: 23.FEB.2021 21:26:37

Highest Band Edge / 1 RB

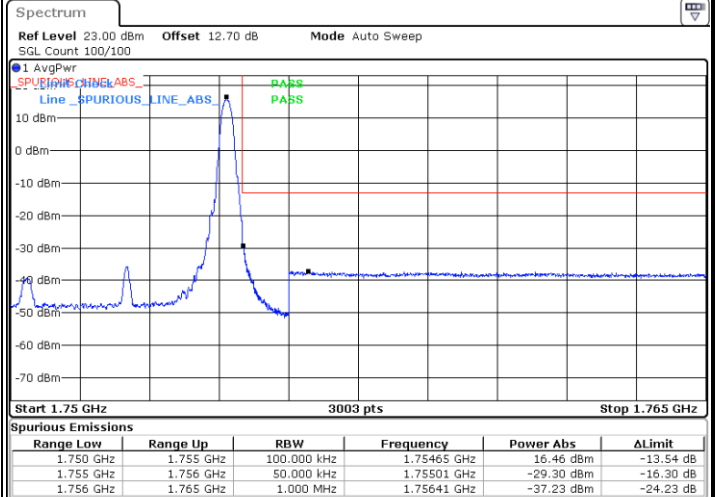

Date: 24.FEB.2021 01:44:02

Lowest Band Edge / Full RB

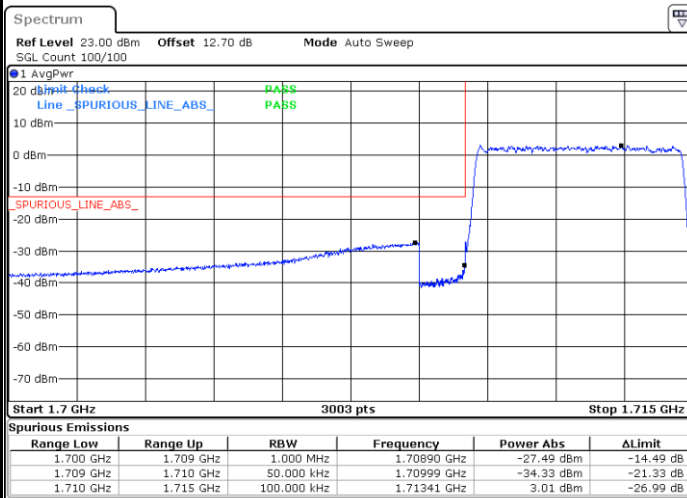

Date: 24.FEB.2021 01:41:28

Highest Band Edge / Full RB

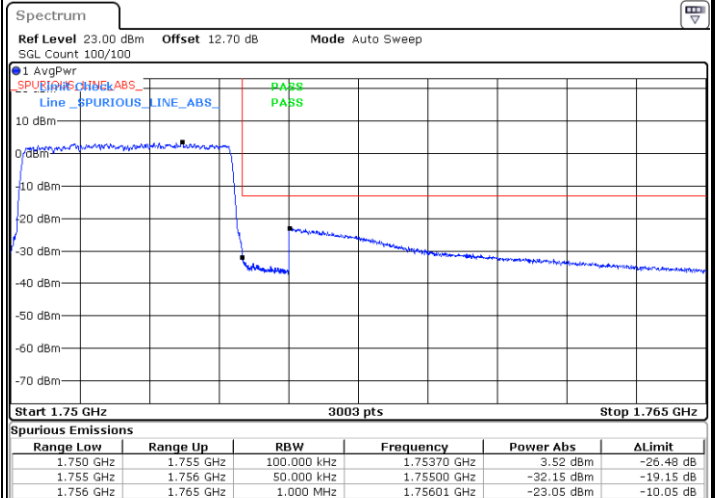

Date: 24.FEB.2021 01:45:52



LTE Band 4 / 10MHz / QPSK

Lowest Band Edge / 1 RB

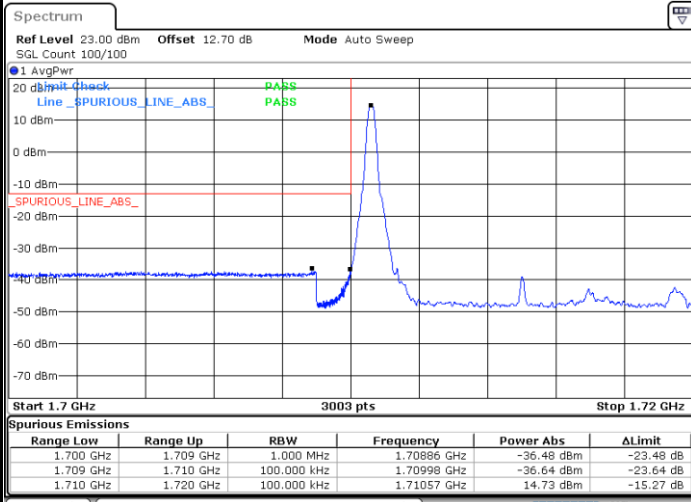

Date: 24.FEB.2021 22:17:18

Highest Band Edge / 1 RB

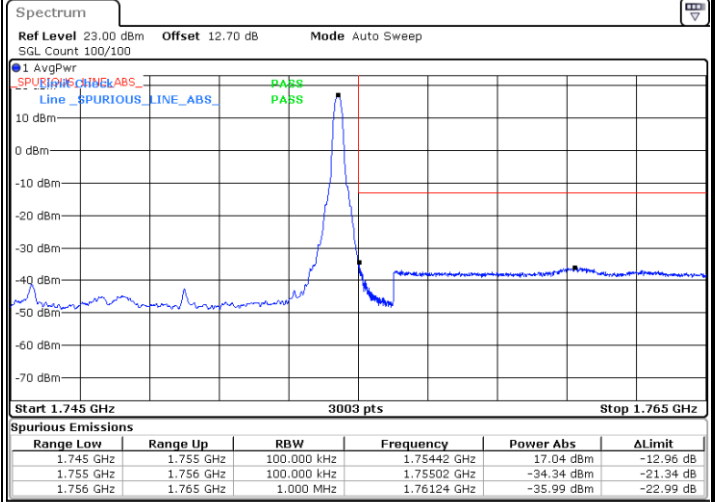

Date: 24.FEB.2021 23:27:15

Lowest Band Edge / Full RB

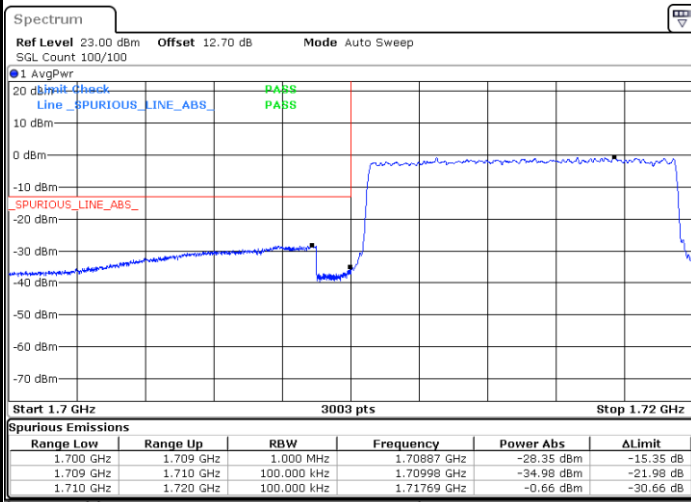

Date: 24.FEB.2021 22:18:16

Highest Band Edge / Full RB

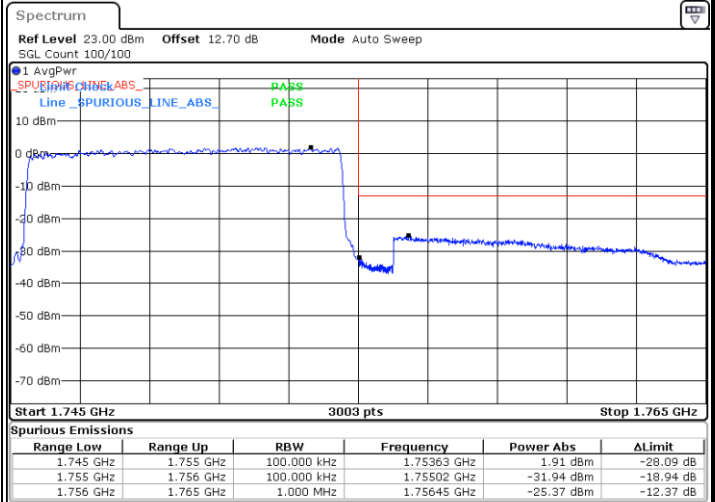

Date: 24.FEB.2021 23:28:14



LTE Band 4 / 10MHz / 16QAM

Lowest Band Edge / 1 RB

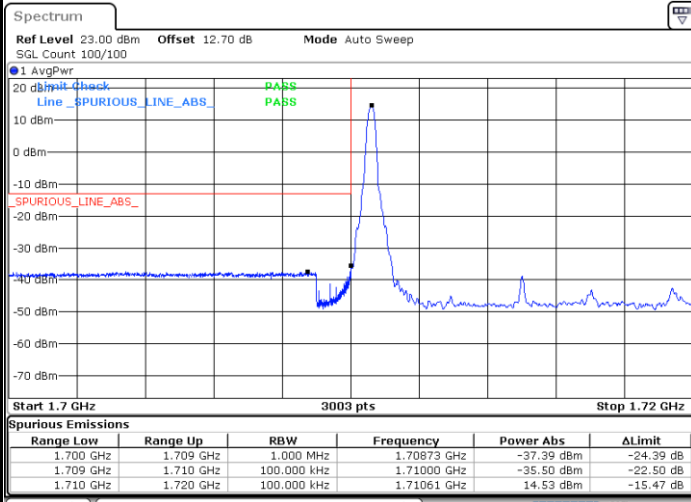

Date: 24.FEB.2021 22:17:47

Highest Band Edge / 1 RB

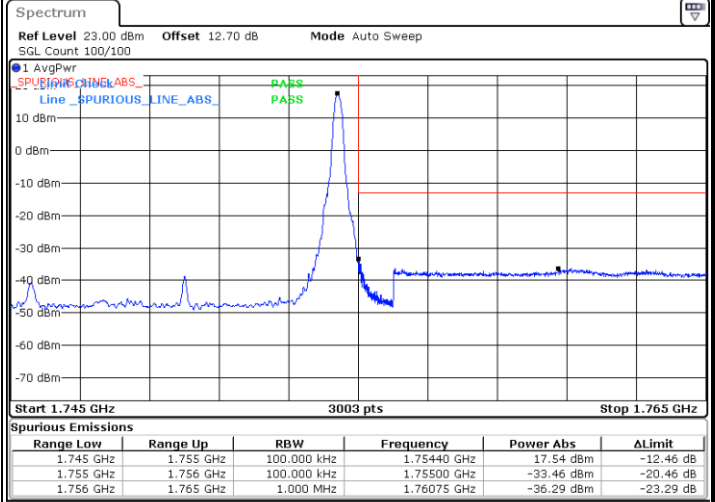

Date: 24.FEB.2021 23:27:45

Lowest Band Edge / Full RB

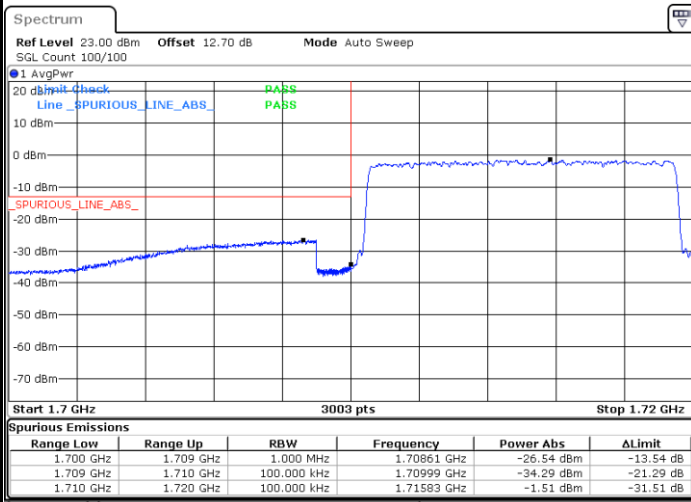

Date: 24.FEB.2021 22:18:45

Highest Band Edge / Full RB

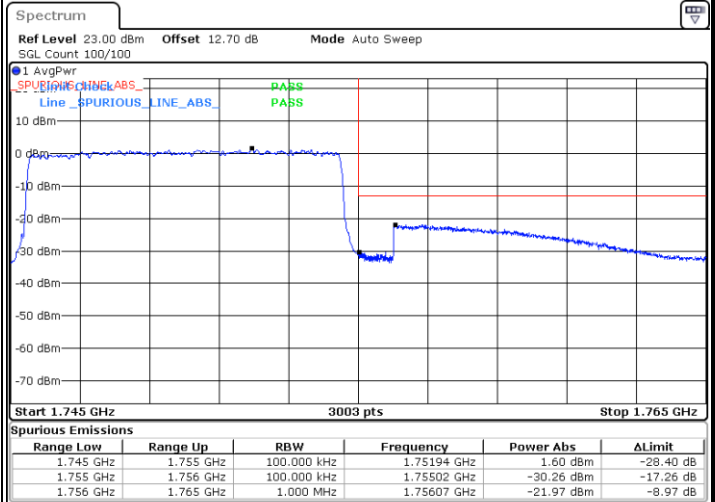

Date: 24.FEB.2021 23:28:43



LTE Band 4 / 10MHz / 64QAM

Lowest Band Edge / 1 RB

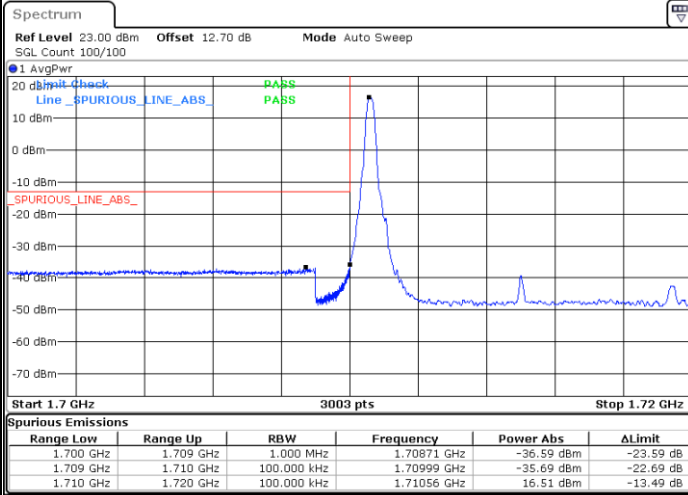

Date: 24.FEB.2021 23:31:13

Highest Band Edge / 1 RB

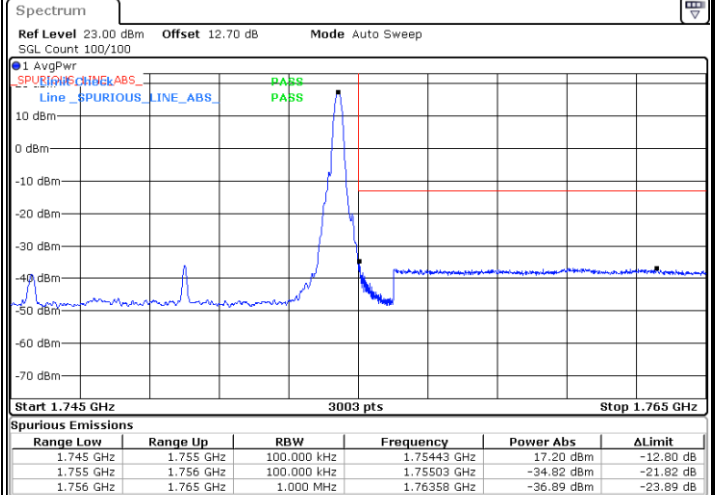

Date: 24.FEB.2021 23:33:31

Lowest Band Edge / Full RB

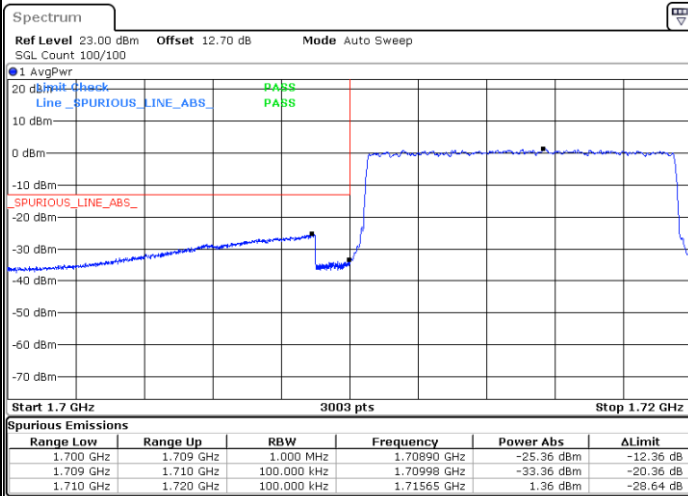

Date: 24.FEB.2021 23:31:42

Highest Band Edge / Full RB

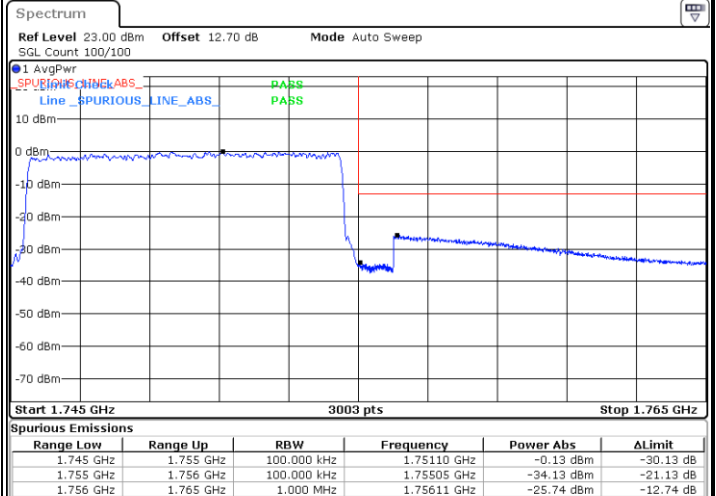

Date: 25.FEB.2021 02:40:13



LTE Band 4 / 15MHz / QPSK

Lowest Band Edge / 1 RB

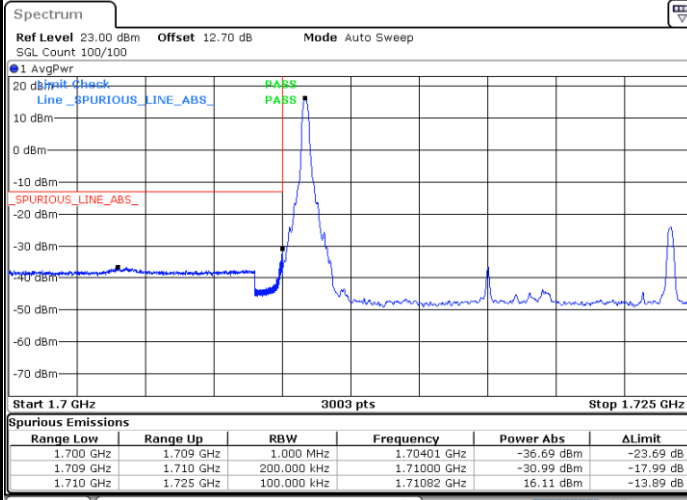

Date: 25.FEB.2021 01:42:38

Highest Band Edge / 1 RB

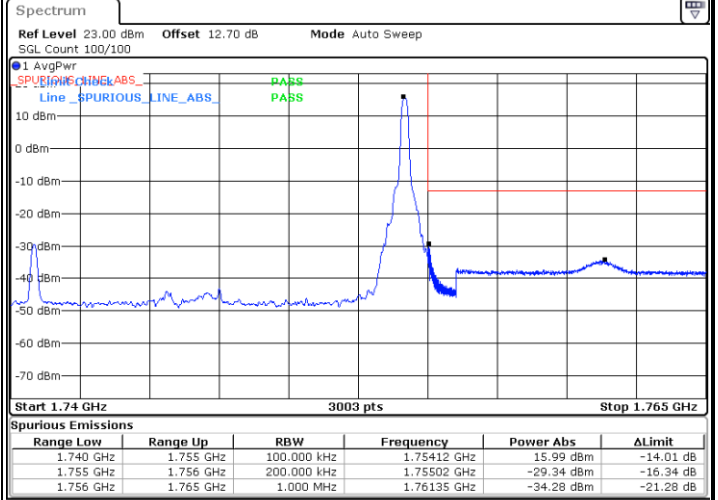

Date: 25.FEB.2021 01:52:44

Lowest Band Edge / Full RB

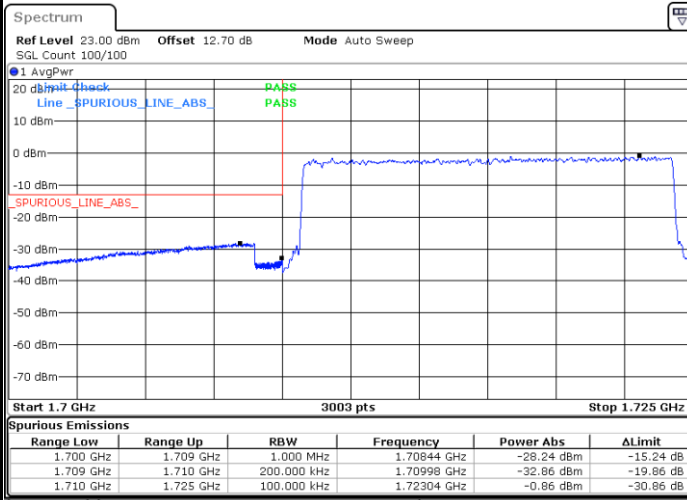

Date: 25.FEB.2021 01:43:36

Highest Band Edge / Full RB

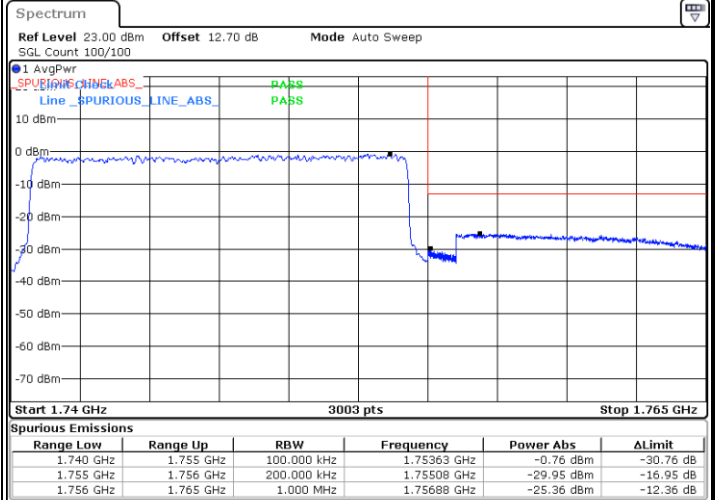

Date: 25.FEB.2021 01:53:42



LTE Band 4 / 15MHz / 16QAM

Lowest Band Edge / 1 RB

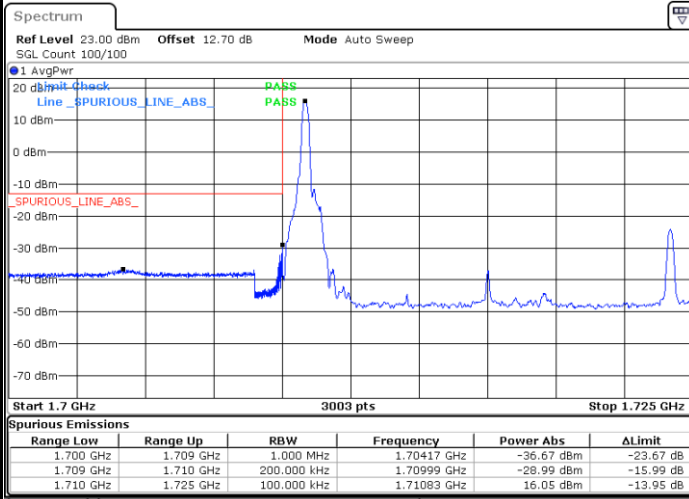

Date: 25.FEB.2021 01:43:07

Highest Band Edge / 1 RB

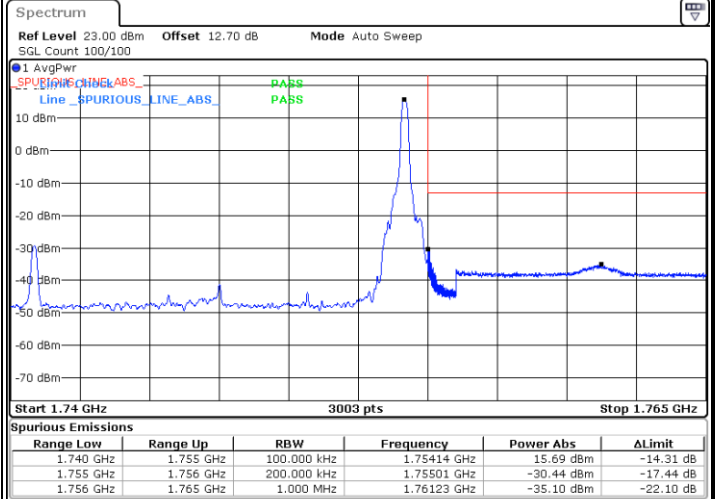

Date: 25.FEB.2021 01:53:13

Lowest Band Edge / Full RB

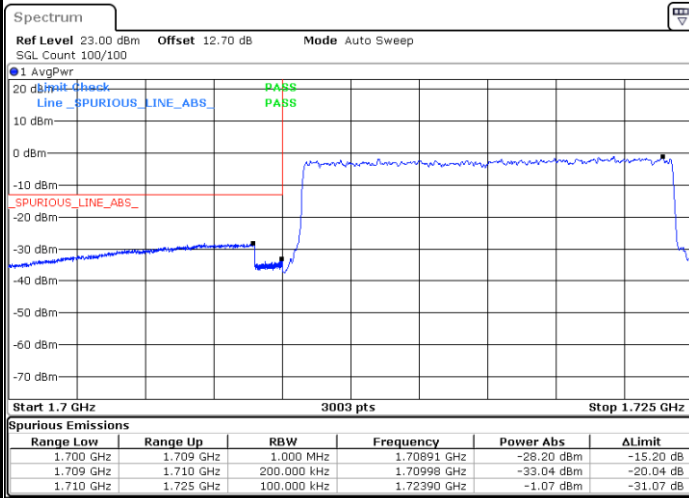

Date: 25.FEB.2021 01:44:05

Highest Band Edge / Full RB



Date: 25.FEB.2021 01:54:11



LTE Band 4 / 15MHz / 64QAM

Lowest Band Edge / 1 RB

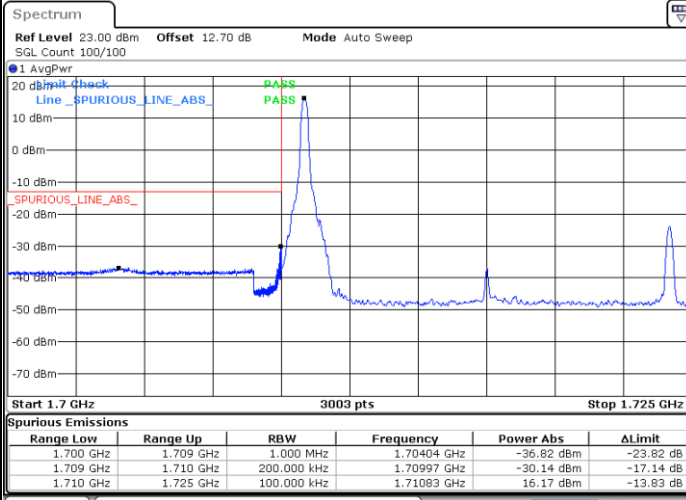

Date: 25.FEB.2021 01:56:13

Highest Band Edge / 1 RB

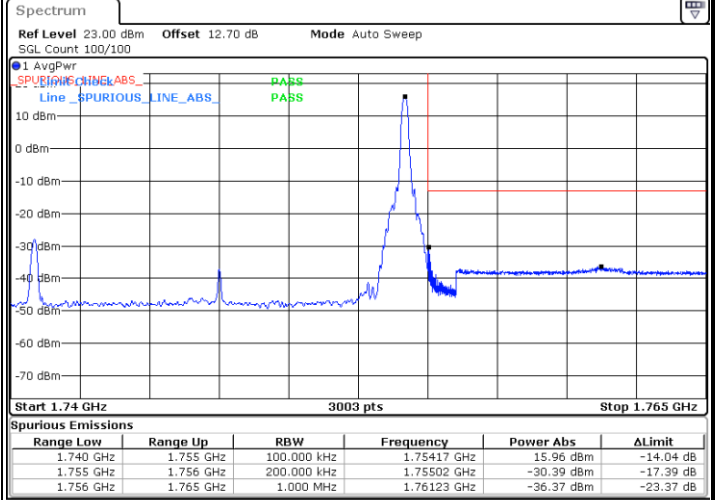

Date: 25.FEB.2021 02:01:57

Lowest Band Edge / Full RB

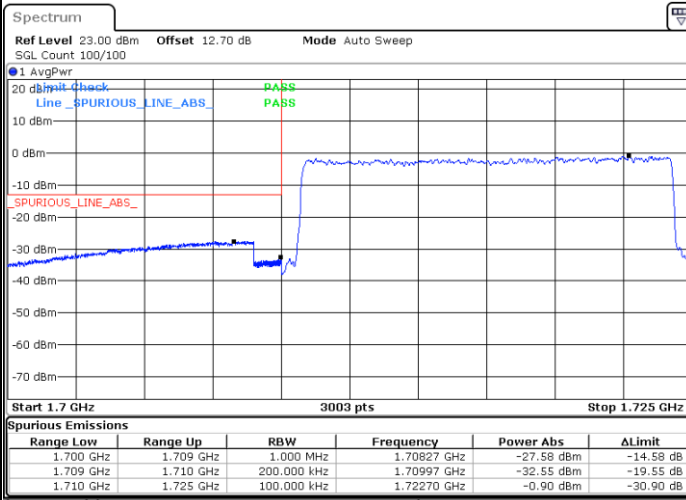

Date: 25.FEB.2021 01:56:42

Highest Band Edge / Full RB

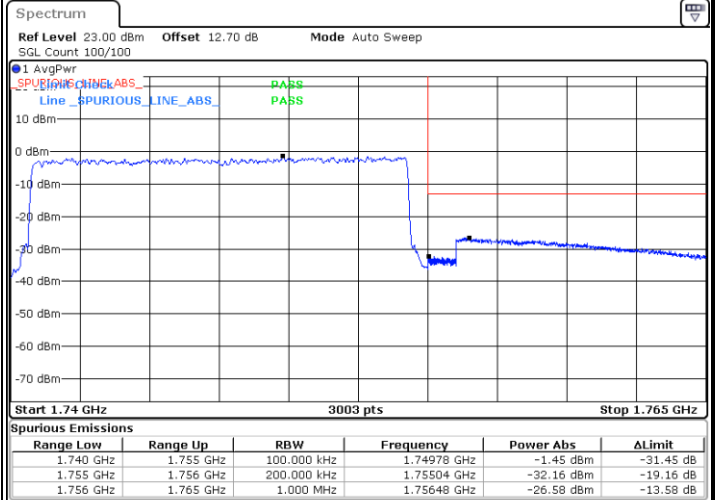

Date: 25.FEB.2021 02:02:26