



FCC RADIO TEST REPORT

FCC ID : PY7-26726G
Equipment : GSM/WCDMA/LTE/5G Phone with BT, DTS/UNII a/b/g/n/ac/ax, GPS, WPC and NFC
Brand Name : Sony
Applicant : Sony Corporation
1-7-1 Konan Minato-ku Tokyo, 108-0075 Japan
Manufacturer : Sony Corporation
1-7-1 Konan Minato-ku Tokyo, 108-0075 Japan
Standard : FCC Part 15 Subpart C §15.209

The product was received on Feb. 19, 2021 and testing was started from Mar. 02, 2021 and completed on Mar. 31, 2021. We, Sporton International Inc. EMC & Wireless Communications Laboratory, would like to declare that the tested sample has been evaluated in accordance with the test procedures and has been in compliance with the applicable technical standards.

The test results in this report apply exclusively to the tested model / sample. Without written approval of Sporton International Inc. EMC & Wireless Communications Laboratory, the test report shall not be reproduced except in full.

Approved by: Louis Wu

Sporton International Inc. EMC & Wireless Communications Laboratory
No.52, Huaya 1st Rd., Guishan Dist., Taoyuan City 333, Taiwan (R.O.C.)



Table of Contents

History of this test report.....	3
Summary of Test Result.....	4
1. General Description	5
1.1 Product Feature of Equipment Under Test	5
1.2 Modification of EUT	5
1.3 Testing Location	6
1.4 Applicable Standards.....	6
2. Test Configuration of Equipment Under Test.....	7
2.1 Descriptions of Test Mode	7
2.2 Connection Diagram of Test System	7
2.3 Support Unit used in test configuration and system	7
2.4 EUT Operation Test Setup	7
3. Test Results	8
3.1 20dB and 99% OBW Spectrum Bandwidth Measurement.....	8
3.2 Radiated Emissions Measurement	9
3.3 Antenna Requirements.....	12
4. List of Measuring Equipment	13
5. Uncertainty of Evaluation	14
Appendix A. Test Results of Conducted Test Items	
A1. Test Result	
Appendix B. Test Results of Radiated Test Items	
B1. Test Result of Field Strength of Fundamental Emissions	
B2. Results of Radiated Emissions (9 kHz~30MHz)	
B3. Results of Radiated Emissions (30MHz~1GHz)	



Summary of Test Result

Report Clause	Ref Std. Clause	Test Items	Result (PASS/FAIL)	Remark
-	15.207	AC Power Line Conducted Emissions	Not Required	-
3.1	15.215(c)	20dB Spectrum Bandwidth	Reporting only	-
	2.1049	99% OBW Spectrum Bandwidth	Reporting only	-
3.2	15.209	Field Strength of Fundamental Emissions	Pass	Max level -14.47 dB μ V/m at 0.150 MHz
		Radiated Spurious Emissions	Pass	Under limit 12.87 dB at 954.410MHz
3.3	15.203	Antenna Requirements	Pass	-

Note: Not required means after assessing, test items are not necessary to carry out.

Declaration of Conformity:

The test results with all measurement uncertainty excluded are presented in accordance with the regulation limits or requirements declared by manufacturers.

Comments and Explanations:

The declared of product specification for EUT presented in the report are provided by the manufacturer, and the manufacturer takes all the responsibilities for the accuracy of product specification.

Reviewed by: Wii Chang

Report Producer: Dara Chiu



1. General Description

1.1 Product Feature of Equipment Under Test

GSM/WCDMA/LTE, Bluetooth, DTS/UNII a/b/g/n/ac/ax, NFC, FM Receiver, WPC/WPT, and GNSS

Standards-related Product Specification	
Antenna Type	Loop Antenna

Remark: The above EUT's information was declared by manufacturer. Please refer to Comments and Explanations in report summary.

EUT Information List			
HW Version	SW Version	S/N	Performed Test Item
A	0.406	QV7200EK6F	RF conducted measurement Radiated Spurious Emission

Accessory List	
AC Adapter	Model Name : XQZ-UC1
	S/N : 0020W51300039 (for Radiated Spurious Emission) 0020W51300024 (for Conducted Emission)
Earphone	Model Name : STH40D
	S/N : N/A
USB Cable	Model Name : XQZ-UB1
	S/N : N/A
Wireless Charger	Model Name.: F7U050
	S/N : 26S10EHC828473

Note:

- Above EUT list used are electrically identical per declared by manufacturer.
- Above the accessories list are used to exercise the EUT during test, and the serial number of each type of accessories is listed in each section of this report. .
- For other wireless features of this EUT, test report will be issued separately.

1.2 Modification of EUT

No modifications are made to the EUT during all test items.



1.3 Testing Location

Test Site	Sporton International Inc. EMC & Wireless Communications Laboratory
Test Site Location	No.52, Huaya 1st Rd., Guishan Dist., Taoyuan City 333, Taiwan (R.O.C.) TEL: +886-3-327-3456 FAX: +886-3-328-4978
Test Site No.	Sporton Site No. TH03-HY
Test Engineer	Oscar Chi
Temperature	22 ~ 24°C
Relative Humidity	53 ~ 55%

Note: The test site complies with ANSI C63.4 2014 requirement.

Test Site	Sporton International Inc. Wensan Laboratory
Test Site Location	No.58, Aly. 75, Ln. 564, Wenhua 3rd, Rd., Guishan Dist., Taoyuan City 333010, Taiwan (R.O.C.) TEL: +886-3-327-0868 FAX: +886-3-327-0855
Test Site No.	Sporton Site No. 03CH11-HY (TAF Code: 3786)
Test Engineer	Troye Hsieh
Temperature	19.2 ~ 20.4°C
Relative Humidity	53.2 ~ 68.7%
Remark	The Radiated Spurious Emission test item subcontracted to Sporton International Inc. Wensan Laboratory

Note: The test site complies with ANSI C63.4 2014 requirement.

FCC designation No.: TW1190

1.4 Applicable Standards

According to the specifications of the manufacturer, the EUT must comply with the requirements of the following standards:

- ♦ FCC Part 15 Subpart C §15.209
- ♦ FCC KDB 414788 D01 Radiated Test Site v01r01
- ♦ ANSI C63.10-2013

Remark: The TAF code is not including all the FCC KDB listed without accreditation.

2. Test Configuration of Equipment Under Test

2.1 Descriptions of Test Mode

Investigation has been done on all the possible configurations.

The following table is a list of the test modes shown in this test report.

Test Items	
20dB Spectrum Bandwidth	Field Strength of Fundamental Emissions
Radiated Spurious Emissions 9kHz~30MHz	Radiated Spurious Emissions 30MHz~1GHz

Pre-scanned tests, X, Y, Z in three orthogonal panels to determine the final configuration (X Plane as worst plane) from all possible combinations.

2.2 Connection Diagram of Test System

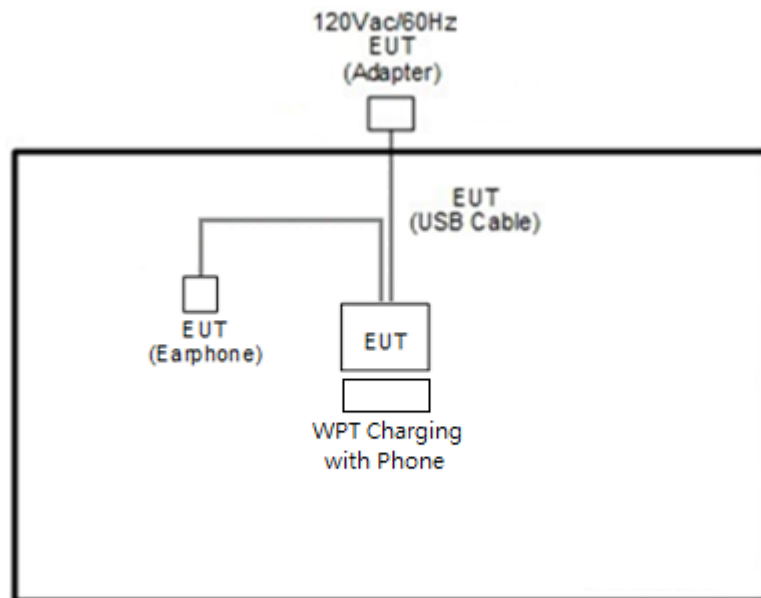

2.3 Support Unit used in test configuration and system

Item	Equipment	Brand Name	Model Name	FCC ID	Data Cable	Power Cord
1.	Phone	Sony	N/A	PY7-26726G	N/A	N/A

2.4 EUT Operation Test Setup

The Wireless Charging with Phone via wireless power transfer function.

3. Test Results

3.1 20dB and 99% OBW Spectrum Bandwidth Measurement

3.1.1 Limit

Reporting only

3.1.2 Measuring Instruments

See list of measuring instruments of this test report.

3.1.3 Test Procedures

1. The spectrum analyzer connected via a receive antenna placed near the EUT in peak Max hold mode.
2. The resolution bandwidth of 1 kHz and the video bandwidth of 3 kHz were used.
3. Measured the spectrum width with power higher than 20dB below carrier.
4. Measured the 99% OBW.

3.1.4 Test Setup

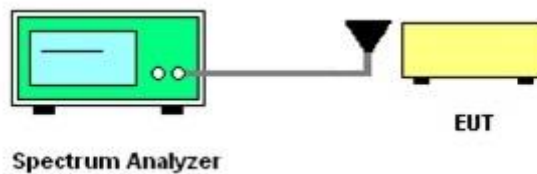

3.1.5 Test Result of Conducted Test Items

Please refer to Appendix A.



3.2 Radiated Emissions Measurement

3.2.1 Limit

The field strength of any emissions which appear band shall not exceed the general radiated emissions limits.

Frequencies (MHz)	Field Strength ($\mu\text{V/m}$)	Measurement Distance (meters)
0.009~0.490	2400/F(kHz)	300
0.490~1.705	24000/F(kHz)	30
1.705~30.0	30	30
30~88	100	3
88~216	150	3
216~960	200	3
Above 960	500	3

3.2.2 Measuring Instruments

See list of measuring instruments of this test report.

3.2.3 Measuring Instrument Setting

The following table is the setting of receiver:

Receiver Parameter	Setting
Attenuation	Auto
Frequency Range: 9kHz~150kHz	RBW 200Hz for QP
Frequency Range: 150kHz~30MHz	RBW 9kHz for QP
Frequency Range: 30MHz~1000MHz	RBW 120kHz for Peak

Note: The emission limits shown in the above table are based on measurements employing a CISPR quasi-peak detector except for the frequency bands 9-90 kHz and 110-490 kHz. Radiated emission limits in these two bands are based on measurements employing an average detector.



3.2.4 Test Procedures

1. Configure the EUT according to ANSI C63.10. The EUT was placed on the top of the turntable 0.8 meter above ground. The phase center of the receiving antenna mounted on the top of a height-variable antenna tower was placed 3 meters far away from the turntable.
2. Power on the EUT and all the supporting units. The turntable was rotated by 360 degrees to determine the position of the highest radiation.
3. The height of the broadband receiving antenna was varied between one meter and four meters above ground to find the maximum emissions field strength of both horizontal and vertical polarization.
4. For each suspected emissions, the antenna tower was scan (from 1 M to 4 M) and then the turntable was rotated (from 0 degree to 360 degrees) to find the maximum reading.
5. Set the test-receiver system to Peak or CISPR quasi-peak Detect Function with specified bandwidth under Maximum Hold Mode.
6. When the radiated emissions limits are expressed in terms of the average value of the emissions, and pulsed operation is employed, the measurement field strength shall be determined by averaging over one complete pulse train, including blanking intervals, as long as the pulse train does not exceed 0.1 seconds. As an alternative (provided the transmitter operates for longer than 0.1 seconds) or in cases where the pulse train exceeds 0.1 seconds, the measured field strength shall be determined from the average absolute voltage during a 0.1 second interval during which the field strength is at its maximum value.
7. In case the emission is lower than 30MHz, loop antenna has to be used for measurement and the recorded data should be QP measured by receiver.

3.2.5 Test Setup

For radiated emissions below 30MHz

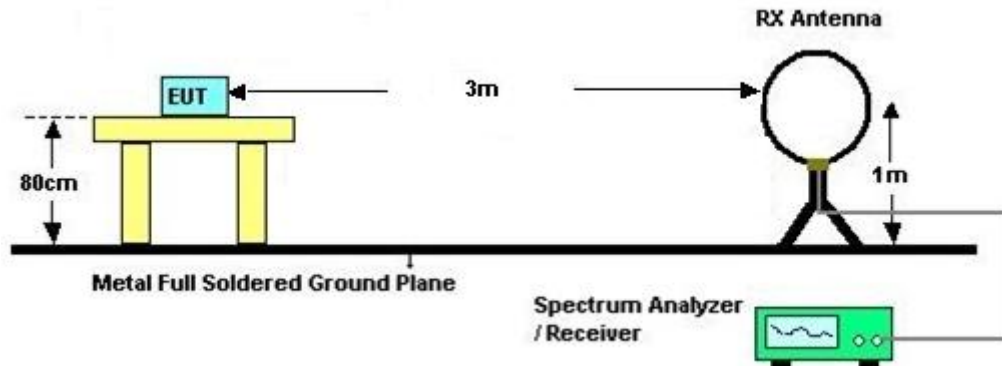

For radiated emissions above 30MHz

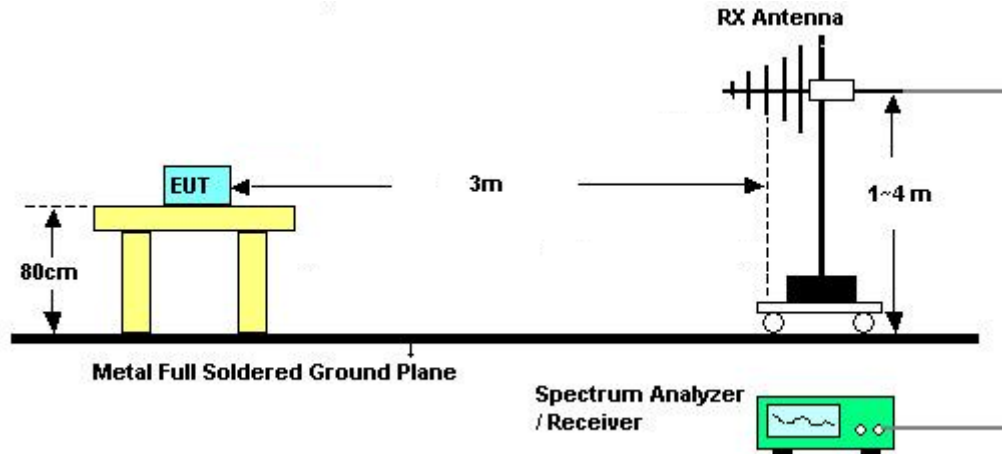

3.2.6 Test Result of Radiated Emissions Measurement

Please refer to Appendix B.

Remark:

1. There is a comparison data of both open-field test site and alternative test site - semi-Anechoic chamber according to 414788 D01 Radiated Test Site v01r01, and the result came out very similar.
2. According to C63.10 radiated Test, the EUT pre-scanned horizontal, vertical, and ground-parallel three polarization's, the worst case is horizontal & vertical polarization, test data of two mode was reported.



3.3 Antenna Requirements

3.3.1 Standard Applicable

Except for special regulations, the Low-power Radio-frequency Devices must not be equipped with any jacket for installing an antenna with extension cable. An intentional radiator shall be designed to ensure that no antenna other than that furnished by the responsible party shall be used with the device. The use of a permanently attached antenna or of an antenna that uses a unique coupling to the intentional radiator shall be considered sufficient to comply with the provisions of this Section. The manufacturer may design the unit so that the user can replace a broken antenna, but the use of a standard antenna jack or electrical connector is prohibited.

The use of a permanently attached antenna or of an antenna that uses a unique coupling to the intentional radiator shall be considered sufficient to comply with the rule.

3.3.2 Antenna Anti-Replacement Construction

An embedded-in antenna design is used.



4. List of Measuring Equipment

Instrument	Brand Name	Model No.	Serial No.	Characteristics	Calibration Date	Test Date	Due Date	Remark
Hygrometer	Testo	608-H1	34913904	N/A	Jul. 27, 2020	Mar. 02, 2021	Jul. 26, 2021	Conducted (TH03-HY)
Spectrum Analyzer	Rohde & Schwarz	FSP30	101329	9kHz~30GHz	Sep. 03, 2020	Mar. 02, 2021	Sep. 02, 2021	Conducted (TH03-HY)
Bilog Antenna	TESEQ	CBL 6111D & N-6-06	35414 & AT-N0602	30MHz~1GHz	Oct. 11, 2020	Mar. 31, 2021	Oct. 10, 2021	Radiation (03CH11-HY)
Loop Antenna	Rohde & Schwarz	HFH2-Z2	100488	9 kHz~30 MHz	Jul. 14, 2020	Mar. 31, 2021	Jul. 13, 2021	Radiation (03CH11-HY)
Amplifier	SONOMA	310N	187312	9kHz~1GHz	Dec. 02, 2020	Mar. 31, 2021	Dec. 01, 2021	Radiation (03CH11-HY)
Spectrum Analyzer	Keysight	N9010A	MY54200486	10Hz~44GHz	Oct. 23, 2020	Mar. 31, 2021	Oct. 22, 2021	Radiation (03CH11-HY)
Software	Audix	E3 6.2009-8-24	RK-001053	N/A	N/A	Mar. 31, 2021	N/A	Radiation (03CH11-HY)
Controller	EMEC	EM 1000	N/A	Control Turn table & Ant Mast	N/A	Mar. 31, 2021	N/A	Radiation (03CH11-HY)
Antenna Mast	EMEC	AM-BS-4500-B	N/A	1~4m	N/A	Mar. 31, 2021	N/A	Radiation (03CH11-HY)
Turn Table	EMEC	TT 2000	N/A	0~360 Degree	N/A	Mar. 31, 2021	N/A	Radiation (03CH11-HY)
Filter	Wainwright	WHK20/1000C 7/40SS	SN2	20M High Pass	Sep. 14, 2020	Mar. 31, 2021	Sep. 13, 2021	Radiation (03CH11-HY)
RF Cable	HUBER + SUHNER	SUCOFLEX 104	MY9837/4PE	9kHz-30MHz	Mar. 11, 2021	Mar. 31, 2021	Mar. 10, 2022	Radiation (03CH11-HY)
RF Cable	HUBER + SUHNER	SUCOFLEX 104	MY9837/4PE	30M-18G	Mar. 11, 2021	Mar. 31, 2021	Mar. 10, 2022	Radiation (03CH11-HY)
RF Cable	HUBER + SUHNER	SUCOFLEX 102	MY2859/2	30MHz-40GHz	Mar. 11, 2021	Mar. 31, 2021	Mar. 10, 2022	Radiation (03CH11-HY)
Hygrometer	TECPEL	DTN-303B	TP200880	QA-3-031	Oct. 22, 2020	Mar. 31, 2021	Oct. 21, 2021	Radiation (03CH11-HY)
Hygrometer	TECPEL	DTN-303B	TP140325	N/A	Nov. 18, 2020	Mar. 31, 2021	Nov. 17, 2021	Radiation (03CH11-HY)



5. Uncertainty of Evaluation

Uncertainty of Conducted Emission Measurement (150 kHz ~ 30 MHz)

Measuring Uncertainty for a Level of Confidence of 95% ($U = 2Uc(y)$)	2.3
---	-----

Uncertainty of Radiated Emission Measurement (9 kHz ~ 30 MHz)

Measuring Uncertainty for a Level of Confidence of 95% ($U = 2Uc(y)$)	3.4
---	-----

Uncertainty of Radiated Emission Measurement (30 MHz ~ 1000 MHz)

Measuring Uncertainty for a Level of Confidence of 95% ($U = 2Uc(y)$)	4.4
---	-----



Appendix A. Test Results of Conducted Test Items

A1. Test Result

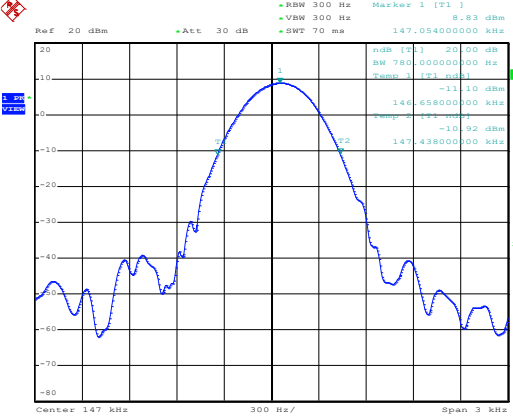
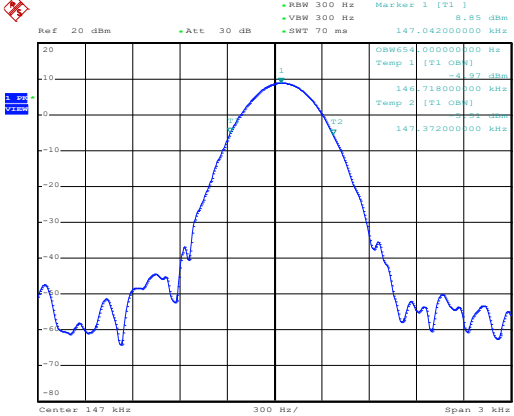
Test mode	WPT Tx						
 <p>Date: 2.MAR.2021 11:20:16</p>		 <p>Date: 2.MAR.2021 11:19:50</p>		20dB Bandwidth (kHz)	0.780	99% Occupied BW(kHz)	0.654

Remark: Because the measured signal is CW adjusting the RBW per C63.10 would not be practical since measured bandwidth will always follow the RBW and the result will be approximately twice the RBW.



Appendix B. Test Results of Radiated Test Items

B1. Test Result of Field Strength of Fundamental Emissions

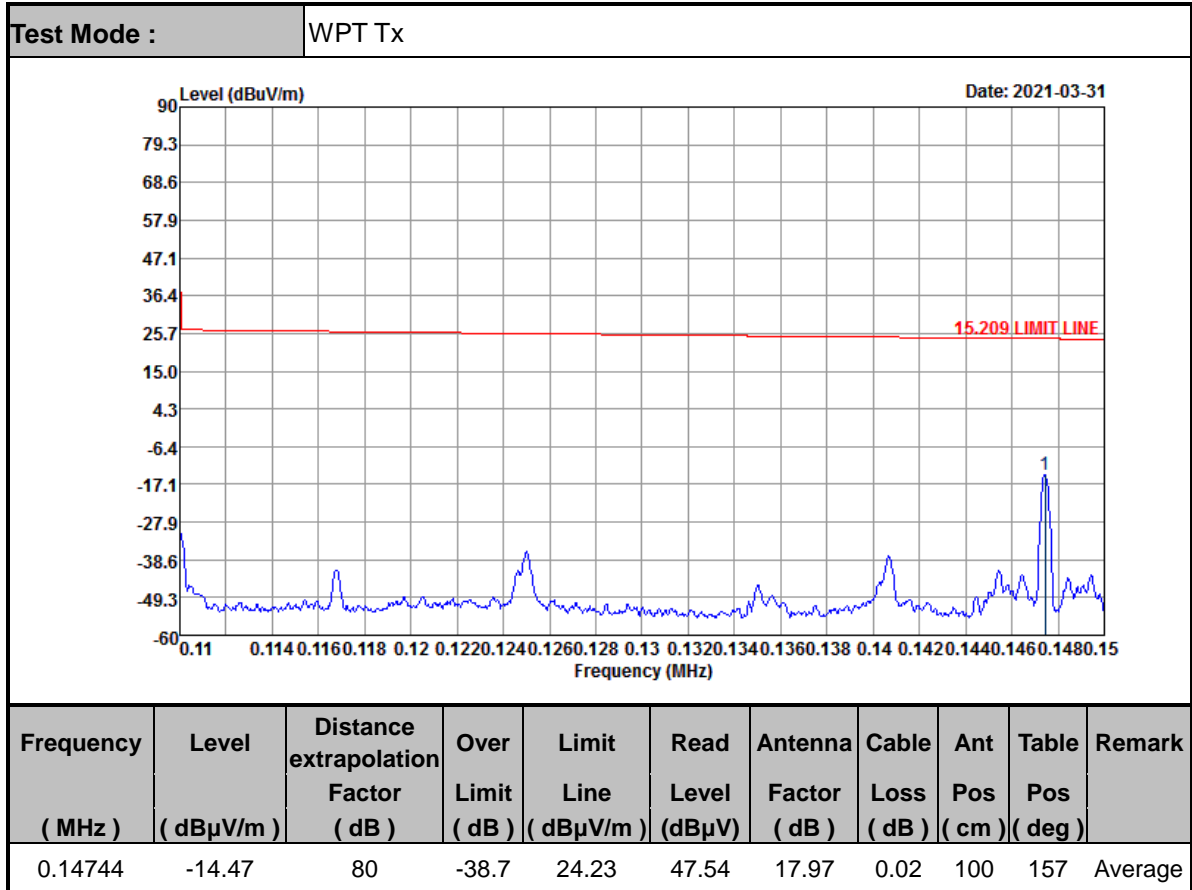

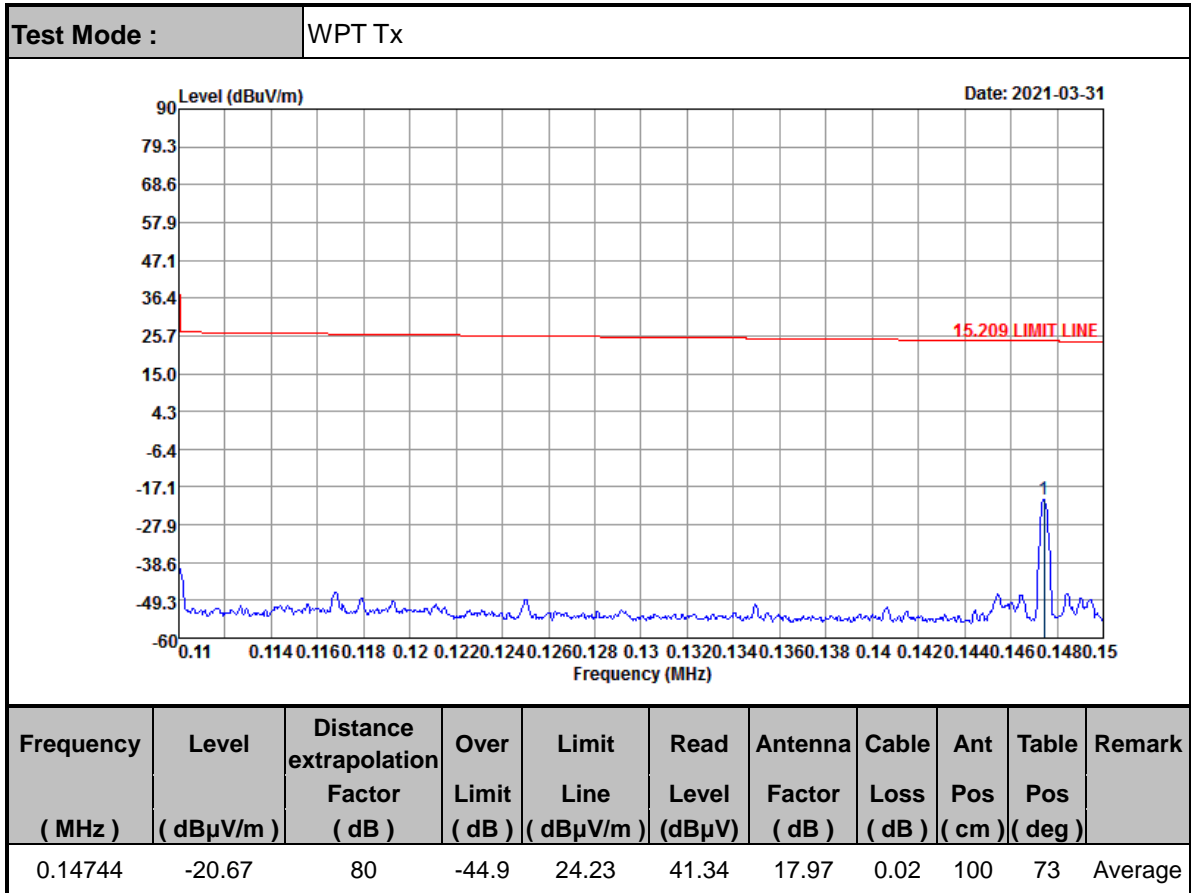



B2. Results of Radiated Spurious Emissions (9 kHz~30MHz)

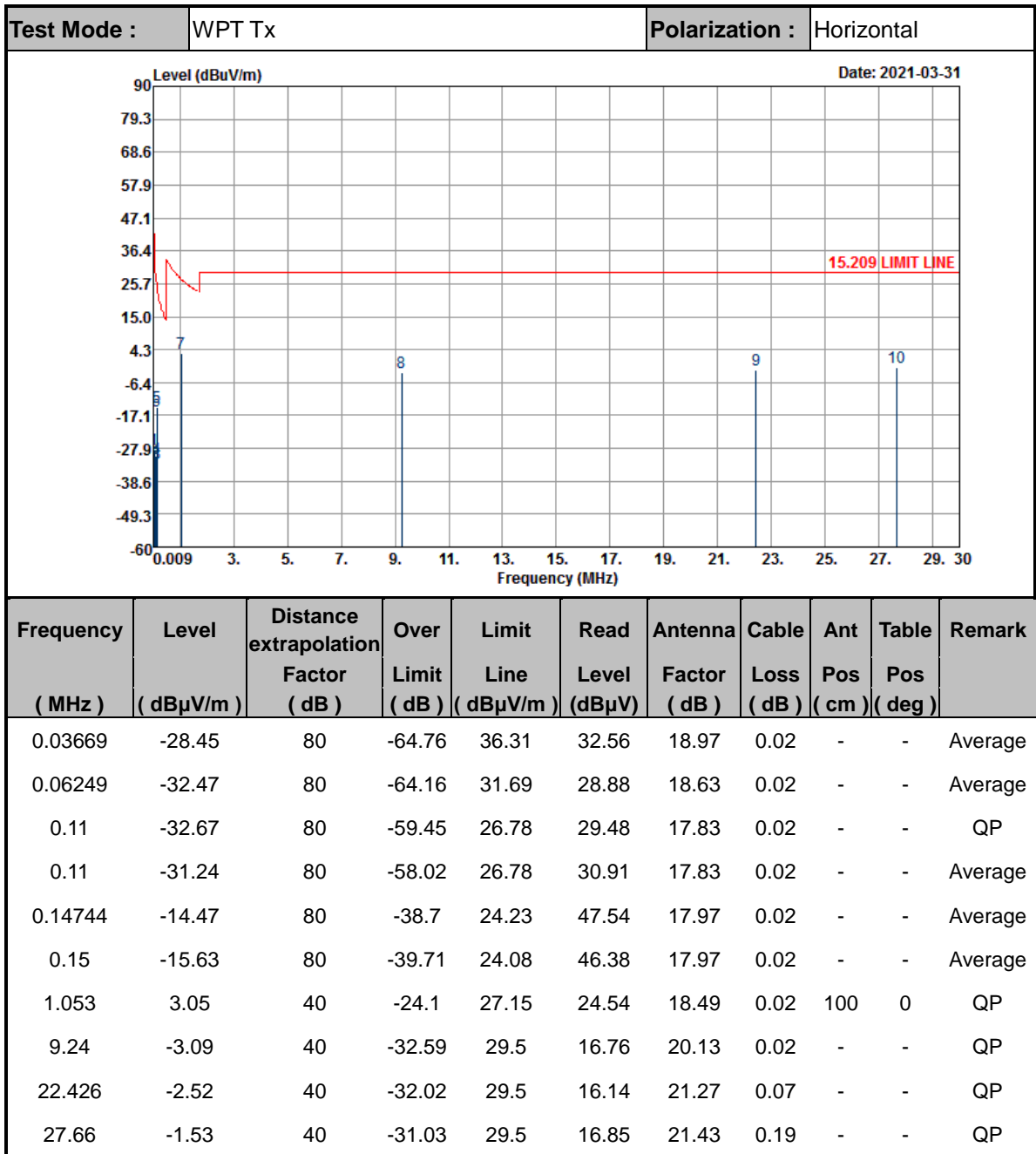

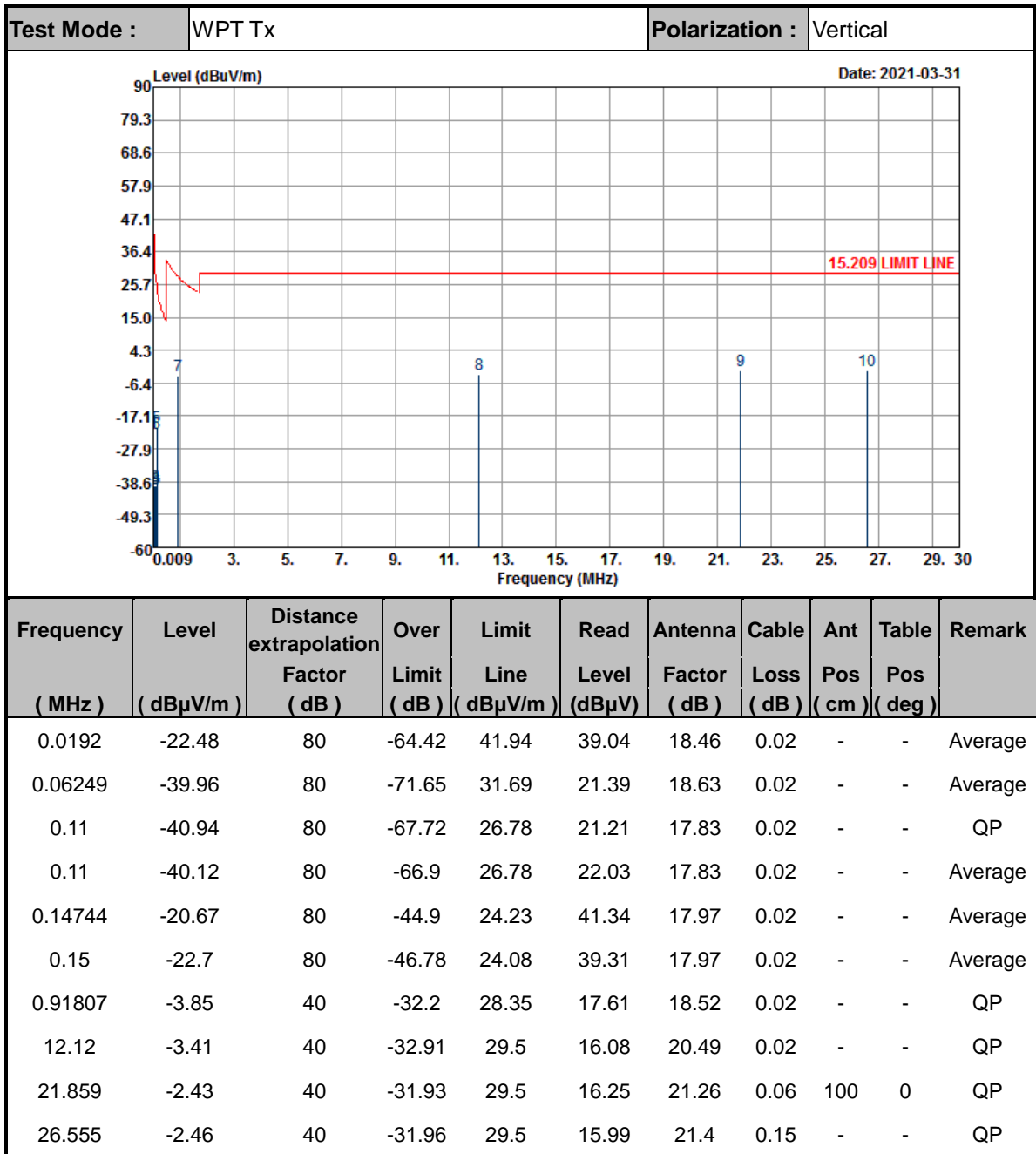

Note:

1. The amplitude of spurious emissions which are attenuated by more than 20dB below the permissible value has no need to be reported.
2. Distance extrapolation factor = 40 log (specific distance / test distance) (dB);
3. Limit line = specific limits (dBμV) + distance extrapolation factor.



B3. Results of Radiated Spurious Emissions (30MHz~1GHz)

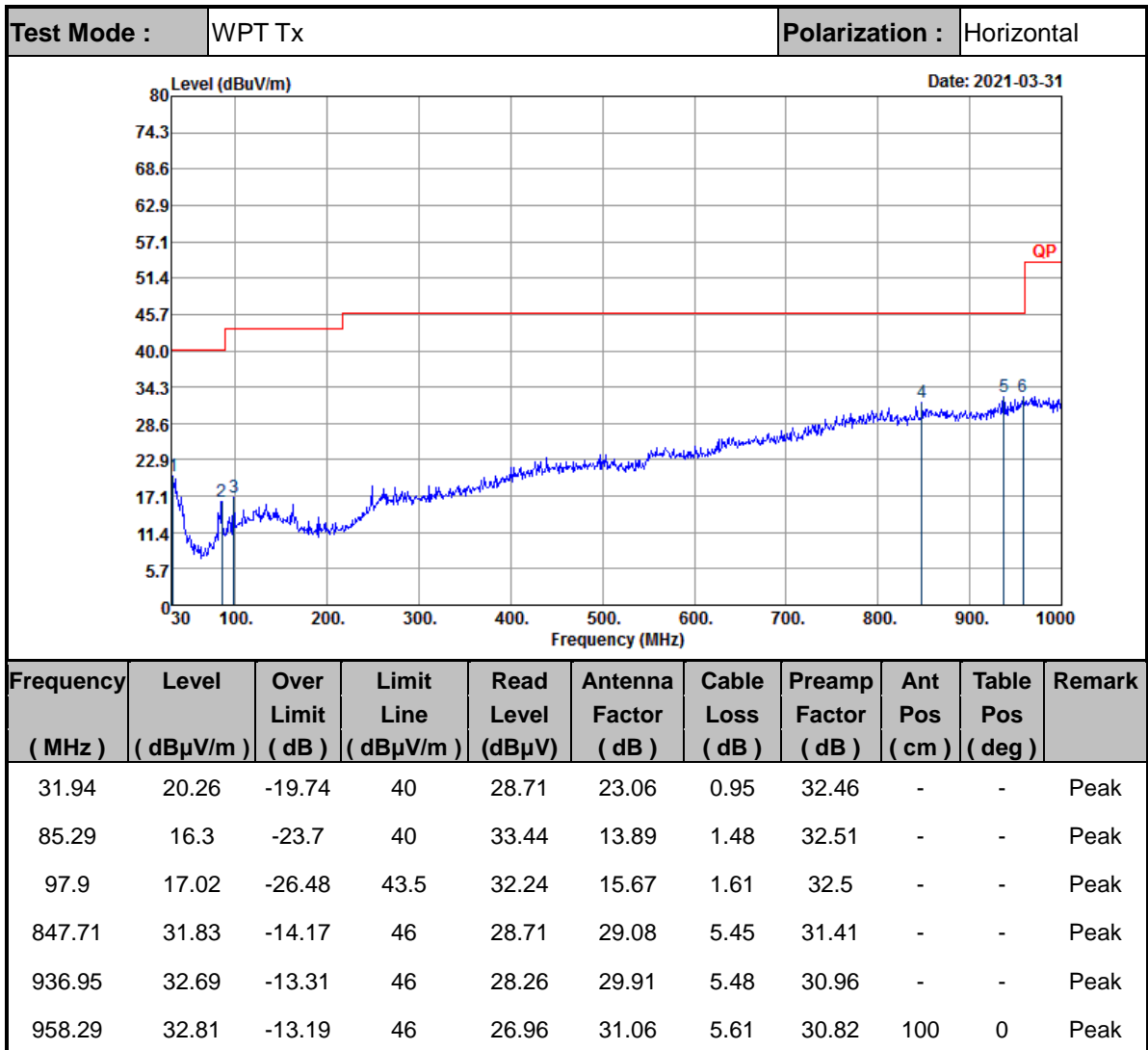

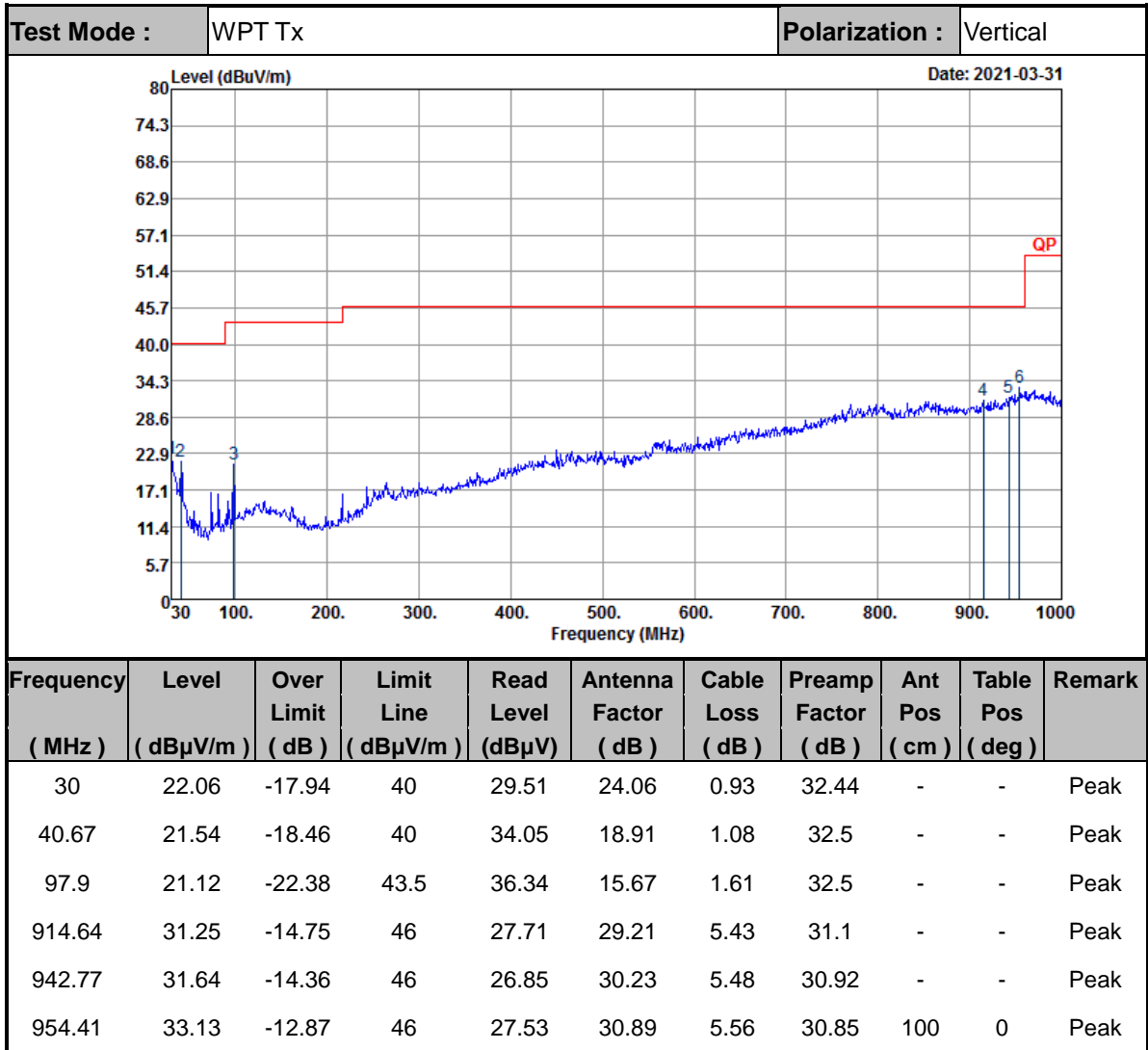

Note:

1. The amplitude of spurious emissions which are attenuated by more than 20dB below the permissible value has no need to be reported.
2. Emission level (dBμV/m) = 20 log Emission level (μV/m).
3. Corrected Reading: Antenna Factor + Cable Loss + Read Level - Preamp Factor= Level.

—————THE END—————