

FCC Test Report

Report No.: RF160621C21-10

FCC ID: PY7-14784Z

Received Date: Jun. 21, 2016

Test Date: Jul. 08, 2016 ~ Aug. 03, 2016

Issued Date: Aug. 3, 2016

Applicant: Sony Mobile Communications Inc.

Address: 4-12-3 Higashi-Shinagawa, Shinagawa-ku, Tokyo, 140-0002, Japan

Issued By: Bureau Veritas Consumer Products Services (H.K.) Ltd., Taoyuan Branch

Lab Address: No. 47-2, 14th Ling, Chia Pau Vil., Lin Kou Dist., New Taipei City, Taiwan (R.O.C)

Test Location (1): No. 19, Hwa Ya 2nd Rd, Wen Hwa Tsuen, Kwei Shan Hsiang, Taoyuan Hsien 333, Taiwan, R.O.C.

Test Location (2): No.215, Sec. 3, Beixin Rd., Xindian Dist., New Taipei City 231, Taiwan, R.O.C



This report is for your exclusive use. Any copying or replication of this report to or for any other person or entity, or use of our name or trademark, is permitted only with our prior written permission. This report sets forth our findings solely with respect to the test samples identified herein. The results set forth in this report are not indicative or representative of the quality or characteristics of the lot from which a test sample was taken or any similar or identical product unless specifically and expressly noted. Our report includes all of the tests requested by you and the results thereof based upon the information that you provided to us. You have 60 days from date of issuance of this report to notify us of any material error or omission caused by our negligence, provided, however, that such notice shall be in writing and shall specifically address the issue you wish to raise. A failure to raise such issue within the prescribed time shall constitute your unqualified acceptance of the completeness of this report, the tests conducted and the correctness of the report contents. Unless specific mention, the uncertainty of measurement has been explicitly taken into account to declare the compliance or non-compliance to the specification. The report must not be used by the client to claim product certification, approval, or endorsement by TAF or any government agencies.

Table of Contents

Release Control Record	3
1 Certificate of Conformity	4
2 Summary of Test Results.....	5
2.1 Measurement Uncertainty.....	5
2.2 Modification Record	5
3 General Information	6
3.1 General Description of EUT	6
3.2 Description of Test Modes.....	7
3.2.1 Test Mode Applicability and Tested Channel Detail.....	7
3.3 Description of Support Units	8
3.3.1 Configuration of System under Test	8
3.4 General Description of Applied Standards.....	8
4 Test Types and Results	9
4.1 Radiated Emission Measurement.....	9
4.1.1 Limits of Radiated Emission Measurement	9
4.1.2 Test Instruments	10
4.1.3 Limit	11
4.1.4 Test Procedures.....	11
4.1.5 Deviation from Test Standard	12
4.1.6 Test Set Up	12
4.1.7 EUT Operating Conditions.....	12
4.1.8 Test Results	13
4.2 Conducted Emission Measurement.....	24
4.2.1 Limits of Conducted Emission Measurement	24
4.2.2 Test Instruments	24
4.2.3 Test Procedures.....	25
4.2.4 Deviation from Test Standard	25
4.2.5 Test Setup.....	25
4.2.6 EUT Operating Conditions.....	25
4.2.7 Test Results	26
4.3 Frequency Stability	28
4.3.1 Limits of Frequency Stability Measurement	28
4.3.2 Test Setup.....	28
4.3.3 Test Instruments	28
4.3.4 Test Procedure	28
4.3.5 Deviation from Test Standard	28
4.3.6 EUT Operating Conditions.....	28
4.3.7 Test Result	29
4.4 20 dB Bandwidth.....	30
4.4.1 Limits of 20 dB Bandwidth Measurement.....	30
4.4.2 Test Setup.....	30
4.4.3 Test Instruments	30
4.4.4 Test Procedures.....	30
4.4.5 Deviation from Test Standard	30
4.4.6 EUT Operating Conditions.....	30
4.4.7 Test Results	31
5 Pictures of Test Arrangements.....	32
Appendix – Information on the Testing Laboratories	33

Release Control Record

Issue No.	Description	Date Issued
RF160621C21-10	Original Release	Aug. 3, 2016

1 Certificate of Conformity

Product: Mobile Phone

Brand: Sony

Sample Status: Identical Prototype

Applicant: Sony Mobile Communications Inc.

Test Date: Jul. 08, 2016 ~ Aug. 03, 2016

Standards: 47 CFR FCC Part 15, Subpart C (Section 15.225)
47 CFR FCC Part 15, Subpart C (Section 15.215)
ANSI C63.10:2013

The above equipment has been tested by **Bureau Veritas Consumer Products Services (H.K.) Ltd., Taoyuan Branch**, and found compliance with the requirement of the above standards. The test record, data evaluation & Equipment Under Test (EUT) configurations represented herein are true and accurate accounts of the measurements of the sample's EMC characteristics under the conditions specified in this report.

Prepared by : Evonne Liu, **Date:** Aug. 3, 2016
Evonne Liu / Specialist

Approved by : Stanley Wu, **Date:** Aug. 3, 2016
Stanley Wu / Assistant Manager

2 Summary of Test Results

47 CFR FCC Part 15, Subpart C (Section 15.225, 15.215)			
FCC Clause	Test Item	Result	Remarks
15.207	Conducted emission test	Pass	Meet the requirement of limit. Minimum passing margin is -9.61 dB at 13.55739 MHz.
15.225 (a)	The field strength of any emissions within the band 13.553-13.567 MHz	Pass	Meet the requirement of limit. Minimum passing margin is -69.66 dB at 13.559 MHz.
15.225 (b)	The field strength of any emissions within the bands 13.410-13.553 MHz and 13.567-13.710 MHz	Pass	Meet the requirement of limit.
15.225 (c)	The field strength of any emissions within the bands 13.110-13.410 MHz and 13.710-14.010 MHz	Pass	Meet the requirement of limit.
15.225 (d)	The field strength of any emissions appearing outside of the 13.110-14.010 MHz band	Pass	Meet the requirement of limit. Minimum passing margin is -14.14 dB at 43.58 MHz.
15.225 (e)	The frequency tolerance	Pass	Meet the requirement of limit.
15.215 (c)	20dB Bandwidth	Pass	Meet the requirement of limit.
15.203	Antenna Requirement	Pass	No antenna connector is used.

2.1 Measurement Uncertainty

Where relevant, the following measurement uncertainty levels have been estimated for tests performed on the EUT as specified in CISPR 16-4-2:

Measurement	Frequency	Expanded Uncertainty (k=2) (±)
Conducted Emissions at mains ports	150 kHz ~ 30 MHz	2.44 dB
Radiated Emissions up to 1 GHz	30 MHz ~ 200 MHz	2.93 dB
	200 MHz ~ 1000 MHz	2.95 dB
Radiated Emissions above 1 GHz	1 GHz ~ 18 GHz	2.26 dB
	18 GHz ~ 40 GHz	1.94 dB

2.2 Modification Record

There were no modifications required for compliance.

3 General Information

3.1 General Description of EUT

Product	Mobile Phone
Brand	Sony
Status of EUT	Identical Prototype
Power Supply Rating	3.8Vdc (Embedded Battery) 5Vdc or 9Vdc or 12Vdc (Adapter)
Modulation Type	ASK
Operating Frequency	13.56 MHz
Antenna Type	Loop Antenna
Accessory Device	Refer to Note
Data Cable Supplied	Refer to Note

Note:

1. The EUT contains following accessory devices.

Product	Brand	Model	Type	Description
Adapter	Sony	UCH12	AC-0051	I/P: 100- 240Vac, 400mA, 50~60 Hz, O/P: 5.0Vdc, 2700 mA / O/P: 9.0Vdc, 1800 mA / O/P: 12.0Vdc, 1350 mA
Battery	Sony	1303-8269	N/A	3.8Vdc, 2700mAh
Earphone	Sony	MH410c	AG-1100	1.5m non-shielded cable w/o core
USB Cable	Sony	UCB20	AI-0160	0.95m shielded cable w/o core

2. The above EUT information is declared by manufacturer and for more detailed features description, please refer to the manufacturer's specifications or user's manual.

3.2 Description of Test Modes

One channel was provided to this EUT:

Channel	Frequency (MHz)
1	13.56

3.2.1 Test Mode Applicability and Tested Channel Detail

EUT Configure Mode	Applicable To				Description
	RE	PLC	FS	EB	
-	√	√	√	√	-

Where

RE: Radiated Emission
 FS: Frequency Stability

PLC: Power Line Conducted Emission
 EB: 20 dB Bandwidth measurement

Radiated Emission Test:

- Pre-Scan has been conducted to determine the worst-case mode from all possible combinations between available modulations, data rates and antenna ports (if EUT with antenna diversity architecture).
- Following channel(s) was (were) selected for the final test as listed below.

EUT Configure Mode	Available Channel	Tested Channel	Modulation Type of worst	Axis
-	1	1	ASK	Y

Power Line Conducted Emission Test:

- Pre-Scan has been conducted to determine the worst-case mode from all possible combinations between available modulations, data rates and antenna ports (if EUT with antenna diversity architecture).
- Following channel(s) was (were) selected for the final test as listed below.

EUT Configure Mode	Available Channel	Tested Channel	Modulation Type of worst	Axis
-	1	1	ASK	Y

Frequency Stability:

- This item includes all test value of each mode, but only includes spectrum plot of worst value of each mode.
- Pre-Scan has been conducted to determine the worst-case mode from all possible combinations between available modulations, data rates and antenna ports (if EUT with antenna diversity architecture).
- Following channel(s) was (were) selected for the final test as listed below.

EUT Configure Mode	Available Channel	Tested Channel	Modulation Type of worst	Axis
-	1	1	ASK	Y

20 dB Bandwidth:

- This item includes all test value of each mode, but only includes spectrum plot of worst value of each mode.
- Pre-Scan has been conducted to determine the worst-case mode from all possible combinations between available modulations, data rates and antenna ports (if EUT with antenna diversity architecture).
- Following channel(s) was (were) selected for the final test as listed below.

EUT Configure Mode	Available Channel	Tested Channel	Modulation Type of worst	Axis
-	1	1	ASK	Y

Test Condition:

Applicable To	Environmental Conditions	Input Power	Tested By
RE	25 deg. C, 65 % RH	120 Vac, 60 Hz	Getaz Yang
FS	25 deg. C, 65 % RH	120 Vac, 60 Hz	Taylor Liu
PLC	25 deg. C, 65 % RH	120 Vac, 60 Hz	Toby Tian
EB	25 deg. C, 68 % RH	3.8 Vdc	Luke Chen

3.3 Description of Support Units

The EUT has been tested as an independent unit together with other necessary accessories or support units.

3.3.1 Configuration of System under Test

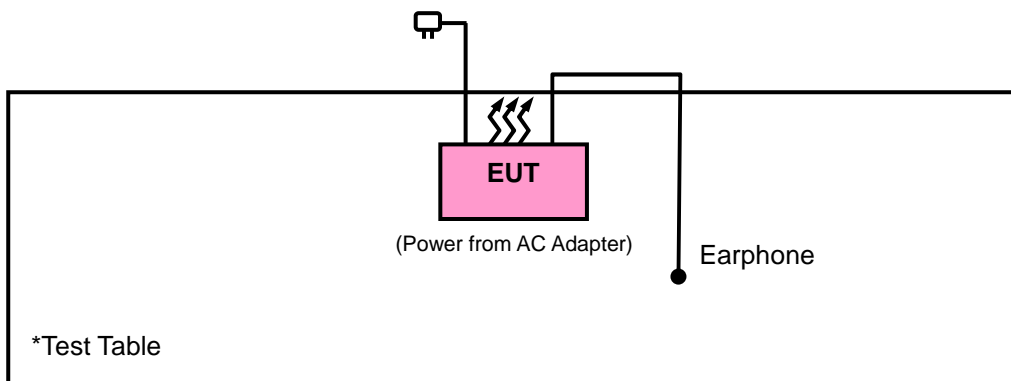

3.4 General Description of Applied Standards

The EUT is a RF Product. According to the specifications of the manufacturer, it must comply with the requirements of the following standards:

FCC Part 15, Subpart C (15.225)

FCC Part 15, Subpart C (15.215)

ANSI C63.10-2013

All test items have been performed and recorded as per the above standards.

NOTE: The EUT has been verified to comply with the requirements of FCC Part 15, Subpart B, Class B (Certification). The test report has been issued separately.

4 Test Types and Results

4.1 Radiated Emission Measurement

4.1.1 Limits of Radiated Emission Measurement

The field strength of any emissions within the band 13.553-13.567 MHz shall not exceed 15,848 microvolts/meter at 30 meters.

The field strength of any emissions appearing outside of the 13.110-14.010 MHz band shall not exceed the general radiated emission limits in § 15.209.

Frequencies (MHz)	Field Strength (microvolts/meter)	Measurement Distance (meters)
0.009 ~ 0.490	2400/F (kHz)	300
0.490 ~ 1.705	24000/F (kHz)	30
1.705 ~ 30.0	30	30
30 ~ 88	100	3
88 ~ 216	150	3
216 ~ 960	200	3
Above 960	500	3

NOTE:

1. The lower limit shall apply at the transition frequencies.
2. Emission level (dBuV/m) = 20 log Emission level (uV/m).
3. For frequencies above 1000 MHz, the field strength limits are based on average detector, however, the peak field strength of any emission shall not exceed the maximum permitted average limits, specified above by more than 20 dB under any condition of modulation.

4.1.2 Test Instruments

Description & Manufacturer	Model No.	Serial No.	Date of Calibration	Due Date of Calibration
Test Receiver Agilent	N9038A	MY51210203	Jan. 21, 2016	Jan. 20, 2017
Spectrum Analyzer Agilent	N9010A	MY52220314	Sep. 03, 2015	Sep. 02, 2016
Spectrum Analyzer ROHDE & SCHWARZ	FSU43	101261	Dec. 17, 2015	Dec. 16, 2016
BILOG Antenna SCHWARZBECK	VULB9168	9168-472	Jan. 07, 2016	Jan. 06, 2017
HORN Antenna SCHWARZBECK	BBHA 9120 D	9120D-969	Jan. 04, 2016	Jan. 03, 2017
HORN Antenna SCHWARZBECK	BBHA 9170	9170-480	Jan. 08, 2016	Jan. 07, 2017
Loop Antenna	EM-6879	269	Jul. 31, 2015	Jul. 30, 2016
Preamplifier EMCI	EMC 012645	980115	Dec. 21, 2015	Dec. 20, 2016
Preamplifier EMCI	EMC 184045	980116	Dec. 21, 2015	Dec. 20, 2016
Preamplifier EMCI	EMC 330H	980112	Dec. 28, 2015	Dec. 27, 2016
Power Meter Anritsu	ML2495A	1232002	Sep. 21, 2015	Sep. 20, 2016
Power Sensor Anritsu	MA2411B	1207325	Sep. 21, 2015	Sep. 20, 2016
RF signal cable HUBER+SUHNNER	SUCOFLEX 104	309219/4 2950114	Oct. 12, 2015	Oct. 11, 2016
RF signal cable HUBER+SUHNNER	SUCOFLEX 104	250130/4	Oct. 12, 2015	Oct. 11, 2016
RF Coaxial Cable Worken	8D-FB	Cable-Ch10-01	Oct. 12, 2015	Oct. 11, 2016
Software BV ADT	E3 6.120103	NA	NA	NA
Antenna Tower MF	MFA-440H	NA	NA	NA
Turn Table MF	MFT-201SS	NA	NA	NA
Antenna Tower & Turn Table Controller MF	MF-7802	NA	NA	NA

- Note: 1. The calibration interval of the above test instruments is 12 months and the calibrations are traceable to NML/ROC and NIST/USA.
2. The test was performed in HwaYa Chamber 10.
3. The horn antenna and preamplifier (model: EMC 184045) are used only for the measurement of emission frequency above 1 GHz if tested.
4. The FCC Site Registration No. is 690701.
5. The IC Site Registration No. is IC7450F-10.

4.1.3 Limit

Rules and specifications	FCC CFR 47 Part 15 section 15.225			
Description	Compliance with the spectrum mask is tested with RBW set to 9kHz.			
Freq. of Emission (MHz)	Field Strength ($\mu\text{V/m}$) at 30m	Field Strength (dB $\mu\text{V/m}$) at 30m	Field Strength (dB $\mu\text{V/m}$) at 10m	Field Strength (dB $\mu\text{V/m}$) at 3m
1.705~13.110	30	29.5	48.58	69.5
13.110~13.410	106	40.5	59.58	80.5
13.410~13.553	334	50.5	69.58	90.5
13.553~13.567	15848	84.0	103.08	124.0
13.567~13.710	334	50.5	69.58	90.5
13.710~14.010	106	40.5	59.58	80.5
14.010~30.000	30	29.5	48.58	69.5

4.1.4 Test Procedures

- The EUT was placed on the top of a rotating table 0.8 meters above the ground at a 3 meters semi-anechoic chamber. The table was rotated 360 degrees to determine the position of the highest radiation.
- The EUT was set 3 meters away from the interference-receiving antenna, which was mounted on the top of a variable-height antenna tower.
- Height of receiving antenna is varied from one meter to four meters above the ground to determine the maximum value of the field strength. Both horizontal and vertical polarizations of the antenna are set to make the measurement.
- For each suspected emission, the EUT was arranged to its worst case and then the antenna was tuned to heights from 1 meter to 4 meters and the rotatable table was turned from 0 degrees to 360 degrees to find the maximum reading.
- The test-receiver system was set to Peak Detect Function and Specified Bandwidth with Maximum Hold Mode.
- If the emission level of the EUT in peak mode was lower than the limit specified, then testing could be stopped and the peak values of the EUT would be reported. Otherwise the emissions would be re-tested one by one using peak, quasi-peak or average method as specified and then reported in a data sheet.

NOTE:

- The resolution bandwidth and video bandwidth of test receiver/spectrum analyzer is 120 kHz for Quasi-peak detection at frequency below 1 GHz.
- The resolution bandwidth of test receiver/spectrum analyzer is 1 MHz and video bandwidth is 3 MHz for Peak detection at frequency above 1 GHz.
- The resolution bandwidth of test receiver/spectrum analyzer is 1 MHz and the video bandwidth is $\geq 1/T$ (Duty cycle < 98 %) or 10 Hz (Duty cycle > 98 %) for Average detection (AV) at frequency above 1 GHz.
- All modes of operation were investigated and the worst-case emissions are reported.

4.1.5 Deviation from Test Standard

No deviation.

4.1.6 Test Set Up

Frequency range 9k~30MHz:

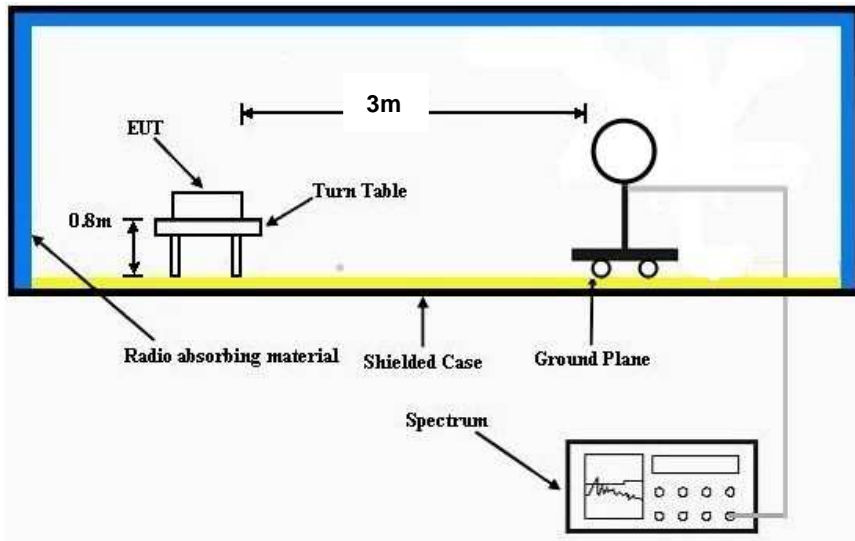

Frequency range 30~1000MHz:

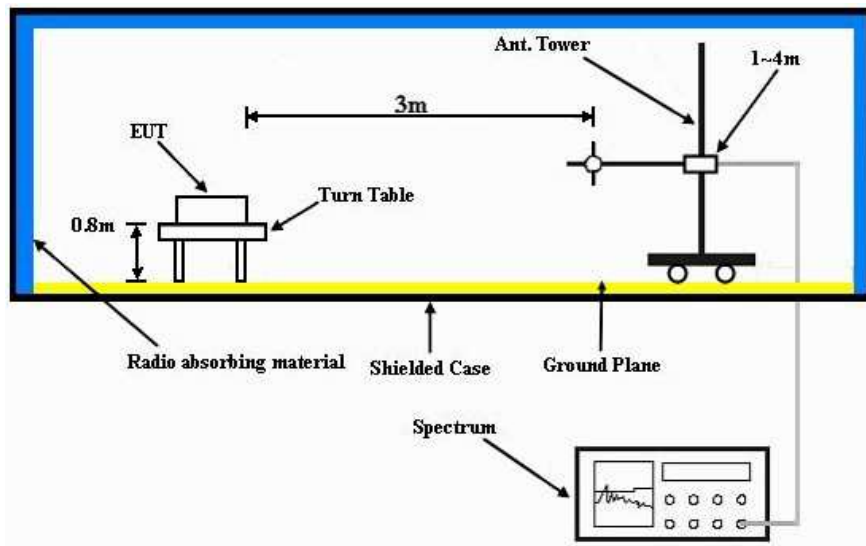

For the actual test configuration, please refer to the attached file (Test Setup Photo).

4.1.7 EUT Operating Conditions

- Placed the EUT on the testing table.
- Set the EUT under transmission condition continuously at specific channel frequency.

4.1.8 Test Results

EUT Test Condition		Measurement Detail	
Channel	Channel 1	Frequency Range	13.553 ~ 13.567 MHz
Input Power	120 Vac, 60 Hz	Detector Function	Quasi-Peak
Environmental Conditions	25 deg. C, 65 % RH	Tested By	Getaz Yang

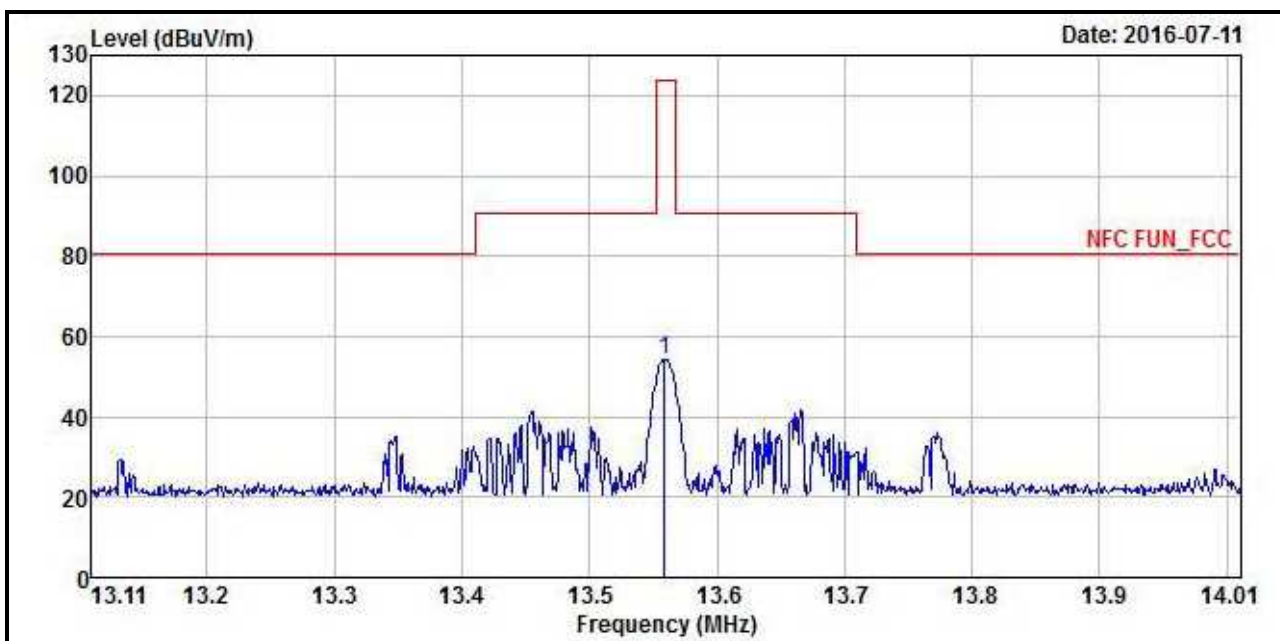

Antenna Polarity & Test Distance: Loop Antenna Open at 3M										
Frequency (MHz)	Emission Level (dBuV/m)	Read Level (dBuV)	Limit (dBuV/m)	Margin (dB)	Antenna Factor (dB/m)	Cable Loss (dB)	Preamp Factor (dB)	Antenna Height (cm)	Table Angle (Degree)	Remark
13.559	54.34	57.72	124	-69.66	37.67	0.31	41.36	100	360	Peak

Transfer the test data from the testing distance at 3M to 30M

Antenna Polarity & Test Distance: Loop Antenna Open at 30M			
Frequency (MHz)	Emission Level (dBuV/m)	Limit (dBuV/m)	Margin (dB)
13.559	14.34	84	-69.66

Note: Emission Level(dBuV/m) at 3M – 40dB = Emission Level(dBuV/m) at 30M

- REMARKS:**
1. Emission level(dBuV/m)=Raw Value(dBuV) + Correction Factor(dB/m)
 2. Correction Factor(dB/m)=Antenna Factor (dB/m)+Cable Factor (dB)–Pre-Amplifier Factor(dB)
 3. The other emission levels were very low against the limit.
 4. Margin value = Emission level – Limit value.
 5. Above limits have been translated by the formula

The measured field strength was extrapolated to distance 30 meters, using the formula that the limit of field strength varies as the inverse distance square. Extrapolation Factor = $20 \log_{10}(30/3)^2 = 40\text{dB}$

Example:

$$\begin{aligned}
 13.56 \text{ MHz} &= 15848 \text{ uV/m} && 30\text{m} \\
 &= 84 \text{ dBuV/m} && 30\text{m} \\
 &= 84+20\log(30/3)^2 && 3\text{m} \\
 &= 124 \text{ dBuV/m}
 \end{aligned}$$

EUT Test Condition		Measurement Detail	
Channel	Channel 1	Frequency Range	13.553 ~ 13.567 MHz
Input Power	120 Vac, 60 Hz	Detector Function	Quasi-Peak
Environmental Conditions	25 deg. C, 65 % RH	Tested By	Getaz Yang

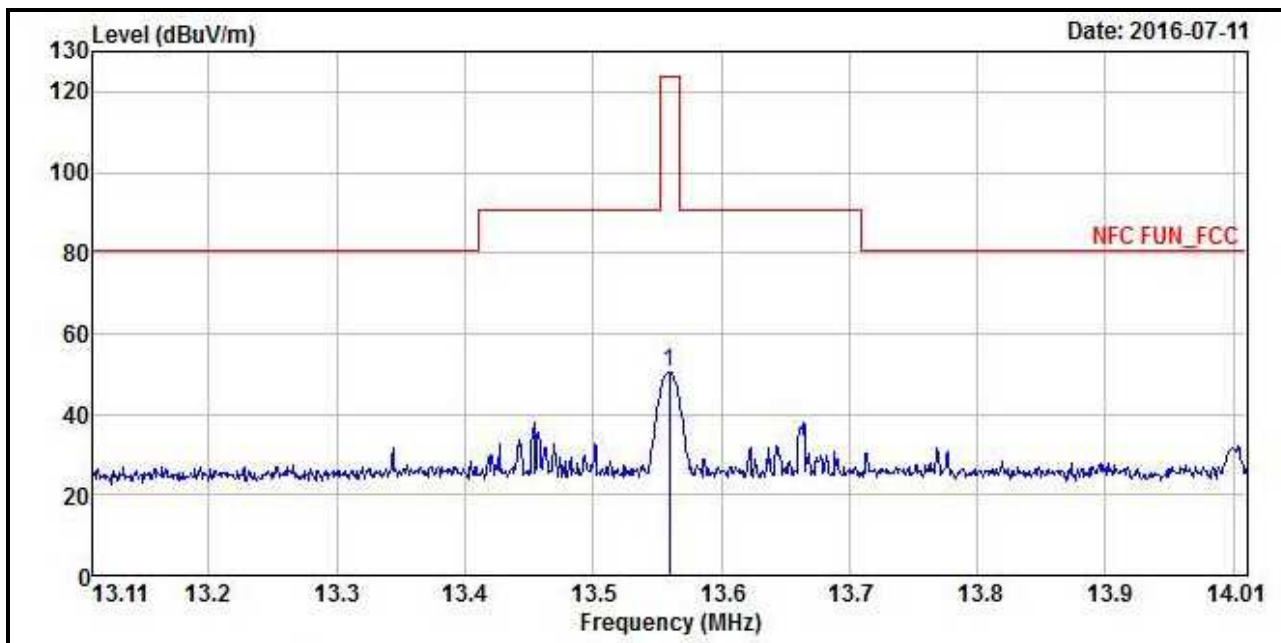

Antenna Polarity & Test Distance: Loop Antenna Close at 3M										
Frequency (MHz)	Emission Level (dBuV/m)	Read Level (dBuV)	Limit (dBuV/m)	Margin (dB)	Antenna Factor (dB/m)	Cable Loss (dB)	Preamp Factor (dB)	Antenna Height (cm)	Table Angle (Degree)	Remark
13.56	50.44	53.82	124	-73.56	37.67	0.31	41.36	100	0	Peak

Transfer the test data from the testing distance at 3M to 30M

Antenna Polarity & Test Distance: Loop Antenna Open at 30M			
Frequency (MHz)	Emission Level (dBuV/m)	Limit (dBuV/m)	Margin (dB)
13.559	10.44	84	-73.56

Note: Emission Level(dBuV/m) at 3M – 40dB = Emission Level(dBuV/m) at 30M

- REMARKS:**
1. Emission level(dBuV/m)=Raw Value(dBuV) + Correction Factor(dB/m)
 2. Correction Factor(dB/m)=Antenna Factor (dB/m)+Cable Factor (dB)–Pre-Amplifier Factor(dB)
 3. The other emission levels were very low against the limit.
 4. Margin value = Emission level – Limit value.
 5. Above limits have been translated by the formula

The measured field strength was extrapolated to distance 30 meters, using the formula that the limit of field strength varies as the inverse distance square. Extrapolation Factor = $20 \log_{10}(30/3)^2 = 40\text{dB}$

Example:

$$\begin{aligned}
 13.56 \text{ MHz} &= 15848 \text{ uV/m} && 30\text{m} \\
 &= 84 \text{ dBuV/m} && 30\text{m} \\
 &= 84+20\log(30/3)^2 && 3\text{m} \\
 &= 124 \text{ dBuV/m}
 \end{aligned}$$

EUT Test Condition		Measurement Detail	
Channel	Channel 1	Frequency Range	Below 30 MHz
Input Power	120 Vac, 60 Hz	Detector Function	Quasi-Peak
Environmental Conditions	25 deg. C, 65 % RH	Tested By	Getaz Yang

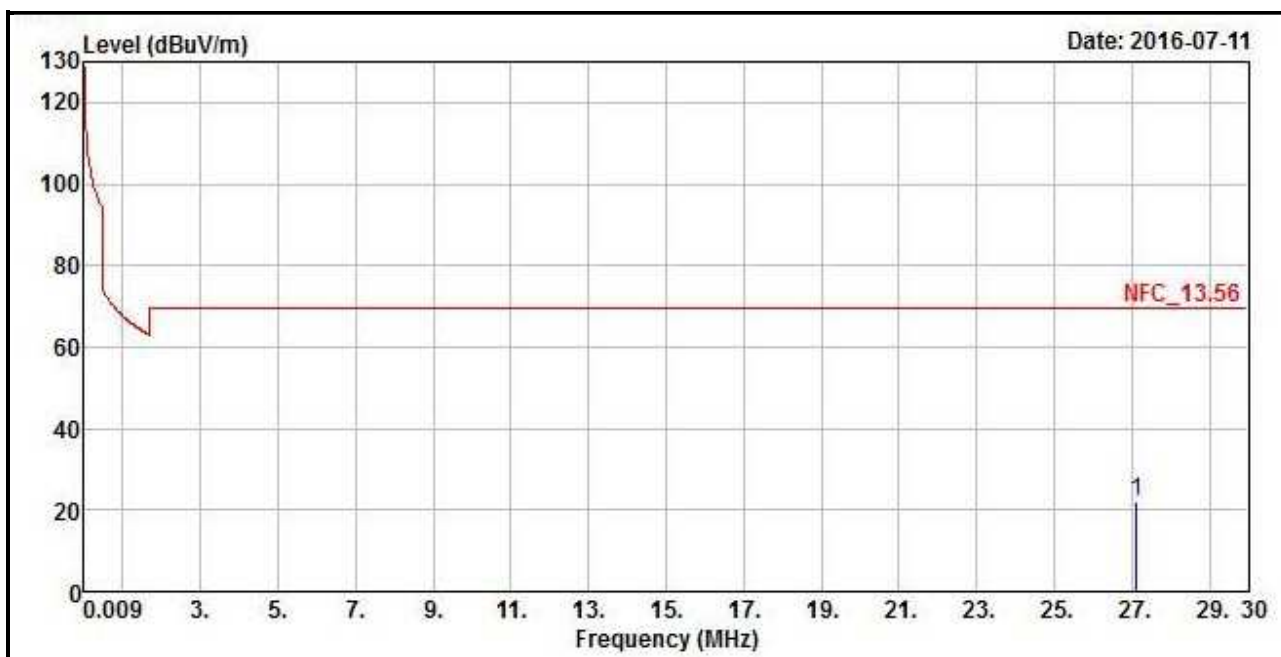

Antenna Polarity & Test Distance: Loop Antenna Open at 3M										
Frequency (MHz)	Emission Level (dBuV/m)	Read Level (dBuV)	Limit (dBuV/m)	Margin (dB)	Antenna Factor (dB/m)	Cable Loss (dB)	Preamp Factor (dB)	Antenna Height (cm)	Table Angle (Degree)	Remark
27.12	22.17	27.57	69.54	-47.37	35.55	0.38	41.33	100	0	Peak

REMARKS:

1. Emission Level(dBuV/m) = Raw Value(dBuV) + Correction Factor(dB/m)
2. Correction Factor(dB/m) = Antenna Factor(dB/m) + Cable Factor(dB) – Pre-Amplifier Factor (dB)
3. The other emission levels were very low against the limit.
4. Margin value = Emission Level – Limit value

EUT Test Condition		Measurement Detail	
Channel	Channel 1	Frequency Range	Below 30 MHz
Input Power	120 Vac, 60 Hz	Detector Function	Quasi-Peak
Environmental Conditions	25 deg. C, 65 % RH	Tested By	Getaz Yang

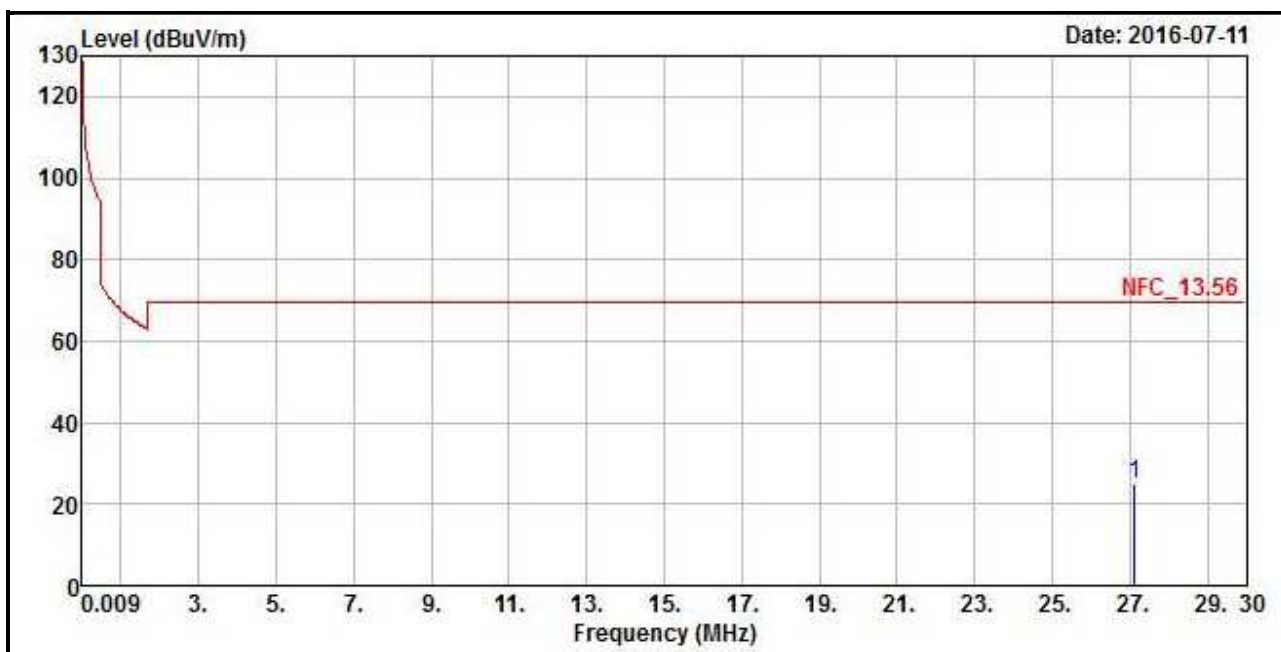

Antenna Polarity & Test Distance: Loop Antenna Close at 3M										
Frequency (MHz)	Emission Level (dBuV/m)	Read Level (dBuV)	Limit (dBuV/m)	Margin (dB)	Antenna Factor (dB/m)	Cable Loss (dB)	Preamp Factor (dB)	Antenna Height (cm)	Table Angle (Degree)	Remark
27.12	25.05	30.45	69.54	-44.49	35.55	0.38	41.33	100	360	Peak

REMARKS:

1. Emission Level(dBuV/m) = Raw Value(dBuV) + Correction Factor(dB/m)
2. Correction Factor(dB/m) = Antenna Factor(dB/m) + Cable Factor(dB) – Pre-Amplifier Factor (dB)
3. The other emission levels were very low against the limit.
4. Margin value = Emission Level – Limit value

EUT Test Condition		Measurement Detail	
Channel	Channel 1	Frequency Range	Below 1000 MHz
Input Power	120 Vac, 60 Hz	Detector Function	Quasi-Peak
Environmental Conditions	25 deg. C, 65 % RH	Tested By	Getaz Yang

HORIZONTAL

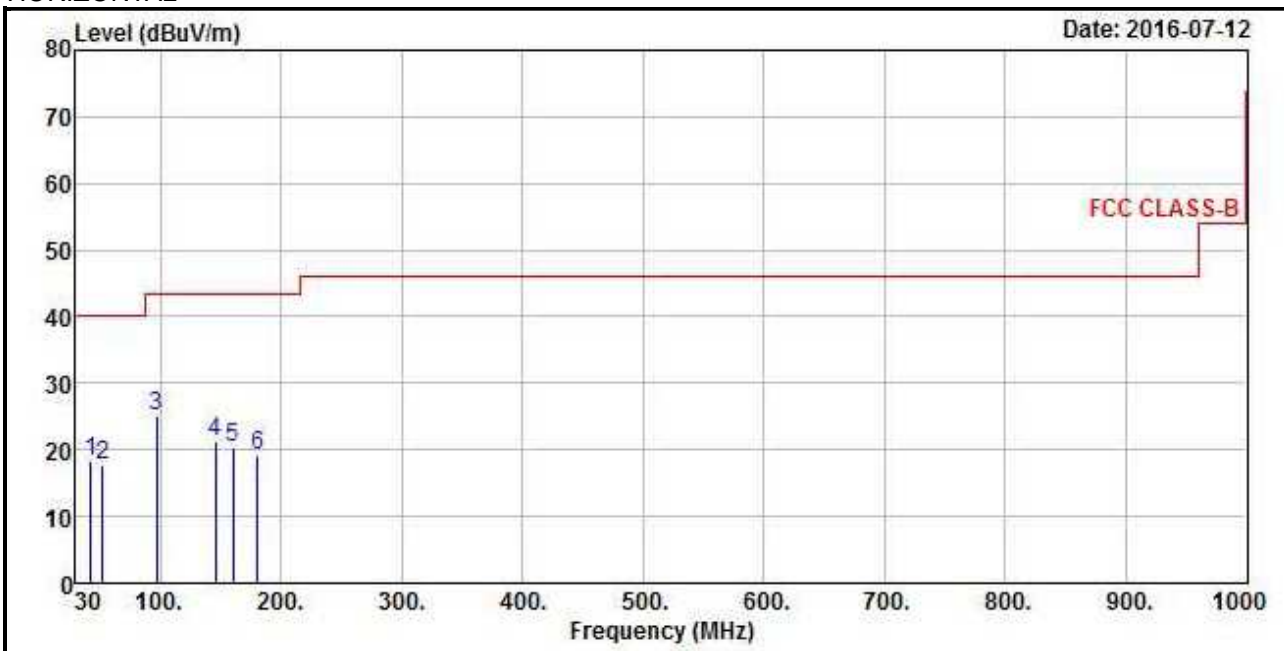

VERTICAL

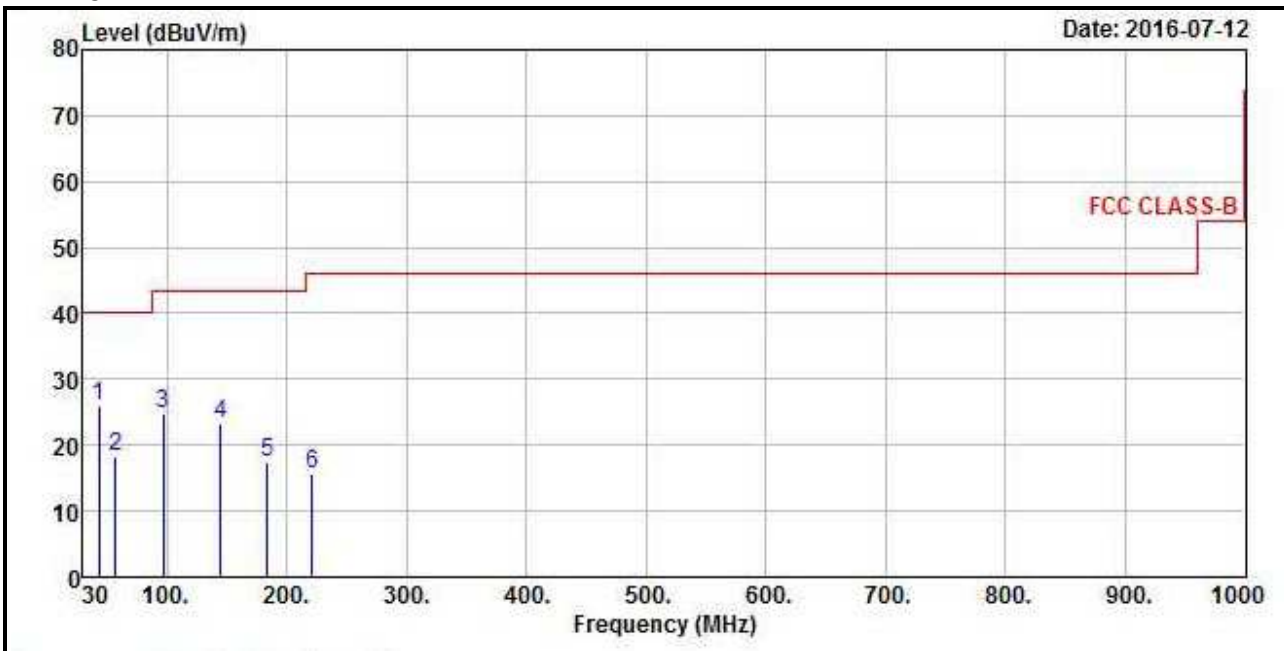

Antenna Polarity & Test Distance: Horizontal at 3 m

Frequency (MHz)	Emission Level (dBuV/m)	Read Level (dBuV)	Limit (dBuV/m)	Margin (dB)	Antenna Factor (dB/m)	Cable Loss (dB)	Preamp Factor (dB)	Antenna Height (cm)	Table Angle (Degree)	Remark
42.61	18.27	35.11	40	-21.73	13.58	0.66	31.08	104	158	Peak
52.31	17.8	35.64	40	-22.2	12.76	0.72	31.32	101	20	Peak
96.93	25.12	47.22	43.5	-18.38	8.83	1.03	31.96	121	212	Peak
145.43	21.21	39.13	43.5	-22.29	12.54	1.16	31.62	120	201	Peak
159.98	20.41	38.41	43.5	-23.09	12.73	1.15	31.88	128	194	Peak
180.35	19.07	38.95	43.5	-24.43	10.74	1.22	31.84	113	142	Peak

Antenna Polarity & Test Distance: Vertical at 3 m

Frequency (MHz)	Emission Level (dBuV/m)	Read Level (dBuV)	Limit (dBuV/m)	Margin (dB)	Antenna Factor (dB/m)	Cable Loss (dB)	Preamp Factor (dB)	Antenna Height (cm)	Table Angle (Degree)	Remark
43.58	25.86	42.71	40	-14.14	13.59	0.67	31.11	109	73	Peak
57.16	18.26	36.59	40	-21.74	12.25	0.77	31.35	138	185	Peak
96.93	24.8	46.9	43.5	-18.7	8.83	1.03	31.96	109	336	Peak
144.46	23.45	41.41	43.5	-20.05	12.51	1.16	31.63	125	213	Peak
184.23	17.34	37.42	43.5	-26.16	10.46	1.23	31.77	132	77	Peak
221.09	15.53	35.61	46	-30.47	10.26	1.38	31.72	105	59	Peak

REMARKS:

- Emission Level = Read Level + Antenna Factor + Cable Loss - Preamp Factor
Margin value = Emission level – Limit value.

#Verification of Radiated Spurious Emissions at Open-area test site

Frequency Range: 13.553 ~ 13.567 MHz

Location : OPEN SITE 6 Date : 2016/8/3 Time : PM 12:49
 Temperature (C) : 32.0 Humidity (%) : 60 Loop antenna open mode at 3M

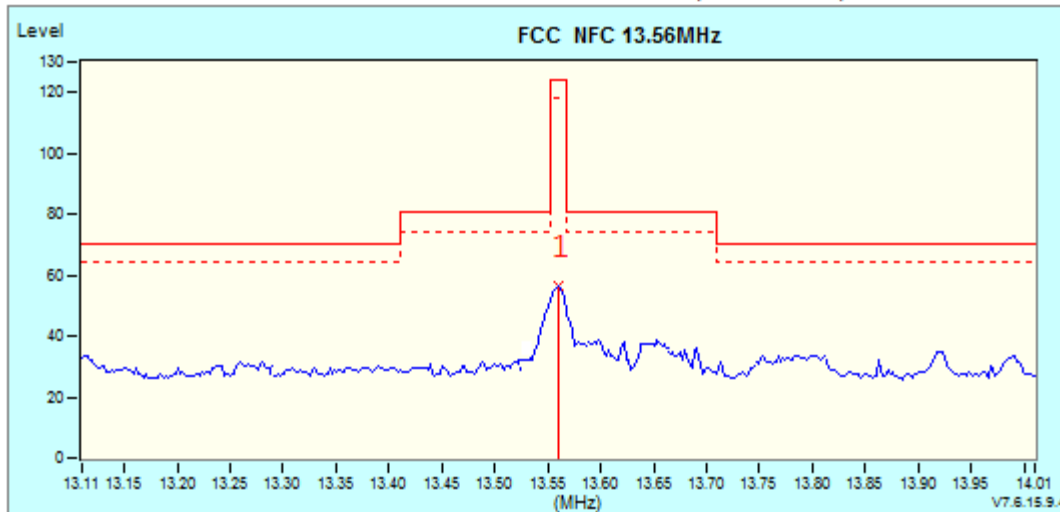

No.	Frequency MHz	Factor dB	Reading dBuV	Emission dBuV/m	Limit dBuV/m	Margin dB
* 1	13.56	-4.14	60.56	56.42	124.00	-67.58

Location : OPEN SITE 6

Date : 2016/8/3

Time : PM 12:39

Temperature (C) :32.0

Humidity (%) : 60

Loop antenna close mode at 3M

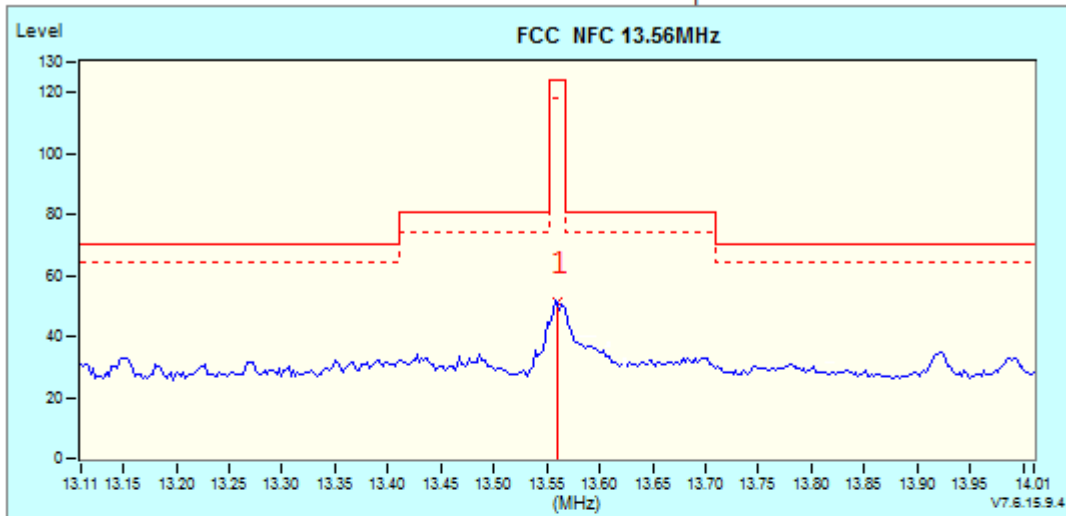

No.	Frequency MHz	Factor dB	Reading dBuV	Emission dBuV/m	Limit dBuV/m	Margin dB
* 1	13.56	-4.14	55.58	51.44	124.00	-72.56

Frequency Range: Below 30 MHz

Location : OPEN SITE 6

Date : 2016/8/3

Time : PM 12:55

Temperature (C) : 32.0

Humidity (%) : 60

Loop antenna open mode at 3M

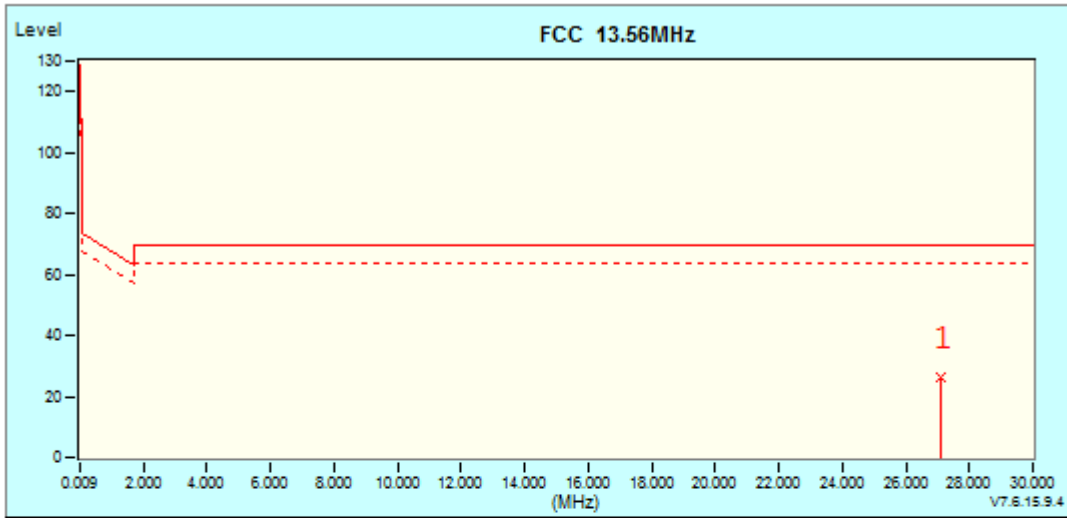

No.	Frequency MHz	Factor dB	Reading dBuV	Emission dBuV/m	Limit dBuV/m	Margin dB
* 1	27.12	-5.33	31.56	26.23	69.54	-43.31

#List of Measuring Equipment at Open-area test site

Description & Manufacturer	Model No.	Serial No.	Cal. Date	Cal. Due
Agilent Preamplifier	8447D	2432A03504	Feb. 26, 2016	Feb. 25, 2017
Agilent Test Receiver	N9038A	MY51210129	Feb. 02, 2016	Feb. 01, 2017
Loop Antenna	EM-6879	269	Jan. 07, 2016	Jan. 06, 2017
ADT. Turn Table	TT100	0306	NA	NA
ADT. Tower	AT100	0306	NA	NA
Software	Radiated_V7.6.15.9.4	NA	NA	NA
WOKEN RF cable With 5dB PAD	8D	CABLE-CH6-02	Jul. 20, 2016	Jul. 19, 2017

Notes: 1. The calibration interval of the above test instruments is 12 months and the calibrations are traceable to NML/ROC and NIST/USA.

2. The test was performed in Open-area test site No. 6.
3. The Industry Canada Reference No. IC 7450E-6.
4. The FCC Site Registration No. 447212.

4.2 Conducted Emission Measurement

4.2.1 Limits of Conducted Emission Measurement

Frequency (MHz)	Conducted Limit (dBuV)	
	Quasi-peak	Average
0.15 - 0.5	66 - 56	56 - 46
0.50 - 5.0	56	46
5.0 - 30.0	60	50

Note:

1. The lower limit shall apply at the transition frequencies.
2. The limit decreases in line with the logarithm of the frequency in the range of 0.15 to 0.50 MHz.
3. All emanations from a class A/B digital device or system, including any network of conductors and apparatus connected thereto, shall not exceed the level of field strengths specified above.

4.2.2 Test Instruments

Description & Manufacturer	Model No.	Serial No.	Date Of Calibration	Due Date Of Calibration
Test Receiver ROHDE & SCHWARZ	ESCI	100613	Nov. 16, 2015	Nov. 15, 2016
RF signal cable (with 10dB PAD) Woken	5D-FB	Cable-cond1-01	Dec. 26, 2015	Dec. 25, 2016
LISN ROHDE & SCHWARZ (EUT)	ESH3-Z5	835239/001	Feb. 26, 2016	Feb. 25, 2017
LISN ROHDE & SCHWARZ (Peripheral)	ESH3-Z5	100311	Jul. 24, 2015	Jul. 23, 2016
Software ADT	BV ADT_Cond_ V7.3.7.3	NA	NA	NA

- NOTE:**
1. The calibration interval of the above test instruments is 12 months and the calibrations are traceable to NML/ROC and NIST/USA.
 2. The test was performed in HwaYa Shielded Room 2.
 3. The VCCI Site Registration No. is C-2047.

4.2.3 Test Procedures

- The EUT was placed 0.4 meters from the conducting wall of the shielded room with EUT being connected to the power mains through a line impedance stabilization network (LISN). Other support units were connected to the power mains through another LISN. The two LISNs provide 50 ohm/50 uH of coupling impedance for the measuring instrument.
- Both lines of the power mains connected to the EUT were checked for maximum conducted interference.
- The frequency range from 150 kHz to 30 MHz was searched. Emission levels under (Limit – 20 dB) was not recorded.

NOTE: The resolution bandwidth and video bandwidth of test receiver is 9 kHz for quasi-peak detection (QP) and average detection (AV) at frequency 0.15 MHz - 30 MHz.

4.2.4 Deviation from Test Standard

No deviation.

4.2.5 Test Setup

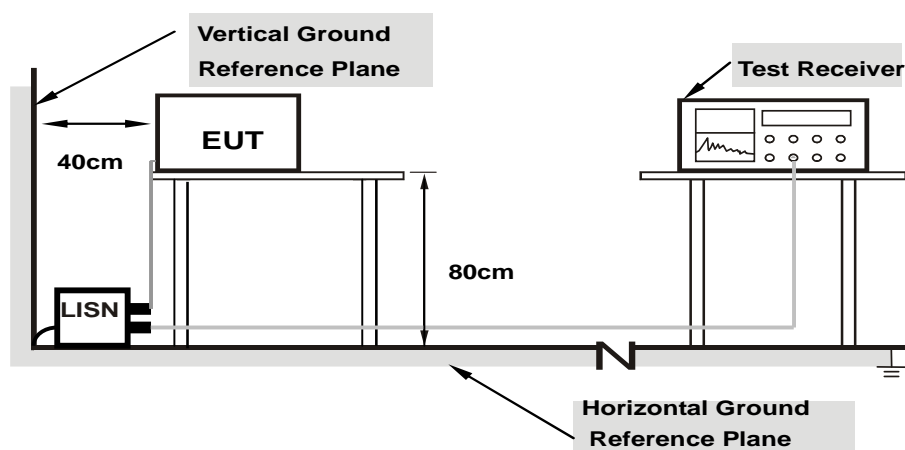

- Note:**
- Support units were connected to second LISN.
 - Both of LISNs (AMN) are 80 cm from EUT and at least 80 cm from other units and other metal planes

For the actual test configuration, please refer to the attached file (Test Setup Photo).

4.2.6 EUT Operating Conditions

- Placed the EUT on the testing table.
- Set the EUT under transmission condition continuously at specific channel frequency.

4.2.7 Test Results

Frequency Range	150kHz ~ 30MHz	Detector Function & Resolution Bandwidth	Quasi-Peak (QP) / Average (AV), 9kHz
Input Power	120Vac, 60Hz	Environmental Conditions	25°C, 65%RH
Tested by	Toby Tian	Test Date	2016/7/8

Phase Of Power : Line (L)										
No	Frequency (MHz)	Correction Factor (dB)	Reading Value (dBuV)		Emission Level (dBuV)		Limit (dBuV)		Margin (dB)	
			Q.P.	AV.	Q.P.	AV.	Q.P.	AV.	Q.P.	AV.
1	0.20474	10.03	22.22	11.85	32.25	21.88	63.42	53.42	-31.17	-31.54
2	0.26730	10.06	20.92	9.71	30.98	19.77	61.20	51.20	-30.22	-31.43
3	0.40800	10.12	19.64	9.50	29.76	19.62	57.69	47.69	-27.93	-28.07
4	0.61138	10.15	19.58	13.86	29.73	24.01	56.00	46.00	-26.27	-21.99
5	8.76373	10.66	21.81	13.25	32.47	23.91	60.00	50.00	-27.53	-26.09
6	13.55739	10.93	37.18	29.46	48.11	40.39	60.00	50.00	-11.89	-9.61

Remarks:

1. Q.P. and AV. are abbreviations of quasi-peak and average individually.
2. The emission levels of other frequencies were very low against the limit.
3. Margin value = Emission level – Limit value
4. Correction factor = Insertion loss + Cable loss
5. Emission Level = Correction Factor + Reading Value

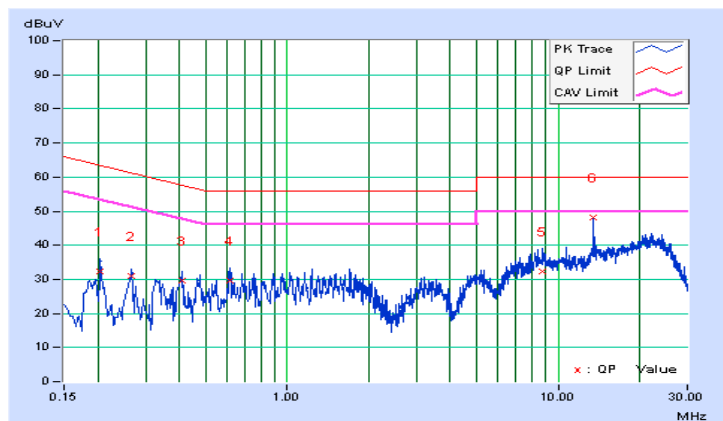

Frequency Range	150kHz ~ 30MHz	Detector Function & Resolution Bandwidth	Quasi-Peak (QP) / Average (AV), 9kHz
Input Power	120Vac, 60Hz	Environmental Conditions	25°C, 65%RH
Tested by	Toby Tian	Test Date	2016/7/8

Phase Of Power : Neutral (N)										
No	Frequency (MHz)	Correction Factor (dB)	Reading Value (dBuV)		Emission Level (dBuV)		Limit (dBuV)		Margin (dB)	
			Q.P.	AV.	Q.P.	AV.	Q.P.	AV.	Q.P.	AV.
1	0.20458	10.04	21.41	12.05	31.45	22.09	63.42	53.42	-31.97	-31.33
2	0.26730	10.07	20.47	9.62	30.54	19.69	61.20	51.20	-30.66	-31.51
3	0.54491	10.15	19.52	11.48	29.67	21.63	56.00	46.00	-26.33	-24.37
4	1.57715	10.25	16.41	10.23	26.66	20.48	56.00	46.00	-29.34	-25.52
5	8.77546	10.72	20.42	11.34	31.14	22.06	60.00	50.00	-28.86	-27.94
6	13.56130	11.02	35.54	21.39	46.56	32.41	60.00	50.00	-13.44	-17.59

Remarks:

1. Q.P. and AV. are abbreviations of quasi-peak and average individually.
2. The emission levels of other frequencies were very low against the limit.
3. Margin value = Emission level – Limit value
4. Correction factor = Insertion loss + Cable loss
5. Emission Level = Correction Factor + Reading Value

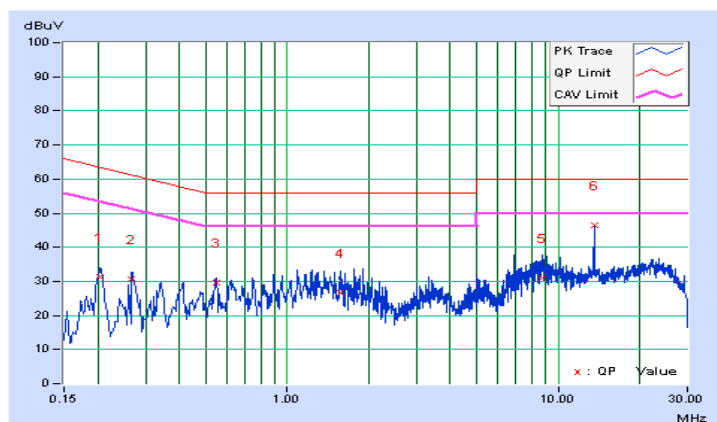

4.3 Frequency Stability

4.3.1 Limits of Frequency Stability Measurement

The frequency tolerance of the carrier signal shall be maintained within $\pm 0.01\%$ of the operating frequency over a temperature variation of -20 degrees to 50 degrees C at normal supply voltage, and for a variation in the primary supply voltage from 85% to 115% of the rated supply voltage at a temperature of 20 degrees C.

4.3.2 Test Setup

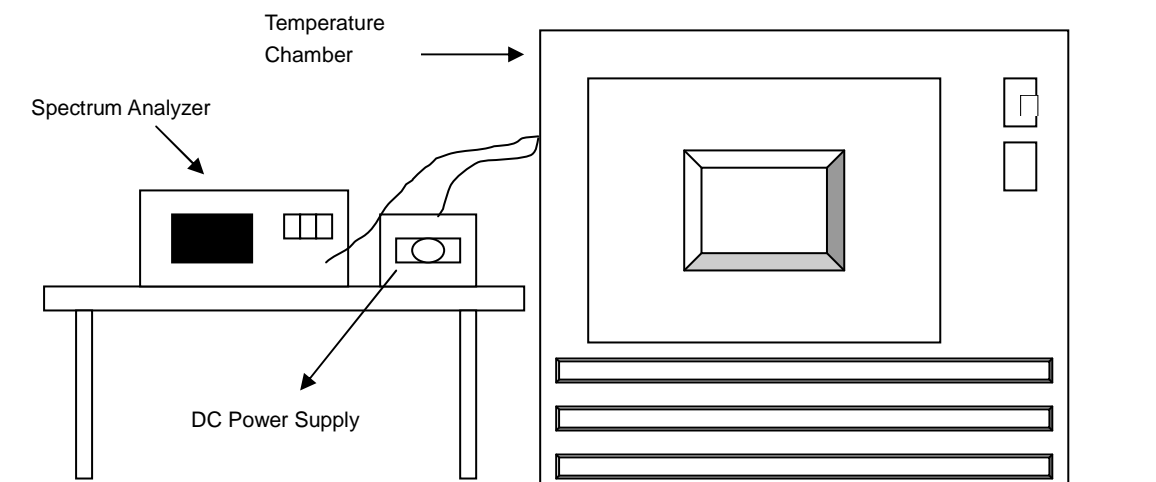

4.3.3 Test Instruments

Refer to section 4.1.2 to get information of above instrument.

4.3.4 Test Procedure

- The EUT was placed inside the environmental test chamber and powered by nominal AC voltage.
- Turned the EUT on and coupled its output to a spectrum analyzer.
- Turned the EUT off and set the chamber to the highest temperature specified.
- Allowed sufficient time (approximately 30 min) for the temperature of the chamber to stabilize then turned the EUT on and measured the operating frequency after 2, 5, and 10 minutes.
- Repeated step 2 and 3 with the temperature chamber set to the lowest temperature.
- The test chamber was allowed to stabilize at $+20$ degree C for a minimum of 30 minutes. The supply voltage was then adjusted on the EUT from 85% to 115% and the frequency record.

4.3.5 Deviation from Test Standard

No deviation.

4.3.6 EUT Operating Conditions

- Placed the EUT on the testing table.
- Set the EUT under transmission condition continuously at specific channel frequency.

4.3.7 Test Result

Frequency Stability Versus Temperature									
Temp. (°C)	Power Supply (Vdc)	0 Minute		2 Minute		5 Minute		10 Minute	
		Measured Frequency	Frequency Drift	Measured Frequency	Frequency Drift	Measured Frequency	Frequency Drift	Measured Frequency	Frequency Drift
		(MHz)	%	(MHz)	%	(MHz)	%	(MHz)	%
55	3.8	13.560021	0.00015	13.560041	0.00030	13.560042	0.00031	13.560033	0.00024
50	3.8	13.560019	0.00014	13.560031	0.00023	13.560022	0.00016	13.560016	0.00012
40	3.8	13.559990	-0.00007	13.559993	-0.00005	13.559984	-0.00012	13.559976	-0.00018
30	3.8	13.560047	0.00035	13.560043	0.00032	13.560063	0.00046	13.560062	0.00046
20	3.8	13.560009	0.00007	13.559997	-0.00002	13.560003	0.00002	13.560024	0.00018
10	3.8	13.560044	0.00032	13.560039	0.00029	13.560044	0.00032	13.560046	0.00034
0	3.8	13.560032	0.00024	13.560032	0.00024	13.560017	0.00013	13.560019	0.00014
-10	3.8	13.559947	-0.00039	13.559943	-0.00042	13.559954	-0.00034	13.559946	-0.00040
-20	3.8	13.559994	-0.00004	13.559982	-0.00013	13.559990	-0.00007	13.559976	-0.00018
-30	3.8	13.560059	0.00044	13.560038	0.00028	13.560064	0.00047	13.560058	0.00043

Frequency Stability Versus Voltage									
Temp. (°C)	Power Supply (Vdc)	0 Minute		2 Minute		5 Minute		10 Minute	
		Measured Frequency	Frequency Drift	Measured Frequency	Frequency Drift	Measured Frequency	Frequency Drift	Measured Frequency	Frequency Drift
		(MHz)	%	(MHz)	%	(MHz)	%	(MHz)	%
20	4.2	13.560005	0.00004	13.560000	0.00000	13.560001	0.00001	13.560025	0.00018
	3.8	13.560009	0.00007	13.559997	-0.00002	13.560003	0.00002	13.560024	0.00018
	3.6	13.560005	0.00004	13.559997	-0.00002	13.560006	0.00004	13.560023	0.00017

4.4 20 dB Bandwidth

4.4.1 Limits of 20 dB Bandwidth Measurement

The 20 dB bandwidth shall be specified in operating frequency band.

4.4.2 Test Setup

Refer to section 4.1.5.

4.4.3 Test Instruments

Refer to section 4.1.2 to get information of above instrument.

4.4.4 Test Procedures

The bandwidth of the fundamental frequency was measured by spectrum analyzer with 1 kHz RBW and 3 kHz VBW. The 20 dB bandwidth is defined as the total spectrum the power of which is higher than peak power minus 20 dB.

4.4.5 Deviation from Test Standard

No deviation.

4.4.6 EUT Operating Conditions

- a. Placed the EUT on the testing table.
- b. Set the EUT under transmission condition continuously at specific channel frequency.

4.4.7 Test Results

20 dBc Point (Low)	20 dBc Point (High)	Operating Frequency Band (MHz)	Pass / Fail
13.558075000 MHz	13.560568750 MHz	13.553~13.567	Pass

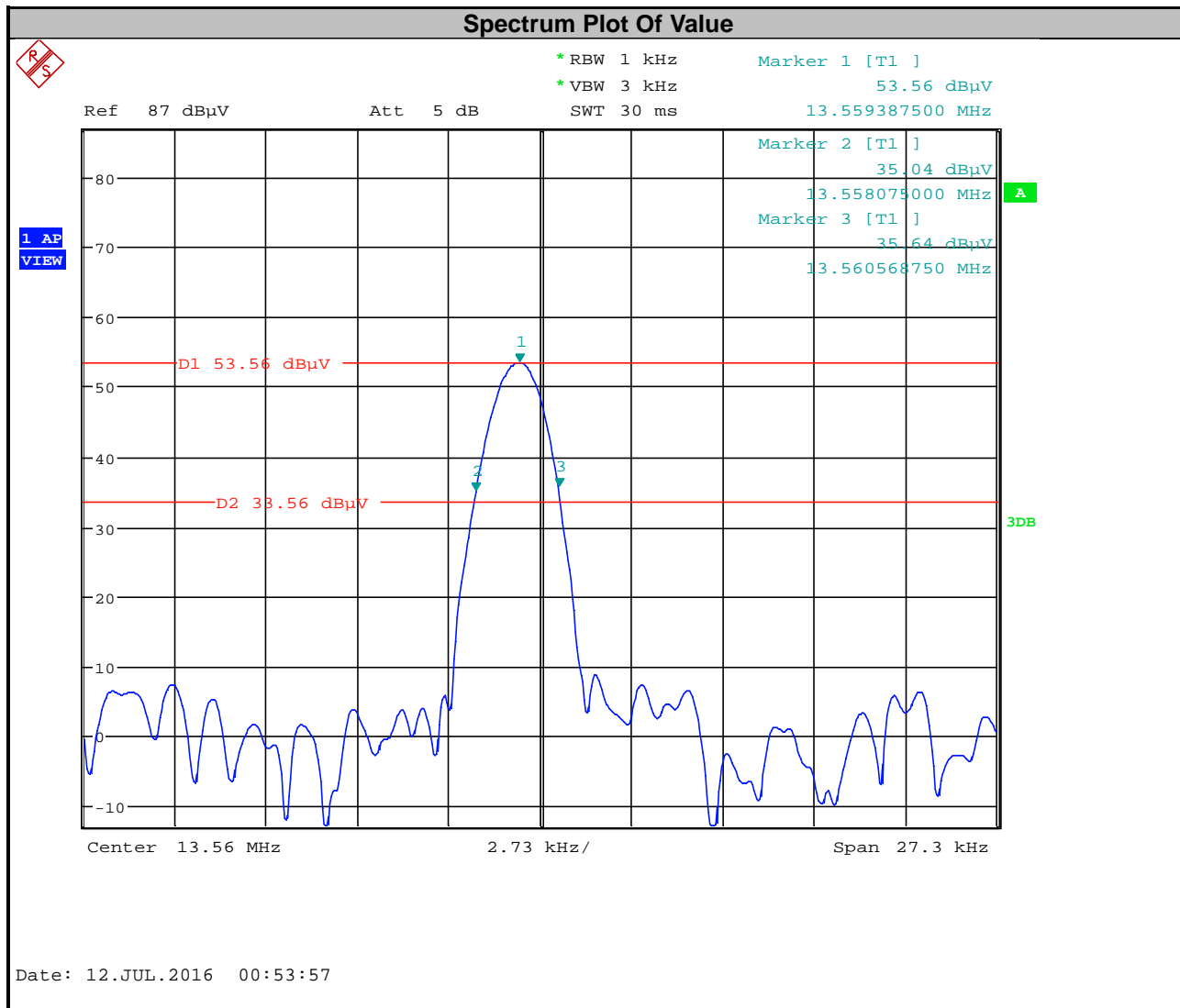

5 Pictures of Test Arrangements

Please refer to the attached file (Test Setup Photo).

Appendix – Information on the Testing Laboratories

We, Bureau Veritas Consumer Products Services (H.K.) Ltd., Taoyuan Branch, were founded in 1988 to provide our best service in EMC, Radio, Telecom and Safety consultation. Our laboratories are accredited and approved according to ISO/IEC 17025.

If you have any comments, please feel free to contact us at the following:

Linko EMC/RF Lab

Tel: 886-2-26052180

Fax: 886-2-26051924

Hsin Chu EMC/RF/Telecom Lab

Tel: 886-3-6668565

Fax: 886-3-6668323

Hwa Ya EMC/RF/Safety

Tel: 886-3-3183232

Fax: 886-3-3270892

Email: service.adt@tw.bureauveritas.com

Web Site: www.bureauveritas-adt.com

The address and road map of all our labs can be found in our web site also.

--- END ---