



FCC RF Test Report

APPLICANT : Sony Mobile Communications Inc.
EQUIPMENT : GSM/WCDMA/LTE Phone+Bluetooth, DTS/UNII
a/b/g/n/ac and NFC
BRAND NAME : Sony
FCC ID : PY7-08608T
STANDARD : FCC Part 15 Subpart E §15.407
CLASSIFICATION : (NII) Unlicensed National Information Infrastructure

The product was received on Jun. 07, 2017 and testing was completed on Oct. 03, 2017. We, SPORTON INTERNATIONAL INC., would like to declare that the tested sample has been evaluated in accordance with the test procedures and has been in compliance with the applicable technical standards.

The test results in this report apply exclusively to the tested model / sample. Without written approval of SPORTON INTERNATIONAL INC., the test report shall not be reproduced except in full.

Reviewed by: Joseph Lin / Supervisor

Approved by: Jones Tsai / Manager



SPORTON INTERNATIONAL INC.

No. 52, Hwa Ya 1st Rd., Hwa Ya Technology Park, Kwei-Shan District, Tao Yuan City, Taiwan, R.O.C.

SPORTON INTERNATIONAL INC.

TEL : 886-3-327-3456

FAX : 886-3-328-4978

FCC ID : PY7-08608T

Page Number : 1 of 33

Report Issued Date : Oct. 26, 2017

Report Version : Rev. 02

Report Template No.: BU5-FR15EWL Version 2.0



TABLE OF CONTENTS

SUMMARY OF TEST RESULT 4

1 GENERAL DESCRIPTION 5

 1.1 Applicant 5

 1.2 Manufacturer 5

 1.3 Product Feature of Equipment Under Test 5

 1.4 Modification of EUT 6

 1.5 Testing Location 7

 1.6 Applicable Standards 7

2 TEST CONFIGURATION OF EQUIPMENT UNDER TEST 8

 2.1 Carrier Frequency Channel 8

 2.2 Test Mode 9

 2.3 Connection Diagram of Test System 11

 2.4 Support Unit used in test configuration and system 12

 2.5 EUT Operation Test Setup 12

 2.6 Measurement Results Explanation Example 12

3 TEST RESULT 13

 3.1 26dB & 99% Occupied Bandwidth Measurement 13

 3.2 Maximum Conducted Output Power Measurement 15

 3.3 Power Spectral Density Measurement 17

 3.4 Unwanted Radiated Emission Measurement 20

 3.5 AC Conducted Emission Measurement 26

 3.6 Frequency Stability Measurement 28

 3.7 Automatically Discontinue Transmission 29

 3.8 Antenna Requirements 30

4 LIST OF MEASURING EQUIPMENTS 31

5 UNCERTAINTY OF EVALUATION 33

APPENDIX A. CONDUCTED TEST RESULTS

APPENDIX B. AC CONDUCTED EMISSION TEST RESULT

APPENDIX C. RADIATED SPURIOUS EMISSION

APPENDIX D. RADIATED SPURIOUS EMISSION PLOTS

APPENDIX E. DUTY CYCLE PLOTS

APPENDIX F. SETUP PHOTOGRAPHS



REVISION HISTORY

REPORT NO.	VERSION	DESCRIPTION	ISSUED DATE
FR760710-01E	Rev. 01	Initial issue of report	Oct. 24, 2017
FR760710-01E	Rev. 02	Add FCC designation No. in section 1.5, and add duty factor in appendix e. Revising KDB789033 information in section 3.1.1, 3.2.1, and 3.3.1	Oct. 26, 2017



SUMMARY OF TEST RESULT

Report Section	FCC Rule	Description	Limit	Result	Remark
3.1	2.1049 15.403(i)	26dB & 99% Bandwidth	-	Pass	-
3.2	15.407(a)	Maximum Conducted Output Power	≤ 24 dBm (depend on band)	Pass	-
3.3	15.407(a)	Power Spectral Density	≤ 11 dBm (depend on band)	Pass	-
3.4	15.407(b)	Unwanted Emissions	≤ -17, -27 dBm (depend on band)&15.209(a)	Pass	Under limit 6.06 dB at 5725.08 MHz
3.5	15.207	AC Conducted Emission	15.207(a)	Pass	Under limit 15.30 dB at 0.150 MHz
3.6	15.407(g)	Frequency Stability	Within Operation Band	Pass	-
3.7	15.407(c)	Automatically Discontinue Transmission	Discontinue Transmission	Pass	-
3.8	15.203 & 15.407(a)	Antenna Requirement	N/A	Pass	-



1 General Description

1.1 Applicant

Sony Mobile Communications Inc.

4-12-3 Higashi-Shinagawa, Shinagawa-ku, Tokyo, 140-0002, Japan

1.2 Manufacturer

Sony Mobile Communications Inc.

4-12-3 Higashi-Shinagawa, Shinagawa-ku, Tokyo, 140-0002, Japan

1.3 Product Feature of Equipment Under Test

GSM/WCDMA/LTE, Bluetooth, DTS/UNII a/b/g/n/ac, FM Receiver, NFC, and GPS.

Product Specification subjective to this standard	
Antenna Type	PIFA Antenna
Antenna Gain	<5150 MHz ~ 5250 MHz> -4.90 dBi
	<5250 MHz ~ 5350 MHz> -5.00 dBi
	<5470 MHz ~ 5725 MHz> -2.60 dBi

EUT Information List			
HW Version	SW Version	S/N	Performed Test Item
A	1.14	RQ3005UYBC	RF conducted measurement
		CQ300000EW	Radiated Spurious Emission
		CQ300000EL	AC Conducted Emission



Accessory List	
AC Adapter 1	Model Name: UCH12
	S/N: VB17W34100174 (for radiated emission) VB17W34100230 (for conducted emission)
Earphone 1	Model Name: MH410c
	S/N: N/A
USB Cable	Model Name: UCB20
	S/N: N/A

Note:

1. Above EUT list and accessory list used are electrically identical per declared by manufacturer.
2. Above the accessories list are used to exercise the EUT during test.
3. For other wireless features of this EUT, test report will be issued separately.

1.4 Modification of EUT

No modifications are made to the EUT during all test items.



1.5 Testing Location

Sporton Lab is accredited to ISO 17025 by Taiwan Accreditation Foundation (TAF code : 1190) and the FCC designation No. TW1190 and TW0007 under the FCC 2.948(e) by Mutual Recognition Agreement (MRA) in FCC Test.

Test Site	SPORTON INTERNATIONAL INC.	
Test Site Location	No. 52, Hwa Ya 1 st Rd., Hwa Ya Technology Park, Kwei-Shan District, Tao Yuan City, Taiwan, R.O.C. TEL: +886-3-327-3456 FAX: +886-3-328-4978	
Test Site No.	Sporton Site No.	
	TH05-HY	CO05-HY

Note: The test site complies with ANSI C63.4 2014 requirement.

Test Site	SPORTON INTERNATIONAL INC.	
Test Site Location	No.58, Aly. 75, Ln. 564, Wenhua 3rd Rd. Guishan Dist, Taoyuan City, Taiwan (R.O.C.) TEL: +886-3-327-0868 FAX: +886-3-327-0855	
Test Site No.	Sporton Site No.	
	03CH12-HY	

Note: The test site complies with ANSI C63.4 2014 requirement.

1.6 Applicable Standards

According to the specifications of the manufacturer, the EUT must comply with the requirements of the following standards:

- ♦ FCC Part 15 Subpart E
- ♦ FCC KDB 789033 D02 General UNII Test Procedures New Rules v01r04.
- ♦ ANSI C63.10-2013

Remark:

1. All test items were verified and recorded according to the standards and without any deviation during the test.
2. This EUT has also been tested and complied with the requirements of FCC Part 15, Subpart B, recorded in a separate test report.



2 Test Configuration of Equipment Under Test

- a. The EUT has been associated with peripherals and configuration operated in a manner tended to maximize its emission characteristics in a typical application. Frequency range investigated: conduction emission (150 kHz to 30 MHz), radiation emission (9 kHz to the 10th harmonic of the highest fundamental frequency or to 40 GHz, whichever is lower). For radiated measurement, pre-scanned in three orthogonal panels, X, Y, Z. The worst cases (X plane) were recorded in this report.
- b. AC power line Conducted Emission was tested under maximum output power.

2.1 Carrier Frequency Channel

Frequency Band	Channel	Freq. (MHz)	Channel	Freq. (MHz)
5150-5250 MHz Band 1 (U-NII-1)	36	5180	44	5220
	38*	5190	46*	5230
	40	5200	48	5240
	42 [#]	5210		

Frequency Band	Channel	Freq. (MHz)	Channel	Freq. (MHz)
5250-5350 MHz Band 2 (U-NII-2A)	52	5260	60	5300
	54*	5270	62*	5310
	56	5280	64	5320
	58 [#]	5290		

Frequency Band	Channel	Freq. (MHz)	Channel	Freq. (MHz)
5470-5725 MHz Band 3 (U-NII-2C)	100	5500	112	5560
	102*	5510	116	5580
	104	5520	132	5660
	106 [#]	5530	134*	5670
	108	5540	136	5680
	110*	5550	140	5700



Frequency Band	Channel	Freq. (MHz)	Channel	Freq. (MHz)
TDWR Channel	118*	5590	124	5620
	120	5600	126*	5630
	122 [#]	5610	128	5640

Frequency Band	Channel	Freq. (MHz)	Channel	Freq. (MHz)
Straddle Channel	138 [#]	5690	144	5720
	142*	5710		

Note:

1. The above Frequency and Channel in "*" were 802.11n HT40 and 802.11ac VHT40.
2. The above Frequency and Channel in "[#]" were 802.11ac VHT80.

2.2 Test Mode

Final test mode of conducted test items and radiated spurious emissions are considering the modulation and worse data rates as below table.

Modulation	Data Rate
802.11a	6 Mbps
802.11ac VHT20	MCS0
802.11ac VHT40	MCS0
802.11ac VHT80	MCS0

Test Cases	
AC Conducted Emission	Mode 1 : Bluetooth Link + WLAN (5GHz) Link + Earphone 1 + Battery 1 + USB Cable (Charging from Adapter 1)
Remark: For Radiated Test Cases, The tests were performance with Battery 1.	



Ch. #		Band I : 5150-5250 MHz	Band II : 5250-5350 MHz	Band III : 5470-5725MHz
		802.11a	802.11a	802.11a
L	Low	36	52	100
M	Middle	44	60	116
H	High	48	64	140
Straddle		-	-	144

Ch. #		Band I : 5150-5250 MHz	Band II : 5250-5350 MHz	Band III : 5470-5725MHz
		802.11ac VHT20	802.11ac VHT20	802.11ac VHT20
L	Low	36	52	100
M	Middle	44	60	116
H	High	48	64	140
Straddle		-	-	144

Ch. #		Band I : 5150-5250 MHz	Band II : 5250-5350 MHz	Band III : 5470-5725MHz
		802.11ac VHT40	802.11ac VHT40	802.11ac VHT40
L	Low	38	54	102
M	Middle	-	-	110
H	High	46	62	134
Straddle		-	-	142

Ch. #		Band I : 5150-5250 MHz	Band II : 5250-5350 MHz	Band III : 5470-5725MHz
		802.11ac VHT80	802.11ac VHT80	802.11ac VHT80
L	Low	-	-	106
M	Middle	42	58	-
H	High	-	-	-
Straddle		-	-	138

2.3 Connection Diagram of Test System

<WLAN Tx Mode>

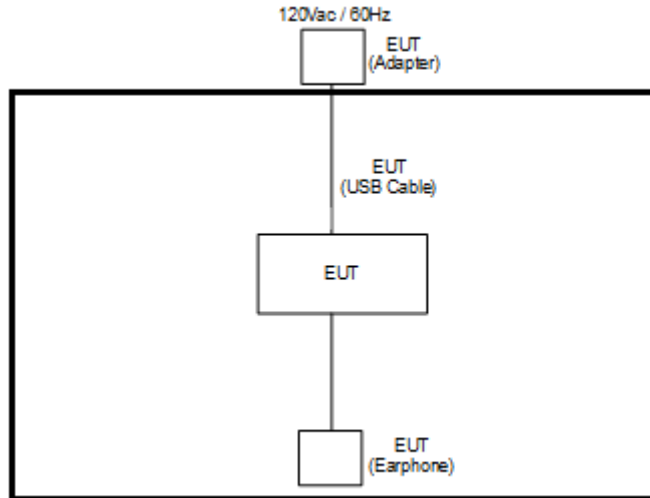

<AC Conducted Emission Mode>

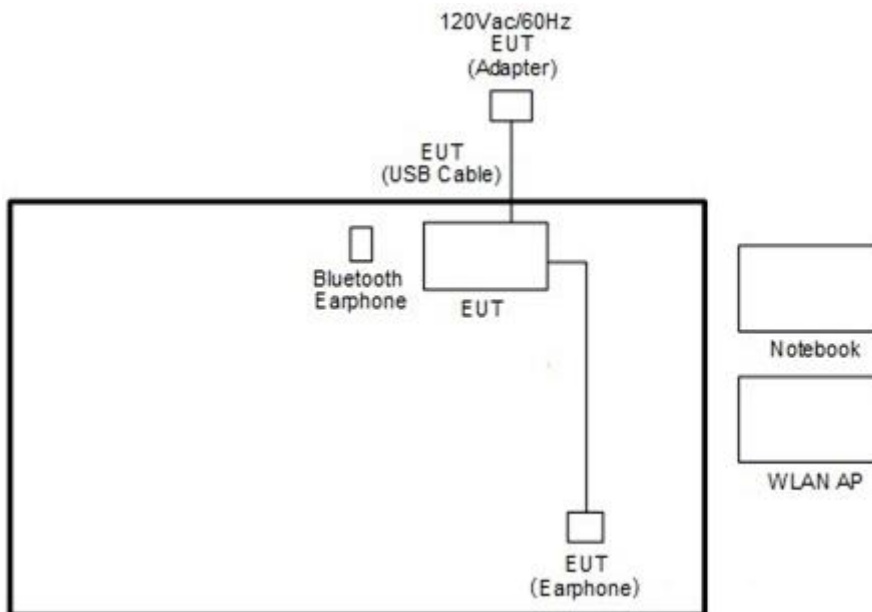



2.4 Support Unit used in test configuration and system

Item	Equipment	Trade Name	Model Name	FCC ID	Data Cable	Power Cord
1.	Bluetooth Earphone	Sony	SBH20	PY7-RD0010	N/A	N/A
2.	WLAN AP	ASUS	RT-AC66U	MSQ-RTAC66U	N/A	Unshielded, 1.8 m
3.	Notebook	DELL	Latitude E6320	FCC DoC/ Contains FCC ID: QDS-BRCM1054	N/A	AC I/P: Unshielded, 1.2 m DC O/P: Shielded, 1.8 m
4.	SD Card	SanDisk	MicroSD HC	FCC DoC	N/A	N/A

2.5 EUT Operation Test Setup

The RF test items, an engineering test program was provided and enabled to make EUT continuous transmit/receive.

2.6 Measurement Results Explanation Example

For all conducted test items:

The offset level is set in the spectrum analyzer to compensate the RF cable loss and attenuator factor between EUT conducted output port and spectrum analyzer. With the offset compensation, the spectrum analyzer reading level is exactly the EUT RF output level.

Example :

The spectrum analyzer offset is derived from RF cable loss and attenuator factor.

Offset = RF cable loss + attenuator factor.

Following shows an offset computation example with cable loss 4.2 dB and 10dB attenuator.

$$\begin{aligned} \text{Offset(dB)} &= \text{RF cable loss(dB)} + \text{attenuator factor(dB)}. \\ &= 4.2 + 10 = 14.2 \text{ (dB)} \end{aligned}$$

3 Test Result

3.1 26dB & 99% Occupied Bandwidth Measurement

3.1.1 Description of 26dB & 99% Occupied Bandwidth

This section is for reporting purpose only.

There is no restriction limits for bandwidth.

For Straddle Channel, According to KDB 789033 D02 General UNII Test Procedures New Rules v01r04, If the power and PSD of the devices are uniform and comply with the lower limits specified for the U-NII-2 bands, a single measurement over the entire emission bandwidth can be performed to show compliance.

3.1.2 Measuring Instruments

The measuring equipment is listed in the section 4 of this test report.

3.1.3 Test Procedures

1. The testing follows FCC KDB 789033 D02 General UNII Test Procedures New Rules v01r04. Section C) Emission bandwidth
2. Set RBW = approximately 1% of the emission bandwidth.
3. Set the VBW > RBW.
4. Detector = Peak.
5. Trace mode = max hold
6. Measure the maximum width of the emission that is 26 dB down from the peak of the emission. Compare this with the RBW setting of the analyzer. Readjust RBW and repeat measurement as needed until the RBW/EBW ratio is approximately 1%.
7. For 99% Bandwidth Measurement, the spectrum analyzer's resolution bandwidth (RBW) is set 1MHz and set the Video bandwidth (VBW) $\geq 3 * RBW$.
8. Measure and record the results in the test report.

3.1.4 Test Setup

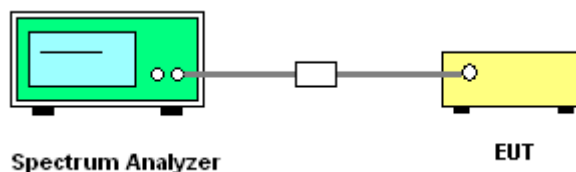



3.1.5 Test Result of 26dB & 99% Occupied Bandwidth Plots

Please refer to Appendix A.

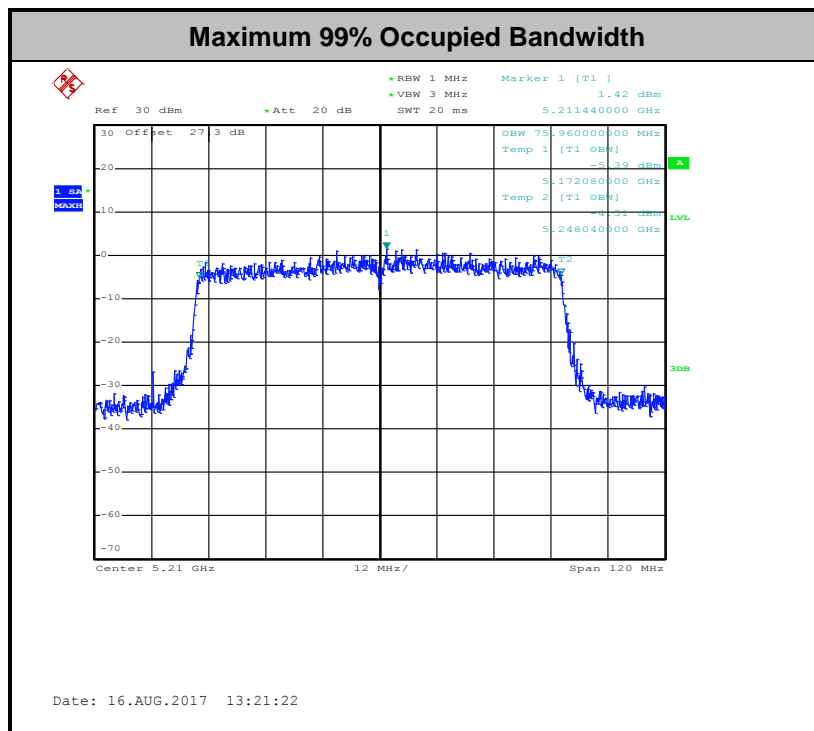
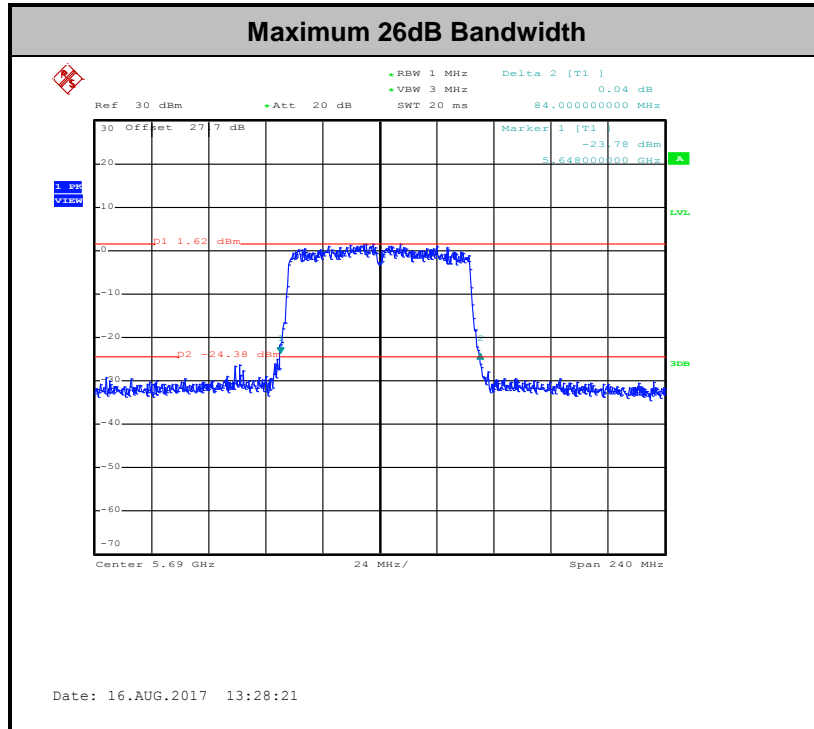

Note : The occupied channel bandwidth is maintained within the band of operation for all of the modulations.



3.2 Maximum Conducted Output Power Measurement

3.2.1 Limit of Maximum Conducted Output Power

<FCC 14-30 CFR 15.407>

For mobile and portable client devices in the 5.15–5.25 GHz band, the maximum conducted output power over the frequency band of operation shall not exceed 250 mW.

For the 5.25–5.725 GHz bands, the maximum conducted output power over the frequency bands of operation shall not exceed the lesser of 250 mW or $11 \text{ dBm} + 10 \log B$, where B is the 26 dB emission bandwidth in megahertz.

If transmitting antennas of directional gain greater than 6 dBi are used, the peak output power shall be reduced by the amount in dB that the directional gain of the antenna exceeds 6 dBi.

Note that U-NII-2 band, devices with a maximum e.i.r.p. greater than 500 mW shall implement TPC in order to have the capability to operate at least 6 dB below the maximum permitted e.i.r.p. of 1 W.

For Straddle Channel, According to KDB 789033 D02 General UNII Test Procedures New Rules v01r04. If the power and PSD of the devices are uniform and comply with the lower limits specified for the U-NII-2 bands, a single measurement over the entire emission bandwidth can be performed to show compliance.

3.2.2 Measuring Instruments

The measuring equipment is listed in the section 4 of this test report.

3.2.3 Test Procedures

The testing follows Method PM of FCC KDB 789033 D02 General UNII Test Procedures New Rules v01r04.

Method PM (Measurement using an RF average power meter):

1. Measurement is performed using a wideband RF power meter.
2. The EUT is configured to transmit continuously with a consistent duty cycle at its maximum power control level.
3. Measure the average power of the transmitter, and the average power is corrected with duty factor, $10 \log(1/x)$, where x is the duty cycle.

3.2.4 Test Setup

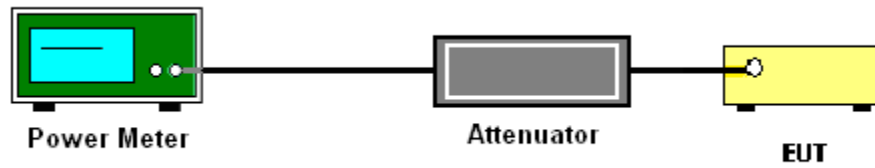

3.2.5 Test Result of Maximum Conducted Output Power

Please refer to Appendix A.



3.3 Power Spectral Density Measurement

3.3.1 Limit of Power Spectral Density

<FCC 14-30 CFR 15.407>

For mobile and portable client devices in the 5.15–5.25 GHz band, the maximum power spectral density shall not exceed 11dBm in any 1 megahertz band.

For the 5.25–5.725 GHz bands, the maximum power spectral density shall not exceed 11 dBm in any 1 megahertz band.

If transmitting antennas of directional gain greater than 6 dBi are used, the peak output power shall be reduced by the amount in dB that the directional gain of the antenna exceeds 6 dBi.

For Straddle Channel, According to KDB 789033 D02 General UNII Test Procedures New Rules v01r04, If the power and PSD of the devices are uniform and comply with the lower limits specified for the U-NII-2 bands, a single measurement over the entire emission bandwidth can be performed to show compliance.

3.3.2 Measuring Instruments

The measuring equipment is listed in the section 4 of this test report.

3.3.3 Test Procedures

The testing follows FCC KDB 789033 D02 General UNII Test Procedures New Rules v01r04.
Section F) Maximum power spectral density.

Method SA-2

(trace averaging across on and off times of the EUT transmissions, followed by duty cycle correction).

1. The testing follows Method SA-2 of FCC KDB 789033 D02 General UNII Test Procedures New Rules v01r04.
 - Measure the duty cycle.
 - Set span to encompass the entire emission bandwidth (EBW) of the signal.
 - Set RBW = 1 MHz.
 - Set VBW \geq 3 MHz.
 - Number of points in sweep \geq 2 Span / RBW.
 - Sweep time = auto.
 - Detector = RMS
 - Trace average at least 100 traces in power averaging mode.
 - Add $10 \log(1/x)$, where x is the duty cycle, to the measured power in order to compute the average power during the actual transmission times. For example, add $10 \log(1/0.25) = 6$ dB if the duty cycle is 25 percent.
2. The RF output of EUT was connected to the spectrum analyzer by a low loss cable.
3. Each plot has already offset with cable loss, and attenuator loss. Measure the PPSD and record it.

3.3.4 Test Setup

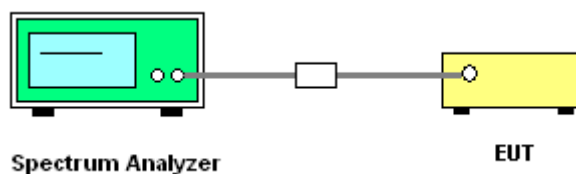



3.3.5 Test Result of Power Spectral Density

Please refer to Appendix A.

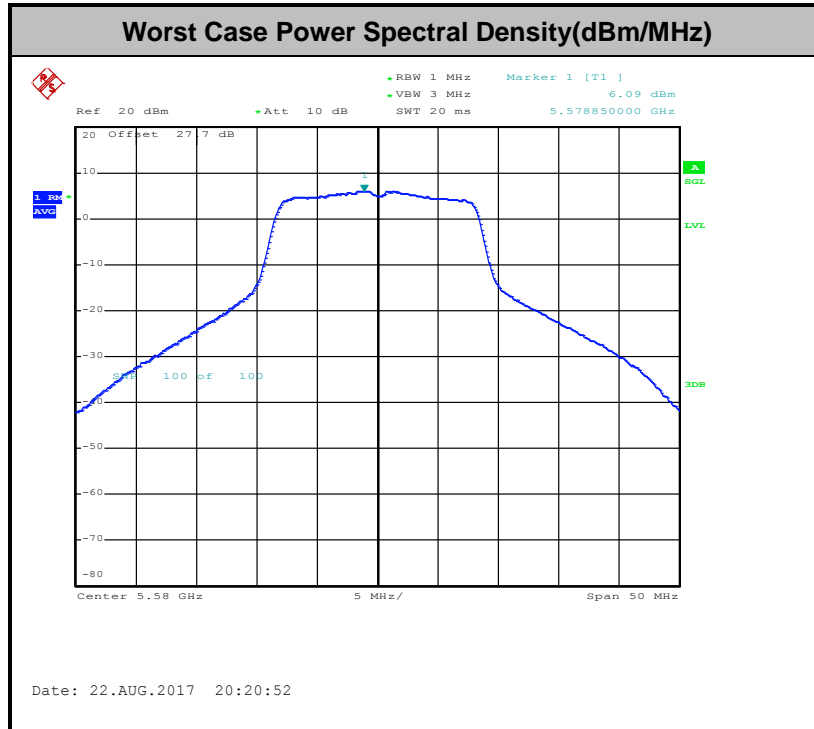

Note: Average Power Density (dB) = Measured value+ Duty Factor



3.4 Unwanted Radiated Emission Measurement

This section is to measure unwanted emissions through radiated measurement for band edge spurious emissions and out of band emissions measurement.

3.4.1 Limit of Unwanted Emissions

- (1) For transmitters operating in the 5150-5250 MHz band: all emissions outside of the 5150-5350 MHz band shall not exceed an EIRP of -27dBm/MHz.

For transmitters operating in the 5250-5350 MHz band: all emissions outside of the 5150-5350 MHz band shall not exceed an EIRP of -27 dBm/MHz. Devices operating in the 5250-5350 MHz band that generate emissions in the 5150-5250 MHz band must meet all applicable technical requirements for operation in the 5150-5250 MHz band (including indoor use) or alternatively meet an out-of-band emission EIRP limit of -27 dBm/MHz in the 5150-5250 MHz band.

For transmitters operating in the 5470-5725MHz band: all emissions outside of the 5470-5725MHz band shall not exceed an EIRP of -27 dBm/MHz.

- (2) Unwanted spurious emissions fallen in restricted bands shall comply with the general field strength limits as below table,

Frequency (MHz)	Field Strength (microvolts/meter)	Measurement Distance (meters)
0.009 – 0.490	2400/F(kHz)	300
0.490 – 1.705	24000/F(kHz)	30
1.705 – 30.0	30	30
30 – 88	100	3
88 – 216	150	3
216 - 960	200	3
Above 960	500	3

Note: The following formula is used to convert the EIRP to field strength.

$$E = \frac{1000000\sqrt{30P}}{3} \mu\text{V/m, where P is the eirp (Watts)}$$



EIRP (dBm)	Field Strength at 3m (dBµV/m)
-17	78.3
- 27	68.3

(3) KDB789033 D02 v01r04 G)2)c)

- (i) Sections 15.407(b)(1) to (b)(3) specify the unwanted emission limits for the U-NII-1 and U-NII-2 bands. As specified, emissions above 1000 MHz that are outside of the restricted bands are subject to a peak emission limit of -27 dBm/MHz.³
- (ii) Section 15.407(b)(4) specifies the unwanted emission limit for the U-NII-3 band. A band emissions mask is specified in Section 15.407(b)(4)(i). The emission limits are in terms of a Peak detector. An alternative to the band emissions mask is specified in Section 15.407(b)(4)(ii). The alternative limits are based on the highest antenna gain specified in the filing. There are also marketing and importation restrictions for the devices using the alternative limit.⁴

Note 3: An out-of-band emission that complies with both the average and peak limits of Section 15.209 is not required to satisfy the -27 dBm/MHz peak emission limit.

Note 4: Only devices with antenna gains of 10 dBi or less may be approved using the emission limits specified in Section 15.247(d) till March 2, 2018; all other devices operating in this band must use the mask specified in Section 15.407(b)(4)(i).

3.4.2 Measuring Instruments

The measuring equipment is listed in the section 4 of this test report.



3.4.3 Test Procedures

1. The testing follows FCC KDB 789033 D02 General UNII Test Procedures New Rules v01r04. Section G) Unwanted emissions measurement.

(1) Procedure for Unwanted Emissions Measurements Below 1000MHz

- RBW = 120 kHz
- VBW = 300 kHz
- Detector = Peak
- Trace mode = max hold

(2) Procedure for Peak Unwanted Emissions Measurements Above 1000 MHz

- RBW = 1 MHz
- VBW \geq 3 MHz
- Detector = Peak
- Sweep time = auto
- Trace mode = max hold

(3) Procedures for Average Unwanted Emissions Measurements Above 1000MHz

- RBW = 1 MHz
- VBW = 10 Hz, when duty cycle is no less than 98 percent.
- VBW \geq 1/T, when duty cycle is less than 98 percent where T is the minimum transmission duration over which the transmitter is on and is transmitting at its maximum power control level for the tested mode of operation.

2. The EUT was placed on a turntable with 0.8 meter for frequency below 1GHz and 1.5 meter for frequency above 1GHz respectively above ground.
3. The EUT was set 3 meters from the interference receiving antenna which was mounted on the top of a variable height antenna tower.
4. The antenna is a broadband antenna and its height is adjusted between one meter and four meters above ground to find the maximum value of the field strength for both horizontal polarization and vertical polarization of the antenna.
5. For each suspected emission, the EUT was arranged to its worst case and then adjust the antenna tower (from 1 m to 4 m) and turntable (from 0 degree to 360 degrees) to find the maximum reading.
6. For testing below 1GHz, if the emission level of the EUT in peak mode was 3 dB lower than the limit specified, then peak values of EUT will be reported, otherwise, the emissions will be repeated one by one using the CISPR quasi-peak method and reported.
7. For testing above 1GHz, the emission level of the EUT in peak mode was 20dB lower than average limit (that means the emission level in average mode also complies with the limit in average mode), then peak values of EUT will be reported, otherwise, the emissions will be measured in average mode again and reported.

3.4.4 Test Setup

For radiated emissions below 30MHz

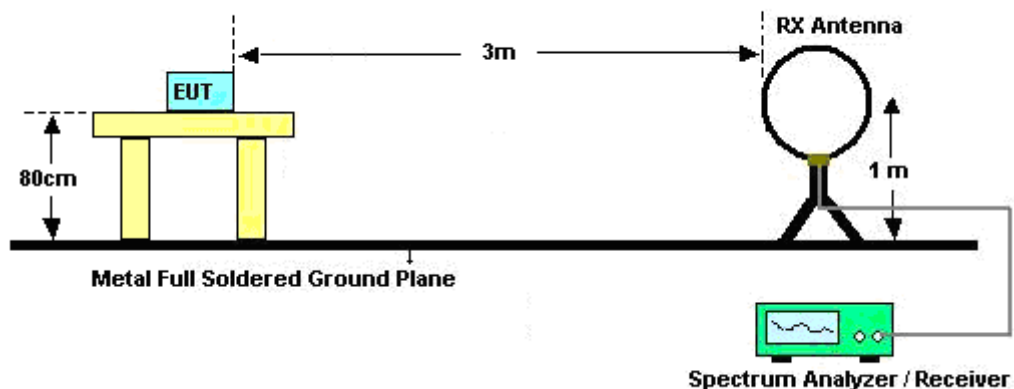

For radiated emissions from 30MHz to 1GHz

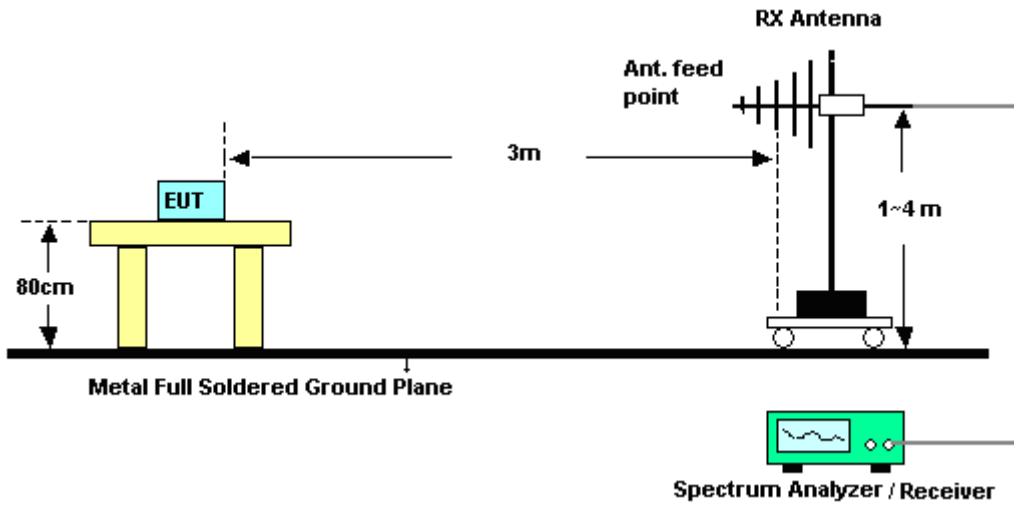

For radiated emissions above 1GHz

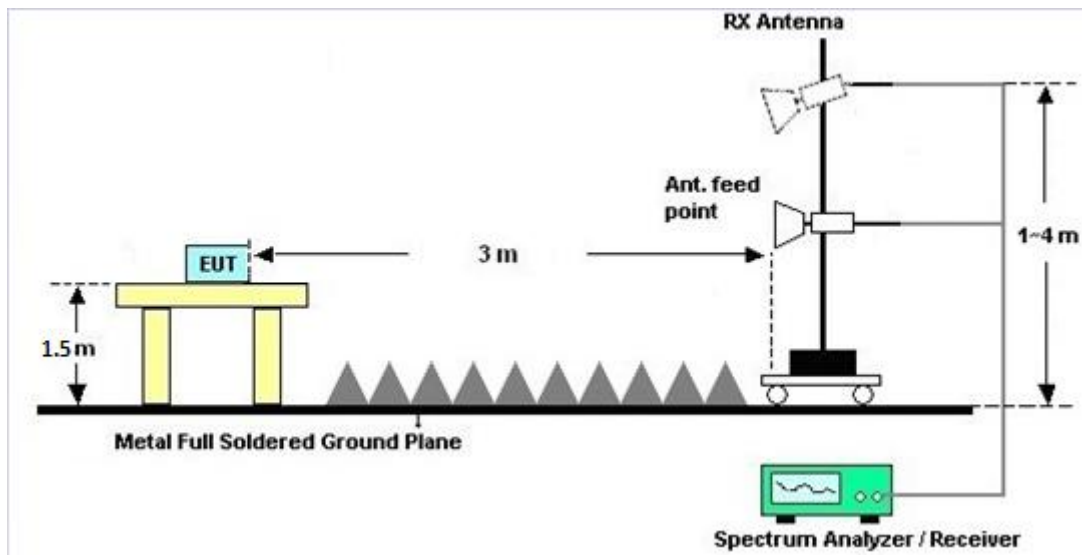



3.4.5 Test Results of Radiated Spurious Emissions (9 kHz ~ 30 MHz)

The low frequency, which started from 9 kHz to 30MHz, was pre-scanned and the result which was 20dB lower than the limit line was not reported.

There is a comparison data of both open-field test site and semi-Anechoic chamber, and the result came out very similar.

3.4.6 Test Result of Radiated Spurious at Band Edges

Please refer to Appendix C and D.

3.4.7 Duty Cycle

Please refer to Appendix E.

3.4.8 Test Result of Radiated Spurious Emissions (30MHz ~ 10th Harmonic)

Please refer to Appendix C and D.



3.5 AC Conducted Emission Measurement

3.5.1 Limit of AC Conducted Emission

For equipment that is designed to be connected to the public utility (AC) power line, the radio frequency voltage that is conducted back onto the AC power line on any frequency or frequencies within the band 150 kHz to 30 MHz shall not exceed the limits in the following table.

Frequency of emission (MHz)	Conducted limit (dB μ V)	
	Quasi-peak	Average
0.15-0.5	66 to 56*	56 to 46*
0.5-5	56	46
5-30	60	50

*Decreases with the logarithm of the frequency.

3.5.2 Measuring Instruments

The measuring equipment is listed in the section 4 of this test report.

3.5.3 Test Procedures

1. The EUT was placed 0.4 meter from the conducting wall of the shielding room was kept at least 80 centimeters from any other grounded conducting surface.
2. Connect EUT to the power mains through a line impedance stabilization network (LISN).
3. All the support units are connecting to the other LISN.
4. The LISN provides 50 ohm coupling impedance for the measuring instrument.
5. The FCC states that a 50 ohm, 50 microhenry LISN should be used.
6. Both sides of AC line were checked for maximum conducted interference.
7. The frequency range from 150 kHz to 30 MHz was searched.
8. Set the test-receiver system to Peak Detect Function and specified bandwidth with Maximum Hold Mode.

3.5.4 Test Setup

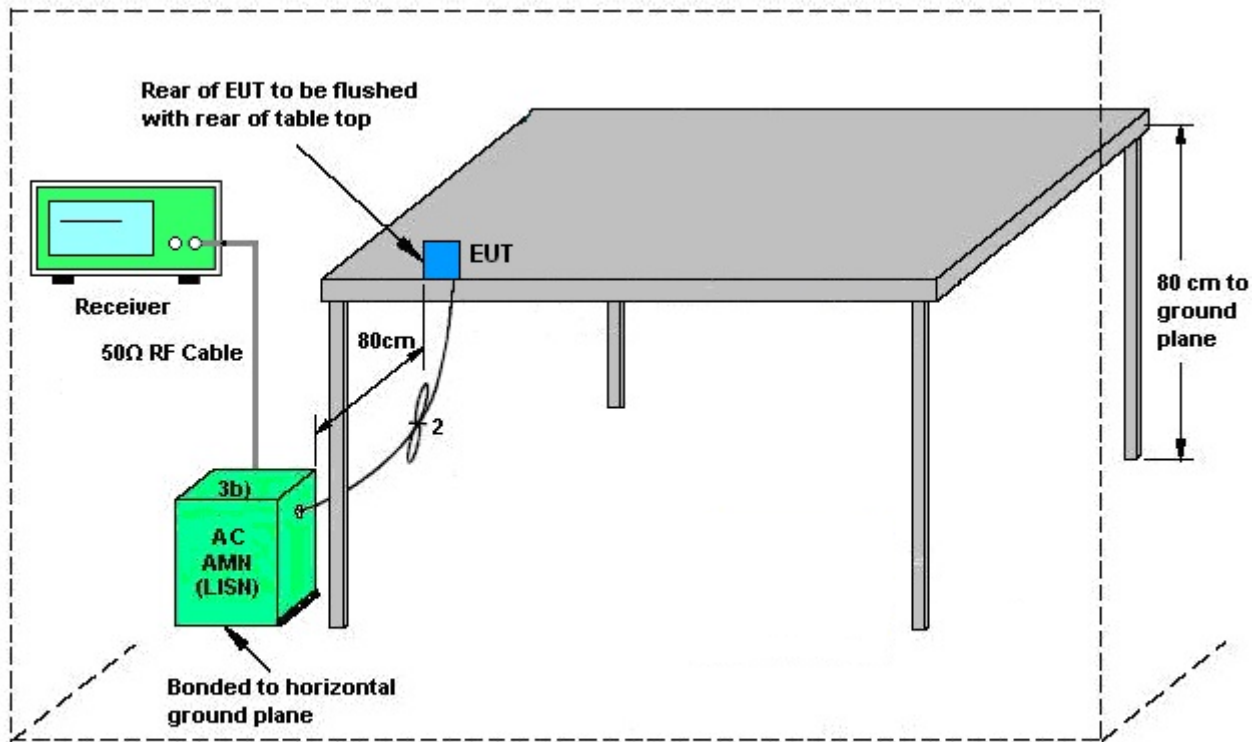

AMN = Artificial mains network (LISH)
 AE = Associated equipment
 EUT = Equipment under test
 ISN = Impedance stabilization network

3.5.5 Test Result of AC Conducted Emission

Please refer to Appendix B.

3.6 Frequency Stability Measurement

3.6.1 Limit of Frequency Stability

Manufacturers of U-NII devices are responsible for ensuring frequency stability such that an emission is maintained within the band of operation under all conditions of normal operation as specified in the user's manual.

3.6.2 Measuring Instruments

The measuring equipment is listed in the section 4 of this test report.

3.6.3 Test Procedures

1. To ensure emission at the band edge is maintained within the authorized band, those values shall be measured by radiation emissions at upper and lower frequency points, and finally compensated by frequency deviation as procedures below.
2. The EUT was operated at the maximum output power, and connected to the spectrum analyzer, which is set to maximum hold function and peak detector. The peak value of the power envelope was measured and noted. The upper and lower frequency points were respectively measured relatively 10dB lower than the measured peak value.
3. The frequency deviation was calculated by adding the upper frequency point and the lower frequency point divided by two. Those detailed values of frequency deviation are provided in table below.

3.6.4 Test Setup

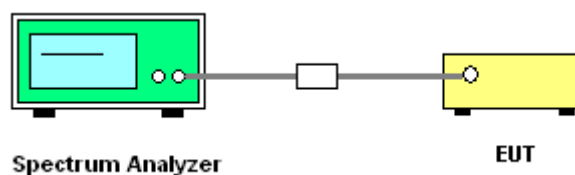

3.6.5 Test Result of Frequency Stability

Please refer to Appendix A.



3.7 Automatically Discontinue Transmission

3.7.1 Limit of Automatically Discontinue Transmission

The device shall automatically discontinue transmission in case of either absence of information to transmit or operational failure. These provisions are not intended to preclude the transmission of control or signaling information or the use of repetitive codes used by certain digital technologies to complete frame or burst intervals. Applicants shall include in their application for equipment authorization to describe how this requirement is met.

3.7.2 Measuring Instruments

The measuring equipment is listed in the section 4 of this test report.

3.7.3 Test Result of Automatically Discontinue Transmission

While the EUT is not transmitting any information, the EUT can automatically discontinue transmission and become standby mode for power saving. The EUT can detect the controlling signal of ACK message transmitting from remote device and verify whether it shall resend or discontinue transmission.



3.8 Antenna Requirements

3.8.1 Standard Applicable

If transmitting antenna directional gain is greater than 6 dBi, both the peak transmit power and the peak power spectral density shall be reduced by the amount in dB that the directional gain of the antenna exceeds 6 dBi.

3.8.2 Antenna Anti-Replacement Construction

An embedded-in antenna design is used.

3.8.3 Antenna Gain

The antenna gain is less than 6 dBi. Therefore, it is not necessary to reduce maximum peak output power limit.



4 List of Measuring Equipments

Instrument	Manufacturer	Model No.	Serial No.	Characteristics	Calibration Date	Test Date	Due Date	Remark
Power Meter	Anritsu	ML2495A	0932001	N/A	Sep. 29, 2016	Aug. 10, 2017~ Aug. 25, 2017	Sep. 28, 2017	Conducted (TH05-HY)
Power Sensor	Anritsu	MA2411B	0846202	300MHz~40GHz	Sep. 29, 2016	Aug. 10, 2017~ Aug. 25, 2017	Sep. 28, 2017	Conducted (TH05-HY)
Spectrum Analyzer	Rohde & Schwarz	FSP30	101067	9kHz ~ 30GHz	Nov. 17, 2016	Aug. 10, 2017~ Aug. 25, 2017	Nov. 16, 2017	Conducted (TH05-HY)
Hygrometer	Testo	608-H2	41410069	N/A	Aug. 28, 2016	Aug. 10, 2017~ Aug. 25, 2017	Aug. 27, 2017	Conducted (TH05-HY)
RF Cable	HUBER + SUHNER	SUCOFLEX 104	MY84209521	1GHz~26GHz	Dec. 02, 2016	Aug. 10, 2017~ Aug. 25, 2017	Dec. 01, 2017	Conducted (TH05-HY)
Temperature Chamber	ESPEC	SH-641	92013720	-40°C ~90°C	Sep. 01, 2016	Aug. 10, 2017~ Aug. 25, 2017	Aug. 31, 2017	Conducted (TH05-HY)
AC Power Source	ChainTek	APC-1000W	N/A	N/A	N/A	Oct. 02, 2017 ~ Oct. 03, 2017	N/A	Conduction (CO05-HY)
EMI Test Receiver	Rohde & Schwarz	ESCI 7	100724	9kHz~7GHz	Sep. 20, 2017	Oct. 02, 2017 ~ Oct. 03, 2017	Sep. 19, 2018	Conduction (CO05-HY)
Hygrometer	Testo	608-H1	34913912	N/A	May 02, 2017	Oct. 02, 2017 ~ Oct. 03, 2017	May 01, 2018	Conduction (CO05-HY)
LISN	Rohde & Schwarz	ENV216	100080	9kHz~30MHz	Nov. 29, 2016	Oct. 02, 2017 ~ Oct. 03, 2017	Nov. 28, 2017	Conduction (CO05-HY)
LF Cable	HUBER + SUHNER	RG-214/U	LF01	N/A	Jan. 05, 2017	Oct. 02, 2017 ~ Oct. 03, 2017	Jan. 04, 2018	Conduction (CO05-HY)
Test Software	N/A	EMC32	8.40.0	N/A	N/A	Oct. 02, 2017 ~ Oct. 03, 2017	N/A	Conduction (CO05-HY)
Loop Antenna	Rohde & Schwarz	HFH2-Z2	100488	9 kHz~30 MHz	Oct. 20, 2016	Sep. 19, 2017 ~ Sep. 29, 2017	Oct. 19, 2018	Radiation (03CH12-HY)
Bilog Antenna	TESEQ	CBL 6111D&00800 N1D01N-06	37059&01	30MHz~1GHz	Oct. 15, 2016	Sep. 19, 2017 ~ Sep. 29, 2017	Oct. 14, 2017	Radiation (03CH12-HY)
Horn Antenna	SCHWARZBECK	BBHA 9120D	9120D-1328	1GHz ~ 18GHz	Oct. 25, 2016	Sep. 19, 2017 ~ Sep. 29, 2017	Oct. 24, 2017	Radiation (03CH12-HY)
SHF-EHF Horn Antenna	SCHWARZBECK	BBHA 9170	BBHA9170576	18GHz ~ 40GHz	Apr. 27, 2017	Sep. 19, 2017 ~ Sep. 29, 2017	Apr. 26, 2018	Radiation (03CH12-HY)
Spectrum Analyzer	Keysight	N9010A	MY54200486	10Hz ~ 44GHz	Oct. 12, 2016	Sep. 19, 2017 ~ Sep. 29, 2017	Oct. 11, 2017	Radiation (03CH12-HY)
EMI Test Receiver	Rohde & Schwarz	ESU26	100390	20Hz~26.5GHz	Dec. 23, 2016	Sep. 19, 2017 ~ Sep. 29, 2017	Dec. 22, 2017	Radiation (03CH12-HY)
Amplifier	MITEQ	TTA1840-35-HG	1871923	18GHz~40GHz, VSWR : 2.5:1 max	Jul. 18, 2017	Sep. 19, 2017 ~ Sep. 29, 2017	Jul. 17, 2018	Radiation (03CH12-HY)
Preamplifier	COM-POWER	PA-103	161075	10MHz~1GHz	Mar. 23, 2017	Sep. 19, 2017 ~ Sep. 29, 2017	Mar. 22, 2018	Radiation (03CH12-HY)
Preamplifier	MITEQ	AMF-7D-0010 1800-30-10P	1815698	1GHz~18GHz	Dec. 01, 2016	Sep. 19, 2017 ~ Sep. 29, 2017	Nov. 30, 2017	Radiation (03CH12-HY)
Preamplifier	Keysight	83017A	MY53270148	1GHz~26.5GHz	Jan. 12, 2017	Sep. 19, 2017 ~ Sep. 29, 2017	Jan. 11, 2018	Radiation (03CH12-HY)



Instrument	Manufacturer	Model No.	Serial No.	Characteristics	Calibration Date	Test Date	Due Date	Remark
Hygrometer	TECPEL	DTM-303B	TP140349	N/A	Nov. 14, 2016	Sep. 19, 2017 ~ Sep. 29, 2017	Nov. 13, 2017	Radiation (03CH12-HY)
RF Cable	HUBER + SUHNER	SUCOFLEX 104	MY24958/4, MY28653/4, MY9839/4PE	26GHz~40GHz	Jan. 10, 2017	Sep. 19, 2017 ~ Sep. 29, 2017	Jan. 09, 2018	Radiation (03CH12-HY)
RF Cable	HUBER + SUHNER	SUCOFLEX 104	MY24958/4, MY28653/4, MY9839/4PE	1GHz~26GHz	Jan. 10, 2017	Sep. 19, 2017 ~ Sep. 29, 2017	Jan. 09, 2018	Radiation (03CH12-HY)
RF Cable	HUBER + SUHNER	SUCOFLEX 104	MY24958/4, MY28653/4, MY9839/4PE	30MHz~1GHz	Jan. 10, 2017	Sep. 19, 2017 ~ Sep. 29, 2017	Jan. 09, 2018	Radiation (03CH12-HY)
Controller	EMEC	EM1000	N/A	Control Turn table & Ant Mast	N/A	Sep. 19, 2017 ~ Sep. 29, 2017	N/A	Radiation (03CH12-HY)
Antenna Mast	EMEC	AM-BS-4500-B	N/A	1m~4m	N/A	Sep. 19, 2017 ~ Sep. 29, 2017	N/A	Radiation (03CH12-HY)
Turn Table	EMEC	TT2000	N/A	0~360 Degree	N/A	Sep. 19, 2017 ~ Sep. 29, 2017	N/A	Radiation (03CH12-HY)
Test Software	Audix	E3	6.2009-8-24	N/A	N/A	Sep. 19, 2017 ~ Sep. 29, 2017	N/A	Radiation (03CH12-HY)
Filter	Wainwright	WLKS1200-12 SS	SN2	1.2G Low Pass	Mar. 24, 2017	Sep. 19, 2017 ~ Sep. 29, 2017	Mar. 23, 2018	Radiation (03CH12-HY)
Filter	Wainwright	WHKX12-2700 -3000-18000-6 0SS	SN2	3G High Pass	Sep. 18, 2017	Sep. 19, 2017 ~ Sep. 29, 2017	Sep. 17, 2018	Radiation (03CH12-HY)
Filter	Woken	WHKX8-5272. 5-6750-18000- 40ST	SN2	6.75G Highpass	Mar. 22, 2017	Sep. 19, 2017 ~ Sep. 29, 2017	Mar. 21, 2018	Radiation (03CH12-HY)



5 Uncertainty of Evaluation

Uncertainty of Conducted Emission Measurement (150kHz ~ 30MHz)

Measuring Uncertainty for a Level of Confidence of 95% ($U = 2Uc(y)$)	2.70
---	------

Uncertainty of Radiated Emission Measurement (30 MHz ~ 1000 MHz)

Measuring Uncertainty for a Level of Confidence of 95% ($U = 2Uc(y)$)	5.10
---	------

Uncertainty of Radiated Emission Measurement (1000 MHz ~ 18000 MHz)

Measuring Uncertainty for a Level of Confidence of 95% ($U = 2Uc(y)$)	5.20
---	------

Uncertainty of Radiated Emission Measurement (18000 MHz ~ 40000 MHz)

Measuring Uncertainty for a Level of Confidence of 95% ($U = 2Uc(y)$)	4.70
---	------

Appendix A. Test Result of Conducted Test Items

Test Engineer:	Shiming Liu/Derek Hsu	Temperature:	21~25	°C
Test Date:	2017/8/10~2017/8/25	Relative Humidity:	51~54	%

TEST RESULTS DATA
26dB and 99% OBW

Band I										
Mod.	Data Rate	NTX	CH.	Freq. (MHz)	99% Bandwidth (MHz)	26 dB Bandwidth (MHz)	IC 99% Bandwidth Power Limit (dBm)	IC 99% Bandwidth EIRP Limit (dBm)		
11a	6Mbps	1	36	5180	18.30	32.14	-	22.62		
11a	6Mbps	1	44	5220	17.70	27.96	-	22.48		
11a	6Mbps	1	48	5240	18.10	30.12	-	22.58		
VHT20	MCS0	1	36	5180	18.55	26.43	-	22.68		
VHT20	MCS0	1	44	5220	18.60	26.48	-	22.70		
VHT20	MCS0	1	48	5240	18.55	25.20	-	22.68		
VHT40	MCS0	1	38	5190	36.50	41.61	-	23.01		
VHT40	MCS0	1	46	5230	36.60	41.28	-	23.01		
VHT80	MCS0	1	42	5210	75.96	83.44	-	23.01		

TEST RESULTS DATA
Average Power Table

FCC Band I										
Mod.	Data Rate	NTX	CH.	Freq. (MHz)	Duty Factor (dB)	Average Conducted Power (dBm)	FCC Conducted Power Limit (dBm)	DG (dBi)		Pass/Fail
11a	6Mbps	1	36	5180	0.29	16.99	24.00	-4.90		Pass
11a	6Mbps	1	44	5220	0.29	16.74	24.00	-4.90		Pass
11a	6Mbps	1	48	5240	0.29	16.55	24.00	-4.90		Pass
HT20	MCS0	1	36	5180	0.29	13.90	24.00	-4.90		Pass
HT20	MCS0	1	44	5220	0.29	13.69	24.00	-4.90		Pass
HT20	MCS0	1	48	5240	0.29	13.61	24.00	-4.90		Pass
HT40	MCS0	1	38	5190	0.56	12.96	24.00	-4.90		Pass
HT40	MCS0	1	46	5230	0.56	12.91	24.00	-4.90		Pass
VHT20	MCS0	1	36	5180	0.31	13.92	24.00	-4.90		Pass
VHT20	MCS0	1	44	5220	0.31	13.99	24.00	-4.90		Pass
VHT20	MCS0	1	48	5240	0.31	13.98	24.00	-4.90		Pass
VHT40	MCS0	1	38	5190	0.56	12.97	24.00	-4.90		Pass
VHT40	MCS0	1	46	5230	0.56	12.92	24.00	-4.90		Pass
VHT80	MCS0	1	42	5210	0.57	11.77	24.00	-4.90		Pass

TEST RESULTS DATA
Power Spectral Density

FCC Band I										
Mod.	Data Rate	NTX	CH.	Freq. (MHz)	Duty Factor (dB)	Average Power Density (dBm/MHz)	Average PSD Limit (dBm/MHz)	DG (dBi)	-	Pass/Fail
11a	6Mbps	1	36	5180	0.29	6.05	11.00	-4.90		Pass
11a	6Mbps	1	44	5220	0.29	5.64	11.00	-4.90		Pass
11a	6Mbps	1	48	5240	0.29	5.59	11.00	-4.90		Pass
VHT20	MCS0	1	36	5180	0.31	1.79	11.00	-4.90		Pass
VHT20	MCS0	1	44	5220	0.31	2.06	11.00	-4.90		Pass
VHT20	MCS0	1	48	5240	0.31	1.73	11.00	-4.90		Pass
VHT40	MCS0	1	38	5190	0.56	-1.31	11.00	-4.90		Pass
VHT40	MCS0	1	46	5230	0.56	-1.28	11.00	-4.90		Pass
VHT80	MCS0	1	42	5210	0.57	-5.66	11.00	-4.90		Pass

TEST RESULTS DATA
26dB and 99% OBW

Band II										
Mod.	Data Rate	NTX	CH.	Freq. (MHz)	99% Bandwidth (MHz)	26 dB Bandwidth (MHz)	IC 99% Bandwidth Power Limit (dBm)	IC 99% Bandwidth EIRP Limit (dBm)	FCC 26dB Bandwidth Power Limit (dBm)	Note
11a	6M bps	1	52	5260	17.95	28.85	23.54	29.54	23.98	
11a	6M bps	1	60	5300	17.70	27.12	23.48	29.48	23.98	
11a	6M bps	1	64	5320	17.90	30.24	23.53	29.53	23.98	
VHT20	MCS 0	1	52	5260	18.75	26.52	23.73	29.73	23.98	
VHT20	MCS 0	1	60	5300	18.60	27.15	23.70	29.70	23.98	
VHT20	MCS 0	1	64	5320	18.55	25.55	23.68	29.68	23.98	
VHT40	MCS 0	1	54	5270	36.70	41.49	23.98	30.00	23.98	
VHT40	MCS 0	1	62	5310	36.60	41.52	23.98	30.00	23.98	
VHT80	MCS 0	1	58	5290	75.84	83.92	23.98	30.00	23.98	

TEST RESULTS DATA
Average Power Table

FCC Band II										
Mod.	Data Rate	NTX	CH.	Freq. (MHz)	Duty Factor (dB)	Average Conducted Power (dBm)	FCC Conducted Power Limit (dBm)	DG (dBi)	EIRP Power Limit (dBm)	Pass/Fail
11a	6M bps	1	52	5260	0.29	16.51	23.98	-5.00	26.99	Pass
11a	6M bps	1	60	5300	0.29	16.74	23.98	-5.00	26.99	Pass
11a	6M bps	1	64	5320	0.29	16.94	23.98	-5.00	26.99	Pass
HT20	MCS 0	1	52	5260	0.29	13.65	23.98	-5.00	26.99	Pass
HT20	MCS 0	1	60	5300	0.29	13.74	23.98	-5.00	26.99	Pass
HT20	MCS 0	1	64	5320	0.29	13.64	23.98	-5.00	26.99	Pass
HT40	MCS 0	1	54	5270	0.56	12.87	23.98	-5.00	26.99	Pass
HT40	MCS 0	1	62	5310	0.56	12.66	23.98	-5.00	26.99	Pass
VHT20	MCS 0	1	52	5260	0.31	13.97	23.98	-5.00	26.99	Pass
VHT20	MCS 0	1	60	5300	0.31	13.76	23.98	-5.00	26.99	Pass
VHT20	MCS 0	1	64	5320	0.31	13.66	23.98	-5.00	26.99	Pass
VHT40	MCS 0	1	54	5270	0.56	12.94	23.98	-5.00	26.99	Pass
VHT40	MCS 0	1	62	5310	0.56	12.96	23.98	-5.00	26.99	Pass
VHT80	MCS 0	1	58	5290	0.57	11.74	23.98	-5.00	26.99	Pass

TEST RESULTS DATA
Power Spectral Density

Band II										
Mod.	Data Rate	NTX	CH.	Freq. (MHz)	Duty Factor (dB)	Average Power Density (dBm/MHz)	Average PSD Limit (dBm/MHz)	DG (dBi)		Pass/Fail
11a	6M bps	1	52	5260	0.29	5.78	11.00	-5.00		Pass
11a	6M bps	1	60	5300	0.29	6.05	11.00	-5.00		Pass
11a	6M bps	1	64	5320	0.29	6.22	11.00	-5.00		Pass
VHT20	MCS 0	1	52	5260	0.31	1.72	11.00	-5.00		Pass
VHT20	MCS 0	1	60	5300	0.31	1.18	11.00	-5.00		Pass
VHT20	MCS 0	1	64	5320	0.31	1.28	11.00	-5.00		Pass
VHT40	MCS 0	1	54	5270	0.56	-1.67	11.00	-5.00		Pass
VHT40	MCS 0	1	62	5310	0.56	-1.57	11.00	-5.00		Pass
VHT80	MCS 0	1	58	5290	0.57	-5.68	11.00	-5.00		Pass

TEST RESULTS DATA
26dB and 99% OBW

Band III										
Mod.	Data Rate	NTX	CH.	Freq. (MHz)	99% Bandwidth (MHz)	26 dB Bandwidth (MHz)	IC 99% Bandwidth Power Limit (dBm)	IC 99% Bandwidth EIRP Limit (dBm)	FCC 26dB Bandwidth Power Limit (dBm)	Note
11a	6M bps	1	100	5500	17.70	28.26	23.48	29.48	23.98	
11a	6M bps	1	116	5580	17.85	29.13	23.52	29.52	23.98	
11a	6M bps	1	140	5700	17.70	27.92	23.48	29.48	23.98	
11a	6Mbps	1	144	5720	17.65	26.88	23.47	29.47	23.98	
VHT20	MCS 0	1	100	5500	18.70	25.44	23.72	29.72	23.98	
VHT20	MCS 0	1	116	5580	18.70	26.28	23.72	29.72	23.98	
VHT20	MCS 0	1	140	5700	18.60	26.05	23.70	29.70	23.98	
VHT20	MCS0	1	144	5720	18.70	25.97	23.72	29.72	23.98	
VHT40	MCS 0	1	102	5510	36.60	42.24	23.98	30.00	23.98	
VHT40	MCS 0	1	110	5550	36.60	42.39	23.98	30.00	23.98	
VHT40	MCS 0	1	134	5670	36.70	41.88	23.98	30.00	23.98	
VHT40	MCS0	1	142	5710	36.60	41.04	23.98	30.00	23.98	
VHT80	MCS 0	1	106	5530	75.96	82.72	23.98	30.00	23.98	
VHT80	MCS 0	1	122	5610	75.72	83.12	23.98	30.00	23.98	
VHT80	MCS0	1	138	5690	75.84	84.00	23.98	30.00	23.98	

TEST RESULTS DATA
Average Power Table

FCC Band III										
Mod.	Data Rate	NTX	CH.	Freq. (MHz)	Duty Factor (dB)	Average Conducted Power (dBm)	FCC Conducted Power Limit (dBm)	DG (dBi)	EIRP Power Limit (dBm)	Pass/Fail
11a	6M bps	1	100	5500	0.29	16.84	23.98	-2.60	26.99	Pass
11a	6M bps	1	116	5580	0.29	16.55	23.98	-2.60	26.99	Pass
11a	6M bps	1	140	5700	0.29	16.54	23.98	-2.60	26.99	Pass
11a	6M bps	1	144	5720	0.29	16.60	23.98	-2.60	26.99	Pass
HT20	MCS 0	1	100	5500	0.29	13.68	23.98	-2.60	26.99	Pass
HT20	MCS 0	1	116	5580	0.29	13.58	23.98	-2.60	26.99	Pass
HT20	MCS 0	1	140	5700	0.29	13.62	23.98	-2.60	26.99	Pass
HT20	MCS 0	1	144	5720	0.29	13.51	23.98	-2.60	26.99	Pass
HT40	MCS 0	1	102	5510	0.56	12.64	23.98	-2.60	26.99	Pass
HT40	MCS 0	1	110	5550	0.56	12.61	23.98	-2.60	26.99	Pass
HT40	MCS 0	1	134	5670	0.56	12.61	23.98	-2.60	26.99	Pass
HT40	MCS 0	1	142	5710	0.56	12.66	23.98	-2.60	26.99	Pass
VHT20	MCS 0	1	100	5500	0.31	13.70	23.98	-2.60	26.99	Pass
VHT20	MCS 0	1	116	5580	0.31	13.87	23.98	-2.60	26.99	Pass
VHT20	MCS 0	1	140	5700	0.31	13.54	23.98	-2.60	26.99	Pass
VHT20	MCS 0	1	144	5720	0.31	13.99	23.98	-2.60	26.99	Pass
VHT40	MCS 0	1	102	5510	0.56	12.69	23.98	-2.60	26.99	Pass
VHT40	MCS 0	1	110	5550	0.56	12.64	23.98	-2.60	26.99	Pass
VHT40	MCS 0	1	134	5670	0.56	12.66	23.98	-2.60	26.99	Pass
VHT40	MCS 0	1	142	5710	0.56	12.68	23.98	-2.60	26.99	Pass
VHT80	MCS 0	1	106	5530	0.57	11.79	23.98	-2.60	26.99	Pass
VHT80	MCS 0	1	122	5610	0.57	11.58	23.98	-2.60	26.99	Pass
VHT80	MCS 0	1	138	5690	0.57	11.56	23.98	-2.60	26.99	Pass

TEST RESULTS DATA
Power Spectral Density

Band III										
Mod.	Data Rate	NTX	CH.	Freq. (MHz)	Duty Factor (dB)	Average Power Density (dBm/MHz)	Average PSD Limit (dBm/MHz)	DG (dBi)		Pass/Fail
11a	6M bps	1	100	5500	0.29	5.89	11.00	-2.60		Pass
11a	6M bps	1	116	5580	0.29	6.38	11.00	-2.60		Pass
11a	6M bps	1	140	5700	0.29	6.22	11.00	-2.60		Pass
VHT20	MCS 0	1	100	5500	0.31	3.26	11.00	-2.60		Pass
VHT20	MCS 0	1	116	5580	0.31	3.98	11.00	-2.60		Pass
VHT20	MCS 0	1	140	5700	0.31	2.64	11.00	-2.60		Pass
VHT20	MCS0	1	144	5720	0.31	3.03	11.00	-2.60		Pass
VHT40	MCS 0	1	102	5510	0.56	-0.48	11.00	-2.60		Pass
VHT40	MCS 0	1	110	5550	0.56	-0.34	11.00	-2.60		Pass
VHT40	MCS 0	1	134	5670	0.56	-0.95	11.00	-2.60		Pass
VHT40	MCS0	1	142	5710	0.56	-1.28	11.00	-2.60		Pass
VHT80	MCS 0	1	106	5530	0.57	-4.30	11.00	-2.60		Pass
VHT80	MCS 0	1	122	5610	0.57	-4.69	11.00	-2.60		Pass
VHT80	MCS0	1	138	5690	0.57	-5.40	11.00	-2.60		Pass

TEST RESULTS DATA
Frequency Stability

Band I										
Mod.	Data Rate	NTX	CH.	Freq. (MHz)	Center Frequency (MHz)	Frequency Deviation (MHz)	Frequency Stability (ppm)	Temperature (°C)	Voltage (V)	Note
11a	6Mbps	1	36	5180	5179.950	-0.050	-9.65	55	3.85	
11a	6Mbps	1	36	5180	5180.075	0.075	14.48	-30	3.85	
11a	6Mbps	1	36	5180	5180.000	0.000	0.00	20	4.4	
11a	6Mbps	1	36	5180	5180.050	0.050	9.65	20	3.4	
11a	6Mbps	1	36	5180	5180.000	0.000	0.00	20	3.85	

Band II										
Mod.	Data Rate	NTX	CH.	Freq. (MHz)	Center Frequency (MHz)	Frequency Deviation (MHz)	Frequency Stability (ppm)	Temperature (°C)	Voltage (V)	Note
11a	6Mbps	1	64	5320	5319.975	-0.025	-4.70	55	3.85	
11a	6Mbps	1	64	5320	5320.050	0.050	9.40	-30	3.85	
11a	6Mbps	1	64	5320	5319.950	-0.050	-9.40	20	4.4	
11a	6Mbps	1	64	5320	5320.000	0.000	0.00	20	3.4	
11a	6Mbps	1	64	5320	5319.950	-0.050	-9.40	20	3.85	

Band III										
Mod.	Data Rate	NTX	CH.	Freq. (MHz)	Center Frequency (MHz)	Frequency Deviation (MHz)	Frequency Stability (ppm)	Temperature (°C)	Voltage (V)	Note
11a	6Mbps	1	100	5500	5500.000	0.000	0.00	55	3.85	
11a	6Mbps	1	100	5500	5500.075	0.075	13.64	-30	3.85	
11a	6Mbps	1	100	5500	5500.000	0.000	0.00	20	4.4	
11a	6Mbps	1	100	5500	5500.000	0.000	0.00	20	3.4	
11a	6Mbps	1	100	5500	5499.950	-0.050	-9.09	20	3.85	



Appendix B. AC Conducted Emission Test Results

Test Engineer :	Blue Lan	Temperature :	26~27°C
		Relative Humidity :	51~52%

EUT Information

Report NO : 760710-01
 Test Mode : Mode 1
 Test Voltage : 120Vac/60Hz
 Phase : Line

ENV216 Auto Test FCC Power Bar - L

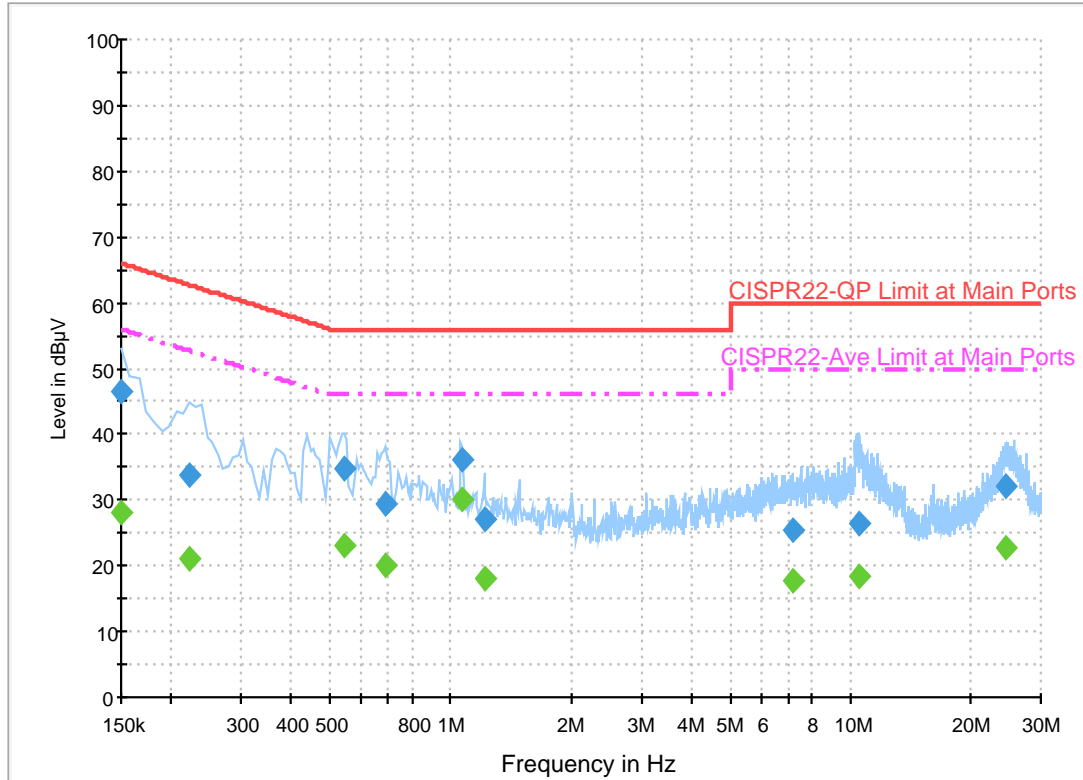

Final Result 1

Frequency (MHz)	QuasiPeak (dBµV)	Filter	Line	Corr. (dB)	Margin (dB)	Limit (dBµV)
0.150000	46.5	Off	L1	19.6	19.5	66.0
0.222000	33.7	Off	L1	19.6	29.0	62.7
0.542000	34.7	Off	L1	19.6	21.3	56.0
0.686000	29.5	Off	L1	19.6	26.5	56.0
1.070000	36.0	Off	L1	19.6	20.0	56.0
1.214000	26.9	Off	L1	19.6	29.1	56.0
7.206000	25.3	Off	L1	19.9	34.7	60.0
10.558000	26.5	Off	L1	20.1	33.5	60.0
24.494000	32.1	Off	L1	20.8	27.9	60.0

Final Result 2

Frequency (MHz)	Average (dBµV)	Filter	Line	Corr. (dB)	Margin (dB)	Limit (dBµV)
0.150000	28.0	Off	L1	19.6	28.0	56.0
0.222000	21.1	Off	L1	19.6	31.6	52.7
0.542000	23.0	Off	L1	19.6	23.0	46.0
0.686000	20.2	Off	L1	19.6	25.8	46.0
1.070000	30.0	Off	L1	19.6	16.0	46.0
1.214000	18.0	Off	L1	19.6	28.0	46.0
7.206000	17.7	Off	L1	19.9	32.3	50.0
10.558000	18.5	Off	L1	20.1	31.5	50.0
24.494000	22.8	Off	L1	20.8	27.2	50.0

EUT Information

Report NO : 760710-01
 Test Mode : Mode 1
 Test Voltage : 120Vac/60Hz
 Phase : Neutral

ENV216 Auto Test FCC Power Bar - N

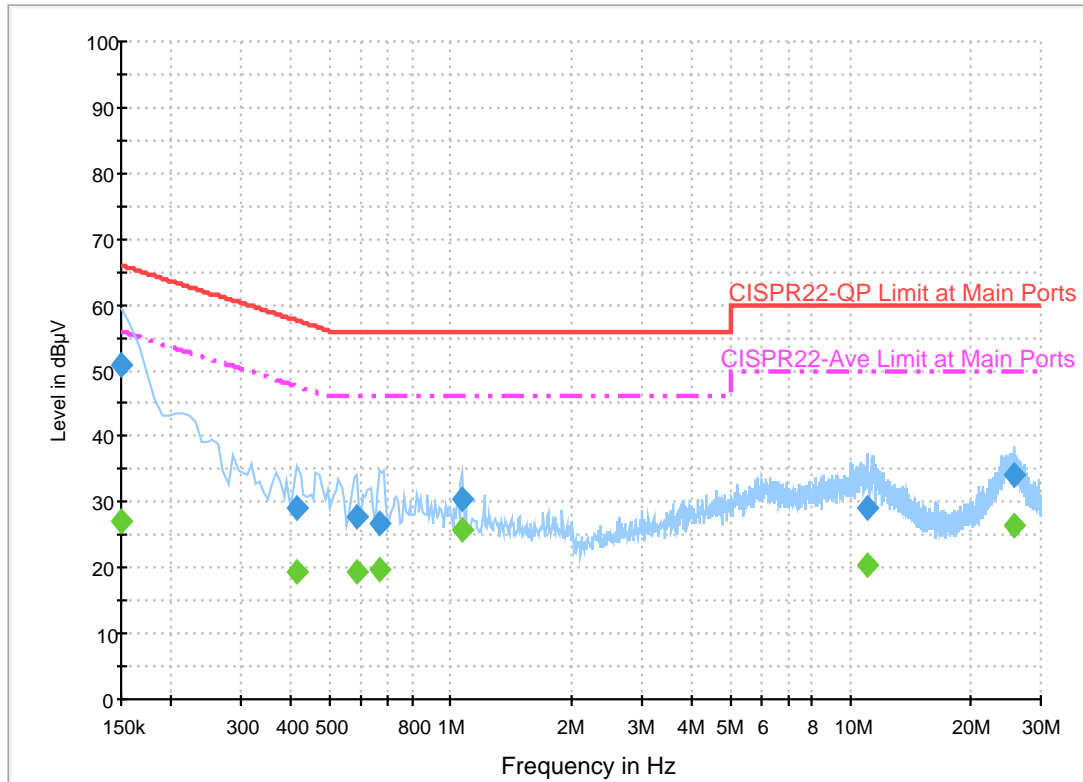

Final Result 1

Frequency (MHz)	QuasiPeak (dBµV)	Filter	Line	Corr. (dB)	Margin (dB)	Limit (dBµV)
0.150000	50.7	Off	N	19.5	15.3	66.0
0.414000	29.2	Off	N	19.5	28.4	57.6
0.582000	27.9	Off	N	19.5	28.1	56.0
0.662000	26.8	Off	N	19.5	29.2	56.0
1.070000	30.5	Off	N	19.6	25.5	56.0
11.054000	29.1	Off	N	20.1	30.9	60.0
25.598000	34.2	Off	N	21.0	25.8	60.0

Final Result 2

Frequency (MHz)	Average (dBµV)	Filter	Line	Corr. (dB)	Margin (dB)	Limit (dBµV)
0.150000	27.1	Off	N	19.5	28.9	56.0
0.414000	19.4	Off	N	19.5	28.2	47.6
0.582000	19.3	Off	N	19.5	26.7	46.0
0.662000	19.8	Off	N	19.5	26.2	46.0
1.070000	25.8	Off	N	19.6	20.2	46.0
11.054000	20.4	Off	N	20.1	29.6	50.0
25.598000	26.3	Off	N	21.0	23.7	50.0



Appendix C. Radiated Spurious Emission

Test Engineer :	Nick Yu / Peter Liao / Ray Chen	Temperature :	22~24°C
		Relative Humidity :	43~44%

Band 1 - 5150~5250MHz

WIFI 802.11a (Band Edge @ 3m)

WIFI Ant. 1	Note	Frequency (MHz)	Level (dBμV/m)	Over Limit (dB)	Limit Line (dBμV/m)	Read Level (dBμV)	Antenna Factor (dB/m)	Cable Loss (dB)	Preamp Factor (dB)	Ant Pos (cm)	Table Pos (deg)	Peak Avg. (P/A)	Pol. (H/V)	
802.11a CH 36 5180MHz		5142.74	50.52	-23.48	74	43.01	32.47	5.99	30.95	100	253	P	H	
		5149.5	39.99	-14.01	54	32.48	32.47	5.99	30.95	100	253	A	H	
	*	5180	103.58	-	-	96.05	32.46	6.02	30.95	100	253	P	H	
	*	5180	92.49	-	-	84.96	32.46	6.02	30.95	100	253	A	H	
													H	
														H
			5146.9	51.14	-22.86	74	43.63	32.47	5.99	30.95	101	243	P	V
			5150	39.77	-14.23	54	32.26	32.47	5.99	30.95	101	243	A	V
	*		5180	103.28	-	-	95.75	32.46	6.02	30.95	101	243	P	V
	*		5180	92.2	-	-	84.67	32.46	6.02	30.95	101	243	A	V
														V
														V
802.11a CH 44 5220MHz		5101.92	54.5	-19.5	74	47.02	32.48	5.95	30.95	100	263	P	H	
		5134.16	43.43	-10.57	54	35.93	32.47	5.98	30.95	100	263	A	H	
	*	5220	102.67	-	-	95.12	32.46	6.04	30.95	100	263	P	H	
	*	5220	91.75	-	-	84.2	32.46	6.04	30.95	100	263	A	H	
			5394.48	54.4	-19.6	74	46.77	32.42	6.16	30.95	100	263	P	H
			5426.4	43.53	-10.47	54	35.89	32.41	6.18	30.95	100	263	A	H
			5143	54.47	-19.53	74	46.96	32.47	5.99	30.95	100	242	P	V
			5149.5	43.43	-10.57	54	35.92	32.47	5.99	30.95	100	242	A	V
	*		5220	103.92	-	-	96.37	32.46	6.04	30.95	100	242	P	V
	*		5220	92.7	-	-	85.15	32.46	6.04	30.95	100	242	A	V
			5422.76	54.68	-19.32	74	47.03	32.42	6.18	30.95	100	242	P	V
			5439.28	43.41	-10.59	54	35.76	32.41	6.19	30.95	100	242	A	V



802.11a CH 48 5240MHz		5122.2	54.36	-19.64	74	46.86	32.48	5.97	30.95	107	264	P	H
		5149.76	43.37	-10.63	54	35.86	32.47	5.99	30.95	107	264	A	H
	*	5240	102.48	-	-	94.93	32.45	6.05	30.95	107	264	P	H
	*	5240	91.31	-	-	83.76	32.45	6.05	30.95	107	264	A	H
		5442.36	54.87	-19.13	74	47.22	32.41	6.19	30.95	107	264	P	H
		5351.08	43.55	-10.45	54	35.95	32.43	6.12	30.95	107	264	A	H
		5121.42	54.57	-19.43	74	47.07	32.48	5.97	30.95	100	247	P	V
		5145.08	43.39	-10.61	54	35.88	32.47	5.99	30.95	100	247	A	V
	*	5240	103.69	-	-	96.14	32.45	6.05	30.95	100	247	P	V
	*	5240	92.9	-	-	85.35	32.45	6.05	30.95	100	247	A	V
		5447.4	55.61	-18.39	74	47.96	32.41	6.19	30.95	100	247	P	V
		5356.68	43.49	-10.51	54	35.89	32.43	6.12	30.95	100	247	A	V
Remark	1. No other spurious found. 2. All results are PASS against Peak and Average limit line.												



Band 1 5150~5250MHz
WIFI 802.11a (Harmonic @ 3m)

WIFI Ant. 1	Note	Frequency (MHz)	Level (dBμV/m)	Over Limit (dB)	Limit Line (dBμV/m)	Read Level (dBμV)	Antenna Factor (dB/m)	Cable Loss (dB)	Preamp Factor (dB)	Ant Pos (cm)	Table Pos (deg)	Peak Avg. (P/A)	Pol. (H/V)
802.11a CH 36 5180MHz		10360	47.32	-26.68	74	54.92	39.75	9.25	57.14	100	0	P	H
		15540	46.52	-27.48	74	53.13	39.38	11.47	58.22	100	0	P	H
													H
													H
		10360	46.59	-27.41	74	54.19	39.75	9.25	57.14	100	0	P	V
		15540	46.38	-27.62	74	52.99	39.38	11.47	58.22	100	0	P	V
													V
													V
802.11a CH 44 5220MHz		10440	48.96	-25.04	74	56.27	39.89	9.28	57.02	100	0	P	H
		15660	47.74	-26.26	74	54.4	39.02	11.53	57.96	100	0	P	H
													H
													H
		10440	48.94	-25.06	74	56.25	39.89	9.28	57.02	100	0	P	V
		15660	46.88	-27.12	74	53.54	39.02	11.53	57.96	100	0	P	V
													V
													V
802.11a CH 48 5240MHz		10480	47.98	-26.02	74	55.1	39.96	9.31	56.93	100	0	P	H
		15720	45.91	-28.09	74	52.58	38.84	11.56	57.81	100	0	P	H
													H
													H
		10480	47.22	-26.78	74	54.34	39.96	9.31	56.93	100	0	P	V
		15720	46.49	-27.51	74	53.16	38.84	11.56	57.81	100	0	P	V
													V
													V
Remark	1. No other spurious found. 2. All results are PASS against Peak and Average limit line.												



Band 1 5150~5250MHz
WIFI 802.11ac VHT20 (Band Edge @ 3m)

WIFI Ant. 1	Note	Frequency (MHz)	Level (dBμV/m)	Over Limit (dB)	Limit Line (dBμV/m)	Read Level (dBμV)	Antenna Factor (dB/m)	Cable Loss (dB)	Preamp Factor (dB)	Ant Pos (cm)	Table Pos (deg)	Peak Avg. (P/A)	Pol. (H/V)	
802.11ac VHT20 CH 36 5180MHz		5146.64	50.25	-23.75	74	42.74	32.47	5.99	30.95	105	318	P	H	
		5146.12	38.97	-15.03	54	31.46	32.47	5.99	30.95	105	318	A	H	
	*	5180	99.92	-	-	92.39	32.46	6.02	30.95	105	318	P	H	
	*	5180	89.1	-	-	81.57	32.46	6.02	30.95	105	318	A	H	
													H	
														H
			5093.34	49.4	-24.6	74	41.92	32.48	5.95	30.95	102	247	P	V
			5148.46	39.11	-14.89	54	31.6	32.47	5.99	30.95	102	247	A	V
		*	5180	100.2	-	-	92.67	32.46	6.02	30.95	102	247	P	V
		*	5180	89.04	-	-	81.51	32.46	6.02	30.95	102	247	A	V
													V	
													V	
802.11ac VHT20 CH 44 5220MHz		5074.62	49.84	-24.16	74	42.36	32.49	5.94	30.95	100	265	P	H	
		5145.34	38.21	-15.79	54	30.7	32.47	5.99	30.95	100	265	A	H	
		*	5220	98.62	-	-	91.07	32.46	6.04	30.95	100	265	P	H
		*	5220	87.72	-	-	80.17	32.46	6.04	30.95	100	265	A	H
			5376.56	49.08	-24.92	74	41.46	32.42	6.15	30.95	100	265	P	H
			5393.36	38.01	-15.99	54	30.39	32.42	6.15	30.95	100	265	A	H
			5030.68	49.93	-24.07	74	42.49	32.49	5.9	30.95	100	248	P	V
			5146.12	38.39	-15.61	54	30.88	32.47	5.99	30.95	100	248	A	V
		*	5220	102.22	-	-	94.67	32.46	6.04	30.95	100	248	P	V
		*	5220	90.69	-	-	83.14	32.46	6.04	30.95	100	248	A	V
		5379.92	50.01	-23.99	74	42.39	32.42	6.15	30.95	100	248	P	V	
		5414.64	38.05	-15.95	54	30.4	32.42	6.18	30.95	100	248	A	V	



802.11ac VHT20 CH 48 5240MHz		5010.14	49.38	-24.62	74	41.94	32.5	5.89	30.95	107	253	P	H
		5147.68	38.21	-15.79	54	30.7	32.47	5.99	30.95	107	253	A	H
	*	5240	99.49	-	-	91.94	32.45	6.05	30.95	107	253	P	H
	*	5240	88.26	-	-	80.71	32.45	6.05	30.95	107	253	A	H
		5396.72	49.13	-24.87	74	41.5	32.42	6.16	30.95	107	253	P	H
		5405.12	38.08	-15.92	54	30.45	32.42	6.16	30.95	107	253	A	H
		5138.84	49.74	-24.26	74	42.24	32.47	5.98	30.95	100	249	P	V
		5149.24	38.34	-15.66	54	30.83	32.47	5.99	30.95	100	249	A	V
	*	5240	102.19	-	-	94.64	32.45	6.05	30.95	100	249	P	V
	*	5240	90.96	-	-	83.41	32.45	6.05	30.95	100	249	A	V
		5451.04	49.16	-24.84	74	41.49	32.41	6.21	30.95	100	249	P	V
		5396.44	38.09	-15.91	54	30.46	32.42	6.16	30.95	100	249	A	V
Remark	1. No other spurious found. 2. All results are PASS against Peak and Average limit line.												



Band 1 5150~5250MHz
WIFI 802.11ac VHT20 (Harmonic @ 3m)

WIFI Ant. 1	Note	Frequency (MHz)	Level (dBμV/m)	Over Limit (dB)	Limit Line (dBμV/m)	Read Level (dBμV)	Antenna Factor (dB/m)	Cable Loss (dB)	Preamp Factor (dB)	Ant Pos (cm)	Table Pos (deg)	Peak Avg. (P/A)	Pol. (H/V)
802.11ac VHT20 CH 36 5180MHz		10360	49.23	-24.77	74	56.83	39.75	9.25	57.14	100	0	P	H
		15540	46.41	-27.59	74	53.02	39.38	11.47	58.22	100	0	P	H
													H
													H
		10360	49.62	-24.38	74	57.22	39.75	9.25	57.14	100	0	P	V
		15540	46.85	-27.15	74	53.46	39.38	11.47	58.22	100	0	P	V
													V
802.11ac VHT20 CH 44 5220MHz		10440	48.82	-25.18	74	56.13	39.89	9.28	57.02	100	0	P	H
		15660	47.26	-26.74	74	53.92	39.02	11.53	57.96	100	0	P	H
													H
													H
		10440	48.49	-25.51	74	55.8	39.89	9.28	57.02	100	0	P	V
		15660	47.61	-26.39	74	54.27	39.02	11.53	57.96	100	0	P	V
													V
802.11ac VHT20 CH 48 5240MHz		10480	47.54	-26.46	74	54.66	39.96	9.31	56.93	100	0	P	H
		15720	47.28	-26.72	74	53.95	38.84	11.56	57.81	100	0	P	H
													H
													H
		10480	48.04	-25.96	74	55.16	39.96	9.31	56.93	100	0	P	V
		15720	47.04	-26.96	74	53.71	38.84	11.56	57.81	100	0	P	V
													V
Remark	1. No other spurious found.												
	2. All results are PASS against Peak and Average limit line.												



Band 1 5150~5250MHz
WIFI 802.11ac VHT40 (Band Edge @ 3m)

WIFI Ant. 1	Note	Frequency (MHz)	Level (dBμV/m)	Over Limit (dB)	Limit Line (dBμV/m)	Read Level (dBμV)	Antenna Factor (dB/m)	Cable Loss (dB)	Preamp Factor (dB)	Ant Pos (cm)	Table Pos (deg)	Peak Avg. (P/A)	Pol. (H/V)
802.11ac VHT40 CH 38 5190MHz		5144.82	53.14	-20.86	74	45.63	32.47	5.99	30.95	100	264	P	H
		5150	42.35	-11.65	54	34.84	32.47	5.99	30.95	100	264	A	H
	*	5190	97.89	-	-	90.36	32.46	6.02	30.95	100	264	P	H
	*	5190	86.89	-	-	79.36	32.46	6.02	30.95	100	264	A	H
		5433.68	49.04	-24.96	74	41.39	32.41	6.19	30.95	100	264	P	H
		5408.2	38.85	-15.15	54	31.22	32.42	6.16	30.95	100	264	A	H
		5149.76	51.82	-22.18	74	44.31	32.47	5.99	30.95	100	244	P	V
		5149.5	42.21	-11.79	54	34.7	32.47	5.99	30.95	100	244	A	V
	*	5190	98.16	-	-	90.63	32.46	6.02	30.95	100	244	P	V
	*	5190	87.36	-	-	79.83	32.46	6.02	30.95	100	244	A	V
		5369.84	49.26	-24.74	74	41.64	32.43	6.14	30.95	100	244	P	V
		5401.48	38.94	-15.06	54	31.31	32.42	6.16	30.95	100	244	A	V
802.11ac VHT40 CH 46 5230MHz		5105.04	49.16	-24.84	74	41.68	32.48	5.95	30.95	100	262	P	H
		5149.24	39.32	-14.68	54	31.81	32.47	5.99	30.95	100	262	A	H
	*	5230	96.84	-	-	89.3	32.45	6.04	30.95	100	262	P	H
	*	5230	86.22	-	-	78.68	32.45	6.04	30.95	100	262	A	H
		5374.6	49.61	-24.39	74	41.99	32.43	6.14	30.95	100	262	P	H
		5414.64	38.94	-15.06	54	31.29	32.42	6.18	30.95	100	262	A	H
		5110.5	49.24	-24.76	74	41.74	32.48	5.97	30.95	109	243	P	V
		5147.16	39.1	-14.9	54	31.59	32.47	5.99	30.95	109	243	A	V
	*	5230	98.08	-	-	90.54	32.45	6.04	30.95	109	243	P	V
	*	5230	87.07	-	-	79.53	32.45	6.04	30.95	109	243	A	V
	5439.28	48.89	-25.11	74	41.24	32.41	6.19	30.95	109	243	P	V	
	5445.44	38.75	-15.25	54	31.1	32.41	6.19	30.95	109	243	A	V	
Remark	1. No other spurious found. 2. All results are PASS against Peak and Average limit line.												



Band 1 5150~5250MHz
WIFI 802.11ac VHT40 (Harmonic @ 3m)

WIFI Ant. 1	Note	Frequency (MHz)	Level (dBμV/m)	Over Limit (dB)	Limit Line (dBμV/m)	Read Level (dBμV)	Antenna Factor (dB/m)	Cable Loss (dB)	Preamp Factor (dB)	Ant Pos (cm)	Table Pos (deg)	Peak Avg. (P/A)	Pol. (H/V)	
802.11ac VHT40 CH 38 5190MHz		10380	47.46	-26.54	74	54.99	39.78	9.26	57.11	100	0	P	H	
		15570	46.06	-27.94	74	52.68	39.29	11.49	58.15	100	0	P	H	
													H	
													H	
			10380	47.37	-26.63	74	54.9	39.78	9.26	57.11	100	0	P	V
			15570	45.87	-28.13	74	52.49	39.29	11.49	58.15	100	0	P	V
														V
802.11ac VHT40 CH 46 5230MHz		10460	47.32	-26.68	74	54.55	39.93	9.29	56.99	100	0	P	H	
		15690	46.65	-27.35	74	53.32	38.93	11.54	57.88	100	0	P	H	
													H	
													H	
			10460	47.49	-26.51	74	54.72	39.93	9.29	56.99	100	0	P	V
			15690	47.93	-26.07	74	54.6	38.93	11.54	57.88	100	0	P	V
														V
Remark	1. No other spurious found.													
	2. All results are PASS against Peak and Average limit line.													



Band 1 5150~5250MHz
WIFI 802.11ac VHT80 (Band Edge @ 3m)

Table with 14 columns: WIFI Ant. 1, Note, Frequency (MHz), Level (dBµV/m), Over Limit (dB), Limit Line (dBµV/m), Read Level (dBµV), Antenna Factor (dB/m), Cable Loss (dB), Preamp Factor (dB), Ant Pos (cm), Table Pos (deg), Peak Avg. (P/A), Pol. (H/V). Rows include test results for 802.11ac VHT80 CH 42 5210MHz and a Remark section.



Band 1 5150~5250MHz

WIFI 802.11ac VHT80 (Harmonic @ 3m)

WIFI Ant. 1	Note	Frequency (MHz)	Level (dBμV/m)	Over Limit (dB)	Limit Line (dBμV/m)	Read Level (dBμV)	Antenna Factor (dB/m)	Cable Loss (dB)	Preamp Factor (dB)	Ant Pos (cm)	Table Pos (deg)	Peak Avg. (P/A)	Pol. (H/V)	
802.11ac VHT80 CH 42 5210MHz		10420	49.18	-24.82	74	56.56	39.86	9.27	57.05	100	0	P	H	
		15630	46.79	-27.21	74	53.42	39.11	11.51	58	100	0	P	H	
													H	
													H	
			10420	48.77	-25.23	74	56.15	39.86	9.27	57.05	100	0	P	V
			15630	47.33	-26.67	74	53.96	39.11	11.51	58	100	0	P	V
														V
														V
Remark	1. No other spurious found. 2. All results are PASS against Peak and Average limit line.													



Band 2 - 5250~5350MHz
WIFI 802.11a (Band Edge @ 3m)

WIFI	Note	Frequency	Level	Over	Limit	Read	Antenna	Cable	Preamp	Ant	Table	Peak	Pol.
Ant.				Limit	Line	Level	Factor	Loss	Factor	Pos	Pos	Avg.	
1		(MHz)	(dBμV/m)	(dB)	(dBμV/m)	(dBμV)	(dB/m)	(dB)	(dB)	(cm)	(deg)	(P/A)	(H/V)
802.11a CH 52 5260MHz		5067.32	54.42	-19.58	74	46.95	32.49	5.93	30.95	100	74	P	H
		5068.34	43.37	-10.63	54	35.9	32.49	5.93	30.95	100	74	A	H
	*	5260	101.76	-	-	94.19	32.45	6.07	30.95	100	74	P	H
	*	5260	90.76	-	-	83.19	32.45	6.07	30.95	100	74	A	H
		5400.48	54.68	-19.32	74	47.05	32.42	6.16	30.95	100	74	P	H
		5370.72	43.45	-10.55	54	35.83	32.43	6.14	30.95	100	74	A	H
		5021.76	54.31	-19.69	74	46.86	32.5	5.9	30.95	100	249	P	V
		5100.98	43.34	-10.66	54	35.86	32.48	5.95	30.95	100	249	A	V
	*	5260	103.88	-	-	96.31	32.45	6.07	30.95	100	249	P	V
	*	5260	92.82	-	-	85.25	32.45	6.07	30.95	100	249	A	V
		5420.16	54.53	-19.47	74	46.88	32.42	6.18	30.95	100	249	P	V
		5408.16	43.52	-10.48	54	35.89	32.42	6.16	30.95	100	249	A	V
802.11a CH 60 5300MHz		5142.46	55.62	-18.38	74	48.12	32.47	5.98	30.95	100	74	P	H
		5149.26	43.39	-10.61	54	35.88	32.47	5.99	30.95	100	74	A	H
	*	5300	103.13	-	-	95.55	32.44	6.09	30.95	100	74	P	H
	*	5300	91.98	-	-	84.4	32.44	6.09	30.95	100	74	A	H
		5371.2	54.56	-19.44	74	46.94	32.43	6.14	30.95	100	74	P	H
		5444.88	43.5	-10.5	54	35.85	32.41	6.19	30.95	100	74	A	H
		5090.78	55.55	-18.45	74	48.07	32.48	5.95	30.95	101	245	P	V
		5113.9	43.33	-10.67	54	35.83	32.48	5.97	30.95	101	245	A	V
	*	5300	105.13	-	-	97.55	32.44	6.09	30.95	101	245	P	V
	*	5300	94.09	-	-	86.51	32.44	6.09	30.95	101	245	A	V
		5422.8	54.83	-19.17	74	47.18	32.42	6.18	30.95	101	245	P	V
		5364	43.66	-10.34	54	36.04	32.43	6.14	30.95	101	245	A	V



802.11a CH 64 5320MHz	*	5320	103.09	-	-	95.5	32.44	6.1	30.95	100	72	P	H
	*	5320	91.84	-	-	84.25	32.44	6.1	30.95	100	72	A	H
		5421.6	54.7	-19.3	74	47.05	32.42	6.18	30.95	100	72	P	H
		5366.72	43.64	-10.36	54	36.02	32.43	6.14	30.95	100	72	A	H
													H
													H
	*	5320	105.12	-	-	97.53	32.44	6.1	30.95	100	246	P	V
	*	5320	94.11	-	-	86.52	32.44	6.1	30.95	100	246	A	V
		5357.76	54.99	-19.01	74	47.39	32.43	6.12	30.95	100	246	P	V
		5358.24	43.83	-10.17	54	36.21	32.43	6.14	30.95	100	246	A	V
													V
													V
Remark	1. No other spurious found. 2. All results are PASS against Peak and Average limit line.												



Band 2 5250~5350MHz
WIFI 802.11a (Harmonic @ 3m)

WIFI Ant. 1	Note	Frequency (MHz)	Level (dBμV/m)	Over Limit (dB)	Limit Line (dBμV/m)	Read Level (dBμV)	Antenna Factor (dB/m)	Cable Loss (dB)	Preamp Factor (dB)	Ant Pos (cm)	Table Pos (deg)	Peak Avg. (P/A)	Pol. (H/V)
802.11a CH 52 5260MHz		10520	48.1	-25.9	74	55.12	40.01	9.33	56.9	100	0	P	H
		15780	46.08	-27.92	74	52.79	38.66	11.58	57.69	100	0	P	H
													H
													H
		10520	47.22	-26.78	74	54.24	40.01	9.33	56.9	100	0	P	V
		15780	46.36	-27.64	74	53.07	38.66	11.58	57.69	100	0	P	V
													V
													V
802.11a CH 60 5300MHz		10600	48.77	-25.23	74	55.71	40.04	9.36	56.88	400	0	P	H
		15900	45.42	-28.58	74	52.18	38.3	11.64	57.43	400	0	P	H
													H
													H
		10600	48.31	-25.69	74	55.25	40.04	9.36	56.88	100	0	P	V
		15900	44.61	-29.39	74	51.37	38.3	11.64	57.43	100	0	P	V
													V
													V
802.11a CH 64 5320MHz		10640	47.41	-26.59	74	54.31	40.06	9.38	56.87	100	0	P	H
		15960	45.43	-28.57	74	52.21	38.12	11.66	57.28	100	0	P	H
													H
													H
		10640	47.89	-26.11	74	54.79	40.06	9.38	56.87	100	0	P	V
		15960	45.07	-28.93	74	51.85	38.12	11.66	57.28	100	0	P	V
													V
													V
Remark	1. No other spurious found. 2. All results are PASS against Peak and Average limit line.												



Band 2 5250~5350MHz
WIFI 802.11ac VHT20 (Band Edge @ 3m)

WIFI Ant. 1	Note	Frequency (MHz)	Level (dBμV/m)	Over Limit (dB)	Limit Line (dBμV/m)	Read Level (dBμV)	Antenna Factor (dB/m)	Cable Loss (dB)	Preamp Factor (dB)	Ant Pos (cm)	Table Pos (deg)	Peak Avg. (P/A)	Pol. (H/V)
802.11ac VHT20 CH 52 5260MHz		5145.52	49.28	-24.72	74	41.77	32.47	5.99	30.95	100	264	P	H
		5147.22	38.21	-15.79	54	30.7	32.47	5.99	30.95	100	264	A	H
	*	5260	98.16	-	-	90.59	32.45	6.07	30.95	100	264	P	H
	*	5260	87.29	-	-	79.72	32.45	6.07	30.95	100	264	A	H
		5428.32	49.44	-24.56	74	41.8	32.41	6.18	30.95	100	264	P	H
		5384.88	38.1	-15.9	54	30.48	32.42	6.15	30.95	100	264	A	H
		5144.16	49.23	-24.77	74	41.72	32.47	5.99	30.95	100	248	P	V
		5134.3	38.02	-15.98	54	30.52	32.47	5.98	30.95	100	248	A	V
	*	5260	101.75	-	-	94.18	32.45	6.07	30.95	100	248	P	V
	*	5260	90.62	-	-	83.05	32.45	6.07	30.95	100	248	A	V
		5372.16	49.13	-24.87	74	41.51	32.43	6.14	30.95	100	248	P	V
		5393.28	38.18	-15.82	54	30.56	32.42	6.15	30.95	100	248	A	V
802.11ac VHT20 CH 60 5300MHz		5128.86	49.3	-24.7	74	41.8	32.47	5.98	30.95	100	316	P	H
		5147.9	37.85	-16.15	54	30.34	32.47	5.99	30.95	100	316	A	H
	*	5300	98.51	-	-	90.93	32.44	6.09	30.95	100	316	P	H
	*	5300	87.39	-	-	79.81	32.44	6.09	30.95	100	316	A	H
		5371.68	49.27	-24.73	74	41.65	32.43	6.14	30.95	100	316	P	H
		5448.48	38.11	-15.89	54	30.44	32.41	6.21	30.95	100	316	A	H
		5129.88	48.47	-25.53	74	40.97	32.47	5.98	30.95	100	249	P	V
		5114.58	37.99	-16.01	54	30.49	32.48	5.97	30.95	100	249	A	V
	*	5300	101.58	-	-	94	32.44	6.09	30.95	100	249	P	V
	*	5300	90.33	-	-	82.75	32.44	6.09	30.95	100	249	A	V
	5457.84	49.34	-24.66	74	41.67	32.41	6.21	30.95	100	249	P	V	
	5357.28	38.37	-15.63	54	30.77	32.43	6.12	30.95	100	249	A	V	



802.11ac VHT20 CH 64 5320MHz	*	5320	98.61	-	-	91.02	32.44	6.1	30.95	100	333	P	H
	*	5320	87.18	-	-	79.59	32.44	6.1	30.95	100	333	A	H
		5352.32	49.53	-24.47	74	41.93	32.43	6.12	30.95	100	333	P	H
		5359.36	38.81	-15.19	54	31.19	32.43	6.14	30.95	100	333	A	H
													H
													H
	*	5320	100.25	-	-	92.66	32.44	6.1	30.95	100	233	P	V
	*	5320	89.59	-	-	82	32.44	6.1	30.95	100	233	A	V
		5354.88	50.23	-23.77	74	42.63	32.43	6.12	30.95	100	233	P	V
		5351.52	39.09	-14.91	54	31.49	32.43	6.12	30.95	100	233	A	V
												V	
												V	
Remark	<ol style="list-style-type: none"> No other spurious found. All results are PASS against Peak and Average limit line. 												



Band 2 5250~5350MHz
WIFI 802.11ac VHT20 (Harmonic @ 3m)

WIFI Ant. 1	Note	Frequency (MHz)	Level (dBμV/m)	Over Limit (dB)	Limit Line (dBμV/m)	Read Level (dBμV)	Antenna Factor (dB/m)	Cable Loss (dB)	Preamp Factor (dB)	Ant Pos (cm)	Table Pos (deg)	Peak Avg. (P/A)	Pol. (H/V)	
802.11ac VHT20 CH 52 5260MHz		10520	49.71	-24.29	74	56.73	40.01	9.33	56.9	100	0	P	H	
		15780	48.14	-25.86	74	54.85	38.66	11.58	57.69	100	0	P	H	
													H	
													H	
			10520	48.66	-25.34	74	55.68	40.01	9.33	56.9	100	0	P	V
			15780	48.16	-25.84	74	54.87	38.66	11.58	57.69	100	0	P	V
														V
802.11ac VHT20 CH 60 5300MHz		10600	48.91	-25.09	74	55.85	40.04	9.36	56.88	100	0	P	H	
		15900	48.04	-25.96	74	54.8	38.3	11.64	57.43	100	0	P	H	
													H	
													H	
			10600	48.89	-25.11	74	55.83	40.04	9.36	56.88	100	0	P	V
			15900	47.28	-26.72	74	54.04	38.3	11.64	57.43	100	0	P	V
														V
802.11ac VHT20 CH 64 5320MHz		10640	48.4	-25.6	74	55.3	40.06	9.38	56.87	100	0	P	H	
		15960	46.25	-27.75	74	53.03	38.12	11.66	57.28	100	0	P	H	
													H	
													H	
			10640	47.91	-26.09	74	54.81	40.06	9.38	56.87	100	0	P	V
			15960	45.98	-28.02	74	52.76	38.12	11.66	57.28	100	0	P	V
														V
Remark	1. No other spurious found.													
	2. All results are PASS against Peak and Average limit line.													



Band 2 5250~5350MHz
WIFI 802.11ac VHT40 (Band Edge @ 3m)

WIFI Ant. 1	Note	Frequency (MHz)	Level (dBμV/m)	Over Limit (dB)	Limit Line (dBμV/m)	Read Level (dBμV)	Antenna Factor (dB/m)	Cable Loss (dB)	Preamp Factor (dB)	Ant Pos (cm)	Table Pos (deg)	Peak Avg. (P/A)	Pol. (H/V)
802.11ac VHT40 CH 54 5270MHz		5086.7	49.11	-24.89	74	41.64	32.48	5.94	30.95	100	263	P	H
		5141.44	38.99	-15.01	54	31.49	32.47	5.98	30.95	100	263	A	H
	*	5270	95.92	-	-	88.34	32.45	6.08	30.95	100	263	P	H
	*	5270	85.06	-	-	77.48	32.45	6.08	30.95	100	263	A	H
		5444.4	49.58	-24.42	74	41.93	32.41	6.19	30.95	100	263	P	H
		5404.8	39.12	-14.88	54	31.49	32.42	6.16	30.95	100	263	A	H
		5122.06	50.06	-23.94	74	42.56	32.48	5.97	30.95	100	242	P	V
		5006.12	38.93	-15.07	54	31.49	32.5	5.89	30.95	100	242	A	V
	*	5270	97.44	-	-	89.86	32.45	6.08	30.95	100	242	P	V
	*	5270	86.44	-	-	78.86	32.45	6.08	30.95	100	242	A	V
		5397.6	49.14	-24.86	74	41.51	32.42	6.16	30.95	100	242	P	V
		5362.8	38.88	-15.12	54	31.26	32.43	6.14	30.95	100	242	A	V
	802.11ac VHT40 CH 62 5310MHz		5022.44	49.1	-24.9	74	41.65	32.5	5.9	30.95	100	260	P
		5141.44	38.76	-15.24	54	31.26	32.47	5.98	30.95	100	260	A	H
*		5310	95.51	-	-	87.92	32.44	6.1	30.95	100	260	P	H
*		5310	84.86	-	-	77.27	32.44	6.1	30.95	100	260	A	H
		5350.08	51.02	-22.98	74	43.42	32.43	6.12	30.95	100	260	P	H
		5350.8	40.88	-13.12	54	33.28	32.43	6.12	30.95	100	260	A	H
		5041.82	48.84	-25.16	74	41.38	32.49	5.92	30.95	100	244	P	V
		5140.42	38.75	-15.25	54	31.25	32.47	5.98	30.95	100	244	A	V
*		5310	98.01	-	-	90.42	32.44	6.1	30.95	100	244	P	V
*		5310	86.98	-	-	79.39	32.44	6.1	30.95	100	244	A	V
	5356.32	51.26	-22.74	74	43.66	32.43	6.12	30.95	100	244	P	V	
	5350.08	42.41	-11.59	54	34.81	32.43	6.12	30.95	100	244	A	V	
Remark	1. No other spurious found. 2. All results are PASS against Peak and Average limit line.												



Band 2 5250~5350MHz
WIFI 802.11ac VHT40 (Harmonic @ 3m)

WIFI Ant. 1	Note	Frequency (MHz)	Level (dBμV/m)	Over Limit (dB)	Limit Line (dBμV/m)	Read Level (dBμV)	Antenna Factor (dB/m)	Cable Loss (dB)	Preamp Factor (dB)	Ant Pos (cm)	Table Pos (deg)	Peak Avg. (P/A)	Pol. (H/V)	
802.11ac VHT40 CH 54 5270MHz		10450	48.36	-25.64	74	55.61	39.91	9.29	56.99	100	0	P	H	
		15810	47.63	-26.37	74	54.34	38.57	11.6	57.62	100	0	P	H	
													H	
													H	
			10450	48	-26	74	55.25	39.91	9.29	56.99	100	0	P	V
			15810	47.97	-26.03	74	54.68	38.57	11.6	57.62	100	0	P	V
														V
802.11ac VHT40 CH 62 5310MHz		10620	47.61	-26.39	74	54.54	40.05	9.37	56.88	100	0	P	H	
		15930	46.88	-27.12	74	53.63	38.21	11.66	57.35	100	0	P	H	
													H	
													H	
			10620	47.74	-26.26	74	54.67	40.05	9.37	56.88	100	0	P	V
			15930	46.03	-27.97	74	52.78	38.21	11.66	57.35	100	0	P	V
														V
Remark	1. No other spurious found.													
	2. All results are PASS against Peak and Average limit line.													



Band 2 5250~5350MHz
WIFI 802.11ac VHT80 (Band Edge @ 3m)

WIFI Ant. 1	Note	Frequency (MHz)	Level (dBμV/m)	Over Limit (dB)	Limit Line (dBμV/m)	Read Level (dBμV)	Antenna Factor (dB/m)	Cable Loss (dB)	Preamp Factor (dB)	Ant Pos (cm)	Table Pos (deg)	Peak Avg. (P/A)	Pol. (H/V)
802.11ac VHT80 CH 58 5290MHz		5133.96	49.29	-24.71	74	41.79	32.47	5.98	30.95	115	263	P	H
		5132.6	38.77	-15.23	54	31.27	32.47	5.98	30.95	115	263	A	H
	*	5290	93.89	-	-	86.31	32.44	6.09	30.95	115	263	P	H
	*	5290	81.62	-	-	74.04	32.44	6.09	30.95	115	263	A	H
		5351.52	52	-22	74	44.4	32.43	6.12	30.95	115	263	P	H
		5350.56	41.24	-12.76	54	33.64	32.43	6.12	30.95	115	263	A	H
		5126.82	49.62	-24.38	74	42.12	32.47	5.98	30.95	105	242	P	V
		5148.92	38.8	-15.2	54	31.29	32.47	5.99	30.95	105	242	A	V
	*	5290	94.91	-	-	87.33	32.44	6.09	30.95	105	242	P	V
	*	5290	82.98	-	-	75.4	32.44	6.09	30.95	105	242	A	V
		5352.96	54.14	-19.86	74	46.54	32.43	6.12	30.95	105	242	P	V
		5352.48	42.9	-11.1	54	35.3	32.43	6.12	30.95	105	242	A	V
Remark	1. No other spurious found. 2. All results are PASS against Peak and Average limit line.												



Band 2 5250~5350MHz
WIFI 802.11ac VHT80 (Harmonic @ 3m)

WIFI Ant. 1	Note	Frequency (MHz)	Level (dBμV/m)	Over Limit (dB)	Limit Line (dBμV/m)	Read Level (dBμV)	Antenna Factor (dB/m)	Cable Loss (dB)	Preamp Factor (dB)	Ant Pos (cm)	Table Pos (deg)	Peak Avg. (P/A)	Pol. (H/V)	
802.11ac VHT80 CH 58 5290MHz		10580	48.85	-25.15	74	55.8	40.03	9.36	56.88	100	0	P	H	
		15870	46.76	-27.24	74	53.49	38.39	11.62	57.47	100	0	P	H	
													H	
													H	
			10580	48.27	-25.73	74	55.22	40.03	9.36	56.88	100	0	P	V
			15870	45.73	-28.27	74	52.46	38.39	11.62	57.47	100	0	P	V
														V
														V
Remark	1. No other spurious found. 2. All results are PASS against Peak and Average limit line.													



Band 3 - 5470~5725MHz
WIFI 802.11a (Band Edge @ 3m)

WIFI	Note	Frequency	Level	Over	Limit	Read	Antenna	Cable	Preamp	Ant	Table	Peak	Pol.	
Ant.				Limit	Line	Level	Factor	Loss	Factor	Pos	Pos	Avg.		
1		(MHz)	(dBμV/m)	(dB)	(dBμV/m)	(dBμV)	(dB/m)	(dB)	(dB)	(cm)	(deg)	(P/A)	(H/V)	
802.11a CH 100 5500MHz		5466.64	56.81	-17.19	74	49.12	32.41	6.23	30.95	118	70	P	H	
		5469.52	44.08	-9.92	54	36.39	32.41	6.23	30.95	118	70	A	H	
	*	5500	102.82	-	-	95.13	32.4	6.24	30.95	118	70	P	H	
	*	5500	91.89	-	-	84.2	32.4	6.24	30.95	118	70	A	H	
													H	
													H	
			5469.84	56.56	-17.44	74	48.87	32.41	6.23	30.95	100	251	P	V
			5469.84	45.35	-8.65	54	37.66	32.41	6.23	30.95	100	251	A	V
	*		5500	107.36	-	-	99.67	32.4	6.24	30.95	100	251	P	V
	*		5500	96.71	-	-	89.02	32.4	6.24	30.95	100	251	A	V
													V	
													V	
802.11a CH 116 5580MHz		5355.52	54.66	-19.34	74	47.06	32.43	6.12	30.95	100	114	P	H	
		5464.48	43.49	-10.51	54	35.82	32.41	6.21	30.95	100	114	A	H	
	*	5580	102.76	-	-	94.8	32.62	6.32	30.98	100	114	P	H	
	*	5580	91.72	-	-	83.76	32.62	6.32	30.98	100	114	A	H	
			5743.265	54.66	-19.34	74	46.24	33.08	6.37	31.03	100	114	P	H
			5742.95	44.23	-9.77	54	35.81	33.08	6.37	31.03	100	114	A	H
			5442.16	54.68	-19.32	74	47.03	32.41	6.19	30.95	101	251	P	V
			5465.44	43.51	-10.49	54	35.84	32.41	6.21	30.95	101	251	A	V
	*		5580	108.36	-	-	100.4	32.62	6.32	30.98	101	251	P	V
	*		5580	97.03	-	-	89.07	32.62	6.32	30.98	101	251	A	V
			5763.74	55.99	-18.01	74	47.52	33.14	6.37	31.04	101	251	P	V
			5750.825	44.18	-9.82	54	35.74	33.1	6.37	31.03	101	251	A	V



802.11a CH 140 5700MHz	*	5700	101.74	-	-	93.43	32.96	6.36	31.01	100	131	P	H
	*	5700	91.16	-	-	82.85	32.96	6.36	31.01	100	131	A	H
		5755.72	56.68	-17.32	74	48.22	33.12	6.37	31.03	100	131	P	H
		5725.24	44.94	-9.06	54	36.56	33.03	6.37	31.02	100	131	A	H
													H
													H
	*	5700	108.73	-	-	100.42	32.96	6.36	31.01	100	252	P	V
	*	5700	97.59	-	-	89.28	32.96	6.36	31.01	100	252	A	V
		5725.08	61.27	-12.73	74	52.89	33.03	6.37	31.02	100	252	P	V
		5725.08	47.94	-6.06	54	39.56	33.03	6.37	31.02	100	252	A	V
													V
													V
Remark	1. No other spurious found. 2. All results are PASS against Peak and Average limit line.												



Band 3 - 5470~5725MHz
WIFI 802.11a (Harmonic @ 3m)

WIFI Ant. 1	Note	Frequency (MHz)	Level (dBμV/m)	Over Limit (dB)	Limit Line (dBμV/m)	Read Level (dBμV)	Antenna Factor (dB/m)	Cable Loss (dB)	Preamp Factor (dB)	Ant Pos (cm)	Table Pos (deg)	Peak Avg. (P/A)	Pol. (H/V)
802.11a CH 100 5500MHz		11000	48.25	-25.75	74	54.77	40.2	9.56	56.8	100	0	P	H
		16500	46.39	-27.61	74	50	39.5	11.8	55.6	100	0	P	H
													H
													H
		11000	48.34	-25.66	74	54.86	40.2	9.56	56.8	100	0	P	V
		16500	49.52	-24.48	74	53.13	39.5	11.8	55.6	100	0	P	V
													V
													V
802.11a CH 116 5580MHz		11160	48.54	-25.46	74	55.25	40.2	9.64	57.07	100	0	P	H
		16740	48.4	-25.6	74	51.21	40.41	11.85	55.74	100	0	P	H
													H
													H
		11160	48.54	-25.46	74	55.25	40.2	9.64	57.07	100	0	P	V
		16740	58.65	-15.35	74	61.46	40.41	11.85	55.74	131	307	P	V
		16740	42.6	-11.4	54	45.41	40.41	11.85	55.74	131	307	A	V
													V
802.11a CH 140 5700MHz		11400	47.5	-26.5	74	54.45	40.2	9.77	57.44	100	0	P	H
		17100	49.31	-24.69	74	51.35	41.62	11.99	56.3	100	0	P	H
													H
													H
		11400	48.16	-25.84	74	55.11	40.2	9.77	57.44	100	0	P	V
		17100	59.45	-14.55	74	61.49	41.62	11.99	56.3	137	56	P	V
		17100	43.85	-10.15	54	45.89	41.62	11.99	56.3	137	56	A	V
													V
Remark	1. No other spurious found. 2. All results are PASS against Peak and Average limit line.												



Band 3 - 5470~5725MHz
WIFI 802.11ac VHT20 (Band Edge @ 3m)

WIFI Ant. 1	Note	Frequency (MHz)	Level (dBμV/m)	Over Limit (dB)	Limit Line (dBμV/m)	Read Level (dBμV)	Antenna Factor (dB/m)	Cable Loss (dB)	Preamp Factor (dB)	Ant Pos (cm)	Table Pos (deg)	Peak Avg. (P/A)	Pol. (H/V)	
802.11ac VHT20 CH 100 5500MHz		5466.8	49.76	-24.24	74	42.07	32.41	6.23	30.95	100	321	P	H	
		5468.88	38.96	-15.04	54	31.27	32.41	6.23	30.95	100	321	A	H	
	*	5500	98.72	-	-	91.03	32.4	6.24	30.95	100	321	P	H	
	*	5500	88.04	-	-	80.35	32.4	6.24	30.95	100	321	A	H	
													H	
														H
			5469.2	51.6	-22.4	74	43.91	32.41	6.23	30.95	100	254	P	V
			5469.52	40.15	-13.85	54	32.46	32.41	6.23	30.95	100	254	A	V
		*	5500	103.26	-	-	95.57	32.4	6.24	30.95	100	254	P	V
		*	5500	93.07	-	-	85.38	32.4	6.24	30.95	100	254	A	V
													V	
													V	
802.11ac VHT20 CH 116 5580MHz		5466.16	49.74	-24.26	74	42.05	32.41	6.23	30.95	100	320	P	H	
		5465.68	38.13	-15.87	54	30.46	32.41	6.21	30.95	100	320	A	H	
	*	5580	100.9	-	-	92.94	32.62	6.32	30.98	100	320	P	H	
	*	5580	89.6	-	-	81.64	32.62	6.32	30.98	100	320	A	H	
			5738.225	49.93	-24.07	74	41.52	33.07	6.37	31.03	100	320	P	H
			5733.185	38.69	-15.31	54	30.3	33.05	6.37	31.03	100	320	A	H
			5402.08	50.11	-23.89	74	42.48	32.42	6.16	30.95	100	258	P	V
			5440.48	38.02	-15.98	54	30.37	32.41	6.19	30.95	100	258	A	V
		*	5580	105.09	-	-	97.13	32.62	6.32	30.98	100	258	P	V
		*	5580	93.99	-	-	86.03	32.62	6.32	30.98	100	258	A	V
		5733.185	50.39	-23.61	74	42	33.05	6.37	31.03	100	258	P	V	
		5747.675	38.81	-15.19	54	30.38	33.09	6.37	31.03	100	258	A	V	



802.11ac VHT20 CH 140 5700MHz	*	5700	99.44	-	-	91.13	32.96	6.36	31.01	110	298	P	H
	*	5700	88.31	-	-	80	32.96	6.36	31.01	110	298	A	H
		5725.08	53.19	-20.81	74	44.81	33.03	6.37	31.02	110	298	P	H
		5725.4	40.96	-13.04	54	32.58	33.03	6.37	31.02	110	298	A	H
													H
													H
	*	5700	105.29	-	-	96.98	32.96	6.36	31.01	100	254	P	V
	*	5700	94.21	-	-	85.9	32.96	6.36	31.01	100	254	A	V
		5725.08	57.75	-16.25	74	49.37	33.03	6.37	31.02	100	254	P	V
		5725	43.83	-10.17	54	35.45	33.03	6.37	31.02	100	254	A	V
												V	
												V	
Remark	1. No other spurious found. 2. All results are PASS against Peak and Average limit line.												



Band 3 - 5470~5725MHz
WIFI 802.11ac VHT20 (Harmonic @ 3m)

WIFI Ant. 1	Note	Frequency (MHz)	Level (dBμV/m)	Over Limit (dB)	Limit Line (dBμV/m)	Read Level (dBμV)	Antenna Factor (dB/m)	Cable Loss (dB)	Preamp Factor (dB)	Ant Pos (cm)	Table Pos (deg)	Peak Avg. (P/A)	Pol. (H/V)	
802.11ac VHT20 CH 100 5500MHz		11000	48.24	-25.76	74	54.76	40.2	9.56	56.8	100	0	P	H	
		16500	45.15	-28.85	74	48.76	39.5	11.8	55.6	100	0	P	H	
													H	
													H	
			11000	49.52	-24.48	74	56.04	40.2	9.56	56.8	100	0	P	V
			16500	46.33	-27.67	74	49.94	39.5	11.8	55.6	100	0	P	V
														V
802.11ac VHT20 CH 116 5580MHz		11160	47.93	-26.07	74	54.64	40.2	9.64	57.07	100	0	P	H	
		16740	47.06	-26.94	74	49.87	40.41	11.85	55.74	100	0	P	H	
													H	
													H	
			11160	47.2	-26.8	74	53.91	40.2	9.64	57.07	100	0	P	V
			16740	47.95	-26.05	74	50.76	40.41	11.85	55.74	100	0	P	V
														V
802.11ac VHT20 CH 140 5700MHz		11400	46.08	-27.92	74	53.03	40.2	9.77	57.44	100	0	P	H	
		17100	47.96	-26.04	74	50	41.62	11.99	56.3	100	0	P	H	
													H	
													H	
			11400	46.13	-27.87	74	53.08	40.2	9.77	57.44	100	0	P	V
			17100	48.13	-25.87	74	50.17	41.62	11.99	56.3	100	0	P	V
														V
Remark	1. No other spurious found.													
	2. All results are PASS against Peak and Average limit line.													



Band 3 - 5470~5725MHz
WIFI 802.11ac VHT40 (Band Edge @ 3m)

WIFI Ant. 1	Note	Frequency (MHz)	Level (dBμV/m)	Over Limit (dB)	Limit Line (dBμV/m)	Read Level (dBμV)	Antenna Factor (dB/m)	Cable Loss (dB)	Preamp Factor (dB)	Ant Pos (cm)	Table Pos (deg)	Peak Avg. (P/A)	Pol. (H/V)
802.11ac VHT40 CH 102 5510MHz		5469.76	54.86	-19.14	74	47.17	32.41	6.23	30.95	114	295	P	H
		5470	44.69	-9.31	54	37	32.41	6.23	30.95	114	295	A	H
	*	5510	98.17	-	-	90.44	32.43	6.26	30.96	114	295	P	H
	*	5510	87.47	-	-	79.74	32.43	6.26	30.96	114	295	A	H
		5747.36	50.65	-23.35	74	42.22	33.09	6.37	31.03	114	295	P	H
		5725.31	39.62	-14.38	54	31.24	33.03	6.37	31.02	114	295	A	H
		5467.84	56.78	-17.22	74	49.09	32.41	6.23	30.95	104	262	P	V
		5469.76	47.6	-6.4	54	39.91	32.41	6.23	30.95	104	262	A	V
	*	5510	100.52	-	-	92.79	32.43	6.26	30.96	104	262	P	V
	*	5510	90.3	-	-	82.57	32.43	6.26	30.96	104	262	A	V
		5754.29	49.6	-24.4	74	41.15	33.11	6.37	31.03	104	262	P	V
		5734.13	39.63	-14.37	54	31.23	33.06	6.37	31.03	104	262	A	V
802.11ac VHT40 CH 110 5550MHz		5425.36	49.27	-24.73	74	41.63	32.41	6.18	30.95	105	295	P	H
		5466.88	38.96	-15.04	54	31.27	32.41	6.23	30.95	105	295	A	H
	*	5550	98.21	-	-	90.35	32.54	6.29	30.97	105	295	P	H
	*	5550	87.39	-	-	79.53	32.54	6.29	30.97	105	295	A	H
		5752.4	49.79	-24.21	74	41.34	33.11	6.37	31.03	105	295	P	H
		5754.29	39.51	-14.49	54	31.06	33.11	6.37	31.03	105	295	A	H
		5410	49.84	-24.16	74	42.21	32.42	6.16	30.95	100	256	P	V
		5468.56	39.42	-14.58	54	31.73	32.41	6.23	30.95	100	256	A	V
	*	5550	100.72	-	-	92.86	32.54	6.29	30.97	100	256	P	V
	*	5550	89.73	-	-	81.87	32.54	6.29	30.97	100	256	A	V
	5746.1	50.45	-23.55	74	42.02	33.09	6.37	31.03	100	256	P	V	
	5728.46	39.8	-14.2	54	31.41	33.04	6.37	31.02	100	256	A	V	



802.11ac VHT40 CH 134 5670MHz		5466.2	49.44	-24.56	74	41.75	32.41	6.23	30.95	117	293	P	H
		5461.65	38.79	-15.21	54	31.12	32.41	6.21	30.95	117	293	A	H
	*	5670	99.47	-	-	91.25	32.88	6.35	31.01	117	293	P	H
	*	5670	88.37	-	-	80.15	32.88	6.35	31.01	117	293	A	H
		5726.5	50.91	-23.09	74	42.53	33.03	6.37	31.02	117	293	P	H
		5732.275	40.44	-13.56	54	32.05	33.05	6.37	31.03	117	293	A	H
		5394.1	49.29	-24.71	74	41.66	32.42	6.16	30.95	113	262	P	V
		5464.1	38.85	-15.15	54	31.18	32.41	6.21	30.95	113	262	A	V
	*	5670	102.43	-	-	94.21	32.88	6.35	31.01	113	262	P	V
	*	5670	91.73	-	-	83.51	32.88	6.35	31.01	113	262	A	V
		5727.55	51.65	-22.35	74	43.26	33.04	6.37	31.02	113	262	P	V
		5726.5	41.31	-12.69	54	32.93	33.03	6.37	31.02	113	262	A	V
Remark	1. No other spurious found. 2. All results are PASS against Peak and Average limit line.												



Band 3 - 5470~5725MHz
WIFI 802.11ac VHT40 (Harmonic @ 3m)

WIFI Ant. 1	Note	Frequency (MHz)	Level (dBμV/m)	Over Limit (dB)	Limit Line (dBμV/m)	Read Level (dBμV)	Antenna Factor (dB/m)	Cable Loss (dB)	Preamp Factor (dB)	Ant Pos (cm)	Table Pos (deg)	Peak Avg. (P/A)	Pol. (H/V)	
802.11ac VHT40 CH 102 5510MHz		11020	48.54	-25.46	74	55.07	40.2	9.58	56.83	100	0	P	H	
		16530	46.93	-27.07	74	50.45	39.61	11.8	55.62	100	0	P	H	
													H	
													H	
			11020	48.47	-25.53	74	55	40.2	9.58	56.83	100	0	P	V
			16530	46.93	-27.07	74	50.45	39.61	11.8	55.62	100	0	P	V
														V
802.11ac VHT40 CH 110 5550MHz		11100	47.62	-26.38	74	54.24	40.2	9.62	56.96	100	0	P	H	
		16650	47.39	-26.61	74	50.5	40.07	11.83	55.69	100	0	P	H	
													H	
													H	
			11100	47.96	-26.04	74	54.58	40.2	9.62	56.96	100	0	P	V
			16650	48.18	-25.82	74	51.29	40.07	11.83	55.69	100	0	P	V
														V
802.11ac VHT40 CH 134 5670MHz		11340	47.16	-26.84	74	54.03	40.2	9.74	57.33	100	0	P	H	
		17010	48.83	-25.17	74	50.82	41.42	11.91	55.97	100	0	P	H	
													H	
													H	
			11340	47.9	-26.1	74	54.77	40.2	9.74	57.33	100	0	P	V
			17010	49.08	-24.92	74	51.07	41.42	11.91	55.97	100	0	P	V
														V
Remark	1. No other spurious found.													
	2. All results are PASS against Peak and Average limit line.													



Band 3 5470~5725MHz
WIFI 802.11ac VHT80 (Band Edge @ 3m)

WIFI Ant. 1	Note	Frequency (MHz)	Level (dBμV/m)	Over Limit (dB)	Limit Line (dBμV/m)	Read Level (dBμV)	Antenna Factor (dB/m)	Cable Loss (dB)	Preamp Factor (dB)	Ant Pos (cm)	Table Pos (deg)	Peak Avg. (P/A)	Pol. (H/V)
802.11ac VHT80 CH 106 5530MHz		5463.76	54.98	-19.02	74	47.31	32.41	6.21	30.95	111	295	P	H
		5468.32	44.79	-9.21	54	37.1	32.41	6.23	30.95	111	295	A	H
	*	5530	94.23	-	-	86.45	32.48	6.27	30.97	111	295	P	H
	*	5530	82.81	-	-	75.03	32.48	6.27	30.97	111	295	A	H
		5761.535	49.91	-24.09	74	41.45	33.13	6.37	31.04	111	295	P	H
		5752.4	39.57	-14.43	54	31.12	33.11	6.37	31.03	111	295	A	H
		5463.04	57.87	-16.13	74	50.2	32.41	6.21	30.95	106	263	P	V
		5461.84	45.36	-8.64	54	37.69	32.41	6.21	30.95	106	263	A	V
	*	5530	96.68	-	-	88.9	32.48	6.27	30.97	106	263	P	V
	*	5530	86.14	-	-	78.36	32.48	6.27	30.97	106	263	A	V
		5733.5	50.05	-23.95	74	41.66	33.05	6.37	31.03	106	263	P	V
		5759.015	39.64	-14.36	54	31.18	33.13	6.37	31.04	106	263	A	V
802.11ac VHT80 CH 122 5610MHz		5459.2	49.53	-24.47	74	41.86	32.41	6.21	30.95	100	126	P	H
		5360.5	38.92	-15.08	54	31.3	32.43	6.14	30.95	100	126	A	H
	*	5610	95.56	-	-	87.5	32.71	6.34	30.99	100	126	P	H
	*	5610	84.45	-	-	76.39	32.71	6.34	30.99	100	126	A	H
		5726.85	50.05	-23.95	74	41.66	33.04	6.37	31.02	100	126	P	H
		5754.5	39.65	-14.35	54	31.2	33.11	6.37	31.03	100	126	A	H
		5436.1	49.26	-24.74	74	41.61	32.41	6.19	30.95	100	260	P	V
		5424.55	39.1	-14.9	54	31.45	32.42	6.18	30.95	100	260	A	V
	*	5610	98.1	-	-	90.04	32.71	6.34	30.99	100	260	P	V
	*	5610	86.33	-	-	78.27	32.71	6.34	30.99	100	260	A	V
	5730.875	50.29	-23.71	74	41.9	33.05	6.37	31.03	100	260	P	V	
	5726.85	40.05	-13.95	54	31.66	33.04	6.37	31.02	100	260	A	V	
Remark	1. No other spurious found. 2. All results are PASS against Peak and Average limit line.												



Band 3 5470~5725MHz
WIFI 802.11ac VHT80 (Harmonic @ 3m)

WIFI Ant. 1	Note	Frequency (MHz)	Level (dBμV/m)	Over Limit (dB)	Limit Line (dBμV/m)	Read Level (dBμV)	Antenna Factor (dB/m)	Cable Loss (dB)	Preamp Factor (dB)	Ant Pos (cm)	Table Pos (deg)	Peak Avg. (P/A)	Pol. (H/V)
802.11ac VHT80 CH 106 5530MHz		11060	47.51	-26.49	74	54.1	40.2	9.6	56.91	100	0	P	H
		16590	46.19	-27.81	74	49.5	39.84	11.82	55.65	100	0	P	H
													H
													H
		11060	46.95	-27.05	74	53.54	40.2	9.6	56.91	100	0	P	V
		16590	46.57	-27.43	74	49.88	39.84	11.82	55.65	100	0	P	V
													V
802.11ac VHT80 CH 122 5610MHz		11220	45.99	-28.01	74	52.74	40.2	9.68	57.15	100	0	P	H
		16830	48.07	-25.93	74	50.58	40.75	11.87	55.8	100	0	P	H
													H
													H
		11220	46.19	-27.81	74	52.94	40.2	9.68	57.15	100	0	P	V
		16830	48.32	-25.68	74	50.83	40.75	11.87	55.8	100	0	P	V
													V
Remark	1. No other spurious found.												
	2. All results are PASS against Peak and Average limit line.												



Band 3 - Straddle Channel
WIFI 802.11a (Fundamental @ 3m)

WIFI	Note	Frequency	Level	Over	Limit	Read	Antenna	Cable	Preamp	Ant	Table	Peak	Pol.
Ant.				Limit	Line	Level	Factor	Loss	Factor	Pos	Pos	Avg.	
1		(MHz)	(dBμV/m)	(dB)	(dBμV/m)	(dBμV)	(dB/m)	(dB)	(dB)	(cm)	(deg)	(P/A)	(H/V)
802.11a CH 144 5720MHz	*	5720	103.87	-	-	95.5	33.02	6.37	31.02	104	124	P	H
	*	5720	92.96	-	-	84.59	33.02	6.37	31.02	104	124	A	H
													H
													H
													H
													H
	*	5720	108.34	-	-	99.97	33.02	6.37	31.02	100	258	P	V
	*	5720	97.29	-	-	88.92	33.02	6.37	31.02	100	258	A	V
													V
													V
													V
	Remark	1. No other spurious found. 2. All results are PASS against Peak and Average limit line.											



Band 3 - Straddle Channel
WIFI 802.11a (Harmonic @ 3m)

WIFI Ant. 1	Note	Frequency (MHz)	Level (dBμV/m)	Over Limit (dB)	Limit Line (dBμV/m)	Read Level (dBμV)	Antenna Factor (dB/m)	Cable Loss (dB)	Preamp Factor (dB)	Ant Pos (cm)	Table Pos (deg)	Peak Avg. (P/A)	Pol. (H/V)	
802.11a CH 144 5720MHz		11440	46.91	-27.09	74	53.9	40.2	9.79	57.49	100	0	P	H	
		17160	57.96	-16.04	74	60.11	41.75	12.03	56.57	211	335	P	H	
		17160	42.72	-11.28	54	44.87	41.75	12.03	56.57	211	335	A	H	
													H	
			11440	47.15	-26.85	74	54.14	40.2	9.79	57.49	100	0	P	V
			17160	59.15	-14.85	74	61.3	41.75	12.03	56.57	100	26	P	V
			17160	44.15	-9.85	54	46.3	41.75	12.03	56.57	100	26	A	V
														V
Remark	1. No other spurious found. 2. All results are PASS against Peak and Average limit line.													



Band 3 - Straddle Channel
WIFI 802.11ac VHT20 (Fundamental @ 3m)

WIFI Ant. 1	Note	Frequency (MHz)	Level (dBμV/m)	Over Limit (dB)	Limit Line (dBμV/m)	Read Level (dBμV)	Antenna Factor (dB/m)	Cable Loss (dB)	Preamp Factor (dB)	Ant Pos (cm)	Table Pos (deg)	Peak Avg. (P/A)	Pol. (H/V)
802.11ac VHT20 CH 144 5720MHz	*	5720	103.94	-	-	95.57	33.02	6.37	31.02	100	292	P	H
	*	5720	92.46	-	-	84.09	33.02	6.37	31.02	100	292	A	H
													H
													H
													H
													H
	*	5720	106.26	-	-	97.89	33.02	6.37	31.02	100	256	P	V
	*	5720	95.21	-	-	86.84	33.02	6.37	31.02	100	256	A	V
													V
													V
												V	
												V	
Remark	1. No other spurious found. 2. All results are PASS against Peak and Average limit line.												



Band 3 - Straddle Channel
WIFI 802.11ac VHT20 (Harmonic @ 3m)

WIFI Ant. 1	Note	Frequency (MHz)	Level (dBμV/m)	Over Limit (dB)	Limit Line (dBμV/m)	Read Level (dBμV)	Antenna Factor (dB/m)	Cable Loss (dB)	Preamp Factor (dB)	Ant Pos (cm)	Table Pos (deg)	Peak Avg. (P/A)	Pol. (H/V)	
802.11ac VHT20 CH 144 5720MHz		11440	47.74	-26.26	74	54.73	40.2	9.79	57.49	100	0	P	H	
		17160	48.12	-25.88	74	50.27	41.75	12.03	56.57	100	0	P	H	
													H	
													H	
			11440	46.93	-27.07	74	53.92	40.2	9.79	57.49	100	0	P	V
			17160	48.19	-25.81	74	50.34	41.75	12.03	56.57	100	0	P	V
														V
													V	
Remark	1. No other spurious found. 2. All results are PASS against Peak and Average limit line.													



Band 3 - Straddle Channel
WIFI 802.11ac VHT40 (Fundamental @ 3m)

WIFI Ant. 1	Note	Frequency (MHz)	Level (dBμV/m)	Over Limit (dB)	Limit Line (dBμV/m)	Read Level (dBμV)	Antenna Factor (dB/m)	Cable Loss (dB)	Preamp Factor (dB)	Ant Pos (cm)	Table Pos (deg)	Peak Avg. (P/A)	Pol. (H/V)
802.11ac VHT40 CH 142 5710MHz	*	5710	99.9	-	-	91.57	32.99	6.36	31.02	125	293	P	H
	*	5710	88.23	-	-	79.9	32.99	6.36	31.02	125	293	A	H
													H
													H
													H
													H
	*	5720	102.25	-	-	93.88	33.02	6.37	31.02	115	261	P	V
	*	5720	91.4	-	-	83.03	33.02	6.37	31.02	115	261	A	V
													V
													V
												V	
												V	
Remark	1. No other spurious found. 2. All results are PASS against Peak and Average limit line.												



Band 3 - Straddle Channel
WIFI 802.11ac VHT40 (Harmonic @ 3m)

WIFI Ant. 1	Note	Frequency (MHz)	Level (dBµV/m)	Over Limit (dB)	Limit Line (dBµV/m)	Read Level (dBµV)	Antenna Factor (dB/m)	Cable Loss (dB)	Preamp Factor (dB)	Ant Pos (cm)	Table Pos (deg)	Peak Avg. (P/A)	Pol. (H/V)	
802.11ac VHT40 CH 142 5710MHz		11420	46.98	-27.02	74	53.96	40.2	9.78	57.47	100	0	P	H	
		17130	48.66	-25.34	74	50.74	41.69	12.01	56.43	100	0	P	H	
													H	
													H	
			11420	46.81	-27.19	74	53.79	40.2	9.78	57.47	100	0	P	V
			17130	48.75	-25.25	74	50.83	41.69	12.01	56.43	100	0	P	V
														V
													V	
Remark	1. No other spurious found. 2. All results are PASS against Peak and Average limit line.													



**Band 3 - Straddle Channel
WIFI 802.11ac VHT80 (Fundamental @ 3m)**

WIFI Ant. 1	Note	Frequency (MHz)	Level (dBμV/m)	Over Limit (dB)	Limit Line (dBμV/m)	Read Level (dBμV)	Antenna Factor (dB/m)	Cable Loss (dB)	Preamp Factor (dB)	Ant Pos (cm)	Table Pos (deg)	Peak Avg. (P/A)	Pol. (H/V)
802.11ac VHT80 CH 138 5690MHz	*	5690	95.36	-	-	87.08	32.93	6.36	31.01	100	293	P	H
	*	5690	84.13	-	-	75.85	32.93	6.36	31.01	100	293	A	H
													H
													H
													H
													H
	*	5690	98.22	-	-	89.94	32.93	6.36	31.01	100	262	P	V
	*	5690	86.71	-	-	78.43	32.93	6.36	31.01	100	262	A	V
													V
													V
												V	
												V	
Remark	1. No other spurious found. 2. All results are PASS against Peak and Average limit line.												



Band 3 - Straddle Channel
WIFI 802.11ac VHT80 (Harmonic @ 3m)

WIFI Ant. 1	Note	Frequency (MHz)	Level (dBμV/m)	Over Limit (dB)	Limit Line (dBμV/m)	Read Level (dBμV)	Antenna Factor (dB/m)	Cable Loss (dB)	Preamp Factor (dB)	Ant Pos (cm)	Table Pos (deg)	Peak Avg. (P/A)	Pol. (H/V)	
802.11ac VHT80 CH 138 5690MHz		11380	47.59	-26.41	74	54.52	40.2	9.76	57.41	100	0	P	H	
		17070	48.92	-25.08	74	50.93	41.55	11.96	56.17	100	0	P	H	
													H	
													H	
			11380	46.78	-27.22	74	53.71	40.2	9.76	57.41	100	0	P	V
			17070	48.4	-25.6	74	50.41	41.55	11.96	56.17	100	0	P	V
														V
													V	
Remark	1. No other spurious found. 2. All results are PASS against Peak and Average limit line.													



Emission below 1GHz

WIFI 802.11a (LF @ 3m)

WIFI	Note	Frequency	Level	Over	Limit	Read	Antenna	Cable	Preamp	Ant	Table	Peak	Pol.	
Ant.				Limit	Line	Level	Factor	Loss	Factor	Pos	Pos	Avg.		
1		(MHz)	(dBμV/m)	(dB)	(dBμV/m)	(dBμV)	(dB/m)	(dB)	(dB)	(cm)	(deg)	(P/A)	(H/V)	
802.11a LF		137.46	27.83	-15.67	43.5	41.69	17.57	0.95	32.45	100	0	P	H	
		152.31	27.12	-16.38	43.5	41.25	17.15	1.02	32.43			P	H	
		243.84	22.26	-23.74	46	35.35	17.85	1.28	32.38			P	H	
		560.4	24.68	-21.32	46	28.88	26.2	1.92	32.43			P	H	
		888.7	29.95	-16.05	46	29.87	29.22	2.42	31.72			P	H	
		967.1	33.79	-20.21	54	31	31.09	2.51	31.04			P	H	
														H
														H
														H
														H
														H
														H
			139.08	29.92	-13.58	43.5	43.76	17.59	0.95	32.45			P	V
			150.96	28.11	-15.39	43.5	42.17	17.23	1.02	32.43			P	V
			243.84	22.19	-23.81	46	35.28	17.85	1.28	32.38			P	V
			654.9	26.84	-19.16	46	30.57	26.57	2.05	32.47			P	V
			885.9	37.04	-8.96	46	36.98	29.21	2.42	31.73	100	0	P	V
			984.6	32.36	-21.64	54	29.52	30.97	2.53	30.89			P	V
													V	
													V	
													V	
													V	
													V	
													V	
Remark	1. No other spurious found. 2. All results are PASS against limit line.													



Note symbol

*	Fundamental Frequency which can be ignored. However, the level of any unwanted emissions shall not exceed the level of the fundamental frequency.
!	Test result is over limit line.
P/A	Peak or Average
H/V	Horizontal or Vertical



A calculation example for radiated spurious emission is shown as below:

WIFI	Note	Frequency	Level	Over	Limit	Read	Antenna	Cable	Preamp	Ant	Table	Peak	Pol.
Ant.				Limit	Line	Level	Factor	Loss	Factor	Pos	Pos	Avg.	
1		(MHz)	(dBμV/m)	(dB)	(dBμV/m)	(dBμV)	(dB/m)	(dB)	(dB)	(cm)	(deg)	(P/A)	(H/V)
802.11b		2390	55.45	-18.55	74	54.51	32.22	4.58	35.86	103	308	P	H
CH 01													
2412MHz		2390	43.54	-10.46	54	42.6	32.22	4.58	35.86	103	308	A	H

- Level(dBμV/m) =
Antenna Factor(dB/m) + Cable Loss(dB) + Read Level(dBμV) - Preamp Factor(dB)
- Over Limit(dB) = Level(dBμV/m) – Limit Line(dBμV/m)

For Peak Limit @ 2390MHz:

- Level(dBμV/m)
= Antenna Factor(dB/m) + Cable Loss(dB) + Read Level(dBμV) - Preamp Factor(dB)
= 32.22(dB/m) + 4.58(dB) + 54.51(dBμV) – 35.86 (dB)
= 55.45 (dBμV/m)
- Over Limit(dB)
= Level(dBμV/m) – Limit Line(dBμV/m)
= 55.45(dBμV/m) – 74(dBμV/m)
= -18.55(dB)

For Average Limit @ 2390MHz:

- Level(dBμV/m)
= Antenna Factor(dB/m) + Cable Loss(dB) + Read Level(dBμV) - Preamp Factor(dB)
= 32.22(dB/m) + 4.58(dB) + 42.6(dBμV) – 35.86 (dB)
= 43.54 (dBμV/m)
- Over Limit(dB)
= Level(dBμV/m) – Limit Line(dBμV/m)
= 43.54(dBμV/m) – 54(dBμV/m)
= -10.46(dB)

Both peak and average measured complies with the limit line, so test result is “PASS”.



Appendix D. Radiated Spurious Emission

Test Engineer :	Nick Yu / Peter Liao / Ray Chen	Temperature :	22~24°C
		Relative Humidity :	43~44%

Note symbol

-L	Low channel location
-R	High channel location



Band 1 - 5150~5250MHz
WIFI 802.11a (Band Edge @ 3m)

Table with 2 columns (Horizontal, Fundamental) and 2 rows (Peak, Avg.). Each cell contains a spectral plot showing Level (dBuV/m) vs Frequency (MHz) with specific peak and average markers.

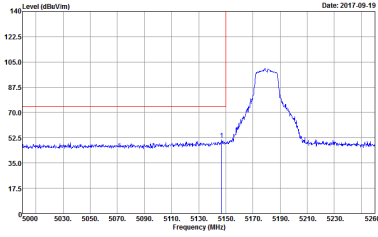
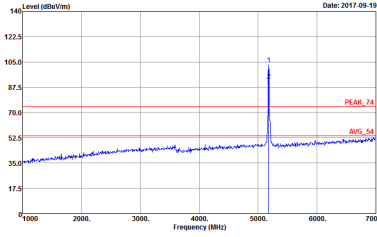
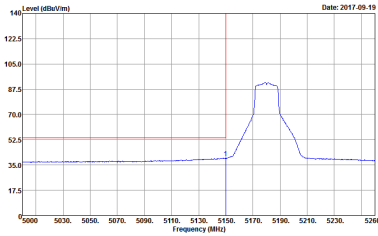

WIFI	Band 1 5150~5250MHz Band Edge @ 3m	
ANT	802.11a CH36 5180MHz	
1	Vertical	Fundamental
<p>Peak</p>	 <p>Site Condition : 03CH12-HY : PEAK_BE_74 3m HORN_9120D_1328 VERTICAL</p>	 <p>Site Condition : 03CH12-HY : PEAK_74 3m HORN_9120D_1328 VERTICAL</p>
<p>Avg.</p>	 <p>Site Condition : 03CH12-HY : AVG_BE_54 3m HORN_9120D_1328 VERTICAL</p>	<p>Left blank</p>



WIFI	Band 1 5150~5250MHz Band Edge @ 3m	
ANT	802.11a CH44 5220MHz - L	
1	Horizontal	Fundamental
Peak		
Avg.		Left blank

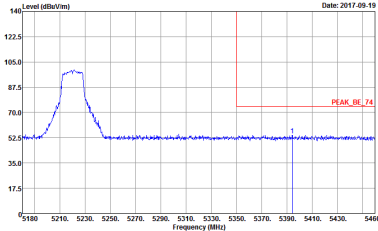
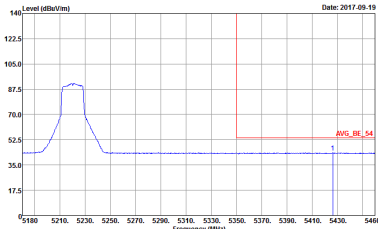

WIFI	Band 1 5150~5250MHz Band Edge @ 3m	
ANT	802.11a CH44 5220MHz - R	
1	Horizontal	Fundamental
<p>Peak</p>	 <p>Site Condition : 03CH12-HY : PEAK_BE_74 3m HORN_9120D_1328 HORIZONTAL</p>	<p>Left blank</p>
<p>Avg.</p>	 <p>Site Condition : 03CH12-HY : AVG_BE_54 3m HORN_9120D_1328 HORIZONTAL</p>	<p>Left blank</p>



WIFI	Band 1 5150~5250MHz Band Edge @ 3m	
ANT	802.11a CH44 5220MHz - L	
1	Vertical	Fundamental
Peak	<p>Site Condition : 03CH12-HY : PEAK_BE_74 3m HORN_9120D_1328 VERTICAL</p>	<p>Site Condition : 03CH12-HY : PEAK_74 3m HORN_9120D_1328 VERTICAL</p>
Avg.	<p>Site Condition : 03CH12-HY : AVG_BE_54 3m HORN_9120D_1328 VERTICAL</p>	Left blank



WIFI	Band 1 5150~5250MHz Band Edge @ 3m	
ANT	802.11a CH44 5220MHz - R	
1	Vertical	Fundamental
Peak	<p>Site Condition : 03CH12-HY : PEAK_BE_74 3m HORN_9120D_1328 VERTICAL</p>	Left blank
Avg.	<p>Site Condition : 03CH12-HY : AVG_BE_54 3m HORN_9120D_1328 VERTICAL</p>	Left blank



WIFI	Band 1 5150~5250MHz Band Edge @ 3m	
ANT	802.11a CH48 5240MHz - L	
1	Horizontal	Fundamental
Peak	<p>Site Condition : 03CH12-HY : PEAK_BE_74 3m HORN_9120D_1328 HORIZONTAL</p>	<p>Site Condition : 03CH12-HY : PEAK_74 3m HORN_9120D_1328 HORIZONTAL</p>
Avg.	<p>Site Condition : 03CH12-HY : AVG_BE_54 3m HORN_9120D_1328 HORIZONTAL</p>	Left blank

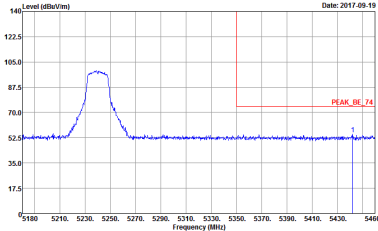
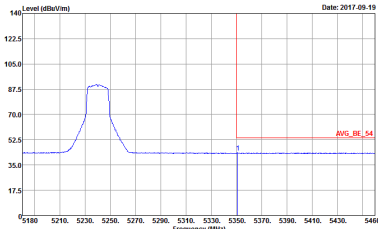

WIFI	Band 1 5150~5250MHz Band Edge @ 3m	
ANT	802.11a CH48 5240MHz - R	
1	Horizontal	Fundamental
<p>Peak</p>	 <p>Site Condition : 03CH12-HY : PEAK_BE_74 3m HORN_9120D_1328 HORIZONTAL</p>	<p>Left blank</p>
<p>Avg.</p>	 <p>Site Condition : 03CH12-HY : AVG_BE_54 3m HORN_9120D_1328 HORIZONTAL</p>	<p>Left blank</p>



WIFI	Band 1 5150~5250MHz Band Edge @ 3m	
ANT	802.11a CH48 5240MHz - L	
1	Vertical	Fundamental
Peak	<p>Site Condition : 03CH12-HY : PEAK_BE_74 3m HORN_9120D_1328 VERTICAL</p>	<p>Site Condition : 03CH12-HY : PEAK_74 3m HORN_9120D_1328 VERTICAL</p>
Avg.	<p>Site Condition : 03CH12-HY : AVG_BE_54 3m HORN_9120D_1328 VERTICAL</p>	Left blank



WIFI	Band 1 5150~5250MHz Band Edge @ 3m	
ANT	802.11a CH48 5240MHz - R	
1	Vertical	Fundamental
Peak	<p>Site Condition : 03CH12-HY : PEAK_BE_74 3m HORN_9120D_1328 VERTICAL</p>	Left blank
Avg.	<p>Site Condition : 03CH12-HY : AVG_BE_54 3m HORN_9120D_1328 VERTICAL</p>	Left blank



Band 1 5150~5250MHz
WIFI 802.11ac VHT20 (Band Edge @ 3m)

Table with 2 columns (WIFI, ANT) and 2 rows (Peak, Avg.). The table contains spectral plots for 'Horizontal' and 'Fundamental' views. The 'Peak' row shows a signal peak at 5170 MHz. The 'Avg.' row shows the average signal level. The 'Fundamental' view shows a sharp peak at 5170 MHz. The 'Left blank' view shows no signal.



WIFI	Band 1 5150~5250MHz Band Edge @ 3m	
ANT	802.11ac VHT20 CH36 5180MHz	
1	Vertical	Fundamental
Peak	<p>Site Condition : 03CH12-HY : PEAK_BE_74 3m HORN_9120D_1328 VERTICAL</p>	<p>Site Condition : 03CH12-HY : PEAK_74 3m HORN_9120D_1328 VERTICAL</p>
Avg.	<p>Site Condition : 03CH12-HY : AVG_BE_54 3m HORN_9120D_1328 VERTICAL</p>	Left blank

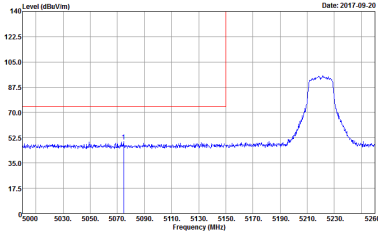
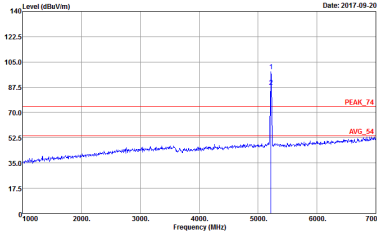
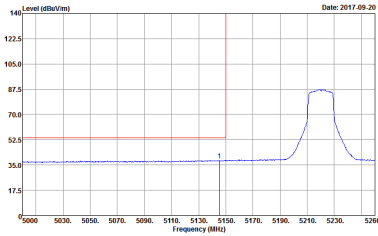

WIFI	Band 1 5150~5250MHz Band Edge @ 3m	
ANT	802.11ac VHT20 CH44 5220MHz - L	
1	Horizontal	Fundamental
<p>Peak</p>	 <p>Site Condition : 03CH12-HY : PEAK_BE_74 3m HORN_9120D_1328 HORIZONTAL</p>	 <p>Site Condition : 03CH12-HY : PEAK_74 3m HORN_9120D_1328 HORIZONTAL</p>
<p>Avg.</p>	 <p>Site Condition : 03CH12-HY : AVG_BE_54 3m HORN_9120D_1328 HORIZONTAL</p>	<p>Left blank</p>

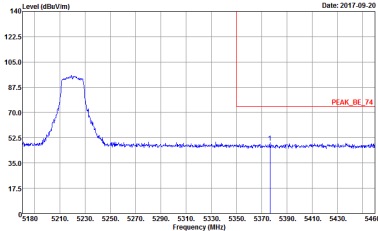
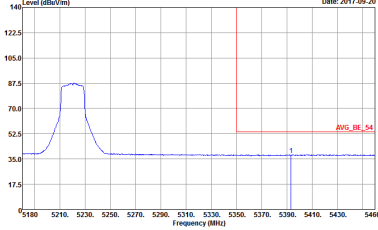

WIFI	Band 1 5150~5250MHz Band Edge @ 3m	
ANT	802.11ac VHT20 CH44 5220MHz - R	
1	Horizontal	Fundamental
<p>Peak</p>	 <p>Site Condition : 03CH12-HY : PEAK_BE_74 3m HORN_9120D_1328 HORIZONTAL</p>	<p>Left blank</p>
<p>Avg.</p>	 <p>Site Condition : 03CH12-HY : AVG_BE_54 3m HORN_9120D_1328 HORIZONTAL</p>	<p>Left blank</p>



WIFI	Band 1 5150~5250MHz Band Edge @ 3m	
ANT	802.11ac VHT20 CH44 5220MHz - L	
1	Vertical	Fundamental
Peak		
Avg.		Left blank

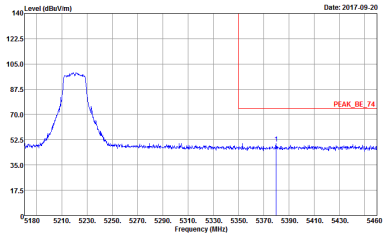
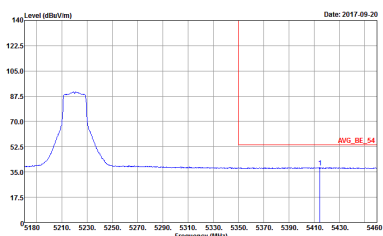

WIFI	Band 1 5150~5250MHz Band Edge @ 3m	
ANT	802.11ac VHT20 CH44 5220MHz - R	
1	Vertical	Fundamental
Peak	 <p>Site Condition : 03CH12-HY : PEAK_BE_74 3m HORN_9120D_1328 VERTICAL</p>	Left blank
Avg.	 <p>Site Condition : 03CH12-HY : AVG_BE_54 3m HORN_9120D_1328 VERTICAL</p>	Left blank

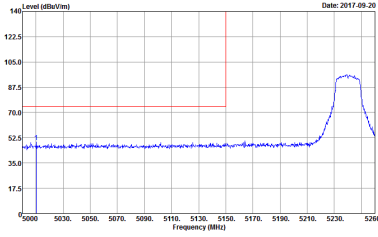
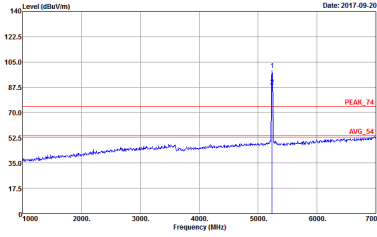
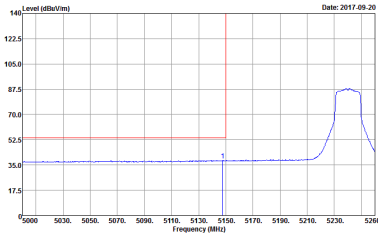

WIFI	Band 1 5150~5250MHz Band Edge @ 3m	
ANT	802.11ac VHT20 CH48 5240MHz - L	
1	Horizontal	Fundamental
<p>Peak</p>	 <p>Site Condition : 03CH12-HY : PEAK_BE_74 3m HORN_9120D_1328 HORIZONTAL</p>	 <p>Site Condition : 03CH12-HY : PEAK_74 3m HORN_9120D_1328 HORIZONTAL</p>
<p>Avg.</p>	 <p>Site Condition : 03CH12-HY : AVG_BE_54 3m HORN_9120D_1328 HORIZONTAL</p>	<p>Left blank</p>



WIFI	Band 1 5150~5250MHz Band Edge @ 3m	
ANT	802.11ac VHT20 CH48 5240MHz - R	
1	Horizontal	Fundamental
Peak	<p>Site Condition : 03CH12-HY : PEAK_BE_74 3m HORN_9120D_1328 HORIZONTAL</p>	Left blank
Avg.	<p>Site Condition : 03CH12-HY : AVG_BE_54 3m HORN_9120D_1328 HORIZONTAL</p>	Left blank

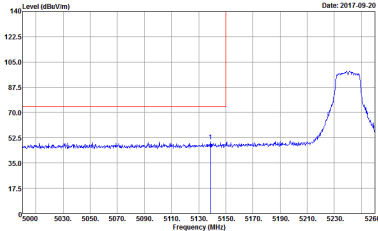
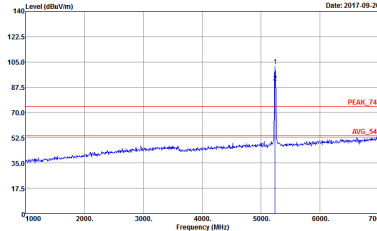
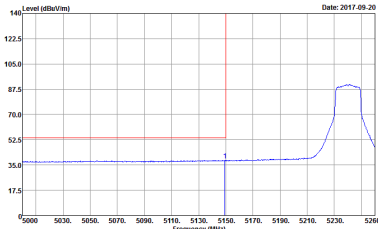

WIFI	Band 1 5150~5250MHz Band Edge @ 3m	
ANT	802.11ac VHT20 CH48 5240MHz - L	
1	Vertical	Fundamental
<p>Peak</p>	 <p>Site Condition : 03CH12-HY : PEAK_BE_74 3m HORN_9120D_1328 VERTICAL</p>	 <p>Site Condition : 03CH12-HY : PEAK_74 3m HORN_9120D_1328 VERTICAL</p>
<p>Avg.</p>	 <p>Site Condition : 03CH12-HY : AVG_BE_54 3m HORN_9120D_1328 VERTICAL</p>	<p>Left blank</p>

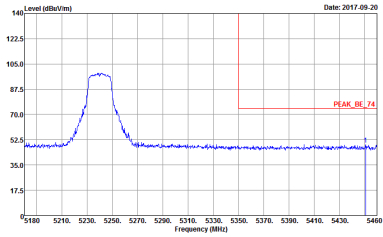
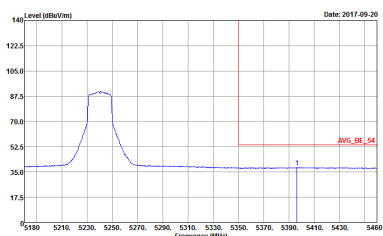

WIFI	Band 1 5150~5250MHz Band Edge @ 3m	
ANT	802.11ac VHT20 CH48 5240MHz - R	
1	Vertical	Fundamental
Peak	 <p>Site Condition : 03CH12-HY : PEAK_BE_74 3m HORN_9120D_1328 VERTICAL</p>	Left blank
Avg.	 <p>Site Condition : 03CH12-HY : AVG_BE_54 3m HORN_9120D_1328 VERTICAL</p>	Left blank



**Band 1 5150~5250MHz
WIFI 802.11ac VHT40 (Band Edge @ 3m)**

WIFI	Band 1 5150~5250MHz Band Edge @ 3m	
ANT	802.11ac VHT40 CH38 5190MHz - L	
1	Horizontal	Fundamental
Peak		
Avg.		Left blank

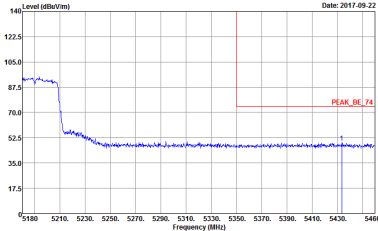
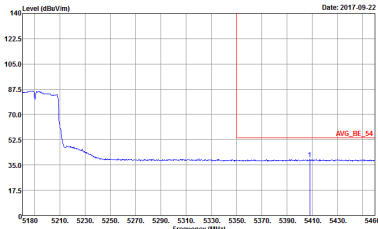

WIFI	Band 1 5150~5250MHz Band Edge @ 3m	
ANT	802.11ac VHT40 CH38 5190MHz - R	
1	Horizontal	Fundamental
<p>Peak</p>	 <p>Site Condition : 03CH12-HY : PEAK_BE_74 3m HORN_9120D_1328 HORIZONTAL</p>	<p>Left blank</p>
<p>Avg.</p>	 <p>Site Condition : 03CH12-HY : AVG_BE_54 3m HORN_9120D_1328 HORIZONTAL</p>	<p>Left blank</p>



WIFI	Band 1 5150~5250MHz Band Edge @ 3m	
ANT	802.11ac VHT40 CH38 5190MHz - L	
1	Vertical	Fundamental
Peak		
Avg.		Left blank



WIFI	Band 1 5150~5250MHz Band Edge @ 3m	
ANT	802.11ac VHT40 CH38 5190MHz - R	
1	Vertical	Fundamental
Peak	<p>Site Condition : 03CH12-HY : PEAK_BE_74 3m HORN_9120D_1328 VERTICAL</p>	Left blank
Avg.	<p>Site Condition : 03CH12-HY : AVG_BE_54 3m HORN_9120D_1328 VERTICAL</p>	Left blank

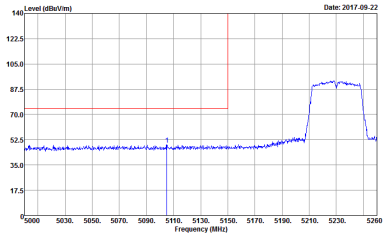
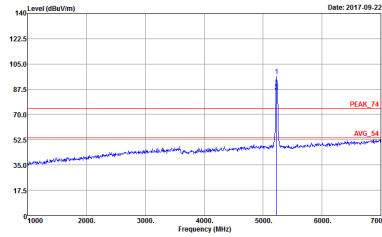
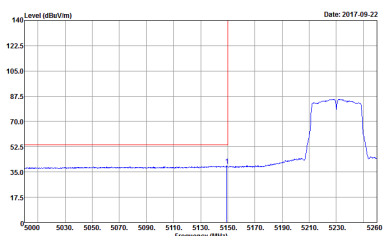

WIFI	Band 1 5150~5250MHz Band Edge @ 3m	
ANT	802.11ac VHT40 CH46 5230MHz - L	
1	Horizontal	Fundamental
Peak	 <p>Site Condition : 03CH12-HY : PEAK_BE_74 3m HORN_9120D_1328 HORIZONTAL</p>	 <p>Site Condition : 03CH12-HY : PEAK_74 3m HORN_9120D_1328 HORIZONTAL</p>
Avg.	 <p>Site Condition : 03CH12-HY : AVG_BE_54 3m HORN_9120D_1328 HORIZONTAL</p>	Left blank



WIFI	Band 1 5150~5250MHz Band Edge @ 3m	
ANT	802.11ac VHT40 CH46 5230MHz - R	
1	Horizontal	Fundamental
Peak	<p>Site Condition : 03CH12-HY : PEAK_BE_74 3m HORN_9120D_1328 HORIZONTAL</p>	Left blank
Avg.	<p>Site Condition : 03CH12-HY : AVG_BE_54 3m HORN_9120D_1328 HORIZONTAL</p>	Left blank



WIFI	Band 1 5150~5250MHz Band Edge @ 3m	
ANT	802.11ac VHT40 CH46 5230MHz - L	
1	Vertical	Fundamental
Peak	<p>Site Condition : 03CH12-HY : PEAK_BE_74 3m HORN_9120D_1328 VERTICAL</p>	<p>Site Condition : 03CH12-HY : PEAK_74 3m HORN_9120D_1328 VERTICAL</p>
Avg.	<p>Site Condition : 03CH12-HY : AVG_BE_54 3m HORN_9120D_1328 VERTICAL</p>	Left blank



WIFI	Band 1 5150~5250MHz Band Edge @ 3m	
ANT	802.11ac VHT40 CH46 5230MHz - R	
1	Vertical	Fundamental
Peak	<p>Site Condition : 03CH12-HY : PEAK_BE_74 3m HORN_9120D_1328 VERTICAL</p>	Left blank
Avg.	<p>Site Condition : 03CH12-HY : AVG_BE_54 3m HORN_9120D_1328 VERTICAL</p>	Left blank



**Band 1 5150~5250MHz
WIFI 802.11ac VHT80 (Band Edge @ 3m)**

WIFI	Band 1 5150~5250MHz Band Edge @ 3m	
ANT	802.11ac VHT80 CH42 5210MHz - L	
1	Horizontal	Fundamental
Peak	<p>Site Condition : 03CH12-HY : PEAK_BE_74 3m HORN_9120D_1328 HORIZONTAL</p>	<p>Site Condition : 03CH12-HY : PEAK_74 3m HORN_9120D_1328 HORIZONTAL</p>
Avg.	<p>Site Condition : 03CH12-HY : AVG_BE_54 3m HORN_9120D_1328 HORIZONTAL</p>	Left blank



WIFI	Band 1 5150~5250MHz Band Edge @ 3m	
ANT	802.11ac VHT80 CH42 5210MHz - R	
1	Horizontal	Fundamental
Peak	<p>Site Condition : 03CH12-HY : PEAK_BE_74 3m HORN_9120D_1328 HORIZONTAL</p>	Left blank
Avg.	<p>Site Condition : 03CH12-HY : AVG_BE_54 3m HORN_9120D_1328 HORIZONTAL</p>	Left blank



WIFI	Band 1 5150~5250MHz Band Edge @ 3m	
ANT	802.11ac VHT80 CH42 5210MHz - L	
1	Vertical	Fundamental
Peak	<p>Site Condition : 03CH12-HY : PEAK_BE_74 3m HORN_9120D_1328 VERTICAL</p>	<p>Site Condition : 03CH12-HY : PEAK_74 3m HORN_9120D_1328 VERTICAL</p>
Avg.	<p>Site Condition : 03CH12-HY : AVG_BE_54 3m HORN_9120D_1328 VERTICAL</p>	Left blank



WIFI	Band 1 5150~5250MHz Band Edge @ 3m	
ANT	802.11ac VHT80 CH42 5210MHz - R	
1	Vertical	Fundamental
Peak	<p>Site Condition : 03CH12-HY : PEAK_BE_74 3m HORN_9120D_1328 VERTICAL</p>	Left blank
Avg.	<p>Site Condition : 03CH12-HY : AVG_BE_54 3m HORN_9120D_1328 VERTICAL</p>	Left blank



Band 1 - 5150~5250MHz
WIFI 802.11a (Harmonic @ 3m)

WIFI	Band 1 5150~5250MHz Harmonic @ 3m	
ANT	802.11a CH36 5180MHz	
1	Horizontal	Vertical
Peak Avg.	<p>Site Condition : 03C112-HY : PEAK_74 3m HORN_9120D_1328 HORIZONTAL</p>	<p>Site Condition : 03C112-HY : PEAK_74 3m HORN_9120D_1328 VERTICAL</p>



WIFI	Band 1 5150~5250MHz Harmonic @ 3m	
ANT	802.11a CH44 5220MHz	
1	Horizontal	Vertical
Peak Avg.	<p>Site Condition : 03CH12-HY : PEAK_74 3m HORN_9120D_1328 HORIZONTAL</p>	<p>Site Condition : 03CH12-HY : PEAK_74 3m HORN_9120D_1328 VERTICAL</p>



WIFI	Band 1 5150~5250MHz Harmonic @ 3m	
ANT	802.11a CH48 5240MHz	
1	Horizontal	Vertical
Peak Avg.	<p>Site Condition : 03CH12-HY : PEAK_74 3m HORN_9120D_1328 HORIZONTAL</p>	<p>Site Condition : 03CH12-HY : PEAK_74 3m HORN_9120D_1328 VERTICAL</p>



Band 1 5150~5250MHz
WIFI 802.11ac VHT20 (Harmonic @ 3m)

WIFI	Band 1 5150~5250MHz Harmonic @ 3m	
ANT	802.11ac VHT20 CH36 5180MHz	
1	Horizontal	Vertical
Peak Avg.	<p>Site Condition : 03CH12-HY : PEAK_74 3m HORN_9120D_1320 HORIZONTAL</p>	<p>Site Condition : 03CH12-HY : PEAK_74 3m HORN_9120D_1320 VERTICAL</p>



WIFI	Band 1 5150~5250MHz Harmonic @ 3m	
ANT	802.11ac VHT20 CH44 5220MHz	
1	Horizontal	Vertical
Peak Avg.	<p>Site Condition : 03CH12-HY : PEAK_74 3m HORN_9120D_1328 HORIZONTAL</p>	<p>Site Condition : 03CH12-HY : PEAK_74 3m HORN_9120D_1328 VERTICAL</p>



WIFI	Band 1 5150~5250MHz Harmonic @ 3m	
ANT	802.11ac VHT20 CH48 5240MHz	
1	Horizontal	Vertical
Peak Avg.	<p>Site Condition : 03CH12-HY : PEAK_74 3m HORN_9120D_1328 HORIZONTAL</p>	<p>Site Condition : 03CH12-HY : PEAK_74 3m HORN_9120D_1328 VERTICAL</p>



Band 1 5150~5250MHz
WIFI 802.11ac VHT40 (Harmonic @ 3m)

Table with 3 columns: WIFI, ANT, and measurement results for Horizontal and Vertical orientations. Includes two graphs showing Level (dBm/Vm) vs Frequency (MHz) with peak and average values.



WIFI	Band 1 5150~5250MHz Harmonic @ 3m	
ANT	802.11ac VHT40 CH46 5230MHz	
1	Horizontal	Vertical
Peak Avg.	<p>Site Condition : 03CH12-HY : PEAK_74 3m HORN_9120D_1328 HORIZONTAL</p>	<p>Site Condition : 03CH12-HY : PEAK_74 3m HORN_9120D_1328 VERTICAL</p>



Band 1 5150~5250MHz
WIFI 802.11ac VHT80 (Harmonic @ 3m)

Table with 3 columns: WIFI, ANT, and measurement results for Horizontal and Vertical orientations. Includes two graphs showing Level (dBm/Vm) vs Frequency (MHz) with peak and average values.



Band 2 - 5250~5350MHz
WIFI 802.11a (Band Edge @ 3m)

WIFI	Band 2 5250~5350MHz Band Edge @ 3m	
ANT	802.11a CH52 5260MHz - L	
1	Horizontal	Fundamental
Peak	<p>Site Condition : 03CH12-HY : PEAK_BE_74 3m HORN_9120D_1328 HORIZONTAL</p>	<p>Site Condition : 03CH12-HY : PEAK_74 3m HORN_9120D_1328 HORIZONTAL</p>
Avg.	<p>Site Condition : 03CH12-HY : AVG_BE_54 3m HORN_9120D_1328 HORIZONTAL</p>	Left blank



WIFI	Band 2 5250~5350MHz Band Edge @ 3m	
ANT	802.11a CH52 5260MHz - R	
1	Horizontal	Fundamental
<p>Peak</p>		<p>Left blank</p>
<p>Avg.</p>		<p>Left blank</p>



WIFI	Band 2 5250~5350MHz Band Edge @ 3m	
ANT	802.11a CH52 5260MHz - L	
1	Vertical	Fundamental
<p>Peak</p>	<p>Site Condition : 03CH12-HY : PEAK_BE_74 3m HORN_9120D_1328 VERTICAL</p>	<p>Site Condition : 03CH12-HY : PEAK_74 3m HORN_9120D_1328 VERTICAL</p>
<p>Avg.</p>	<p>Site Condition : 03CH12-HY : AVG_BE_54 3m HORN_9120D_1328 VERTICAL</p>	<p>Left blank</p>



WIFI	Band 2 5250~5350MHz Band Edge @ 3m	
ANT	802.11a CH52 5260MHz - R	
1	Vertical	Fundamental
Peak		Left blank
Avg.		Left blank

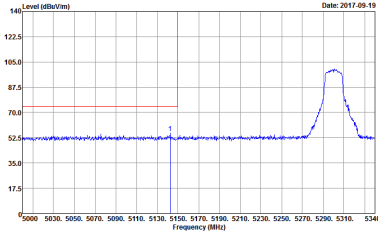
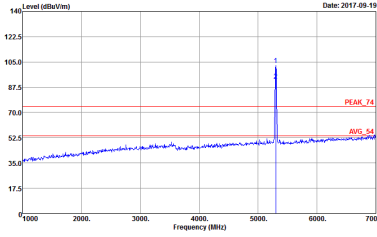
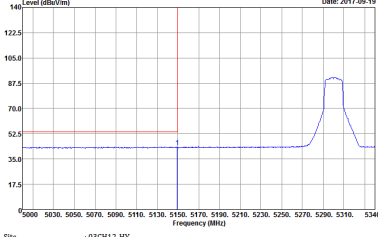

WIFI	Band 2 5250~5350MHz Band Edge @ 3m	
ANT	802.11a CH60 5300MHz - L	
1	Horizontal	Fundamental
<p>Peak</p>	 <p>Site Condition : 03CH12-HY : PEAK_BE_74 3m HORN_9120D_1328 HORIZONTAL</p>	 <p>Site Condition : 03CH12-HY : PEAK_74 3m HORN_9120D_1328 HORIZONTAL</p>
<p>Avg.</p>	 <p>Site Condition : 03CH12-HY : AVG_BE_54 3m HORN_9120D_1328 HORIZONTAL</p>	<p>Left blank</p>



WIFI	Band 2 5250~5350MHz Band Edge @ 3m	
ANT	802.11a CH60 5300MHz - R	
1	Horizontal	Fundamental
Peak	<p>Site: 03CH12-HY Condition: PEAK_BE_74 3m HORN_9120D_1328 HORIZONTAL Date: 2017-09-19</p>	Left blank
Avg.	<p>Site: 03CH12-HY Condition: AVG_BE_54 3m HORN_9120D_1328 HORIZONTAL Date: 2017-09-19</p>	Left blank



WIFI	Band 2 5250~5350MHz Band Edge @ 3m	
ANT	802.11a CH60 5300MHz - L	
1	Vertical	Fundamental
Peak	<p>Site Condition : 03CH12-HY : PEAK_BE_74 3m HORN_9120D_1328 VERTICAL</p>	<p>Site Condition : 03CH12-HY : PEAK_74 3m HORN_9120D_1328 VERTICAL</p>
Avg.	<p>Site Condition : 03CH12-HY : AVG_BE_54 3m HORN_9120D_1328 VERTICAL</p>	Left blank



WIFI	Band 2 5250~5350MHz Band Edge @ 3m	
ANT	802.11a CH60 5300MHz - R	
1	Vertical	Fundamental
Peak	<p>Site: 03CH12-HY Condition: PEAK_BE_74 3m HORN_9120D_1328 VERTICAL Date: 2017-09-19</p>	Left blank
Avg.	<p>Site: 03CH12-HY Condition: AVG_BE_54 3m HORN_9120D_1328 VERTICAL Date: 2017-09-19</p>	Left blank



WIFI	Band 2 5250~5350MHz Band Edge @ 3m	
ANT	802.11a CH64 5320MHz	
1	Horizontal	Fundamental
Peak	<p>Site Condition : 03CH12-HY : PEAK_BE_74 3m HORN_9120D_1328 HORIZONTAL</p>	<p>Site Condition : 03CH12-HY : PEAK_74 3m HORN_9120D_1328 HORIZONTAL</p>
Avg.	<p>Site Condition : 03CH12-HY : AVG_BE_54 3m HORN_9120D_1328 HORIZONTAL</p>	Left blank



WIFI	Band 2 5250~5350MHz Band Edge @ 3m	
ANT	802.11a CH64 5320MHz	
1	Vertical	Fundamental
Peak	<p>Site Condition : 03CH12-HY : PEAK_BE_74 3m HORN_9120D_1328 VERTICAL</p>	<p>Site Condition : 03CH12-HY : PEAK_74 3m HORN_9120D_1328 VERTICAL</p>
Avg.	<p>Site Condition : 03CH12-HY : AVG_BE_54 3m HORN_9120D_1328 VERTICAL</p>	Left blank



Band 2 5250~5350MHz
WIFI 802.11ac VHT20 (Band Edge @ 3m)

WIFI	Band 2 5250~5350MHz Band Edge @ 3m	
ANT	802.11ac VHT20 CH52 5260MHz - L	
1	Horizontal	Fundamental
Peak		
Avg.		Left blank

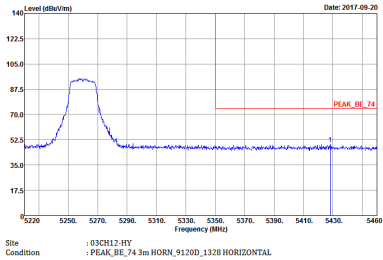
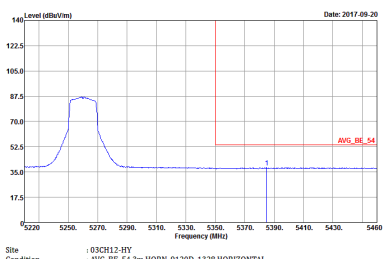

WIFI	Band 2 5250~5350MHz Band Edge @ 3m	
ANT	802.11ac VHT20 CH52 5260MHz - R	
1	Horizontal	Fundamental
Peak		Left blank
Avg.		Left blank



WIFI	Band 2 5250~5350MHz Band Edge @ 3m	
ANT	802.11ac VHT20 CH52 5260MHz - L	
1	Vertical	Fundamental
Peak	<p>Site Condition : 03CH12-HY : PEAK_BE_74 3m HORN_9120D_1328 VERTICAL</p>	<p>Site Condition : 03CH12-HY : PEAK_74 3m HORN_9120D_1328 VERTICAL</p>
Avg.	<p>Site Condition : 03CH12-HY : AVG_BE_54 3m HORN_9120D_1328 VERTICAL</p>	Left blank

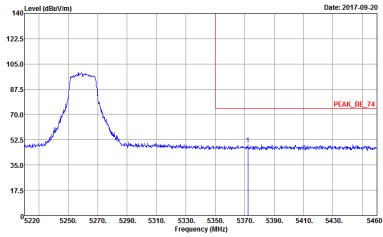
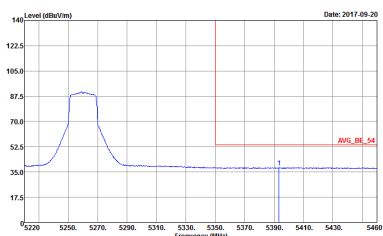

WIFI	Band 2 5250~5350MHz Band Edge @ 3m	
ANT	802.11ac VHT20 CH52 5260MHz - R	
1	Vertical	Fundamental
<p>Peak</p>	 <p>Site Condition : 03CH12-HY : PEAK_BE_74 3m HORN_9120D_1328 VERTICAL</p>	<p>Left blank</p>
<p>Avg.</p>	 <p>Site Condition : 03CH12-HY : AVG_BE_54 3m HORN_9120D_1328 VERTICAL</p>	<p>Left blank</p>



WIFI	Band 2 5250~5350MHz Band Edge @ 3m	
ANT	802.11ac VHT20 CH60 5300MHz - L	
1	Horizontal	Fundamental
Peak	<p>Site Condition : 03CH12-HY : PEAK_BE_74 3m HORN_9120D_1328 HORIZONTAL</p>	<p>Site Condition : 03CH12-HY : PEAK_74 3m HORN_9120D_1328 HORIZONTAL</p>
Avg.	<p>Site Condition : 03CH12-HY : AVG_BE_54 3m HORN_9120D_1328 HORIZONTAL</p>	Left blank

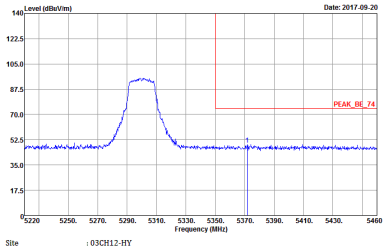
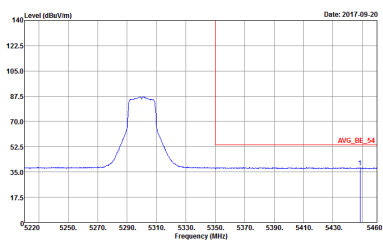

WIFI	Band 2 5250~5350MHz Band Edge @ 3m	
ANT	802.11ac VHT20 CH60 5300MHz - R	
1	Horizontal	Fundamental
Peak	 <p>Site: 03CH12-HY Condition: PEAK_BE_74 3m HORN_9120D_1328 HORIZONTAL Date: 2017-09-20</p>	Left blank
Avg.	 <p>Site: 03CH12-HY Condition: AVG_BE_54 3m HORN_9120D_1328 HORIZONTAL Date: 2017-09-20</p>	Left blank

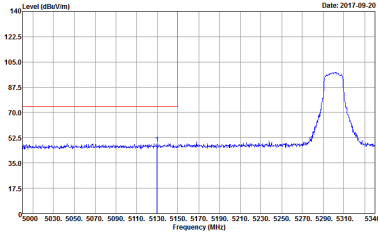
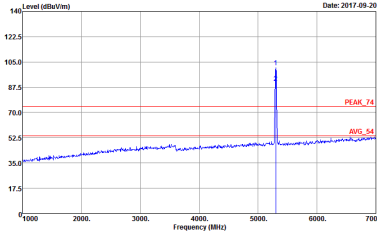
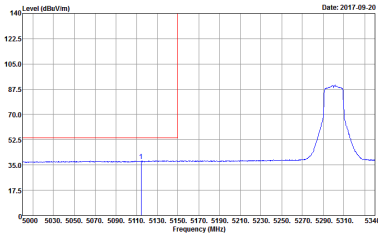

WIFI	Band 2 5250~5350MHz Band Edge @ 3m	
ANT	802.11ac VHT20 CH60 5300MHz - L	
1	Vertical	Fundamental
Peak	 <p>Site Condition : 03CH12-HY : PEAK_BE_74 3m HORN_9120D_1328 VERTICAL</p>	 <p>Site Condition : 03CH12-HY : PEAK_74 3m HORN_9120D_1328 VERTICAL</p>
Avg.	 <p>Site Condition : 03CH12-HY : AVG_BE_54 3m HORN_9120D_1328 VERTICAL</p>	Left blank



WIFI	Band 2 5250~5350MHz Band Edge @ 3m	
ANT	802.11ac VHT20 CH60 5300MHz - R	
1	Vertical	Fundamental
Peak	<p>Site Condition : 03CH12-HY : PEAK_BE_74 3m HORN_9120D_1328 VERTICAL</p>	Left blank
Avg.	<p>Site Condition : 03CH12-HY : AVG_BE_54 3m HORN_9120D_1328 VERTICAL</p>	Left blank



WIFI	Band 2 5250~5350MHz Band Edge @ 3m	
ANT	802.11ac VHT20 CH64 5320MHz	
1	Horizontal	Fundamental
Peak	<p>Site Condition : 03CH12-HY : PEAK_BE_74 3m HORN_9120D_1328 HORIZONTAL</p>	<p>Site Condition : 03CH12-HY : PEAK_74 3m HORN_9120D_1328 HORIZONTAL</p>
Avg.	<p>Site Condition : 03CH12-HY : AVG_BE_54 3m HORN_9120D_1328 HORIZONTAL</p>	Left blank



WIFI	Band 2 5250~5350MHz Band Edge @ 3m	
ANT	802.11ac VHT20 CH64 5320MHz	
1	Vertical	Fundamental
Peak	<p>Site Condition : 03CH12-HY : PEAK_BE_74 3m HORN_9120D_132B VERTICAL</p>	<p>Site Condition : 03CH12-HY : PEAK_74 3m HORN_9120D_132B VERTICAL</p>
Avg.	<p>Site Condition : 03CH12-HY : AVG_BE_54 3m HORN_9120D_132B VERTICAL</p>	Left blank

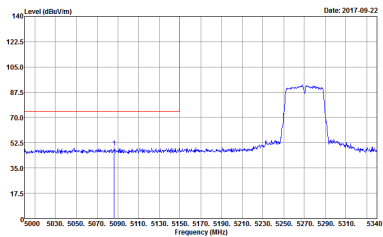
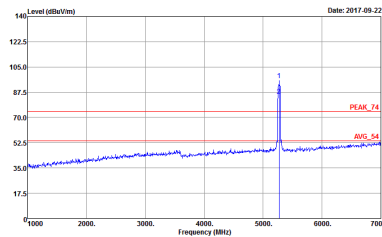
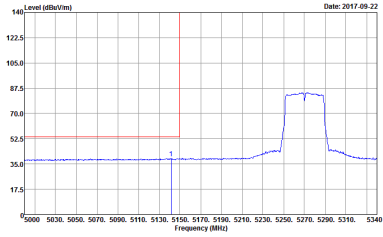

Band 2 5250~5350MHz
WIFI 802.11ac VHT40 (Band Edge @ 3m)

WIFI	Band 2 5250~5350MHz Band Edge @ 3m	
ANT	802.11ac VHT40 CH54 5270 MHz - L	
1	Horizontal	Fundamental
Peak	 <p>Site Condition : 03CH12-HY : PEAK_BE_74 3m HORN_9120D_1328 HORIZONTAL</p>	 <p>Site Condition : 03CH12-HY : PEAK_74 3m HORN_9120D_1328 HORIZONTAL</p>
Avg.	 <p>Site Condition : 03CH12-HY : AVG_BE_54 3m HORN_9120D_1328 HORIZONTAL</p>	Left blank

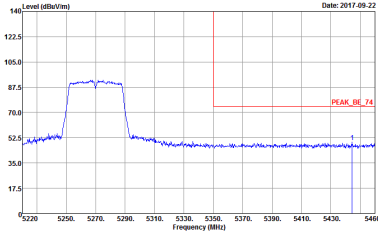
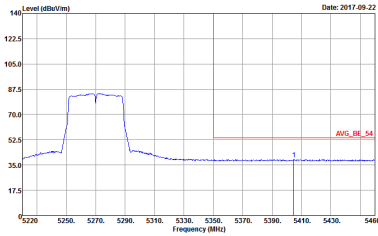

WIFI	Band 2 5250~5350MHz Band Edge @ 3m	
ANT	802.11ac VHT40 CH54 5270 MHz - R	
1	Horizontal	Fundamental
<p>Peak</p>	 <p>Site Condition : 03CH12-HY : PEAK_BE_74 3m HORN_9120D_1328 HORIZONTAL</p>	<p>Left blank</p>
<p>Avg.</p>	 <p>Site Condition : 03CH12-HY : AVG_BE_54 3m HORN_9120D_1328 HORIZONTAL</p>	<p>Left blank</p>



WIFI	Band 2 5250~5350MHz Band Edge @ 3m	
ANT	802.11ac VHT40 CH54 5270 MHz - L	
1	Vertical	Fundamental
Peak	<p>Site Condition : 03CH12-HY : PEAK_BE_74 3m HORN_9120D_1328 VERTICAL</p>	<p>Site Condition : 03CH12-HY : PEAK_74 3m HORN_9120D_1328 VERTICAL</p>
Avg.	<p>Site Condition : 03CH12-HY : AVG_BE_54 3m HORN_9120D_1328 VERTICAL</p>	Left blank



WIFI	Band 2 5250~5350MHz Band Edge @ 3m	
ANT	802.11ac VHT40 CH54 5270 MHz - R	
1	Vertical	Fundamental
Peak	<p>Site: 03CH12-HY Condition: PEAK_BE_74 3m HORN_9120D_1328 VERTICAL Date: 2017-09-22</p>	Left blank
Avg.	<p>Site: 03CH12-HY Condition: AVG_BE_54 3m HORN_9120D_1328 VERTICAL Date: 2017-09-22</p>	Left blank



WIFI	Band 2 5250~5350MHz Band Edge @ 3m	
ANT	802.11ac VHT40 CH62 5310 MHz - L	
1	Horizontal	Fundamental
Peak	<p>Site Condition : 03CH12-HY : PEAK_BE_74 3m HORN_9120D_1328 HORIZONTAL</p>	<p>Site Condition : 03CH12-HY : PEAK_74 3m HORN_9120D_1328 HORIZONTAL</p>
Avg.	<p>Site Condition : 03CH12-HY : AVG_BE_54 3m HORN_9120D_1328 HORIZONTAL</p>	Left blank

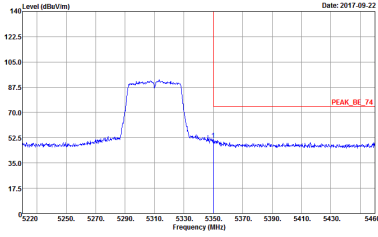
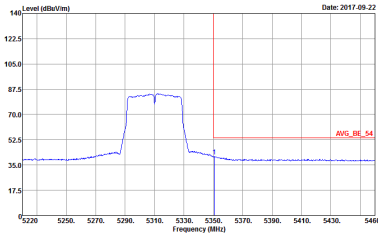

WIFI	Band 2 5250~5350MHz Band Edge @ 3m	
ANT	802.11ac VHT40 CH62 5310 MHz - R	
1	Horizontal	Fundamental
<p>Peak</p>	 <p>Site Condition : 03CH12-HY : PEAK_BE_74 3m HORN_9120D_1328 HORIZONTAL</p>	<p>Left blank</p>
<p>Avg.</p>	 <p>Site Condition : 03CH12-HY : AVG_BE_54 3m HORN_9120D_1328 HORIZONTAL</p>	<p>Left blank</p>



WIFI	Band 2 5250~5350MHz Band Edge @ 3m	
ANT	802.11ac VHT40 CH62 5310 MHz - L	
1	Vertical	Fundamental
Peak	<p>Site Condition : 03CH12-HY : PEAK_BE_74 3m HORN_9120D_1328 VERTICAL</p>	<p>Site Condition : 03CH12-HY : PEAK_74 3m HORN_9120D_1328 VERTICAL</p>
Avg.	<p>Site Condition : 03CH12-HY : AVG_BE_54 3m HORN_9120D_1328 VERTICAL</p>	Left blank

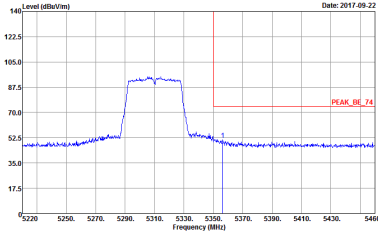
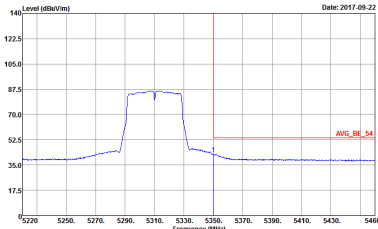

WIFI	Band 2 5250~5350MHz Band Edge @ 3m	
ANT	802.11ac VHT40 CH62 5310 MHz - R	
1	Vertical	Fundamental
Peak	 <p>Site Condition : 03CH12-HY : PEAK_BE_74 3m HORN_9120D_1328 VERTICAL</p>	Left blank
Avg.	 <p>Site Condition : 03CH12-HY : AVG_BE_54 3m HORN_9120D_1328 VERTICAL</p>	Left blank



Band 2 5250~5350MHz
WIFI 802.11ac VHT80 (Band Edge @ 3m)

WIFI	Band 2 5250~5350MHz Band Edge @ 3m	
ANT	802.11ac VHT80 CH58 5290MHz - L	
1	Horizontal	Fundamental
Peak	<p>Site Condition : 03CH12-HY : PEAK_BE_74 3m HORN_9120D_1328 HORIZONTAL</p>	<p>Site Condition : 03CH12-HY : PEAK_74 3m HORN_9120D_1328 HORIZONTAL</p>
Avg.	<p>Site Condition : 03CH12-HY : AVG_BE_54 3m HORN_9120D_1328 HORIZONTAL</p>	Left blank

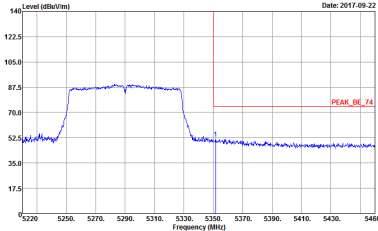
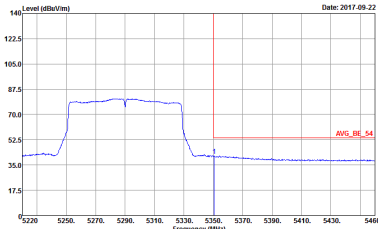

WIFI	Band 2 5250~5350MHz Band Edge @ 3m	
ANT	802.11ac VHT80 CH58 5290MHz - R	
1	Horizontal	Fundamental
<p>Peak</p>	 <p>Site Condition : 03CH12-HY : PEAK_BE_74 3m HORN_9120D_1328 HORIZONTAL</p>	<p>Left blank</p>
<p>Avg.</p>	 <p>Site Condition : 03CH12-HY : AVG_BE_54 3m HORN_9120D_1328 HORIZONTAL</p>	<p>Left blank</p>



WIFI	Band 2 5250~5350MHz Band Edge @ 3m	
ANT	802.11ac VHT80 CH58 5290MHz - L	
1	Vertical	Fundamental
Peak	<p>Site Condition : 03CH12-HY : PEAK_BE_74 3m HORN_9120D_1328 VERTICAL</p>	<p>Site Condition : 03CH12-HY : PEAK_74 3m HORN_9120D_1328 VERTICAL</p>
Avg.	<p>Site Condition : 03CH12-HY : AVG_BE_54 3m HORN_9120D_1328 VERTICAL</p>	Left blank



WIFI	Band 2 5250~5350MHz Band Edge @ 3m	
ANT	802.11ac VHT80 CH58 5290MHz - R	
1	Vertical	Fundamental
Peak	<p>Site Condition : 03CH12-HY : PEAK_BE_74 3m HORN_9120D_1328 VERTICAL</p>	Left blank
Avg.	<p>Site Condition : 03CH12-HY : AVG_BE_54 3m HORN_9120D_1328 VERTICAL</p>	Left blank



Band 2 - 5250~5350MHz
WIFI 802.11a (Harmonic @ 3m)

WIFI	Band 2 5250~5350MHz Harmonic @ 3m	
ANT	802.11a CH52 5260MHz	
1	Horizontal	Vertical
Peak Avg.	<p>Site Condition : 03C112-HY : PEAK_74 3m HORN_9120D_1328 HORIZONTAL</p>	<p>Site Condition : 03C112-HY : PEAK_74 3m HORN_9120D_1328 VERTICAL</p>



WIFI	Band 2 5250~5350MHz Harmonic @ 3m	
ANT	802.11a CH60 5300MHz	
1	Horizontal	Vertical
Peak Avg.	<p>Site Condition : 03CH12-HY : PEAK_74 3m HORN_9120D_1328 HORIZONTAL</p>	<p>Site Condition : 03CH12-HY : PEAK_74 3m HORN_9120D_1328 VERTICAL</p>



WIFI	Band 2 5250~5350MHz Harmonic @ 3m	
ANT	802.11a CH64 5320MHz	
1	Horizontal	Vertical
Peak Avg.	<p>Site Condition : 03CH12-HY : PEAK_74 3m HORN_9120D_1328 HORIZONTAL</p>	<p>Site Condition : 03CH12-HY : PEAK_74 3m HORN_9120D_1328 VERTICAL</p>



Band 2 5250~5350MHz
WIFI 802.11ac VHT20 (Harmonic @ 3m)

WIFI	Band 2 5250~5350MHz Harmonic @ 3m	
ANT	802.11ac VHT20 CH52 5260MHz	
1	Horizontal	Vertical
Peak Avg.	<p>Site Condition : 03CH12-HY : PEAK_74 3m HORN_9120D_1320 HORIZONTAL</p>	<p>Site Condition : 03CH12-HY : PEAK_74 3m HORN_9120D_1320 VERTICAL</p>



WIFI	Band 2 5250~5350MHz Harmonic @ 3m	
ANT	802.11ac VHT20 CH60 5300MHz	
1	Horizontal	Vertical
Peak Avg.	<p>Site Condition : 03CH12-HY : PEAK_74 3m HORN_9120D_1328 HORIZONTAL</p>	<p>Site Condition : 03CH12-HY : PEAK_74 3m HORN_9120D_1328 VERTICAL</p>



WIFI	Band 2 5250~5350MHz Harmonic @ 3m	
ANT	802.11ac VHT20 CH64 5320MHz	
1	Horizontal	Vertical
Peak Avg.	<p>Site Condition : 03CH12-HY : PEAK_74 3m HORN_9120D_1328 HORIZONTAL</p>	<p>Site Condition : 03CH12-HY : PEAK_74 3m HORN_9120D_1328 VERTICAL</p>



Band 2 5250~5350MHz
WIFI 802.11ac VHT40 (Harmonic @ 3m)

WIFI	Band 2 5250~5350MHz Harmonic @ 3m	
ANT	802.11ac VHT40 CH54 5270 MHz	
1	Horizontal	Vertical
Peak Avg.	<p>Site Condition : 03CH12-HY : PEAK_74 3m HORN_9120D_1320 HORIZONTAL</p>	<p>Site Condition : 03CH12-HY : PEAK_74 3m HORN_9120D_1320 VERTICAL</p>



WIFI	Band 2 5250~5350MHz Harmonic @ 3m	
ANT	802.11ac VHT40 CH62 5310 MHz	
1	Horizontal	Vertical
Peak Avg.	<p>Site Condition : 03CH12-HY : PEAK_74 3m HORN_9120D_1328 HORIZONTAL</p>	<p>Site Condition : 03CH12-HY : PEAK_74 3m HORN_9120D_1328 VERTICAL</p>



Band 2 5250~5350MHz
WIFI 802.11ac VHT80 (Harmonic @ 3m)

Table with 3 columns: WIFI, ANT, and 1. It contains two graphs: 'Horizontal' and 'Vertical'. Each graph plots Level (dBm/Vm) vs Frequency (MHz) with markers for PEAK_74 and AVG_54. The graphs show two distinct peaks at approximately 12.5 GHz and 15.0 GHz.



Band 3 - 5470~5725MHz
WIFI 802.11a (Band Edge @ 3m)

WIFI	Band 3 5470~5725MHz Band Edge @ 3m	
ANT	802.11a CH100 5500MHz	
1	Horizontal	Fundamental
Peak	<p>Site Condition : 03CH12-HY : PEAK_BE_74 3m HORN_9120D_1328 HORIZONTAL</p>	<p>Site Condition : 03CH12-HY : PEAK_74 3m HORN_9120D_1328 HORIZONTAL</p>
Avg.	<p>Site Condition : 03CH12-HY : AVG_BE_54 3m HORN_9120D_1328 HORIZONTAL</p>	Left blank



WIFI	Band 3 5470~5725MHz Band Edge @ 3m	
ANT	802.11a CH100 5500MHz	
1	Vertical	Fundamental
<p>Peak</p>	<p>Site Condition : 03CH12-HY : PEAK_BE_74 3m HORN_9120D_1328 VERTICAL</p>	<p>Site Condition : 03CH12-HY : PEAK_74 3m HORN_9120D_1328 VERTICAL</p>
<p>Avg.</p>	<p>Site Condition : 03CH12-HY : AVG_BE_54 3m HORN_9120D_1328 VERTICAL</p>	<p>Left blank</p>



WIFI	Band 3 5470~5725MHz Band Edge @ 3m	
ANT	802.11a CH116 5580MHz - L	
1	Horizontal	Fundamental
<p>Peak</p>	<p>Site Condition : 03CH12-HY : PEAK_BE_74 3m HORN_9120D_1328 HORIZONTAL</p>	<p>Site Condition : 03CH12-HY : PEAK_74 3m HORN_9120D_1328 HORIZONTAL</p>
<p>Avg.</p>	<p>Site Condition : 03CH12-HY : AVG_BE_54 3m HORN_9120D_1328 HORIZONTAL</p>	<p>Left blank</p>



WIFI	Band 3 5470~5725MHz Band Edge @ 3m	
ANT	802.11a CH116 5580MHz - R	
1	Horizontal	Fundamental
<p>Peak</p>	<p>Site Condition : 03CH12-HY : PEAK_BE_74 3m HORN_9120D_1328 HORIZONTAL</p>	<p>Left blank</p>
<p>Avg.</p>	<p>Site Condition : 03CH12-HY : AVG_BE_54 3m HORN_9120D_1328 HORIZONTAL</p>	<p>Left blank</p>



WIFI	Band 3 5470~5725MHz Band Edge @ 3m	
ANT	802.11a CH116 5580MHz - L	
1	Vertical	Fundamental
Peak	<p>Site Condition : 03CH12-HY : PEAK_BE_74 3m HORN_9120D_1328 VERTICAL</p>	<p>Site Condition : 03CH12-HY : PEAK_74 3m HORN_9120D_1328 VERTICAL</p>
Avg.	<p>Site Condition : 03CH12-HY : AVG_BE_54 3m HORN_9120D_1328 VERTICAL</p>	Left blank

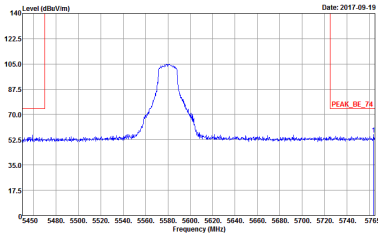
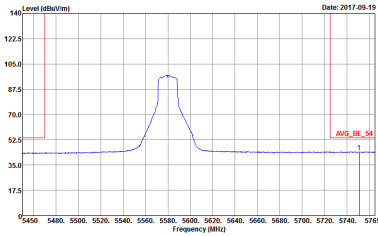

WIFI	Band 3 5470~5725MHz Band Edge @ 3m	
ANT	802.11a CH116 5580MHz - R	
1	Vertical	Fundamental
Peak	 <p>Site Condition : 03CH12-HY : PEAK_BE_74 3m HORN_9120D_132B VERTICAL</p>	Left blank
Avg.	 <p>Site Condition : 03CH12-HY : AVG_BE_54 3m HORN_9120D_132B VERTICAL</p>	Left blank



WIFI	Band 3 5470~5725MHz Band Edge @ 3m	
ANT	802.11a CH140 5700MHz	
1	Horizontal	Fundamental
Peak	<p>Site Condition : 03CH12-HY : PEAK_BE_74 3m HORN_9120D_1328 HORIZONTAL</p>	<p>Site Condition : 03CH12-HY : PEAK_74 3m HORN_9120D_1328 HORIZONTAL</p>
Avg.	<p>Site Condition : 03CH12-HY : AVG_BE_54 3m HORN_9120D_1328 HORIZONTAL</p>	Left blank



WIFI	Band 3 5470~5725MHz Band Edge @ 3m	
ANT	802.11a CH140 5700MHz	
1	Vertical	Fundamental
Peak	<p>Site Condition : 03CH12-HY : PEAK_BE_74 3m HORN_9120D_1328 VERTICAL</p>	<p>Site Condition : 03CH12-HY : PEAK_74 3m HORN_9120D_1328 VERTICAL</p>
Avg.	<p>Site Condition : 03CH12-HY : AVG_BE_54 3m HORN_9120D_1328 VERTICAL</p>	Left blank



Band 3 5470~5725MHz
WIFI 802.11ac VHT20 (Band Edge @ 3m)

Table with 2 columns (WIFI, ANT) and 2 rows (Peak, Avg.). It contains spectral plots for Horizontal and Fundamental signals, and a 'Left blank' label for the Avg. Fundamental plot. Each plot shows Level (dBuV/m) vs Frequency (MHz) with specific site conditions.



WIFI	Band 3 5470~5725MHz Band Edge @ 3m	
ANT	802.11ac VHT20 CH100 5500MHz	
1	Vertical	Fundamental
Peak	<p>Site Condition : 03CH12-HY : PEAK_BE_74 3m HORN_9120D_132B VERTICAL</p>	<p>Site Condition : 03CH12-HY : PEAK_74 3m HORN_9120D_132B VERTICAL</p>
Avg.	<p>Site Condition : 03CH12-HY : AVG_BE_54 3m HORN_9120D_132B VERTICAL</p>	Left blank



WIFI	Band 3 5470~5725MHz Band Edge @ 3m	
ANT	802.11ac VHT20 CH116 5580MHz - L	
1	Horizontal	Fundamental
Peak	<p>Site Condition : 03CH12-HY : PEAK_BE_74 3m HORN_9120D_1328 HORIZONTAL</p>	<p>Site Condition : 03CH12-HY : PEAK_74 3m HORN_9120D_1328 HORIZONTAL</p>
Avg.	<p>Site Condition : 03CH12-HY : AVG_BE_54 3m HORN_9120D_1328 HORIZONTAL</p>	Left blank



WIFI	Band 3 5470~5725MHz Band Edge @ 3m	
ANT	802.11ac VHT20 CH116 5580MHz - R	
1	Horizontal	Fundamental
<p>Peak</p>	<p>Site : 03CH12-HY Condition : PEAK_BE_74 3m HORN_9120D_1328 HORIZONTAL</p>	<p>Left blank</p>
<p>Avg.</p>	<p>Site : 03CH12-HY Condition : AVG_BE_54 3m HORN_9120D_1328 HORIZONTAL</p>	<p>Left blank</p>



WIFI	Band 3 5470~5725MHz Band Edge @ 3m	
ANT	802.11ac VHT20 CH116 5580MHz - L	
1	Vertical	Fundamental
Peak		
Avg.		Left blank



WIFI	Band 3 5470~5725MHz Band Edge @ 3m	
ANT	802.11ac VHT20 CH116 5580MHz - R	
1	Vertical	Fundamental
Peak	<p>Site Condition : 03CH12-HY : PEAK_BE_74 3m HORN_9120D_1328 VERTICAL</p>	Left blank
Avg.	<p>Site Condition : 03CH12-HY : AVG_BE_54 3m HORN_9120D_1328 VERTICAL</p>	Left blank



WIFI	Band 3 5470~5725MHz Band Edge @ 3m	
ANT	802.11ac VHT20 CH140 5700MHz	
1	Horizontal	Fundamental
Peak		
Avg.		Left blank



WIFI	Band 3 5470~5725MHz Band Edge @ 3m	
ANT	802.11ac VHT20 CH140 5700MHz	
1	Vertical	Fundamental
Peak	<p>Site Condition : 03CH12-HY : PEAK_BE_74 3m HORN_9120D_1328 VERTICAL</p>	<p>Site Condition : 03CH12-HY : PEAK_74 3m HORN_9120D_1328 VERTICAL</p>
Avg.	<p>Site Condition : 03CH12-HY : AVG_BE_54 3m HORN_9120D_1328 VERTICAL</p>	Left blank



**Band 3 5470~5725MHz
WIFI 802.11ac VHT40 (Band Edge @ 3m)**

WIFI	Band 3 5470~5725MHz Band Edge @ 3m	
ANT	802.11ac VHT40 CH102 5510MHz - L	
1	Horizontal	Fundamental
Peak	<p>Site Condition : 03CH12-HY : PEAK_BE_74 3m HORN_9120D_132B HORIZONTAL</p>	<p>Site Condition : 03CH12-HY : PEAK_74 3m HORN_9120D_132B HORIZONTAL</p>
Avg.	<p>Site Condition : 03CH12-HY : AVG_BE_54 3m HORN_9120D_132B HORIZONTAL</p>	Left blank



WIFI	Band 3 5470~5725MHz Band Edge @ 3m	
ANT	802.11ac VHT40 CH102 5510MHz - R	
1	Horizontal	Fundamental
Peak	<p>Site Condition : 03CH12-HY : PEAK_BE_74 3m HORN_9120D_132B HORIZONTAL</p>	Left blank
Avg.	<p>Site Condition : 03CH12-HY : AVG_BE_54 3m HORN_9120D_132B HORIZONTAL</p>	Left blank



WIFI	Band 3 5470~5725MHz Band Edge @ 3m	
ANT	802.11ac VHT40 CH102 5510MHz - L	
1	Vertical	Fundamental
Peak	<p>Site Condition : 03CH12-HY : PEAK_BE_74 3m HORN_9120D_1328 VERTICAL</p>	<p>Site Condition : 03CH12-HY : PEAK_74 3m HORN_9120D_1328 VERTICAL</p>
Avg.	<p>Site Condition : 03CH12-HY : AVG_BE_54 3m HORN_9120D_1328 VERTICAL</p>	Left blank



WIFI	Band 3 5470~5725MHz Band Edge @ 3m	
ANT	802.11ac VHT40 CH102 5510MHz - R	
1	Vertical	Fundamental
Peak	<p>Site Condition : 03CH12-HY : PEAK_BE_74 3m HORN_9120D_132B VERTICAL</p>	Left blank
Avg.	<p>Site Condition : 03CH12-HY : AVG_BE_54 3m HORN_9120D_132B VERTICAL</p>	Left blank



WIFI	Band 3 5470~5725MHz Band Edge @ 3m	
ANT	802.11ac VHT40 CH110 5550MHz - L	
1	Horizontal	Fundamental
<p>Peak</p>	<p>Site Condition : 03CH12-HY : PEAK_BE_74 3m HORN_9120D_1328 HORIZONTAL</p>	<p>Site Condition : 03CH12-HY : PEAK_74 3m HORN_9120D_1328 HORIZONTAL</p>
<p>Avg.</p>	<p>Site Condition : 03CH12-HY : AVG_BE_54 3m HORN_9120D_1328 HORIZONTAL</p>	<p>Left blank</p>



WIFI	Band 3 5470~5725MHz Band Edge @ 3m	
ANT	802.11ac VHT40 CH110 5550MHz - R	
1	Horizontal	Fundamental
<p>Peak</p>	<p>Site Condition : 03CH12-HY : PEAK_BE_74 3m HORN_9120D_1328 HORIZONTAL</p>	<p>Left blank</p>
<p>Avg.</p>	<p>Site Condition : 03CH12-HY : AVG_BE_54 3m HORN_9120D_1328 HORIZONTAL</p>	<p>Left blank</p>



WIFI	Band 3 5470~5725MHz Band Edge @ 3m	
ANT	802.11ac VHT40 CH110 5550MHz - L	
1	Vertical	Fundamental
<p>Peak</p>	<p>Site Condition : 03CH12-HY : PEAK_BE_74 3m HORN_9120D_1328 VERTICAL</p>	<p>Site Condition : 03CH12-HY : PEAK_74 3m HORN_9120D_1328 VERTICAL</p>
<p>Avg.</p>	<p>Site Condition : 03CH12-HY : AVG_BE_54 3m HORN_9120D_1328 VERTICAL</p>	<p>Left blank</p>

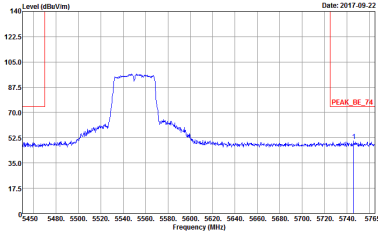
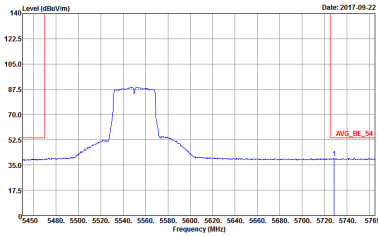

WIFI	Band 3 5470~5725MHz Band Edge @ 3m	
ANT	802.11ac VHT40 CH110 5550MHz - R	
1	Vertical	Fundamental
Peak	 <p data-bbox="432 763 687 786">Site Condition : 03CH12-HY : PEAK_BE_74 3m HORN_9120D_132B VERTICAL</p>	Left blank
Avg.	 <p data-bbox="432 1440 687 1462">Site Condition : 03CH12-HY : AVG_BE_54 3m HORN_9120D_132B VERTICAL</p>	Left blank

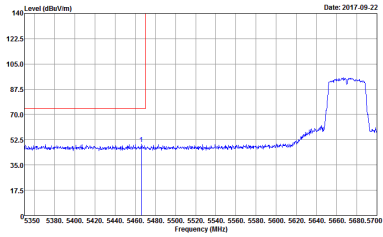
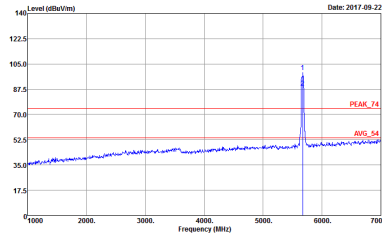
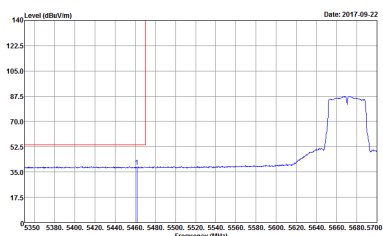

WIFI	Band 3 5470~5725MHz Band Edge @ 3m	
ANT	802.11ac VHT40 CH134 5670MHz - L	
1	Horizontal	Fundamental
<p>Peak</p>	 <p>Site Condition : 03CH12-HY : PEAK_BE_74 3m HORN_9120D_1328 HORIZONTAL</p>	 <p>Site Condition : 03CH12-HY : PEAK_74 3m HORN_9120D_1328 HORIZONTAL</p>
<p>Avg.</p>	 <p>Site Condition : 03CH12-HY : AVG_BE_54 3m HORN_9120D_1328 HORIZONTAL</p>	<p>Left blank</p>



WIFI	Band 3 5470~5725MHz Band Edge @ 3m	
ANT	802.11ac VHT40 CH134 5670MHz - R	
1	Horizontal	Fundamental
Peak	<p>Site Condition : 03CH12-HY : PEAK_BE_74 3m HORN_9120D_1328 HORIZONTAL</p>	Left blank
Avg.	<p>Site Condition : 03CH12-HY : AVG_BE_54 3m HORN_9120D_1328 HORIZONTAL</p>	Left blank



WIFI	Band 3 5470~5725MHz Band Edge @ 3m	
ANT	802.11ac VHT40 CH134 5670MHz - L	
1	Vertical	Fundamental
Peak	<p>Site Condition : 03CH12-HY : PEAK_BE_74 3m HORN_9120D_132B VERTICAL</p>	<p>Site Condition : 03CH12-HY : PEAK_74 3m HORN_9120D_132B VERTICAL</p>
Avg.	<p>Site Condition : 03CH12-HY : AVG_BE_54 3m HORN_9120D_132B VERTICAL</p>	Left blank



WIFI	Band 3 5470~5725MHz Band Edge @ 3m	
ANT	802.11ac VHT40 CH134 5670MHz - R	
1	Vertical	Fundamental
Peak	<p>Site Condition : 03CH12-HY : PEAK_BE_74 3m HORN_9120D_132B VERTICAL</p>	Left blank
Avg.	<p>Site Condition : 03CH12-HY : AVG_BE_54 3m HORN_9120D_132B VERTICAL</p>	Left blank



Band 3 5470~5725MHz
WIFI 802.11ac VHT80 (Band Edge @ 3m)

Table with 2 columns (WIFI, ANT) and 2 rows (Peak, Avg.). It contains spectral plots for Horizontal and Fundamental signals, and a 'Left blank' label for the Avg. Fundamental plot.



WIFI	Band 3 5470~5725MHz Band Edge @ 3m	
ANT	802.11ac VHT80 CH106 5530MHz - R	
1	Horizontal	Fundamental
Peak	<p>Peak</p>	Left blank
Avg.	<p>Avg.</p>	Left blank



WIFI	Band 3 5470~5725MHz Band Edge @ 3m	
ANT	802.11ac VHT80 CH106 5530MHz - L	
1	Vertical	Fundamental
Peak	<p>Site Condition : 03CH12-HY : PEAK_BE_74 3m HORN_9120D_1328 VERTICAL</p>	<p>Site Condition : 03CH12-HY : PEAK_74 3m HORN_9120D_1328 VERTICAL</p>
Avg.	<p>Site Condition : 03CH12-HY : AVG_BE_54 3m HORN_9120D_1328 VERTICAL</p>	Left blank

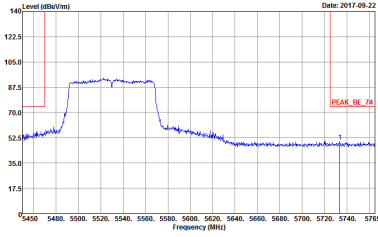
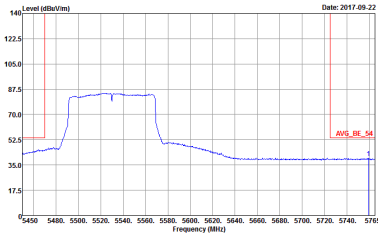

WIFI	Band 3 5470~5725MHz Band Edge @ 3m	
ANT	802.11ac VHT80 CH106 5530MHz - R	
1	Vertical	Fundamental
Peak	 <p>Site Condition : 03CH12-HY : PEAK_BE_74 3m HORN_9120D_132B VERTICAL</p>	Left blank
Avg.	 <p>Site Condition : 03CH12-HY : AVG_BE_54 3m HORN_9120D_132B VERTICAL</p>	Left blank

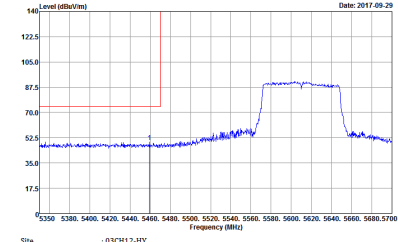
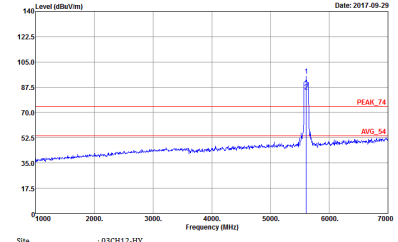
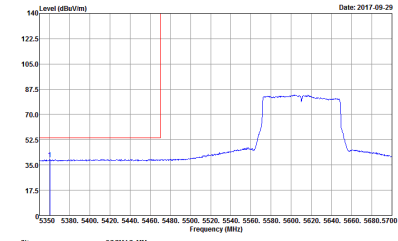

WIFI	Band 3 5470~5725MHz Band Edge @ 3m	
ANT	802.11ac VHT80 CH122 5610MHz - L	
1	Horizontal	Fundamental
Peak	 <p>Site Condition : 03CH12-HY : PEAK_BE_74 3m HORN_9120D_1328 HORIZONTAL</p>	 <p>Site Condition : 03CH12-HY : PEAK_74 3m HORN_9120D_1328 HORIZONTAL</p>
Avg.	 <p>Site Condition : 03CH12-HY : AVG_BE_54 3m HORN_9120D_1328 HORIZONTAL</p>	Left blank

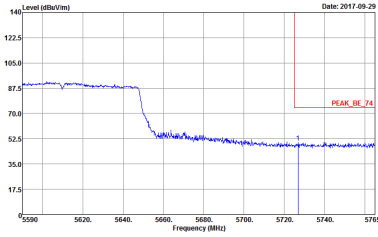
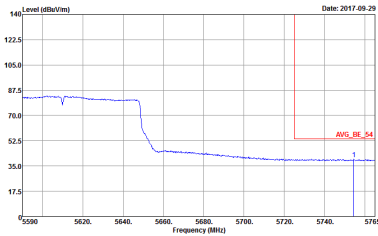

WIFI	Band 3 5470~5725MHz Band Edge @ 3m	
ANT	802.11ac VHT80 CH122 5610MHz - R	
1	Horizontal	Fundamental
<p>Peak</p>	 <p>Site Condition : 03CH12-HY : PEAK_BE_74 3m HORN_9120D_1328 HORIZONTAL</p>	<p>Left blank</p>
<p>Avg.</p>	 <p>Site Condition : 03CH12-HY : AVG_BE_54 3m HORN_9120D_1328 HORIZONTAL</p>	<p>Left blank</p>

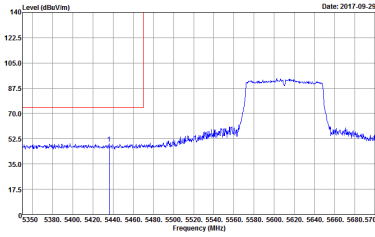
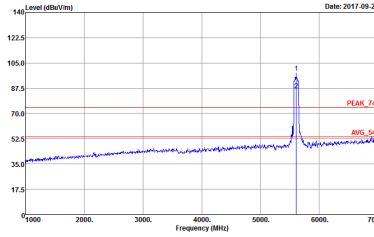
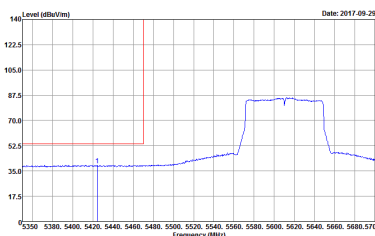

WIFI	Band 3 5470~5725MHz Band Edge @ 3m	
ANT	802.11ac VHT80 CH122 5610MHz - L	
1	Vertical	Fundamental
<p>Peak</p>	 <p>Date: 2017-09-29</p> <p>Site Condition : 03CH12-HY : PEAK_BE_74 3m HORN_9120D_1328 VERTICAL</p>	 <p>Date: 2017-09-29</p> <p>Site Condition : 03CH12-HY : PEAK_F4 3m HORN_9120D_1328 VERTICAL</p>
<p>Avg.</p>	 <p>Date: 2017-09-29</p> <p>Site Condition : 03CH12-HY : AVG_BE_54 3m HORN_9120D_1328 VERTICAL</p>	<p>Left blank</p>



WIFI	Band 3 5470~5725MHz Band Edge @ 3m	
ANT	802.11ac VHT80 CH122 5610MHz - R	
1	Vertical	Fundamental
Peak	<p>Site Condition : 03CH12-HY : PEAK_BE_74 3m HORN_9120D_1328 VERTICAL</p>	Left blank
Avg.	<p>Site Condition : 03CH12-HY : AVG_BE_54 3m HORN_9120D_1328 VERTICAL</p>	Left blank



Band 3 - 5470~5725MHz
WIFI 802.11a (Harmonic @ 3m)

WIFI	Band 3 5470~5725MHz Harmonic @ 3m	
ANT	802.11a CH100 5500MHz	
1	Horizontal	Vertical
Peak Avg.	<p>Site Condition : 03C112-HY : PEAK_74 3m HORN_9120D_1328 HORIZONTAL</p>	<p>Site Condition : 03C112-HY : PEAK_74 3m HORN_9120D_1328 VERTICAL</p>



WIFI	Band 3 5470~5725MHz Harmonic @ 3m	
ANT	802.11a CH116 5580MHz	
1	Horizontal	Vertical
Peak Avg.	<p>Site Condition : 03CH12-HY : PEAK_74 3m HORN_9120D_1328 HORIZONTAL</p>	<p>Site Condition : 03CH12-HY : PEAK_74 3m HORN_9120D_1328 VERTICAL</p>



WIFI	Band 3 5470~5725MHz Harmonic @ 3m	
ANT	802.11a CH140 5700MHz	
1	Horizontal	Vertical
Peak Avg.	<p>Site Condition : 03CH12-HY : PEAK,74 3m HORN_9120D_1328 HORIZONTAL</p>	<p>Site Condition : 03CH12-HY : PEAK,74 3m HORN_9120D_1328 VERTICAL</p>



Band 3 5470~5725MHz
WIFI 802.11ac VHT20 (Harmonic @ 3m)

WIFI	Band 3 5470~5725MHz Harmonic @ 3m	
ANT	802.11ac VHT20 CH100 5500MHz	
1	Horizontal	Vertical
Peak Avg.	<p>Site Condition : 03CH12-HY : PEAK_74 3m HORN_9120D_1320 HORIZONTAL</p>	<p>Site Condition : 03CH12-HY : PEAK_74 3m HORN_9120D_1320 VERTICAL</p>

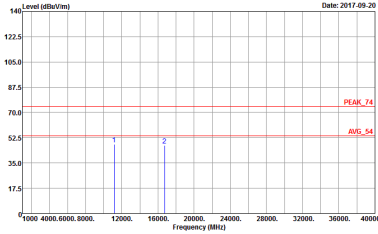
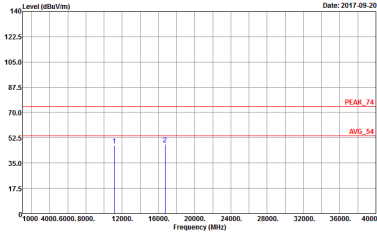

WIFI	Band 3 5470~5725MHz Harmonic @ 3m	
ANT	802.11ac VHT20 CH116 5580MHz	
1	Horizontal	Vertical
Peak Avg.	 <p>Site Condition : 03CH12-HY : PEAK_74 3m HORN_9120D_1328 HORIZONTAL</p>	 <p>Site Condition : 03CH12-HY : PEAK_74 3m HORN_9120D_1328 VERTICAL</p>

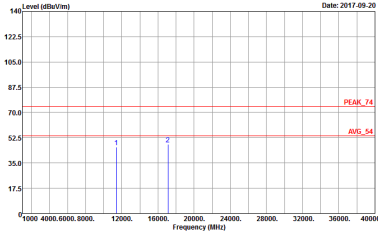
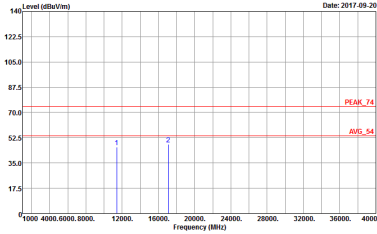

WIFI	Band 3 5470~5725MHz Harmonic @ 3m	
ANT	802.11ac VHT20 CH140 5700MHz	
1	Horizontal	Vertical
Peak Avg.	 <p>Site Condition : 03CH12-HY : PEAK_74 3m HORN_9120D_1328 HORIZONTAL</p>	 <p>Site Condition : 03CH12-HY : PEAK_74 3m HORN_9120D_1328 VERTICAL</p>



Band 3 5470~5725MHz
WIFI 802.11ac VHT40 (Harmonic @ 3m)

Table with 3 columns: WIFI, ANT, and measurement results for Horizontal and Vertical orientations. Includes two graphs showing Level (dBm/Vm) vs Frequency (MHz) with peak and average values.



WIFI	Band 3 5470~5725MHz Harmonic @ 3m	
ANT	802.11ac VHT40 CH110 5550MHz	
1	Horizontal	Vertical
Peak Avg.	<p>Site Condition : 03CH12-HY : PEAK_74 3m HORN_9120D_1328 HORIZONTAL</p>	<p>Site Condition : 03CH12-HY : PEAK_74 3m HORN_9120D_1328 VERTICAL</p>



WIFI	Band 3 5470~5725MHz Harmonic @ 3m	
ANT	802.11ac VHT40 CH134 5670MHz	
1	Horizontal	Vertical
Peak Avg.	<p>Site Condition : 03CH12-HY : PEAK,74 3m HORN_9120D_1328 HORIZONTAL</p>	<p>Site Condition : 03CH12-HY : PEAK,74 3m HORN_9120D_1328 VERTICAL</p>



Band 3 5470~5725MHz
WIFI 802.11ac VHT80 (Harmonic @ 3m)

Table with 3 columns: WIFI, ANT, and 1. It contains two graphs: Horizontal and Vertical. Each graph shows Level (dBm/Vm) vs Frequency (MHz) with peaks labeled 1 and 2, and limits labeled PEAK_74 and AVG_54. Site Condition: 03CH12-HY : PEAK_74 3m HORN_9120D_1320 HORIZONTAL / VERTICAL.

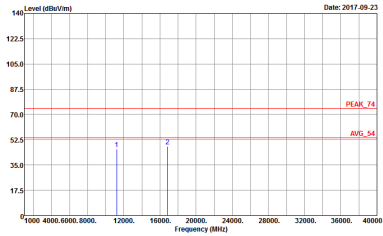
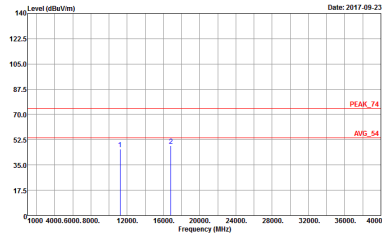

WIFI	Band 3 5470~5725MHz Harmonic @ 3m	
ANT	802.11ac VHT80 CH122 5610MHz	
1	Horizontal	Vertical
Peak Avg.	 <p>Site Condition : 03CH12-HY : PEAK_74 3m HORN_9120D_1328 HORIZONTAL</p>	 <p>Site Condition : 03CH12-HY : PEAK_74 3m HORN_9120D_1328 VERTICAL</p>



Band 3 - Straddle Channel
WIFI 802.11a (Fundamental @ 3m)

WIFI	Band 3 Straddle Channel Fundamental @ 3m	
ANT	802.11a CH144 5720MHz	
1	Horizontal	Vertical
Peak Avg.	<p>Site: 03C112-HY Condition: PEAK_74 3m HORN_9120D_1328 HORIZONTAL</p>	<p>Site: 03C112-HY Condition: PEAK_74 3m HORN_9120D_1328 VERTICAL</p>

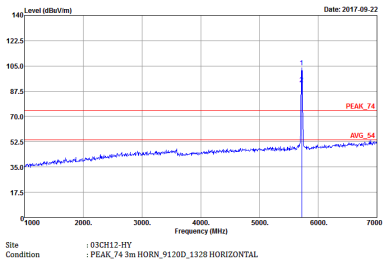
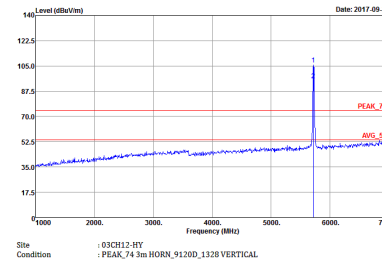

Band 3 – Straddle Channel
WIFI 802.11ac VHT20 (Fundamental @ 3m)

WIFI	Band 3 Straddle Channel Fundamental @ 3m	
ANT	802.11ac VHT20 CH144 5720MHz	
1	Horizontal	Vertical
Peak Avg.	 <p>Site Condition : 03CH12-HY : PEAK_74 3m HORN_9120D_1320 HORIZONTAL</p>	 <p>Site Condition : 03CH12-HY : PEAK_74 3m HORN_9120D_1320 VERTICAL</p>



**Band 3 – Straddle Channel
WIFI 802.11ac VHT40 (Fundamental @ 3m)**

WIFI	Band 3 Straddle Channel Fundamental @ 3m	
ANT	802.11ac VHT40 CH142 5710MHz	
1	Horizontal	Vertical
Peak Avg.	<p>Site Condition : 03CH12-HY : PEAK_74 3m HORN_9120D_1328 HORIZONTAL</p>	<p>Site Condition : 03CH12-HY : PEAK_74 3m HORN_9120D_1328 VERTICAL</p>



**Band 3 – Straddle Channel
WIFI 802.11ac VHT80 (Fundamental @ 3m)**

WIFI	Band 3 Straddle Channel Fundamental @ 3m	
ANT	802.11ac VHT80 CH138 5690MHz	
1	Horizontal	Vertical
Peak Avg.		



Band 3 - Straddle Channel
WIFI 802.11a (Harmonic @ 3m)

WIFI	Band 3 Straddle Channel Harmonic @ 3m	
ANT	802.11a CH144 5720MHz	
1	Horizontal	Vertical
Peak Avg.	<p>Site Condition : 03C112-HY : PEAK_74 3m HORN_9120D_1328 HORIZONTAL</p>	<p>Site Condition : 03C112-HY : PEAK_74 3m HORN_9120D_1328 VERTICAL</p>



**Band 3 – Straddle Channel
WIFI 802.11ac VHT20 (Harmonic @ 3m)**

WIFI	Band 3 Straddle Channel Harmonic @ 3m	
ANT	802.11ac VHT20 CH144 5720MHz	
1	Horizontal	Vertical
Peak Avg.	<p>Site Condition : 03CH12-HY : PEAK_74 3m HORN_9120D_1320 HORIZONTAL</p>	<p>Site Condition : 03CH12-HY : PEAK_74 3m HORN_9120D_1320 VERTICAL</p>



Band 3 – Straddle Channel
WIFI 802.11ac VHT40 (Harmonic @ 3m)

WIFI	Band 3 Straddle Channel Harmonic @ 3m	
ANT	802.11ac VHT40 CH142 5710MHz	
1	Horizontal	Vertical
Peak Avg.	<p>Site Condition : 03CH12-HY : PEAK_74 3m HORN_9120D_1328 HORIZONTAL</p>	<p>Site Condition : 03CH12-HY : PEAK_74 3m HORN_9120D_1328 VERTICAL</p>



**Band 3 – Straddle Channel
WIFI 802.11ac VHT80 (Harmonic @ 3m)**

WIFI	Band 3 Straddle Channel Harmonic @ 3m	
ANT	802.11ac VHT80 CH138 5690MHz	
1	Horizontal	Vertical
Peak Avg.	<p>Site Condition : 03CH12-HY : PEAK_74 3m HORN_9120D_1328 HORIZONTAL</p>	<p>Site Condition : 03CH12-HY : PEAK_74 3m HORN_9120D_1328 VERTICAL</p>



Emission below 1GHz
5GHz WIFI 802.11a (LF)

WIFI	5GHz WIFI	
ANT	802.11a LF	
1	Horizontal	Vertical
QP / Peak	<p>Site : 03CH12-RY Condition : QP 3m BILOG_6111D_37059 HORIZONTAL</p>	<p>Site : 03CH12-RY Condition : QP 3m BILOG_6111D_37059 VERTICAL</p>



Appendix E. Duty Cycle Plots

Band	Duty Cycle(%)	T(us)	1/T(kHz)	VBW Setting	Duty Factor(dB)
802.11a	93.55	2030	0.49	1kHz	0.29
5GHz 802.11ac VHT20	93.17	1910	0.52	1kHz	0.31
5GHz 802.11ac VHT40	87.85	933	1.07	3kHz	0.56
5GHz 802.11ac VHT80	87.65	852	1.17	3kHz	0.57



802.11a

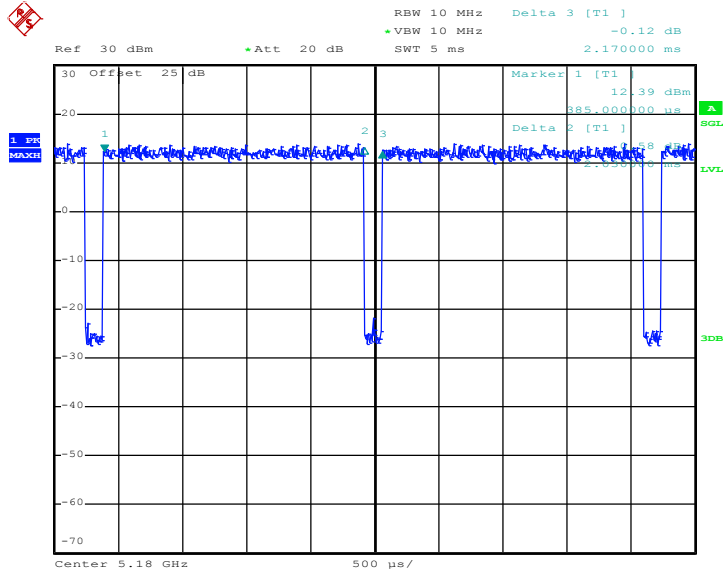

Date: 10.AUG.2017 16:58:22

802.11ac VHT20

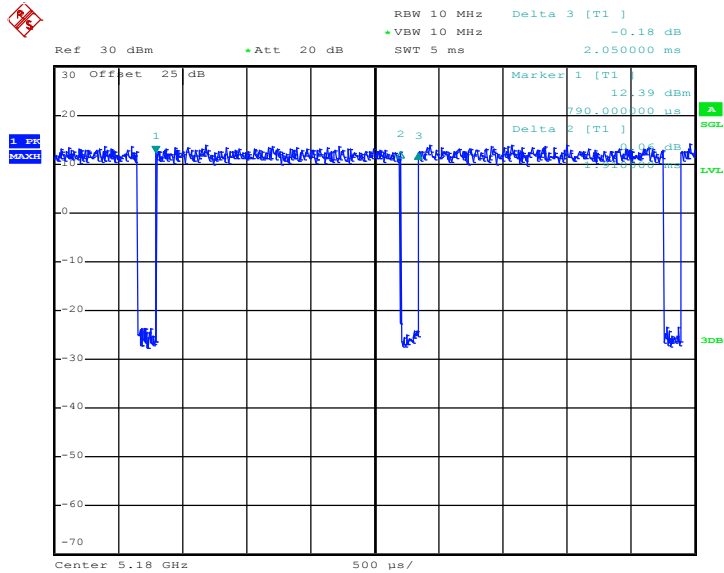

Date: 10.AUG.2017 17:03:50



802.11ac VHT40

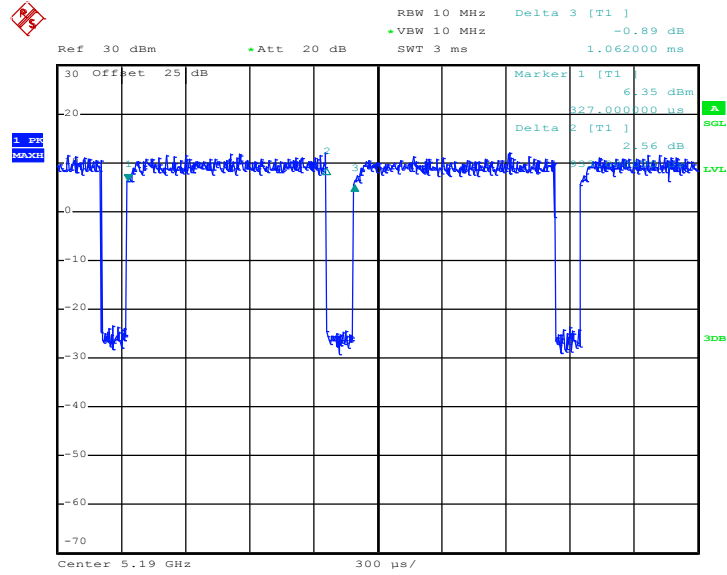

Date: 10.AUG.2017 17:09:49

802.11ac VHT80

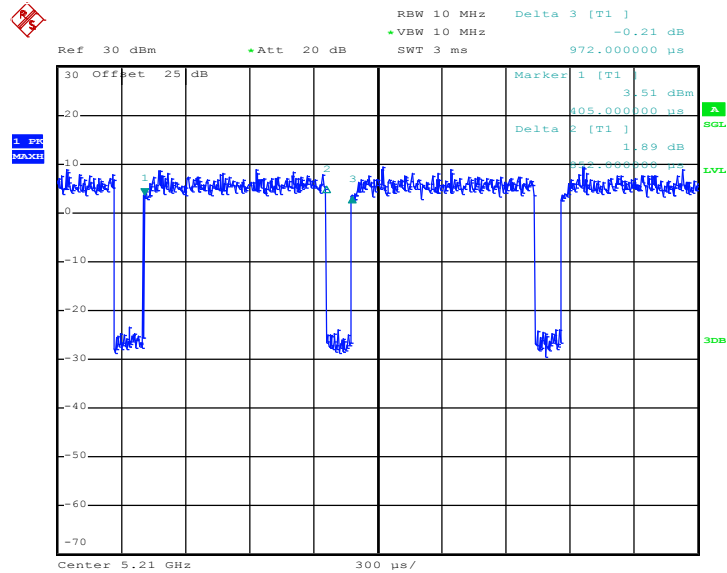

Date: 10.AUG.2017 17:12:25