



FCC RF Test Report

APPLICANT : Sony Mobile Communications Inc.
EQUIPMENT : GSM/WCDMA/LTE Phone+Bluetooth,
DTS/UNII a/b/g/n/ac and NFC
BRAND NAME : Sony
FCC ID : PY7-08608T
STANDARD : FCC Part 15 Subpart C §15.247
CLASSIFICATION : (DTS) Digital Transmission System

The product was received on Jun. 07, 2017 and testing was completed on Oct. 03, 2017. We, SPORTON INTERNATIONAL INC., would like to declare that the tested sample has been evaluated in accordance with the test procedures and has been in compliance with the applicable technical standards.

The test results in this report apply exclusively to the tested model / sample. Without written approval of SPORTON INTERNATIONAL INC., the test report shall not be reproduced except in full.

Reviewed by: Joseph Lin / Supervisor

Approved by: Jones Tsai / Manager



SPORTON INTERNATIONAL INC.

No. 52, Hwa Ya 1st Rd., Hwa Ya Technology Park, Kwei-Shan District, Tao Yuan City, Taiwan, R.O.C.



TABLE OF CONTENTS

REVISION HISTORY.....3

SUMMARY OF TEST RESULT4

1 GENERAL DESCRIPTION5

 1.1 Applicant5

 1.2 Manufacturer.....5

 1.3 Product Feature of Equipment Under Test.....5

 1.4 Modification of EUT6

 1.5 Testing Location7

 1.6 Applicable Standards.....7

2 TEST CONFIGURATION OF EQUIPMENT UNDER TEST8

 2.1 Carrier Frequency and Channel8

 2.2 Test Mode.....9

 2.3 Connection Diagram of Test System.....10

 2.4 Support Unit used in test configuration and system11

 2.5 EUT Operation Test Setup11

 2.6 Measurement Results Explanation Example.....11

3 TEST RESULT.....12

 3.1 6dB and 99% Bandwidth Measurement12

 3.2 Output Power Measurement.....14

 3.3 Power Spectral Density Measurement15

 3.4 Conducted Band Edges and Spurious Emission Measurement17

 3.5 Radiated Band Edges and Spurious Emission Measurement27

 3.6 AC Conducted Emission Measurement.....31

 3.7 Antenna Requirements33

4 LIST OF MEASURING EQUIPMENT34

5 UNCERTAINTY OF EVALUATION.....36

APPENDIX A. CONDUCTED TEST RESULTS

APPENDIX B. AC CONDUCTED EMISSION TEST RESULT

APPENDIX C. RADIATED SPURIOUS EMISSION

APPENDIX D. RADIATED SPURIOUS EMISSION PLOTS

APPENDIX E. DUTY CYCLE PLOTS



REVISION HISTORY

REPORT NO.	VERSION	DESCRIPTION	ISSUED DATE
FR760710-01C	Rev. 01	Initial issue of report	Oct. 24, 2017
FR760710-01C	Rev. 02	Add FCC designation No. in section 1.5.	Oct. 26, 2017



SUMMARY OF TEST RESULT

Report Section	FCC Rule	Description	Limit	Result	Remark
3.1	15.247(a)(2)	6dB Bandwidth	$\geq 0.5\text{MHz}$	Pass	-
3.1	-	99% Bandwidth	-	Pass	-
3.2	15.247(b)	Power Output Measurement	$\leq 30\text{dBm}$	Pass	-
3.3	15.247(e)	Power Spectral Density	$\leq 8\text{dBm}/3\text{kHz}$	Pass	-
3.4	15.247(d)	Conducted Band Edges	$\leq 20\text{dBc}$	Pass	-
		Conducted Spurious Emission		Pass	-
3.5	15.247(d)	Radiated Band Edges and Radiated Spurious Emission	15.209(a) & 15.247(d)	Pass	Under limit 9.74 dB at 2390.000 MHz
3.6	15.207	AC Conducted Emission	15.207(a)	Pass	Under limit 14.00 dB at 0.150 MHz,
3.7	15.203 & 15.247(b)	Antenna Requirement	N/A	Pass	-



1 General Description

1.1 Applicant

Sony Mobile Communications Inc.

4-12-3 Higashi-Shinagawa, Shinagawa-ku, Tokyo, 140-0002, Japan

1.2 Manufacturer

Sony Mobile Communications Inc.

4-12-3 Higashi-Shinagawa, Shinagawa-ku, Tokyo, 140-0002, Japan

1.3 Product Feature of Equipment Under Test

GSM/WCDMA/LTE, Bluetooth, DTS/UNII a/b/g/n/ac, FM Receiver, NFC, and GPS.

Product Specification subjective to this standard	
Antenna Type / Gain	PIFA Antenna type with gain -1.60 dBi

EUT Information List			
HW Version	SW Version	S/N	Performed Test Item
A	1.14	RQ3005UYBC	RF conducted measurement
		RQ3005VVKR	Radiated Spurious Emission
		CQ300000EL	AC Conducted Emission



Accessory List	
AC Adapter 1	Model Name: UCH12
	S/N:
	VB17W34100012 (for radiated spurious emission) VB17W34100230 (for conducted emission)
Earphone 1	Model Name: MH410c
	S/N: N/A
USB Cable	Model Name: UCB20
	S/N: N/A

Note:

1. Above EUT list and accessory list used are electrically identical per declared by manufacturer.
2. Above the accessories list are used to exercise the EUT during test.
3. For other wireless features of this EUT, test report will be issued separately.

1.4 Modification of EUT

No modifications are made to the EUT during all test items.



1.5 Testing Location

Sporton Lab is accredited to ISO 17025 by Taiwan Accreditation Foundation (TAF code : 1190) and the FCC designation No. TW1190 and TW0007 under the FCC 2.948(e) by Mutual Recognition Agreement (MRA) in FCC Test.

Test Site	SPORTON INTERNATIONAL INC.	
Test Site Location	No. 52, Hwa Ya 1 st Rd., Hwa Ya Technology Park, Kwei-Shan District, Tao Yuan City, Taiwan, R.O.C. TEL: +886-3-327-3456 FAX: +886-3-328-4978	
Test Site No.	Sporton Site No.	
	TH05-HY	CO05-HY

Note: The test site complies with ANSI C63.4 2014 requirement.

Test Site	SPORTON INTERNATIONAL INC.	
Test Site Location	No.58, Aly. 75, Ln. 564, Wenhua 3rd Rd. Guishan Dist, Taoyuan City, Taiwan (R.O.C.) TEL: +886-3-327-0868 FAX: +886-3-327-0855	
Test Site No.	Sporton Site No.	
	03CH13-HY	

Note: The test site complies with ANSI C63.4 2014 requirement.

1.6 Applicable Standards

According to the specifications of the manufacturer, the EUT must comply with the requirements of the following standards:

- ♦ FCC Part 15 Subpart C §15.247
- ♦ FCC KDB Publication No. 558074 D01 DTS Meas. Guidance v04
- ♦ ANSI C63.10-2013

Remark:

1. All test items were verified and recorded according to the standards and without any deviation during the test.
2. This EUT has also been tested and complied with the requirements of FCC Part 15, Subpart B, recorded in a separate test report.



2 Test Configuration of Equipment Under Test

- a. The EUT has been associated with peripherals and configuration operated in a manner tended to maximize its emission characteristics in a typical application. Frequency range investigated: conduction (150 kHz to 30 MHz), radiation (9 kHz to the 10th harmonic of the highest fundamental frequency or to 40 GHz, whichever is lower). For radiated measurement, pre-scanned in three orthogonal panels, X, Y, Z. The worst cases (X plane) were recorded in this report.

- b. AC power line Conducted Emission was tested under maximum output power.

2.1 Carrier Frequency and Channel

Frequency Band	Channel	Freq. (MHz)	Channel	Freq. (MHz)
2400-2483.5 MHz	1	2412	7	2442
	2	2417	8	2447
	3	2422	9	2452
	4	2427	10	2457
	5	2432	11	2462
	6	2437	-	-



2.2 Test Mode

Final test mode of conducted test items and radiated spurious emissions are considering the modulation and worse data rates as below table.

Modulation	Data Rate
802.11b	1 Mbps
802.11g	6 Mbps
802.11ac VHT20	MCS0

Test Cases	
AC Conducted Emission	Mode 1: Bluetooth Link + WLAN (2.4GHz) Link + Earphone 1 + Battery 1 + USB Cable (Charging from Adapter 1)
Remark: For Radiated Test Cases, The tests were performance with Battery 1.	

2.3 Connection Diagram of Test System

<WLAN Tx Mode>

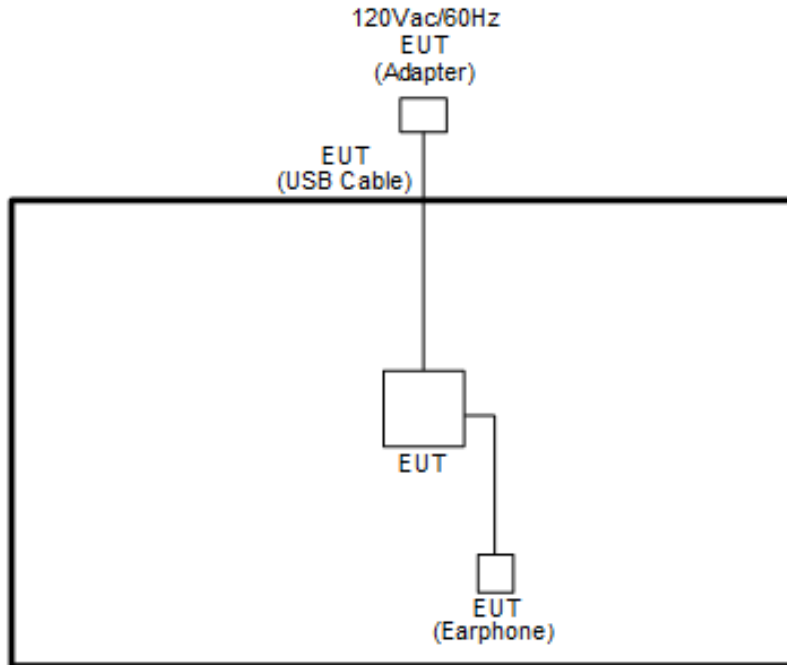

<AC Conducted Emission Mode>

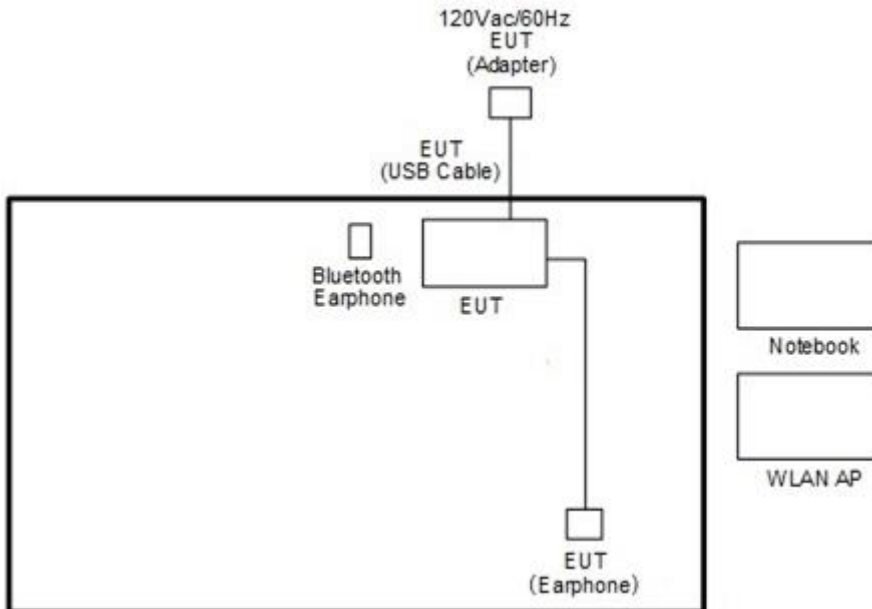



2.4 Support Unit used in test configuration and system

Item	Equipment	Trade Name	Model Name	FCC ID	Data Cable	Power Cord
1.	Bluetooth Earphone	Sony	SBH20	PY7-RD0010	N/A	N/A
2.	WLAN AP	ASUS	RT-AC66U	MSQ-RTAC66U	N/A	Unshielded,1.8m
3.	Notebook	DELL	Latitude E6320	FCC DoC/ Contains FCC ID: QDS-BRCM1054	N/A	AC I/P: Unshielded, 1.2 m DC O/P: Shielded, 1.8 m
4.	SD Card	SanDisk	MicroSD HC	FCC DoC	N/A	N/A

2.5 EUT Operation Test Setup

For RF test items, an engineering test program was provided and enabled to make EUT transmitting signals.

2.6 Measurement Results Explanation Example

For all conducted test items:

The offset level is set in the spectrum analyzer to compensate the RF cable loss and attenuator factor between EUT conducted output port and spectrum analyzer. With the offset compensation, the spectrum analyzer reading level is exactly the EUT RF output level.

Example :

The spectrum analyzer offset is derived from RF cable loss and attenuator factor.

Offset = RF cable loss + attenuator factor.

Following shows an offset computation example with cable loss 4.2 dB and 10dB attenuator.

$$\begin{aligned} \text{Offset(dB)} &= \text{RF cable loss(dB)} + \text{attenuator factor(dB)}. \\ &= 4.2 + 10 = 14.2 \text{ (dB)} \end{aligned}$$

3 Test Result

3.1 6dB and 99% Bandwidth Measurement

3.1.1 Limit of 6dB and 99% Bandwidth

The minimum 6 dB bandwidth shall be at least 500 kHz.

3.1.2 Measuring Instruments

The measuring equipment is listed in the section 4 of this test report.

3.1.3 Test Procedures

1. The testing follows FCC KDB Publication No. 558074 DTS D01 Meas. Guidance v04.
2. The RF output of EUT was connected to the spectrum analyzer by RF cable and attenuator. The path loss was compensated to the results for each measurement.
3. Set to the maximum power setting and enable the EUT transmit continuously.
4. Make the measurement with the spectrum analyzer's resolution bandwidth (RBW) = 100 kHz. Set the Video bandwidth (VBW) = 300 kHz. In order to make an accurate measurement. The 6 dB bandwidth must be greater than 500 kHz.
5. For 99% Bandwidth Measurement, the spectrum analyzer's resolution bandwidth (RBW) = 1MHz and set the Video bandwidth (VBW) = 3MHz.
6. Measure and record the results in the test report.

3.1.4 Test Setup





3.1.5 Test Result of 6dB and 99% Occupied Bandwidth

Please refer to Appendix A.

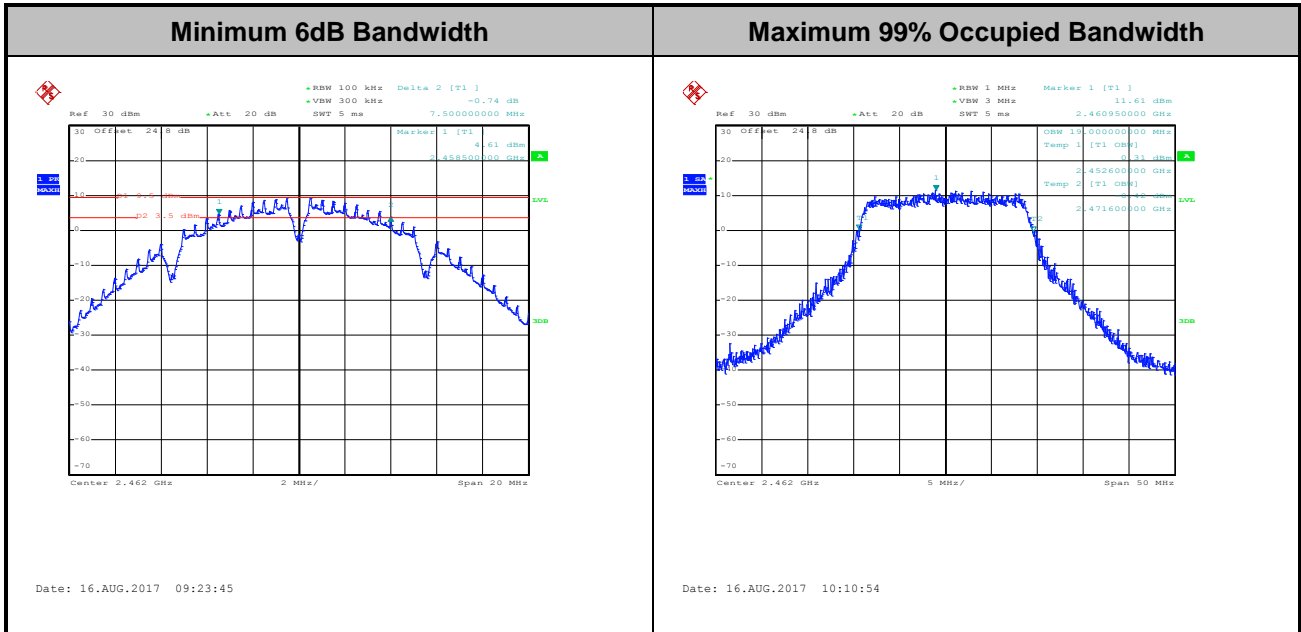

Note : The occupied channel bandwidth is maintained within the band of operation for all of the modulations.

3.2 Output Power Measurement

3.2.1 Limit of Output Power

For systems using digital modulation in the 2400-2483.5MHz, the limit for peak output power is 30dBm. If transmitting antenna of directional gain greater than 6dBi are used the peak output power from the intentional radiator shall be reduced below the above stated value by the amount in dB that the directional gain of the antenna exceeds 6 dBi. In case of point-to-point operation, the limit has to be reduced by 1dB for every 3dB that the directional gain of the antenna exceeds 6dBi.

3.2.2 Measuring Instruments

The measuring equipment is listed in the section 4 of this test report.

3.2.3 Test Procedures

1. The testing follows the Measurement Procedure of FCC KDB No. 558074 DTS D01 Meas. Guidance v04 section 9.1.3 PKPM1 Peak power meter method.
2. The RF output of EUT was connected to the power meter by RF cable and attenuator. The path loss was compensated to the results for each measurement.
3. Set to the maximum power setting and enable the EUT transmit continuously.
4. Measure the conducted output power and record the results in the test report.

3.2.4 Test Setup

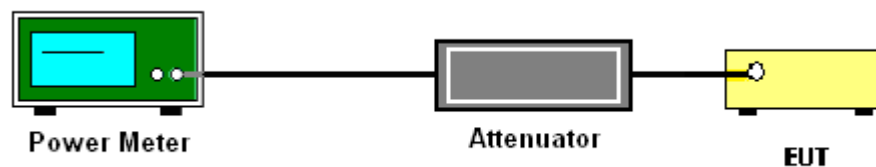

3.2.5 Test Result of Peak Output Power

Please refer to Appendix A.

3.2.6 Test Result of Average output Power (Reporting Only)

Please refer to Appendix A.

3.3 Power Spectral Density Measurement

3.3.1 Limit of Power Spectral Density

The peak power spectral density shall not be greater than 8dBm in any 3kHz band at any time interval of continuous transmission.

3.3.2 Measuring Instruments

The measuring equipment is listed in the section 4 of this test report.

3.3.3 Test Procedures

1. The testing follows Measurement Procedure 10.2 Method PKPSD of FCC KDB Publication No. 558074 D01 DTS Meas. Guidance v04
2. The RF output of EUT was connected to the spectrum analyzer by RF cable and attenuator. The path loss was compensated to the results for each measurement.
3. Set to the maximum power setting and enable the EUT transmit continuously.
4. Make the measurement with the spectrum analyzer's resolution bandwidth (RBW) = 3 kHz. Video bandwidth VBW = 10 kHz In order to make an accurate measurement, set the span to 1.5 times DTS Channel Bandwidth. (6dB BW)
5. Detector = peak, Sweep time = auto couple, Trace mode = max hold, Allow trace to fully stabilize. Use the peak marker function to determine the maximum power level.
6. Measure and record the results in the test report.

3.3.4 Test Setup





3.3.5 Test Result of Power Spectral Density

Please refer to Appendix A.

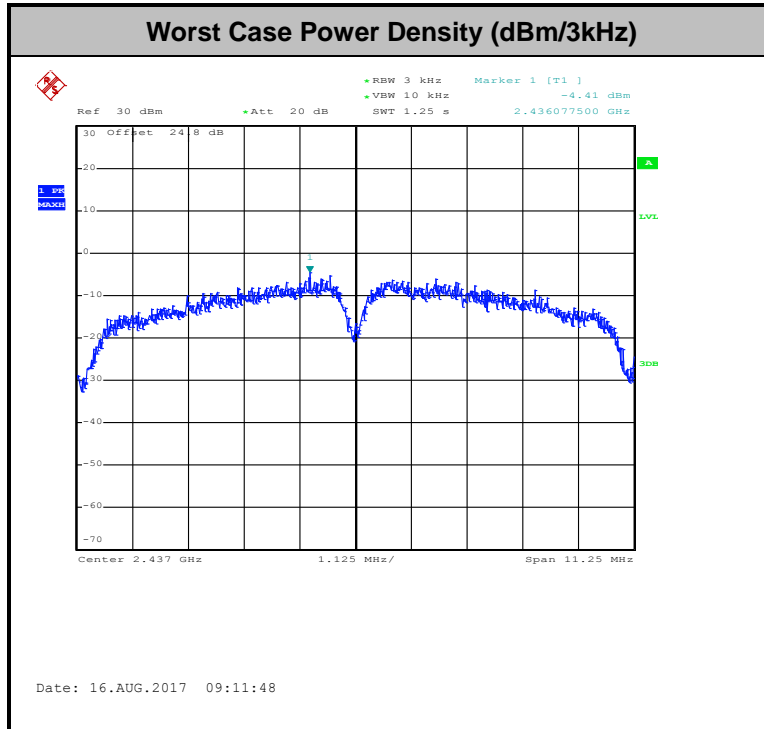

3.4 Conducted Band Edges and Spurious Emission Measurement

3.4.1 Limit of Conducted Band Edges and Spurious Emission Measurement

In any 100 kHz bandwidth outside of the authorized frequency band, the emissions which fall in the non-restricted bands shall be attenuated at least 20 dB / 30dB relative to the maximum PSD level in 100 kHz by RF conducted measurement.

3.4.2 Measuring Instruments

The measuring equipment is listed in the section 4 of this test report.

3.4.3 Test Procedures

1. The testing follows FCC KDB Publication No. 558074 D01 DTS Meas. Guidance v04.
2. The RF output of EUT was connected to the spectrum analyzer by RF cable and attenuator. The path loss was compensated to the results for each measurement.
3. Set to the maximum power setting and enable the EUT transmit continuously.
4. Set RBW = 100 kHz, VBW=300 kHz, Peak Detector. Unwanted Emissions measured in any 100 kHz bandwidth outside of the authorized frequency band shall be attenuated by at least 20 dB relative to the maximum in-band peak PSD level in 100 kHz when maximum peak conducted output power procedure is used. If the transmitter complies with the conducted power limits based on the use of RMS averaging over a time interval, the attenuation required under this paragraph shall be 30 dB instead of 20 dB.
5. Measure and record the results in the test report.
6. The RF fundamental frequency should be excluded against the limit line in the operating frequency band.

3.4.4 Test Setup

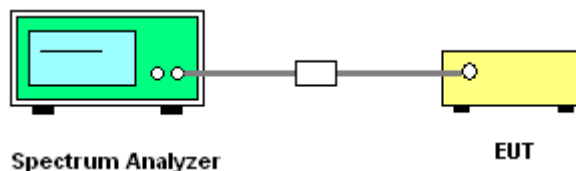



3.4.5 Test Result of Conducted Band Edges and Spurious Emission

Test Mode :	802.11b	Temperature :	24.5~25.3°C
Test Band :	2.4GHz Low	Relative Humidity :	49~54%
Test Channel :	01	Test Engineer :	Alex Jheng / Bill Chang / Wilson Wu

WLAN 802.11b Channel 01

100kHz PSD reference Level

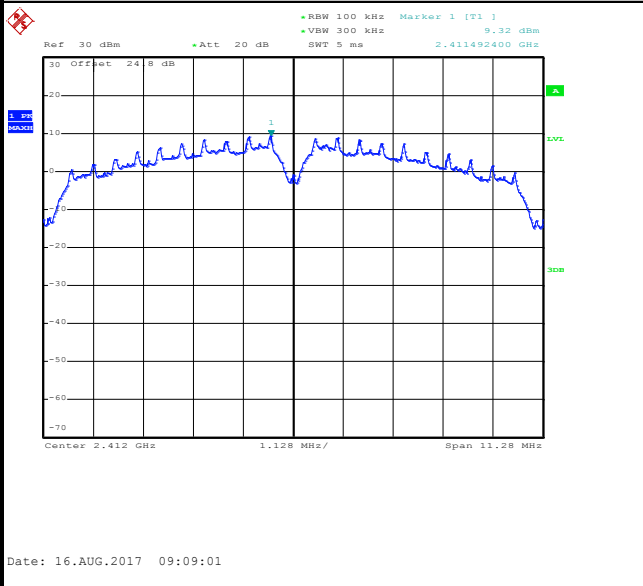

Low Channel Plot

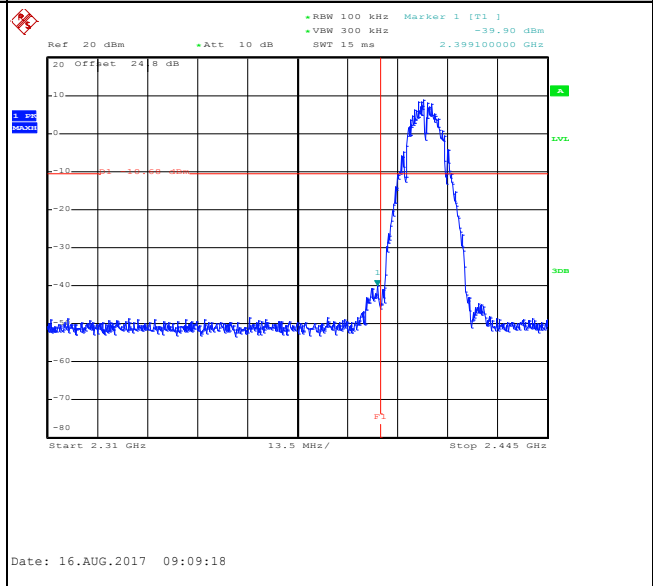

Spurious Emission 30MHz~3GHz

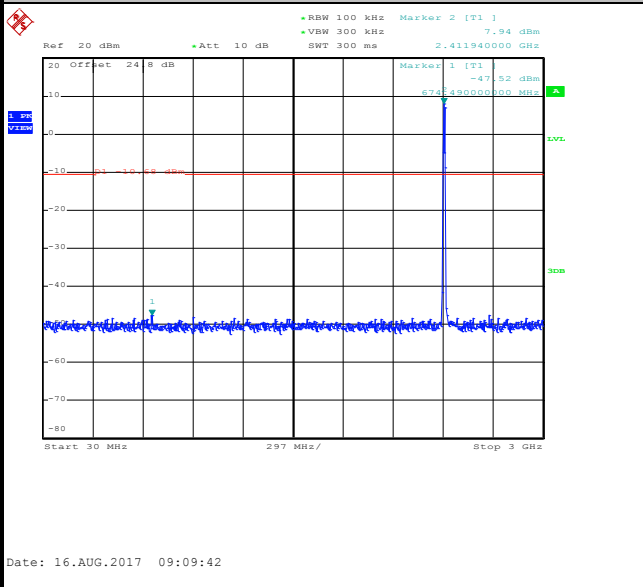

Spurious Emission 2GHz~25GHz

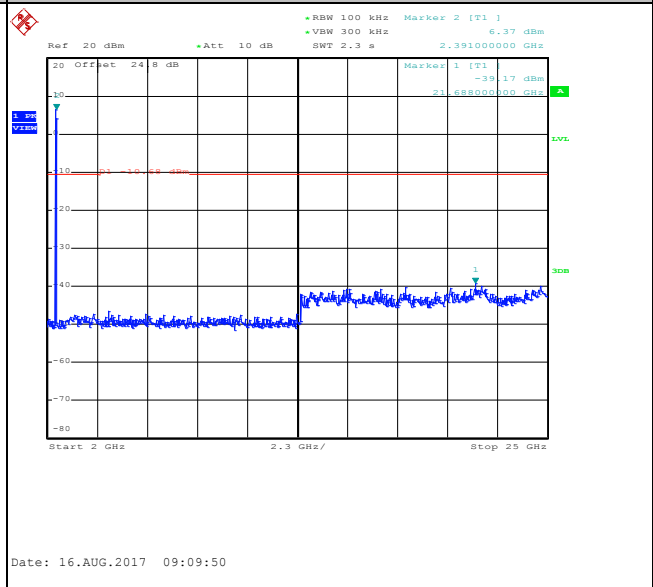



Test Mode :	802.11b	Temperature :	24.5~25.3°C
Test Band :	2.4GHz Mid	Relative Humidity :	49~54%
Test Channel :	06	Test Engineer :	Alex Jheng / Bill Chang / Wilson Wu

WLAN 802.11b Channel 06

100kHz PSD reference Level

Mid Channel Plot

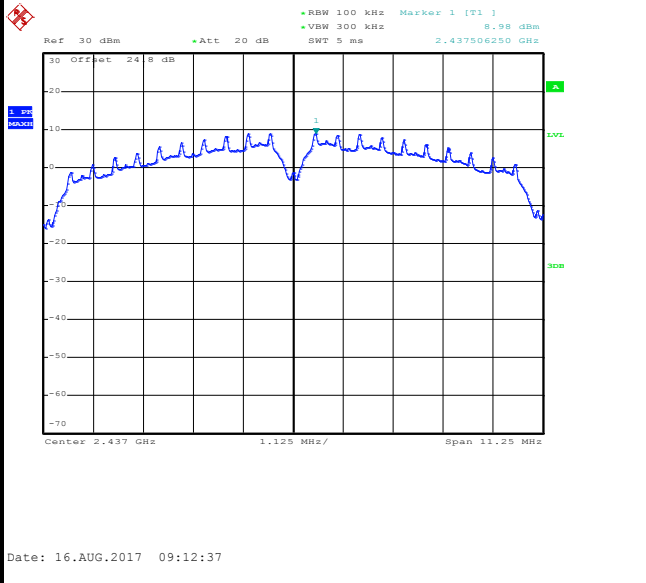

Spurious Emission 30MHz~3GHz

Spurious Emission 2GHz~25GHz

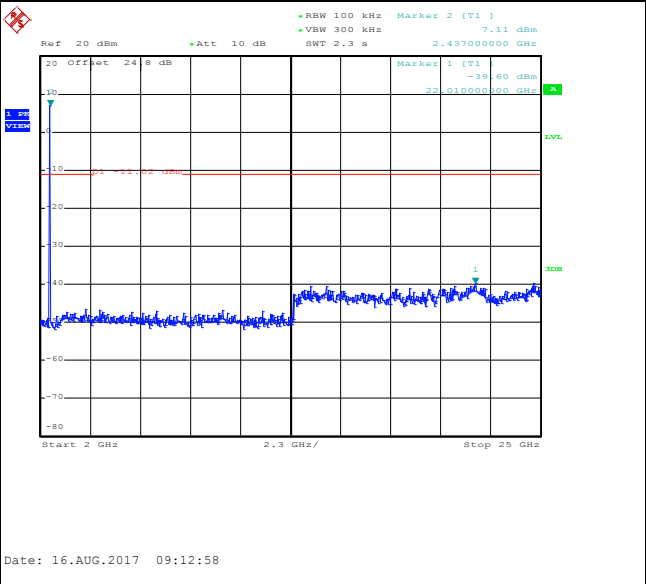
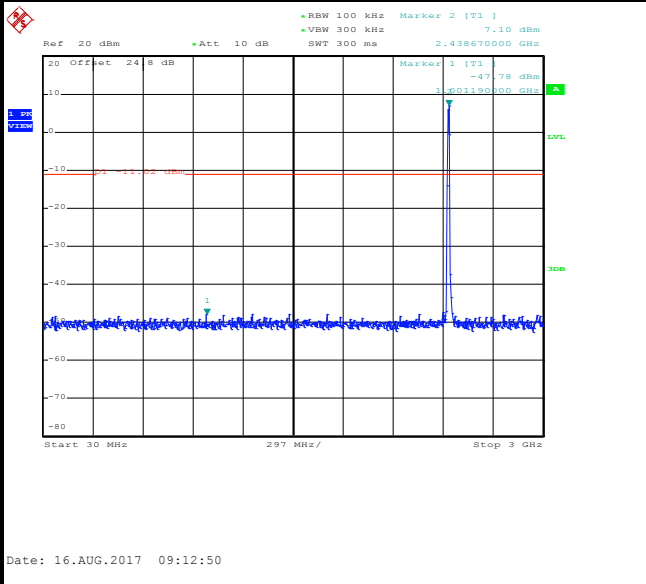



Test Mode :	802.11b	Temperature :	24.5~25.3°C
Test Band :	2.4GHz High	Relative Humidity :	49~54%
Test Channel :	11	Test Engineer :	Alex Jheng / Bill Chang / Wilson Wu

WLAN 802.11b Channel 11

100kHz PSD reference Level

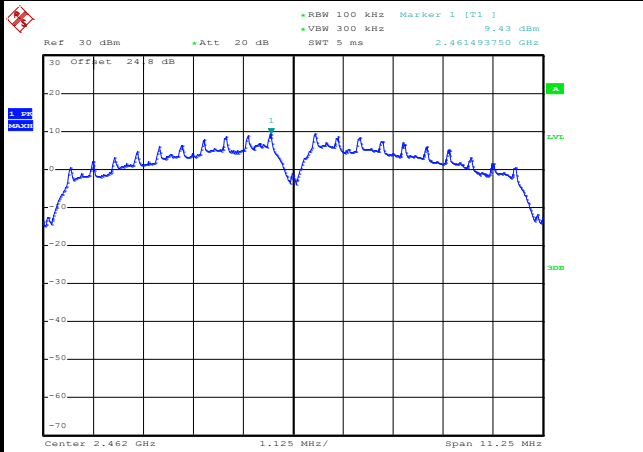

Date: 16.AUG.2017 09:24:12

High Channel Plot

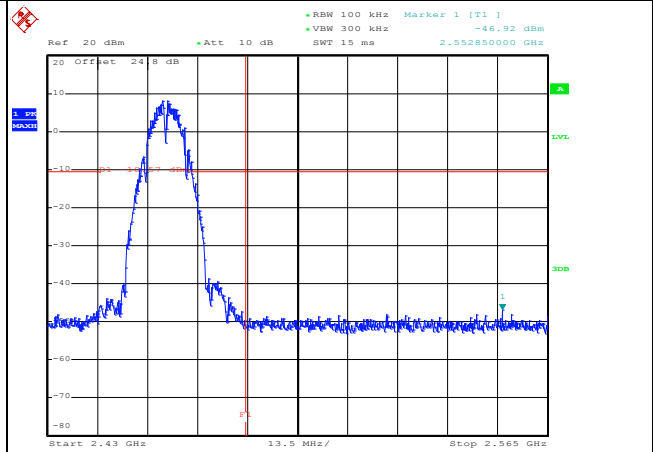

Date: 16.AUG.2017 09:24:24

Spurious Emission 30MHz~3GHz

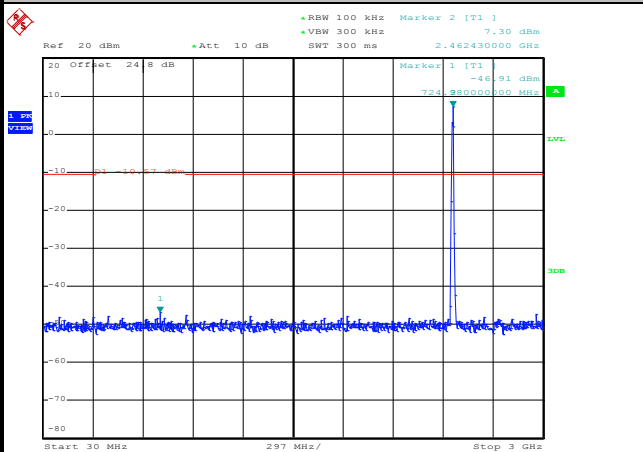

Date: 16.AUG.2017 09:24:37

Spurious Emission 2GHz~25GHz

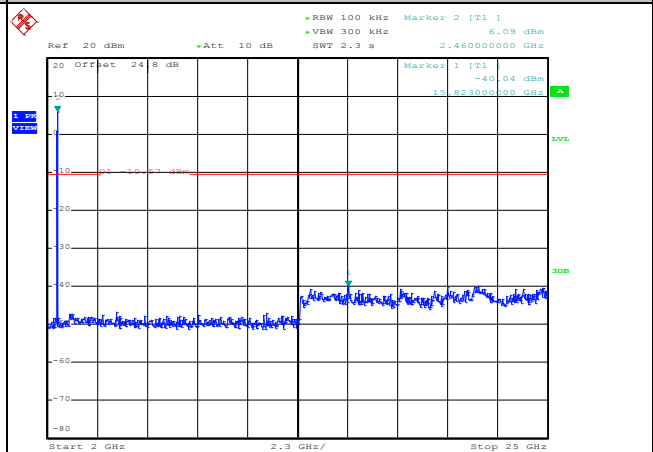

Date: 16.AUG.2017 09:24:45



Test Mode :	802.11g	Temperature :	24.5~25.3°C
Test Band :	2.4GHz Low	Relative Humidity :	49~54%
Test Channel :	01	Test Engineer :	Alex Jheng / Bill Chang / Wilson Wu

WLAN 802.11g Channel 01

100kHz PSD reference Level

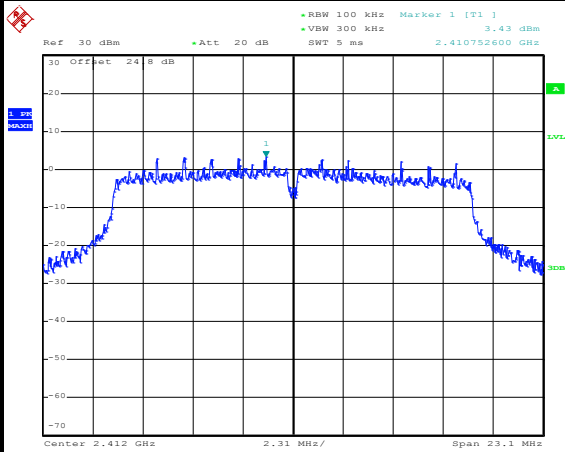

Date: 16.AUG.2017 09:28:58

Low Channel Plot

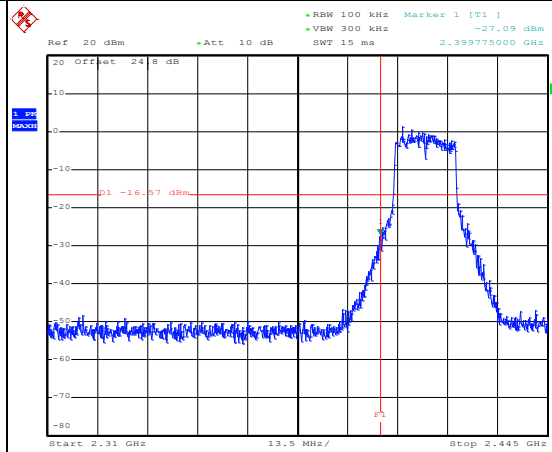

Date: 16.AUG.2017 09:29:29

Spurious Emission 30MHz~3GHz

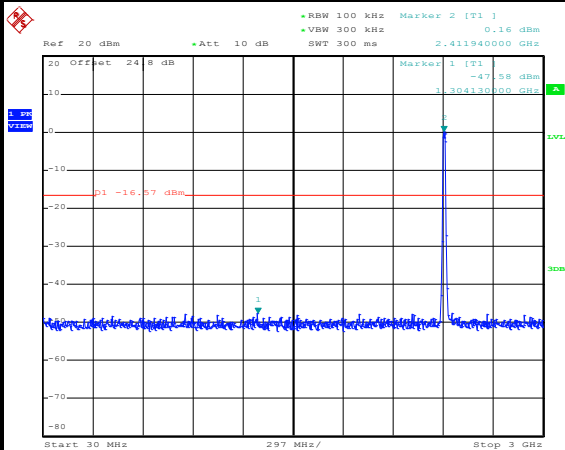

Date: 16.AUG.2017 09:29:42

Spurious Emission 2GHz~25GHz

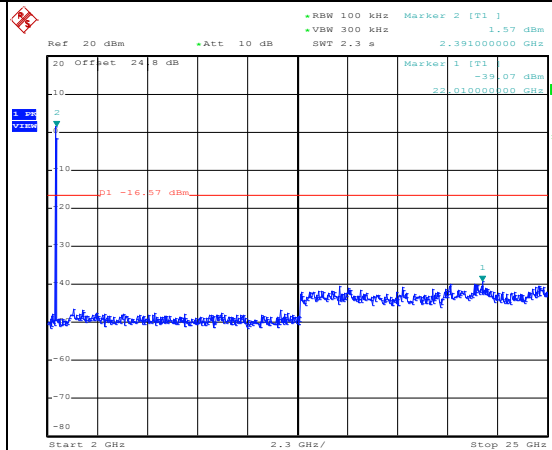

Date: 16.AUG.2017 09:29:50



Test Mode :	802.11g	Temperature :	24.5~25.3°C
Test Band :	2.4GHz Mid	Relative Humidity :	49~54%
Test Channel :	06	Test Engineer :	Alex Jheng / Bill Chang / Wilson Wu

WLAN 802.11g Channel 06

100kHz PSD reference Level

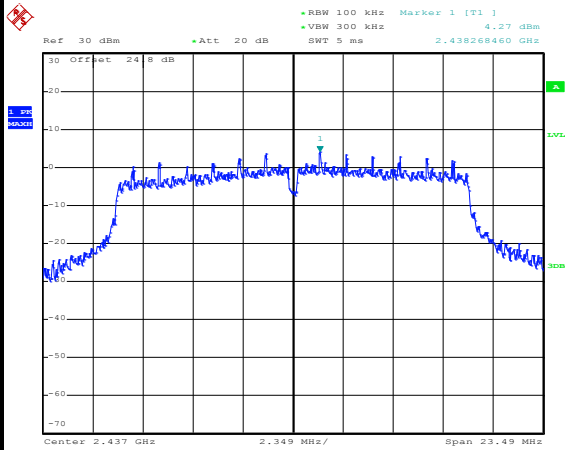

Date: 16.AUG.2017 09:35:41

Mid Channel Plot

Spurious Emission 30MHz~3GHz

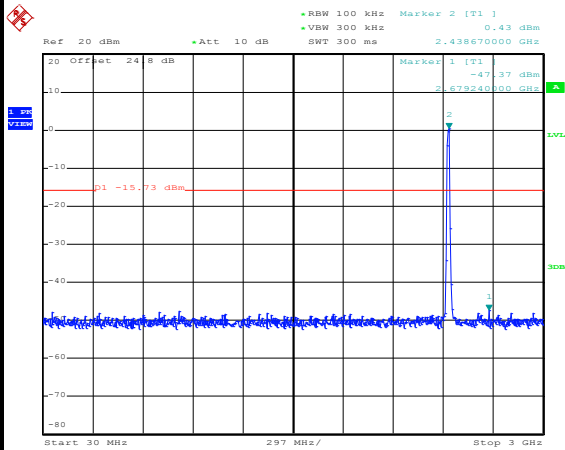

Date: 16.AUG.2017 09:35:53

Spurious Emission 2GHz~25GHz

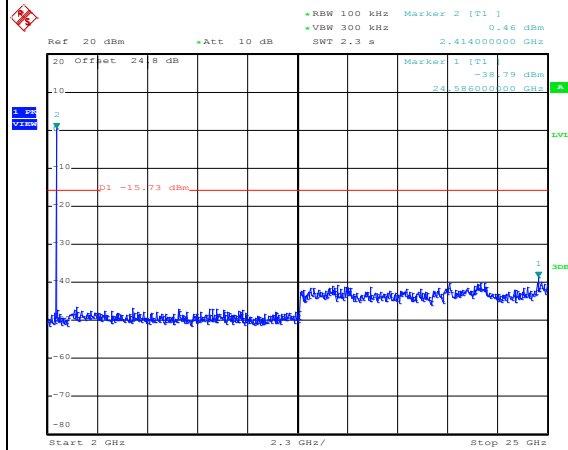

Date: 16.AUG.2017 09:36:02



Test Mode :	802.11g	Temperature :	24.5~25.3°C
Test Band :	2.4GHz High	Relative Humidity :	49~54%
Test Channel :	11	Test Engineer :	Alex Jheng / Bill Chang / Wilson Wu

WLAN 802.11g Channel 11

100kHz PSD reference Level

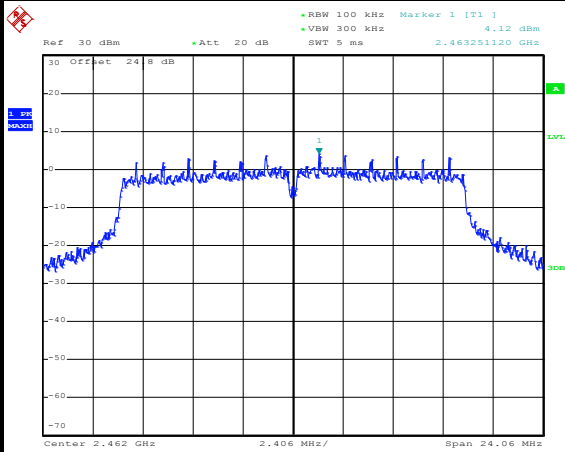

Date: 16.AUG.2017 09:38:33

High Channel Plot

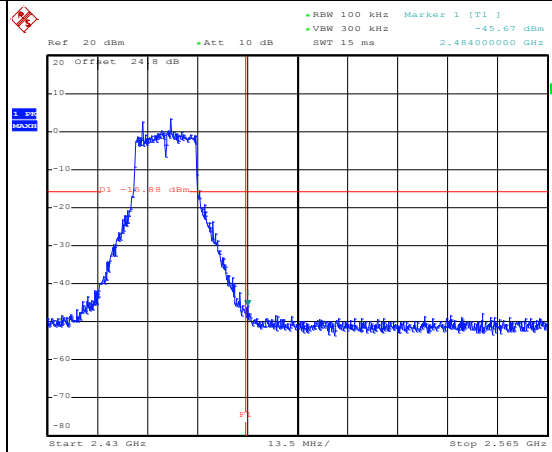

Date: 16.AUG.2017 09:38:53

Spurious Emission 30MHz~3GHz

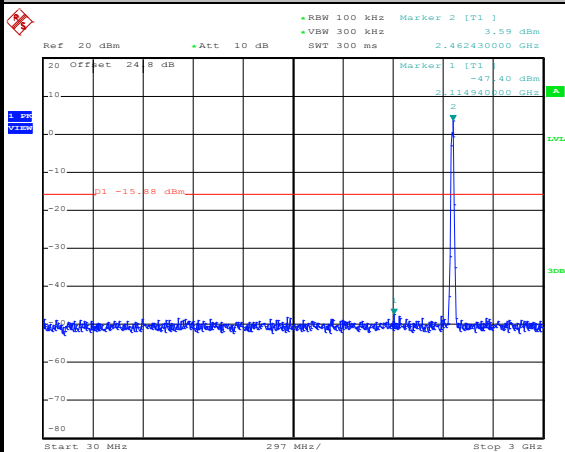

Date: 16.AUG.2017 09:43:01

Spurious Emission 2GHz~25GHz

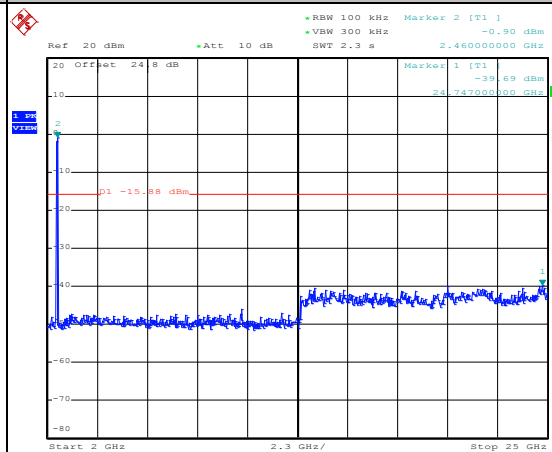

Date: 16.AUG.2017 09:43:10



Test Mode :	802.11ac VHT20	Temperature :	24.5~25.3°C
Test Band :	2.4GHz Low	Relative Humidity :	49~54%
Test Channel :	01	Test Engineer :	Alex Jheng / Bill Chang / Wilson Wu

WLAN 802.11ac VHT20 Channel 01

100kHz PSD reference Level

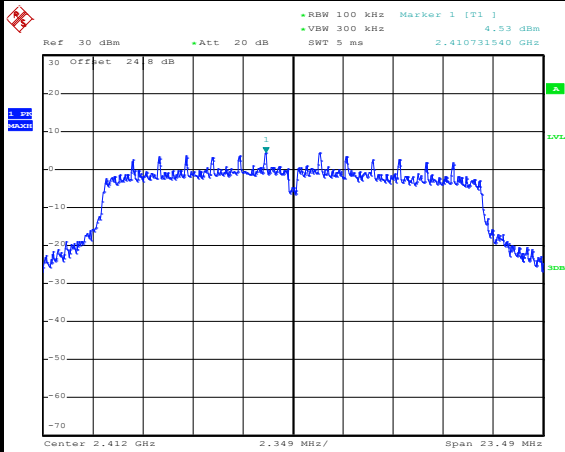

Date: 16.AUG.2017 10:02:52

Low Channel Plot

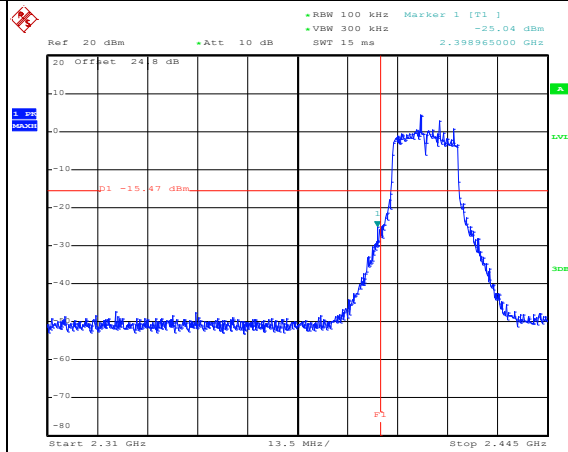

Date: 16.AUG.2017 10:03:04

Spurious Emission 30MHz~3GHz

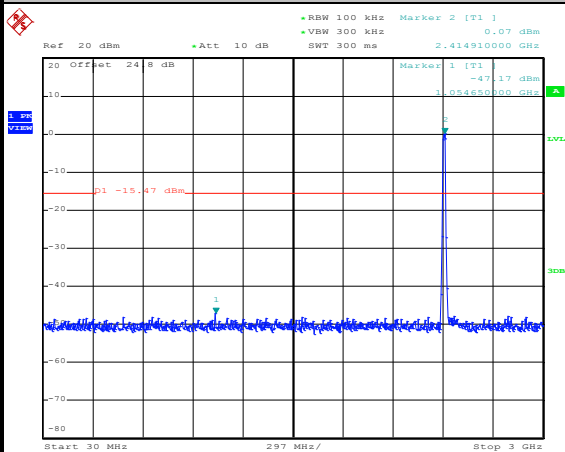

Date: 16.AUG.2017 10:03:18

Spurious Emission 2GHz~25GHz

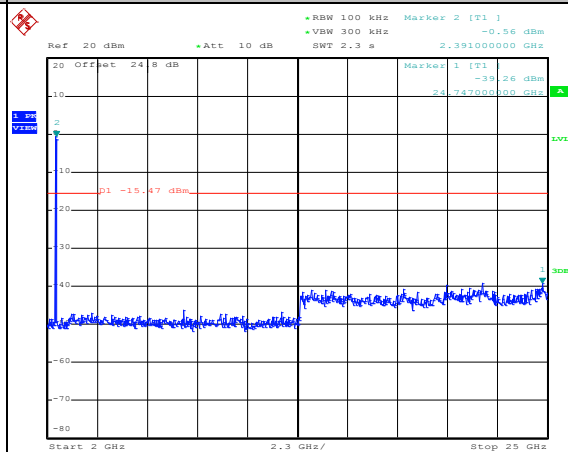

Date: 16.AUG.2017 10:03:26



Test Mode :	802.11ac VHT20	Temperature :	24.5~25.3°C
Test Band :	2.4GHz Mid	Relative Humidity :	49~54%
Test Channel :	06	Test Engineer :	Alex Jheng / Bill Chang / Wilson Wu

WLAN 802.11ac VHT20 Channel 06

100kHz PSD reference Level

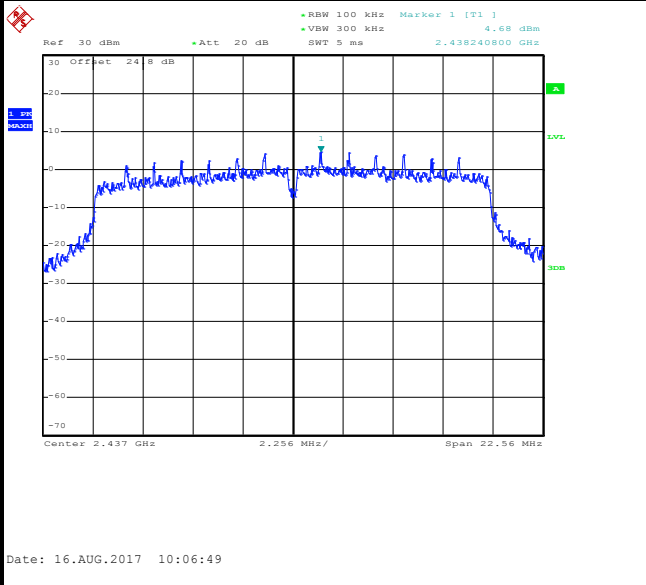

Mid Channel Plot



Spurious Emission 30MHz~3GHz

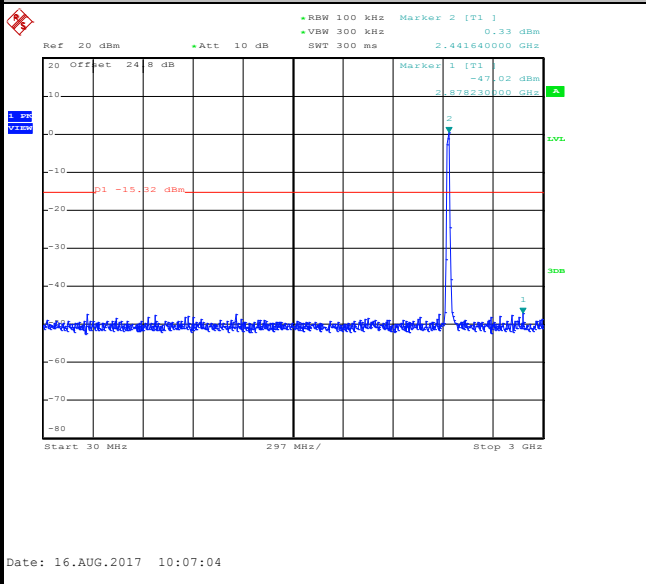

Spurious Emission 2GHz~25GHz

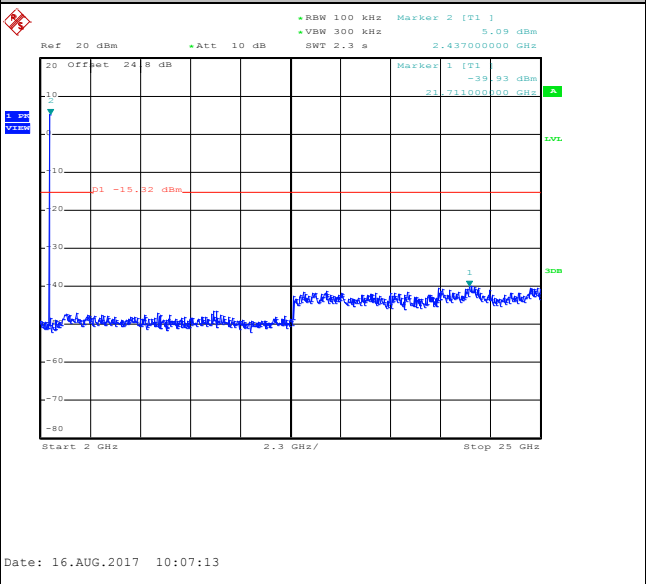



Test Mode :	802.11ac VHT20	Temperature :	24.5~25.3°C
Test Band :	2.4GHz High	Relative Humidity :	49~54%
Test Channel :	11	Test Engineer :	Alex Jheng / Bill Chang / Wilson Wu

WLAN 802.11ac VHT20 Channel 11

100kHz PSD reference Level

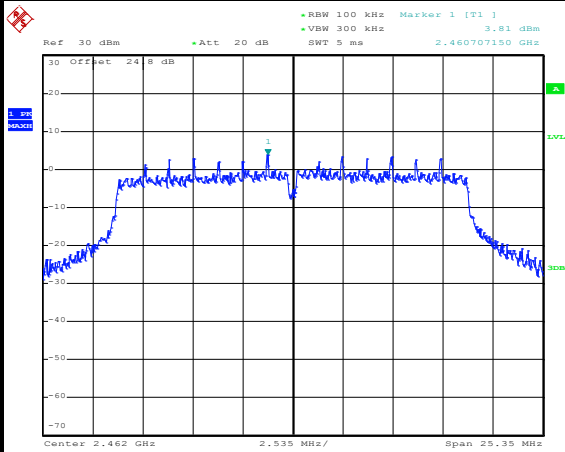

Date: 16.AUG.2017 10:09:49

High Channel Plot

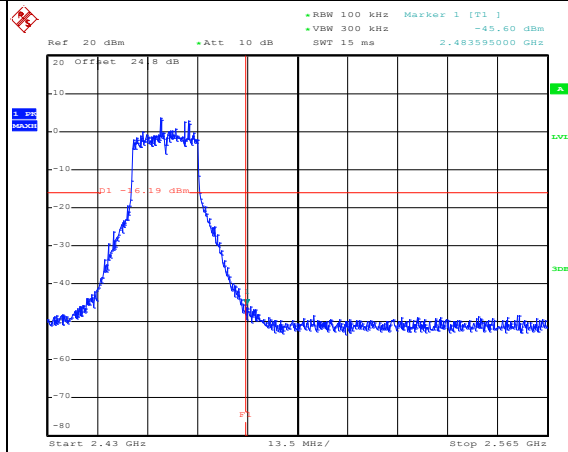

Date: 16.AUG.2017 10:10:04

Spurious Emission 30MHz~3GHz

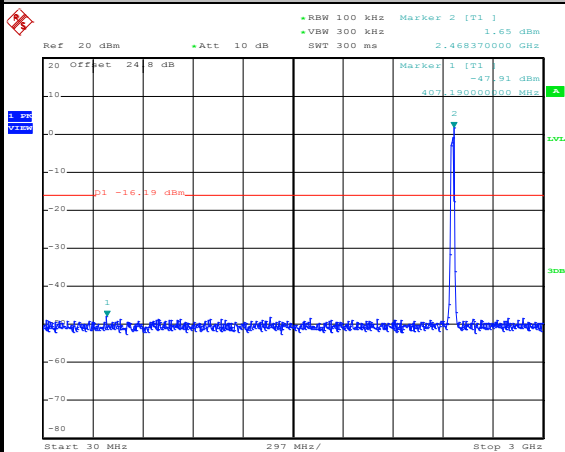

Date: 16.AUG.2017 10:10:31

Spurious Emission 2GHz~25GHz

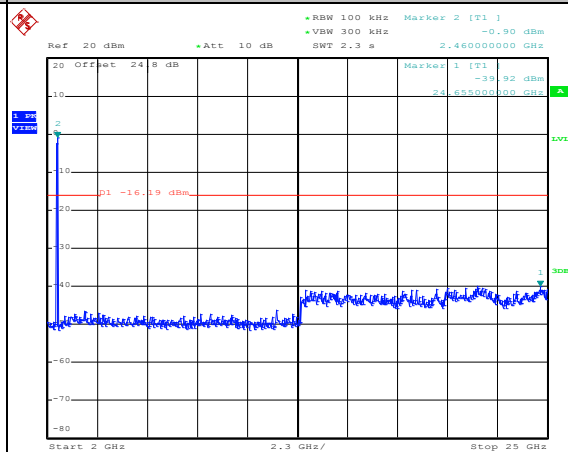

Date: 16.AUG.2017 10:10:39



3.5 Radiated Band Edges and Spurious Emission Measurement

3.5.1 Limit of Radiated band edge and Spurious Emission Measurement

In any 100 kHz bandwidth outside the intentional radiator frequency band, all harmonics/spurious must be at least 20 dB below the highest emission level within the authorized band. If the output power of this device was measured by spectrum analyzer, the attenuation under this paragraph shall be 30 dB instead of 20 dB. In addition, radiated emissions which fall in the restricted bands must also comply with the limits as below.

Frequency (MHz)	Field Strength (microvolts/meter)	Measurement Distance (meters)
0.009 – 0.490	2400/F(kHz)	300
0.490 – 1.705	24000/F(kHz)	30
1.705 – 30.0	30	30
30 – 88	100	3
88 – 216	150	3
216 - 960	200	3
Above 960	500	3

3.5.2 Measuring Instruments

The measuring equipment is listed in the section 4 of this test report.



3.5.3 Test Procedures

1. The testing follows FCC KDB Publication No. 558074 D01 DTS Meas. Guidance v04.
2. The EUT was arranged to its worst case and then tune the antenna tower (from 1 m to 4 m) and turntable (from 0 degree to 360 degrees) to find the maximum reading. A pre-amp and a high pass filter are used for the test in order to get better signal level.
3. The EUT was placed on a turntable with 0.8 meter for frequency below 1GHz and 1.5 meter for frequency above 1GHz respectively above ground.
4. The EUT was set 3 meters from the interference receiving antenna, which was mounted on the top of a variable height antenna tower.
5. Corrected Reading: Antenna Factor + Cable Loss + Read Level - Preamp Factor = Level
6. For testing below 1GHz, if the emission level of the EUT in peak mode was 3 dB lower than the limit specified, then peak values of EUT will be reported, otherwise, the emissions will be repeated one by one using the CISPR quasi-peak method and reported.
7. For testing above 1GHz, the emission level of the EUT in peak mode was 20dB lower than average limit (that means the emission level in average mode also complies with the limit in average mode), then peak values of EUT will be reported, otherwise, the emissions will be measured in average mode again and reported.
8. Use the following spectrum analyzer settings:
 - (1) Span shall wide enough to fully capture the emission being measured;
 - (2) Set RBW=100 kHz for $f < 1$ GHz; VBW \geq RBW; Sweep = auto; Detector function = peak; Trace = max hold;
 - (3) Set RBW = 1 MHz, VBW= 3MHz for $f \geq 1$ GHz for peak measurement.
For average measurement:
 - VBW = 10 Hz, when duty cycle is no less than 98 percent.
 - VBW $\geq 1/T$, when duty cycle is less than 98 percent where T is the minimum transmission duration over which the transmitter is on and is transmitting at its maximum power control level for the tested mode of operation.

3.5.4 Test Setup

For radiated emissions below 30MHz



For radiated emissions from 30MHz to 1GHz

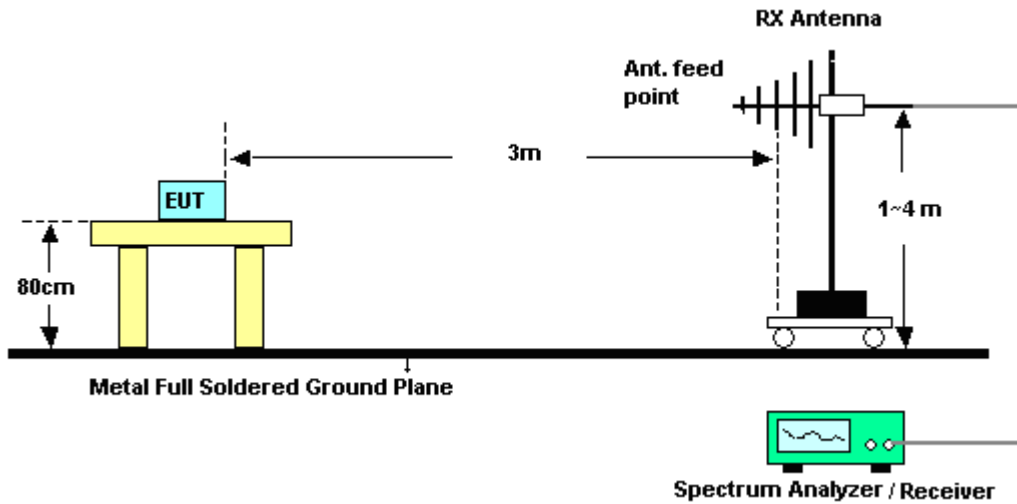

For radiated emissions above 1GHz

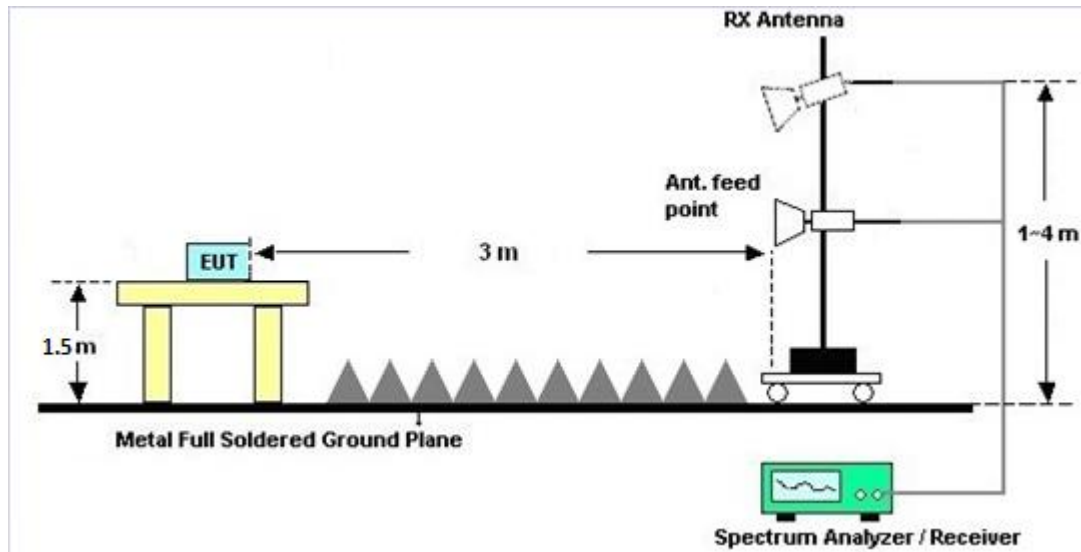

3.5.5 Test Results of Radiated Spurious Emissions (9kHz ~ 30MHz)

The low frequency, which started from 9 kHz to 30MHz, was pre-scanned and the result which was 20dB lower than the limit line was not reported.

There is a comparison data of both open-field test site and semi-Anechoic chamber, and the result came out very similar.

3.5.6 Test Result of Radiated Spurious at Band Edges

Please refer to Appendix C and D.

3.5.7 Duty Cycle

Please refer to Appendix E.

3.5.8 Test Result of Radiated Spurious Emission (30MHz ~ 10th Harmonic)

Please refer to Appendix C and D.



3.6 AC Conducted Emission Measurement

3.6.1 Limit of AC Conducted Emission

For equipment that is designed to be connected to the public utility (AC) power line, the radio frequency voltage that is conducted back onto the AC power line on any frequency or frequencies within the band 150 kHz to 30 MHz shall not exceed the limits in the following table.

Frequency of Emission (MHz)	Conducted Limit (dB μ V)	
	Quasi-Peak	Average
0.15-0.5	66 to 56*	56 to 46*
0.5-5	56	46
5-30	60	50

*Decreases with the logarithm of the frequency.

3.6.2 Measuring Instruments

The measuring equipment is listed in the section 4 of this test report.

3.6.3 Test Procedures

1. The EUT was placed 0.4 meter from the conducting wall of the shielding room, and it was kept at least 80 centimeters from any other grounded conducting surface.
2. Connect EUT to the power mains through a line impedance stabilization network (LISN).
3. All the support units are connecting to the other LISN.
4. The LISN provides 50 ohm coupling impedance for the measuring instrument.
5. The FCC states that a 50 ohm, 50 microhenry LISN should be used.
6. Both sides of AC line were checked for maximum conducted interference.
7. The frequency range from 150 kHz to 30 MHz was searched.
8. Set the test-receiver system to Peak Detect Function and specified bandwidth (IF bandwidth = 9kHz) with Maximum Hold Mode.

3.6.4 Test Setup

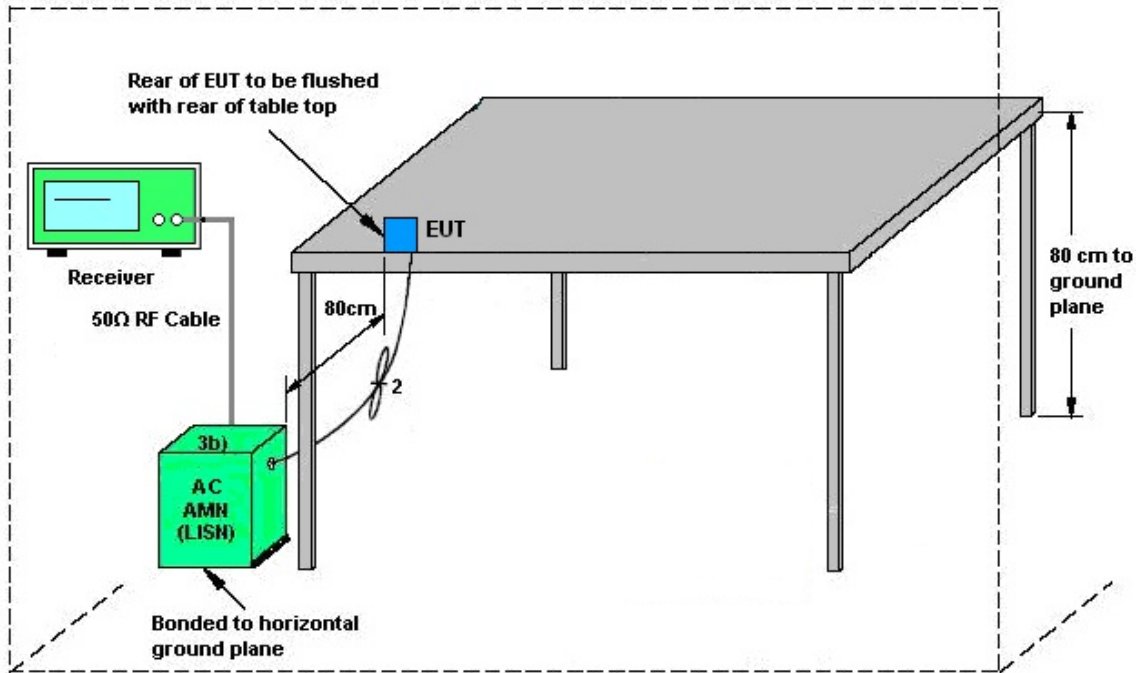

AMN = Artificial mains network (LISN)
AE = Associated equipment
EUT = Equipment under test
ISN = Impedance stabilization network

3.6.5 Test Result of AC Conducted Emission

Please refer to Appendix B.



3.7 Antenna Requirements

3.7.1 Standard Applicable

If directional gain of transmitting antennas is greater than 6dBi, the power shall be reduced by the same level in dB comparing to gain minus 6dBi. The use of a permanently attached antenna or of an antenna that uses a unique coupling to the intentional radiator shall be considered sufficient to comply with the rule.

3.7.2 Antenna Anti-Replacement Construction

An embedded-in antenna design is used.

3.7.3 Antenna Gain

The antenna peak gain of EUT is less than 6 dBi. Therefore, it is not necessary to reduce maximum peak output power limit.



4 List of Measuring Equipment

Instrument	Manufacturer	Model No.	Serial No.	Characteristics	Calibration Date	Test Date	Due Date	Remark
Power Meter	Anritsu	ML2495A	0932001	N/A	Sep. 29, 2016	Aug. 10, 2017~ Aug. 16, 2017	Sep. 28, 2017	Conducted (TH05-HY)
Power Sensor	Anritsu	MA2411B	0846202	300MHz~40GHz	Sep. 29, 2016	Aug. 10, 2017~ Aug. 16, 2017	Sep. 28, 2017	Conducted (TH05-HY)
Spectrum Analyzer	Rohde & Schwarz	FSP40	100057	9kHz-40GHz	Nov. 25, 2016	Aug. 10, 2017~ Aug. 16, 2017	Nov. 24, 2017	Conducted (TH05-HY)
Hygrometer	TECPEL	DTM-303B	TP157151	N/A	Mar. 20, 2017	Aug. 10, 2017~ Aug. 16, 2017	Mar. 19, 2018	Conducted (TH05-HY)
RF Cable	HUBER + SUHNER	SUCOFLEX 104	MY84209521	1GHz~26GHz	Dec. 02, 2016	Aug. 10, 2017~ Aug. 16, 2017	Dec. 01, 2017	Conducted (TH05-HY)
AC Power Source	ChainTek	APC-1000W	N/A	N/A	N/A	Oct. 02, 2017~ Oct. 03, 2017	N/A	Conduction (CO05-HY)
EMI Test Receiver	Rohde & Schwarz	ESCI 7	100724	9kHz~7GHz	Sep. 20, 2017	Oct. 02, 2017~ Oct. 03, 2017	Sep. 19, 2018	Conduction (CO05-HY)
Hygrometer	Testo	608-H1	34913912	N/A	May 02, 2017	Oct. 02, 2017~ Oct. 03, 2017	May 01, 2018	Conduction (CO05-HY)
LISN	Rohde & Schwarz	ENV216	100080	9kHz~30MHz	Nov. 29, 2016	Oct. 02, 2017~ Oct. 03, 2017	Nov. 28, 2017	Conduction (CO05-HY)
LF Cable	HUBER + SUHNER	RG-214/U	LF01	N/A	Jan. 05, 2017	Oct. 02, 2017~ Oct. 03, 2017	Jan. 04, 2018	Conduction (CO05-HY)
Test Software	N/A	EMC32	8.40.0	N/A	N/A	Oct. 02, 2017~ Oct. 03, 2017	N/A	Conduction (CO05-HY)
Loop Antenna	Rohde & Schwarz	HFH2-Z2	100315	9 kHz~30 MHz	May 15, 2017	Sep. 11, 2017~ Sep. 16, 2017	May 14, 2019	Radiation (03CH13-HY)
Bilog Antenna	TESEQ	CBL 6111D&00800 N1D01N-06	40103&04	30MHz to 1GHz	Jan. 07, 2017	Sep. 11, 2017~ Sep. 16, 2017	Jan. 06, 2018	Radiation (03CH13-HY)
Horn Antenna	SCHWARZBECK	BBHA 9120 D	9120D-1241	1GHz ~ 18GHz	May 02, 2017	Sep. 11, 2017~ Sep. 16, 2017	May 01, 2018	Radiation (03CH13-HY)
SHF-EHF Horn Antenna	SCHWARZBECK	BBHA 9170	BBHA9170584	18GHz- 40GHz	Nov. 08, 2016	Sep. 11, 2017~ Sep. 16, 2017	Nov. 07, 2017	Radiation (03CH13-HY)
Spectrum Analyzer	Keysight	N9010A	MY55370526	N/A	Mar. 15, 2017	Sep. 11, 2017~ Sep. 16, 2017	Mar. 14, 2018	Radiation (03CH13-HY)
EMI Test Receiver	Agilent	N9038A(MXE)	MY53290053	20Hz to 26.5GHz	Jan. 12, 2017	Sep. 11, 2017~ Sep. 16, 2017	Jan. 11, 2018	Radiation (03CH13-HY)
Amplifier	Sonoma-Instrument	310 N	187282	9KHz~1GHz	Dec. 21, 2016	Sep. 11, 2017~ Sep. 16, 2017	Dec. 20, 2017	Radiation (03CH13-HY)
Preamplifier	MITEQ	AMF-7D-0010 1800-30-10P	1590074	1GHz~18GHz	May 22, 2017	Sep. 11, 2017~ Sep. 16, 2017	May 21, 2018	Radiation (03CH13-HY)
Preamplifier	Keysight	83017A	MY53270147	1GHz~26.5GHz	Jan. 09, 2017	Sep. 11, 2017~ Sep. 16, 2017	Jan. 08, 2018	Radiation (03CH13-HY)
Preamplifier	MITEQ	TTA 1840-35-HG	1887435	18GHz ~ 40GHz	Oct. 13, 2016	Sep. 11, 2017~ Sep. 16, 2017	Oct. 12, 2017	Radiation (03CH13-HY)



Instrument	Manufacturer	Model No.	Serial No.	Characteristics	Calibration Date	Test Date	Due Date	Remark
Hygrometer	TECEP	DTM-303B	TP140320	N/A	Nov. 14, 2016	Sep. 11, 2017~ Sep. 16, 2017	Nov. 13, 2017	Radiation (03CH13-HY)
RF Cable	HUBER + SUHNER	SUCOFLEX 104	MY335041/4M Y9840/4 MY9838/4	26GHz~40GHz	Mar. 27, 2017	Sep. 11, 2017~ Sep. 16, 2017	Mar. 26, 2018	Radiation (03CH13-HY)
RF Cable	HUBER + SUHNER	SUCOFLEX 104	MY335041/4M Y9840/4 MY9838/4	30MHz~1GHz	Jan. 27, 2017	Sep. 11, 2017~ Sep. 16, 2017	Jan. 26, 2018	Radiation (03CH13-HY)
RF Cable	HUBER + SUHNER	SUCOFLEX 104	MY335041/4M Y9840/4 MY9838/4	1GHz~26GHz	Jan. 27, 2017	Sep. 11, 2017~ Sep. 16, 2017	Jan. 26, 2018	Radiation (03CH13-HY)
Controller	EMEC	EM1000	N/A	Control Turn table & Ant Mast	N/A	Sep. 11, 2017~ Sep. 16, 2017	N/A	Radiation (03CH13-HY)
Antenna Mast	EMEC	AM-BS-4500-B	N/A	1m~4m	N/A	Sep. 11, 2017~ Sep. 16, 2017	N/A	Radiation (03CH13-HY)
Turn Table	EMEC	TT2000	N/A	0~360 Degree	N/A	Sep. 11, 2017~ Sep. 16, 2017	N/A	Radiation (03CH13-HY)
Test Software	Audix	E3	6.2009-8-24	N/A	N/A	Sep. 11, 2017~ Sep. 16, 2017	N/A	Radiation (03CH13-HY)
Filter	Wainwright	WLKS1200-12 SS	SN2	1.2G Low Pass	Sep. 19, 2016	Sep. 11, 2017~ Sep. 16, 2017	Sep. 18, 2017	Radiation (03CH13-HY)
Filter	Wainwright	WHKX12-2700 -3000-18000-6 0SS	SN2	3G High Pass	Sep. 20, 2016	Sep. 11, 2017~ Sep. 16, 2017	Sep. 19, 2017	Radiation (03CH13-HY)



5 Uncertainty of Evaluation

Uncertainty of Conducted Emission Measurement (150kHz ~ 30MHz)

Measuring Uncertainty for a Level of Confidence of 95% ($U = 2Uc(y)$)	2.70
---	------

Uncertainty of Radiated Emission Measurement (30 MHz ~ 1000 MHz)

Measuring Uncertainty for a Level of Confidence of 95% ($U = 2Uc(y)$)	4.90
---	------

Uncertainty of Radiated Emission Measurement (1000 MHz ~ 18000 MHz)

Measuring Uncertainty for a Level of Confidence of 95% ($U = 2Uc(y)$)	5.40
---	------

Uncertainty of Radiated Emission Measurement (18000 MHz ~ 40000 MHz)

Measuring Uncertainty for a Level of Confidence of 95% ($U = 2Uc(y)$)	4.30
---	------

Appendix A. Test Result of Conducted Test Items

Test Engineer:	Reece Lin/Derek Hsu	Temperature:	21~25	°C
Test Date:	2017/8/10~2017/08/16	Relative Humidity:	51~54	%

TEST RESULTS DATA
6dB and 99% Occupied Bandwidth

2.4GHz Band								
Mod.	Data Rate	N _{TX}	CH.	Freq. (MHz)	99% Occupied BW (MHz)	6dB BW (MHz)	6dB BW Limit (MHz)	Pass/Fail
11b	1Mbps	1	1	2412	12.75	7.52	0.50	Pass
11b	1Mbps	1	6	2437	12.70	7.50	0.50	Pass
11b	1Mbps	1	11	2462	13.00	7.50	0.50	Pass
11g	6Mbps	1	1	2412	17.55	15.40	0.50	Pass
11g	6Mbps	1	6	2437	17.40	15.66	0.50	Pass
11g	6Mbps	1	11	2462	17.70	16.04	0.50	Pass
VHT20	MCS0	1	1	2412	18.55	15.66	0.50	Pass
VHT20	MCS0	1	6	2437	18.40	15.04	0.50	Pass
VHT20	MCS0	1	11	2462	19.00	16.90	0.50	Pass

TEST RESULTS DATA
Peak Power Table

2.4GHz Band										
Mod.	Data Rate	N _{TX}	CH.	Freq. (MHz)	Peak Conducted Power (dBm)	Conducted Power Limit (dBm)	DG (dBi)	EIRP Power (dBm)	EIRP Power Limit (dBm)	Pass /Fail
11b	1Mbps	1	1	2412	19.85	30.00	-1.60	18.25	36.00	Pass
11b	1Mbps	1	6	2437	18.62	30.00	-1.60	17.02	36.00	Pass
11b	1Mbps	1	11	2462	18.61	30.00	-1.60	17.01	36.00	Pass
11g	6Mbps	1	1	2412	18.67	30.00	-1.60	17.07	36.00	Pass
11g	6Mbps	1	6	2437	18.33	30.00	-1.60	16.73	36.00	Pass
11g	6Mbps	1	11	2462	18.58	30.00	-1.60	16.98	36.00	Pass
HT20	MCS0	1	1	2412	18.97	30.00	-1.60	17.37	36.00	Pass
HT20	MCS0	1	6	2437	18.90	30.00	-1.60	17.30	36.00	Pass
HT20	MCS0	1	11	2462	18.63	30.00	-1.60	17.03	36.00	Pass
VHT20	MCS0	1	1	2412	19.09	30.00	-1.60	17.49	36.00	Pass
VHT20	MCS0	1	6	2437	18.88	30.00	-1.60	17.28	36.00	Pass
VHT20	MCS0	1	11	2462	18.62	30.00	-1.60	17.02	36.00	Pass

TEST RESULTS DATA
Average Power Table
(Reporting Only)

2.4GHz Band						
Mod.	Data Rate	N _{TX}	CH.	Freq. (MHz)	Duty Factor (dB)	Average Conducted Power (dBm)
11b	1Mbps	1	1	2412	0.06	15.98
11b	1Mbps	1	6	2437	0.06	15.81
11b	1Mbps	1	11	2462	0.06	15.92
11g	6Mbps	1	1	2412	0.32	13.81
11g	6Mbps	1	6	2437	0.32	13.64
11g	6Mbps	1	11	2462	0.32	13.99
HT20	MCS0	1	1	2412	0.33	13.98
HT20	MCS0	1	6	2437	0.33	13.99
HT20	MCS0	1	11	2462	0.33	13.93
VHT20	MCS0	1	1	2412	0.34	13.96
VHT20	MCS0	1	6	2437	0.34	13.93
VHT20	MCS0	1	11	2462	0.34	13.91

TEST RESULTS DATA
Peak Power Density

2.4GHz Band								
Mod.	Data Rate	N _{TX}	CH.	Freq. (MHz)	Peak PSD (dBm /3kHz)	DG (dBi)	Peak PSD Limit (dBm /3kHz)	Pass/Fail
11b	1Mbps	1	1	2412	-5.02	-1.60	8.00	Pass
11b	1Mbps	1	6	2437	-4.41	-1.60	8.00	Pass
11b	1Mbps	1	11	2462	-5.56	-1.60	8.00	Pass
11g	6Mbps	1	1	2412	-10.88	-1.60	8.00	Pass
11g	6Mbps	1	6	2437	-10.71	-1.60	8.00	Pass
11g	6Mbps	1	11	2462	-9.82	-1.60	8.00	Pass
VHT20	MCS0	1	1	2412	-11.12	-1.60	8.00	Pass
VHT20	MCS0	1	6	2437	-11.25	-1.60	8.00	Pass
VHT20	MCS0	1	11	2462	-10.32	-1.60	8.00	Pass



Appendix B. AC Conducted Emission Test Results

Test Engineer :	Blue Lan	Temperature :	26~27°C
		Relative Humidity :	51~52%

EUT Information

Report NO : 760710-01
 Test Mode : Mode 1
 Test Voltage : 120Vac/60Hz
 Phase : Line

ENV216 Auto Test FCC Power Bar - L

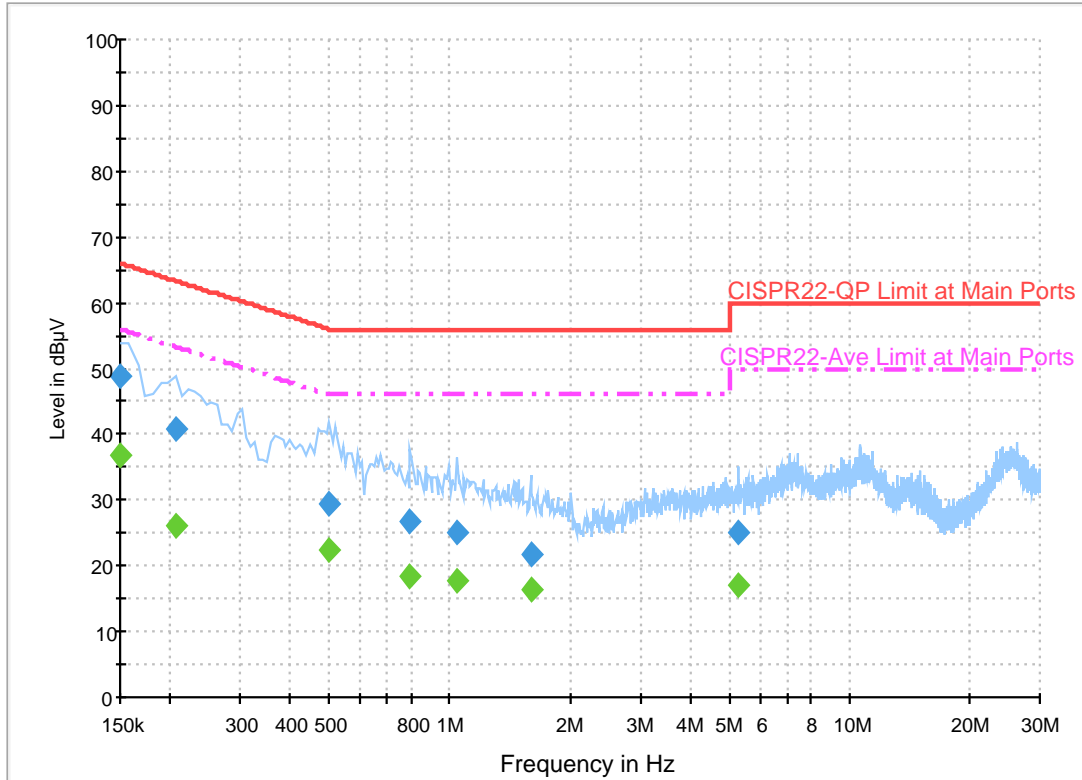

Final Result 1

Frequency (MHz)	QuasiPeak (dBµV)	Filter	Line	Corr. (dB)	Margin (dB)	Limit (dBµV)
0.150000	48.8	Off	L1	19.6	17.2	66.0
0.206000	40.7	Off	L1	19.6	22.7	63.4
0.502000	29.3	Off	L1	19.6	26.7	56.0
0.798000	26.6	Off	L1	19.6	29.4	56.0
1.046000	25.1	Off	L1	19.6	30.9	56.0
1.598000	21.7	Off	L1	19.6	34.3	56.0
5.270000	25.2	Off	L1	19.8	34.8	60.0

Final Result 2

Frequency (MHz)	Average (dBµV)	Filter	Line	Corr. (dB)	Margin (dB)	Limit (dBµV)
0.150000	36.8	Off	L1	19.6	19.2	56.0
0.206000	26.1	Off	L1	19.6	27.3	53.4
0.502000	22.3	Off	L1	19.6	23.7	46.0
0.798000	18.3	Off	L1	19.6	27.7	46.0
1.046000	17.7	Off	L1	19.6	28.3	46.0
1.598000	16.3	Off	L1	19.6	29.7	46.0
5.270000	17.0	Off	L1	19.8	33.0	50.0

EUT Information

Report NO : 760710-01
 Test Mode : Mode 1
 Test Voltage : 120Vac/60Hz
 Phase : Neutral

ENV216 Auto Test FCC Power Bar - N

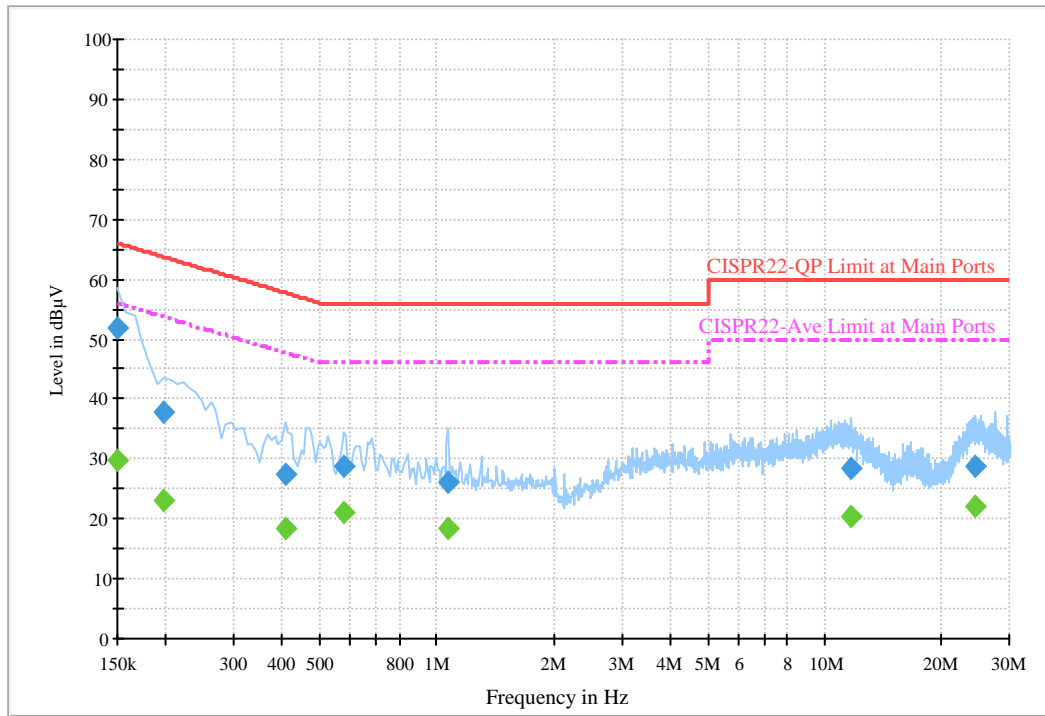

Final Result 1

Frequency (MHz)	QuasiPeak (dBµV)	Filter	Line	Corr. (dB)	Margin (dB)	Limit (dBµV)
0.150000	52.0	Off	N	19.5	14.0	66.0
0.198000	37.8	Off	N	19.5	25.9	63.7
0.406000	27.4	Off	N	19.5	30.3	57.7
0.574000	28.8	Off	N	19.5	27.2	56.0
1.070000	26.0	Off	N	19.6	30.0	56.0
11.774000	28.4	Off	N	20.2	31.6	60.0
24.510000	28.9	Off	N	20.9	31.1	60.0

Final Result 2

Frequency (MHz)	Average (dBµV)	Filter	Line	Corr. (dB)	Margin (dB)	Limit (dBµV)
0.150000	29.6	Off	N	19.5	26.4	56.0
0.198000	23.2	Off	N	19.5	30.5	53.7
0.406000	18.5	Off	N	19.5	29.2	47.7
0.574000	21.2	Off	N	19.5	24.8	46.0
1.070000	18.3	Off	N	19.6	27.7	46.0
11.774000	20.4	Off	N	20.2	29.6	50.0
24.510000	22.0	Off	N	20.9	28.0	50.0



Appendix C. Radiated Spurious Emission

Test Engineer :	Alex Jheng / Bill Chang / Wilson Wu	Temperature :	24.5~25.3°C
		Relative Humidity :	49~54%

2.4GHz 2400~2483.5MHz

WIFI 802.11b (Band Edge @ 3m)

WIFI Ant.	Note	Frequency (MHz)	Level (dBμV/m)	Over Limit (dB)	Limit Line (dBμV/m)	Read Level (dBμV)	Antenna Factor (dB/m)	Cable Loss (dB)	Preamp Factor (dB)	Ant Pos (cm)	Table Pos (deg)	Peak Avg. (P/A)	Pol. (H/V)	
802.11b CH 01 2412MHz		2314.515	51.43	-22.57	74	41.14	26.63	4.74	31.01	138	229	P	H	
		2389.59	40.41	-13.59	54	29.75	26.89	4.83	30.99	138	229	A	H	
	*	2412	97.23	-	-	86.48	26.94	4.87	30.99	138	229	P	H	
	*	2412	94.04	-	-	83.29	26.94	4.87	30.99	138	229	A	H	
													H	
														H
			2365.44	51.23	-22.77	74	40.7	26.79	4.8	30.99	400	280	P	V
			2390	40.42	-13.58	54	29.76	26.89	4.83	30.99	400	280	A	V
	*		2412	99.69	-	-	88.94	26.94	4.87	30.99	400	280	P	V
	*		2412	96.39	-	-	85.64	26.94	4.87	30.99	400	280	A	V
														V
														V
802.11b CH 06 2437MHz		2379.58	50.89	-23.11	74	40.28	26.84	4.83	30.99	134	231	P	H	
		2388.54	40.43	-13.57	54	29.77	26.89	4.83	30.99	134	231	A	H	
	*	2437	99.36	-	-	88.49	27.04	4.88	30.98	134	231	P	H	
	*	2437	96.09	-	-	85.22	27.04	4.88	30.98	134	231	A	H	
			2484.04	52.09	-21.91	74	41.05	27.15	4.93	30.97	134	231	P	H
			2484.11	40.79	-13.21	54	29.75	27.15	4.93	30.97	134	231	A	H
			2338.14	50.95	-23.05	74	40.53	26.73	4.76	31	400	272	P	V
			2386.02	40.47	-13.53	54	29.81	26.89	4.83	30.99	400	272	A	V
	*		2437	101.51	-	-	90.64	27.04	4.88	30.98	400	272	P	V
	*		2437	98.27	-	-	87.4	27.04	4.88	30.98	400	272	A	V
			2499.09	50.88	-23.12	74	39.78	27.2	4.93	30.96	400	272	P	V
			2483.69	40.85	-13.15	54	29.81	27.15	4.93	30.97	400	272	A	V



802.11b CH 11 2462MHz	*	2462	99.84	-	-	88.88	27.1	4.9	30.97	185	229	P	H
	*	2462	96.63	-	-	85.67	27.1	4.9	30.97	185	229	A	H
		2486.04	52.45	-21.55	74	41.41	27.15	4.93	30.97	185	229	P	H
		2485.76	41.03	-12.97	54	29.99	27.15	4.93	30.97	185	229	A	H
													H
													H
	*	2462	102.09	-	-	91.13	27.1	4.9	30.97	392	272	P	V
	*	2462	98.9	-	-	87.94	27.1	4.9	30.97	392	272	A	V
		2486	52.05	-21.95	74	41.01	27.15	4.93	30.97	392	272	P	V
		2483.52	41.08	-12.92	54	30.04	27.15	4.93	30.97	392	272	A	V
													V
													V
Remark	1. No other spurious found. 2. All results are PASS against Peak and Average limit line.												



**2.4GHz 2400~2483.5MHz
WIFI 802.11b (Harmonic @ 3m)**

WIFI Ant. 1	Note	Frequency (MHz)	Level (dBμV/m)	Over Limit (dB)	Limit Line (dBμV/m)	Read Level (dBμV)	Antenna Factor (dB/m)	Cable Loss (dB)	Preamp Factor (dB)	Ant Pos (cm)	Table Pos (deg)	Peak Avg. (P/A)	Pol. (H/V)
802.11b CH 01 2412MHz		4824	45.31	-28.69	74	63.15	31.56	7.33	57.24	100	0	P	H
													H
													H
													H
		4824	42.02	-31.98	74	59.86	31.56	7.33	57.24	100	0	P	V
													V
													V
802.11b CH 06 2437MHz		4874	41.45	-32.55	74	59.05	31.63	7.44	57.17	100	0	P	H
		7311	48.2	-25.8	74	59.72	36.16	9.13	57.27	100	0	P	H
													H
													H
		4874	38.14	-35.86	74	55.74	31.63	7.44	57.17	100	0	P	V
		7311	43.89	-30.11	74	55.41	36.16	9.13	57.27	100	0	P	V
													V
802.11b CH 11 2462MHz		4924	42.37	-31.63	74	59.75	31.7	7.52	57.1	100	0	P	H
		7386	48.06	-25.94	74	59.51	36.31	9.18	57.38	100	0	P	H
													H
													H
		4924	40.91	-33.09	74	58.29	31.7	7.52	57.1	100	0	P	V
		7386	45.23	-28.77	74	56.68	36.31	9.18	57.38	100	0	P	V
													V
Remark	1. No other spurious found.												
	2. All results are PASS against Peak and Average limit line.												



**2.4GHz 2400~2483.5MHz
WIFI 802.11g (Band Edge @ 3m)**

WIFI Ant. 1	Note	Frequency (MHz)	Level (dBμV/m)	Over Limit (dB)	Limit Line (dBμV/m)	Read Level (dBμV)	Antenna Factor (dB/m)	Cable Loss (dB)	Preamp Factor (dB)	Ant Pos (cm)	Table Pos (deg)	Peak Avg. (P/A)	Pol. (H/V)	
802.11g CH 01 2412MHz		2389.485	52.34	-21.66	74	41.68	26.89	4.83	30.99	272	231	P	H	
		2389.695	42.68	-11.32	54	32.02	26.89	4.83	30.99	272	231	A	H	
	*	2412	99.07	-	-	88.32	26.94	4.87	30.99	272	231	P	H	
	*	2412	90.86	-	-	80.11	26.94	4.87	30.99	272	231	A	H	
													H	
														H
			2390	55	-19	74	44.34	26.89	4.83	30.99	317	274	P	V
			2389.905	43.54	-10.46	54	32.88	26.89	4.83	30.99	317	274	A	V
	*		2412	101.3	-	-	90.55	26.94	4.87	30.99	317	274	P	V
	*		2412	93.33	-	-	82.58	26.94	4.87	30.99	317	274	A	V
														V
														V
802.11g CH 06 2437MHz		2376.78	52.31	-21.69	74	41.7	26.84	4.83	30.99	132	231	P	H	
		2369.64	41.43	-12.57	54	30.85	26.84	4.8	30.99	132	231	A	H	
	*	2437	99.73	-	-	88.86	27.04	4.88	30.98	132	231	P	H	
	*	2437	91.73	-	-	80.86	27.04	4.88	30.98	132	231	A	H	
			2489.92	52.15	-21.85	74	41.05	27.2	4.93	30.96	132	231	P	H
			2498.25	41.84	-12.16	54	30.74	27.2	4.93	30.96	132	231	A	H
			2389.38	51.97	-22.03	74	41.31	26.89	4.83	30.99	244	265	P	V
			2389.24	41.44	-12.56	54	30.78	26.89	4.83	30.99	244	265	A	V
	*		2437	101.31	-	-	90.44	27.04	4.88	30.98	244	265	P	V
	*		2437	93.12	-	-	82.25	27.04	4.88	30.98	244	265	A	V
			2489.99	52.2	-21.8	74	41.1	27.2	4.93	30.96	244	265	P	V
			2484.25	41.95	-12.05	54	30.91	27.15	4.93	30.97	244	265	A	V



802.11g CH 11 2462MHz	*	2462	98.9	-	-	87.94	27.1	4.9	30.97	260	232	P	H
	*	2462	91.25	-	-	80.29	27.1	4.9	30.97	260	232	A	H
		2483.64	52.38	-21.62	74	41.34	27.15	4.93	30.97	260	232	P	H
		2483.64	42.47	-11.53	54	31.43	27.15	4.93	30.97	260	232	A	H
													H
													H
	*	2462	101.79	-	-	90.83	27.1	4.9	30.97	208	259	P	V
	*	2462	93.66	-	-	82.7	27.1	4.9	30.97	208	259	A	V
		2484.28	52.28	-21.72	74	41.24	27.15	4.93	30.97	208	259	P	V
		2483.56	43.32	-10.68	54	32.28	27.15	4.93	30.97	208	259	A	V
													V
													V
Remark	1. No other spurious found. 2. All results are PASS against Peak and Average limit line.												



**2.4GHz 2400~2483.5MHz
WIFI 802.11g (Harmonic @ 3m)**

WIFI Ant. 1	Note	Frequency (MHz)	Level (dBμV/m)	Over Limit (dB)	Limit Line (dBμV/m)	Read Level (dBμV)	Antenna Factor (dB/m)	Cable Loss (dB)	Preamp Factor (dB)	Ant Pos (cm)	Table Pos (deg)	Peak Avg. (P/A)	Pol. (H/V)
802.11g CH 01 2412MHz		4824	40.02	-33.98	74	57.86	31.56	7.33	57.24	100	0	P	H
													H
													H
													H
		4824	38.97	-35.03	74	56.81	31.56	7.33	57.24	100	0	P	V
													V
													V
802.11g CH 06 2437MHz		4874	38.08	-35.92	74	55.68	31.63	7.44	57.17	100	0	P	H
		7311	43.51	-30.49	74	55.03	36.16	9.13	57.27	100	0	P	H
													H
													H
		4874	38.99	-35.01	74	56.59	31.63	7.44	57.17	100	0	P	V
		7311	44	-30	74	55.52	36.16	9.13	57.27	100	0	P	V
													V
802.11g CH 11 2462MHz		4924	39.32	-34.68	74	56.7	31.7	7.52	57.1	100	0	P	H
		7386	43.93	-30.07	74	55.38	36.31	9.18	57.38	100	0	P	H
													H
													H
		4924	39.42	-34.58	74	56.8	31.7	7.52	57.1	100	0	P	V
		7386	44.54	-29.46	74	55.99	36.31	9.18	57.38	100	0	P	V
													V
Remark	1. No other spurious found.												
	2. All results are PASS against Peak and Average limit line.												



**2.4GHz 2400~2483.5MHz
WIFI 802.11ac VHT20 (Band Edge @ 3m)**

WIFI Ant. 1	Note	Frequency (MHz)	Level (dBμV/m)	Over Limit (dB)	Limit Line (dBμV/m)	Read Level (dBμV)	Antenna Factor (dB/m)	Cable Loss (dB)	Preamp Factor (dB)	Ant Pos (cm)	Table Pos (deg)	Peak Avg. (P/A)	Pol. (H/V)	
802.11ac VHT20 CH 01 2412MHz		2389.695	52.9	-21.1	74	42.24	26.89	4.83	30.99	213	232	P	H	
		2390	43.42	-10.58	54	32.76	26.89	4.83	30.99	213	232	A	H	
	*	2412	98.43	-	-	87.68	26.94	4.87	30.99	213	232	P	H	
	*	2412	90.25	-	-	79.5	26.94	4.87	30.99	213	232	A	H	
													H	
														H
			2389.905	53.75	-20.25	74	43.09	26.89	4.83	30.99	288	264	P	V
			2390	44.26	-9.74	54	33.6	26.89	4.83	30.99	288	264	A	V
		*	2412	99.92	-	-	89.17	26.94	4.87	30.99	288	264	P	V
		*	2412	91.76	-	-	81.01	26.94	4.87	30.99	288	264	A	V
													V	
													V	
802.11ac VHT20 CH 06 2437MHz		2388.96	51.38	-22.62	74	40.72	26.89	4.83	30.99	226	229	P	H	
		2365.72	41.68	-12.32	54	31.15	26.79	4.8	30.99	226	229	A	H	
		* 2437	99.69	-	-	88.82	27.04	4.88	30.98	226	229	P	H	
		* 2437	91.39	-	-	80.52	27.04	4.88	30.98	226	229	A	H	
			2485.86	52.26	-21.74	74	41.22	27.15	4.93	30.97	226	229	P	H
			2485.51	41.74	-12.26	54	30.7	27.15	4.93	30.97	226	229	A	H
			2359.98	51.64	-22.36	74	41.12	26.79	4.8	31	246	253	P	V
			2388.82	41.58	-12.42	54	30.92	26.89	4.83	30.99	246	253	A	V
		*	2437	101.59	-	-	90.72	27.04	4.88	30.98	246	253	P	V
		*	2437	93.22	-	-	82.35	27.04	4.88	30.98	246	253	A	V
		2499.16	51.36	-22.64	74	40.26	27.2	4.93	30.96	246	253	P	V	
		2485.09	42	-12	54	30.96	27.15	4.93	30.97	246	253	A	V	



802.11ac VHT20 CH 11 2462MHz	*	2462	98.46	-	-	87.5	27.1	4.9	30.97	287	233	P	H
	*	2462	89.9	-	-	78.94	27.1	4.9	30.97	287	233	A	H
		2483.92	52.54	-21.46	74	41.5	27.15	4.93	30.97	287	233	P	H
		2483.52	42.58	-11.42	54	31.54	27.15	4.93	30.97	287	233	A	H
													H
													H
	*	2462	99.74	-	-	88.78	27.1	4.9	30.97	276	252	P	V
	*	2462	92.33	-	-	81.37	27.1	4.9	30.97	276	252	A	V
		2484.2	53.53	-20.47	74	42.49	27.15	4.93	30.97	276	252	P	V
		2483.8	43.2	-10.8	54	32.16	27.15	4.93	30.97	276	252	A	V
												V	
												V	
Remark	1. No other spurious found. 2. All results are PASS against Peak and Average limit line.												



**2.4GHz 2400~2483.5MHz
WIFI 802.11ac VHT20 (Harmonic @ 3m)**

WIFI Ant. 1	Note	Frequency (MHz)	Level (dBμV/m)	Over Limit (dB)	Limit Line (dBμV/m)	Read Level (dBμV)	Antenna Factor (dB/m)	Cable Loss (dB)	Preamp Factor (dB)	Ant Pos (cm)	Table Pos (deg)	Peak Avg. (P/A)	Pol. (H/V)	
802.11ac VHT20 CH 01 2412MHz		4824	39.34	-34.66	74	57.18	31.56	7.33	57.24	100	0	P	H	
													H	
													H	
													H	
			4824	39.9	-34.1	74	57.74	31.56	7.33	57.24	100	0	P	V
														V
														V
802.11ac VHT20 CH 06 2437MHz		4874	38.98	-35.02	74	56.58	31.63	7.44	57.17	100	0	P	H	
		7311	44.08	-29.92	74	55.6	36.16	9.13	57.27	100	0	P	H	
													H	
													H	
			4874	38.65	-35.35	74	56.25	31.63	7.44	57.17	100	0	P	V
			7311	44.36	-29.64	74	55.88	36.16	9.13	57.27	100	0	P	V
														V
802.11ac VHT20 CH 11 2462MHz		4924	40.52	-33.48	74	57.9	31.7	7.52	57.1	100	0	P	H	
		7386	44.32	-29.68	74	55.77	36.31	9.18	57.38	100	0	P	H	
													H	
													H	
			4924	38.77	-35.23	74	56.15	31.7	7.52	57.1	100	0	P	V
			7386	44.83	-29.17	74	56.28	36.31	9.18	57.38	100	0	P	V
														V
Remark	1. No other spurious found.													
	2. All results are PASS against Peak and Average limit line.													



2.4GHz 2400~2483.5MHz

Emission below 1GHz

2.4GHz WIFI 802.11b (LF)

WIFI Ant.	Note	Frequency	Level	Over Limit	Limit Line	Read Level	Antenna Factor	Cable Loss	Preamp Factor	Ant Pos	Table Pos	Peak Avg.	Pol.	
1		(MHz)	(dBμV/m)	(dB)	(dBμV/m)	(dBμV)	(dB/m)	(dB)	(dB)	(cm)	(deg)	(P/A)	(H/V)	
2.4GHz 802.11b LF		30	20.97	-19.03	40	30.11	22.63	0.59	32.34	-	-	P	H	
		103.98	16.69	-26.81	43.5	34.06	13.8	1	32.29	-	-	P	H	
		260.58	16.65	-29.35	46	30.4	16.72	1.63	32.18	-	-	P	H	
		587	23.3	-22.7	46	30.62	22.4	2.39	32.21	-	-	P	H	
		832	28.79	-17.21	46	31.79	25.87	2.84	31.84	100	0	P	H	
		969.2	31.03	-22.97	54	30.45	28.25	3.07	30.88	-	-	P	H	
														H
														H
														H
														H
														H
														H
			30.81	26.14	-13.86	40	36.11	21.8	0.59	32.34	100	0	P	V
			37.29	21.76	-18.24	40	37.46	16.04	0.59	32.33	-	-	P	V
			81.03	19.18	-20.82	40	39.91	10.55	0.95	32.3	-	-	P	V
			640.9	24.52	-21.48	46	30.61	23.5	2.48	32.19	-	-	P	V
			832	30.82	-15.18	46	33.82	25.87	2.84	31.84	-	-	P	V
			964.3	30.52	-23.48	54	29.81	28.43	3.07	30.93	-	-	P	V
													V	
													V	
													V	
													V	
													V	
													V	
Remark	1. No other spurious found. 2. All results are PASS against limit line.													



Emission below 1GHz
2.4GHz WIFI 802.11g (LF)

WIFI	Note	Frequency	Level	Over	Limit	Read	Antenna	Cable	Preamp	Ant	Table	Peak	Pol.	
Ant.				Limit	Line	Level	Factor	Loss	Factor	Pos	Pos	Avg.		
1		(MHz)	(dBμV/m)	(dB)	(dBμV/m)	(dBμV)	(dB/m)	(dB)	(dB)	(cm)	(deg)	(P/A)	(H/V)	
2.4GHz 802.11g LF		30	21.34	-18.66	40	30.48	22.63	0.59	32.34	-	-	P	H	
		37.29	16.39	-23.61	40	32.09	16.04	0.59	32.33	-	-	P	H	
		100.2	16.97	-26.53	43.5	35.31	12.81	1	32.29	-	-	P	H	
		713.7	27.63	-18.37	46	32.9	24.13	2.64	32.14	-	-	P	H	
		887.3	29.99	-16.01	46	32.26	26.25	2.94	31.57	-	-	P	H	
		946.1	30.62	-15.38	46	30.87	27.64	3.06	31.09	100	0	P	H	
													H	
													H	
													H	
													H	
													H	
													H	
			31.08	25.67	-14.33	40	35.64	21.8	0.59	32.34	100	0	P	V
			37.29	20.95	-19.05	40	36.65	16.04	0.59	32.33	-	-	P	V
			48.36	21.07	-18.93	40	41.52	11.11	0.74	32.32	-	-	P	V
			435.1	29.92	-16.08	46	40.45	19.46	2.1	32.17	-	-	P	V
			696.2	25.21	-20.79	46	31.11	23.55	2.62	32.17	-	-	P	V
			832	30.01	-15.99	46	33.01	25.87	2.84	31.84	-	-	P	V
														V
														V
													V	
													V	
													V	
													V	
Remark	1. No other spurious found. 2. All results are PASS against limit line.													



Emission below 1GHz

2.4GHz WIFI 802.11ac VHT20 (LF)

WIFI	Note	Frequency	Level	Over	Limit	Read	Antenna	Cable	Preamp	Ant	Table	Peak	Pol.	
Ant.				Limit	Line	Level	Factor	Loss	Factor	Pos	Pos	Avg.		
1		(MHz)	(dBμV/m)	(dB)	(dBμV/m)	(dBμV)	(dB/m)	(dB)	(dB)	(cm)	(deg)	(P/A)	(H/V)	
2.4GHz 802.11ac VHT20 LF		30	21.67	-18.33	40	30.81	22.63	0.59	32.34	-	-	P	H	
		110.73	16.03	-27.47	43.5	32.77	14.44	1	32.29	-	-	P	H	
		260.31	16.82	-29.18	46	30.52	16.78	1.63	32.19	-	-	P	H	
		793.5	27.5	-18.5	46	31.49	25.14	2.75	32	-	-	P	H	
		892.9	29.68	-16.32	46	31.82	26.35	2.94	31.54	-	--	P	H	
		951.7	31.51	-14.49	46	31.33	28.02	3.06	31.04	100	0	P	H	
														H
														H
														H
														H
														H
														H
			30.81	25.72	-14.28	40	35.69	21.8	0.59	32.34	100	0	P	V
			37.29	21.04	-18.96	40	36.74	16.04	0.59	32.33	-	-	P	V
			91.02	20.46	-23.04	43.5	41.48	10.25	0.95	32.3	-	-	P	V
			720.7	28.13	-17.87	46	33.14	24.38	2.64	32.13	-	-	P	V
			832	31.71	-14.29	46	34.71	25.87	2.84	31.84	-	-	P	V
			955.2	30.51	-15.49	46	30.05	28.27	3.06	31.01	-	-	P	V
													V	
													V	
													V	
													V	
													V	
													V	
Remark	1. No other spurious found. 2. All results are PASS against limit line.													



Note symbol

*	Fundamental Frequency which can be ignored. However, the level of any unwanted emissions shall not exceed the level of the fundamental frequency.
!	Test result is over limit line.
P/A	Peak or Average
H/V	Horizontal or Vertical



A calculation example for radiated spurious emission is shown as below:

WIFI	Note	Frequency	Level	Over	Limit	Read	Antenna	Cable	Preamp	Ant	Table	Peak	Pol.
Ant.				Limit	Line	Level	Factor	Loss	Factor	Pos	Pos	Avg.	
1		(MHz)	(dBμV/m)	(dB)	(dBμV/m)	(dBμV)	(dB/m)	(dB)	(dB)	(cm)	(deg)	(P/A)	(H/V)
802.11b		2390	55.45	-18.55	74	54.51	32.22	4.58	35.86	103	308	P	H
CH 01													
2412MHz		2390	43.54	-10.46	54	42.6	32.22	4.58	35.86	103	308	A	H

- Level(dBμV/m) =
Antenna Factor(dB/m) + Cable Loss(dB) + Read Level(dBμV) - Preamp Factor(dB)
- Over Limit(dB) = Level(dBμV/m) – Limit Line(dBμV/m)

For Peak Limit @ 2390MHz:

- Level(dBμV/m)
= Antenna Factor(dB/m) + Cable Loss(dB) + Read Level(dBμV) - Preamp Factor(dB)
= 32.22(dB/m) + 4.58(dB) + 54.51(dBμV) – 35.86 (dB)
= 55.45 (dBμV/m)
- Over Limit(dB)
= Level(dBμV/m) – Limit Line(dBμV/m)
= 55.45(dBμV/m) – 74(dBμV/m)
= -18.55(dB)

For Average Limit @ 2390MHz:

- Level(dBμV/m)
= Antenna Factor(dB/m) + Cable Loss(dB) + Read Level(dBμV) - Preamp Factor(dB)
= 32.22(dB/m) + 4.58(dB) + 42.6(dBμV) – 35.86 (dB)
= 43.54 (dBμV/m)
- Over Limit(dB)
= Level(dBμV/m) – Limit Line(dBμV/m)
= 43.54(dBμV/m) – 54(dBμV/m)
= -10.46(dB)

Both peak and average measured complies with the limit line, so test result is “PASS”.



Appendix D. Radiated Spurious Emission Plots

Test Engineer :	Alex Jheng / Bill Chang / Wilson Wu	Temperature :	24.5~25.3°C
		Relative Humidity :	49~54%

Note symbol

-L	Low channel location
-R	High channel location



2.4GHz 2400~2483.5MHz
WIFI 802.11b (Band Edge @ 3m)

WIFI	2.4GHz 2400~2483.5MHz Band Edge @ 3m	
ANT	802.11b CH01 2412MHz	
1	Horizontal	Fundamental
Peak	<p>Site : 03CH13-HY Condition : PEAK BE 74 3m HORN 9120D 1241 HORIZONTAL</p>	<p>Site : 03CH13-HY Condition : PEAK 74 3m HORN 9120D 1241 HORIZONTAL</p>
Avg.	<p>Site : 03CH13-HY Condition : AVG BE 54 3m HORN 9120D 1241 HORIZONTAL</p>	<p>Site : 03CH13-HY Condition : AVG 54 3m HORN 9120D 1241 HORIZONTAL</p>



WIFI	2.4GHz 2400~2483.5MHz Band Edge @ 3m	
ANT	802.11b CH01 2412MHz	
1	Vertical	Fundamental
Peak	<p>Site : 03CH13-HY Condition : PEAK BE 74 3m HORN 9120D 1241 VERTICAL</p>	<p>Site : 03CH13-HY Condition : PEAK 74 3m HORN 9120D 1241 VERTICAL</p>
Avg.	<p>Site : 03CH13-HY Condition : AVG BE 54 3m HORN 9120D 1241 VERTICAL</p>	<p>Site : 03CH13-HY Condition : AVG 54 3m HORN 9120D 1241 VERTICAL</p>



WIFI	2.4GHz 2400~2483.5MHz Band Edge @ 3m	
ANT	802.11b CH06 2437MHz - L	
1	Horizontal	Fundamental
Peak	<p>Site : 03CH13-HY Condition : PEAK BE 74 3m HORN 9120D 1241 HORIZONTAL</p>	<p>Site : 03CH13-HY Condition : PEAK 74 3m HORN 9120D 1241 HORIZONTAL</p>
Avg.	<p>Site : 03CH13-HY Condition : AVG BE 54 3m HORN 9120D 1241 HORIZONTAL</p>	<p>Site : 03CH13-HY Condition : AVG 54 3m HORN 9120D 1241 HORIZONTAL</p>

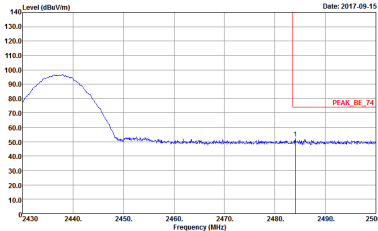
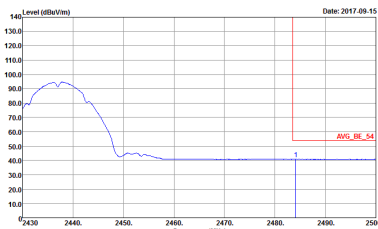

WIFI	2.4GHz 2400~2483.5MHz Band Edge @ 3m	
ANT	802.11b CH06 2437MHz - R	
1	Horizontal	Fundamental
<p>Peak</p>	 <p>Site : 03CH13-HY Condition : PEAK BE 74 3m HORN 9120D 1241 HORIZONTAL</p>	<p>Left blank</p>
<p>Avg.</p>	 <p>Site : 03CH13-HY Condition : AVG BE 54 3m HORN 9120D 1241 HORIZONTAL</p>	<p>Left blank</p>



WIFI	2.4GHz 2400~2483.5MHz Band Edge @ 3m	
ANT	802.11b CH06 2437MHz - L	
1	Vertical	Fundamental
Peak	<p>Site : 03CH13-HY Condition : PEAK BE 74 3m HORN 9120D 1241 VERTICAL</p>	<p>Site : 03CH13-HY Condition : PEAK 74 3m HORN 9120D 1241 VERTICAL</p>
Avg.	<p>Site : 03CH13-HY Condition : AVG BE 54 3m HORN 9120D 1241 VERTICAL</p>	<p>Site : 03CH13-HY Condition : AVG 54 3m HORN 9120D 1241 VERTICAL</p>



WIFI	2.4GHz 2400~2483.5MHz Band Edge @ 3m	
ANT	802.11b CH06 2437MHz - R	
1	Vertical	Fundamental
Peak	<p>Site : 03CH13-HY Condition : PEAK_BE_74 3m HORN 9120D 1241 VERTICAL</p>	Left blank
Avg.	<p>Site : 03CH13-HY Condition : AVG_BE_54 3m HORN 9120D 1241 VERTICAL</p>	Left blank



WIFI	2.4GHz 2400~2483.5MHz Band Edge @ 3m	
ANT	802.11b CH11 2462MHz	
1	Horizontal	Fundamental
Peak	<p>Site : 03CH13-HY Condition : PEAK BE 74 3m HORN 9120D 1241 HORIZONTAL</p>	<p>Site : 03CH13-HY Condition : PEAK 74 3m HORN 9120D 1241 HORIZONTAL</p>
Avg.	<p>Site : 03CH13-HY Condition : AVG BE 54 3m HORN 9120D 1241 HORIZONTAL</p>	<p>Site : 03CH13-HY Condition : AVG 54 3m HORN 9120D 1241 HORIZONTAL</p>



WIFI	2.4GHz 2400~2483.5MHz Band Edge @ 3m	
ANT	802.11b CH11 2462MHz	
1	Vertical	Fundamental
Peak	<p>Site : 03CH13-HY Condition : PEAK BE 74 3m HORN 9120D 1241 VERTICAL</p>	<p>Site : 03CH13-HY Condition : PEAK 74 3m HORN 9120D 1241 VERTICAL</p>
Avg.	<p>Site : 03CH13-HY Condition : AVG BE 54 3m HORN 9120D 1241 VERTICAL</p>	<p>Site : 03CH13-HY Condition : AVG 54 3m HORN 9120D 1241 VERTICAL</p>

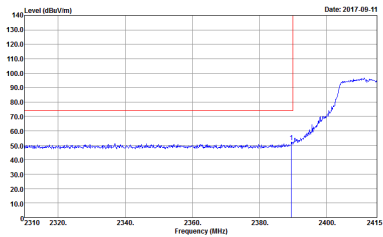
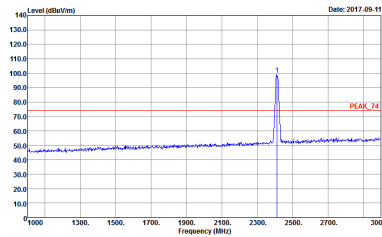
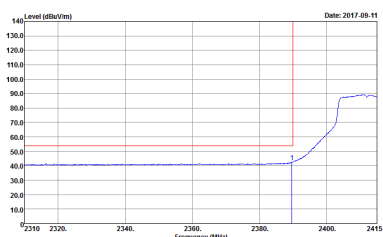
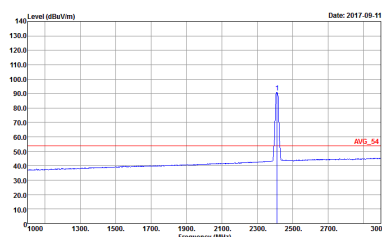

2.4GHz 2400~2483.5MHz
WIFI 802.11g (Band Edge @ 3m)

WIFI	2.4GHz 2400~2483.5MHz Band Edge @ 3m	
ANT	802.11g CH01 2412MHz	
1	Horizontal	Fundamental
Peak	 <p>Site : 03CH13-HY Condition : PEAK BE 74 3m HORN 9120D 1241 HORIZONTAL</p>	 <p>Site : 03CH13-HY Condition : PEAK 74 3m HORN 9120D 1241 HORIZONTAL</p>
Avg.	 <p>Site : 03CH13-HY Condition : AVG BE 54 3m HORN 9120D 1241 HORIZONTAL</p>	 <p>Site : 03CH13-HY Condition : AVG 54 3m HORN 9120D 1241 HORIZONTAL</p>



WIFI	2.4GHz 2400~2483.5MHz Band Edge @ 3m	
ANT	802.11g CH01 2412MHz	
1	Vertical	Fundamental
Peak	<p>Site : 03CH13-HY Condition : PEAK BE 74 3m HORN 9120D 1241 VERTICAL</p>	<p>Site : 03CH13-HY Condition : PEAK 74 3m HORN 9120D 1241 VERTICAL</p>
Avg.	<p>Site : 03CH13-HY Condition : AVG BE 54 3m HORN 9120D 1241 VERTICAL</p>	<p>Site : 03CH13-HY Condition : AVG 54 3m HORN 9120D 1241 VERTICAL</p>



WIFI	2.4GHz 2400~2483.5MHz Band Edge @ 3m	
ANT	802.11g CH06 2437MHz - L	
1	Horizontal	Fundamental
Peak	<p>Site : 03CH13-HY Condition : PEAK BE 74 3m HORN 9120D 1241 HORIZONTAL</p>	<p>Site : 03CH13-HY Condition : PEAK 74 3m HORN 9120D 1241 HORIZONTAL</p>
Avg.	<p>Site : 03CH13-HY Condition : AVG BE 54 3m HORN 9120D 1241 HORIZONTAL</p>	<p>Site : 03CH13-HY Condition : AVG 54 3m HORN 9120D 1241 HORIZONTAL</p>



WIFI	2.4GHz 2400~2483.5MHz Band Edge @ 3m	
ANT	802.11g CH06 2437MHz - R	
1	Horizontal	Fundamental
Peak	<p>Site : 03CH13-HY Condition : PEAK_BE 74 3m HORN 9120D 1241 HORIZONTAL</p>	Left blank
Avg.	<p>Site : 03CH13-HY Condition : AVG_BE 54 3m HORN 9120D 1241 HORIZONTAL</p>	Left blank



WIFI	2.4GHz 2400~2483.5MHz Band Edge @ 3m	
ANT	802.11g CH06 2437MHz - L	
1	Vertical	Fundamental
Peak	<p>Site : 03CH13-HY Condition : PEAK BE 74 3m HORN 9120D 1241 VERTICAL</p>	<p>Site : 03CH13-HY Condition : PEAK 74 3m HORN 9120D 1241 VERTICAL</p>
Avg.	<p>Site : 03CH13-HY Condition : AV6 BE 54 3m HORN 9120D 1241 VERTICAL</p>	<p>Site : 03CH13-HY Condition : AV6 54 3m HORN 9120D 1241 VERTICAL</p>



WIFI	2.4GHz 2400~2483.5MHz Band Edge @ 3m	
ANT	802.11g CH06 2437MHz - R	
1	Vertical	Fundamental
Peak	<p>Site : 03CH13-HY Condition : PEAK_BE 74 3m HORN 9120D 1241 VERTICAL</p>	Left Blank
Avg.	<p>Site : 03CH13-HY Condition : AVG_BE 54 3m HORN 9120D 1241 VERTICAL</p>	Left Blank



WIFI	2.4GHz 2400~2483.5MHz Band Edge @ 3m	
ANT	802.11g CH11 2462MHz	
1	Horizontal	Fundamental
Peak	<p>Site : 03CH13-HY Condition : PEAK BE 74 3m HORN 9120D 1241 HORIZONTAL</p>	<p>Site : 03CH13-HY Condition : PEAK 74 3m HORN 9120D 1241 HORIZONTAL</p>
Avg.	<p>Site : 03CH13-HY Condition : AV6 BE 54 3m HORN 9120D 1241 HORIZONTAL</p>	<p>Site : 03CH13-HY Condition : AV6 54 3m HORN 9120D 1241 HORIZONTAL</p>



WIFI	2.4GHz 2400~2483.5MHz Band Edge @ 3m	
ANT	802.11g CH11 2462MHz	
1	Vertical	Fundamental
Peak	<p>Site : 03CH13-HY Condition : PEAK BE 74 3m HORN 9120D 1241 VERTICAL</p>	<p>Site : 03CH13-HY Condition : PEAK 74 3m HORN 9120D 1241 VERTICAL</p>
Avg.	<p>Site : 03CH13-HY Condition : AVG BE 54 3m HORN 9120D 1241 VERTICAL</p>	<p>Site : 03CH13-HY Condition : AVG 54 3m HORN 9120D 1241 VERTICAL</p>



2.4GHz 2400~2483.5MHz
WIFI 802.11ac VHT20 (Band Edge @ 3m)

WIFI	2.4GHz 2400~2483.5MHz Band Edge @ 3m	
ANT	802.11ac VHT20 CH01 2412MHz	
1	Horizontal	Fundamental
Peak	<p>Site : 03CH13-HY Condition : PEAK BE 74 3m HORN 9120D 1241 HORIZONTAL</p>	<p>Site : 03CH13-HY Condition : PEAK 74 3m HORN 9120D 1241 HORIZONTAL</p>
Avg.	<p>Site : 03CH13-HY Condition : AVG BE 54 3m HORN 9120D 1241 HORIZONTAL</p>	<p>Site : 03CH13-HY Condition : AVG 54 3m HORN 9120D 1241 HORIZONTAL</p>



WIFI	2.4GHz 2400~2483.5MHz Band Edge @ 3m	
ANT	802.11ac VHT20 CH01 2412MHz	
1	Vertical	Fundamental
Peak	<p>Site : 03CH13-HY Condition : PEAK BE 74 3m HORN 9120D 1241 VERTICAL</p>	<p>Site : 03CH13-HY Condition : PEAK 74 3m HORN 9120D 1241 VERTICAL</p>
Avg.	<p>Site : 03CH13-HY Condition : AV6 BE 54 3m HORN 9120D 1241 VERTICAL</p>	<p>Site : 03CH13-HY Condition : AV6 54 3m HORN 9120D 1241 VERTICAL</p>



WIFI	2.4GHz 2400~2483.5MHz Band Edge @ 3m	
ANT	802.11ac VHT20 CH06 2437MHz - L	
1	Horizontal	Fundamental
Peak	<p>Site : 03CH13-HY Condition : PEAK BE 74 3m HORN 9120D 1241 HORIZONTAL</p>	<p>Site : 03CH13-HY Condition : PEAK 74 3m HORN 9120D 1241 HORIZONTAL</p>
Avg.	<p>Site : 03CH13-HY Condition : AVG BE 54 3m HORN 9120D 1241 HORIZONTAL</p>	<p>Site : 03CH13-HY Condition : AVG 54 3m HORN 9120D 1241 HORIZONTAL</p>



WIFI	2.4GHz 2400~2483.5MHz Band Edge @ 3m	
ANT	802.11ac VH20 CH06 2437MHz - R	
1	Horizontal	Fundamental
Peak	<p>Site : 03CH13-HY Condition : PEAK_BE 74 3m HORN 9120D 1241 HORIZONTAL</p>	Left blank
Avg.	<p>Site : 03CH13-HY Condition : AVG_BE 54 3m HORN 9120D 1241 HORIZONTAL</p>	Left blank



WIFI	2.4GHz 2400~2483.5MHz Band Edge @ 3m	
ANT	802.11ac VH20 CH06 2437MHz - L	
1	Vertical	Fundamental
Peak	<p>Site : 03CH13-HY Condition : PEAK BE 74 3m HORN 9120D 1241 VERTICAL</p>	<p>Site : 03CH13-HY Condition : PEAK 74 3m HORN 9120D 1241 VERTICAL</p>
Avg.	<p>Site : 03CH13-HY Condition : AV6 BE 54 3m HORN 9120D 1241 VERTICAL</p>	<p>Site : 03CH13-HY Condition : AV6 54 3m HORN 9120D 1241 VERTICAL</p>



WIFI	2.4GHz 2400~2483.5MHz Band Edge @ 3m	
ANT	802.11ac VH20 CH06 2437MHz - R	
1	Vertical	Fundamental
Peak	<p>Site : 03CH13-HY Condition : PEAK_BE_74 3m HORN 9120D 1241 VERTICAL</p>	Left blank
Avg.	<p>Site : 03CH13-HY Condition : AVG_BE_54 3m HORN 9120D 1241 VERTICAL</p>	Left blank



WIFI	2.4GHz 2400~2483.5MHz Band Edge @ 3m	
ANT	802.11ac VH20 CH11 2462MHz	
1	Horizontal	Fundamental
Peak	<p>Site : 03CH3-HY Condition : PEAK_BE_74 3m HORN_91200_1241 HORIZONTAL</p>	<p>Site : 03CH3-HY Condition : PEAK 74 3m HORN 91200 1241 HORIZONTAL</p>
Avg.	<p>Site : 03CH3-HY Condition : AVG_BE_54 3m HORN_91200_1241 HORIZONTAL</p>	<p>Site : 03CH3-HY Condition : AVG 54 3m HORN 91200 1241 HORIZONTAL</p>



WIFI	2.4GHz 2400~2483.5MHz Band Edge @ 3m	
ANT	802.11ac VH20 CH11 2462MHz	
1	Vertical	Fundamental
Peak		
Avg.		



**2.4GHz 2400~2483.5MHz
WIFI 802.11b (Harmonic @ 3m)**

WIFI	2.4GHz 2400~2483.5MHz Harmonic @ 3m	
ANT	802.11b CH01 2412MHz	
1	Horizontal	Vertical
Peak Avg.	<p>Site : 03CH13-HY Condition : PEAK 74 3m SHF HORN 584 HORIZONTAL</p>	<p>Site : 03CH13-HY Condition : PEAK 74 3m SHF HORN 584 VERTICAL</p>



WIFI	2.4GHz 2400~2483.5MHz Harmonic @ 3m	
ANT	802.11b CH06 2437MHz	
1	Horizontal	Vertical
Peak Avg.	<p>Site : 03CH13-11Y Condition : PEAK 74 3m SHF HORN 584 HORIZONTAL</p>	<p>Site : 03CH13-11Y Condition : PEAK 74 3m SHF HORN 584 VERTICAL</p>



WIFI	2.4GHz 2400~2483.5MHz Harmonic @ 3m	
ANT	802.11b CH11 2462MHz	
1	Horizontal	Vertical
Peak Avg.	<p>Site : 03CH13-11Y Condition : PEAK 74 3m SHF HORN 584 HORIZONTAL</p>	<p>Site : 03CH13-11Y Condition : PEAK 74 3m SHF HORN 584 VERTICAL</p>



2.4GHz 2400~2483.5MHz
 WIFI 802.11g (Harmonic @ 3m)

WIFI	2.4GHz 2400~2483.5MHz Harmonic @ 3m	
ANT	802.11g CH01 2412MHz	
1	Horizontal	Vertical
Peak Avg.		

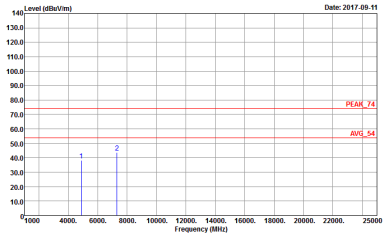
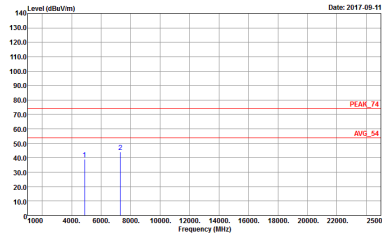

WIFI	2.4GHz 2400~2483.5MHz Harmonic @ 3m	
ANT	802.11g CH06 2437MHz	
1	Horizontal	Vertical
Peak Avg.	 <p>Site : 03CH13-HY Condition : PEAK 74 3m SHF HORN 584 HORIZONTAL</p>	 <p>Site : 03CH13-HY Condition : PEAK 74 3m SHF HORN 584 VERTICAL</p>



WIFI	2.4GHz 2400~2483.5MHz Harmonic @ 3m	
ANT	802.11g CH11 2462MHz	
1	Horizontal	Vertical
Peak Avg.	<p>Site : 03CH13-HY Condition : PEAK 74 3m SHF HORN 584 HORIZONTAL</p>	<p>Site : 03CH13-HY Condition : PEAK 74 3m SHF HORN 584 VERTICAL</p>



2.4GHz 2400~2483.5MHz
WIFI 802.11ac VHT20 (Harmonic @ 3m)

WIFI	2.4GHz 2400~2483.5MHz Harmonic @ 3m	
ANT	802.11ac VHT20 CH01 2412MHz	
1	Horizontal	Vertical
Peak Avg.	<p>Site : 03CH13-14Y Condition : PEAK 74 3m SHF HORN 584 HORIZONTAL</p>	<p>Site : 03CH13-14Y Condition : PEAK 74 3m SHF HORN 584 VERTICAL</p>



WIFI	2.4GHz 2400~2483.5MHz Harmonic @ 3m	
ANT	802.11ac VHT20 CH06 2437MHz	
1	Horizontal	Vertical
Peak Avg.	<p>Site : 03CH13-HY Condition : PEAK 74 3m SHF HORN 584 HORIZONTAL</p>	<p>Site : 03CH13-HY Condition : PEAK 74 3m SHF HORN 584 VERTICAL</p>



WIFI	2.4GHz 2400~2483.5MHz Harmonic @ 3m	
ANT	802.11ac VHT20 CH11 2462MHz	
1	Horizontal	Vertical
Peak Avg.	<p>Site : 03CH13-HY Condition : PEAK 74 3m SHF HORN 584 HORIZONTAL</p>	<p>Site : 03CH13-HY Condition : PEAK 74 3m SHF HORN 584 VERTICAL</p>



Emission below 1GHz
2.4GHz WIFI 802.11b (LF)

WIFI	2.4GHz 2400~2483.5MHz	
ANT	802.11b LF	
1	Horizontal	Vertical
QP / Peak	<p>Site : 03CH13-HY Condition : QP-3m B1LOG 40103 HORIZONTAL</p>	<p>Site : 03CH13-HY Condition : QP-3m B1LOG 40103 VERTICAL</p>



Emission below 1GHz
2.4GHz WIFI 802.11g (LF)

WIFI	2.4GHz 2400~2483.5MHz	
ANT	802.11g LF	
1	Horizontal	Vertical
QP / Peak	<p>Site : 03CH13-HY Condition : QP 3m B1LOG 40103 HORIZONTAL</p>	<p>Site : 03CH13-HY Condition : QP 3m B1LOG 40103 VERTICAL</p>



Emission below 1GHz
2.4GHz WIFI 802.11ac VHT20 (LF)

WIFI	2.4GHz 2400~2483.5MHz	
ANT	802.11ac VHT20 LF	
1	Horizontal	Vertical
QP / Peak	<p>Site : 03CH13-HY Condition : QP-3m-BELOG 40103 HORIZONTAL</p>	<p>Site : 03CH13-HY Condition : QP-3m-BELOG 40103 VERTICAL</p>



Appendix E. Duty Cycle Plots

Band	Duty Cycle(%)	T(us)	1/T(kHz)	VBW Setting
802.11b	98.54	-	-	10Hz
802.11g	92.95	2030	0.49	1kHz
802.11ac VHT20	92.49	1897	0.53	1kHz

802.11b

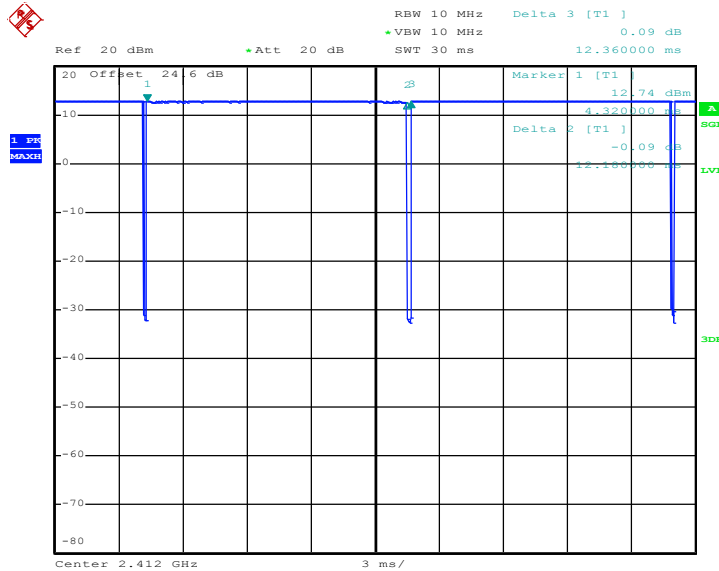

Date: 10.AUG.2017 17:16:46



802.11g

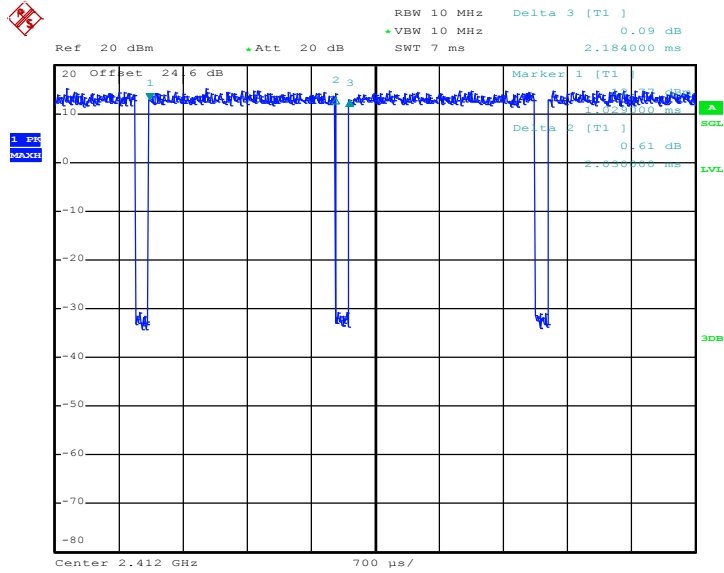

Date: 10.AUG.2017 17:21:12

802.11ac VHT20

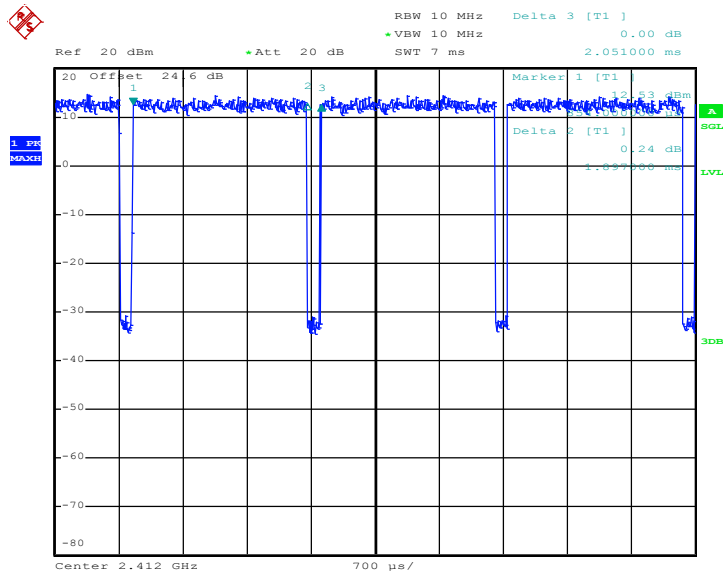

Date: 10.AUG.2017 17:24:05