



CERTIFICATION TEST REPORT

Report Number. : 12132671-E5V2

Applicant : SONY MOBILE COMMUNICATIONS, INC.
4-12-3 HIGASHI-SHINAGAWA,
SHINAGAWA -KU, TOKYO, 140-0002, JAPAN

FCC ID : PY7-11821Y

EUT Description : GSM/WCDMA/LTE Phone with BT, DTS/UNII a/b/g/n/ac &
NFC

Test Standard(s) : FCC 47 CFR PART 15 SUBPART E (EXCEPT DFS)

Date Of Issue:
MARCH 08, 2018

Prepared by:
UL Verification Services Inc.
47173 Benicia Street
Fremont, CA 94538, U.S.A.
TEL: (510) 771-1000
FAX: (510) 661-0888



REPORT REVISION HISTORY

Rev.	Issue Date	Revisions	Revised By
V1	3/6/2018	Initial Issue	
V2	3/8/2018	Updated Section 1, 5.4, 5.6 and 7	Kiya Kedida

TABLE OF CONTENTS

REPORT REVISION HISTORY	2
TABLE OF CONTENTS	3
1. ATTESTATION OF TEST RESULTS	6
2. TEST METHODOLOGY	7
3. FACILITIES AND ACCREDITATION	7
4. CALIBRATION AND UNCERTAINTY	7
4.1. <i>MEASURING INSTRUMENT CALIBRATION</i>	<i>7</i>
4.2. <i>SAMPLE CALCULATION</i>	<i>7</i>
4.3. <i>MEASUREMENT UNCERTAINTY.....</i>	<i>8</i>
5. EQUIPMENT UNDER TEST.....	9
5.1. <i>EUT DESCRIPTION.....</i>	<i>9</i>
5.1. <i>MAXIMUM OUTPUT POWER.....</i>	<i>9</i>
5.2. <i>DESCRIPTION OF AVAILABLE ANTENNAS.....</i>	<i>10</i>
5.3. <i>SOFTWARE AND FIRMWARE.....</i>	<i>10</i>
5.4. <i>LIST OF TEST REDUCTION AND MODES.....</i>	<i>10</i>
5.5. <i>WORST-CASE CONFIGURATION AND MODE.....</i>	<i>11</i>
5.6. <i>DESCRIPTION OF TEST SETUP.....</i>	<i>12</i>
6. MEASUREMENT METHOD.....	15
7. TEST AND MEASUREMENT EQUIPMENT	16
8. ANTENNA PORT TEST RESULTS.....	17
8.1. <i>ON TIME AND DUTY CYCLE.....</i>	<i>17</i>
8.2. <i>26 dB BANDWIDTH.....</i>	<i>19</i>
8.2.1. <i>802.11a 2TX CDD MODE IN THE 5.2 GHz BAND.....</i>	<i>20</i>
8.2.2. <i>802.11n HT20 2TX CDD MODE IN THE 5.2 GHz BAND</i>	<i>22</i>
8.2.3. <i>802.11n HT40 2TX CDD MODE IN THE 5.2 GHz BAND</i>	<i>24</i>
8.2.4. <i>802.11ac VHT80 2TX CDD MODE IN THE 5.2 GHz BAND</i>	<i>25</i>
8.2.5. <i>802.11a 2TX CDD MODE IN THE 5.3 GHz BAND.....</i>	<i>26</i>
8.2.6. <i>802.11n HT20 2TX CDD MODE IN THE 5.3 GHz BAND</i>	<i>28</i>
8.2.7. <i>802.11n HT40 2TX CDD MODE IN THE 5.3 GHz BAND</i>	<i>30</i>
8.2.8. <i>802.11ac VHT80 2TX CDD MODE IN THE 5.3 GHz BAND</i>	<i>31</i>
8.2.9. <i>802.11a 2TX CDD MODE IN THE 5.6 GHz BAND.....</i>	<i>32</i>
8.2.10. <i>802.11n HT20 2TX CDD MODE IN THE 5.6 GHz BAND</i>	<i>34</i>
8.2.11. <i>802.11n HT40 2TX CDD MODE IN THE 5.6 GHz BAND</i>	<i>36</i>
8.2.12. <i>802.11ac VHT80 2TX CDD MODE IN THE 5.6 GHz BAND</i>	<i>38</i>
8.2.13. <i>802.11a 2TX CDD MODE IN THE 5.8 GHz BAND.....</i>	<i>40</i>

8.2.14.	802.11n HT20 2TX CDD MODE IN THE 5.8 GHz BAND	42
8.2.15.	802.11n HT40 2TX CDD MODE IN THE 5.8 GHz BAND	44
8.2.16.	802.11ac VHT80 2TX CDD MODE IN THE 5.8 GHz BAND	45
8.3.	<i>99% BANDWIDTH</i>	46
8.3.1.	802.11a 2TX CDD MODE IN THE 5.2 GHz BAND.....	47
8.3.2.	802.11n HT20 2TX CDD MODE IN THE 5.2 GHz BAND	49
8.3.3.	802.11n HT40 2TX CDD MODE IN THE 5.2 GHz BAND	51
8.3.4.	802.11ac VHT80 2TX CDD MODE IN THE 5.2 GHz BAND	52
8.3.5.	802.11a 2TX CDD MODE IN THE 5.3 GHz BAND.....	53
8.3.6.	802.11n HT20 2TX CDD MODE IN THE 5.3 GHz BAND	55
8.3.7.	802.11n HT40 2TX CDD MODE IN THE 5.3 GHz BAND	57
8.3.8.	802.11ac VHT80 2TX CDD MODE IN THE 5.3 GHz BAND	58
8.3.9.	802.11a 2TX CDD MODE IN THE 5.6 GHz BAND.....	59
8.3.10.	802.11n HT20 2TX CDD MODE IN THE 5.6 GHz BAND	61
8.3.11.	802.11n HT40 2TX CDD MODE IN THE 5.6 GHz BAND	63
8.3.12.	802.11ac VHT80 2TX CDD MODE IN THE 5.6 GHz BAND	65
8.3.13.	802.11a 2TX CDD MODE IN THE 5.8 GHz BAND.....	67
8.3.14.	802.11n HT20 2TX CDD MODE IN THE 5.8 GHz BAND	69
8.3.15.	802.11n HT40 2TX CDD MODE IN THE 5.8 GHz BAND	71
8.3.16.	802.11ac VHT80 2TX CDD MODE IN THE 5.8 GHz BAND	72
8.4.	<i>6 dB BANDWIDTH</i>	73
8.4.1.	802.11a 2TX CDD MODE IN THE 5.8 GHz BAND.....	74
8.4.2.	802.11n HT20 2TX CDD MODE IN THE 5.8 GHz BAND	76
8.4.3.	802.11n HT40 2TX CDD MODE IN THE 5.8 GHz BAND	78
8.4.4.	802.11ac VHT80 2TX CDD MODE IN THE 5.8 GHz BAND	80
8.5.	<i>OUTPUT POWER AND PSD</i>	81
8.5.1.	802.11a 2TX CDD MODE IN THE 5.2 GHz BAND.....	84
8.5.2.	802.11n HT20 2TX CDD MODE IN THE 5.2 GHz BAND	87
8.5.3.	802.11n HT40 2TX CDD MODE IN THE 5.2 GHz BAND	90
8.5.4.	802.11ac VHT80 2TX CDD MODE IN THE 5.2 GHz BAND	92
8.5.5.	802.11a 2TX CDD MODE IN THE 5.3 GHz BAND.....	94
8.5.6.	802.11n HT20 2TX CDD MODE IN THE 5.3 GHz BAND	97
8.5.7.	802.11n HT40 2TX CDD MODE IN THE 5.3 GHz BAND	100
8.5.8.	802.11ac VHT80 2TX CDD MODE IN THE 5.3 GHz BAND	102
8.5.9.	802.11a 2TX CDD MODE IN THE 5.6 GHz BAND.....	104
8.5.10.	802.11n HT20 2TX CDD MODE IN THE 5.6 GHz BAND	107
8.5.11.	802.11n HT40 2TX CDD MODE IN THE 5.6 GHz BAND	110
8.5.12.	802.11ac VHT80 2TX CDD MODE IN THE 5.6 GHz BAND	113
8.5.13.	802.11a 2TX CDD MODE IN THE 5.8 GHz BAND.....	116
8.5.14.	802.11n HT20 2TX CDD MODE IN THE 5.8 GHz BAND	119
8.5.15.	802.11n HT40 2TX CDD MODE IN THE 5.8 GHz BAND	122
8.5.16.	802.11ac VHT80 2TX CDD MODE IN THE 5.8 GHz BAND	124
9.	RADIATED TEST RESULTS	126
9.1.	<i>TRANSMITTER ABOVE 1 GHz</i>	127
9.1.1.	TX ABOVE 1 GHz 802.11a 2TX CDD MODE IN THE 5.2 GHz BAND	127
9.1.2.	TX ABOVE 1 GHz 802.11n HT20 2TX CDD MODE IN THE 5.2 GHz BAND	135
9.1.3.	TX ABOVE 1 GHz 802.11n HT40 2TX CDD MODE IN THE 5.2 GHz BAND	143
9.1.4.	TX ABOVE 1 GHz 802.11ac VHT80 2TX CDD MODE IN THE 5.2 GHz BAND	149
9.1.5.	TX ABOVE 1 GHz 802.11a 2TX CDD MODE IN THE 5.3 GHz BAND	153
9.1.6.	TX ABOVE 1 GHz 802.11n HT20 2TX CDD MODE IN THE 5.3 GHz BAND	161

9.1.7.	TX ABOVE 1 GHz 802.11n HT40 2TX CDD MODE IN THE 5.3 GHz BAND	169
9.1.8.	TX ABOVE 1 GHz 802.11ac VHT80 2TX CDD MODE IN THE 5.3 GHz BAND	175
9.1.9.	TX ABOVE 1 GHz 802.11a 2TX CDD MODE IN THE 5.6 GHz BAND	179
9.1.10.	TX ABOVE 1 GHz 802.11n HT20 2TX CDD MODE IN THE 5.6 GHz BAND	191
9.1.11.	TX ABOVE 1 GHz 802.11n HT40 2TX CDD MODE IN THE 5.6 GHz BAND	203
9.1.12.	TX ABOVE 1 GHz 802.11ac VHT80 2TX CDD MODE IN THE 5.6 GHz BAND	215
9.1.13.	TX ABOVE 1 GHz 802.11a 2TX CDD MODE IN THE 5.8 GHz BAND	225
9.1.14.	TX ABOVE 1 GHz 802.11n HT20 2TX CDD MODE IN THE 5.8 GHz BAND	235
9.1.15.	TX ABOVE 1 GHz 802.11n HT40 2TX CDD MODE IN THE 5.8 GHz BAND	245
9.1.16.	TX ABOVE 1 GHz 802.11ac VHT80 2TX CDD MODE IN THE 5.8 GHz BAND	253
9.2.	<i>WORST-CASE BELOW 30 MHz</i>	259
9.3.	<i>Worst Case Below 1 GHz</i>	260
9.4.	<i>Worst Case 18-26 GHz</i>	262
9.5.	<i>Worst Case 26-40 GHz</i>	264
10.	AC POWER LINE CONDUCTED EMISSIONS	266
10.1.1.	AC Power Line Norm	267
11.	SETUP PHOTOS	270

1. ATTESTATION OF TEST RESULTS

COMPANY NAME: SONY MOBILE COMMUNICATIONS, INC.
4-12-3 HIGASHI-SHINAGAWA,
SHINAGAWA -KU, TOKYO, 140-0002, JAPAN

EUT DESCRIPTION: GSM/WCDMA/LTE Phone with BT, DTS/UNII a/b/g/n/ac & NFC

SERIAL NUMBER: BH900039BB& BH900036BB (CONDUCTED)
BH90005SBB& BH900025BB (RADIATED)

DATE TESTED: FEBRUARY 13 -28 & MARCH 2, 2018

APPLICABLE STANDARDS	
STANDARD	TEST RESULTS
CFR 47 Part 15 Subpart E (EXCEPT DFS)	Complies

UL Verification Services Inc. tested the above equipment in accordance with the requirements set forth in the above standards. All indications of Pass/Fail in this report are opinions expressed by UL Verification Services Inc. based on interpretations and/or observations of test results. Measurement Uncertainties were not taken into account and are published for informational purposes only. The test results show that the equipment tested is capable of demonstrating compliance with the requirements as documented in this report.

Note: The results documented in this report apply only to the tested sample, under the conditions and modes of operation as described herein. This document may not be altered or revised in any way unless done so by UL Verification Services Inc. and all revisions are duly noted in the revisions section. Any alteration of this document not carried out by UL Verification Services Inc. will constitute fraud and shall nullify the document. This report must not be used by the client to claim product certification, approval, or endorsement by NVLAP, NIST, any agency of the Federal Government, or any agency of the U.S. government.

Approved & Released For
UL Verification Services Inc. By:

Prepared By:

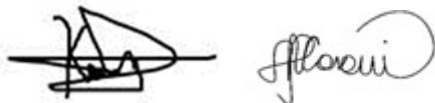

Kiya Kedida/Dan Corona
CONSUMER TECHNOLOGY DIVISION
Project Engineer/Operations Leader
UL Verification Services Inc.



Eric Yu
CONSUMER TECHNOLOGY DIVISION
Test Engineer
UL Verification Services Inc.

2. TEST METHODOLOGY

The tests documented in this report were performed in accordance with FCC CFR 47 Part 2, FCC CFR 47 Part 15, FCC KDB 662911 D01 v02r01, FCC KDB 789033 D02 v02r01, ANSI C63.10-2013.

3. FACILITIES AND ACCREDITATION

The test sites and measurement facilities used to collect data are located at 47173 and 47266 Benicia Street, Fremont, California, USA. Line conducted emissions are measured only at the 47173 address. The following table identifies which facilities were utilized for radiated emission measurements documented in this report. Specific facilities are also identified in the test results sections.

47173 Benicia Street	47266 Benicia Street
<input checked="" type="checkbox"/> Chamber A (ISED:2324B-1)	<input type="checkbox"/> Chamber D (ISED:22541-1)
<input checked="" type="checkbox"/> Chamber B (ISED:2324B-2)	<input type="checkbox"/> Chamber E (ISED:22541-2)
<input type="checkbox"/> Chamber C (ISED:2324B-3)	<input type="checkbox"/> Chamber F (ISED:22541-3)
	<input type="checkbox"/> Chamber G (ISED:22541-4)
	<input type="checkbox"/> Chamber H (ISED:22541-5)

The above test sites and facilities are covered under FCC Test Firm Registration # 208313. Chambers A through C are covered under ISED company address code 2324B with site numbers 2324B -1 through 2324B-3, respectively. Chambers D through H are covered under ISED Canada company address code 22541 with site numbers 22541 -1 through 22541-5, respectively.

UL Verification Services Inc. is accredited by NVLAP, Laboratory Code 200065-0. The full scope of accreditation can be viewed at <http://ts.nist.gov/standards/scopes/2000650.htm>.

4. CALIBRATION AND UNCERTAINTY

4.1. MEASURING INSTRUMENT CALIBRATION

The measuring equipment utilized to perform the tests documented in this report has been calibrated in accordance with the manufacturer's recommendations, and is traceable to recognized national standards.

4.2. SAMPLE CALCULATION

Where relevant, the following sample calculation is provided:

$$\begin{aligned} \text{Field Strength (dBuV/m)} &= \text{Measured Voltage (dBuV)} + \text{Antenna Factor (dB/m)} + \\ &\text{Cable Loss (dB)} - \text{Preamp Gain (dB)} \\ 36.5 \text{ dBuV} + 18.7 \text{ dB/m} + 0.6 \text{ dB} - 26.9 \text{ dB} &= 28.9 \text{ dBuV/m} \end{aligned}$$

4.3. MEASUREMENT UNCERTAINTY

Where relevant, the following measurement uncertainty levels have been estimated for tests performed on the apparatus:

PARAMETER	UNCERTAINTY
Worst Case Conducted Disturbance, 9KHz to 0.15 MHz	3.84 dB
Worst Case Conducted Disturbance, 0.15 to 30 MHz	3.65 dB
Worst Case Radiated Disturbance, 9KHz to 30 MHz	3.15 dB
Worst Case Radiated Disturbance, 30 to 1000 MHz	5.36 dB
Worst Case Radiated Disturbance, 1000 to 18000 MHz	4.32 dB
Worst Case Radiated Disturbance, 18000 to 26000 MHz	4.45 dB
Worst Case Radiated Disturbance, 26000 to 40000 MHz	5.24 dB

Uncertainty figures are valid to a confidence level of 95%.

5. EQUIPMENT UNDER TEST

5.1. EUT DESCRIPTION

The EUT is a GSM/WCDMA/LTE Phone with BT, DTS/UNII a/b/g/n/ac & NFC.

5.1. MAXIMUM OUTPUT POWER

The transmitter has a maximum conducted output power as follows:

5.2GHz Band

Frequency Range (MHz)	Mode	Output Power (dBm)	Output Power (mW)
5180 - 5240	802.11a CDD 2TX	13.81	24.04
	802.11n HT20 CDD 2TX	14.13	25.88
5190 - 5230	802.11n HT40 CDD 2TX	14.48	28.05
5210	802.11ac VHT80 CDD 2TX	13.80	23.99

5.3GHz Band

Frequency Range (MHz)	Mode	Output Power (dBm)	Output Power (mW)
5260 - 5320	802.11a CDD 2TX	13.66	23.23
	802.11n HT20 CDD 2TX	13.87	24.38
5270 - 5310	802.11n HT40 CDD 2TX	14.24	26.55
5290	802.11ac VHT80 CDD 2TX	13.61	22.96

5.6GHz Band

Frequency Range (MHz)	Mode	Output Power (dBm)	Output Power (mW)
5500 - 5720	802.11a CDD 2TX	13.65	23.17
5500 - 5720	802.11n HT20 CDD 2TX	13.56	22.70
5510 - 5710	802.11n HT40 CDD 2TX	14.16	26.06
5530-5690	802.11ac VHT80 CDD 2TX	14.26	26.67

5.8GHz Band

Frequency Range (MHz)	Mode	Output Power (dBm)	Output Power (mW)
5745 - 5825	802.11a CDD 2TX	12.03	15.96
5745 - 5825	802.11n HT20 CDD 2TX	12.02	15.92
5755 - 5795	802.11n HT40 CDD 2TX	12.24	16.75
5775	802.11ac VHT80 CDD 2TX	11.60	14.45

5.2. DESCRIPTION OF AVAILABLE ANTENNAS

The radio utilizes Loop Type antennas, with the following maximum gains:

Frequency (GHz)	Peak Antenna Gain (dBi)	
	Main (Chain 0)	Sub (Chain 1)
5180-5320	-1.2	-5.8
5500-5700	-2.8	-5.7
5725-5850	-4.3	-7.5

5.3. SOFTWARE AND FIRMWARE

The firmware installed in the EUT during testing was s_atp_XXX_0_00333_A_11.
 The test utility software used during testing was Tera Term Ver 4.79.

5.4. LIST OF TEST REDUCTION AND MODES

Antenna port & Radiated Testing	
Mode	Covered by
802.11a Legacy	802.11a 2TX CDD
802.11HT20 2TX STBC	802.11n HT20 2TX CDD
802.11ac VHT20 2TX STBC	802.11n HT20 2TX CDD
802.11n HT40 2TX STBC	802.11n HT40 2TX CDD
802.11ac VHT40 2TX STBC	802.11n HT40 2TX CDD
802.11ac VHT80 2TX STBC	802.11n HT20 2TX CDD

5.5. WORST-CASE CONFIGURATION AND MODE

Radiated emissions below 30MHz, 1GHz, above 18GHz, and power line conducted emission were performed with the EUT set to transmit at the channel with highest output power as worst-case scenario.

The fundamental of the EUT was investigated in three orthogonal orientations X, Y, & Z, and it was determined that X-Axis with AC/DC Adapter was worst-case orientation; therefore, all final radiated testing was performed with the EUT in X-Axis with AC/DC Adapter orientation.

Worst-case data rates as provided by the client were:

802.11a mode: 6 Mbps
802.11n HT20 mode: 13 Mbps (MCS8)
802.11n HT40 mode: 27 Mbps (MCS8)
802.11ac VHT80 mode: 58.5 Mbps (MCS0)

802.11ac VHT20 and VHT40 mode are different from 802.11nHT20 and HT40 only in control messages and have the same power settings.

The simultaneous mode (SISO 2.4GHz Chain 0 and 5GHz chain 1) was checked and stand-alone (MIMO) 2.4 GHz / 5GHz remain worst case.

NOTE: SISO mode is covered by MIMO mode due to same maximum tune-up limit (power).

5.6. DESCRIPTION OF TEST SETUP

SUPPORT EQUIPMENT

Support Equipment List				
Description	Manufacturer	Model	Serial Number	FCC ID
Laptop	Lenovo	20B7S0A200	PC015REW	NA
AC Adapter	SONY	UCH12	4016W40310044	NA
DC Power Supply	Ametek	XT 15-4	T463	N/A

I/O CABLES (CONDUCTED TEST)

I/O Cable List						
Cable No	Port	# of identical ports	Connector Type	Cable Type	Cable Length (m)	Remarks
1	Antenna	1	RF	Shielded	0.2	To spectrum Analyzer
2	USB	1	USB	Shielded	1	N/A
3	DC	1	DC	Shielded	0.3	N/A

I/O CABLES (RADIATED AND CONDUCTED EMISSIONS)

I/O Cable List						
Cable No	Port	# of identical ports	Connector Type	Cable Type	Cable Length (m)	Remarks
1	USB	1	USB	Shielded	3	N/A

TEST SETUP

CONDCUTED TEST SETUP DIAGRAM

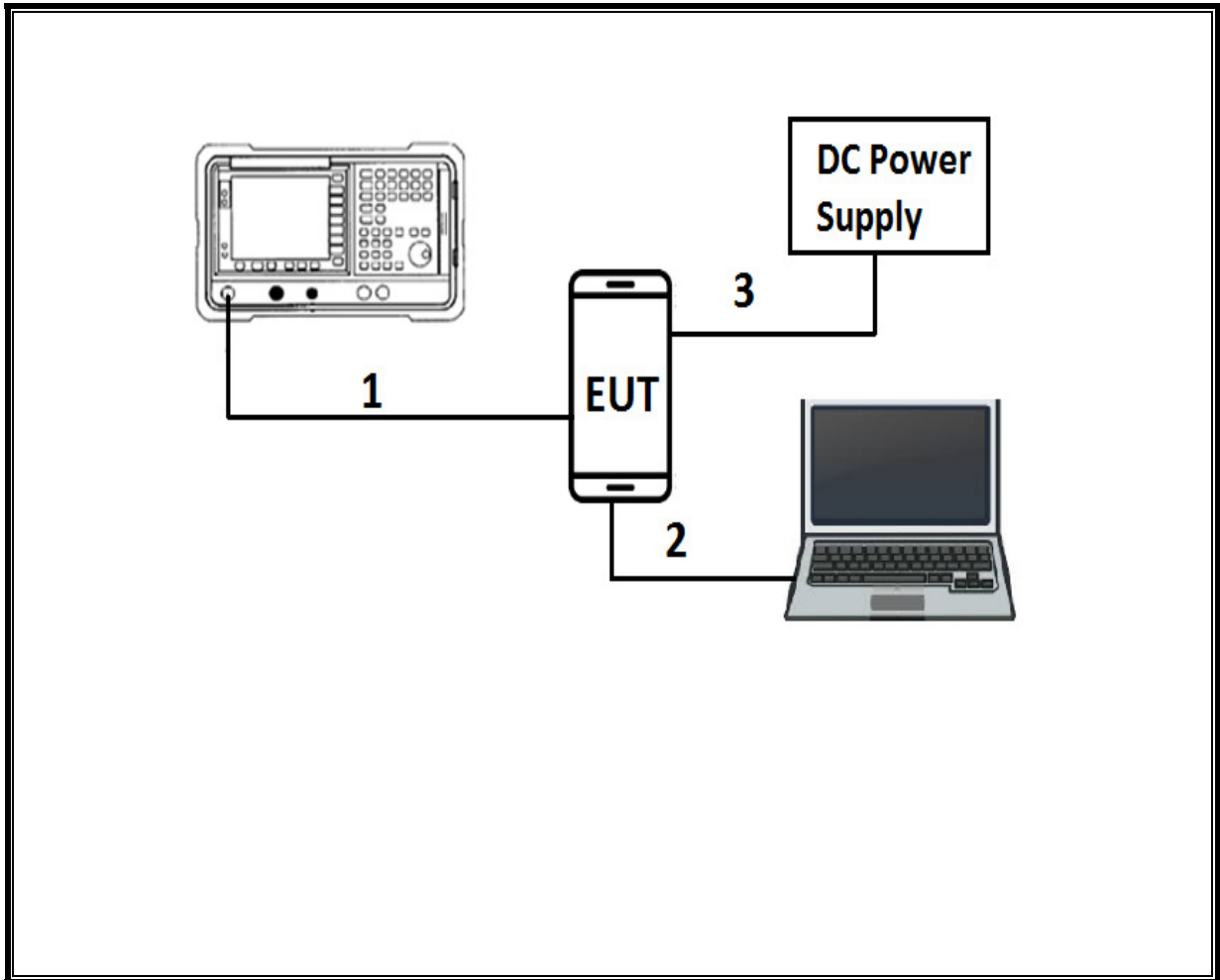

TEST SETUP

RADIATED AND AC LINE CONDUCTED EMISSIONS SETUP DIAGRAM

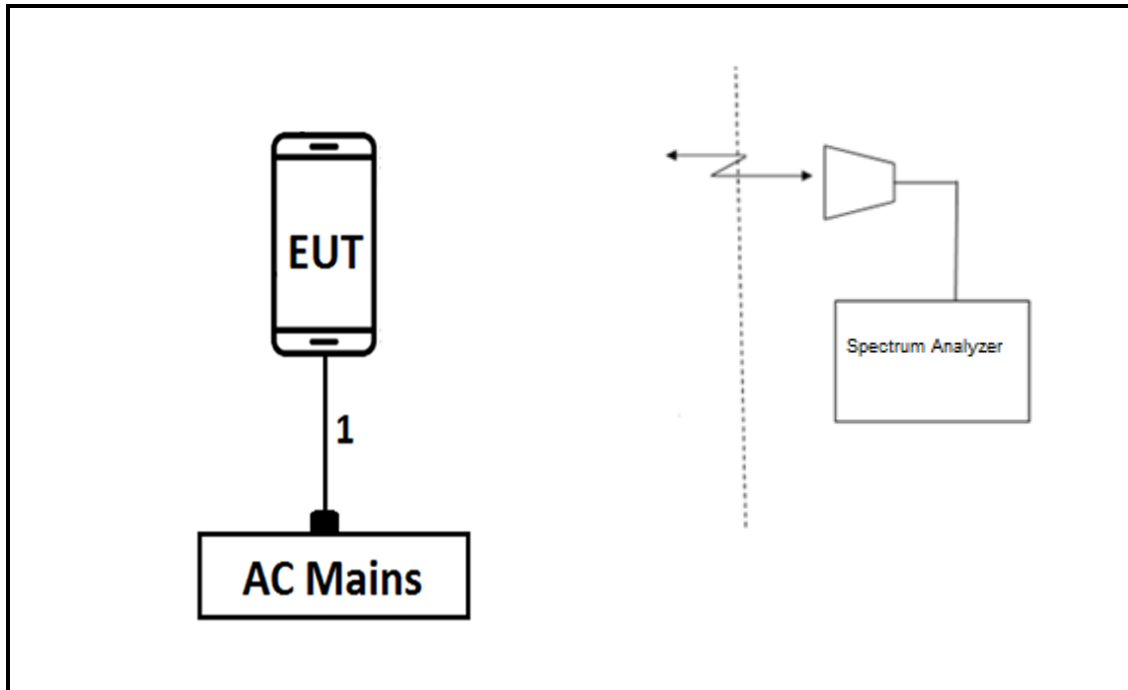

6. MEASUREMENT METHOD

On Time and Duty Cycle: KDB 789033 D02 v02r01, Section B.

6 dB Emission BW: KDB 789033 D02 v02r01, Section C.2.

26 dB Emission BW: KDB 789033 D02 v02r01, Section C.1.

99% Occupied BW: KDB 789033 D02 v02r01, Section D.

Conducted Output Power: KDB 789033 D02 v02r01, Section E.3.b (Method PM-G)

Power Spectral Density: KDB 789033 D02 v02r01, Section F

Unwanted emissions in restricted bands: KDB 789033 D02 v02r01, Sections G.3, G.4, G.5, and G.6

Unwanted emissions in non-restricted bands: KDB 789033 D02 v02r01, Sections G.3, G.4, and G.5

AC Power Line Conducted Emissions: ANSI C63.10-2013, Section 6.2.

7. TEST AND MEASUREMENT EQUIPMENT

The following test and measurement equipment was utilized for the tests documented in this report:

TEST EQUIPMENT LIST				
Description	Manufacturer	Model	ID Num	Cal Due
Amplifier, 1 - 18GHz	Miteq	AFS42-00101800-25-S-42	493	06/23/18
Amplifier, 1 - 18GHz	Miteq	AFS42-00101800-25-S-42	1165	11/25/18
Amplifier, 10KHz to 1GHz, 32dB	Keysight	8447D	10	02/14/19
Amplifier, 10KHz to 1GHz, 32dB	Keysight	8447D	15	08/17/18
RF Preamplifier, 1 - 26GHz	Agilent	8449B	404	07/23/18
Amplifier- 26.5-40GHz	Mlteq	NSP 4000 SP2	T88	04/29/18
Antenna, Broadband Hybrid 30MHz to 2000MHz	Sunol Science	JB1	899	06/15/18
Antenna, Broadband Hybrid 30MHz to 2000MHz	Sunol Science	JB1	130	10/16/18
Antenna, Horn 1-18GHz	ETS-Lindgren	3117	863	06/09/18
Antenna, Horn 1-18GHz	ETS-Lindgren	3117	862	06/09/18
Antenna, Horn 18-26.5GHz	ARA	MWH-1826	T89	01/04/19
Antenna, Horn 26.5 - 40GHz	ARA	MWH-2640	T90	08/25/18
Antenna, Active Loop 9kHz-30MHz	Com-Power Corp.	AL-130R	T1866	10/10/18
Power Meter, P-series single channel	Agilent (Keysight) Technologies	N1911A	T1268	06/15/18
Power Sensor, P – series, 50MHz to 18GHz, Wideband	Agilent (Keysight) Technologies	N1921A	T1223	03/29/18
Spectrum Analyzer, PXA, 3Hz to 44GHz	Agilent (Keysight) Technologies	N9030A	T1466	04/11/18
Spectrum Analyzer, PXA, 3Hz to 44GHz	Agilent (Keysight) Technologies	N9030A	T1454	01/08/19
Spectrum Analyzer, PXA, 3Hz to 44GHz	Agilent (Keysight) Technologies	N9030A	T1113	12/21/18
Spectrum Analyzer, PXA, 3Hz to 44GHz	Agilent (Keysight) Technologies	N9030A	T1450	02/05/19
Test Receiver, EMI, 10Hz-7GHz	Rhode&Schwarz	ESR	T1436	01/06/19
LISN	FISCHER	FCC-LISN-50/250-25-2-01	T1310	01/17/19

Test Software List			
Description	Manufacturer	Model	Version
Radiated Software	UL	UL EMC	Ver 9.5, Dec 1, 2016
Antenna Port Software	UL	UL RF	Ver 7.9, Jan 25, 2018

NOTE: *testing is completed before equipment calibration expiration date.

8. ANTENNA PORT TEST RESULTS

8.1. ON TIME AND DUTY CYCLE

LIMITS

None; for reporting purposes only.

PROCEDURE

KDB 789033 Zero-Span Spectrum Analyzer Method.

ON TIME AND DUTY CYCLE RESULTS

Mode	ON Time B (msec)	Period (msec)	Duty Cycle x (linear)	Duty Cycle (%)	Duty Cycle Correction Factor (dB)	1/B Minimum VBW (kHz)
802.11a CDD	2.027	2.065	0.982	98.16%	0.00	0.010
802.11n HT20 CDD	2.509	2.562	0.979	97.93%	0.09	0.399
802.11n HT40 CDD	1.230	1.316	0.935	93.47%	0.29	0.813
802.11ac VHT80 CDD	0.591	0.669	0.884	88.44%	0.53	1.691

DUTY CYCLE PLOTS



8.2. 26 dB BANDWIDTH

LIMITS

None; for reporting purposes only.

RESULTS

8.2.1. 802.11a 2TX CDD MODE IN THE 5.2 GHz BAND

Channel	Frequency (MHz)	26 dB Bandwidth Chain 0 (MHz)	26 dB Bandwidth Chain 1 (MHz)
Low	5180	21.35	21.05
Mid	5200	21.80	21.15
High	5240	22.65	21.35

LOW CHANNEL

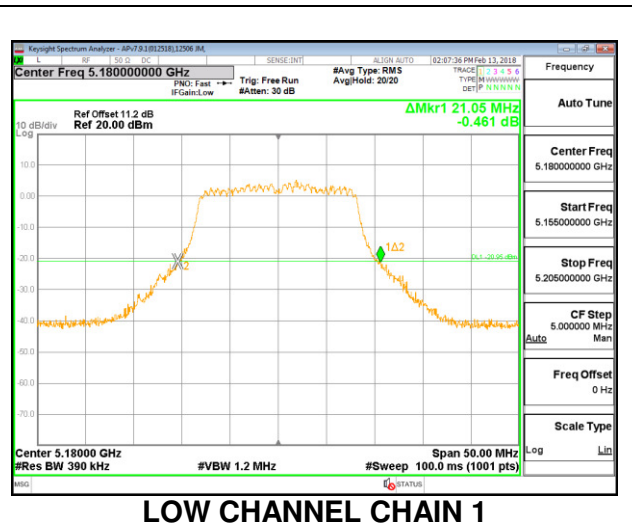
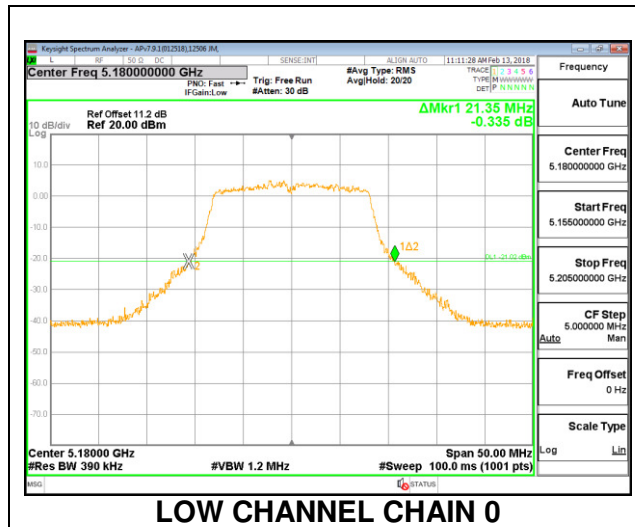

MID CHANNEL

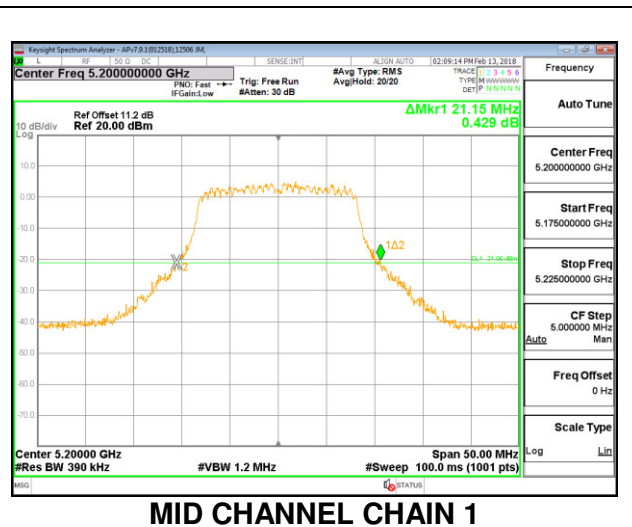
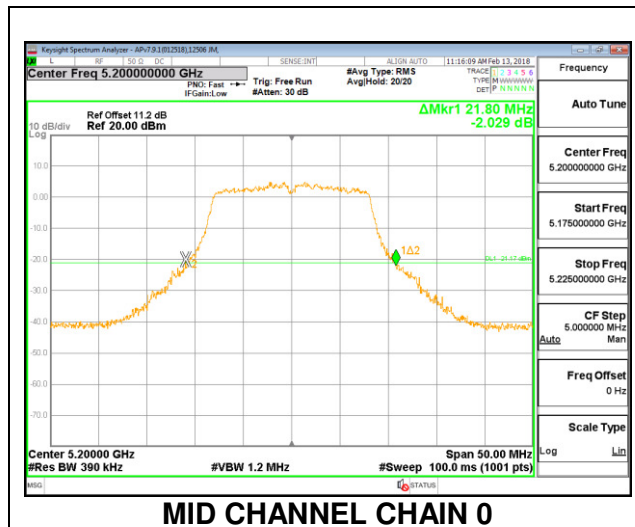

HIGH CHANNEL

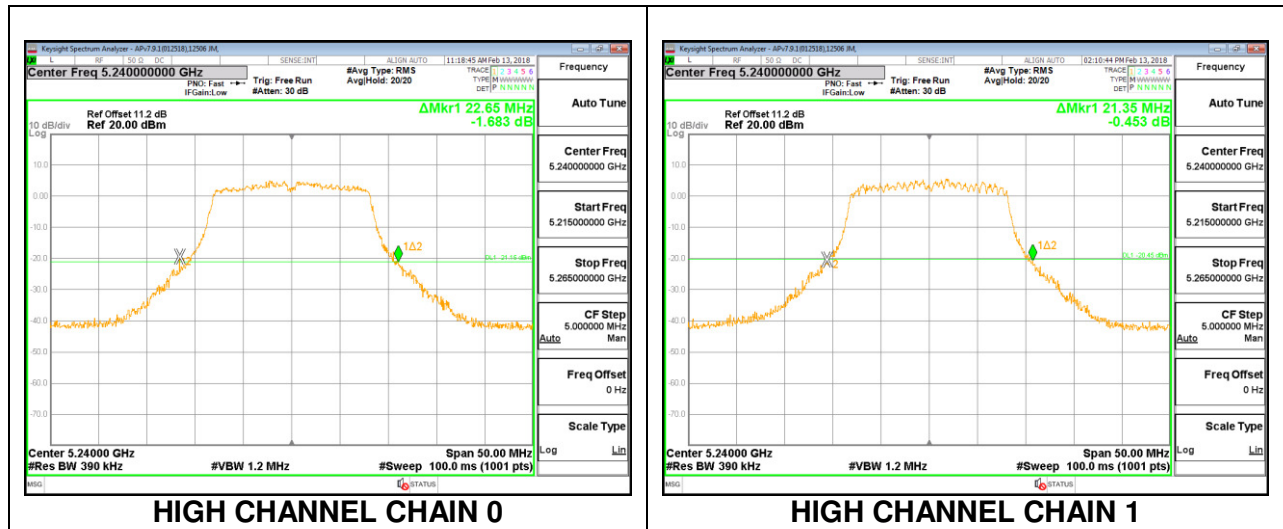

8.2.2. 802.11n HT20 2TX CDD MODE IN THE 5.2 GHz BAND

Channel	Frequency (MHz)	26 dB Bandwidth Chain 0 (MHz)	26 dB Bandwidth Chain 1 (MHz)
Low	5180	22.80	22.15
Mid	5200	22.60	22.15
High	5240	22.90	22.35

LOW CHANNEL

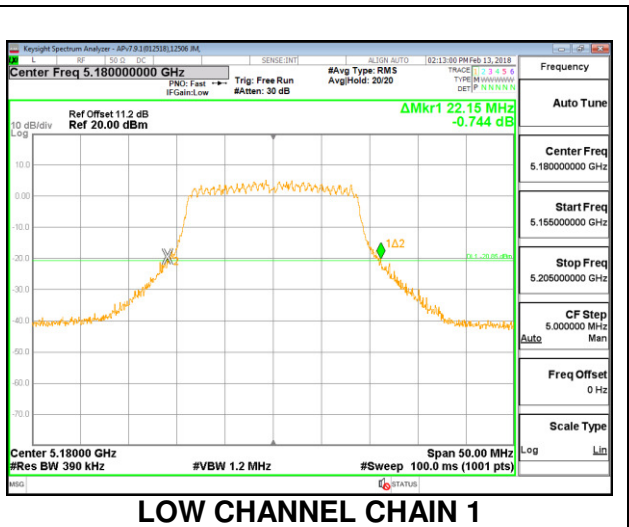
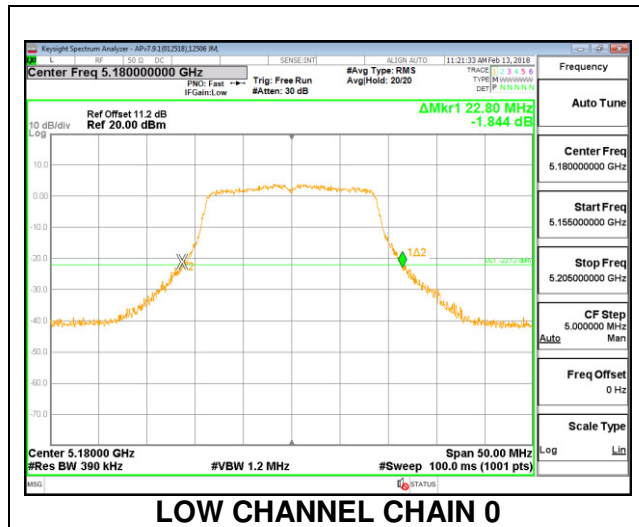

MID CHANNEL

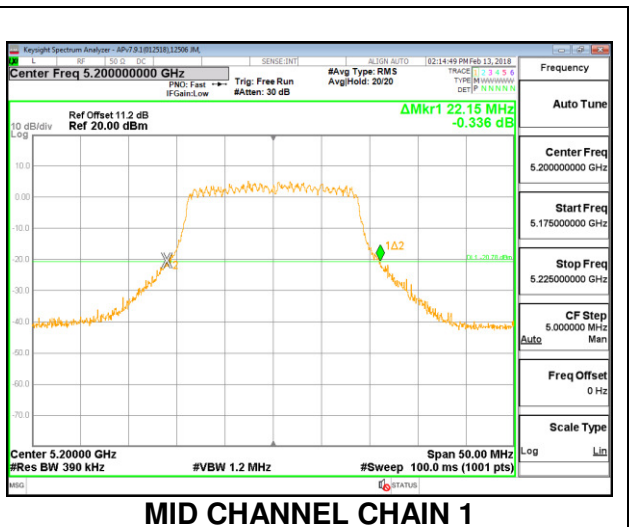
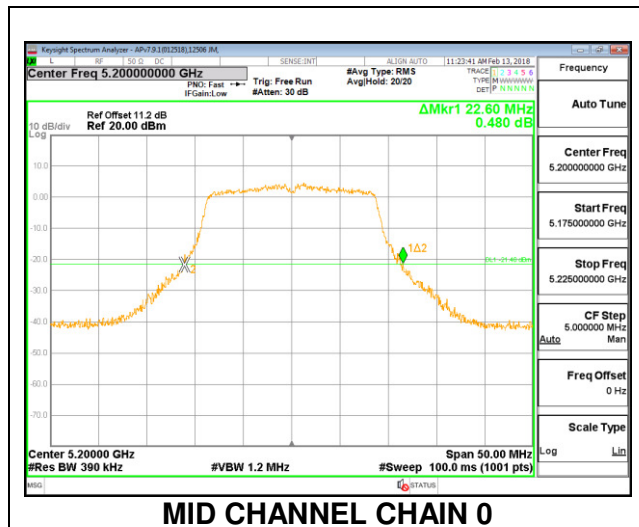

HIGH CHANNEL

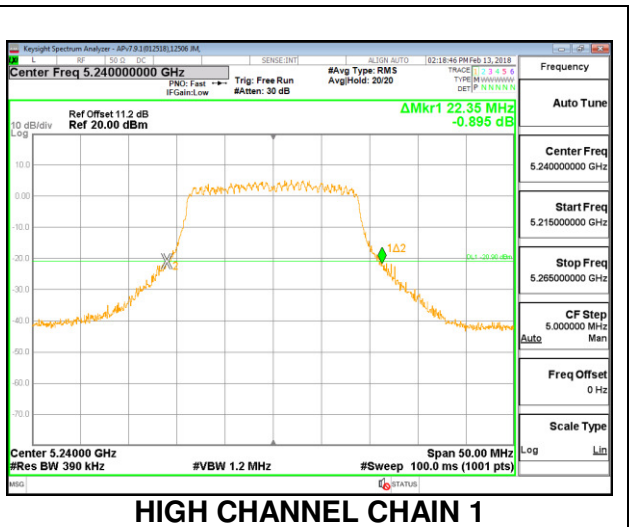
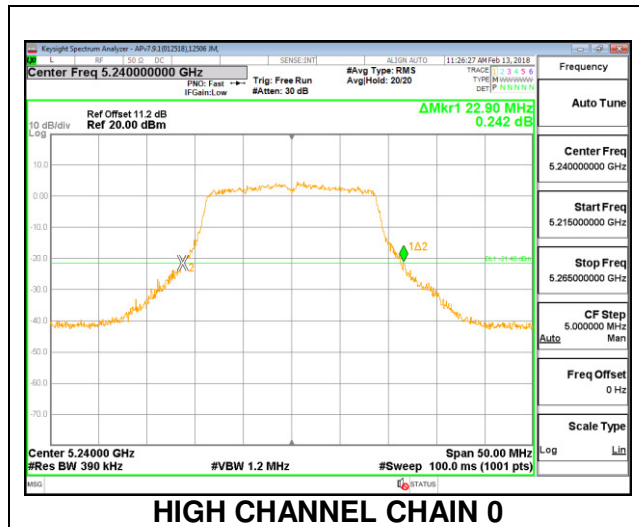

8.2.3. 802.11n HT40 2TX CDD MODE IN THE 5.2 GHz BAND

Channel	Frequency (MHz)	26 dB Bandwidth Chain 0 (MHz)	26 dB Bandwidth Chain 1 (MHz)
Low	5190	41.50	41.00
High	5230	41.60	41.20

LOW CHANNEL

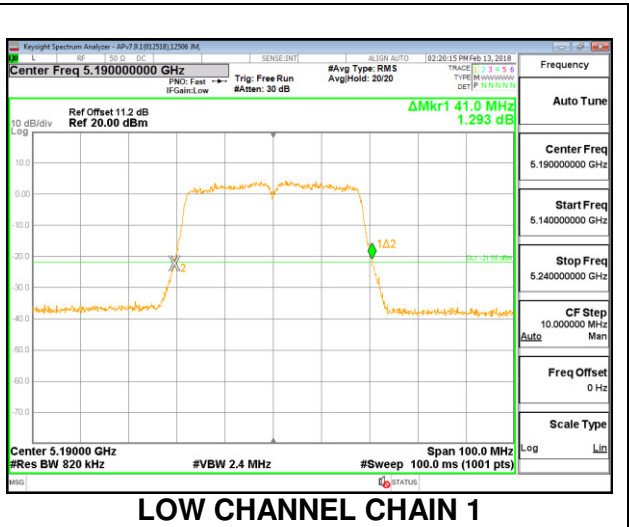
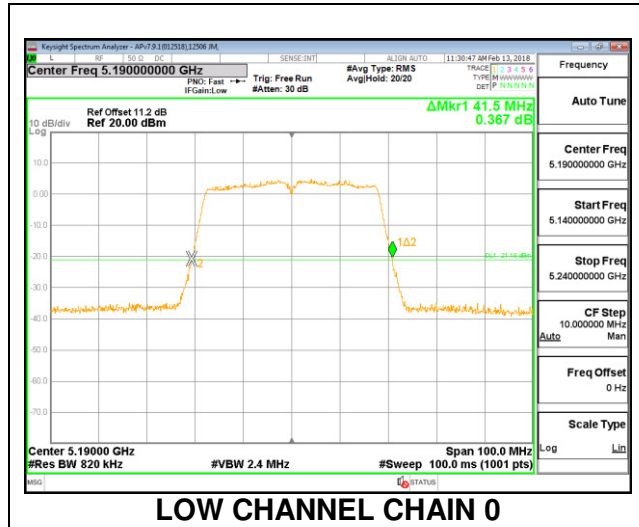

HIGH CHANNEL

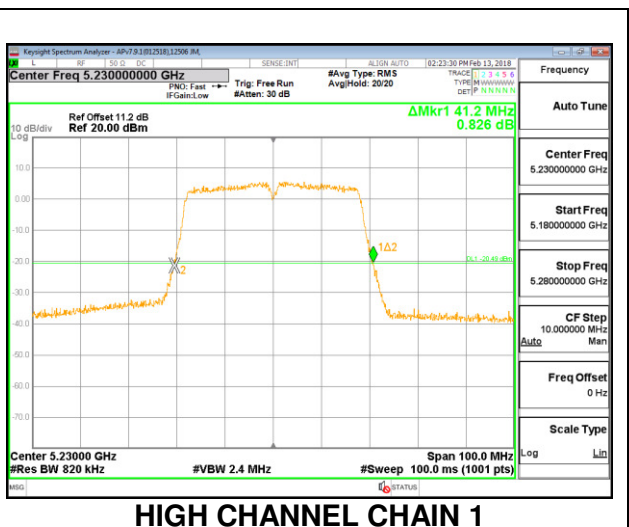
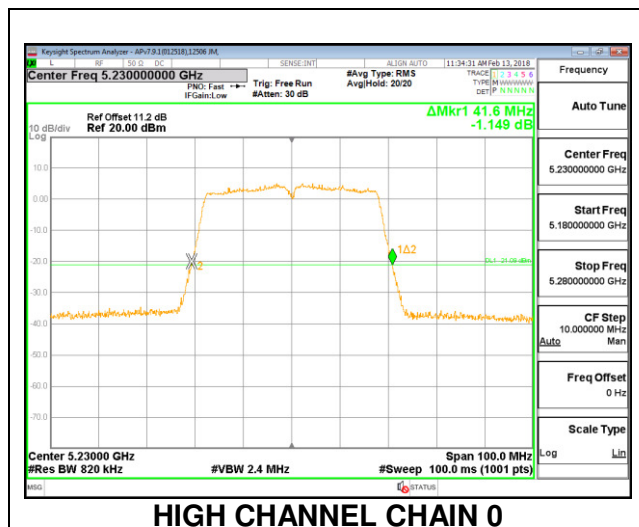

8.2.4. 802.11ac VHT80 2TX CDD MODE IN THE 5.2 GHz BAND

Channel	Frequency (MHz)	26 dB Bandwidth	26 dB Bandwidth
		Chain 0 (MHz)	Chain 1 (MHz)
Mid	5210	84.20	87.60

MID CHANNEL

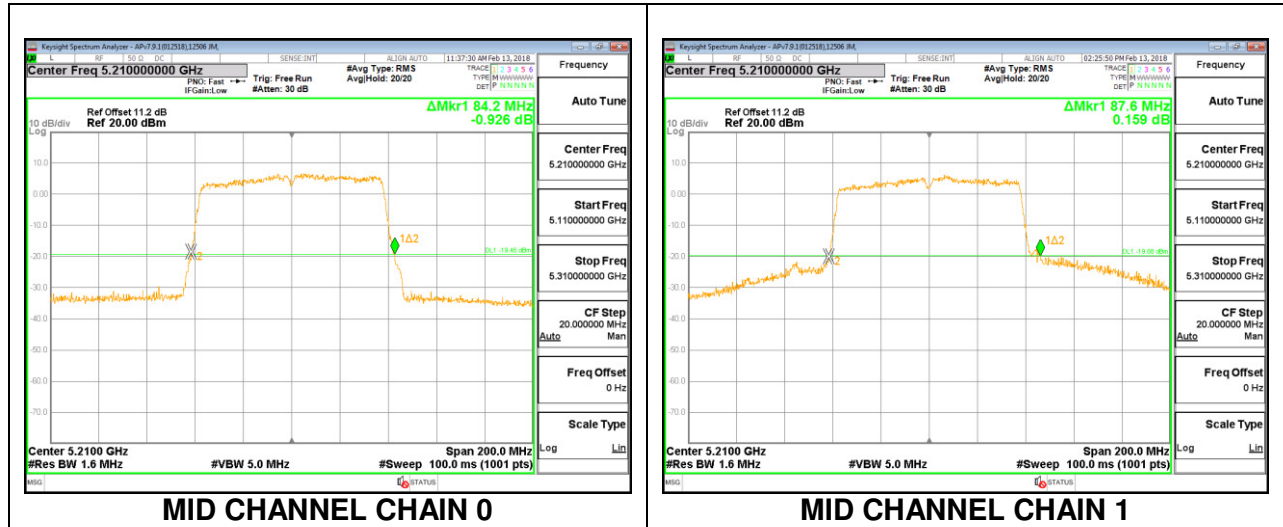

8.2.5. 802.11a 2TX CDD MODE IN THE 5.3 GHz BAND

Channel	Frequency (MHz)	26 dB Bandwidth Chain 0 (MHz)	26 dB Bandwidth Chain 1 (MHz)
Low	5260	21.90	21.70
Mid	5300	21.70	20.85
High	5320	21.85	20.85

LOW CHANNEL

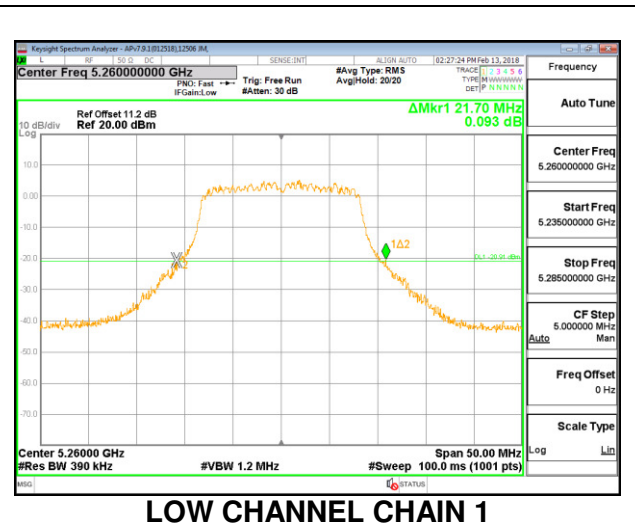
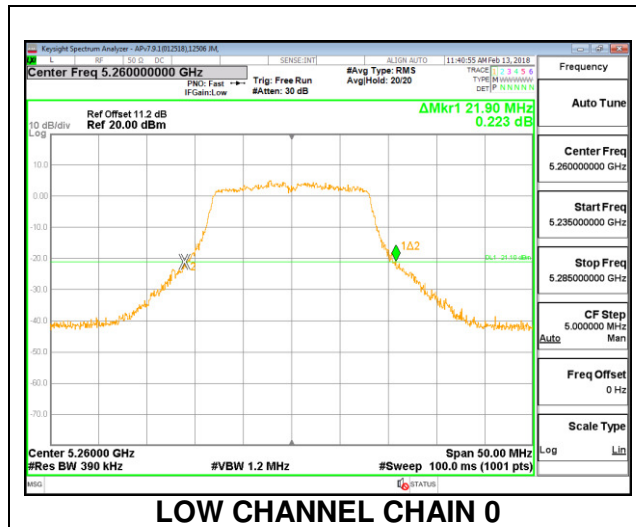

MID CHANNEL

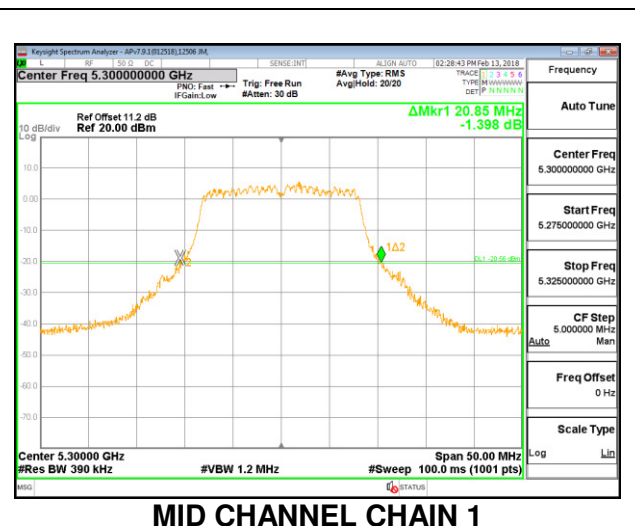
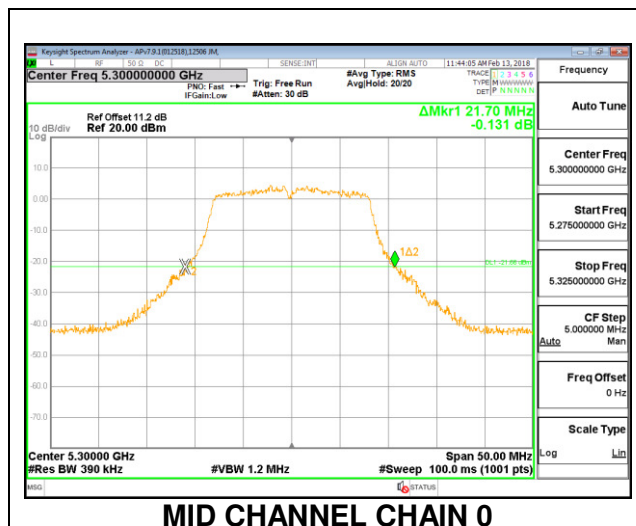

HIGH CHANNEL

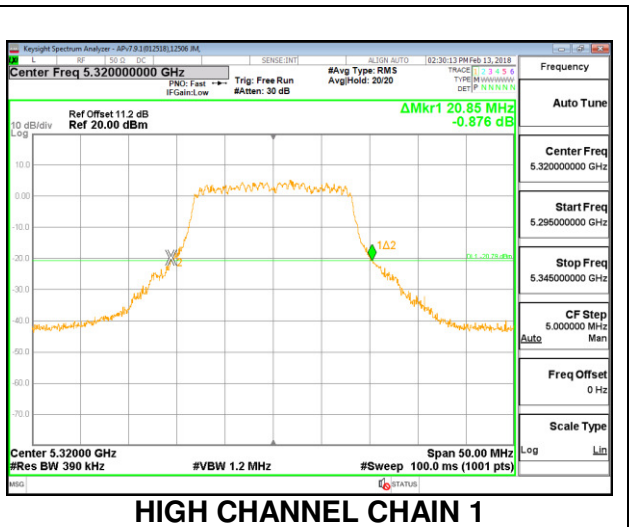
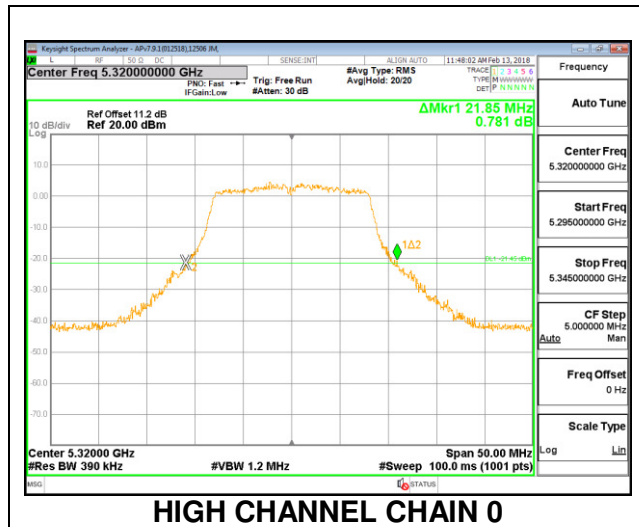

8.2.6. 802.11n HT20 2TX CDD MODE IN THE 5.3 GHz BAND

Channel	Frequency (MHz)	26 dB Bandwidth Chain 0 (MHz)	26 dB Bandwidth Chain 1 (MHz)
Low	5260	22.90	21.90
Mid	5300	23.35	22.00
High	5320	22.65	22.25

LOW CHANNEL

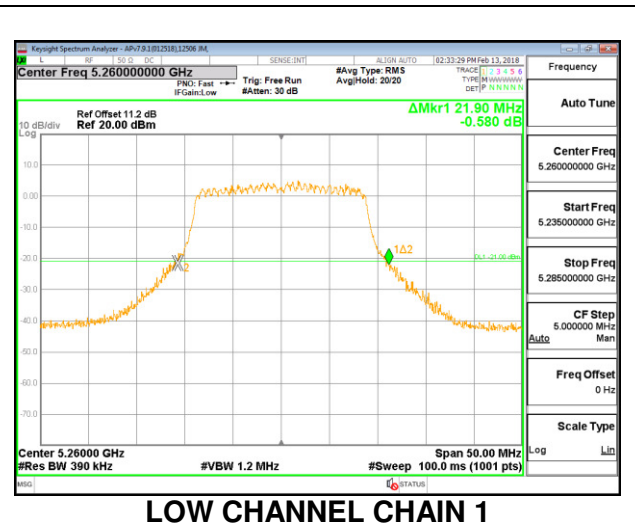
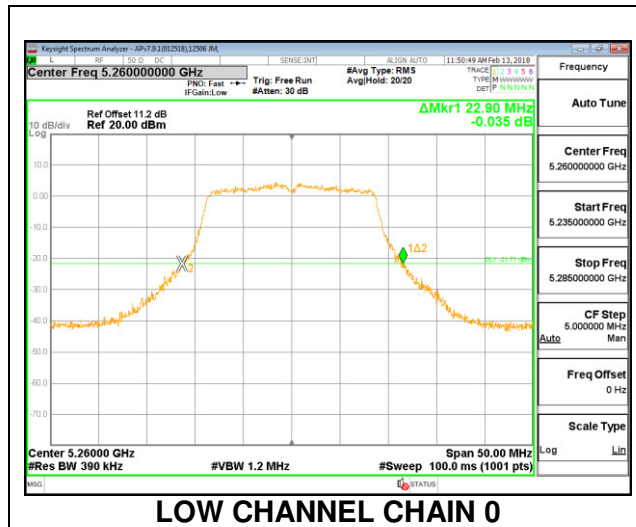

MID CHANNEL

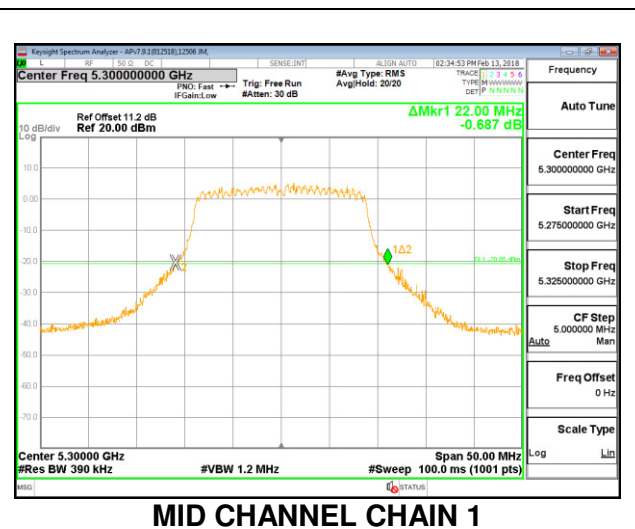
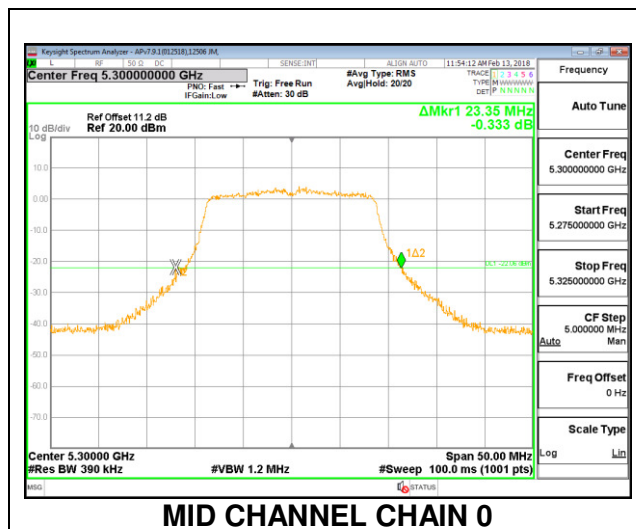

HIGH CHANNEL

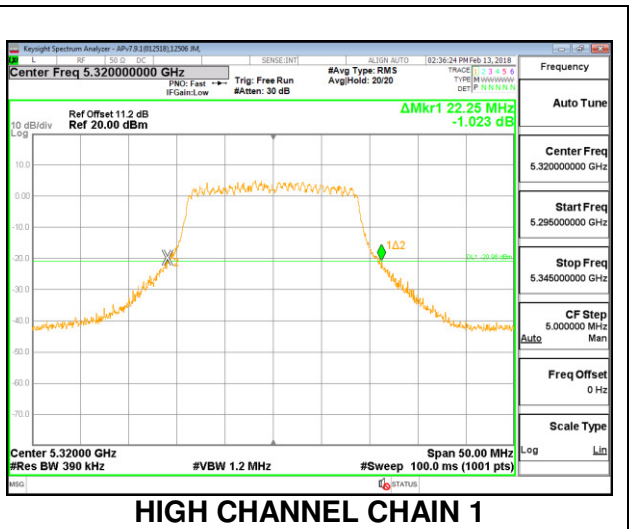
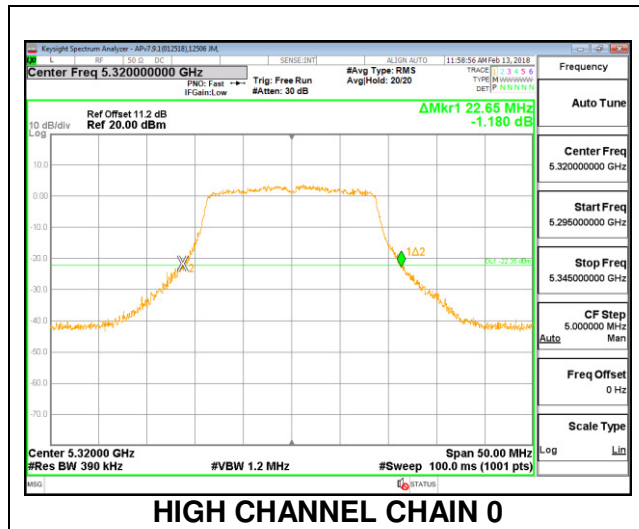

8.2.7. 802.11n HT40 2TX CDD MODE IN THE 5.3 GHz BAND

Channel	Frequency (MHz)	26 dB Bandwidth Chain 0 (MHz)	26 dB Bandwidth Chain 1 (MHz)
Low	5270	41.60	41.00
High	5310	41.60	40.90

LOW CHANNEL

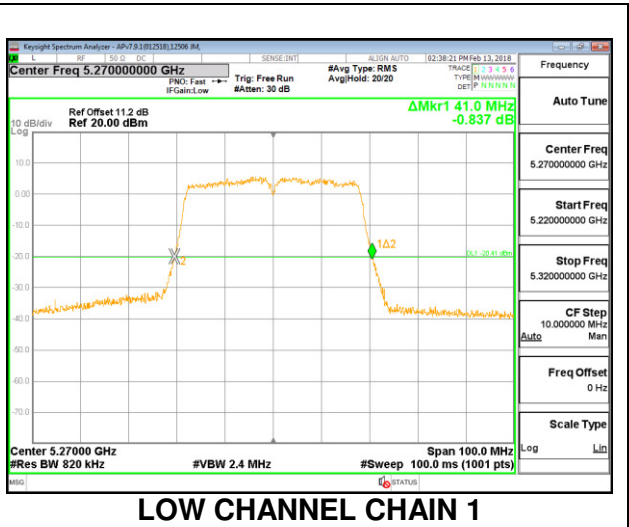
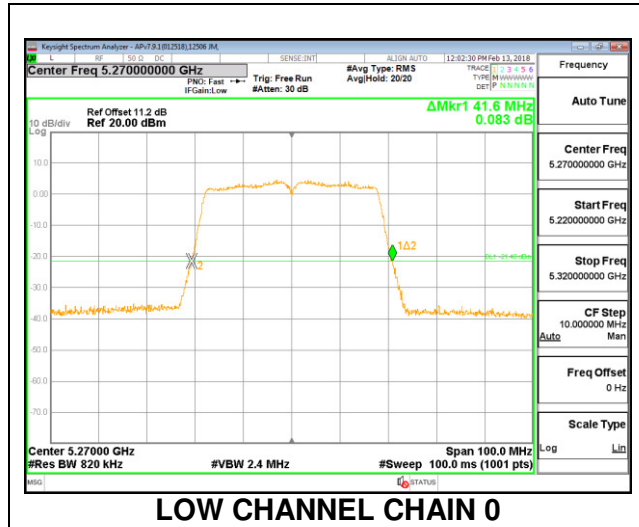

HIGH CHANNEL

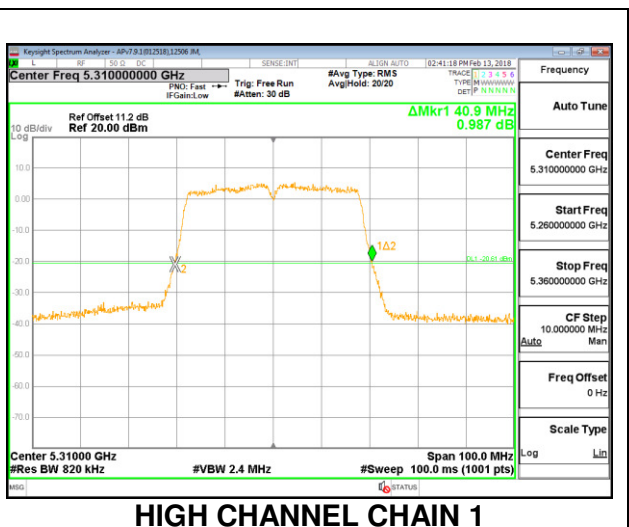
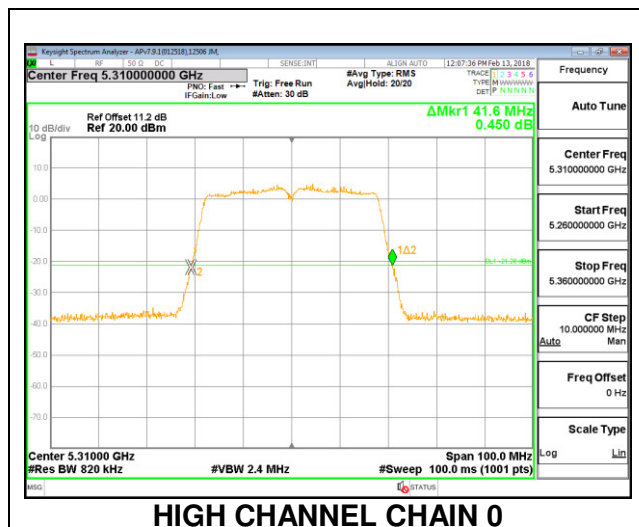

8.2.8. 802.11ac VHT80 2TX CDD MODE IN THE 5.3 GHz BAND

Channel	Frequency (MHz)	26 dB Bandwidth	26 dB Bandwidth
		Chain 0 (MHz)	Chain 1 (MHz)
Mid	5290	84.20	83.60

MID CHANNEL

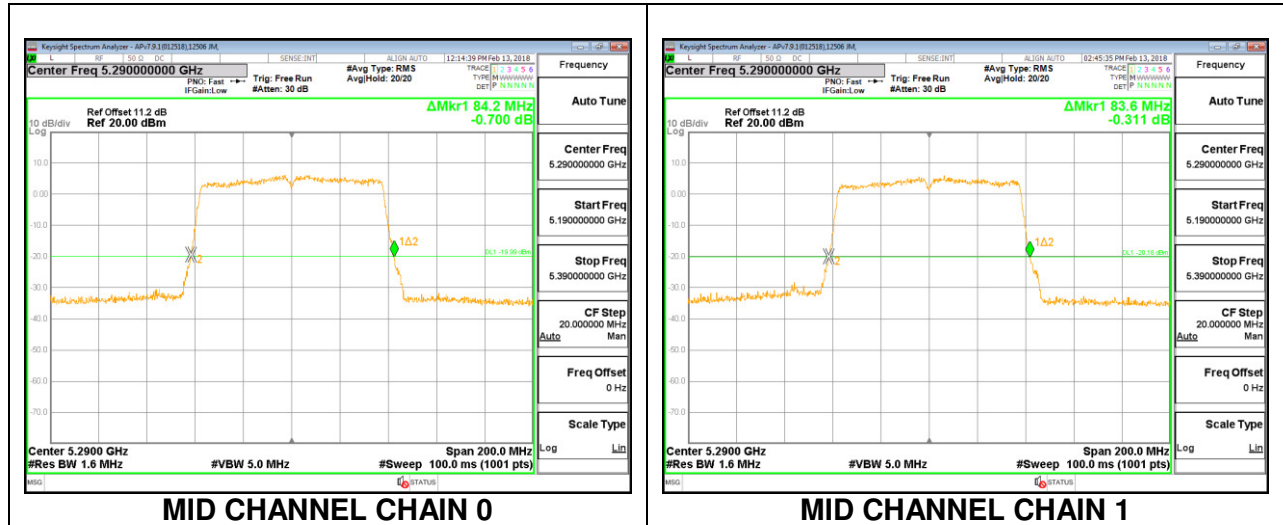

8.2.9. 802.11a 2TX CDD MODE IN THE 5.6 GHz BAND

Channel	Frequency (MHz)	26 dB Bandwidth Chain 0 (MHz)	26 dB Bandwidth Chain 1 (MHz)
Low	5500	21.60	21.00
Mid	5580	22.20	21.30
High	5700	21.65	21.35
144	5720	21.65	21.75

LOW CHANNEL

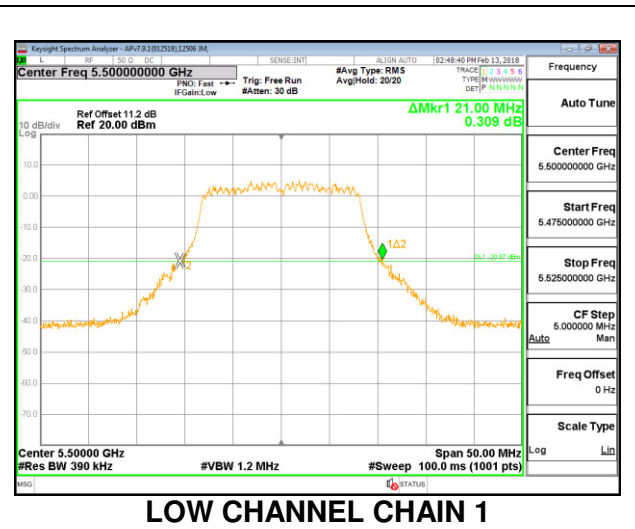
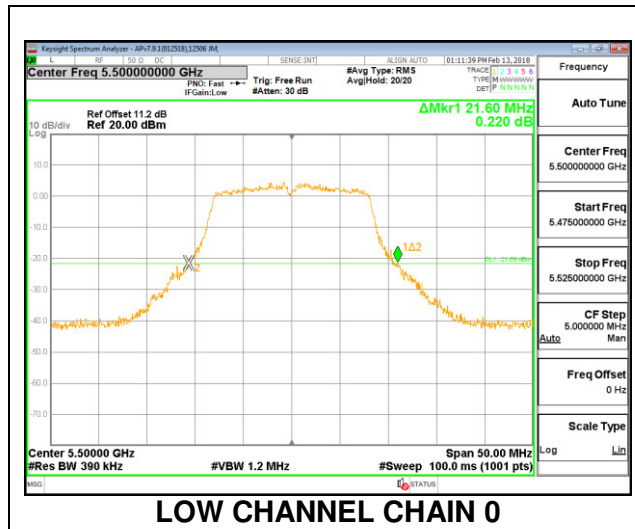

MID CHANNEL

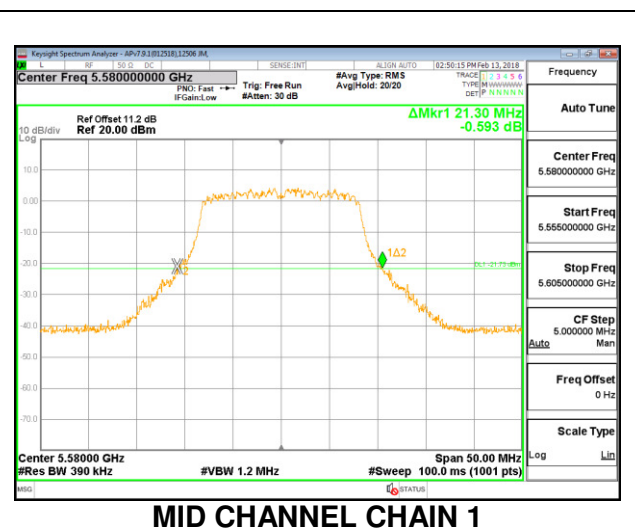
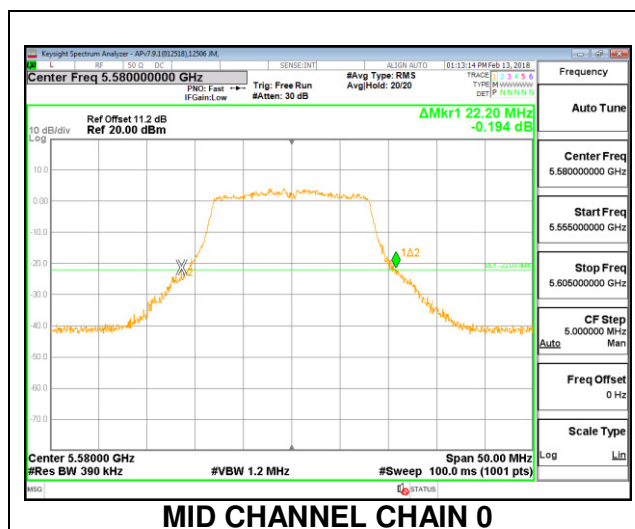

HIGH CHANNEL

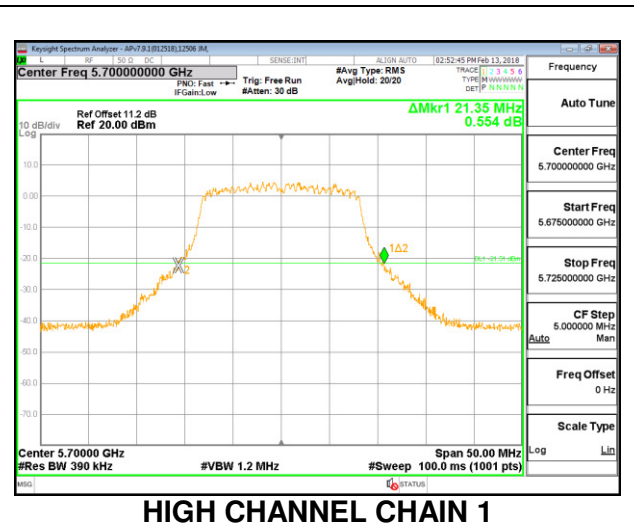
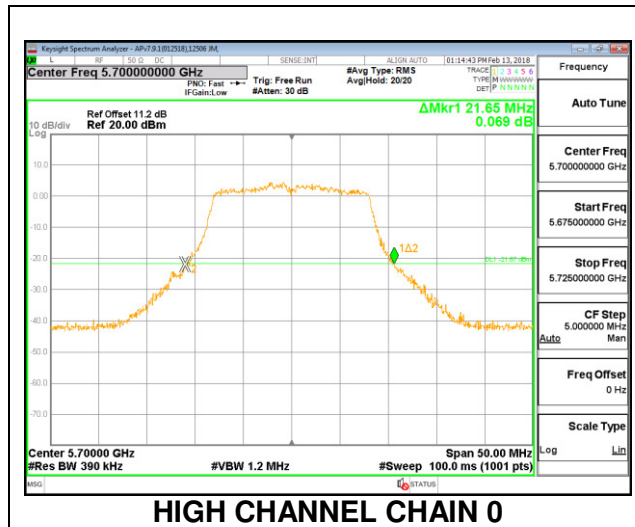

CHANNEL 144

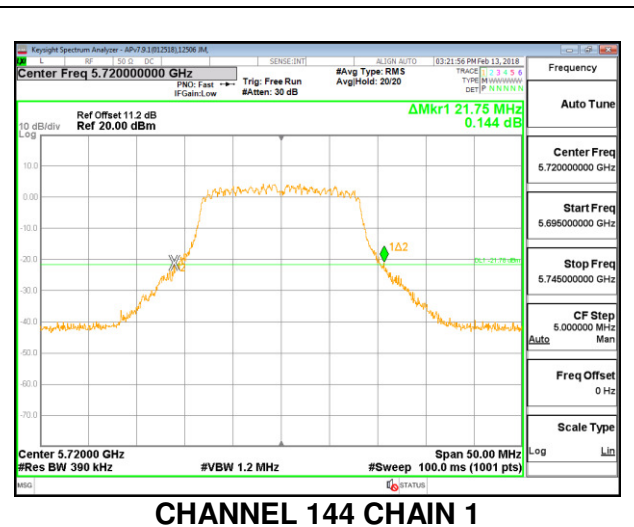
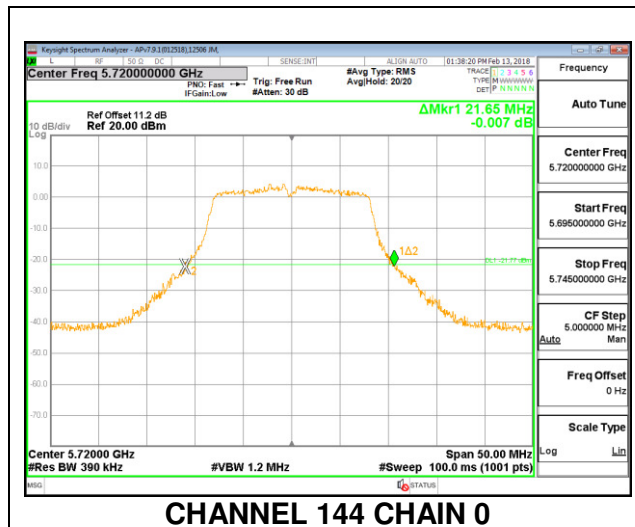

8.2.10. 802.11n HT20 2TX CDD MODE IN THE 5.6 GHz BAND

Channel	Frequency (MHz)	26 dB Bandwidth Chain 0 (MHz)	26 dB Bandwidth Chain 1 (MHz)
Low	5500	23.40	22.20
Mid	5580	22.55	22.15
High	5700	22.90	22.70
144	5720	23.15	22.10

LOW CHANNEL

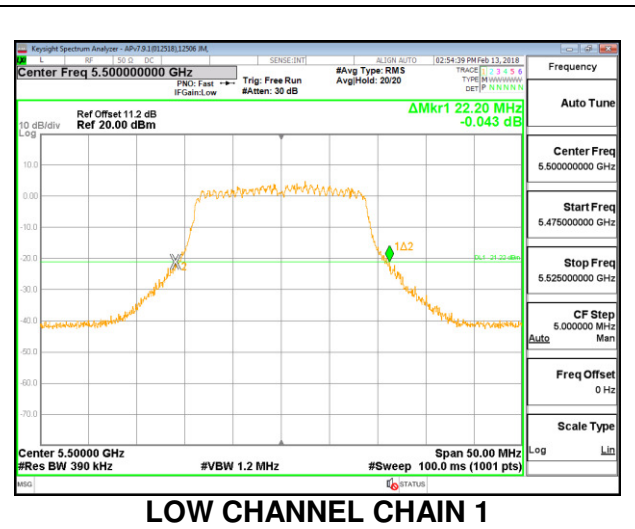
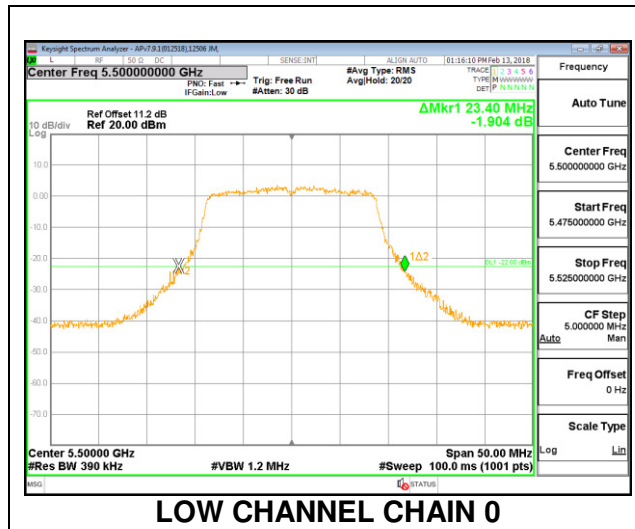

MID CHANNEL

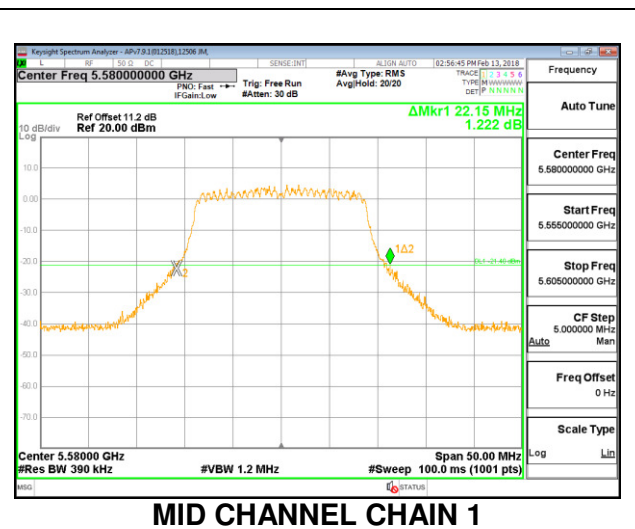
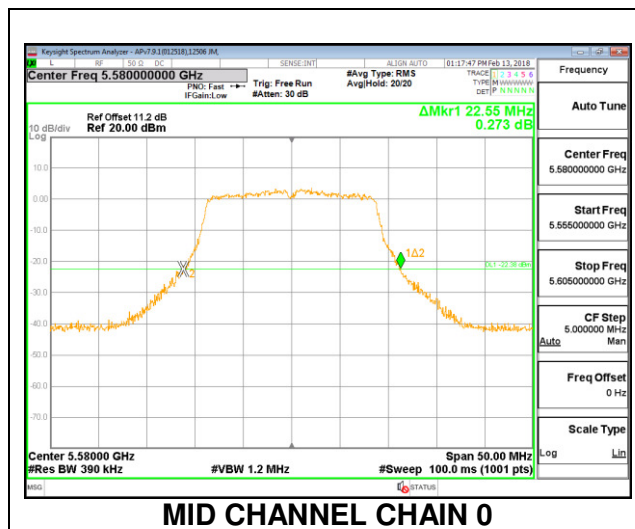

HIGH CHANNEL

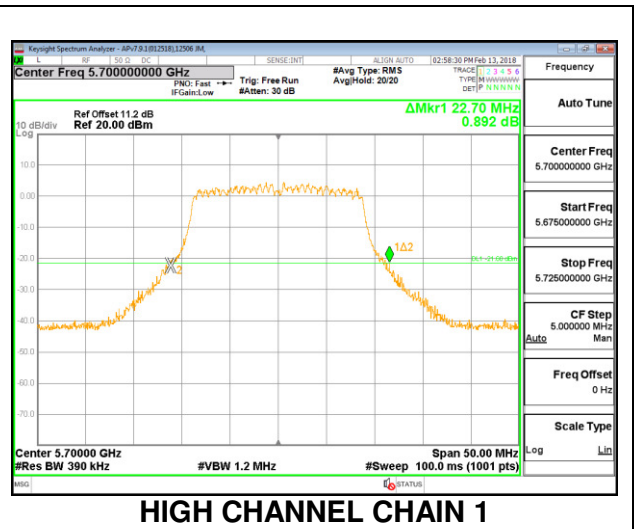
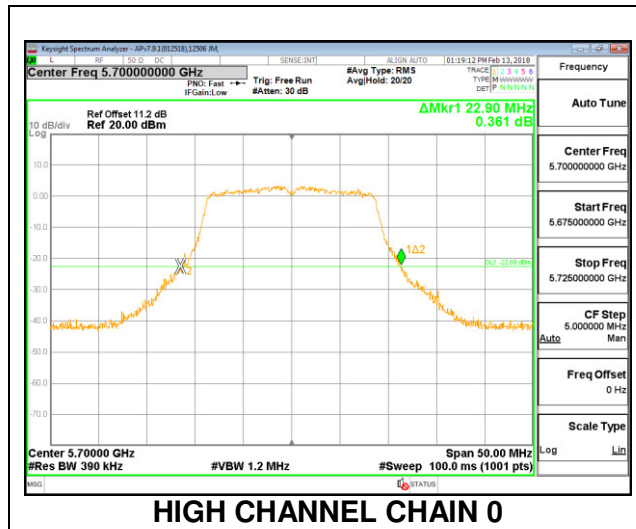

CHANNEL 144

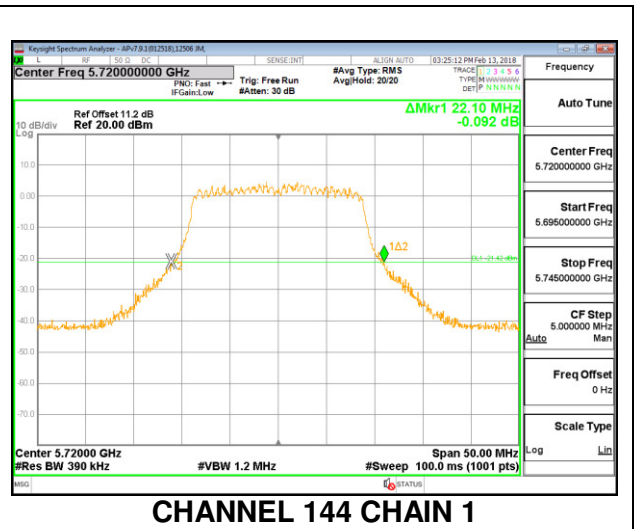
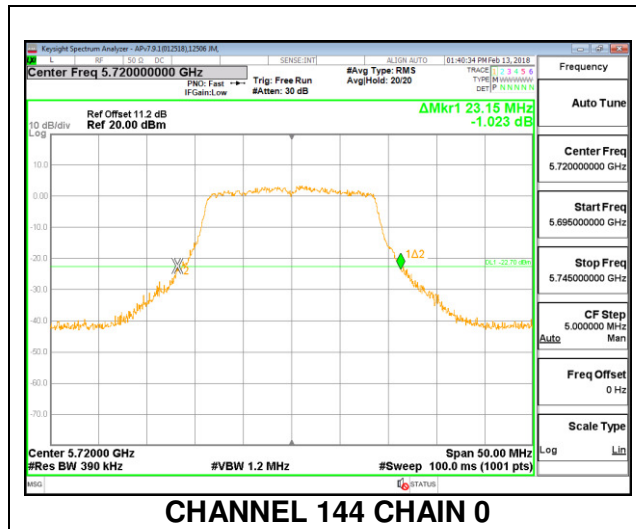

8.2.11. 802.11n HT40 2TX CDD MODE IN THE 5.6 GHz BAND

Channel	Frequency (MHz)	26 dB Bandwidth Chain 0 (MHz)	26 dB Bandwidth Chain 1 (MHz)
Low	5510	41.70	40.90
Mid	5550	41.70	41.10
High	5670	41.50	41.20
142	5710	41.50	41.00

LOW CHANNEL

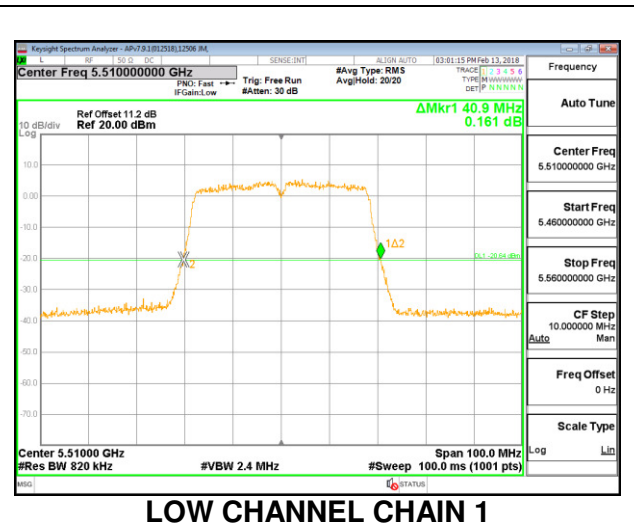
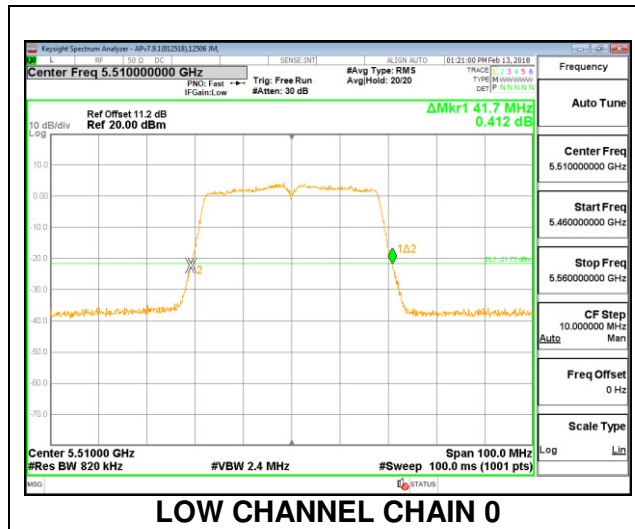

MID CHANNEL

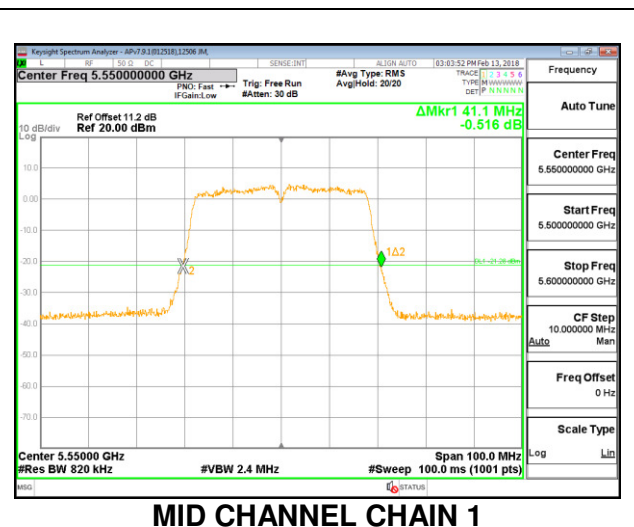
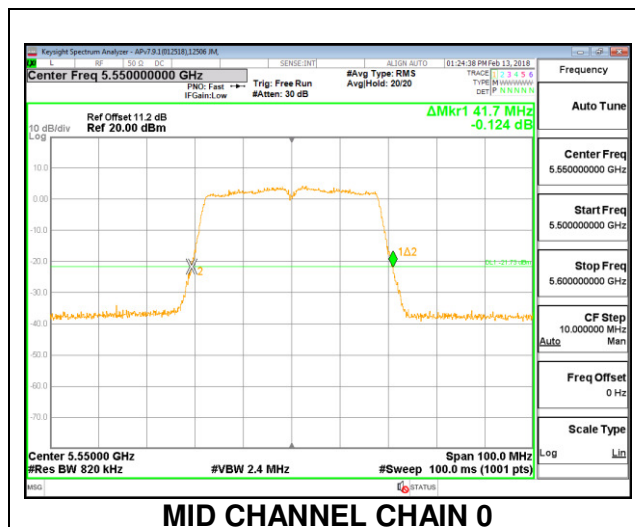

HIGH CHANNEL

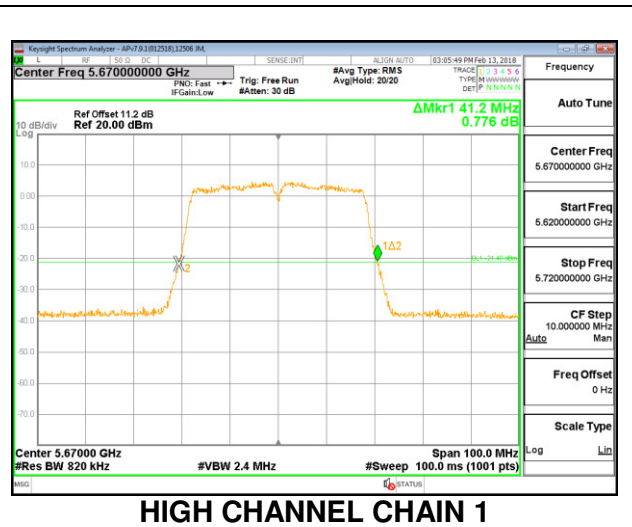
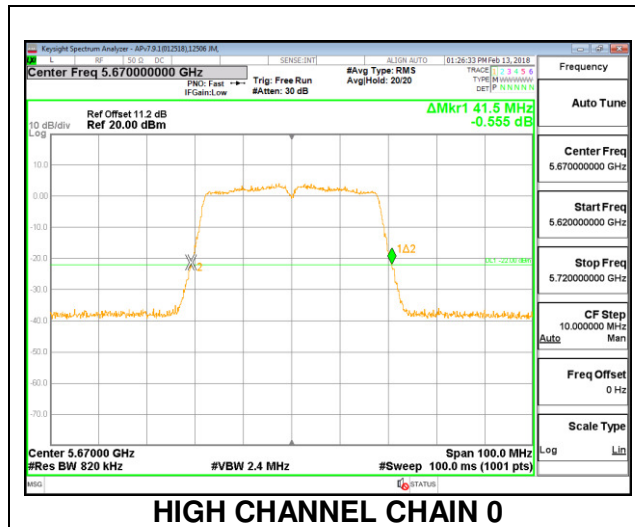

CHANNEL 142

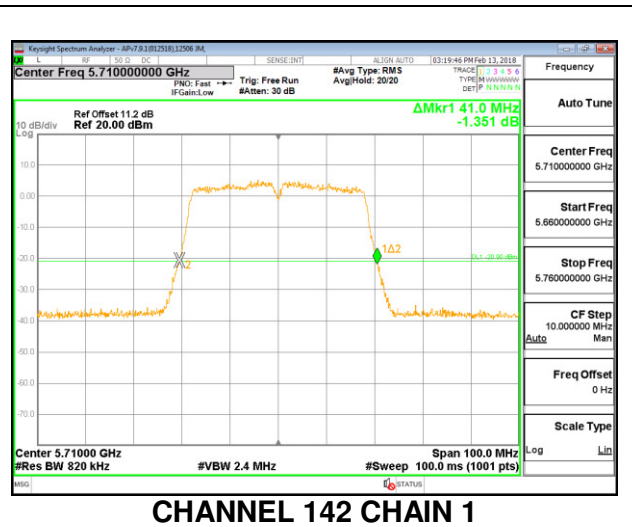
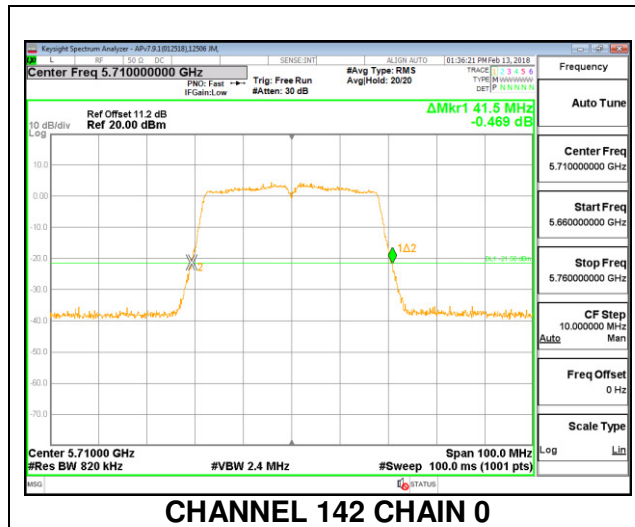

8.2.12. 802.11ac VHT80 2TX CDD MODE IN THE 5.6 GHz BAND

Channel	Frequency (MHz)	26 dB Bandwidth Chain 0 (MHz)	26 dB Bandwidth Chain 1 (MHz)
Low	5530	83.80	83.80
High	5610	84.00	83.60
138	5690	84.00	83.40

LOW CHANNEL

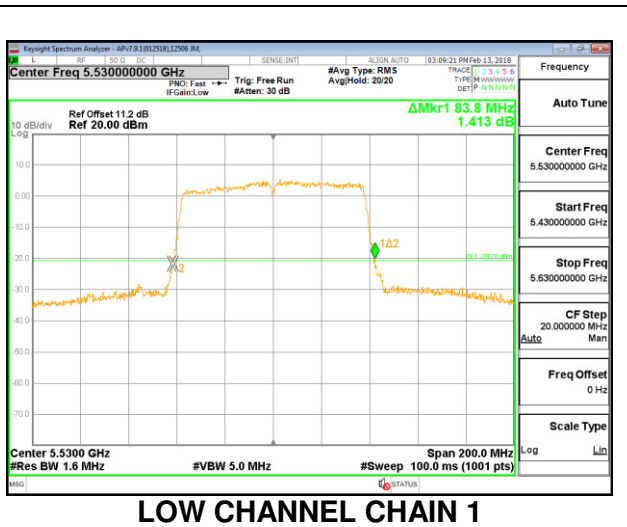
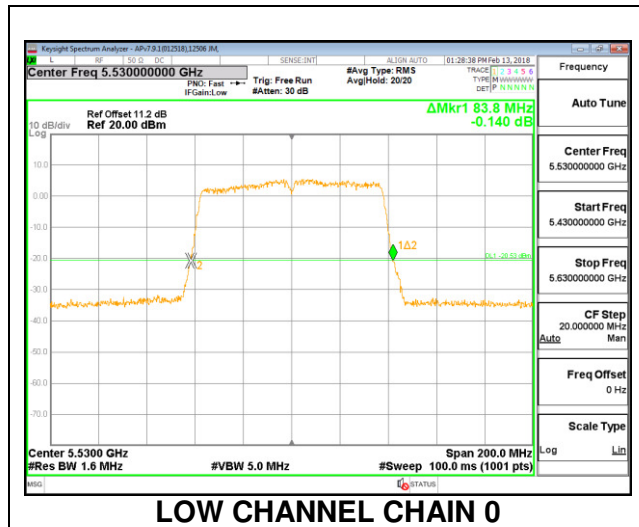

HIGH CHANNEL

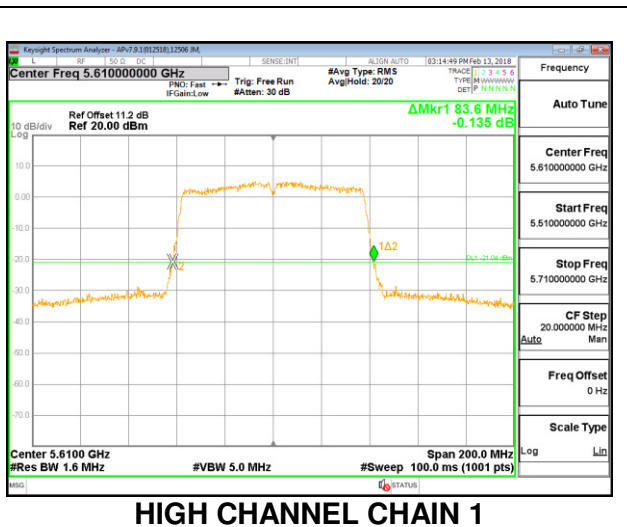
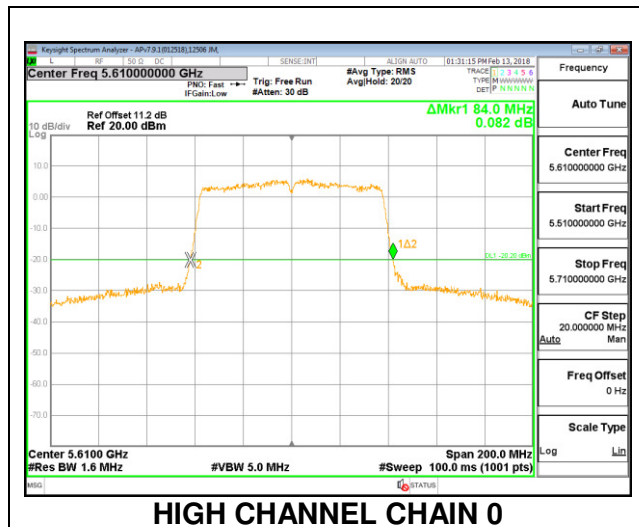

CHANNEL 138

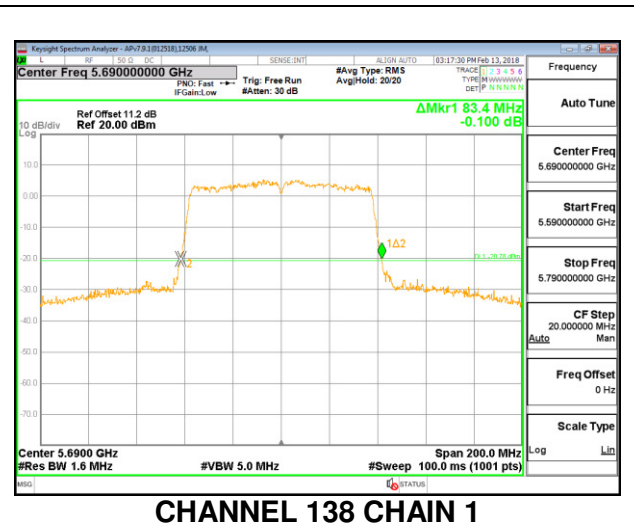
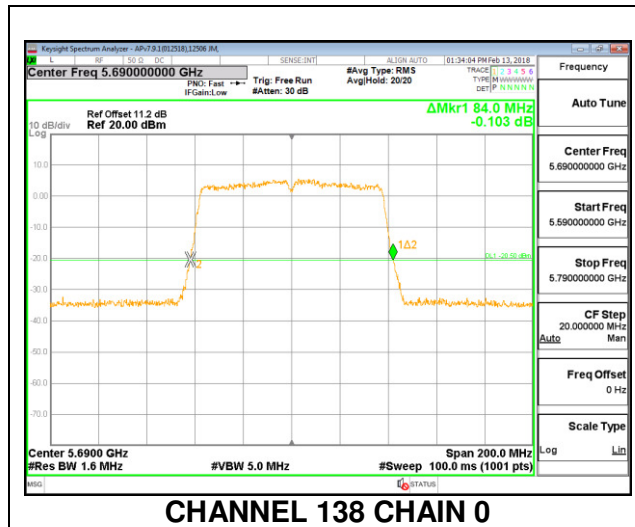

8.2.13. 802.11a 2TX CDD MODE IN THE 5.8 GHz BAND

Channel	Frequency (MHz)	26 dB Bandwidth Chain 0 (MHz)	26 dB Bandwidth Chain 1 (MHz)
Low	5745	22.00	21.45
Mid	5785	21.35	21.35
High	5825	22.15	21.50

LOW CHANNEL

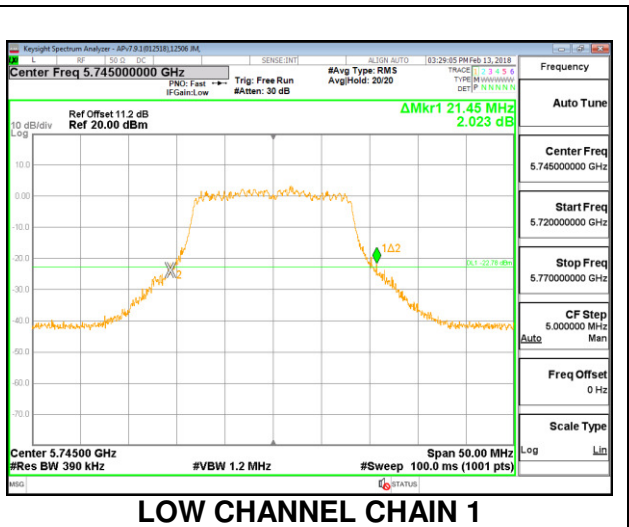
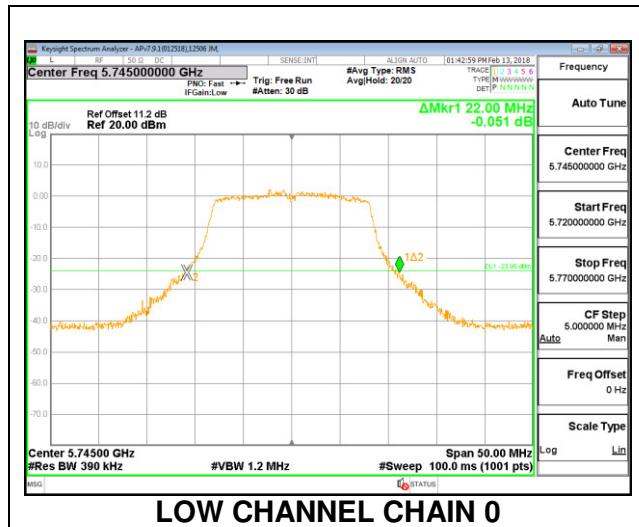

MID CHANNEL

