



CERTIFICATION TEST REPORT

Report Number. : 12132671-E3V2

Applicant : SONY MOBILE COMMUNICATIONS, INC.
4-12-3 HIGASHI-SHINAGAWA,
SHINAGAWA -KU, TOKYO, 140-0002, JAPAN

FCC ID : PY7-11821Y

EUT Description : GSM/WCDMA/LTE Phone with BT, DTS/UNII a/b/g/n/ac &
NFC

Test Standard(s) : FCC 47 CFR PART 15 SUBPART C

Date Of Issue:
March 08, 2018

Prepared by:
UL Verification Services Inc.
47173 Benicia Street
Fremont, CA 94538, U.S.A.
TEL: (510) 771-1000
FAX: (510) 661-0888

REPORT REVISION HISTORY

Rev.	Issue Date	Revisions	Revised By
V1	03/06/18	Initial Issue	
V2	03/08/18	Updated Section 5.5, 5.6, 8.7 and 9.1	Kiya Kedida

TABLE OF CONTENTS

REPORT REVISION HISTORY	2
TABLE OF CONTENTS	3
1. ATTESTATION OF TEST RESULTS	5
2. TEST METHODOLOGY	6
3. FACILITIES AND ACCREDITATION	6
4. CALIBRATION AND UNCERTAINTY	7
4.1. <i>MEASURING INSTRUMENT CALIBRATION</i>	<i>7</i>
4.2. <i>SAMPLE CALCULATION</i>	<i>7</i>
4.3. <i>MEASUREMENT UNCERTAINTY.....</i>	<i>7</i>
5. EQUIPMENT UNDER TEST.....	8
5.1. <i>EUT DESCRIPTION.....</i>	<i>8</i>
5.2. <i>MAXIMUM OUTPUT POWER.....</i>	<i>8</i>
5.3. <i>DESCRIPTION OF AVAILABLE ANTENNAS.....</i>	<i>8</i>
5.4. <i>SOFTWARE AND FIRMWARE.....</i>	<i>8</i>
5.5. <i>WORST-CASE CONFIGURATION AND MODE.....</i>	<i>8</i>
5.6. <i>DESCRIPTION OF TEST SETUP.....</i>	<i>9</i>
6. MEASUREMENT METHOD.....	12
7. TEST AND MEASUREMENT EQUIPMENT	13
8. ANTENNA PORT TEST RESULTS.....	14
8.1. <i>ON TIME AND DUTY CYCLE.....</i>	<i>14</i>
8.2. <i>99% BANDWIDTH.....</i>	<i>17</i>
8.2.1. <i>BLE (1Mbps).....</i>	<i>18</i>
8.2.2. <i>BLE (2Mbps).....</i>	<i>19</i>
8.3. <i>6 dB BANDWIDTH.....</i>	<i>20</i>
8.3.1. <i>BLE (1Mbps).....</i>	<i>21</i>
8.3.2. <i>BLE (2Mbps).....</i>	<i>22</i>
8.4. <i>OUTPUT POWER.....</i>	<i>23</i>
8.4.1. <i>BLE (1Mbps).....</i>	<i>24</i>
8.4.2. <i>BLE (2Mbps).....</i>	<i>25</i>
8.5. <i>AVERAGE POWER.....</i>	<i>26</i>
8.5.1. <i>BLE (1Mbps).....</i>	<i>27</i>
8.5.2. <i>BLE (2Mbps).....</i>	<i>28</i>
8.6. <i>POWER SPECTRAL DENSITY.....</i>	<i>29</i>
8.6.1. <i>BLE (1Mbps).....</i>	<i>30</i>

8.6.2.	BLE (2Mbps).....	31
8.7.	<i>CONDUCTED SPURIOUS EMISSIONS</i>	32
8.7.1.	BLE (1Mbps).....	33
8.7.2.	BLE (2Mbps).....	34
9.	RADIATED TEST RESULTS	35
9.1.	<i>LIMITS AND PROCEDURE</i>	35
9.2.	<i>TRANSMITTER ABOVE 1 GHz</i>	36
9.2.1.	BLE (1Mbps).....	36
9.2.2.	BLE (2Mbps).....	46
9.3.	<i>SPURIOUS EMISSIONS BELOW 30 MHz (WORST-CASE CONFIGURATION)</i>	56
9.4.	<i>Worst Case Below 1 GHz</i>	57
9.5.	<i>Worst Case 18-26 GHz</i>	59
10.	AC POWER LINE CONDUCTED EMISSIONS	61
10.1.1.	AC Power Line Norm.....	62
11.	SETUP PHOTOS	64

1. ATTESTATION OF TEST RESULTS

COMPANY NAME: SONY MOBILE COMMUNICATIONS, INC.
4-12-3 HIGASHI-SHINAGAWA,
SHINAGAWA -KU, TOKYO, 140-0002, JAPAN

EUT DESCRIPTION: GSM/WCDMA/LTE Phone with BT, DTS/UNII a/b/g/n/ac &
NFC

SERIAL NUMBER: BH90005YBB (RADIATED)
BH90009EBB (CONDUCTED)

DATE TESTED: FEBRUARY 12-17, 2018

APPLICABLE STANDARDS	
STANDARD	TEST RESULTS
CFR 47 Part 15 Subpart C	Complies

UL Verification Services Inc. tested the above equipment in accordance with the requirements set forth in the above standards. All indications of Pass/Fail in this report are opinions expressed by UL Verification Services Inc. based on interpretations and/or observations of test results. Measurement Uncertainties were not taken into account and are published for informational purposes only. The test results show that the equipment tested is capable of demonstrating compliance with the requirements as documented in this report.

Note: The results documented in this report apply only to the tested sample, under the conditions and modes of operation as described herein. This document may not be altered or revised in any way unless done so by UL Verification Services Inc. and all revisions are duly noted in the revisions section. Any alteration of this document not carried out by UL Verification Services Inc. will constitute fraud and shall nullify the document. This report must not be used by the client to claim product certification, approval, or endorsement by NVLAP, NIST, any agency of the Federal Government, or any agency of the U.S. government.

Approved & Released For
UL Verification Services Inc. By:

Prepared By:

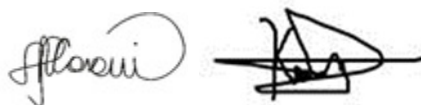

Kiya Kedida/Dan Corona
CONSUMER TECHNOLOGY DIVISION
Project Engineer/Operations Leader
UL Verification Services Inc.

ERIC YU
CONSUMER TECHNOLOGY DIVISION
Test Engineer
UL Verification Services Inc.

2. TEST METHODOLOGY

The tests documented in this report were performed in accordance with FCC CFR 47 Part 2, FCC CFR 47 Part 15, KDB 558074 D01 v04, ANSI C63.10-2013

3. FACILITIES AND ACCREDITATION

The test sites and measurement facilities used to collect data are located at 47173 and 47266 Benicia Street, Fremont, California, USA. Line conducted emissions are measured only at the 47173 address. The following table identifies which facilities were utilized for radiated emission measurements documented in this report. Specific facilities are also identified in the test results sections.

47173 Benicia Street	47266 Benicia Street
<input checked="" type="checkbox"/> Chamber A (ISED:2324B-1)	<input type="checkbox"/> Chamber D (ISED:22541-1)
<input checked="" type="checkbox"/> Chamber B (ISED:2324B-2)	<input type="checkbox"/> Chamber E (ISED:22541-2)
<input type="checkbox"/> Chamber C (ISED:2324B-3)	<input type="checkbox"/> Chamber F (ISED:22541-3)
	<input type="checkbox"/> Chamber G (ISED:22541-4)
	<input type="checkbox"/> Chamber H (ISED:22541-5)

The above test sites and facilities are covered under FCC Test Firm Registration # 208313. Chambers A through C are covered under ISED company address code 2324B with site numbers 2324B -1 through 2324B-3, respectively. Chambers D through H are covered under ISED Canada company address code 22541 with site numbers 22541 -1 through 22541-5, respectively.

UL Verification Services Inc. is accredited by NVLAP, Laboratory Code 200065-0. The full scope of accreditation can be viewed at <http://ts.nist.gov/standards/scopes/2000650.htm>.

4. CALIBRATION AND UNCERTAINTY

4.1. MEASURING INSTRUMENT CALIBRATION

The measuring equipment utilized to perform the tests documented in this report has been calibrated in accordance with the manufacturer's recommendations, and is traceable to recognized national standards.

4.2. SAMPLE CALCULATION

Where relevant, the following sample calculation is provided:

$$\begin{aligned} \text{Field Strength (dBuV/m)} &= \text{Measured Voltage (dBuV)} + \text{Antenna Factor (dB/m)} + \\ &\text{Cable Loss (dB)} - \text{Preamp Gain (dB)} \\ 36.5 \text{ dBuV} + 18.7 \text{ dB/m} + 0.6 \text{ dB} - 26.9 \text{ dB} &= 28.9 \text{ dBuV/m} \end{aligned}$$

4.3. MEASUREMENT UNCERTAINTY

Where relevant, the following measurement uncertainty levels have been estimated for tests performed on the apparatus:

PARAMETER	UNCERTAINTY
Worst Case Conducted Disturbance, 9KHz to 0.15 MHz	3.84 dB
Worst Case Conducted Disturbance, 0.15 to 30 MHz	3.65 dB
Worst Case Radiated Disturbance, 9KHz to 30 MHz	3.15 dB
Worst Case Radiated Disturbance, 30 to 1000 MHz	5.36 dB
Worst Case Radiated Disturbance, 1000 to 18000 MHz	4.32 dB
Worst Case Radiated Disturbance, 18000 to 26000 MHz	4.45 dB
Worst Case Radiated Disturbance, 26000 to 40000 MHz	5.24 dB

Uncertainty figures are valid to a confidence level of 95%.

5. EQUIPMENT UNDER TEST

5.1. EUT DESCRIPTION

The EUT is a GSM/WCDMA/LTE Phone with BT, DTS/UNII a/b/g/n/ac & NFC.

5.2. MAXIMUM OUTPUT POWER

The transmitter has a maximum peak conducted output power as follows:

Frequency Range (MHz)	Mode	Output Power (dBm)	Output Power (mW)
2402 - 2480	BLE (1 Mbps)	5.57	3.61
2402 - 2480	BLE (2 Mbps)	5.61	3.64

5.3. DESCRIPTION OF AVAILABLE ANTENNAS

The radio utilizes Loop Type antenna, with the following maximum gain:

Frequency Band (GHz)	Antenna Gain (dBi)
2402-2480	-0.60

5.4. SOFTWARE AND FIRMWARE

The firmware installed in the EUT during testing was s_atp_XXX_0_00333_A_11.
The test utility software used during testing was Tera Term Ver 4.79.

5.5. WORST-CASE CONFIGURATION AND MODE

Radiated emissions below 30MHz, below 1GHz and above 18GHz, and AC power line conducted emission were performed with the EUT set to transmit at the channel with highest output power as worst-case scenario.

Band edge and radiated emissions between 1GHz and 18GHz were performed with the EUT set to transmit at the highest power on low, middle and high channels.

The fundamental of the EUT was investigated in three orthogonal orientations X, Y, & Z, and it was determined that X-Axis with AC/DC Adapter was worst-case orientation; therefore, all final radiated testing was performed with the EUT in X-Axis with AC/DC Adapter orientation.

5.6. DESCRIPTION OF TEST SETUP

SUPPORT EQUIPMENT

Support Equipment List				
Description	Manufacturer	Model	Serial Number	FCC ID
Laptop	Lenovo	20B7S0A200	PC015REW	NA
AC Adapter	SONY	UCH12	4016W40310044	NA
DC Power Supply	Ametek	XT 15-4	T463	N/A

I/O CABLES (CONDUCTED TEST)

I/O Cable List						
Cable No	Port	# of identical ports	Connector Type	Cable Type	Cable Length (m)	Remarks
1	Antenna	1	RF	Shielded	0.2	To spectrum Analyzer
2	USB	1	USB	Shielded	1	N/A
3	DC	1	DC	Shielded	0.3	N/A

I/O CABLES (RADIATED AND CONDUCTED EMISSIONS)

I/O Cable List						
Cable No	Port	# of identical ports	Connector Type	Cable Type	Cable Length (m)	Remarks
1	USB	1	USB	Shielded	3	N/A

TEST SETUP

CONDCUTED TEST SETUP DIAGRAM

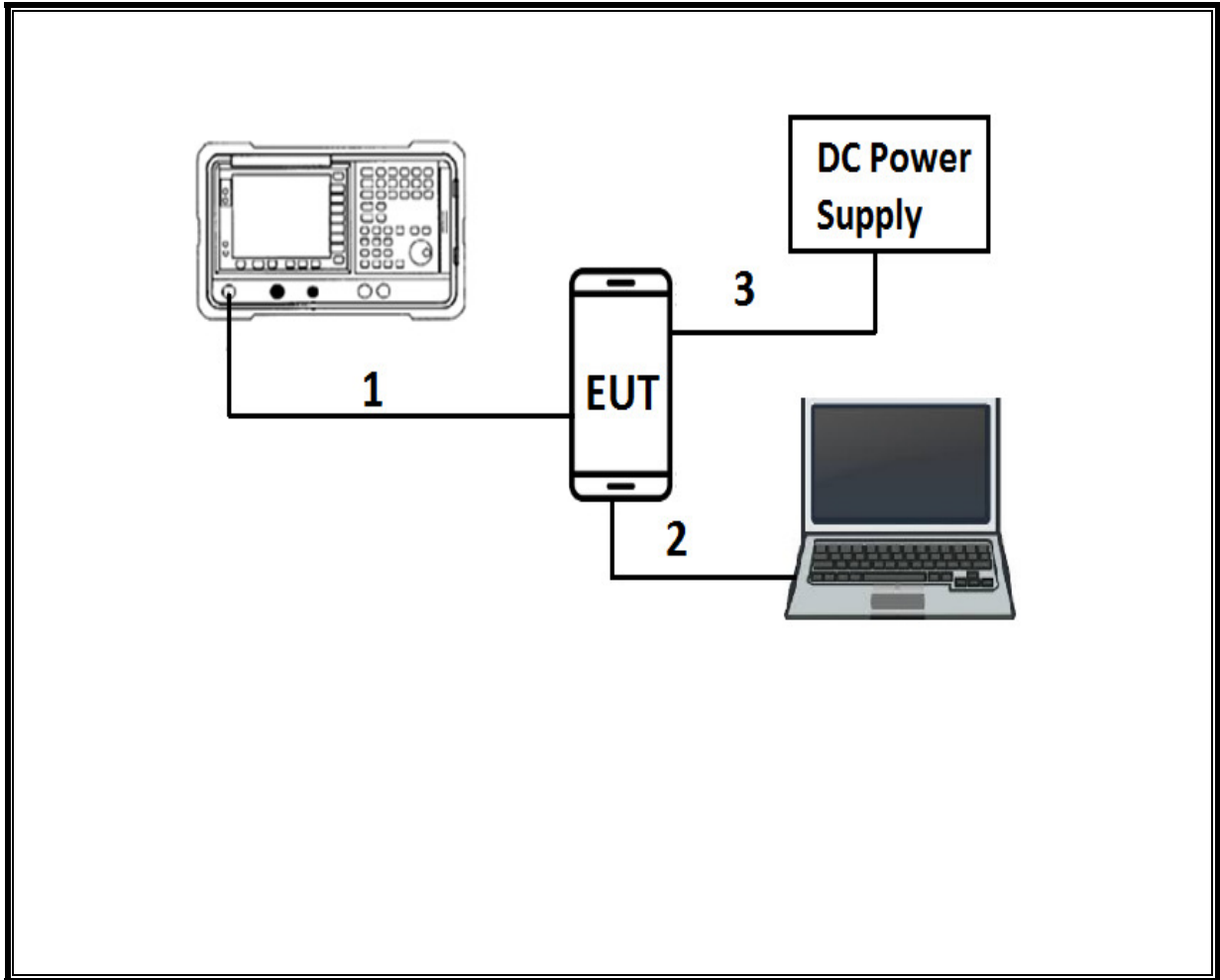

TEST SETUP

RADIATED AND AC LINE CONDUCTED EMISSIONS SETUP DIAGRAM

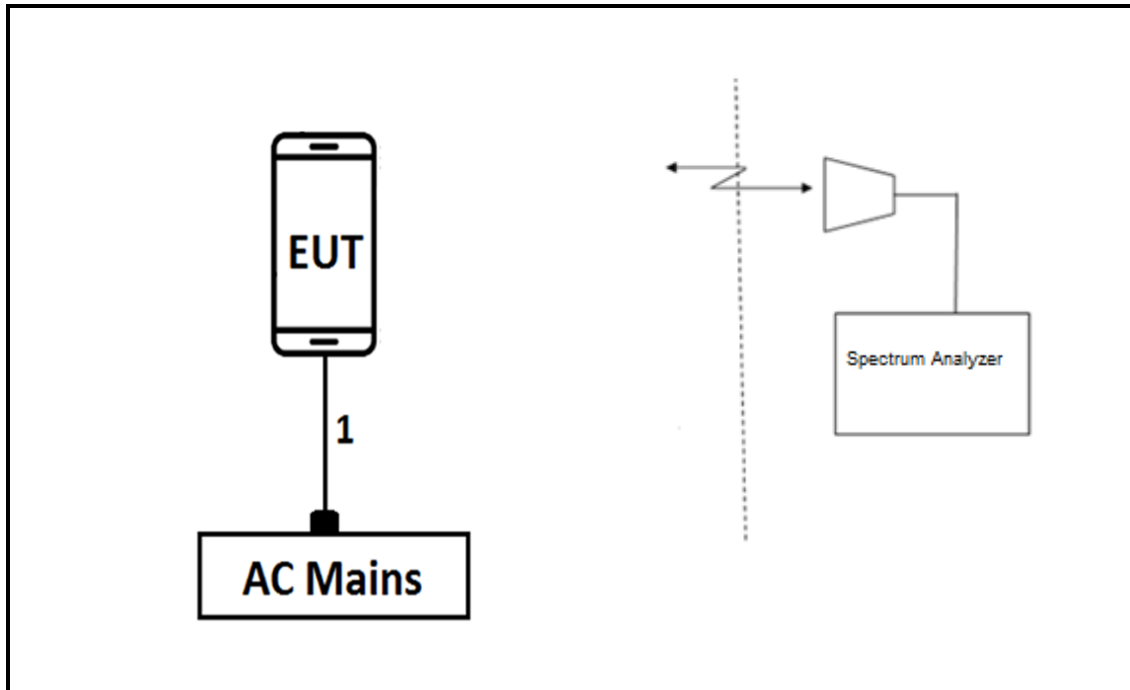

6. MEASUREMENT METHOD

On Time and Duty Cycle: KDB 558074 D01 v04, Section 6.

6 dB BW: KDB 558074 D01 v04, Section 8.1.

Output Power: KDB 558074 D01 v04, Section 9.1.3.

Power Spectral Density: KDB 558074 D01 v04, Section 10.2.

Out-of-band emissions in non-restricted bands: KDB 558074 D01 v04, Section 11.0.

Out-of-band emissions in restricted bands: KDB 558074 D01 v04, Section 12.1.

Band-edge: KDB 558074 D01 v04, Section 12.1.

AC Power Line Conducted Emissions: ANSI C63.10-2013, Section 6.2.

7. TEST AND MEASUREMENT EQUIPMENT

The following test and measurement equipment was utilized for the tests documented in this report:

TEST EQUIPMENT LIST					
Description	Manufacturer	Model	ID Num	Cal Due	Last Cal
Amplifier, 10KHz to 1GHz, 32dB	Agilent (Keysight) Technologies	8447D	T10	02/14/2019	02/14/2018
RF Preamplifier, 1 - 26GHz	Agilent	8449B	T404	07/23/2018	07/23/2017
Antenna, Broadband Hybrid, 30MHz to 2000MHz	Sunol Sciences Corp.	JB1	T130	10/16/2018	10/16/2017
Antenna, Broadband Hybrid, 30MHz to 2000MHz	Sunol Sciences Corp.	JB3	T899	06/15/2018	06/15/2017
Antenna, Horn 1-18GHz	ETS-Lindgren	3117	T346	03/28/2018	03/28/2017
Antenna, Horn 1-18GHz	ETS-Lindgren	3117	T862	06/09/2018	06/09/2017
Antenna, Horn 18-26.5GHz	ARA	MWH-1826	T449	01/04/2019	01/04/2018
Bluetooth Tester	Rohde & Schwarz (Koeln) GmbH & Co. KG	CBT	T258	07/25/2018	07/25/2017
Power Meter, P-series single channel	Agilent (Keysight) Technologies	N1911A	T1269	03/29/2018	03/29/2017
Power Sensor, P - series, 50MHz to 18GHz, Wideband	All	N1921A	T1224	03/29/2018	03/29/2017
Spectrum Analyzer, PXA, 3Hz to 44GHz	Agilent (Keysight) Technologies	N9030A	T1113	12/21/2018	12/21/2017
Spectrum Analyzer, PXA, 3Hz to 44GHz	Agilent (Keysight) Technologies	N9030A	T1466	04/11/2018	04/11/2017
Spectrum Analyzer, PXA, 3Hz to 44GHz	Agilent (Keysight) Technologies	N9030A	T1454	01/08/2019	01/08/2018
Spectrum Analyzer, PXA, 3Hz to 44GHz	Agilent (Keysight) Technologies	N9030A	T1450	02/05/2019	02/05/2018
Power Meter	Keysight	N1911A	T1271	07/17/2018	07/17/2017
Power Sensor	Keysight	N1921A	T413	06/22/2018	06/22/2017
Test Receiver, EMI, 10Hz-7GHz	Rohde & Schwarz	ESR	T1436	01/06/2018	01/06/2017
LISN	Fischer Custom Communications	FCC-LISN-50/250-25-2-01	T1310	06/15/2018	06/15/2017

Test Software List			
Description	Manufacturer	Model	Version
Radiated Software	UL	UL EMC	Ver 9.5, June 24, 2015
Conducted Software	UL	UL EMC	Ver 9.5, May 26, 2015
Antenna Port Software	UL	UL RF	Ver 3.9.1, Dec 28, 2015

8. ANTENNA PORT TEST RESULTS

8.1. ON TIME AND DUTY CYCLE

LIMITS

None; for reporting purposes only.

PROCEDURE

KDB 558074 Zero-Span Spectrum Analyzer Method.

ON TIME AND DUTY CYCLE RESULTS

Mode	ON Time B (msec)	Period (msec)	Duty Cycle x (linear)	Duty Cycle (%)	Duty Cycle Correction Factor (dB)	1/B Minimum VBW (kHz)
BLE 1Mbps	2.131	2.501	0.852	85.21%	0.70	0.469
BLE 2Mbps	1.078	1.877	0.574	57.43%	2.41	0.928

DUTY CYCLE PLOTS

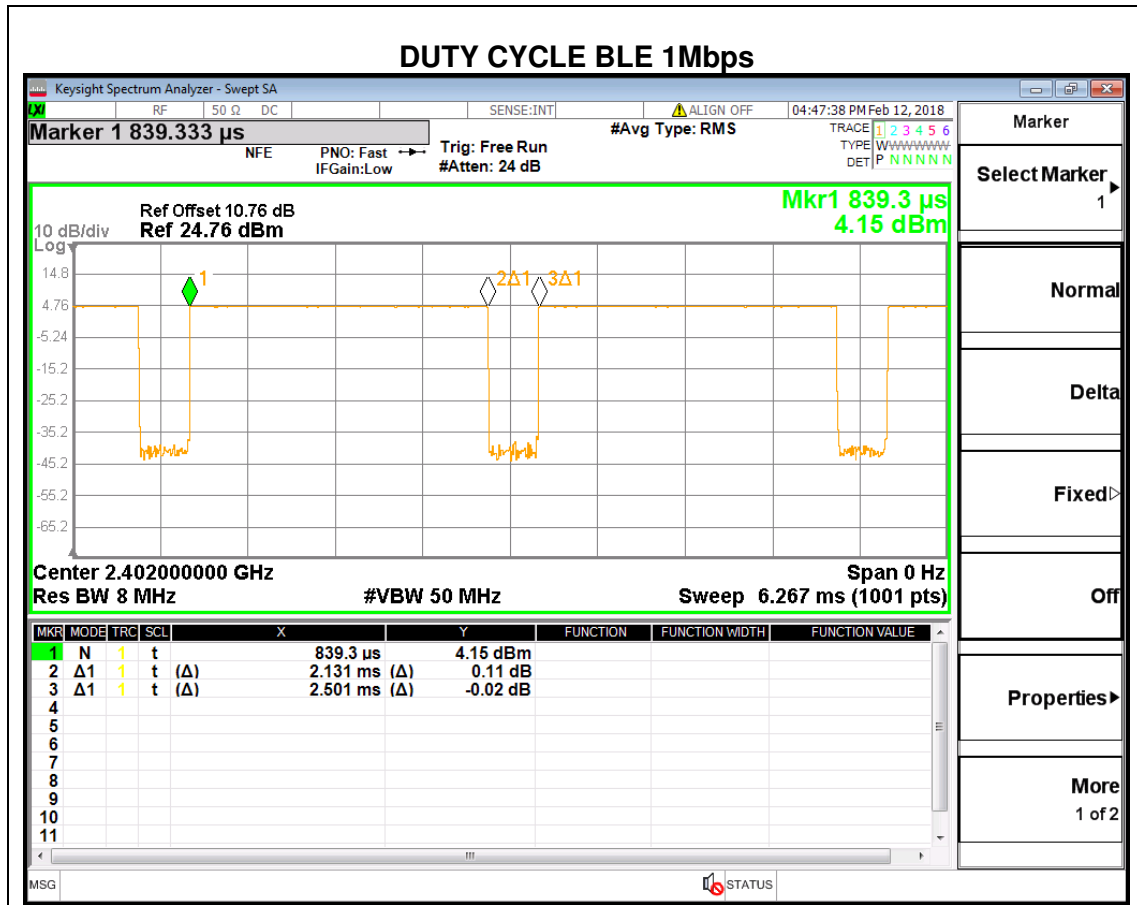

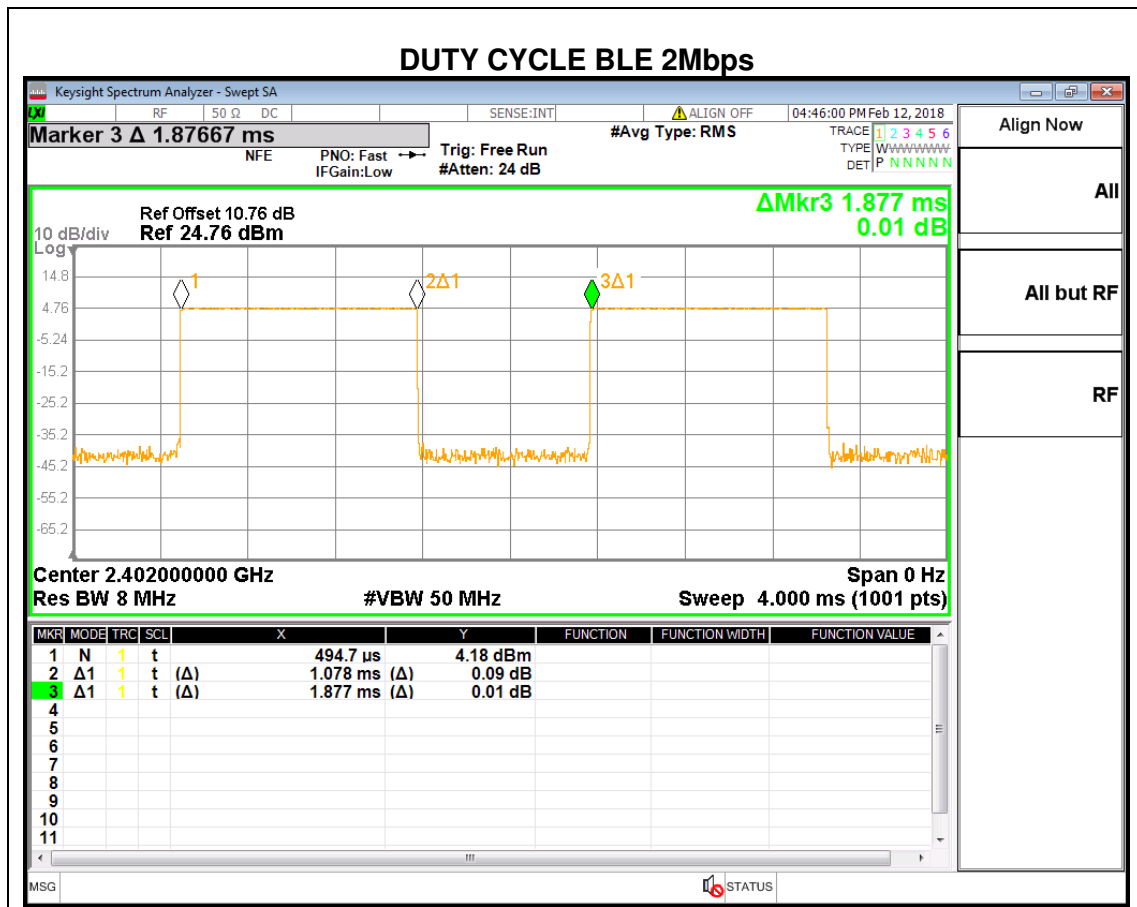

8.2. 99% BANDWIDTH

LIMITS

None; for reporting purposes only.

RESULTS

8.2.1. BLE (1Mbps)

Channel	Frequency (MHz)	99% Bandwidth (MHz)
Low	2402	1.0371
Middle	2440	1.0367
High	2480	1.0365

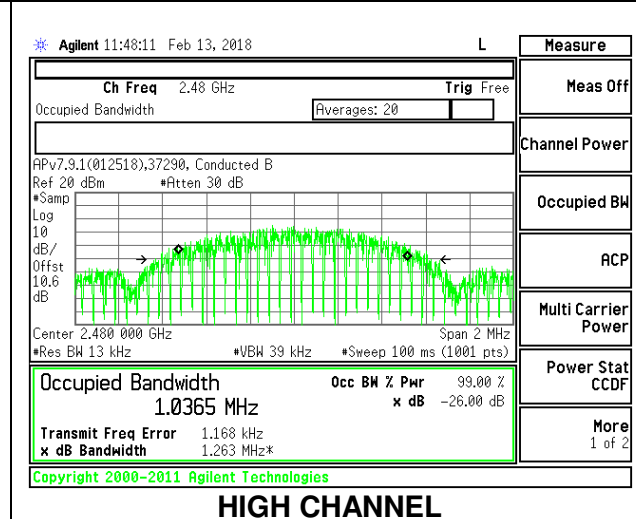
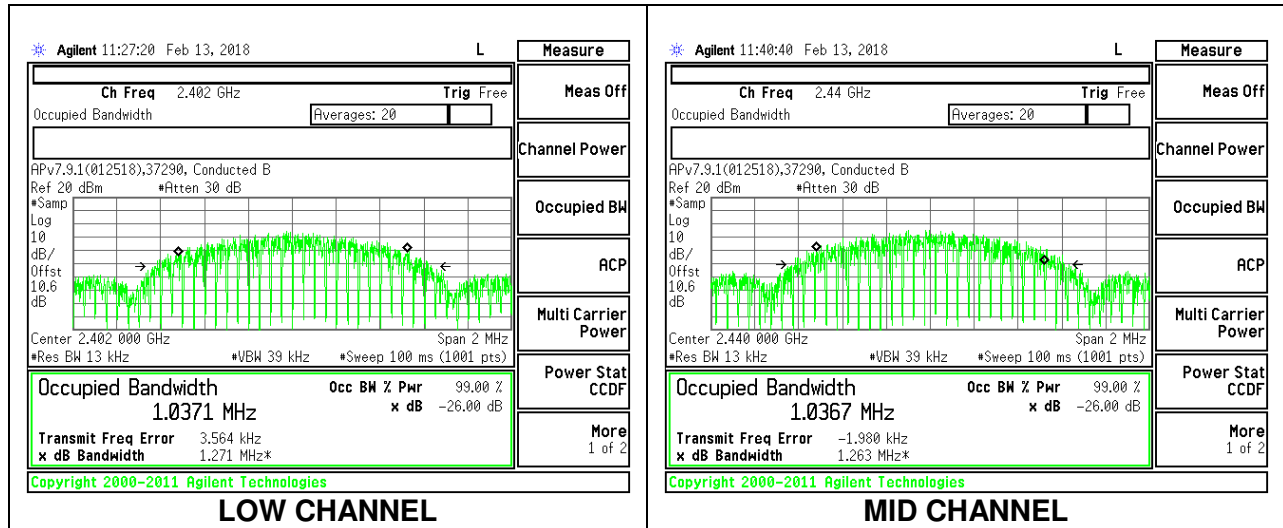

8.2.2. BLE (2Mbps)

Channel	Frequency (MHz)	99% Bandwidth (MHz)
Low	2402	2.0597
Middle	2440	2.0577
High	2480	2.0646

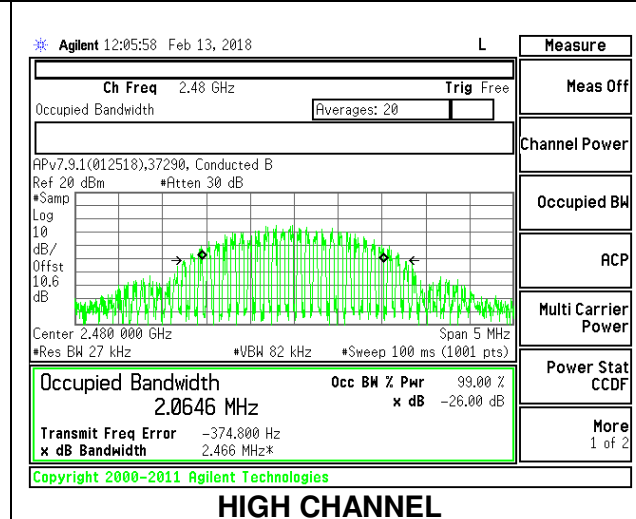
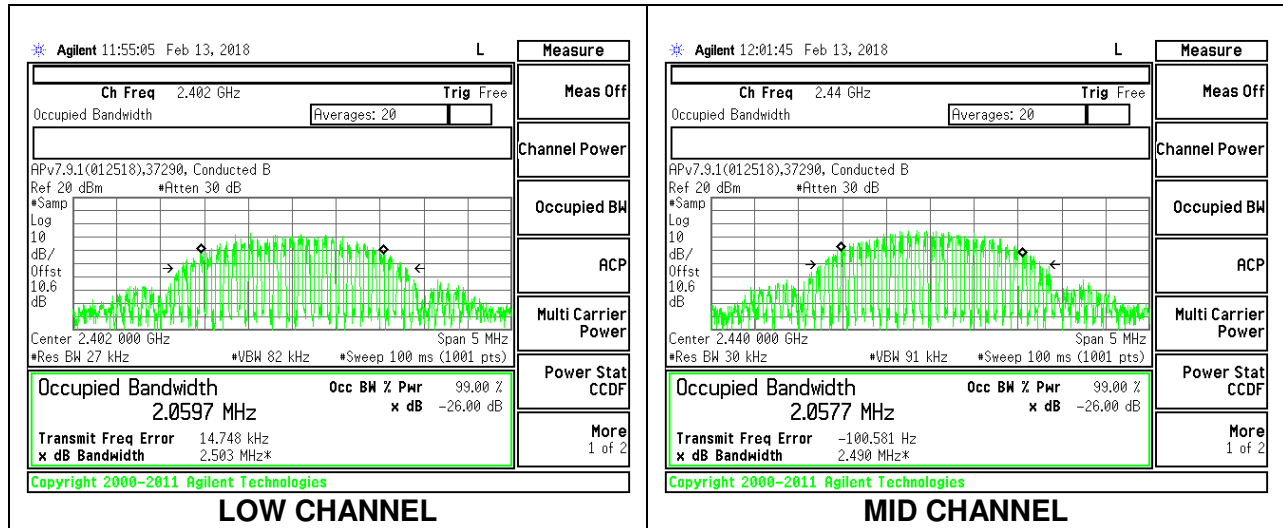

8.3. 6 dB BANDWIDTH

LIMITS

FCC §15.407 (e)

The minimum 6 dB bandwidth shall be at least 500 kHz.

RESULTS

8.3.1. BLE (1Mbps)

Channel	Frequency (MHz)	6 dB Bandwidth (MHz)	Minimum Limit (MHz)
Low	2402	0.6520	0.5
Middle	2440	0.6920	0.5
High	2480	0.7180	0.5

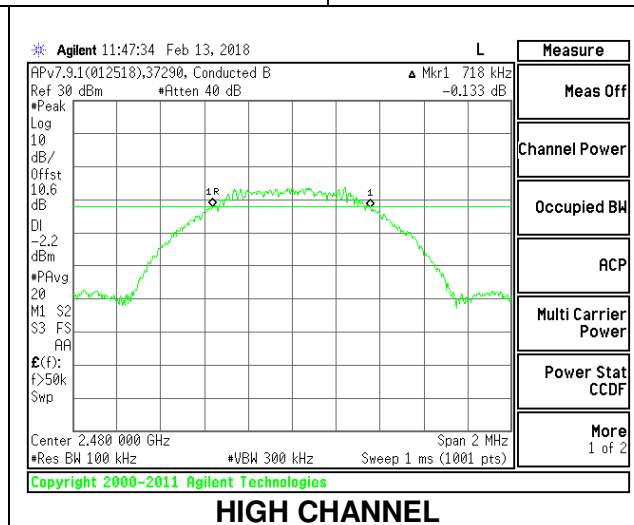
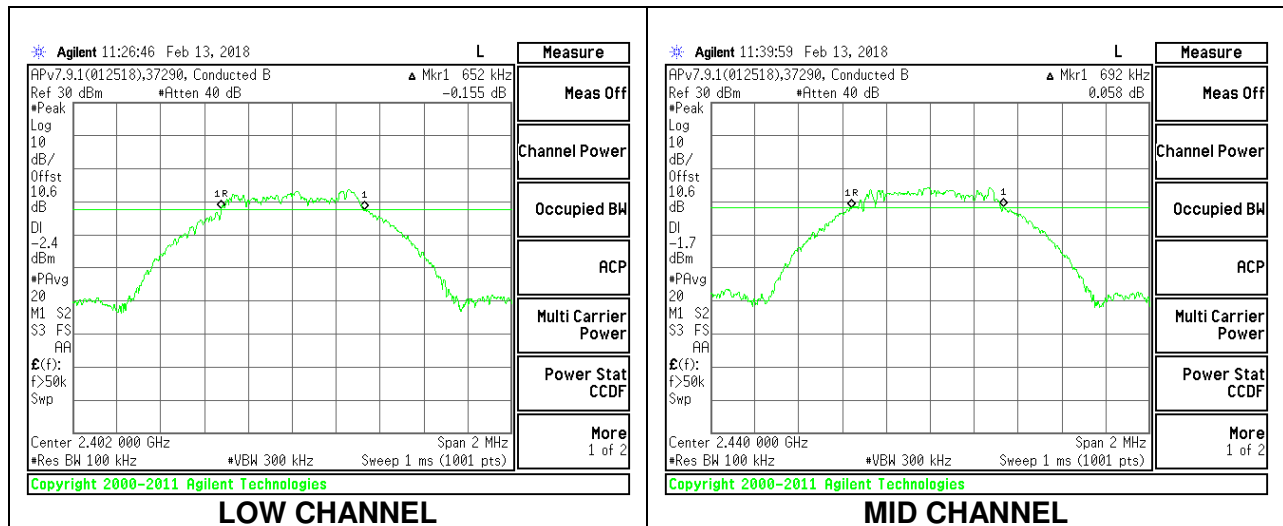

8.3.2. BLE (2Mbps)

Channel	Frequency (MHz)	6 dB Bandwidth (MHz)	Minimum Limit (MHz)
Low	2402	1.2600	0.5
Middle	2440	1.2440	0.5
High	2480	1.2180	0.5

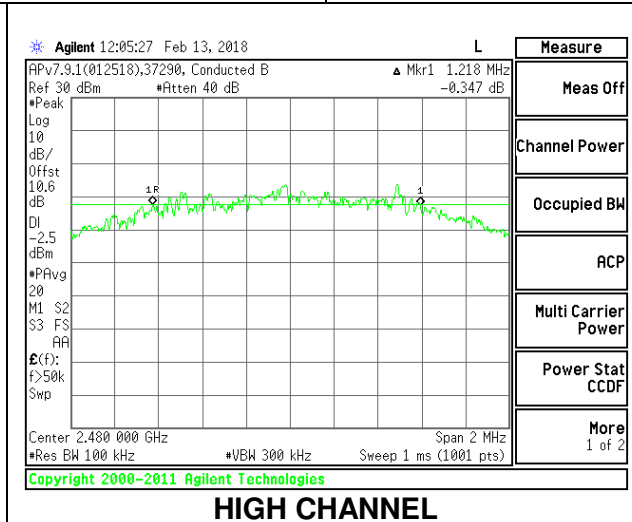
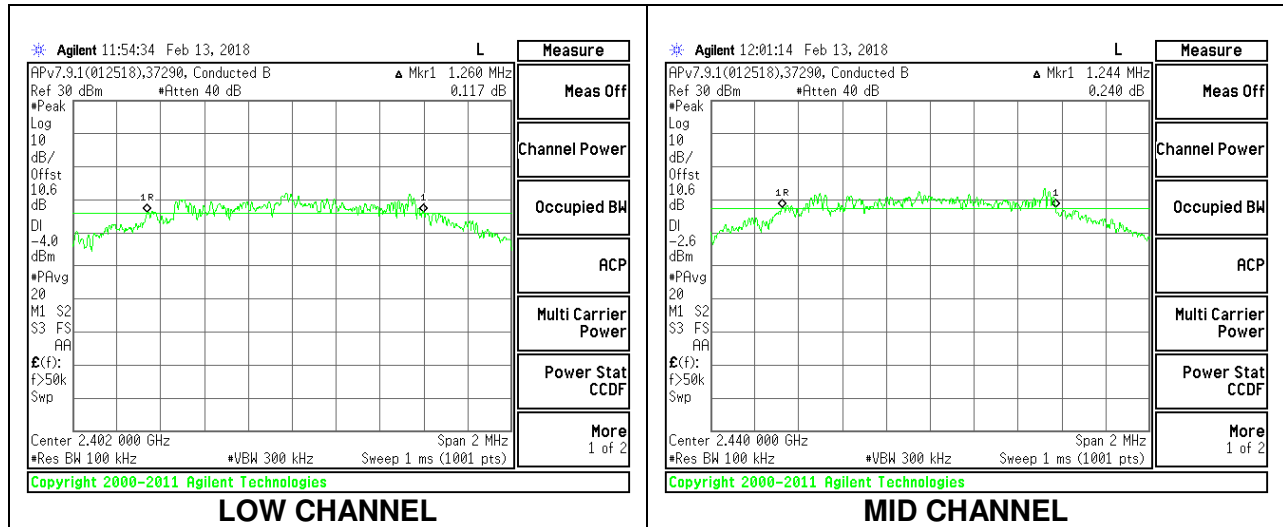

8.4. OUTPUT POWER

LIMITS

FCC §15.247 (b) (3)

The maximum antenna gain is less than or equal to 6 dBi, therefore the limit is 30 dBm.

TEST PROCEDURE

The transmitter output is connected to a power meter. The cable assembly insertion loss was entered as an offset in the power meter to allow for a gated peak reading of power.

RESULTS

8.4.1. BLE (1Mbps)

Tested By:	43578 GE
Date:	2/12/2018

Channel	Frequency (MHz)	Peak Power Reading (dBm)	Limit (dBm)	Margin (dB)
Low	2402	3.980	30	-26.020
Middle	2440	5.570	30	-24.430
High	2480	4.980	30	-25.020

8.4.2. BLE (2Mbps)

Tested By:	43578 GE
Date:	2/12/2018

Channel	Frequency (MHz)	Peak Power Reading (dBm)	Limit (dBm)	Margin (dB)
Low	2402	4.160	30	-25.840
Middle	2440	5.610	30	-24.390
High	2480	5.120	30	-24.880

8.5. AVERAGE POWER

LIMITS

None; for reporting purposes only.

TEST PROCEDURE

The transmitter output is connected to a power meter. The cable assembly insertion loss was entered as an offset in the power meter to allow for a gated peak reading of power.

RESULTS

8.5.1. BLE (1Mbps)

Tested By:	43578 GE
Date:	2/12/2018

Channel	Frequency (MHz)	AV power (dBm)
Low	2402	3.65
Middle	2440	5.14
High	2480	4.70

8.5.2. BLE (2Mbps)

Tested By:	43578 GE
Date:	2/12/2018

Channel	Frequency (MHz)	AV power (dBm)
Low	2402	3.63
Middle	2440	5.12
High	2480	4.67

8.6. POWER SPECTRAL DENSITY

LIMITS

FCC §15.247 (e)

The power spectral density conducted from the transmitter to the antenna shall not be greater than 8 dBm in any 3 kHz band during any time interval of continuous transmission.

RESULTS

8.6.1. BLE (1Mbps)

Channel	Frequency (MHz)	PSD (dBm/3kHz)	Limit (dBm/3kHz)	Margin (dB)
Low	2402	-12.34	8	-20.34
Middle	2440	-10.97	8	-18.97
High	2480	-11.12	8	-19.12

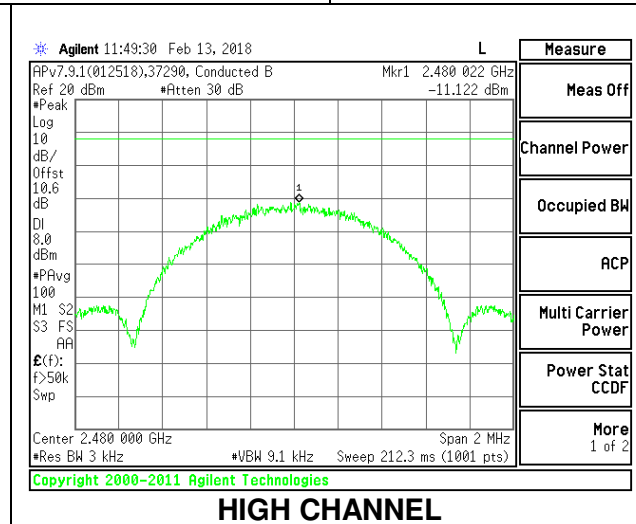
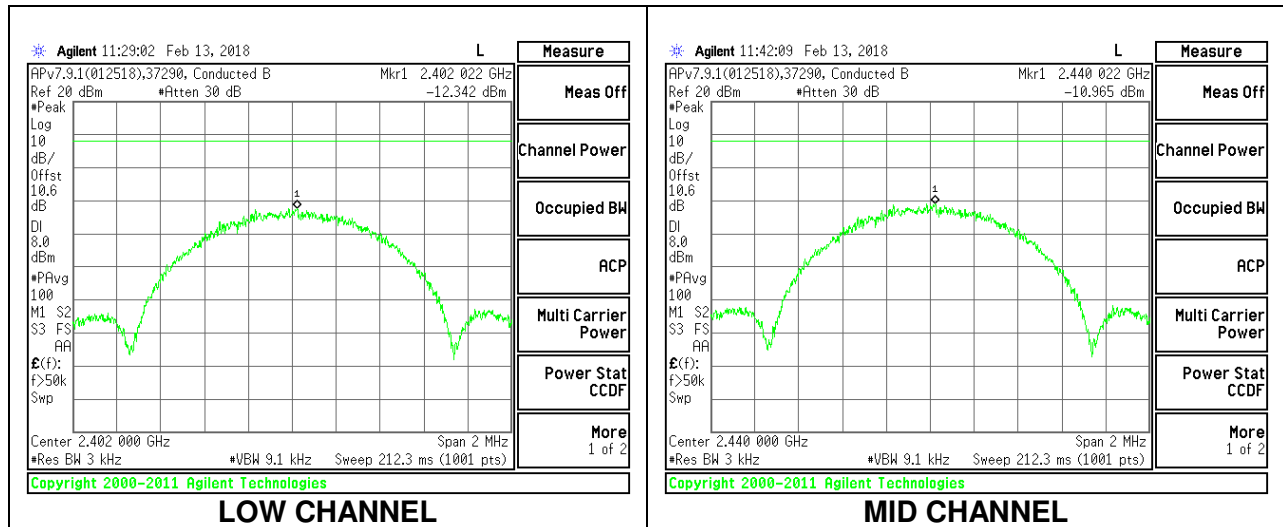

8.6.2. BLE (2Mbps)

Channel	Frequency (MHz)	PSD (dBm/3kHz)	Limit (dBm/3kHz)	Margin (dB)
Low	2402	-14.87	8	-22.87
Middle	2440	-13.40	8	-21.40
High	2480	-13.74	8	-21.74

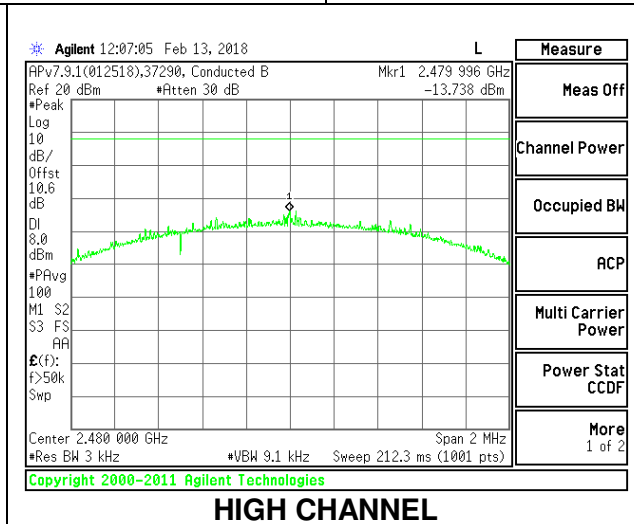
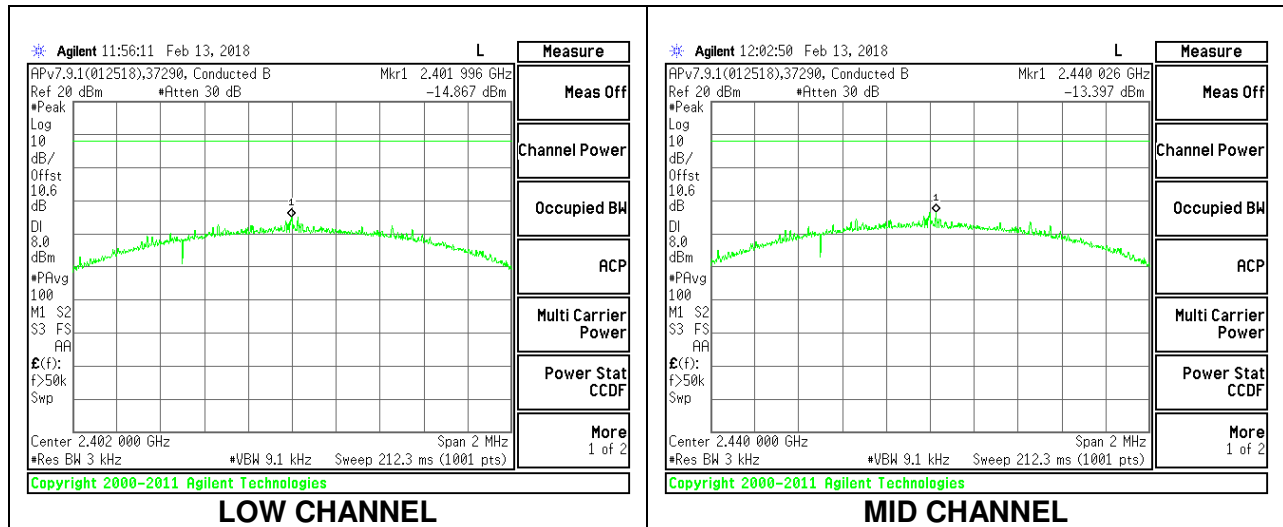

8.7. CONDUCTED SPURIOUS EMISSIONS

LIMITS

FCC §15.247 (d)

Output power was measured based on the use of a peak measurement, therefore the required attenuation is 20 dB.

TEST PROCEDURE

The transmitter output is connected to a spectrum analyzer. The resolution bandwidth is set to 100 kHz. The video bandwidth is set to 300 kHz.

The spectrum from 30 MHz to 26 GHz is investigated with the transmitter set to the lowest, middle, and highest channels.

RESULTS

8.7.1. BLE (1Mbps)

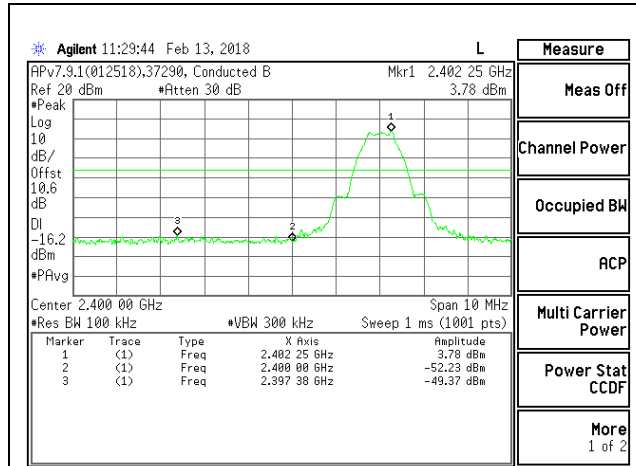

LOW CHANNEL BANDEDGE

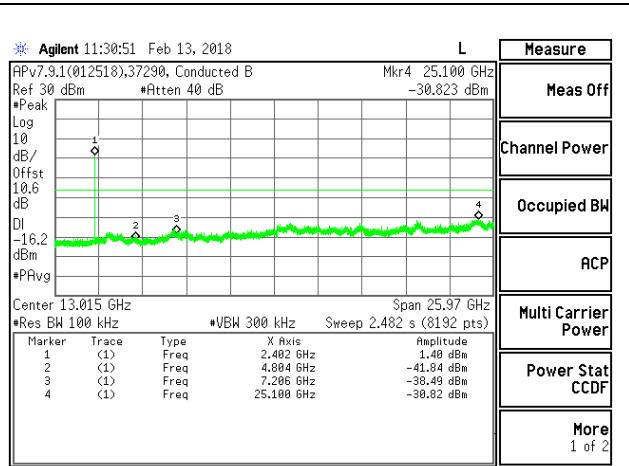

LOW CHANNEL BANDEDGE

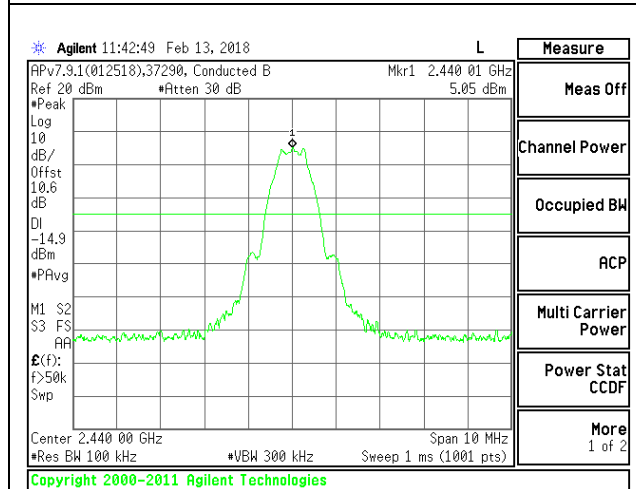

IN-BAND REFERENCE LEVEL

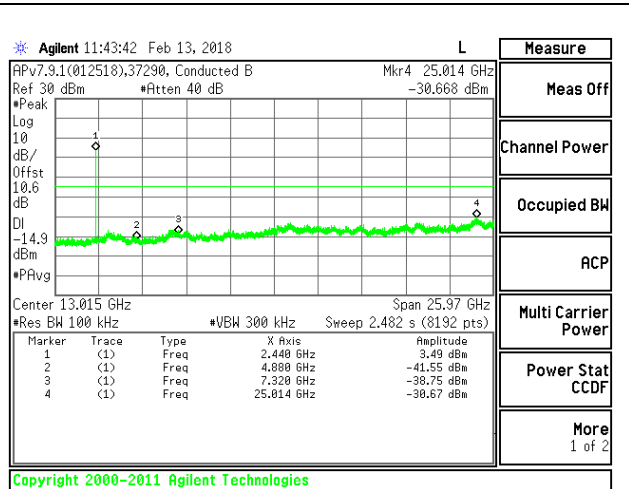

OUT-OF-BAND MID CHANNEL

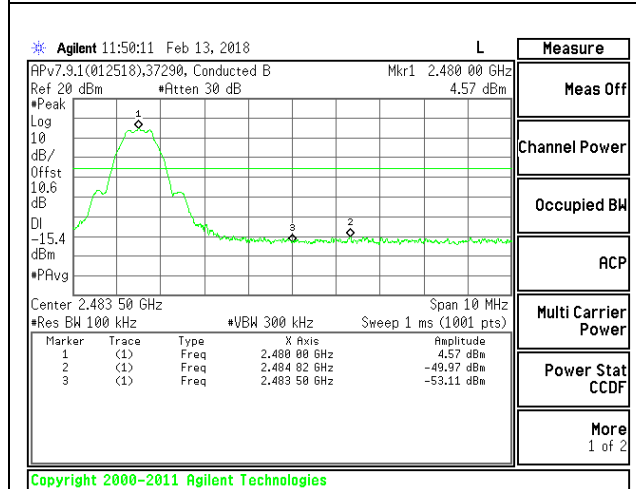

HIGH CHANNEL BANDEDGE

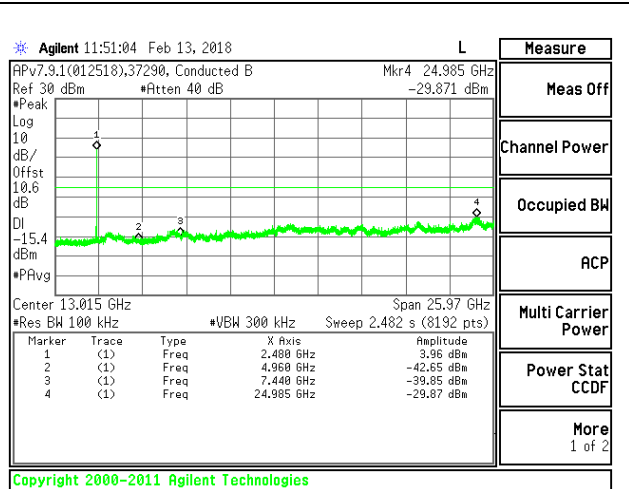

HIGH CHANNEL BANDEDGE

8.7.2. BLE (2Mbps)

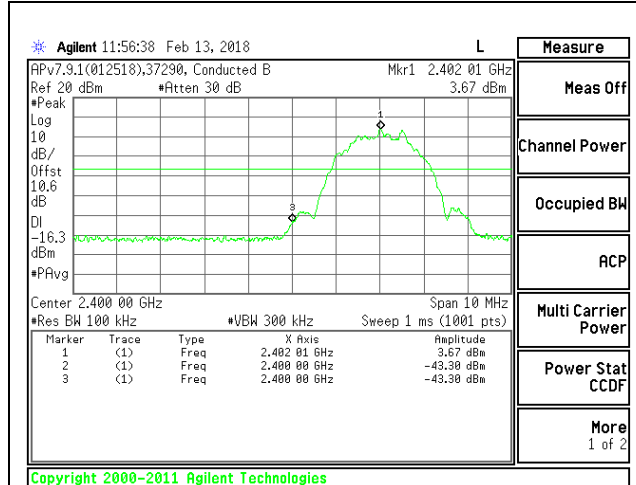

LOW CHANNEL BANDEGE

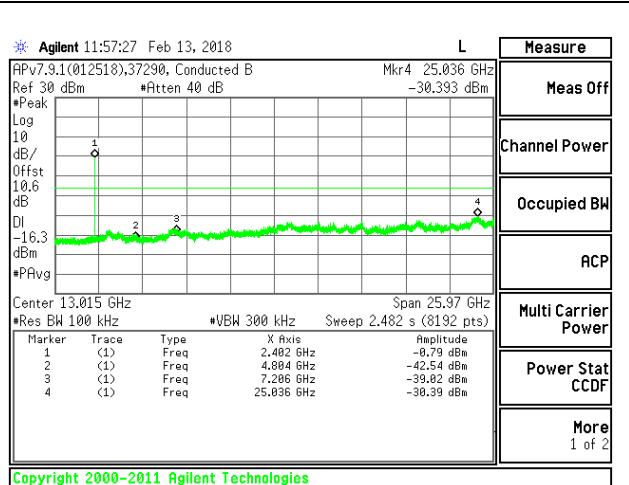

LOW CHANNEL BANDEGE

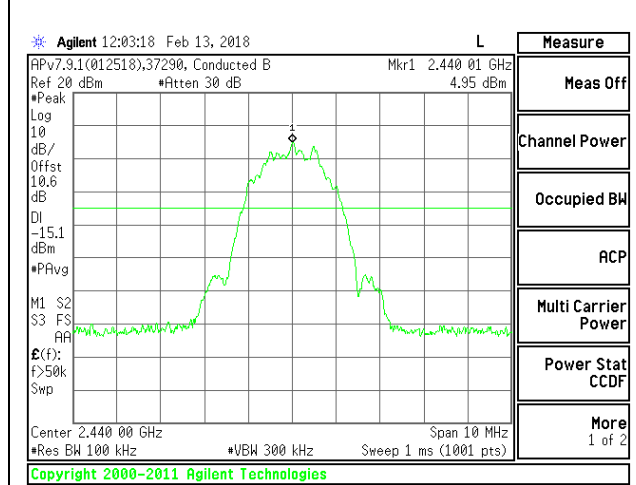

IN-BAND REFERENCE LEVEL

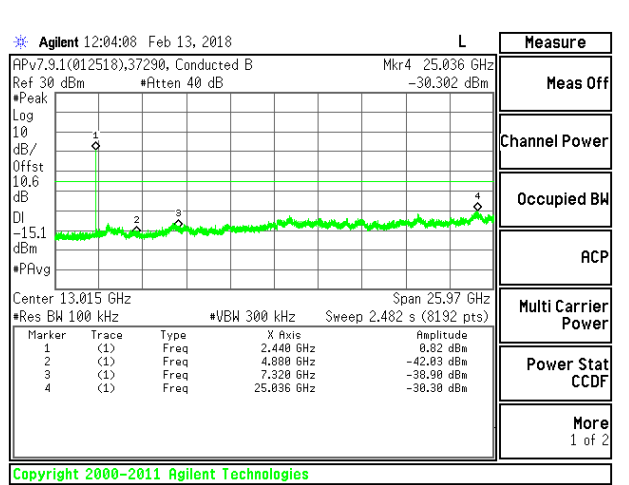

OUT-OF-BAND MID CHANNEL

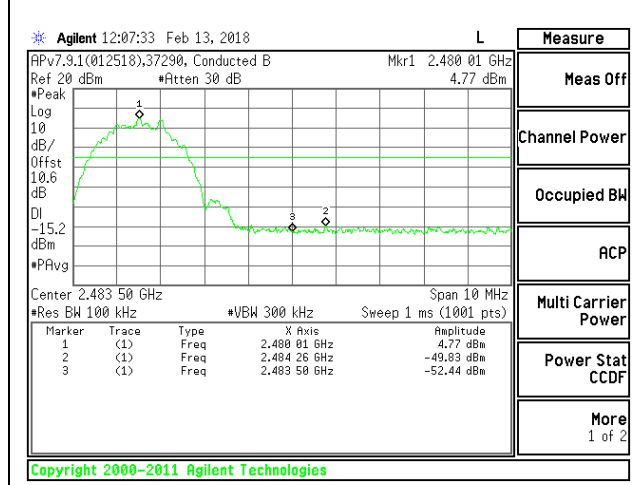

HIGH CHANNEL BANDEGE

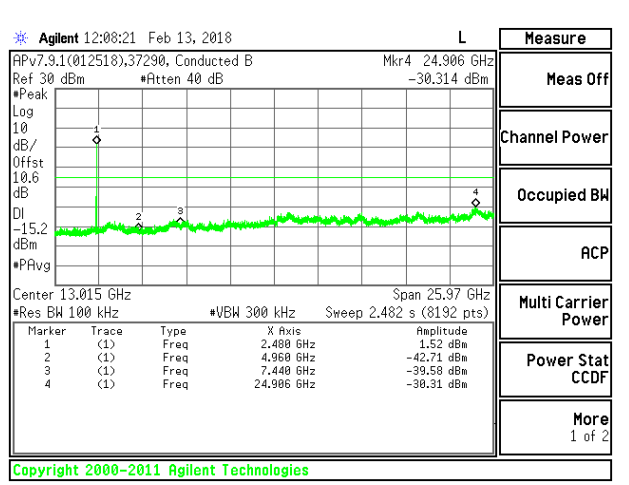

HIGH CHANNEL BANDEGE

9. RADIATED TEST RESULTS

9.1. LIMITS AND PROCEDURE

LIMITS

FCC §15.205 and §15.209

Frequency Range (MHz)	Field Strength Limit (uV/m) at 3 m	Field Strength Limit (dBuV/m) at 3 m
0.009-0.490	2400/F(kHz) @ 300 m	-
0.490-1.705	24000/F(kHz) @ 30 m	-
1.705 - 30	30 @ 30m	-
30 - 88	100	40
88 - 216	150	43.5
216 - 960	200	46
Above 960	500	54

TEST PROCEDURE

The EUT is placed on a non-conducting table 80 cm above the ground plane for measurement below 1GHz; 1.5 m above the ground plane for measurement above 1GHz. The antenna to EUT distance is 3 meters. The EUT is configured in accordance with ANSI C63.10. The EUT is set to transmit in a continuous mode.

For measurements below 1 GHz the resolution bandwidth is set to 100 kHz for peak detection measurements or 120 kHz for quasi-peak detection measurements. Peak detection is used unless otherwise noted as quasi-peak.

For pre-scans above 1 GHz the resolution bandwidth is set to 1 MHz; the video bandwidth is set to 30 KHz for peak measurements.

For final measurements above 1 GHz the resolution bandwidth is set to 1 MHz; the video bandwidth is set to 3 MHz for peak measurements and as applicable for average measurements.

The spectrum from 1 GHz to 18 GHz is investigated with the transmitter set to the lowest, middle, and highest channels in each applicable band. Below 30MHz, below 1GHz and above 18GHz emissions, the channel with the highest output power was tested.

The frequency range of interest is monitored at a fixed antenna height and EUT azimuth. The EUT is rotated through 360 degrees to maximize emissions received. The antenna is scanned from 1 to 4 meters above the ground plane to further maximize the emission. Measurements are made with the antenna polarized in both the vertical and the horizontal positions.

9.2. TRANSMITTER ABOVE 1 GHz

9.2.1. BLE (1Mbps)

BANDEDGE (LOW CHANNEL)

HORIZONTAL RESULT

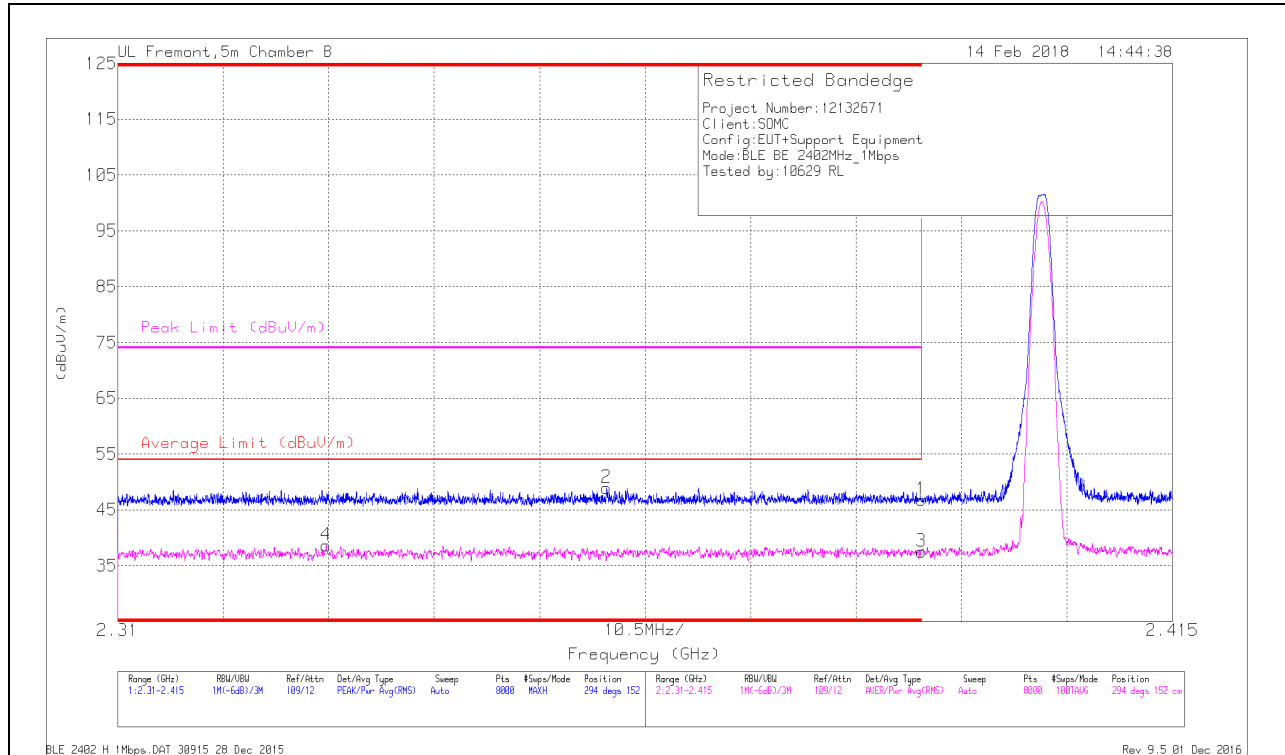

Marker	Frequency (GHz)	Meter Reading (dBuV)	Det	AF Y346 (dBm)	Amp/Cbl/Filt/Pad (dB)	DC Corr (dB)	Corrected Reading (dBuV/m)	Average Limit (dBuV/m)	Margin (dB)	Peak Limit (dBuV/m)	PK Margin (dB)	Azimuth (Degs)	Height (cm)	Polarity
1	* 2.39	36.12	Pk	32	-21.3	0	46.82	-	-	74	-27.18	294	152	H
2	* 2.359	38.33	Pk	31.9	-21.3	0	48.93	-	-	74	-25.07	294	152	H
3	* 2.39	26.06	RMS	32	-21.3	.7	37.46	54	-16.54	-	-	294	152	H
4	* 2.331	27.31	RMS	31.9	-21.3	.7	38.61	54	-15.39	-	-	294	152	H

* - indicates frequency in CFR47 Pt 15 - Restricted Band

Pk - Peak detector

RMS - RMS detection

VERTICAL RESULT

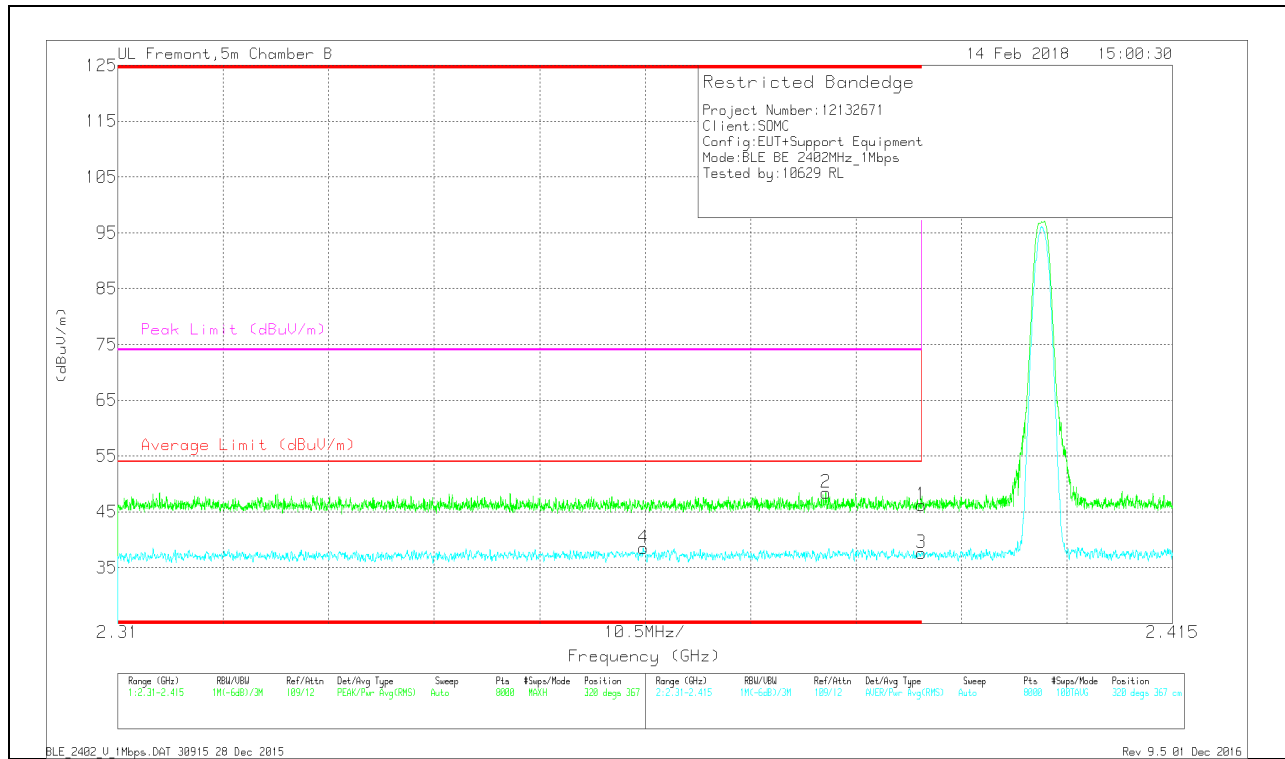

Marker	Frequency (GHz)	Meter Reading (dBuV)	Det	AF T346 (dBm)	Amp/Cbl/Filtr/Pad (dB)	DC Corr (dB)	Corrected Reading (dBuV/m)	Average Limit (dBuV/m)	Margin (dB)	Peak Limit (dBuV/m)	PK Margin (dB)	Azimuth (Degs)	Height (cm)	Polarity
4	* 2.362	27.27	RMS	31.9	-21.4	.7	38.47	54	-15.53	-	-	320	367	V
2	* 2.38	37.76	Pk	32	-21.3	0	48.46	-	-	74	-25.54	320	367	V
1	* 2.39	35.52	Pk	32	-21.3	0	46.22	-	-	74	-27.78	320	367	V
3	* 2.39	26.25	RMS	32	-21.3	.7	37.65	54	-16.35	-	-	320	367	V

* - indicates frequency in CFR47 Pt 15 - Restricted Band
 Pk - Peak detector
 RMS - RMS detection

BANDEDGE (HIGH CHANNEL)

HORIZONTAL RESULT

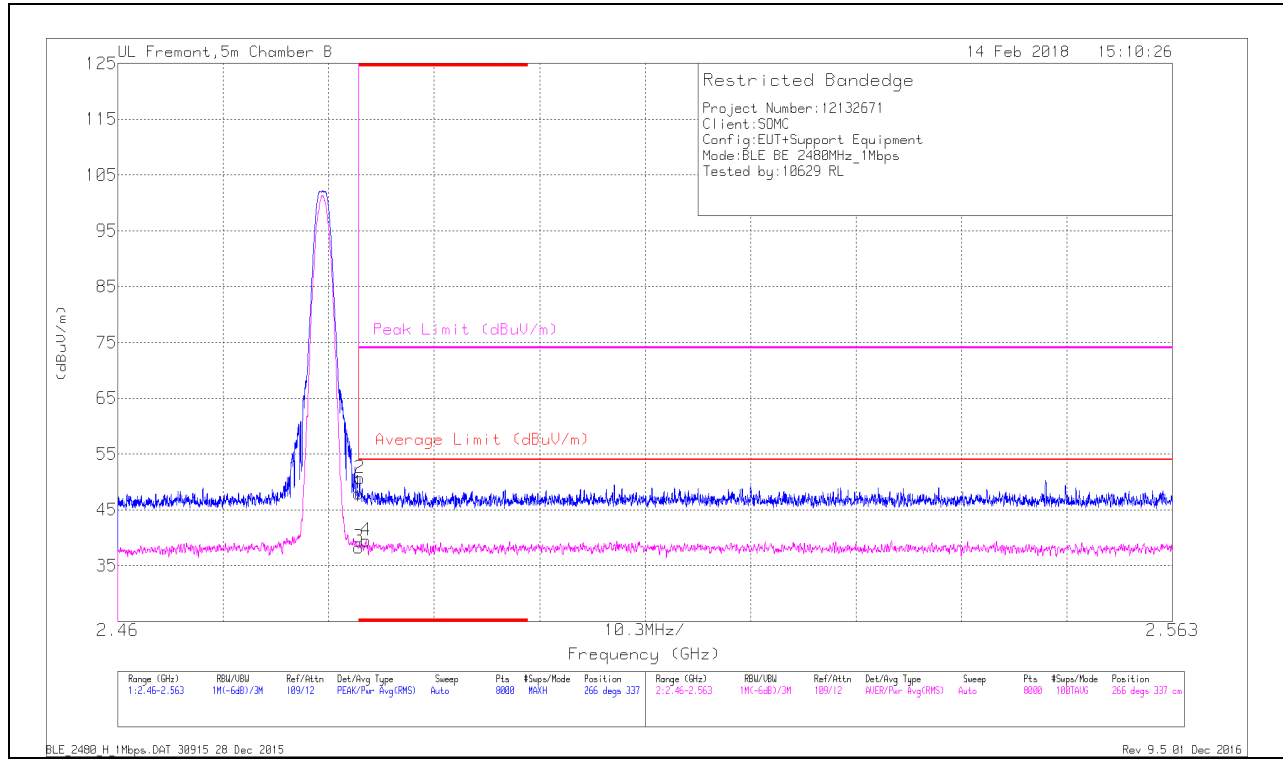

Marker	Frequency (GHz)	Meter Reading (dBuV)	Det	AF T346 (dBm)	Amp/Cbl/Fitr/Pad (dB)	DC Corr (dB)	Corrected Reading (dBuV/m)	Average Limit (dBuV/m)	Margin (dB)	Peak Limit (dBuV/m)	PK Margin (dB)	Azimuth (Degs)	Height (cm)	Polarity
1	* 2.484	36.69	Pk	32.5	-21.3	0	47.89	-	-	74	-26.11	266	337	H
2	* 2.484	39.41	Pk	32.5	-21.3	0	50.61	-	-	74	-23.39	266	337	H
3	* 2.484	26.38	RMS	32.5	-21.3	.7	38.28	54	-15.72	-	-	266	337	H
4	* 2.484	27.64	RMS	32.5	-21.3	.7	39.54	54	-14.46	-	-	266	337	H

* - indicates frequency in CFR47 Pt 15 - Restricted Band
 Pk - Peak detector
 RMS - RMS detection

VERTICAL RESULT

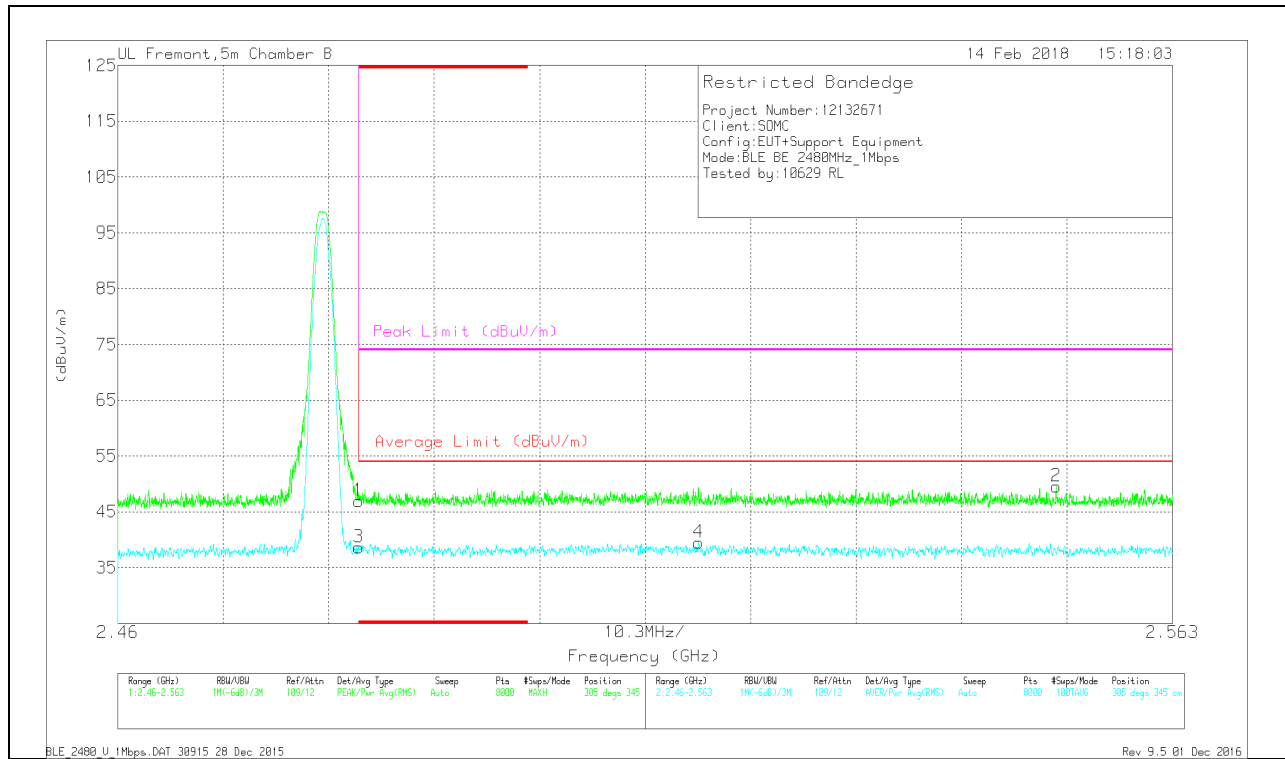

Marker	Frequency (GHz)	Meter Reading (dBuV)	Det	AF T346 (dBm)	Amp/Clf/Filt/Pad (dB)	DC Corr (dB)	Corrected Reading (dBuV/m)	Average Limit (dBuV/m)	Margin (dB)	Peak Limit (dBuV/m)	PK Margin (dB)	Azimuth (Degs)	Height (cm)	Polarity
1	* 2.484	35.7	Pk	32.5	-21.3	0	46.9	-	-	74	-27.1	305	345	V
3	* 2.484	26.72	RMS	32.5	-21.3	.7	38.62	54	-15.38	-	-	305	345	V
4	2.517	27.29	RMS	32.6	-21.1	.7	39.49	54	-14.51	-	-	305	345	V
2	2.552	38.23	Pk	32.5	-21.2	0	49.53	-	-	74	-24.47	305	345	V

* - indicates frequency in CFR47 Pt 15 - Restricted Band
 Pk - Peak detector
 RMS - RMS detection

HARMONICS AND SPURIOUS EMISSIONS

LOW CHANNEL RESULTS

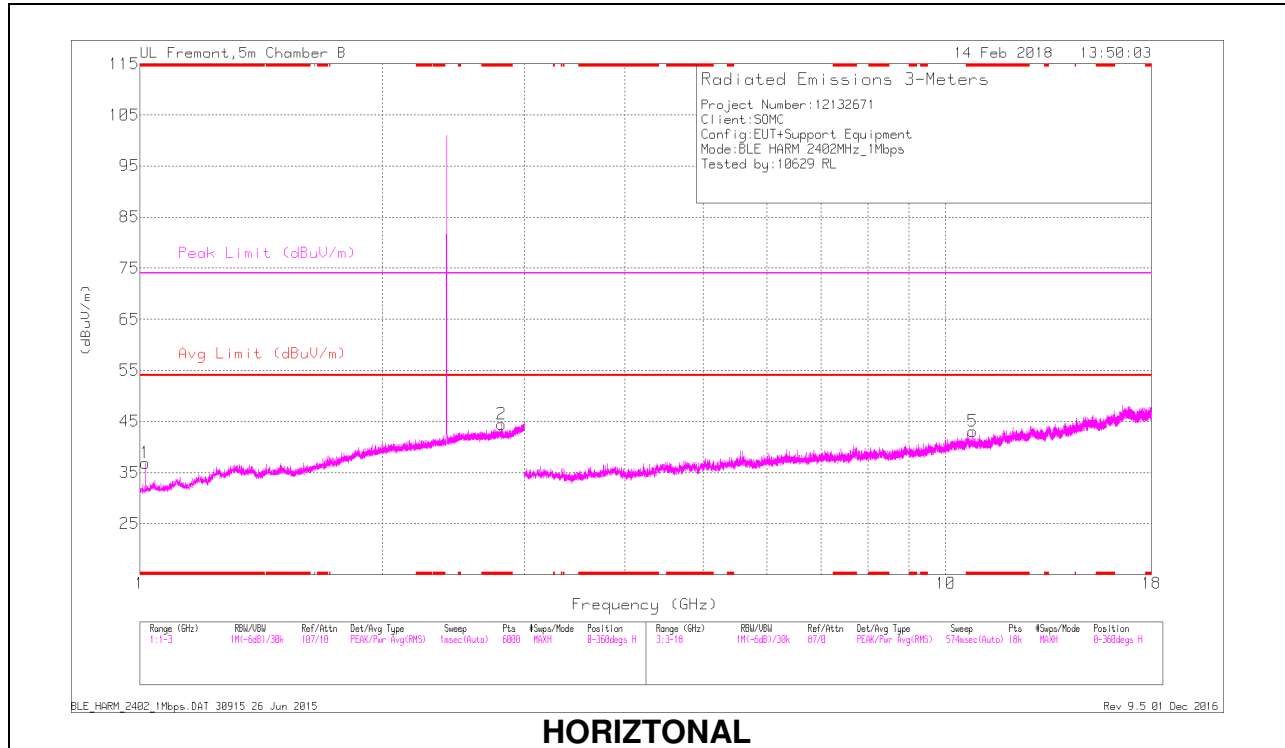

HORIZONTAL

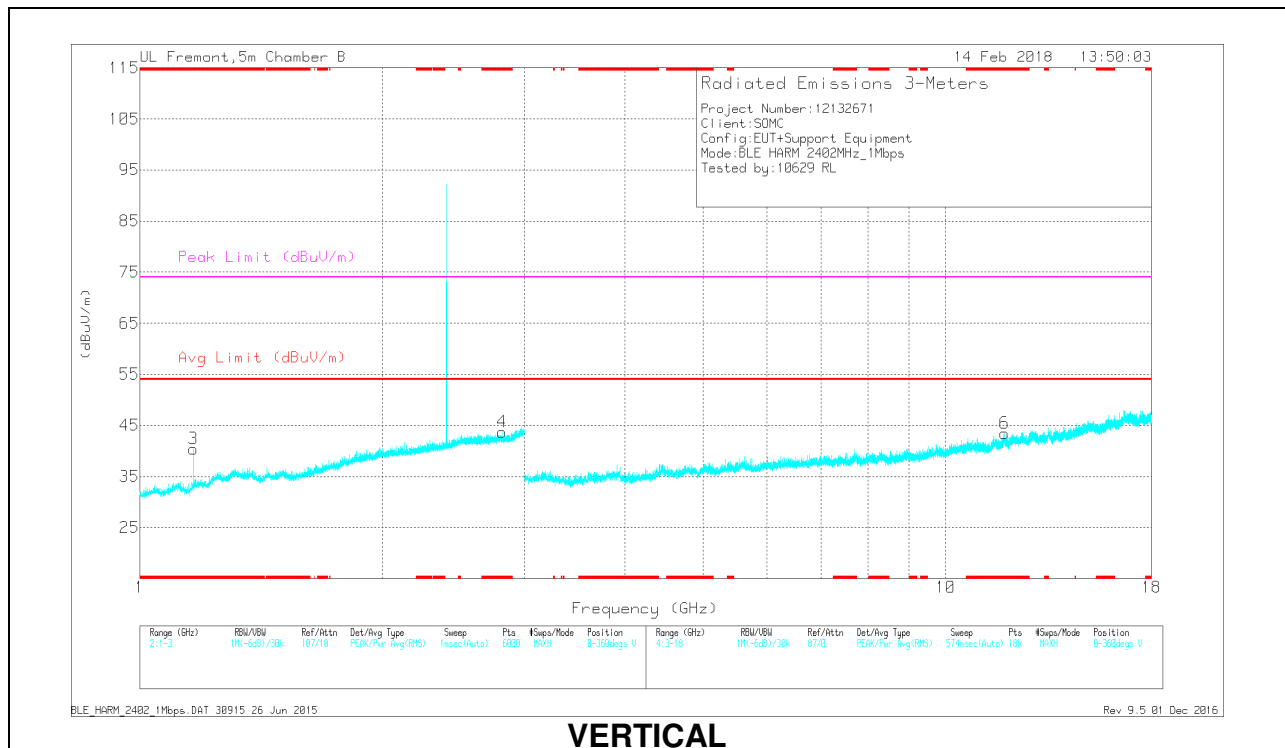

VERTICAL

RADIATED EMISSIONS

Frequency (GHz)	Meter Reading (dBuV)	Det	AF T346 (dB/m)	Amp/Cbl/Filtr/P ad (dB)	DC Corr (dB)	Corrected Reading (dBuV/m)	Avg Limit (dBuV/m)	Margin (dB)	Peak Limit (dBuV/m)	PK Margin (dB)	Azimuth (Degs)	Height (cm)	Polarity
* 1.012	34.21	PK2	27.4	-23.6	0	38.01	-	-	74	-35.99	115	341	H
* 1.02	22.96	MAv1	27.3	-23.6	.7	27.36	54	-26.64	-	-	115	341	H
* 2.814	36.7	PK2	32.4	-20.6	0	48.5	-	-	74	-25.5	240	110	H
* 2.807	24.62	MAv1	32.4	-20.6	.7	37.12	54	-16.88	-	-	240	110	H
* 1.164	35.01	PK2	27.6	-22.7	0	39.91	-	-	74	-34.09	214	180	V
* 1.167	23.22	MAv1	27.6	-22.6	.7	28.92	54	-25.08	-	-	214	180	V
* 2.815	36.15	PK2	32.4	-20.6	0	47.95	-	-	74	-26.05	254	374	V
* 2.815	24.61	MAv1	32.4	-20.6	.7	37.11	54	-16.89	-	-	254	374	V
* 10.803	34.23	PK2	37.7	-24	0	47.93	-	-	74	-26.07	326	340	H
* 10.803	22.83	MAv1	37.7	-24	.7	37.23	54	-16.77	-	-	326	340	H
* 11.825	34.29	PK2	38.6	-23.2	0	49.69	-	-	74	-24.31	244	233	V
* 11.826	22.16	MAv1	38.6	-23.2	.7	38.26	54	-15.74	-	-	244	233	V

* - indicates frequency in CFR47 Pt 15 - Restricted Band
 PK2 - KDB58074 Method: Maximum Peak
 MAv1 - KDB58074 Option 1 Maximum RMS Average

MID CHANNEL RESULTS

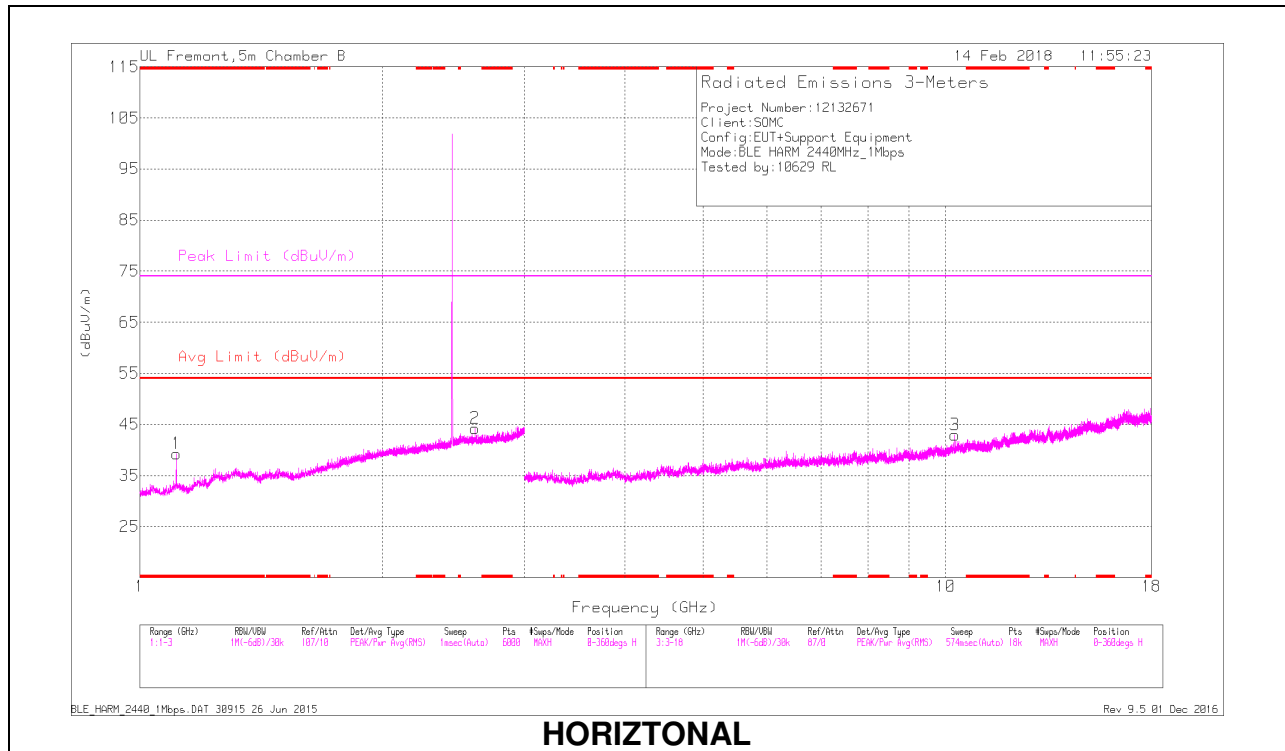

HORIZONTAL

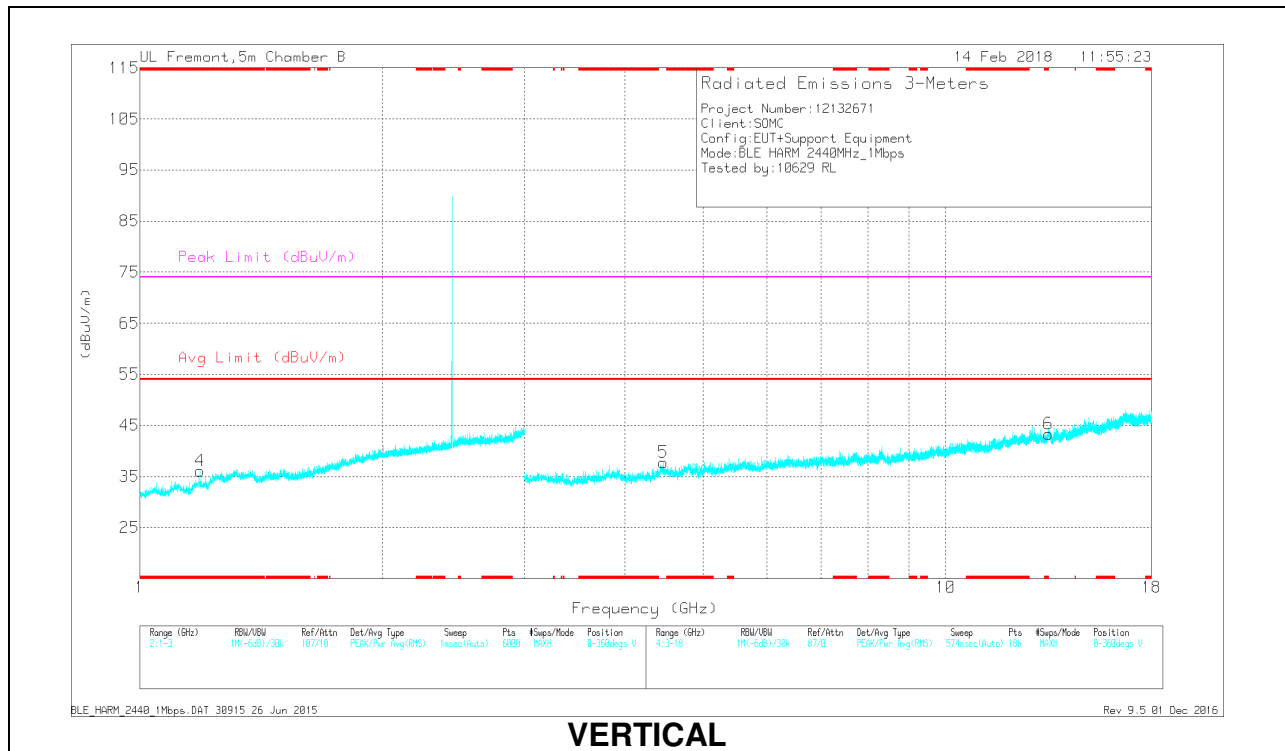

VERTICAL

RADIATED EMISSIONS

Frequency (GHz)	Meter Reading (dBuV)	Det	AF T346 (dBm)	Amp/Cbl/Filtr/Pad (dB)	DC Corr (dB)	Corrected Reading (dBuV/m)	Avg Limit (dBuV/m)	Margin (dB)	Peak Limit (dBuV/m)	PK Margin (dB)	Azimuth (Degs)	Height (cm)	Polarity
* 1.109	35.44	PK2	27.6	-22.9	0	40.14	-	-	74	-33.86	168	281	H
* 1.11	23.34	MAv1	27.6	-22.9	.7	28.74	54	-25.26	-	-	168	281	H
* 1.186	36.12	PK2	27.8	-22.7	0	41.22	-	-	74	-32.78	156	348	V
* 1.186	23.51	MAv1	27.8	-22.7	.7	29.31	54	-24.69	-	-	156	348	V
2.6	36.56	PK2	32.6	-21.1	0	48.06	-	-	-	-	35	358	H
2.6	24.64	MAv1	32.6	-21.1	.7	36.84	-	-	-	-	35	358	H
4.459	27.17	MAv1	33.8	-29.4	.7	32.27	-	-	-	-	333	255	V
4.461	39.29	PK2	33.8	-29.4	0	43.69	-	-	-	-	333	255	V
10.263	23.23	MAv1	37.4	-25.3	.7	36.03	-	-	-	-	251	273	H
10.266	35.24	PK2	37.4	-25.3	0	47.34	-	-	-	-	251	273	H
13.404	22.55	MAv1	39.3	-22.8	.7	39.75	-	-	-	-	60	172	V
13.406	34.94	PK2	39.3	-22.8	0	51.44	-	-	-	-	60	172	V

* - indicates frequency in CFR47 Pt 15 / IC RSS-Restricted Band

PK2 - KDB558074 Method: Maximum Peak

MAv1 - KDB558074 Option 1 Maximum RMS Average

HIGH CHANNEL RESULTS

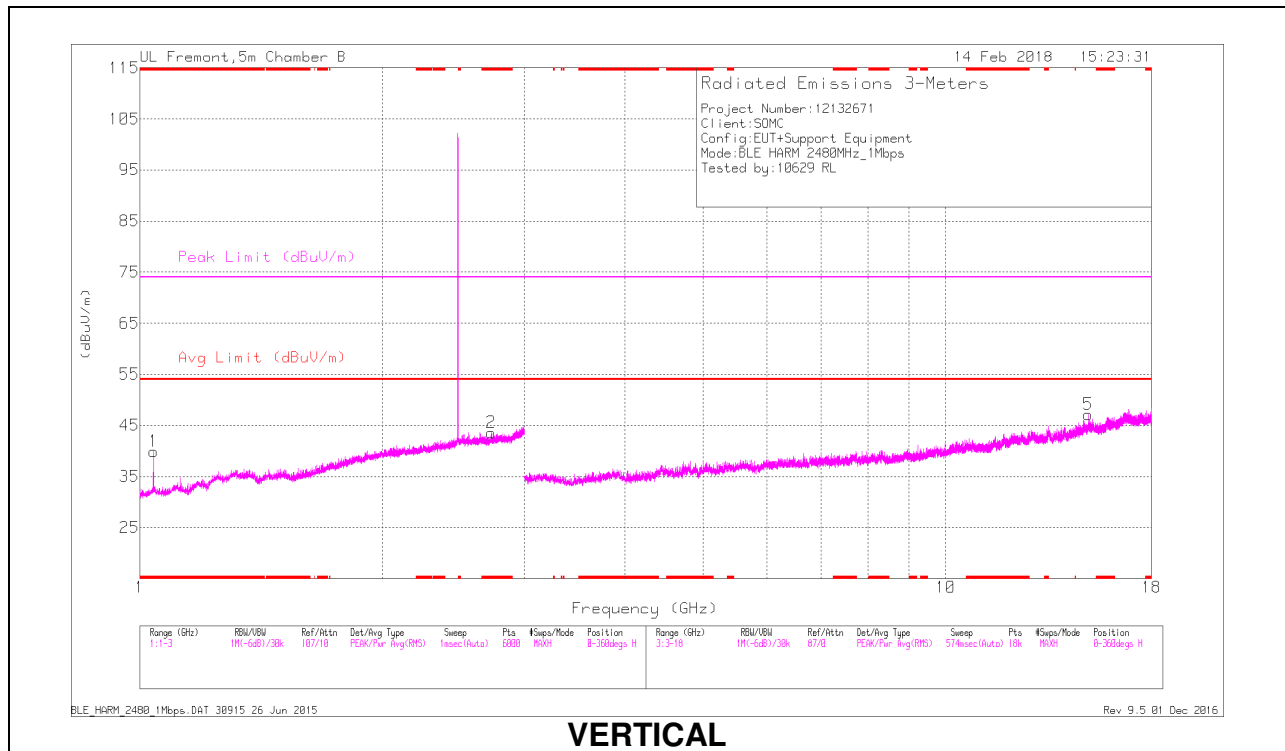
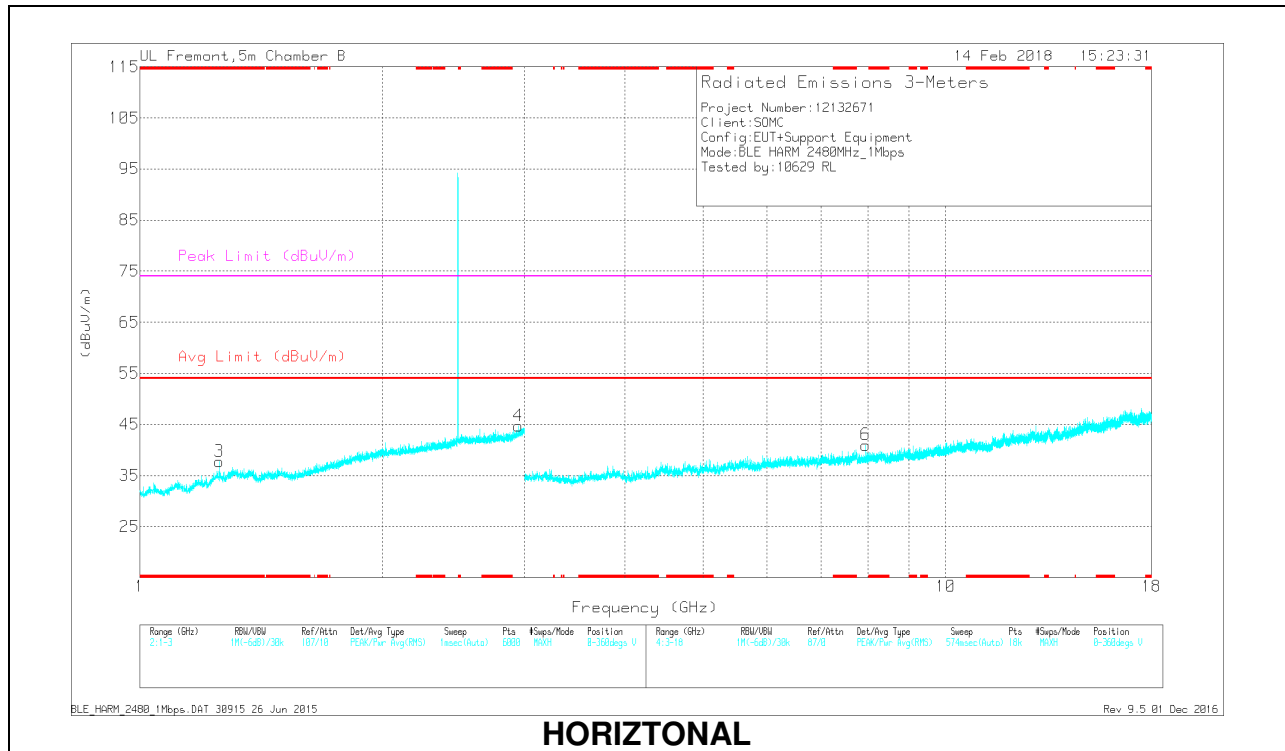

RADIATED EMISSIONS

Frequency (GHz)	Meter Reading (dBuV)	Det	AF T346 (dB/m)	Amp/Cbl/Filtr/ Pad (dB)	DC Corr (dB)	Corrected Reading (dBuV/m)	Avg Limit (dBuV/m)	Margin (dB)	Peak Limit (dBuV/m)	PK Margin (dB)	Azimuth (Degs)	Height (cm)	Polarity
* 1.038	36.23	PK2	27.1	-23.3	0	40.03	-	-	74	-33.97	0	387	H
* 1.038	23.57	MAv1	27.1	-23.3	.7	28.07	54	-25.93	-	-	0	387	H
* 2.729	36.8	PK2	32.4	-20.8	0	48.4	-	-	74	-25.6	121	239	H
* 2.728	24.73	MAv1	32.4	-20.8	.7	37.03	54	-16.97	-	-	121	239	H
* 1.254	35.48	PK2	28.8	-22.2	0	42.08	-	-	74	-31.92	157	190	V
* 1.252	23.09	MAv1	28.8	-22.1	.7	30.49	54	-23.51	-	-	157	190	V
2.949	24.55	MAv1	32.6	-20	.7	37.85	-	-	-	-	0	310	V
2.952	36.41	PK2	32.6	-20	0	49.01	-	-	-	-	0	310	V
7.946	25.54	MAv1	36	-27.9	.7	34.34	-	-	-	-	334	139	V
7.948	36.72	PK2	36	-27.9	0	44.82	-	-	-	-	334	139	V
15.024	21.92	MAv1	40.6	-22.4	.7	40.82	-	-	-	-	235	371	H
15.025	33.93	PK2	40.6	-22.3	0	52.23	-	-	-	-	235	371	H

* - indicates frequency in CFR47 Pt 15 - Restricted Band

PK2 - KDB558074 Method: Maximum Peak

MAv1 - KDB558074 Option 1 Maximum RMS Average

9.2.2. BLE (2Mbps)

BANDEDGE (LOW CHANNEL)

HORIZONTAL RESULT

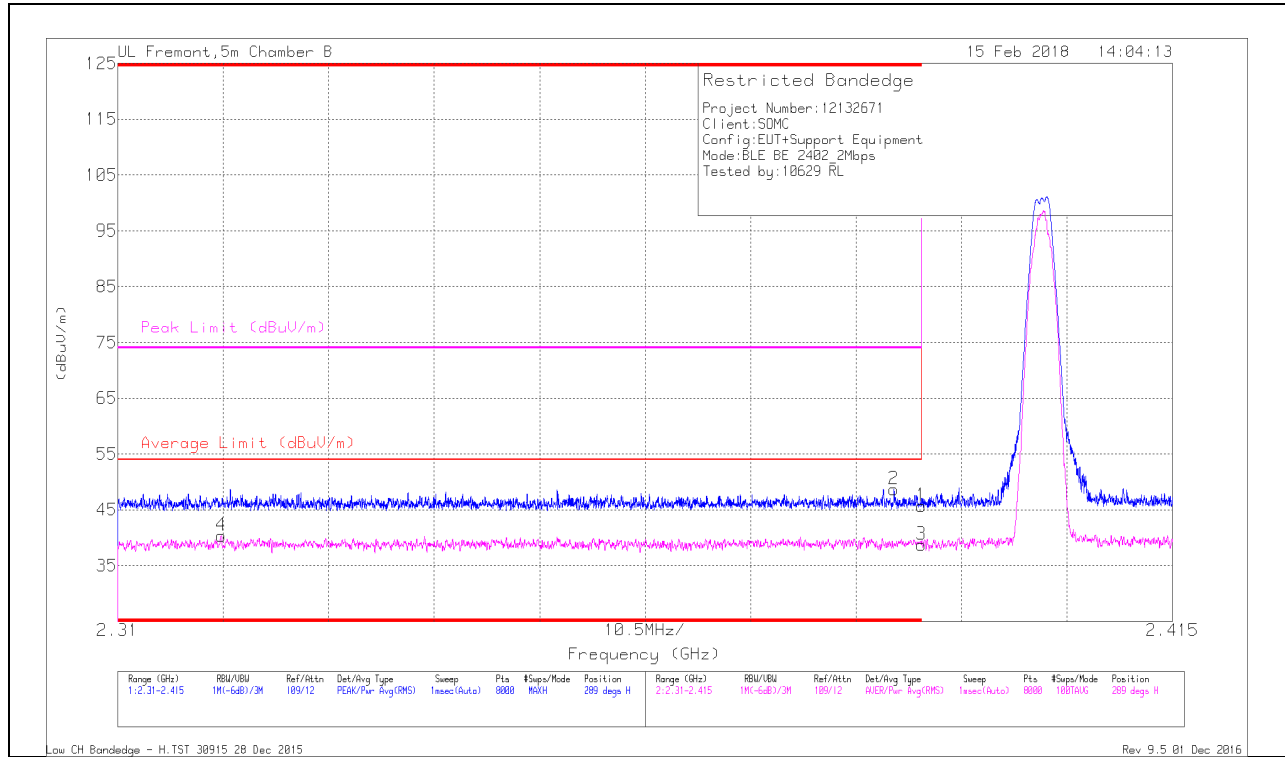

Marker	Frequency (GHz)	Meter Reading (dBuV)	Det	AF T346 (dBm)	Amp/CB/Filt/Pad (dB)	DC Corr (dB)	Corrected Reading (dBuV/m)	Average Limit (dBuV/m)	Margin (dB)	Peak Limit (dBuV/m)	PK Margin (dB)	Azimuth (Degs)	Height (cm)	Polarity
1	* 2.39	35.05	Pk	32	-21.3	0	45.75	-	-	74	-28.25	289	142	H
2	* 2.387	38.03	Pk	32	-21.3	0	48.73	-	-	74	-25.27	289	142	H
3	* 2.39	25.66	RMS	32	-21.3	2.41	38.77	54	-15.23	-	-	289	142	H
4	* 2.32	27.27	RMS	31.9	-21.2	2.41	40.38	54	-13.62	-	-	289	142	H

* - indicates frequency in CFR47 Pt 15 - Restricted Band

Pk - Peak detector

RMS - RMS detection

VERTICAL RESULT

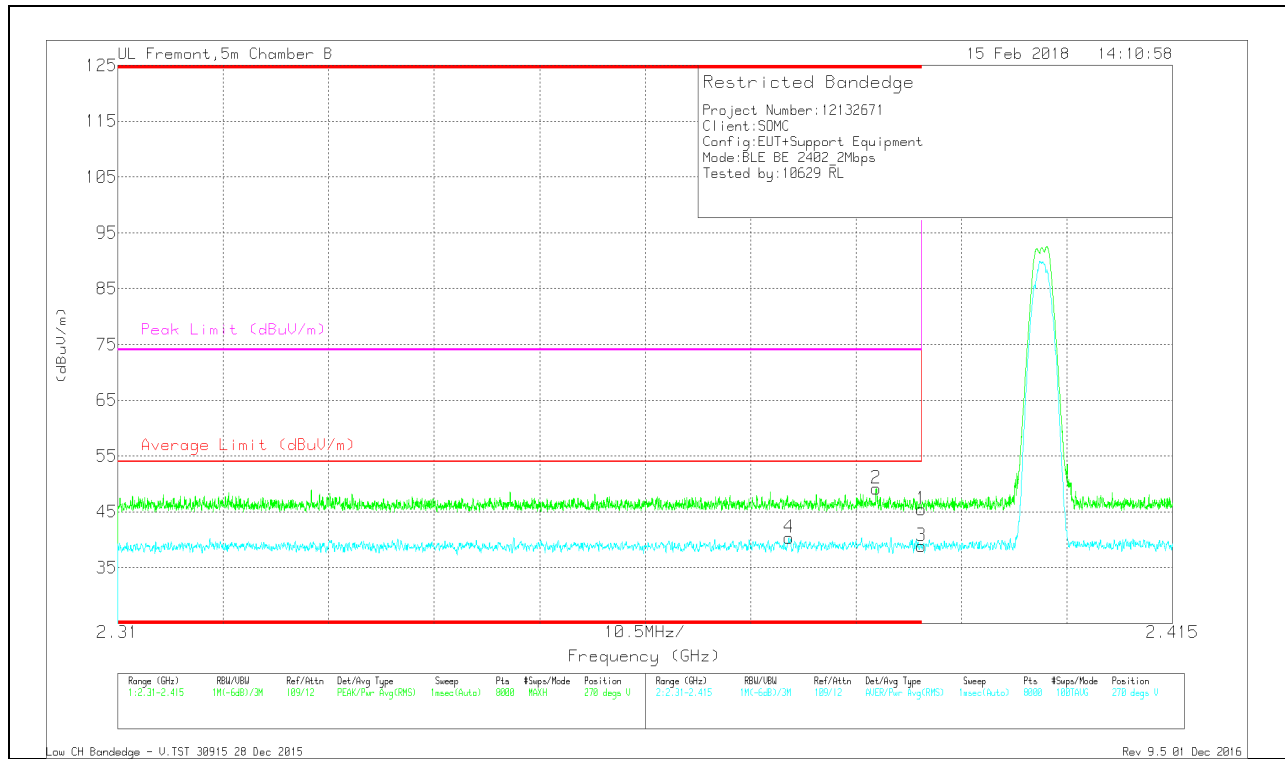

Marker	Frequency (GHz)	Meter Reading (dBuV)	Det	AF T346 (dBm)	Amp/Cbl/Filtr/Pad (dB)	DC Corr (dB)	Corrected Reading (dBuV/m)	Average Limit (dBuV/m)	Margin (dB)	Peak Limit (dBuV/m)	PK Margin (dB)	Azimuth (Degs)	Height (cm)	Polarity
4	* 2.377	27.35	RMS	31.9	-21.3	2.41	40.36	54	-13.64	-	-	270	282	V
2	* 2.385	38.48	Pk	32	-21.3	0	49.18	-	-	74	-24.82	270	282	V
1	* 2.39	34.78	Pk	32	-21.3	0	45.48	-	-	74	-28.52	270	282	V
3	* 2.39	25.72	RMS	32	-21.3	2.41	38.83	54	-15.17	-	-	270	282	V

* - indicates frequency in CFR47 Pt 15 - Restricted Band
 Pk - Peak detector
 RMS - RMS detection

BANDEDGE (HIGH CHANNEL)

HORIZONTAL RESULT

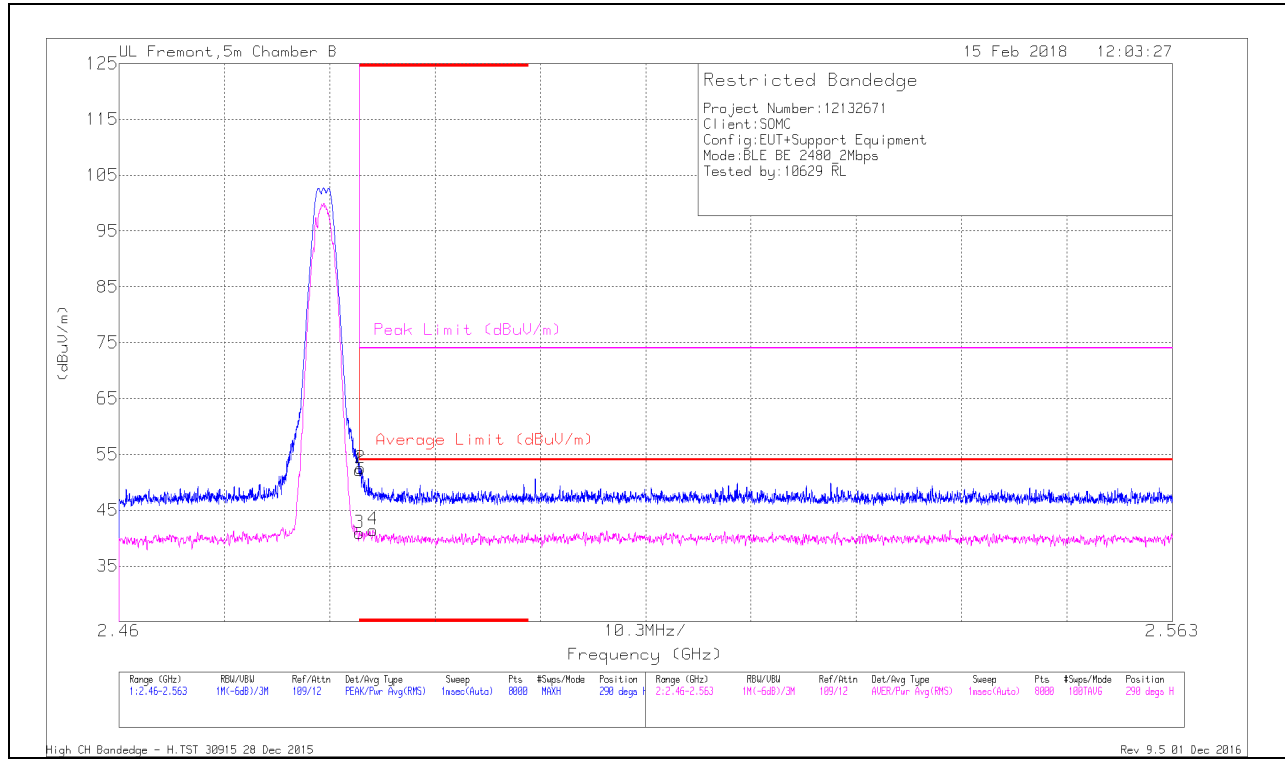

Marker	Frequency (GHz)	Meter Reading (dBuV)	Det	AF T346 (dBm)	Amp/Cbl/Fitr/Pad (dB)	DC Corr (dB)	Corrected Reading (dBuV/m)	Average Limit (dBuV/m)	Margin (dB)	Peak Limit (dBuV/m)	PK Margin (dB)	Azimuth (Degs)	Height (cm)	Polarity
1	* 2.484	40.95	Pk	32.5	-21.3	0	52.15	-	-	74	-21.85	290	136	H
2	* 2.484	41.33	Pk	32.5	-21.3	0	52.53	-	-	74	-21.47	290	136	H
3	* 2.484	27.31	RMS	32.5	-21.3	2.41	40.92	54	-13.08	-	-	290	136	H
4	* 2.485	27.86	RMS	32.5	-21.3	2.41	41.47	54	-12.53	-	-	290	136	H

* - indicates frequency in CFR47 Pt 15 - Restricted Band
 Pk - Peak detector
 RMS - RMS detection

VERTICAL RESULT

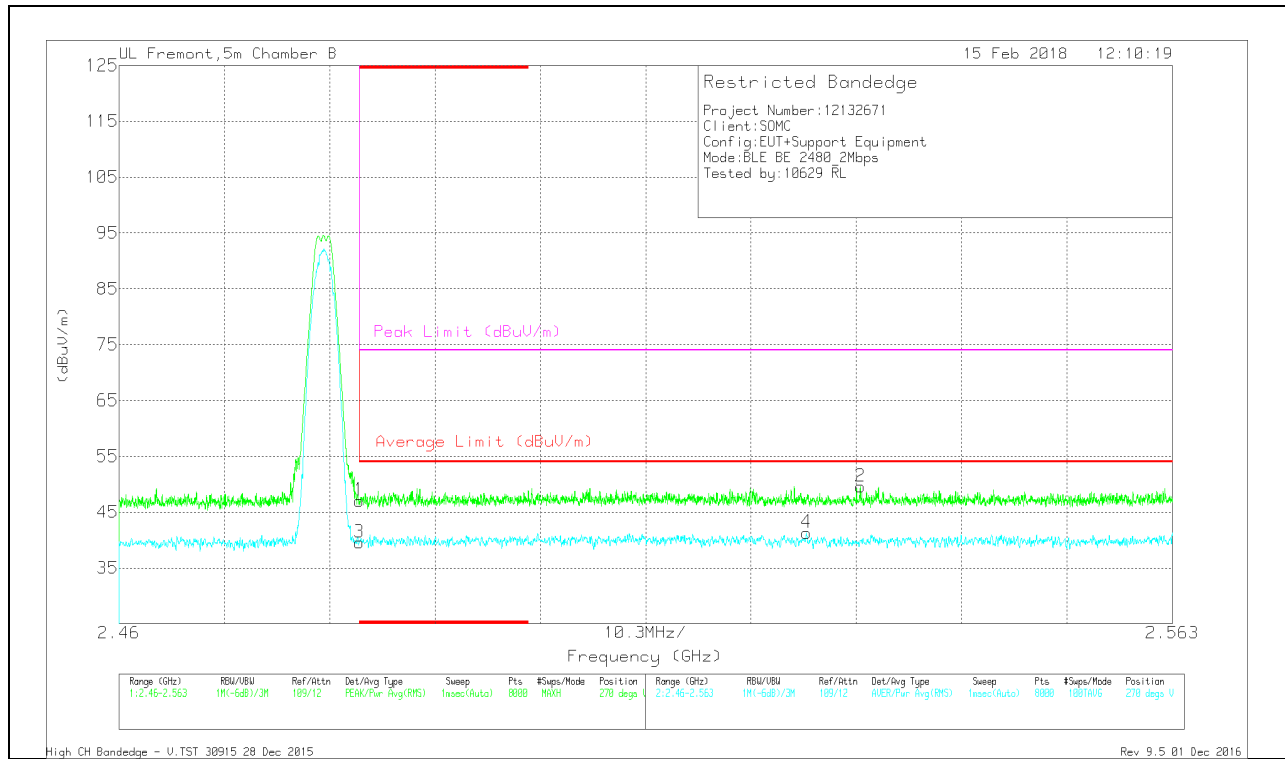

Marker	Frequency (GHz)	Meter Reading (dBuV)	Det	AF T346 (dB/m)	Amp/Cbl/Filtr/Pad (dB)	DC Corr (dB)	Corrected Reading (dBuV/m)	Average Limit (dBuV/m)	Margin (dB)	Peak Limit (dBuV/m)	PK Margin (dB)	Azimuth (Degs)	Height (cm)	Polarity
1	* 2.484	35.88	Pk	32.5	-21.3	0	47.08	-	-	74	-26.92	270	236	V
3	* 2.484	25.96	RMS	32.5	-21.3	2.41	39.57	54	-14.43	-	-	270	236	V
4	2.527	27.6	RMS	32.5	-21.2	2.41	41.31	54	-12.69	-	-	270	236	V
2	2.532	38.39	Pk	32.5	-21.3	0	49.59	-	-	74	-24.41	270	236	V

* - indicates frequency in CFR47 Pt 15 - Restricted Band
 Pk - Peak detector
 RMS - RMS detection

HARMONICS AND SPURIOUS EMISSIONS

LOW CHANNEL RESULTS

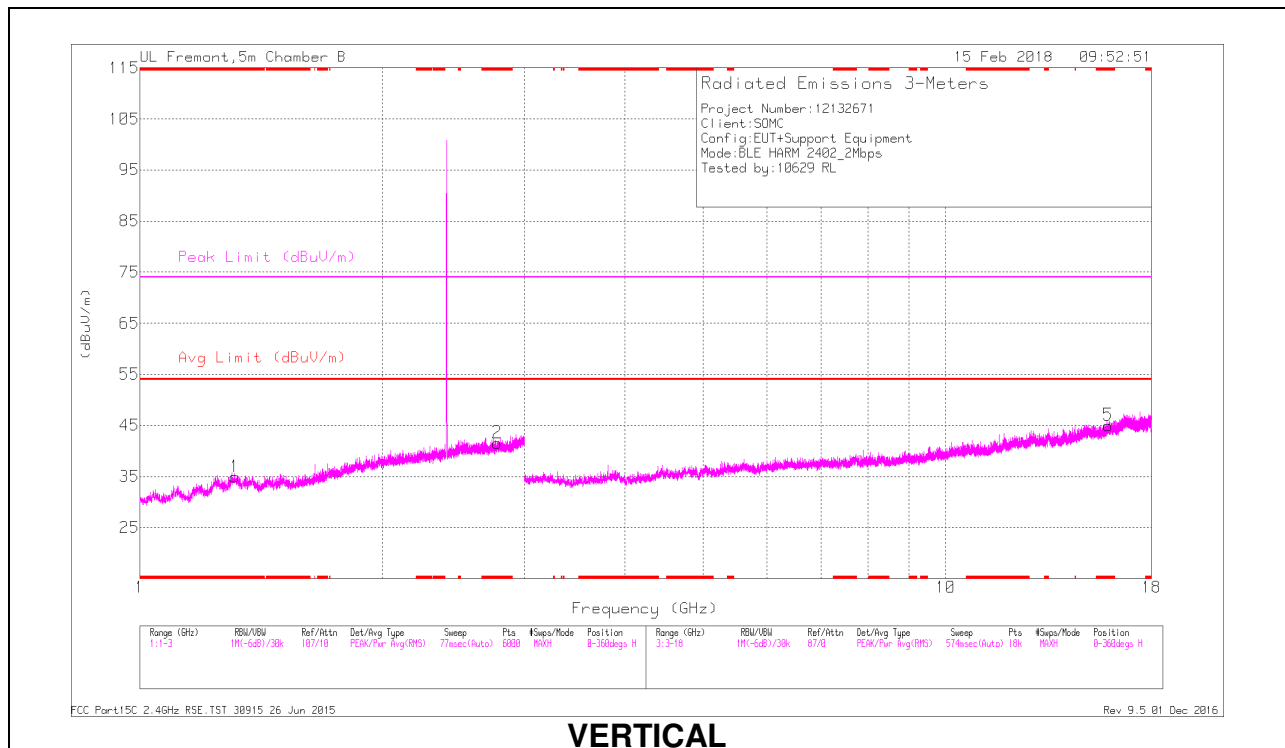
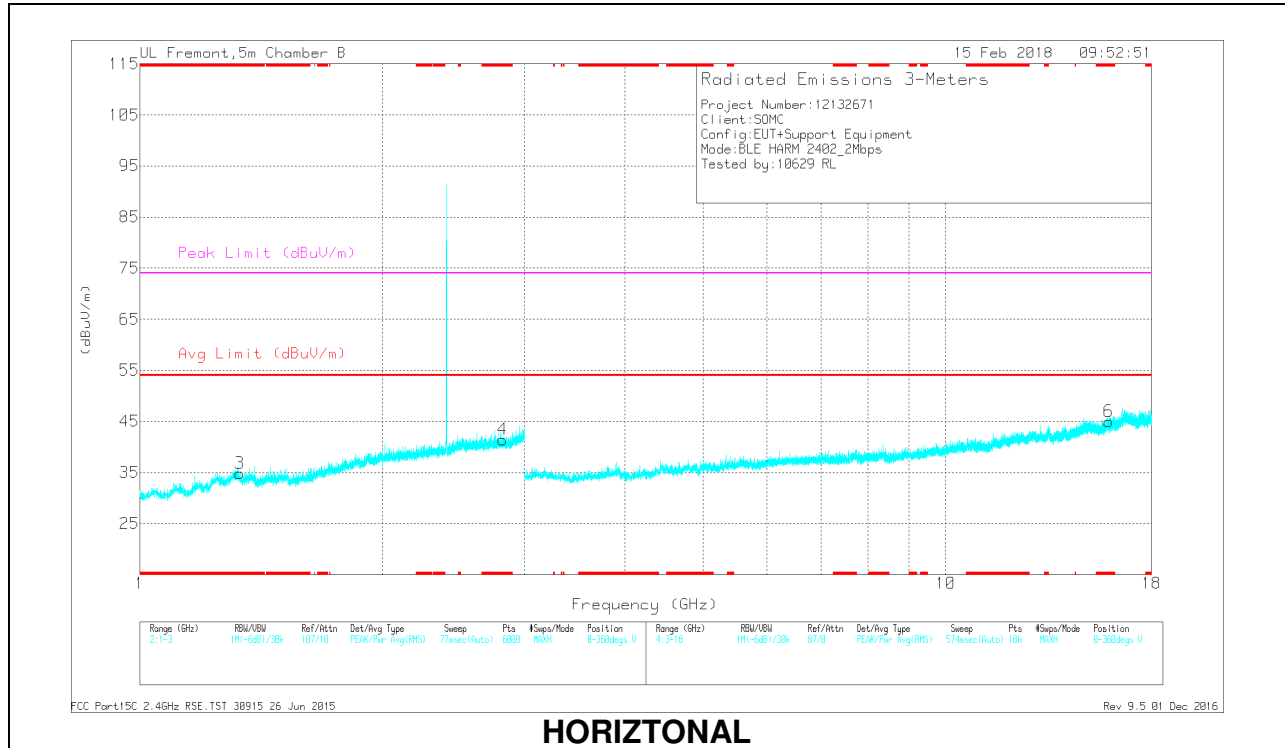

RADIATED EMISSIONS

Frequency (GHz)	Meter Reading (dBuV)	Det	AF T346 (dB/m)	Amp/Cbl/Filtr/ Pad (dB)	DC Corr (dB)	Corrected Reading (dBuV/m)	Avg Limit (dBuV/m)	Margin (dB)	Peak Limit (dBuV/m)	PK Margin (dB)	Azimuth (Degs)	Height (cm)	Polarity
* 1.316	34.76	PK2	28.9	-21.8	0	41.86	-	-	74	-32.14	121	320	H
* 1.313	20.2	MAv1	28.9	-21.9	2.41	29.61	54	-24.39	-	-	121	320	H
* 2.779	35.39	PK2	32.3	-20.7	0	46.99	-	-	74	-27.01	197	191	H
* 2.776	17.54	MAv1	32.3	-20.7	2.41	31.55	54	-22.45	-	-	197	191	H
* 1.33	34.16	PK2	28.9	-21.9	0	41.16	-	-	74	-32.84	239	351	V
* 1.329	17.22	MAv1	28.9	-21.8	2.41	26.73	54	-27.27	-	-	239	351	V
* 2.82	34.91	PK2	32.4	-20.6	0	46.71	-	-	74	-27.29	179	318	V
* 2.819	17.45	MAv1	32.4	-20.6	2.41	31.66	54	-22.34	-	-	179	318	V
* 15.897	31.79	PK2	41	-21.3	0	51.49	-	-	74	-22.51	14	104	H
* 15.898	18.67	MAv1	41	-21.4	2.41	40.68	54	-13.32	-	-	14	104	H
* 15.928	31.74	PK2	41.1	-21.6	0	51.24	-	-	74	-22.76	16	320	V
* 15.927	19.08	MAv1	41.1	-21.6	2.41	40.99	54	-13.01	-	-	16	320	V

* - indicates frequency in CFR47 Pt 15 - Restricted Band

PK2 - KDB558074 Method: Maximum Peak

MAv1 - KDB558074 Option 1 Maximum RMS Average

MID CHANNEL RESULTS

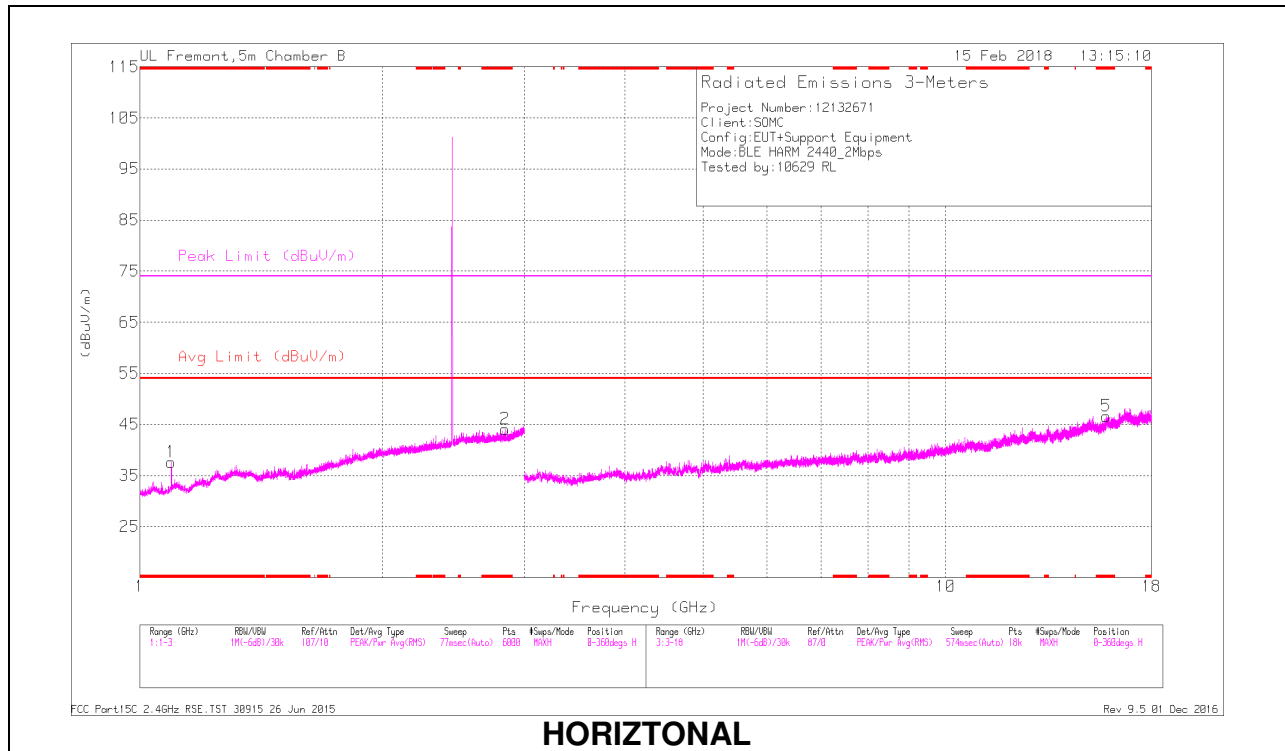

HORIZONTAL

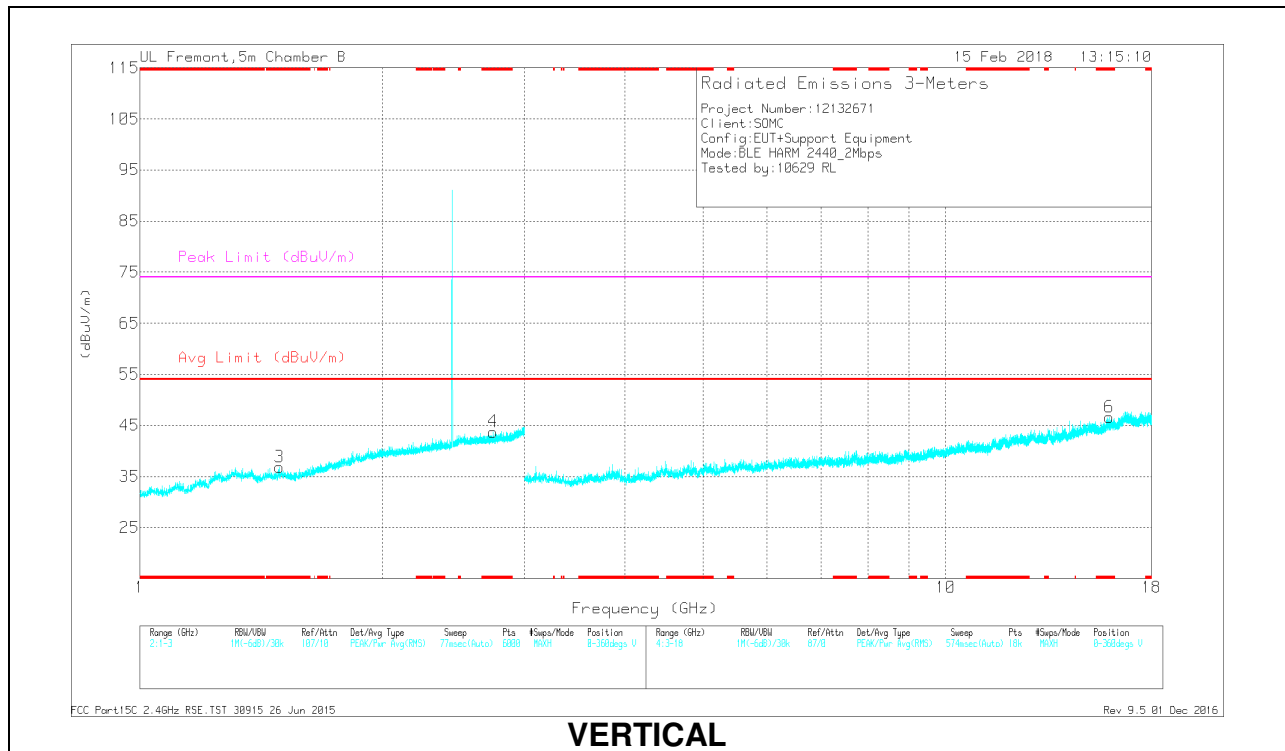

VERTICAL

RADIATED EMISSIONS

Frequency (GHz)	Meter Reading (dBuV)	Det	AF T346 (dB/m)	Amp/Cbl/Filtr/Pad (dB)	DC Corr (dB)	Corrected Reading (dBuV/m)	Avg Limit (dBuV/m)	Margin (dB)	Peak Limit (dBuV/m)	PK Margin (dB)	Azimuth (Degs)	Height (cm)	Polarity
* 1.092	35.28	PK2	27.6	-23	0	39.88	-	-	74	-34.12	85	257	H
* 1.096	23.07	MAv1	27.6	-23	2.41	30.08	54	-23.92	-	-	85	257	H
* 2.841	36.43	PK2	32.4	-20.5	0	48.33	-	-	74	-25.67	315	373	H
* 2.84	24.41	MAv1	32.4	-20.5	2.41	38.72	54	-15.28	-	-	315	373	H
* 1.489	35.86	PK2	28.2	-21.3	0	42.76	-	-	74	-31.24	30	175	V
* 1.491	23.18	MAv1	28.2	-21.3	2.41	32.49	54	-21.51	-	-	30	175	V
* 2.744	36.4	PK2	32.3	-20.8	0	47.9	-	-	74	-26.1	10	216	V
* 2.745	24.64	MAv1	32.3	-20.7	2.41	38.65	54	-15.35	-	-	10	216	V
* 15.812	32.34	PK2	40.9	-21.9	0	51.34	-	-	74	-22.66	123	377	H
* 15.811	21.75	MAv1	40.9	-21.9	2.41	43.16	54	-10.84	-	-	123	377	H
* 15.964	32.83	PK2	41.1	-21.9	0	52.03	-	-	74	-21.97	88	161	V
* 15.962	22.3	MAv1	41.1	-21.9	2.41	43.91	54	-10.09	-	-	88	161	V

* - indicates frequency in CFR47 Pt 15 - Restricted Band
 PK2 - KDB558074 Method: Maximum Peak
 MAv1 - KDB558074 Option 1 Maximum RMS Average

HIGH CHANNEL RESULTS

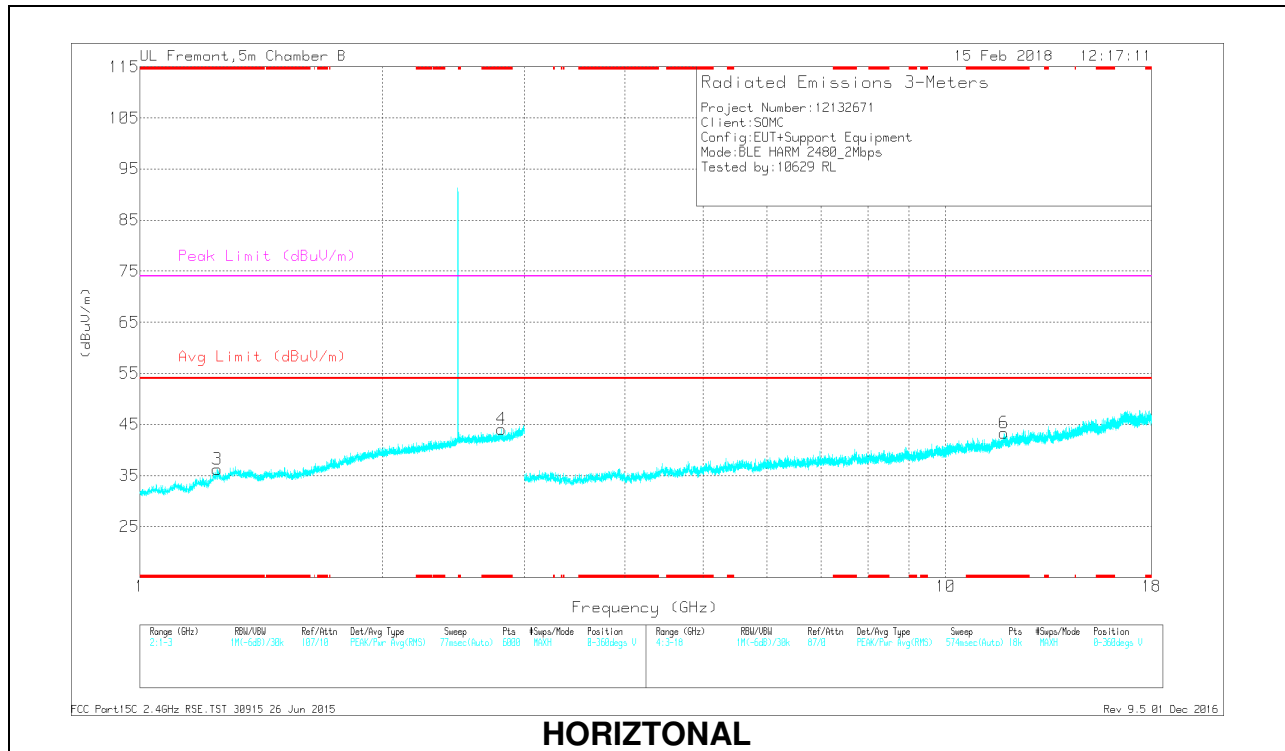

HORIZONTAL

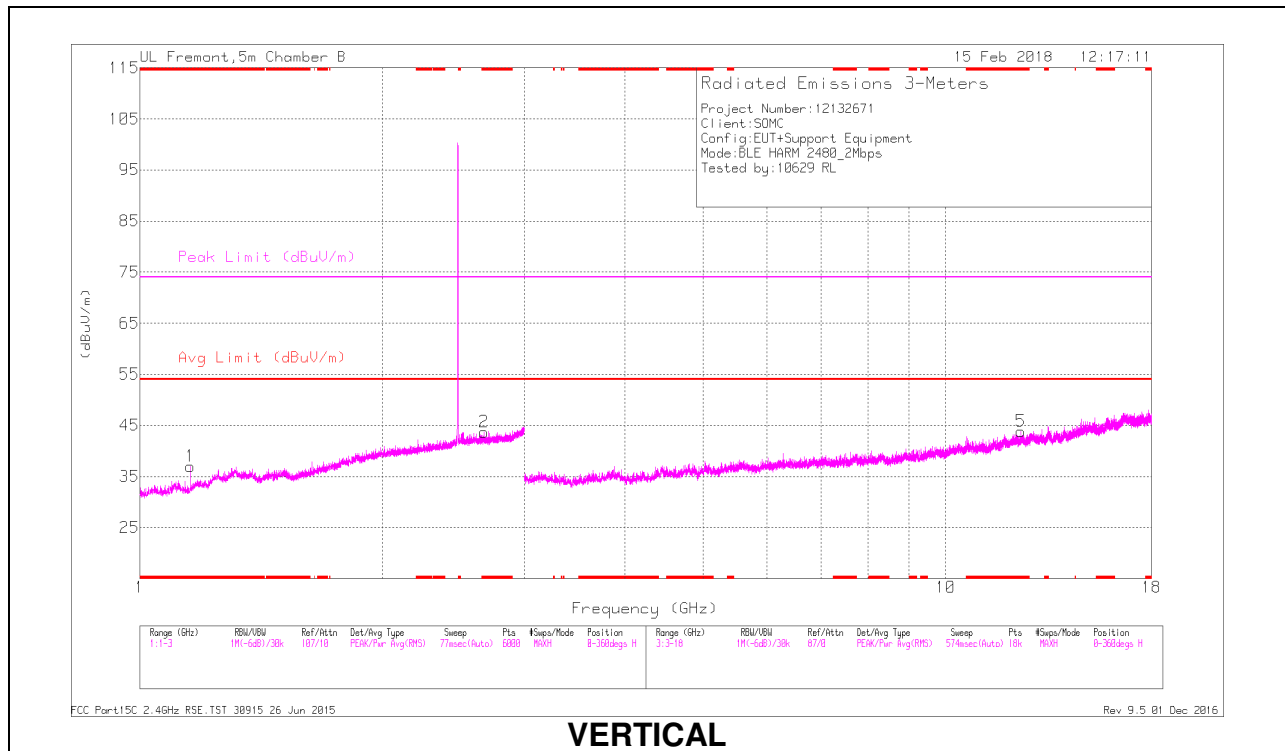

VERTICAL

RADIATED EMISSIONS

Frequency (GHz)	Meter Reading (dBuV)	Det	AF T346 (dB/m)	Amp/Cbl/Filtr/ Pad (dB)	DC Corr (dB)	Corrected Reading (dBuV/m)	Avg Limit (dBuV/m)	Margin (dB)	Peak Limit (dBuV/m)	PK Margin (dB)	Azimuth (Degs)	Height (cm)	Polarity
* 1.155	34.59	PK2	27.5	-22.8	0	39.29	-	-	74	-34.71	256	286	H
* 1.159	22.84	MAv1	27.6	-22.7	2.41	30.15	54	-23.85	-	-	256	286	H
* 2.674	36.85	PK2	32.4	-21.2	0	48.05	-	-	74	-25.95	51	334	H
* 2.676	24.71	MAv1	32.4	-21.1	2.41	38.42	54	-15.58	-	-	51	334	H
* 1.248	34.89	PK2	28.8	-22.2	0	41.49	-	-	74	-32.51	79	192	V
* 1.246	23.39	MAv1	28.7	-22.2	2.41	32.3	54	-21.7	-	-	79	192	V
* 2.811	37	PK2	32.4	-20.6	0	48.8	-	-	74	-25.2	238	182	V
* 2.809	24.63	MAv1	32.4	-20.6	2.41	38.84	54	-15.16	-	-	238	182	V
* 12.395	34.33	PK2	39	-23.9	0	49.43	-	-	74	-24.57	0	178	H
* 12.393	22.64	MAv1	39	-23.9	2.41	40.15	54	-13.85	-	-	0	178	H
* 11.816	33.94	PK2	38.6	-23.2	0	49.34	-	-	74	-24.66	17	118	V
* 11.814	22.12	MAv1	38.6	-23.2	2.41	39.93	54	-14.07	-	-	17	118	V

* - indicates frequency in CFR47 Pt 15 - Restricted Band
 PK2 - KDB558074 Method: Maximum Peak
 MAv1 - KDB558074 Option 1 Maximum RMS Average

9.3. SPURIOUS EMISSIONS BELOW 30 MHz (WORST-CASE CONFIGURATION)

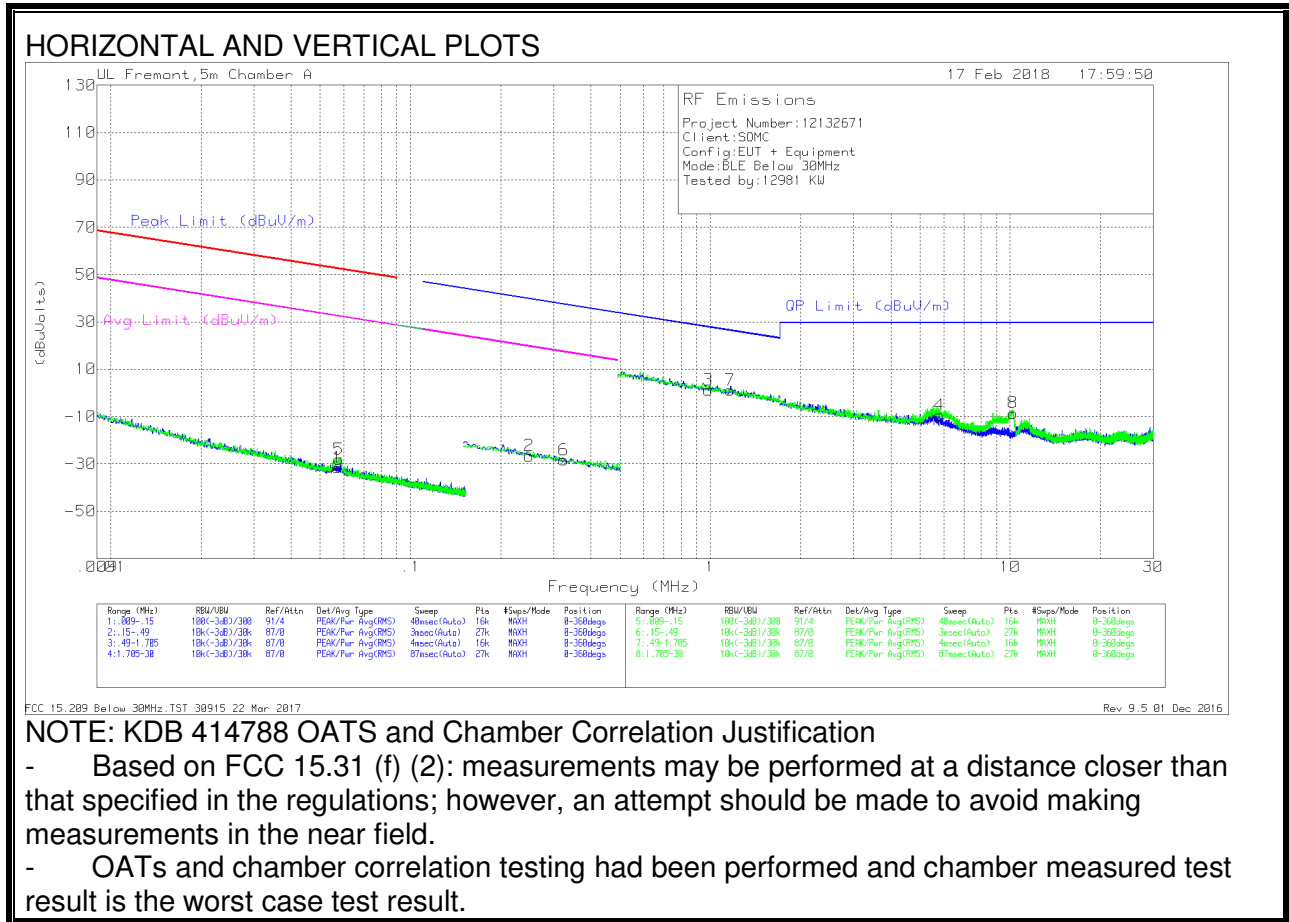

NOTE: KDB 414788 OATS and Chamber Correlation Justification

- Based on FCC 15.31 (f) (2): measurements may be performed at a distance closer than that specified in the regulations; however, an attempt should be made to avoid making measurements in the near field.
- OATs and chamber correlation testing had been performed and chamber measured test result is the worst case test result.

Trace Markers

Marker	Frequency (MHz)	Meter Reading (dBuV)	Det	Loop Antenna (dB/m)	Cbl (dB)	Dist Corr 300m	Corrected Reading (dBuVolts)	Peak Limit (dBuV/m)	Margin (dB)	Avg Limit (dBuV/m)	Margin (dB)	Azimuth (Degs)
1	.05706	36.48	Pk	11.8	.1	-80	-31.62	52.46	-84.08	32.46	-64.08	0-360
5	.05771	40.1	Pk	11.8	.1	-80	-28	52.36	-80.36	32.36	-60.36	0-360
2	.24874	42.31	Pk	11	.1	-80	-26.59	39.7	-66.29	19.7	-46.29	0-360
6	.32449	40.58	Pk	10.9	.1	-80	-28.42	37.39	-65.81	17.39	-45.81	0-360

Pk - Peak detector

Marker	Frequency (MHz)	Meter Reading (dBuV)	Det	Loop Antenna (dB/m)	Cbl (dB)	Dist Corr 30m	Corrected Reading (dBuVolts)	QP Limit (dBuV/m)	Margin (dB)	Azimuth (Degs)
3	.98389	29.58	Pk	11.3	.2	-40	1.08	27.76	-26.68	0-360
7	1.16496	29.63	Pk	11.3	.2	-40	1.13	26.3	-25.17	0-360
4	5.80582	19.07	Pk	11.1	.4	-40	-9.43	29.5	-38.93	0-360
8	10.22419	19.88	Pk	11.1	.5	-40	-8.52	29.5	-38.02	0-360

Pk - Peak detector

9.4. Worst Case Below 1 GHz

SPURIOUS EMISSIONS 30 TO 1000 MHz (WORST-CASE CONFIGURATION)

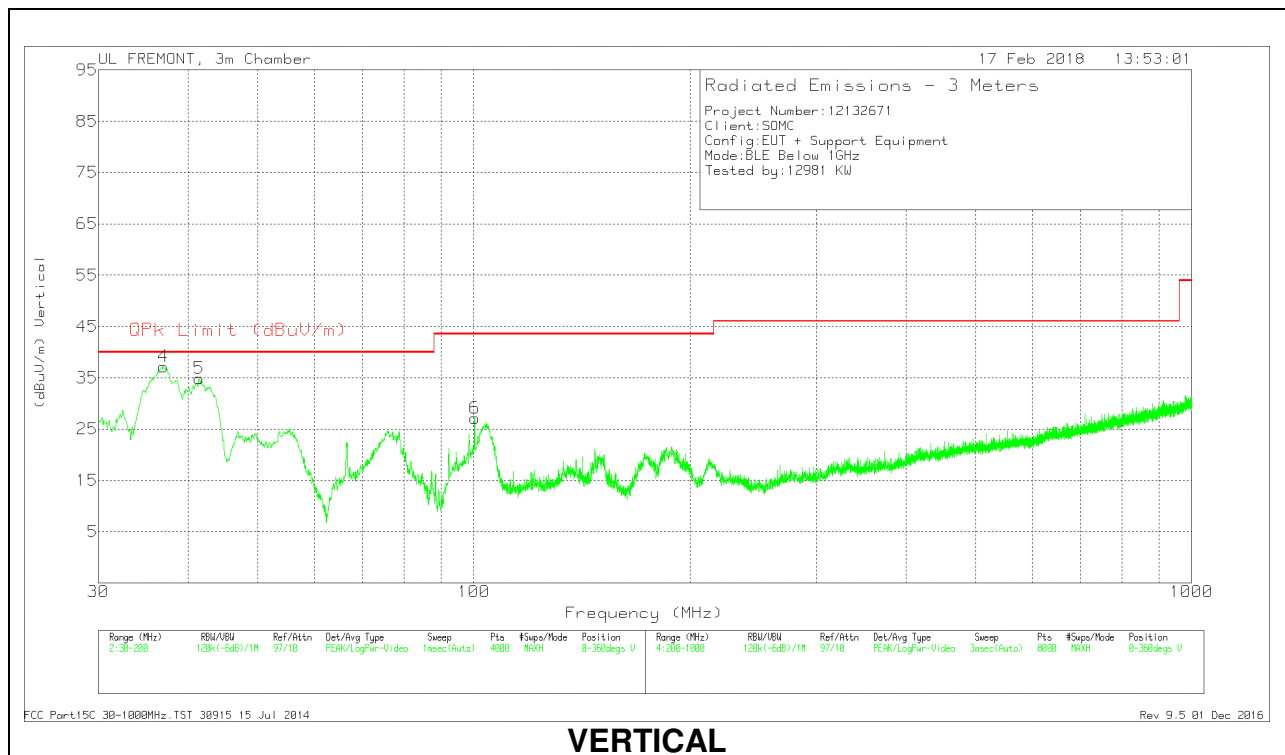
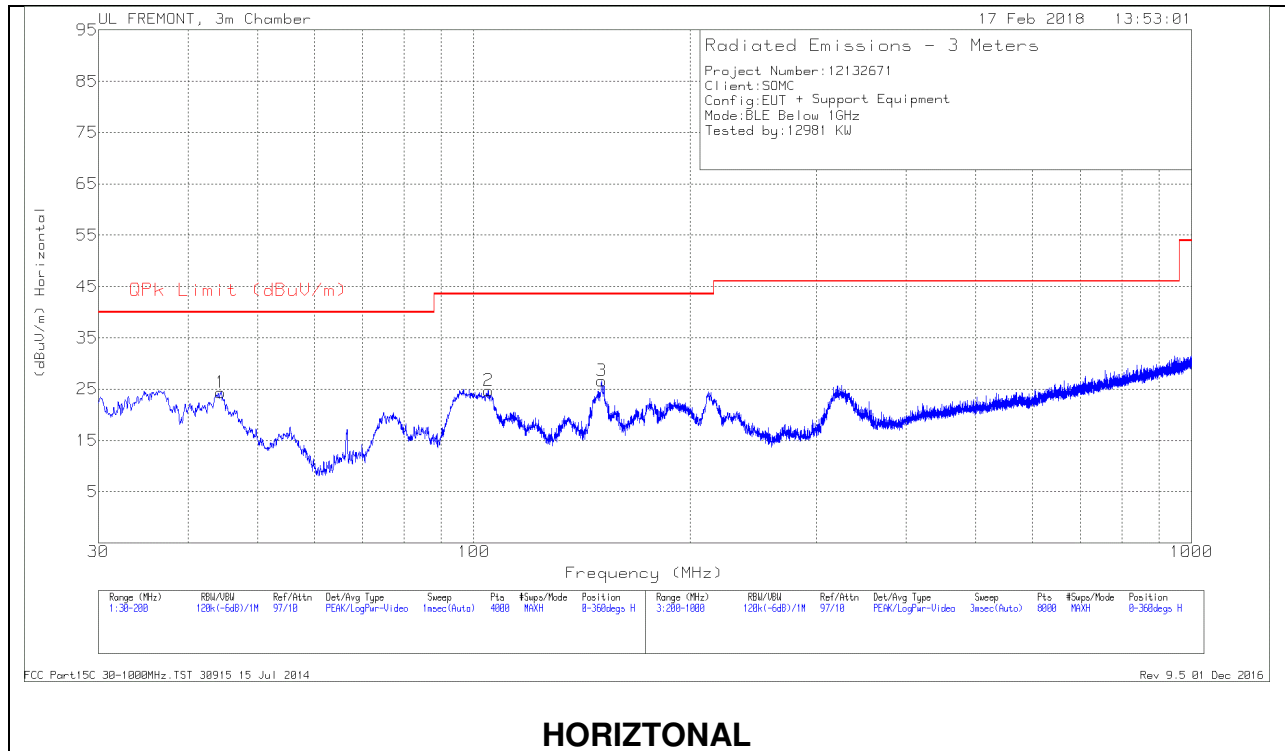

Below 1GHz Data

Marker	Frequency (MHz)	Meter Reading (dBuV)	Det	AF T243 (dB/m)	Amp/Cbl (dB/m)	Corrected Reading (dBuV/m)	QPk Limit (dBuV/m)	Margin (dB)	Azimuth (Degs)	Height (cm)	Polarity
4	36.9293	48.08	Pk	20.1	-31	37.18	40	-2.82	0-360	100	V
5	41.4355	48.86	Pk	16.9	-30.9	34.86	40	-5.14	0-360	100	V
1	44.4112	40.47	Pk	14.8	-30.9	24.37	40	-15.63	0-360	400	H
6	100.2707	43.02	Pk	14.4	-30.3	27.12	43.52	-16.4	0-360	100	V
2	104.8194	39.22	Pk	15.7	-30.2	24.72	43.52	-18.8	0-360	200	H
3	150.7312	39.86	Pk	16.5	-29.8	26.56	43.52	-16.96	0-360	200	H

9.5. Worst Case 18-26 GHz

SPURIOUS EMISSIONS 18-26 GHz (WORST-CASE CONFIGURATION)

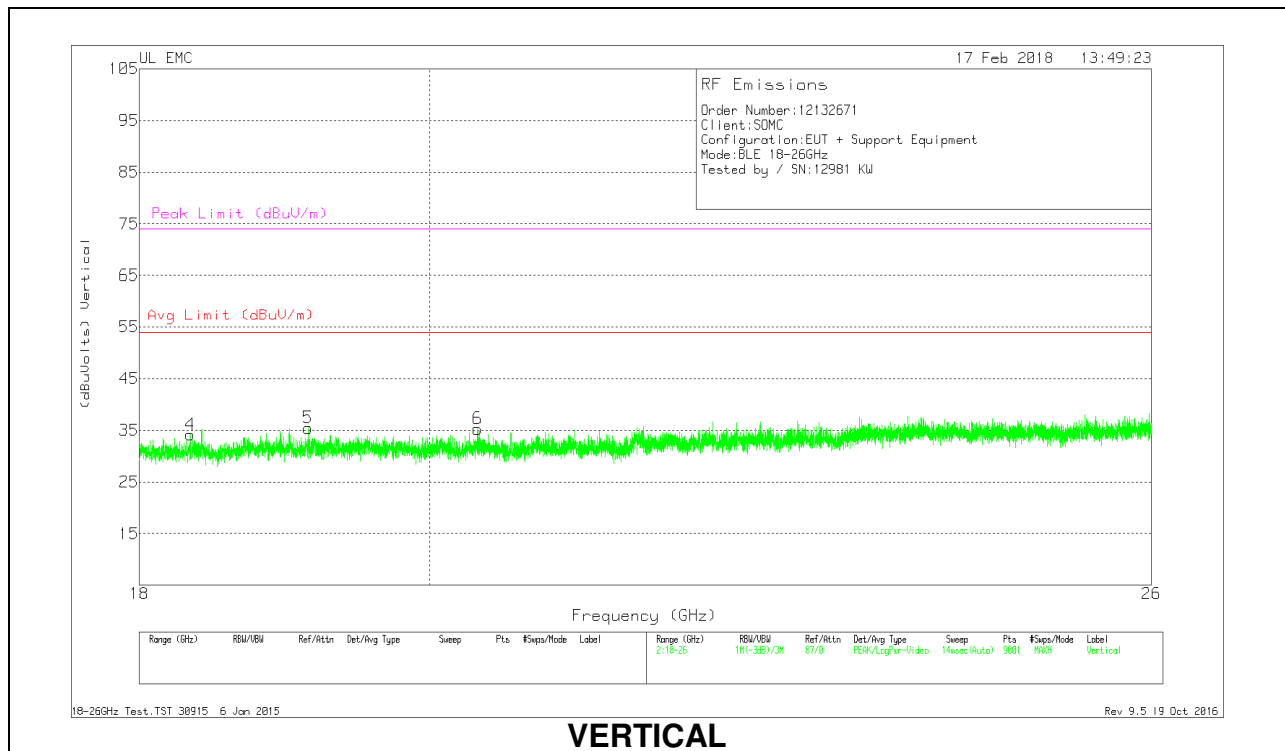
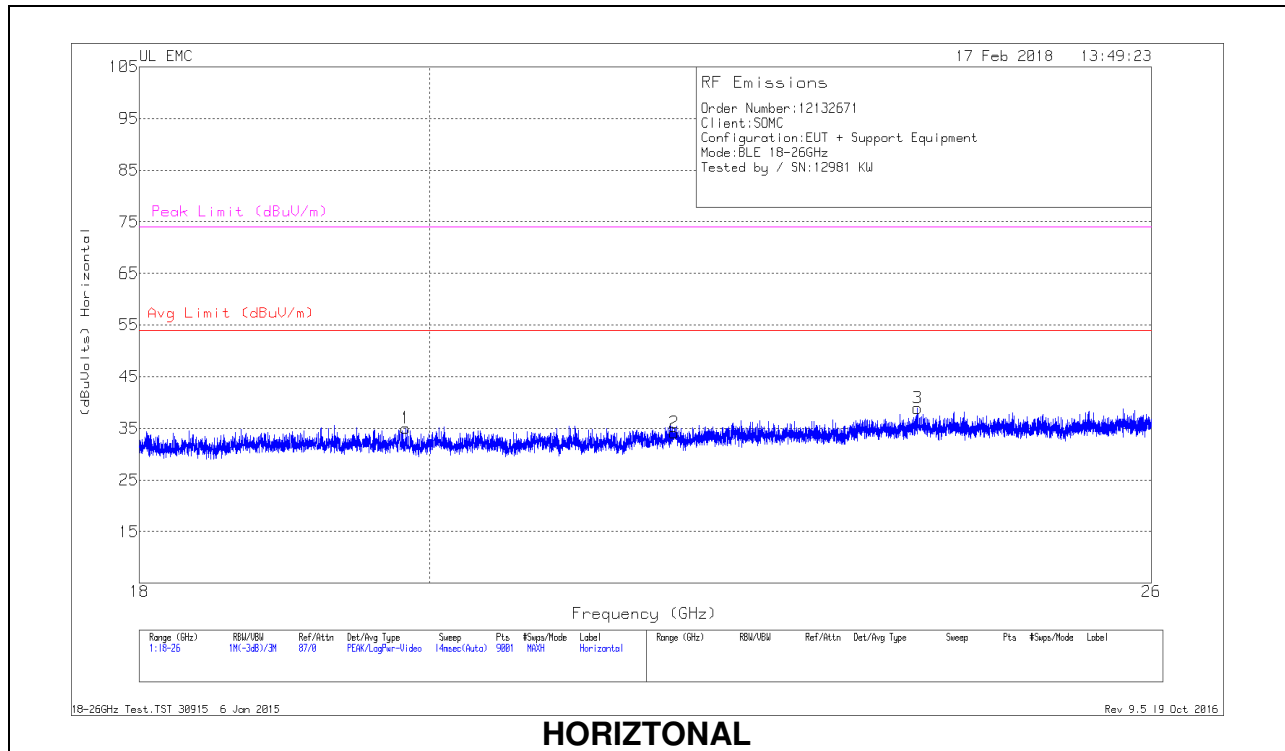

18 – 26GHz DATA

Marker	Frequency (GHz)	Meter Reading (dBuV)	Det	T449 AF (dB/m)	Amp/Cbl (dB)	Dist Corr (dB)	Corrected Reading (dBuVolts)	Avg Limit (dBuV/m)	Margin (dB)	Peak Limit (dBuV/m)	PK Margin (dB)
1	19.828	36.78	Pk	32.7	-25	-9.5	34.98	54	-19.02	74	-39.02
2	21.859	34.89	Pk	33.3	-24.6	-9.5	34.09	54	-19.91	74	-39.91
3	23.88	38.6	Pk	33.9	-24.1	-9.5	38.9	54	-15.1	74	-35.1
4	18.337	36.63	Pk	32.2	-25.2	-9.5	34.13	54	-19.87	74	-39.87
5	19.139	37.02	Pk	32.6	-24.7	-9.5	35.42	54	-18.58	74	-38.58
6	20.353	37.26	Pk	32.9	-25.4	-9.5	35.26	54	-18.74	74	-38.74

10. AC POWER LINE CONDUCTED EMISSIONS

LIMITS

FCC §15.207 (a)

RSS-Gen 8.8

Frequency of Emission (MHz)	Conducted Limit (dBuV)	
	Quasi-peak	Average
0.15-0.5	66 to 56 [*]	56 to 46 [*]
0.5-5	56	46
5-30	60	50

^{*} Decreases with the logarithm of the frequency.

RESULTS

10.1.1. AC Power Line Norm

LINE 1 RESULTS

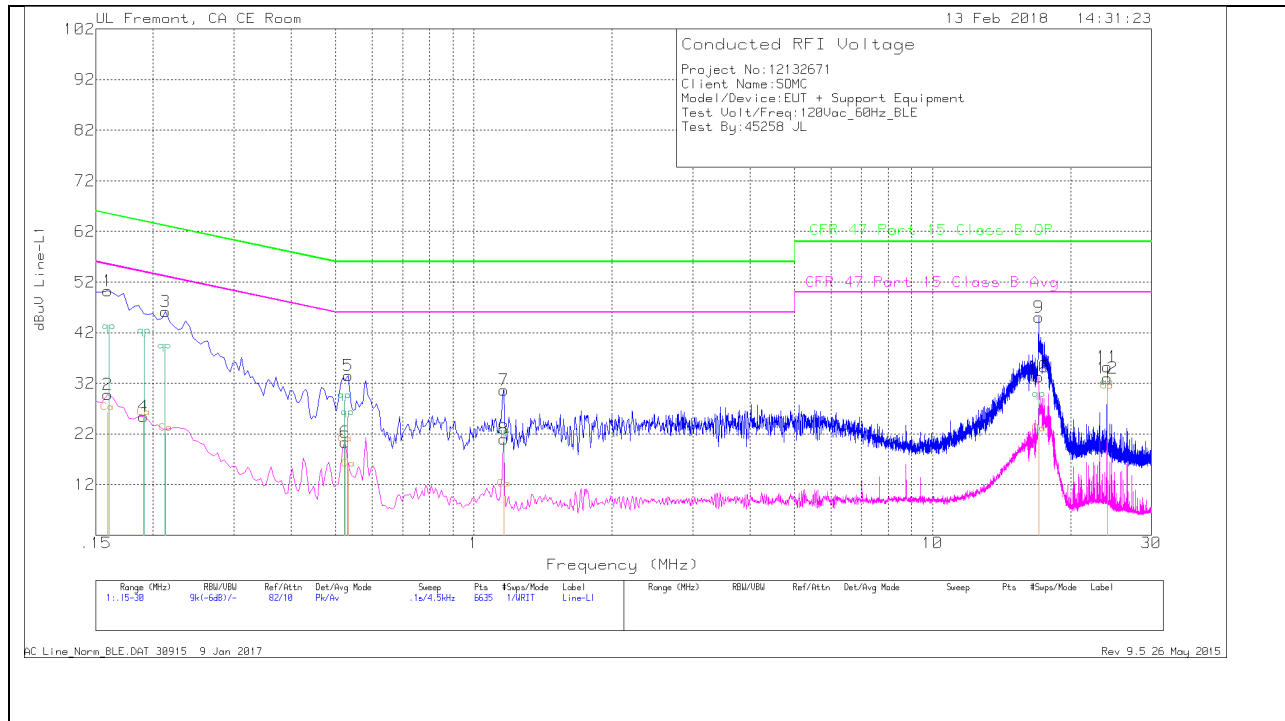

Range 1: Line-L1 .15 - 30MHz

Marker	Frequency (MHz)	Meter Reading (dBuV)	Det	LISN L1	LC Cables C1&C3	Limiter (dB)	Corrected Reading dBuV	CFR 47 Part 15 Class B QP	Margin (dB)	CFR 47 Part 15 Class B Avg	Margin (dB)
1	.159	40.11	Pk	.1	0	10.1	50.31	65.52	-15.21	-	-
2	.159	19.52	Av	.1	0	10.1	29.72	-	-	55.52	-25.8
3	.213	36.08	Pk	0	0	10.1	46.18	63.09	-16.91	-	-
4	.1905	15.29	Av	0	0	10.1	25.39	-	-	54.01	-28.62
5	.5325	23.39	Pk	0	0	10.1	33.49	56	-22.51	-	-
6	.5235	10.19	Av	0	0	10.1	20.29	-	-	46	-25.71
7	1.1625	20.43	Pk	0	.1	10.1	30.63	56	-25.37	-	-
8	1.1625	10.73	Av	0	.1	10.1	20.93	-	-	46	-25.07
9	17.061	34.45	Pk	0	.3	10.3	45.05	60	-14.95	-	-
10	17.061	22.66	Av	0	.3	10.3	33.26	-	-	50	-16.74
11	24.018	24.29	Pk	.1	.3	10.5	35.19	60	-24.81	-	-
12	24.018	22.07	Av	.1	.3	10.5	32.97	-	-	50	-17.03

Pk - Peak detector

Av - Average detection

LINE 2 RESULTS

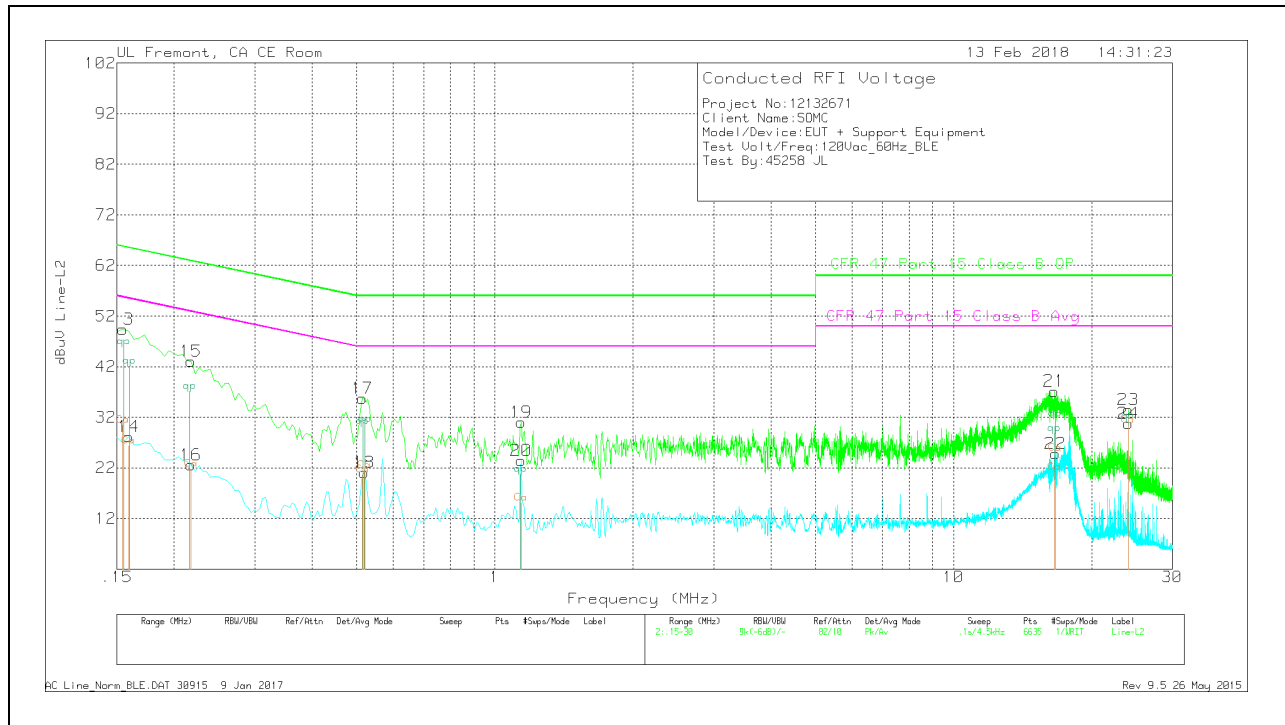

Range 2: Line-L2 .15 - 30MHz

Marker	Frequency (MHz)	Meter Reading (dBuV)	Det	LISN L2	LC Cables C2&C3	Limiter (dB)	Corrected Reading (dBuV)	CFR 47 Part 15 Class B QP	Margin (dB)	CFR 47 Part 15 Class B Avg	Margin (dB)
13	.1545	39.34	Pk	0	0	10.1	49.44	65.75	-16.31	-	-
14	.159	18.02	Av	0	0	10.1	28.12	-	-	55.52	-27.4
15	.2175	32.99	Pk	0	0	10.1	43.09	62.91	-19.82	-	-
16	.2175	12.5	Av	0	0	10.1	22.6	-	-	52.91	-30.31
17	.5145	25.68	Pk	0	0	10.1	35.78	56	-20.22	-	-
18	.519	11.02	Av	0	0	10.1	21.12	-	-	46	-24.88
19	1.14	20.79	Pk	0	.1	10.1	30.99	56	-25.01	-	-
20	1.14	13.27	Av	0	.1	10.1	23.47	-	-	46	-22.53
21	16.602	26.56	Pk	0	.3	10.3	37.16	60	-22.84	-	-
22	16.6605	14.19	Av	0	.3	10.3	24.79	-	-	50	-25.21
23	24.018	22.59	Pk	.1	.3	10.5	33.49	60	-26.51	-	-
24	24.018	19.84	Av	.1	.3	10.5	30.74	-	-	50	-19.26

Pk - Peak detector

Av - Average detection