



# FCC RF Test Report

**APPLICANT** : Sony Mobile Communications Inc.  
**EQUIPMENT** : GSM/WCDMA/LTE Phone+Bluetooth,  
DTS/UNII a/b/g/n and NFC  
**BRAND NAME** : Sony  
**FCC ID** : PY7-08618V  
**STANDARD** : FCC Part 15 Subpart C §15.247  
**CLASSIFICATION** : (DTS) Digital Transmission System

The product was received on Dec. 29, 2016 and testing was completed on Jan. 16, 2017. We, SPORTON INTERNATIONAL INC., would like to declare that the tested sample has been evaluated in accordance with the test procedures and has been in compliance with the applicable technical standards.

The test results in this report apply exclusively to the tested model / sample. Without written approval of SPORTON INTERNATIONAL INC., the test report shall not be reproduced except in full.

Reviewed by: Joseph Lin / Supervisor

Approved by: Jones Tsai / Manager



## **SPORTON INTERNATIONAL INC.**

**No. 52, Hwa Ya 1<sup>st</sup> Rd., Hwa Ya Technology Park, Kwei-Shan District, Tao Yuan City, Taiwan, R.O.C.**

**SPORTON INTERNATIONAL INC.**

TEL : 886-3-327-3456

FAX : 886-3-328-4978

FCC ID : PY7-08618V

Page Number : 1 of 40

Report Issued Date : Mar. 08, 2017

Report Version : Rev. 02

Report Template No.: BU5-FR15CWL Version 1.3



# TABLE OF CONTENTS

**REVISION HISTORY..... 3**

**SUMMARY OF TEST RESULT ..... 4**

**1 GENERAL DESCRIPTION ..... 5**

    1.1 Applicant ..... 5

    1.2 Manufacturer ..... 5

    1.3 Product Feature of Equipment Under Test ..... 5

    1.4 Modification of EUT ..... 6

    1.5 Testing Location ..... 7

    1.6 Applicable Standards ..... 7

**2 TEST CONFIGURATION OF EQUIPMENT UNDER TEST ..... 8**

    2.1 Carrier Frequency and Channel ..... 8

    2.2 Test Mode ..... 9

    2.3 Connection Diagram of Test System ..... 10

    2.4 Support Unit used in test configuration and system ..... 11

    2.5 EUT Operation Test Setup ..... 11

    2.6 Measurement Results Explanation Example ..... 11

**3 TEST RESULT ..... 12**

    3.1 6dB and 99% Bandwidth Measurement ..... 12

    3.2 Output Power Measurement ..... 14

    3.3 Power Spectral Density Measurement ..... 15

    3.4 Conducted Band Edges and Spurious Emission Measurement ..... 17

    3.5 Radiated Band Edges and Spurious Emission Measurement ..... 27

    3.6 AC Conducted Emission Measurement ..... 31

    3.7 Antenna Requirements ..... 37

**4 LIST OF MEASURING EQUIPMENT ..... 38**

**5 UNCERTAINTY OF EVALUATION ..... 40**

**APPENDIX A. CONDUCTED TEST RESULTS**

**APPENDIX B. RADIATED SPURIOUS EMISSION**

**APPENDIX C. RADIATED SPURIOUS EMISSION PLOTS**

**APPENDIX D. DUTY CYCLE PLOTS**



### REVISION HISTORY

REPORT NO.	VERSION	DESCRIPTION	ISSUED DATE
FR6D2925C	Rev. 01	Initial issue of report	Mar. 03, 2017
FR6D2925C	Rev. 02	Revising 99% BW data of the test plot in section 3.1.5.	Mar. 08, 2017



### SUMMARY OF TEST RESULT

Report Section	FCC Rule	Description	Limit	Result	Remark
3.1	15.247(a)(2)	6dB Bandwidth	$\geq 0.5\text{MHz}$	Pass	-
3.1	-	99% Bandwidth	-	Pass	-
3.2	15.247(b)	Power Output Measurement	$\leq 30\text{dBm}$	Pass	-
3.3	15.247(e)	Power Spectral Density	$\leq 8\text{dBm}/3\text{kHz}$	Pass	-
3.4	15.247(d)	Conducted Band Edges	$\leq 20\text{dBc}$	Pass	-
		Conducted Spurious Emission		Pass	-
3.5	15.247(d)	Radiated Band Edges and Radiated Spurious Emission	15.209(a) & 15.247(d)	Pass	Under limit 3.45 dB at 4924.000 MHz
3.6	15.207	AC Conducted Emission	15.207(a)	Pass	Under limit 12.80 dB at 3.246 MHz and 3.534 MHz
3.7	15.203 & 15.247(b)	Antenna Requirement	N/A	Pass	-



# 1 General Description

## 1.1 Applicant

**Sony Mobile Communications Inc.**

4-12-3 Higashi-Shinagawa, Shinagawa-ku, Tokyo, 140-0002, Japan

## 1.2 Manufacturer

**Sony Mobile Communications Inc.**

4-12-3 Higashi-Shinagawa, Shinagawa-ku, Tokyo, 140-0002, Japan

## 1.3 Product Feature of Equipment Under Test

GSM/WCDMA/LTE, Bluetooth, DTS/UNII a/b/g/n, NFC, and GPS

Standards-related Product Specification	
Antenna Type / Gain	PIFA Antenna type with gain 0.70 dBi

EUT Information List			
HW Version	SW Version	S/N	Performed Test Item
A	1.21	0123456789ABCDEF	RF conducted measurement
		WUJ01NNJAG	Radiated Spurious Emission
		WUJ01NNPAN	Conducted Emission



Accessory List	
AC Adapter	Model No. : EP800
	S/N :
	3015W41600900 (for radiated spurious emission) 3015W42100643 (for conducted emission)
Earphone	Model No. : MH410c
	S/N: N/A
USB Cable	Model No. : UCB20
	S/N :
	1635A91C00314D8 (for radiated spurious emission) 1635A9100031498 (for conducted emission)

**Note:**

1. Above EUT list and accessory list used are electrically identical per declared by manufacturer.
2. Above the accessories list are used to exercise the EUT during test.
3. For other wireless features of this EUT, test report will be issued separately.

### 1.4 Modification of EUT

No modifications are made to the EUT during all test items.



### 1.5 Testing Location

Sporton Lab is accredited to ISO 17025 by Taiwan Accreditation Foundation (TAF code : 1190) and the FCC designation No. TW0007 under the FCC 2.948(e) by Mutual Recognition Agreement (MRA) in FCC Test.

<b>Test Site</b>	SPORTON INTERNATIONAL INC.	
<b>Test Site Location</b>	No. 52, Hwa Ya 1 <sup>st</sup> Rd., Hwa Ya Technology Park, Kwei-Shan District, Tao Yuan City, Taiwan, R.O.C. TEL: +886-3-327-3456 FAX: +886-3-328-4978	
<b>Test Site No.</b>	<b>Sporton Site No.</b>	
	TH05-HY	CO05-HY

**Note:** The test site complies with ANSI C63.4 2014 requirement.

<b>Test Site</b>	SPORTON INTERNATIONAL INC.	
<b>Test Site Location</b>	No.58, Aly. 75, Ln. 564, Wenhua 3rd Rd. Guishan Dist, Taoyuan City, Taiwan (R.O.C.) TEL: +886-3-327-0868 FAX: +886-3-327-0855	
<b>Test Site No.</b>	<b>Sporton Site No.</b>	
	03CH12-HY	

**Note:** The test site complies with ANSI C63.4 2014 requirement.

### 1.6 Applicable Standards

According to the specifications of the manufacturer, the EUT must comply with the requirements of the following standards:

- ♦ FCC Part 15 Subpart C §15.247
- ♦ FCC KDB Publication No. 558074 D01 DTS Meas. Guidance v03r05
- ♦ ANSI C63.10-2013

**Remark:**

1. All test items were verified and recorded according to the standards and without any deviation during the test.
2. This EUT has also been tested and complied with the requirements of FCC Part 15, Subpart B, recorded in a separate test report.



## 2 Test Configuration of Equipment Under Test

The EUT has been associated with peripherals and configuration operated in a manner tended to maximize its emission characteristics in a typical application. Frequency range investigated: conducted emission (150 kHz to 30 MHz) and radiated emission (9 kHz to the 10th harmonic of the highest fundamental frequency or to 40 GHz, whichever is lower). For radiated measurement, pre-scanned in three orthogonal panels, X, Y, Z. The worst cases (X plane) were recorded in this report.

### 2.1 Carrier Frequency and Channel

Frequency Band	Channel	Freq. (MHz)	Channel	Freq. (MHz)
2400-2483.5 MHz	1	2412	7	2442
	2	2417	8	2447
	3	2422	9	2452
	4	2427	10	2457
	5	2432	11	2462
	6	2437	-	-





## 2.2 Test Mode

Final test mode of conducted test items and radiated spurious emissions are considering the modulation and worse data rates as below table.

Modulation	Data Rate
802.11b	1 Mbps
802.11g	6 Mbps
802.11n HT20	MCS0

Test Cases	
AC Conducted Emission	Mode 1 : GSM1900 Idle + Bluetooth Link + WLAN (2.4GHz) Link + MP3 + Earphone + Battery + USB Cable (Charging from Adapter)

## 2.3 Connection Diagram of Test System

<WLAN Tx Mode>

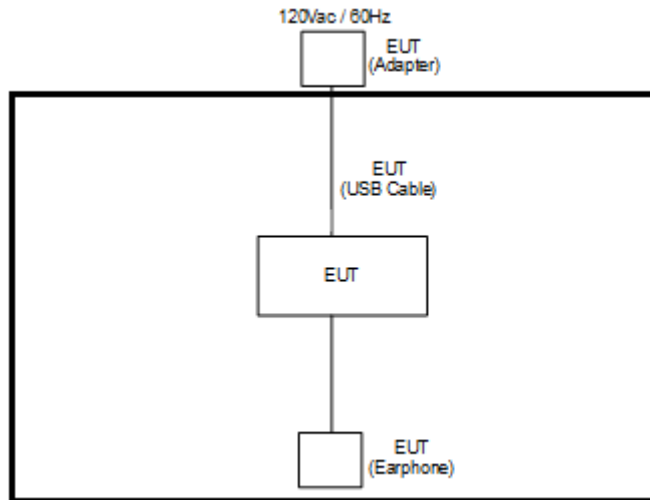

<AC Conducted Emission Mode>

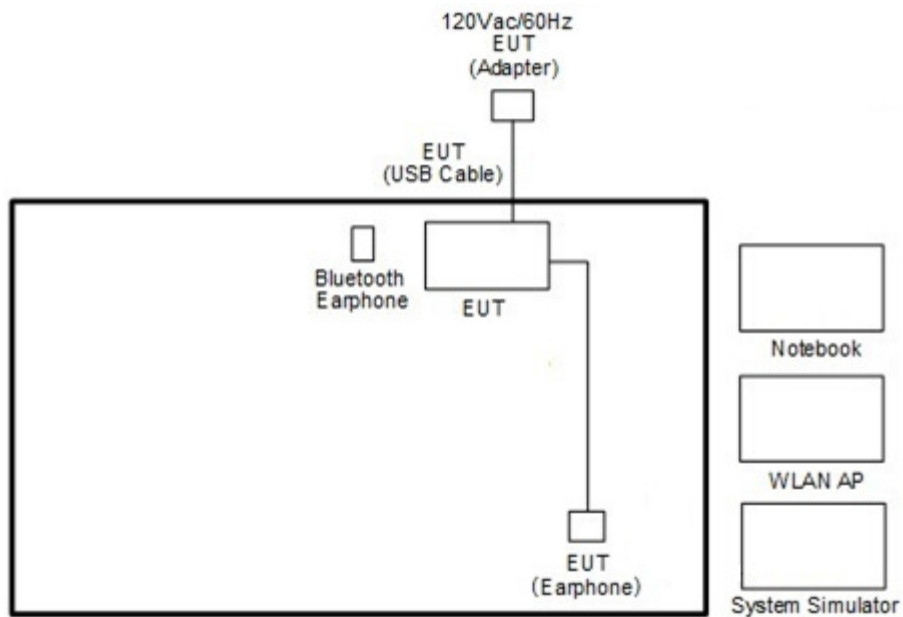



### 2.4 Support Unit used in test configuration and system

Item	Equipment	Trade Name	Model Name	FCC ID	Data Cable	Power Cord
1.	System Simulator	Anritsu	MT8820C	N/A	N/A	Unshielded, 1.8 m
2.	WLAN AP	ASUS	RT-AC66U	MSQ-RTAC66U	N/A	Unshielded, 1.8 m
3.	Notebook	DELL	Latitude E6320	FCC DoC/ Contains FCC ID: QDS-BRCM1054	N/A	AC I/P: Unshielded, 1.2 m DC O/P: Shielded, 1.8 m
4.	Bluetooth Earphone	Sony	SBH20	PY7-RD0010	N/A	N/A
5.	SD Card	SanDisk	MicroSD HC	FCC DoC	N/A	N/A

### 2.5 EUT Operation Test Setup

For RF test items, an engineering test program was provided and enabled to make EUT transmitting signals.

### 2.6 Measurement Results Explanation Example

For all conducted test items:

The offset level is set in the spectrum analyzer to compensate the RF cable loss and attenuator factor between EUT conducted output port and spectrum analyzer. With the offset compensation, the spectrum analyzer reading level is exactly the EUT RF output level.

Example :

The spectrum analyzer offset is derived from RF cable loss and attenuator factor.

*Offset = RF cable loss + attenuator factor.*

Following shows an offset computation example with cable loss 4.2 dB and 10dB attenuator.

$$\begin{aligned}
\text{Offset(dB)} &= \text{RF cable loss(dB)} + \text{attenuator factor(dB)}. \\
&= 4.2 + 10 = 14.2 \text{ (dB)}
\end{aligned}$$

### 3 Test Result

#### 3.1 6dB and 99% Bandwidth Measurement

##### 3.1.1 Limit of 6dB and 99% Bandwidth

The minimum 6 dB bandwidth shall be at least 500 kHz.

##### 3.1.2 Measuring Instruments

The measuring equipment is listed in the section 4 of this test report.

##### 3.1.3 Test Procedures

1. The testing follows FCC KDB Publication No. 558074 DTS D01 Meas. Guidance v03r05.
2. The RF output of EUT was connected to the spectrum analyzer by RF cable and attenuator. The path loss was compensated to the results for each measurement.
3. Set to the maximum power setting and enable the EUT transmit continuously.
4. Make the measurement with the spectrum analyzer's resolution bandwidth (RBW) = 100 kHz. Set the Video bandwidth (VBW) = 300 kHz. In order to make an accurate measurement. The 6 dB bandwidth must be greater than 500 kHz.
5. For 99% Bandwidth Measurement, the spectrum analyzer's resolution bandwidth (RBW) = 1MHz and set the Video bandwidth (VBW) = 3MHz.
6. Measure and record the results in the test report.

##### 3.1.4 Test Setup





### 3.1.5 Test Result of 6dB and 99% Occupied Bandwidth

Please refer to Appendix A.

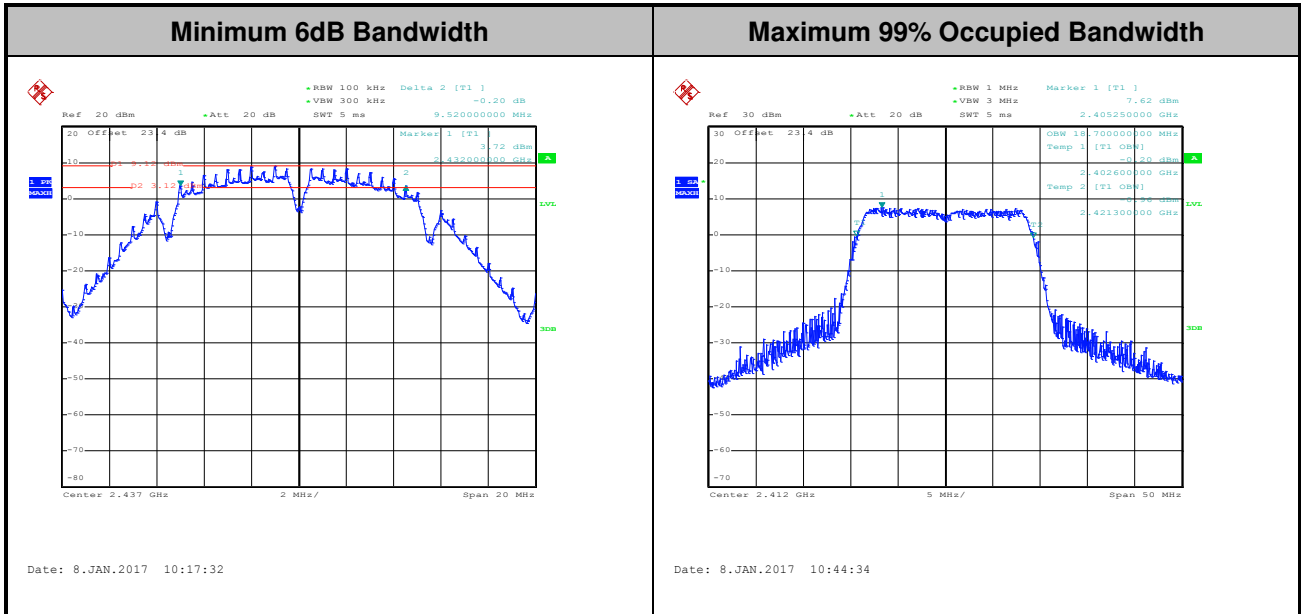

Note : The occupied channel bandwidth is maintained within the band of operation for all of the modulations.

## 3.2 Output Power Measurement

### 3.2.1 Limit of Output Power

For systems using digital modulation in the 2400-2483.5MHz, the limit for peak output power is 30dBm. If transmitting antenna of directional gain greater than 6dBi are used the peak output power from the intentional radiator shall be reduced below the above stated value by the amount in dB that the directional gain of the antenna exceeds 6 dBi. In case of point-to-point operation, the limit has to be reduced by 1dB for every 3dB that the directional gain of the antenna exceeds 6dBi.

### 3.2.2 Measuring Instruments

The measuring equipment is listed in the section 4 of this test report.

### 3.2.3 Test Procedures

1. The testing follows the Measurement Procedure of FCC KDB No. 558074 DTS D01 Meas. Guidance v03r05 section 9.1.2 PKPM1 Peak power meter method.
2. The RF output of EUT was connected to the power meter by RF cable and attenuator. The path loss was compensated to the results for each measurement.
3. Set to the maximum power setting and enable the EUT transmit continuously.
4. Measure the conducted output power and record the results in the test report.

### 3.2.4 Test Setup

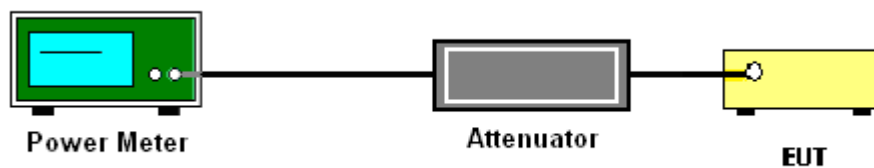

### 3.2.5 Test Result of Peak Output Power

Please refer to Appendix A.

### 3.2.6 Test Result of Average output Power (Reporting Only)

Please refer to Appendix A.

### 3.3 Power Spectral Density Measurement

#### 3.3.1 Limit of Power Spectral Density

The peak power spectral density shall not be greater than 8dBm in any 3kHz band at any time interval of continuous transmission.

#### 3.3.2 Measuring Instruments

The measuring equipment is listed in the section 4 of this test report.

#### 3.3.3 Test Procedures

1. The testing follows Measurement Procedure 10.2 Method PKPSD of FCC KDB Publication No. 558074 D01 DTS Meas. Guidance v03r05
2. The RF output of EUT was connected to the spectrum analyzer by RF cable and attenuator. The path loss was compensated to the results for each measurement.
3. Set to the maximum power setting and enable the EUT transmit continuously.
4. Make the measurement with the spectrum analyzer's resolution bandwidth (RBW) = 3 kHz. Video bandwidth VBW = 10 kHz In order to make an accurate measurement, set the span to 1.5 times DTS Channel Bandwidth. (6dB BW)
5. Detector = peak, Sweep time = auto couple, Trace mode = max hold, Allow trace to fully stabilize. Use the peak marker function to determine the maximum power level.
6. Measure and record the results in the test report.

#### 3.3.4 Test Setup





### 3.3.5 Test Result of Power Spectral Density

Please refer to Appendix A.

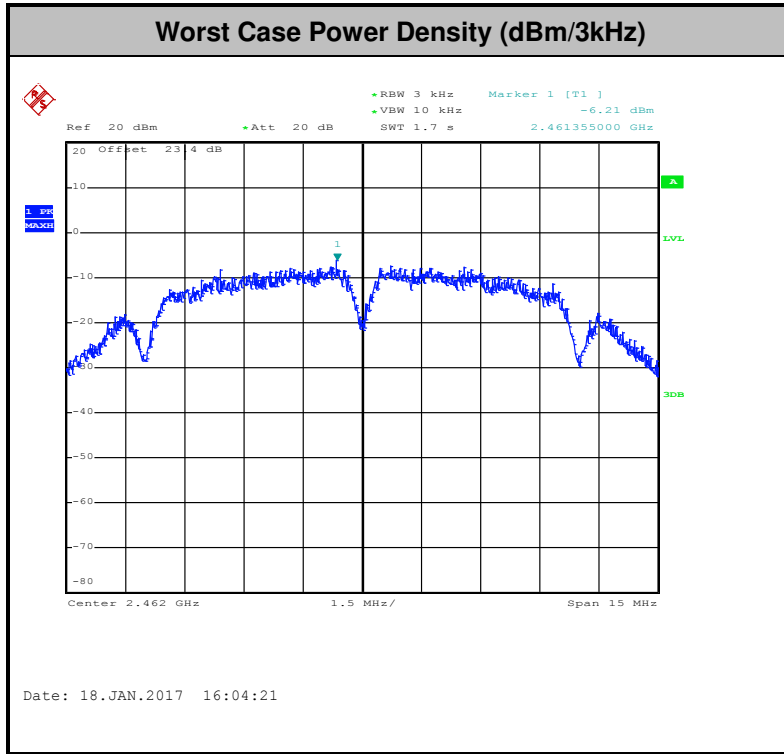



### 3.4 Conducted Band Edges and Spurious Emission Measurement

#### 3.4.1 Limit of Conducted Band Edges and Spurious Emission Measurement

In any 100 kHz bandwidth outside of the authorized frequency band, the emissions which fall in the non-restricted bands shall be attenuated at least 20 dB / 30dB relative to the maximum PSD level in 100 kHz by RF conducted measurement and radiated emissions which fall in the restricted bands, as defined in Section 15.205(a), must also comply with the radiated emission limits specified in Section 15.209(a).

#### 3.4.2 Measuring Instruments

The measuring equipment is listed in the section 4 of this test report.

#### 3.4.3 Test Procedures

1. The testing follows FCC KDB Publication No. 558074 D01 DTS Meas. Guidance v03r05.
2. The RF output of EUT was connected to the spectrum analyzer by RF cable and attenuator. The path loss was compensated to the results for each measurement.
3. Set to the maximum power setting and enable the EUT transmit continuously.
4. Set RBW = 100 kHz, VBW=300 kHz, Peak Detector. Unwanted Emissions measured in any 100 kHz bandwidth outside of the authorized frequency band shall be attenuated by at least 20 dB relative to the maximum in-band peak PSD level in 100 kHz when maximum peak conducted output power procedure is used. If the transmitter complies with the conducted power limits based on the use of RMS averaging over a time interval, the attenuation required under this paragraph shall be 30 dB instead of 20 dB per 15.247(d).
5. Measure and record the results in the test report.
6. The RF fundamental frequency should be excluded against the limit line in the operating frequency band.

#### 3.4.4 Test Setup

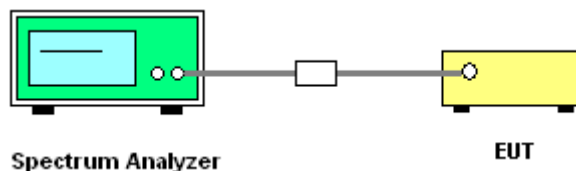



### 3.4.5 Test Result of Conducted Band Edges and Spurious Emission

Test Mode :	802.11b	Temperature :	21~25°C
Test Band :	2.4GHz Low	Relative Humidity :	51~54%
Test Channel :	01	Test Engineer :	Kai Liao / Derek Hsu

#### WLAN 802.11b Channel 01

<b>100kHz PSD reference Level</b>	<b>Low Channel Plot</b>
-----------------------------------	-------------------------

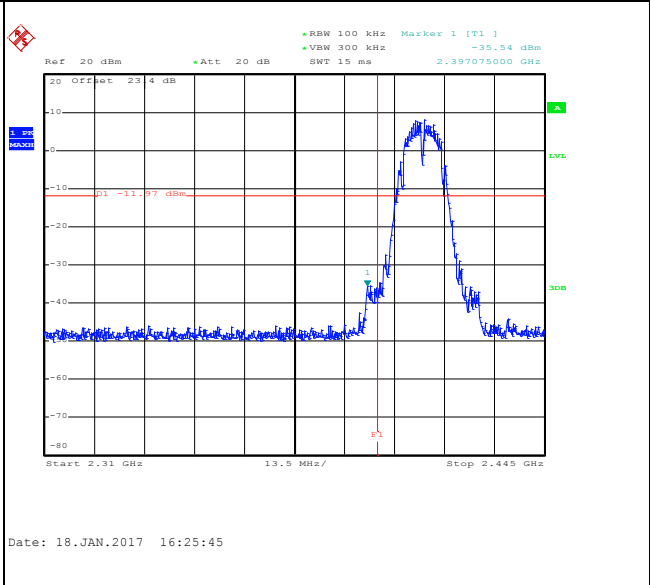
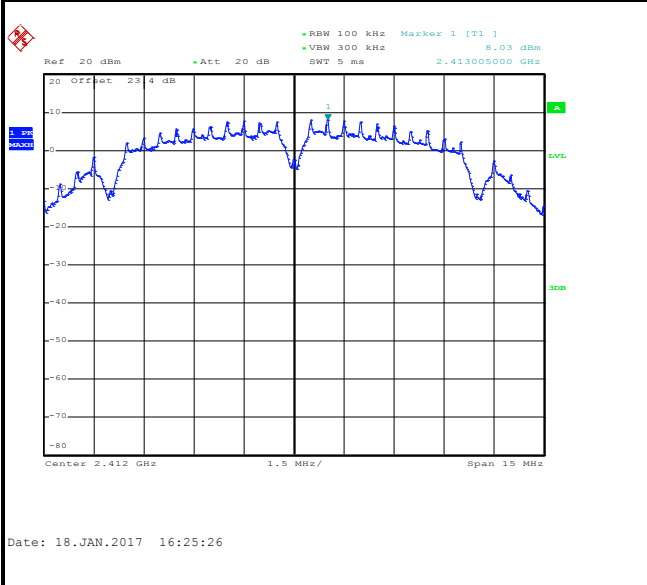

#### Spurious Emission 30MHz~3GHz

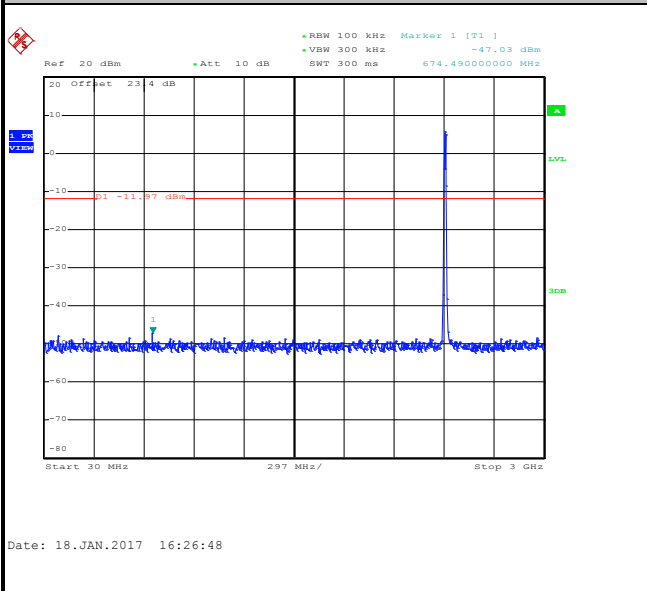

#### Spurious Emission 2GHz~25GHz

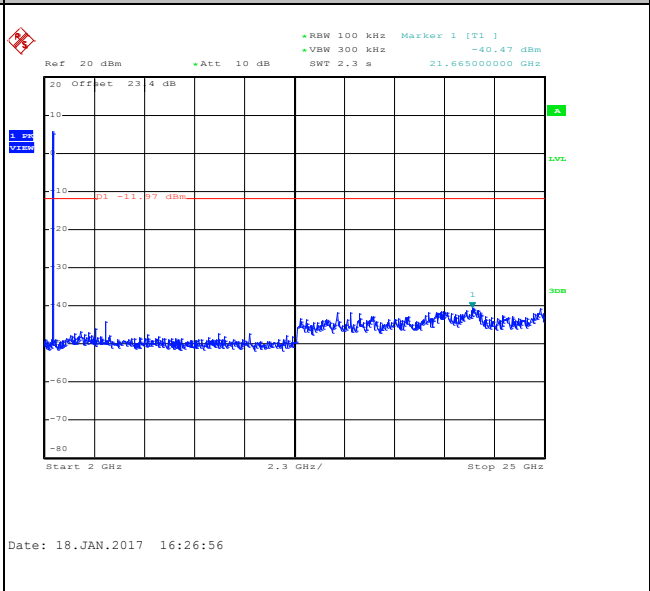



Test Mode :	802.11b	Temperature :	21~25
Test Band :	2.4GHz Mid	Relative Humidity :	51~54
Test Channel :	06	Test Engineer :	Kai Liao / Derek Hsu

WLAN 802.11b Channel 06

100kHz PSD reference Level

Mid Channel Plot

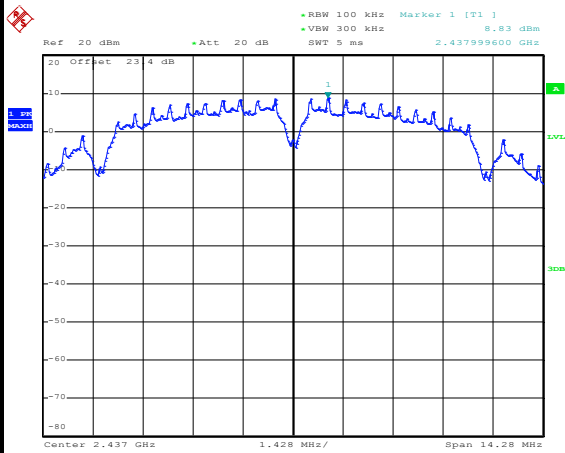

Date: 8.JAN.2017 10:17:55

Spurious Emission 30MHz~3GHz

Spurious Emission 2GHz~25GHz

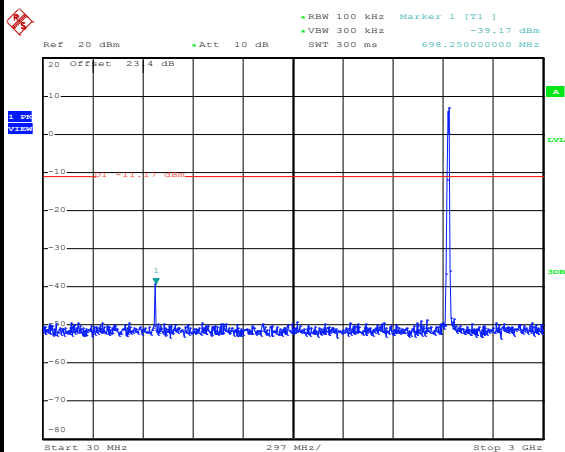

Date: 8.JAN.2017 10:18:07

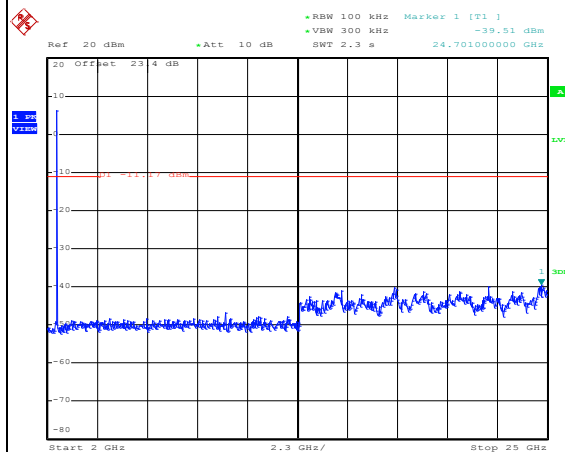

Date: 8.JAN.2017 10:18:15



Test Mode :	802.11b	Temperature :	21~25
Test Band :	2.4GHz High	Relative Humidity :	51~54
Test Channel :	11	Test Engineer :	Kai Liao / Derek Hsu

WLAN 802.11b Channel 11

100kHz PSD reference Level

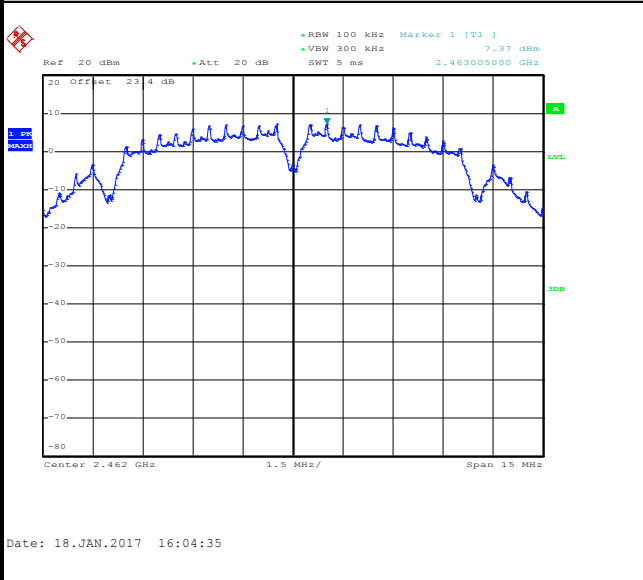

High Channel Plot

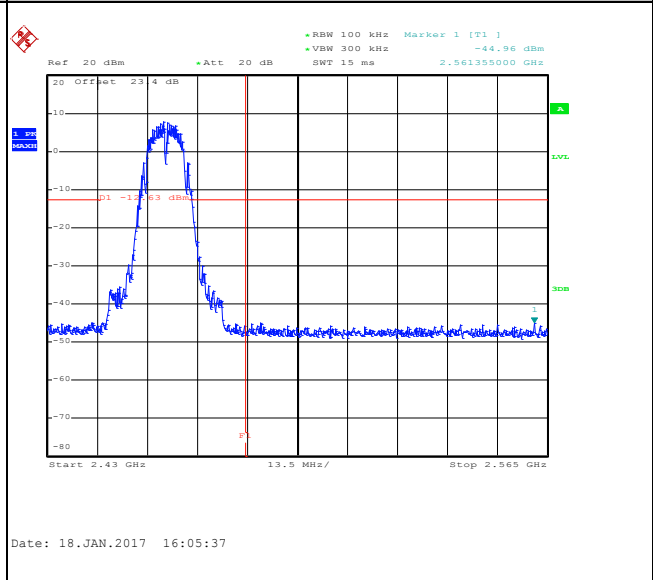

Spurious Emission 30MHz~3GHz

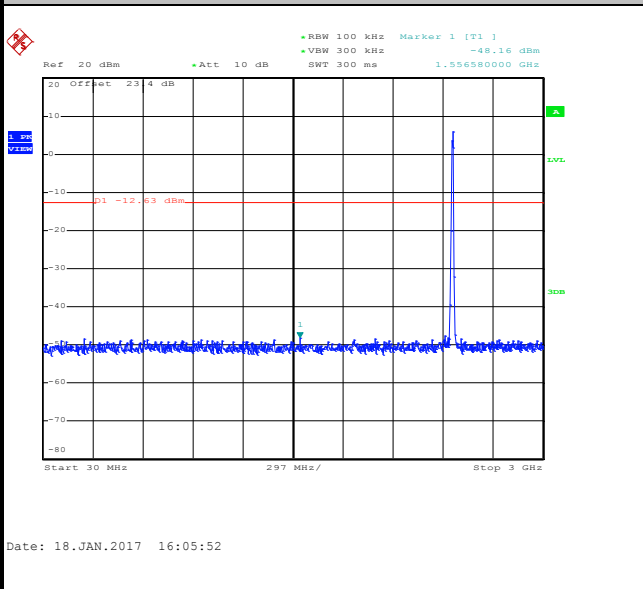

Spurious Emission 2GHz~25GHz

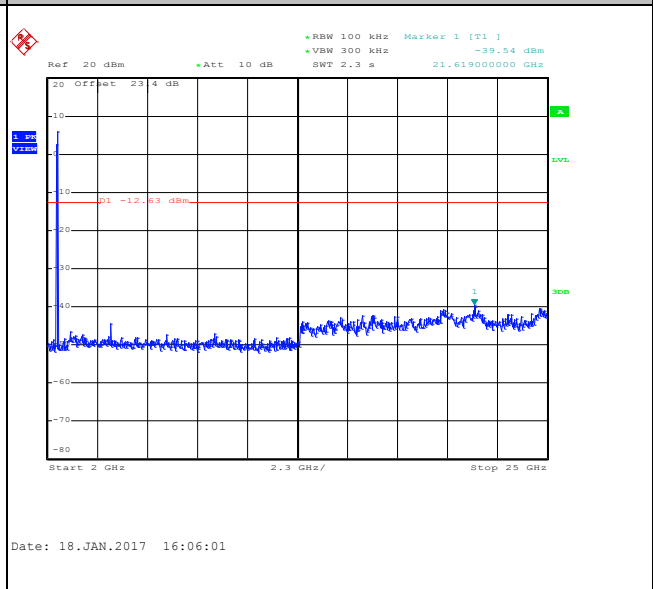



Test Mode :	802.11g	Temperature :	21~25
Test Band :	2.4GHz Low	Relative Humidity :	51~54
Test Channel :	01	Test Engineer :	Kai Liao / Derek Hsu

WLAN 802.11g Channel 01

100kHz PSD reference Level

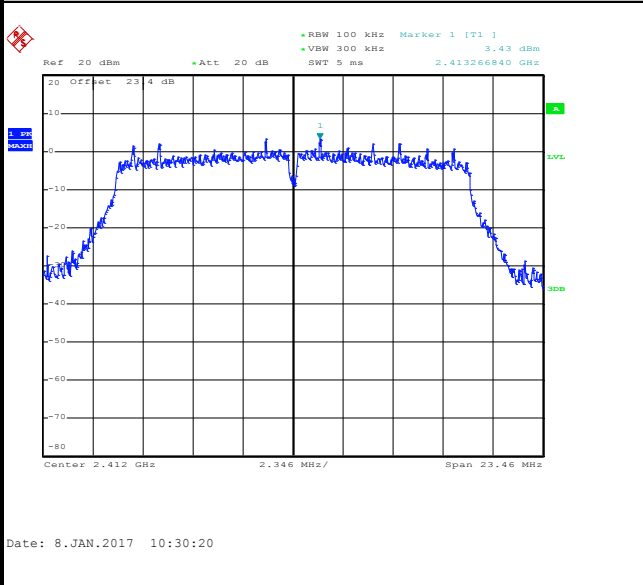

Low Channel Plot

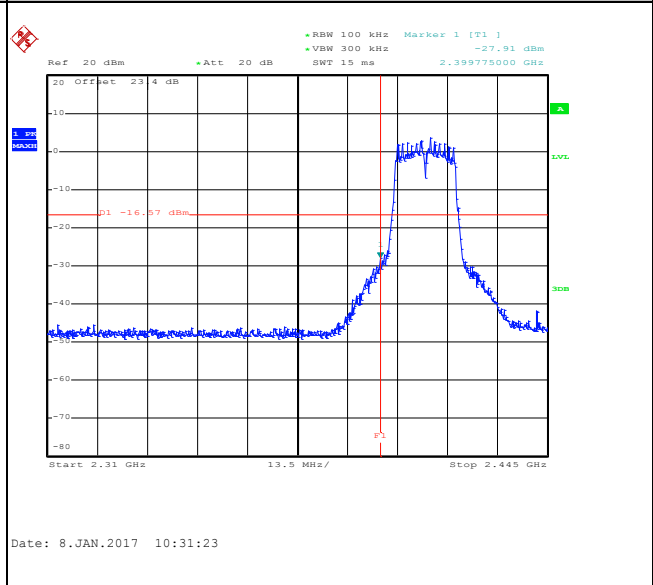

Spurious Emission 30MHz~3GHz

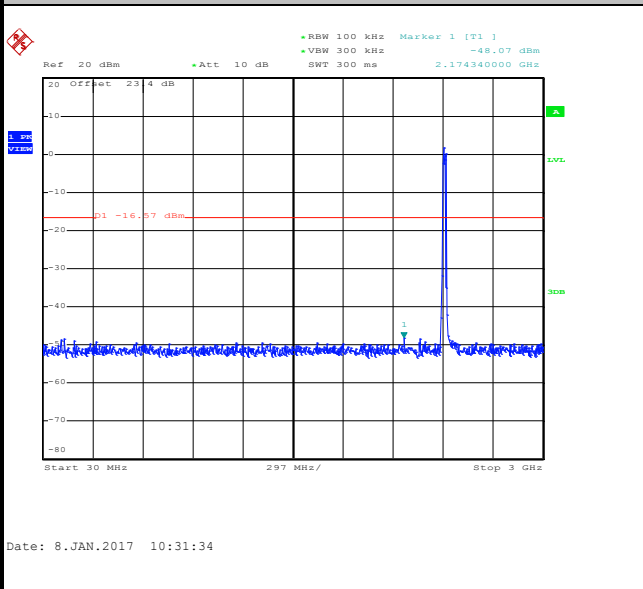

Spurious Emission 2GHz~25GHz

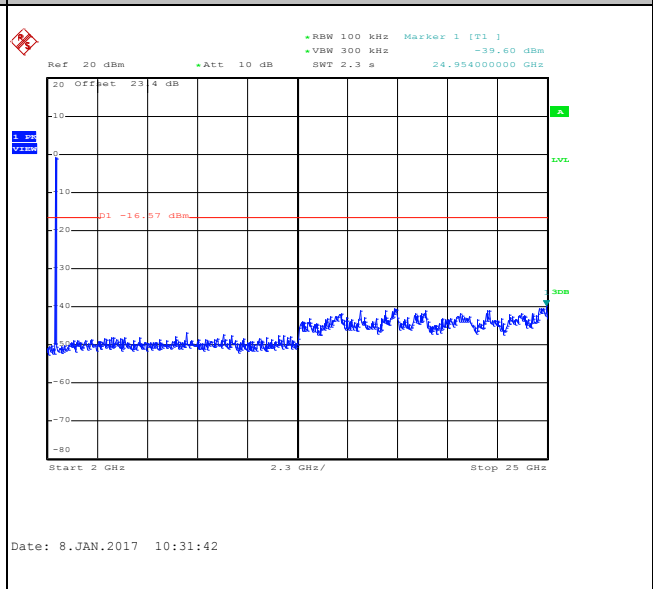



Test Mode :	802.11g	Temperature :	21~25
Test Band :	2.4GHz Mid	Relative Humidity :	51~54
Test Channel :	06	Test Engineer :	Kai Liao / Derek Hsu

WLAN 802.11g Channel 06

100kHz PSD reference Level

Mid Channel Plot

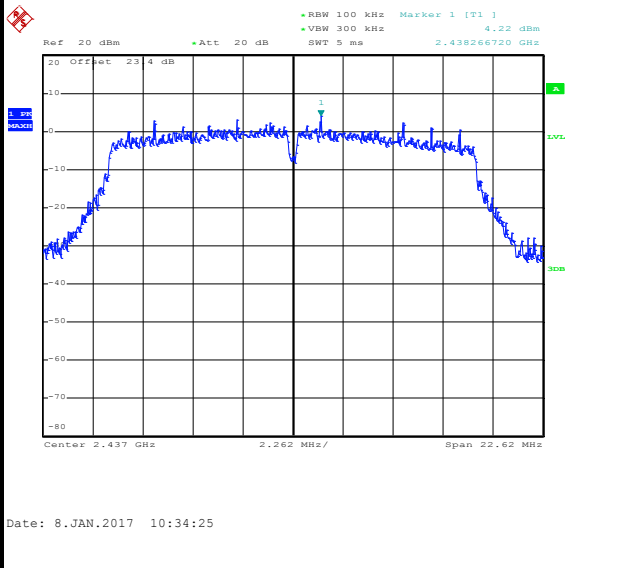

Spurious Emission 30MHz~3GHz

Spurious Emission 2GHz~25GHz

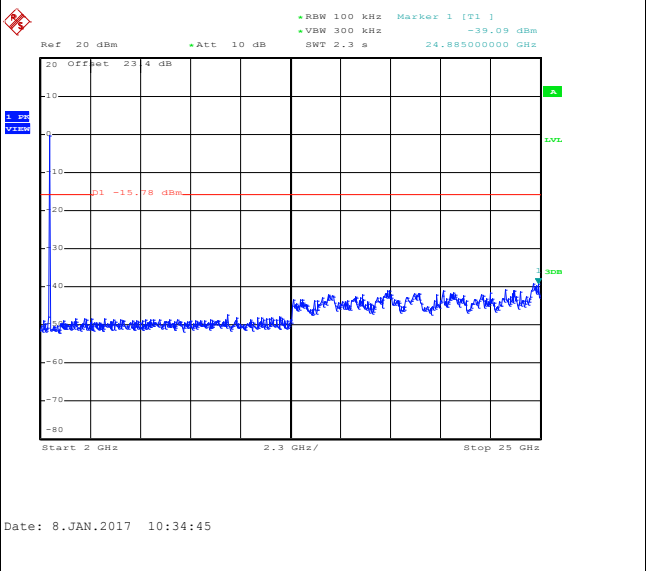
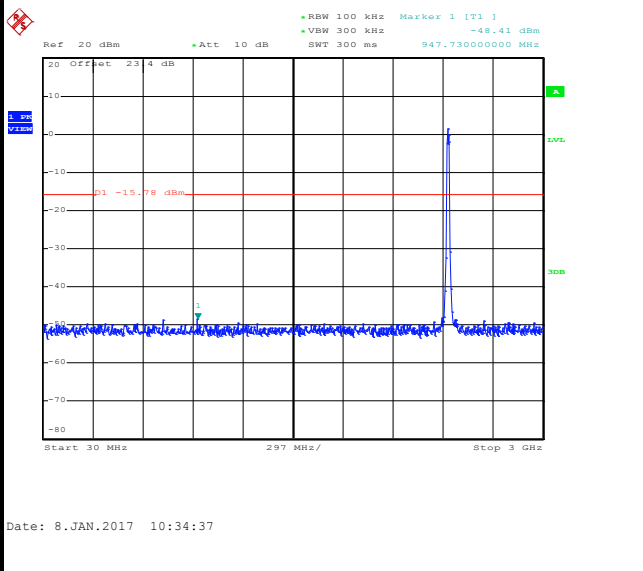



Test Mode :	802.11g	Temperature :	21~25
Test Band :	2.4GHz High	Relative Humidity :	51~54
Test Channel :	11	Test Engineer :	Kai Liao / Derek Hsu

WLAN 802.11g Channel 11

100kHz PSD reference Level

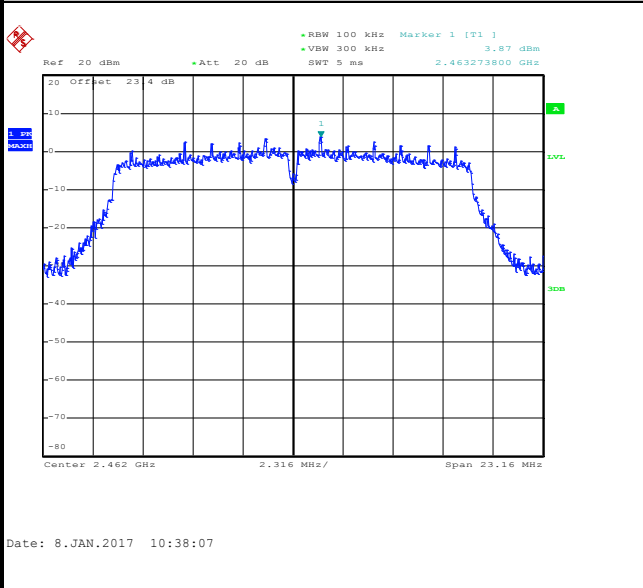

High Channel Plot

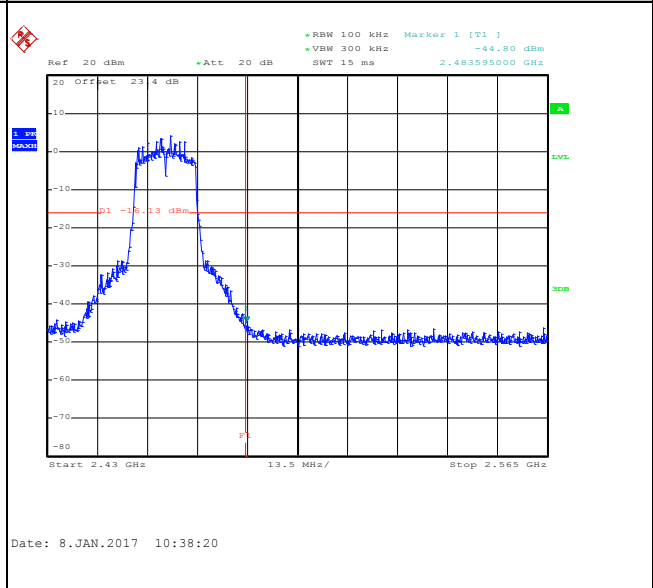

Spurious Emission 30MHz~3GHz

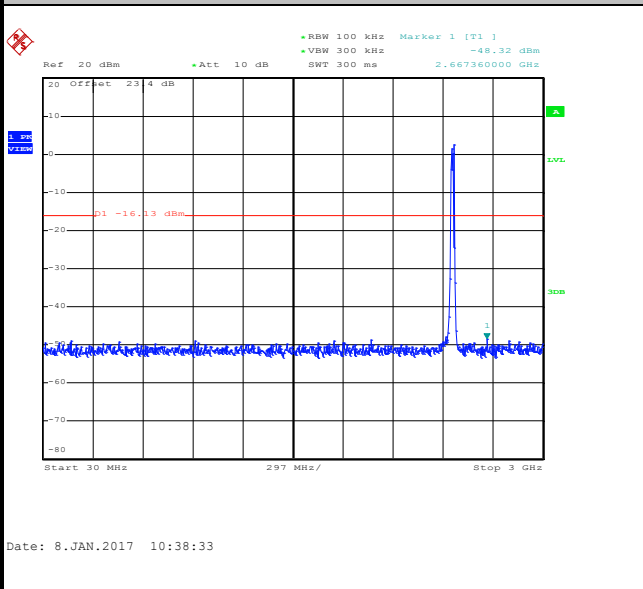

Spurious Emission 2GHz~25GHz

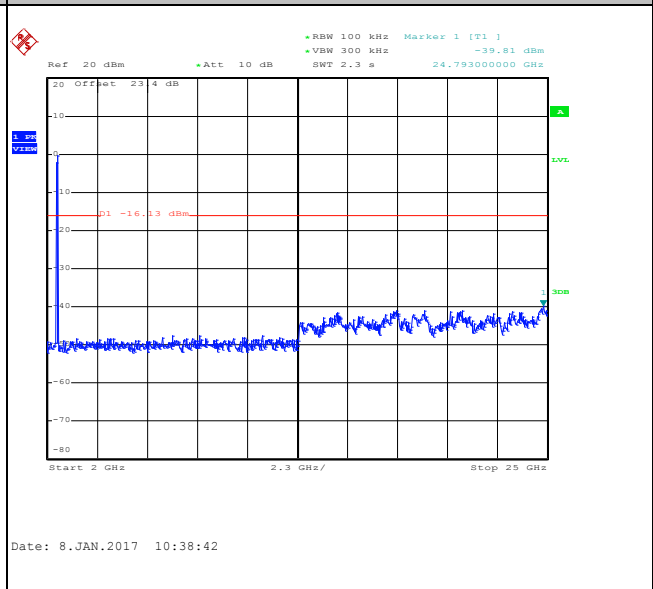



Test Mode :	802.11n HT20	Temperature :	21~25
Test Band :	2.4GHz Low	Relative Humidity :	51~54
Test Channel :	01	Test Engineer :	Kai Liao / Derek Hsu

WLAN 802.11n HT20 Channel 01

100kHz PSD reference Level

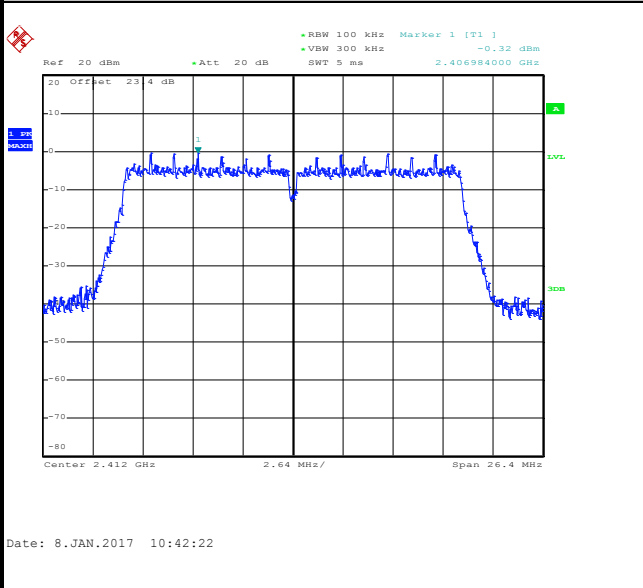

Low Channel Plot

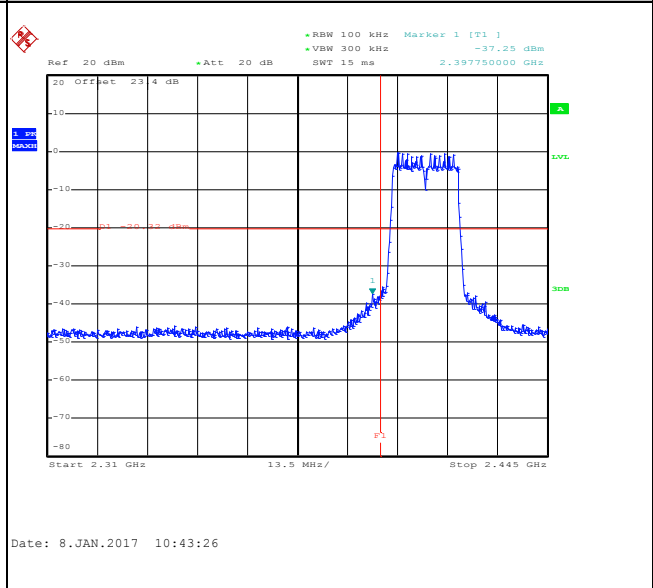

Spurious Emission 30MHz~3GHz

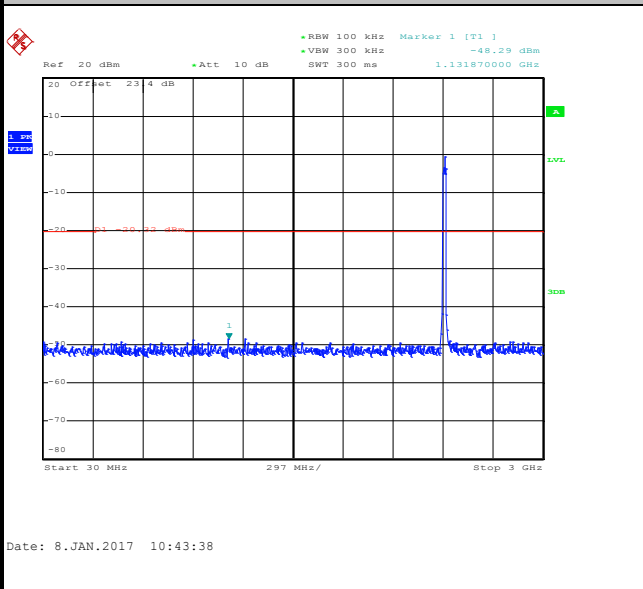

Spurious Emission 2GHz~25GHz

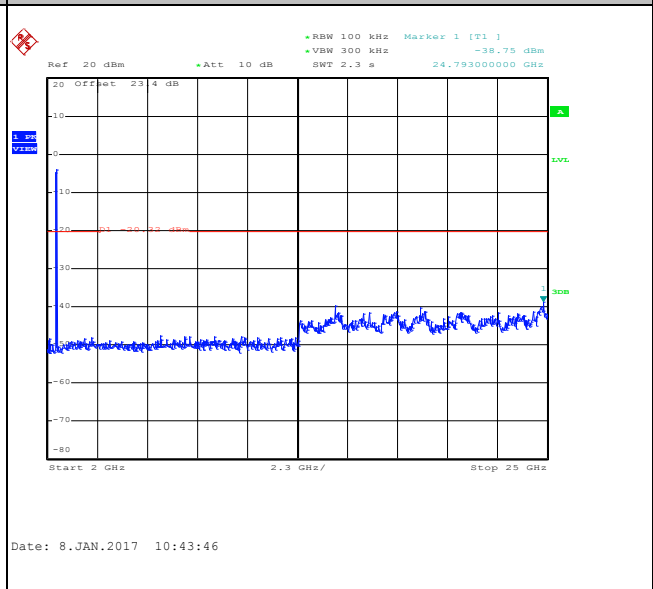





Test Mode :	802.11n HT20	Temperature :	21~25
Test Band :	2.4GHz Mid	Relative Humidity :	51~54
Test Channel :	06	Test Engineer :	Kai Liao / Derek Hsu

WLAN 802.11n HT20 Channel 06

100kHz PSD reference Level

Mid Channel Plot

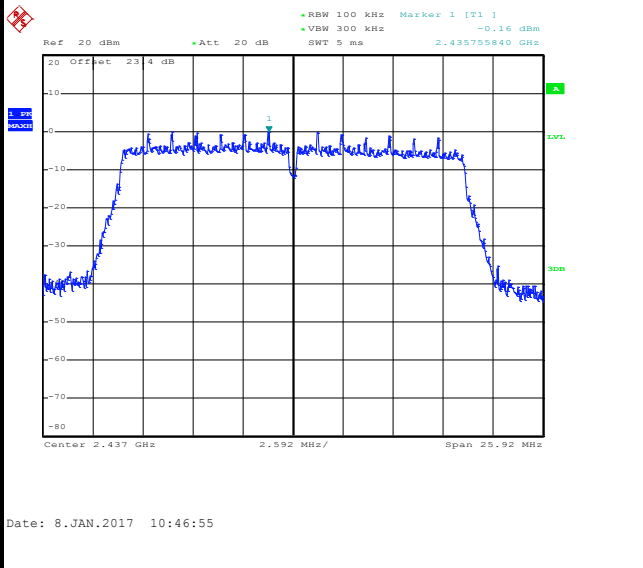

Spurious Emission 30MHz~3GHz

Spurious Emission 2GHz~25GHz

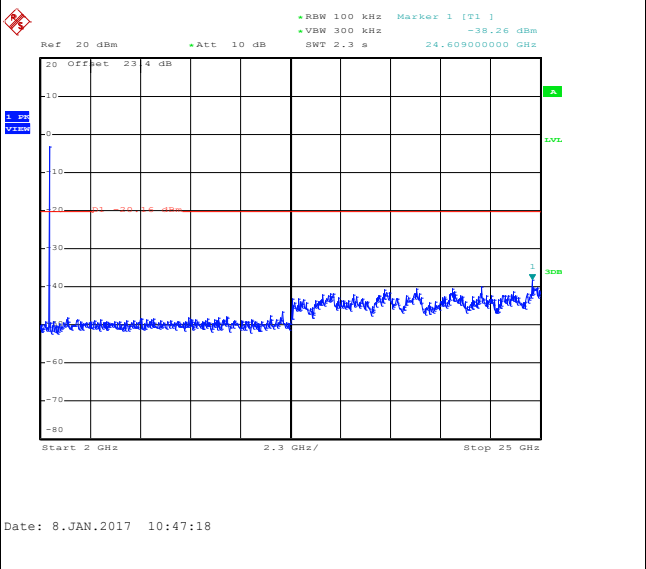
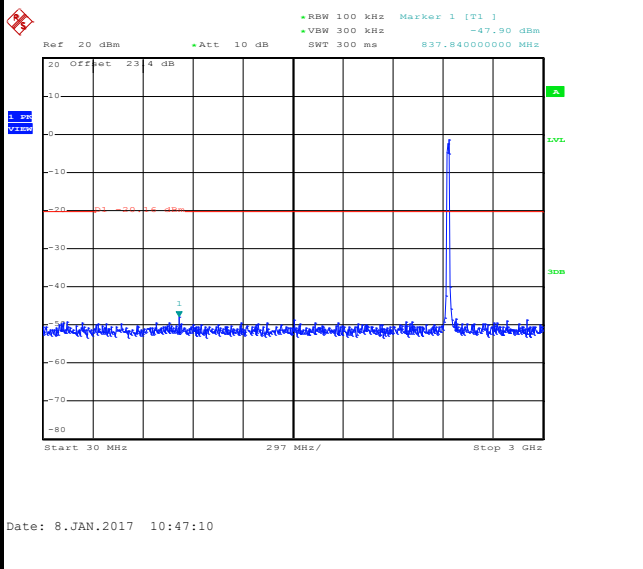



Test Mode :	802.11n HT20	Temperature :	21~25
Test Band :	2.4GHz High	Relative Humidity :	51~54
Test Channel :	11	Test Engineer :	Kai Liao / Derek Hsu

WLAN 802.11n HT20 Channel 11

100kHz PSD reference Level

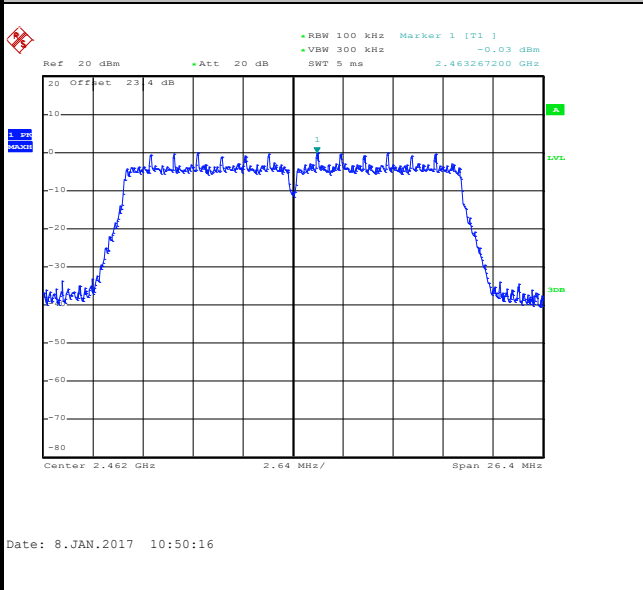

High Channel Plot

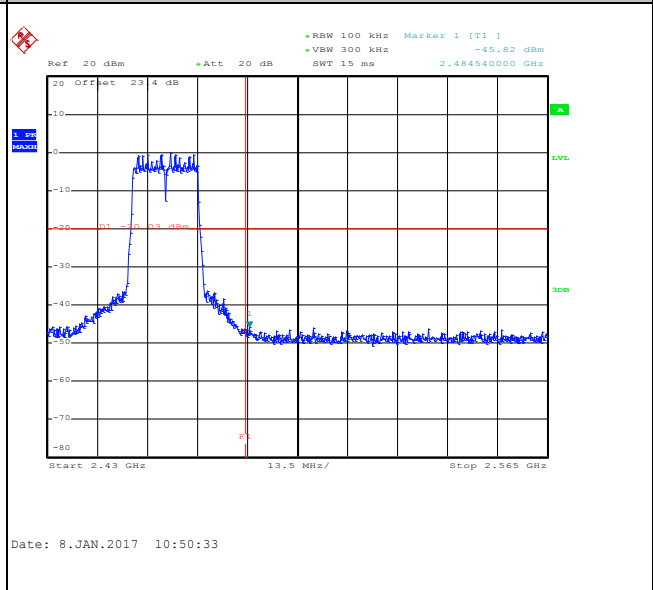

Spurious Emission 30MHz~3GHz

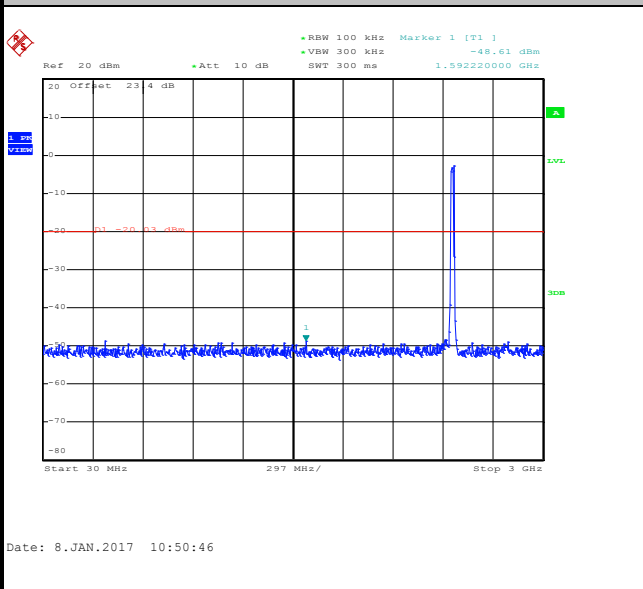

Spurious Emission 2GHz~25GHz

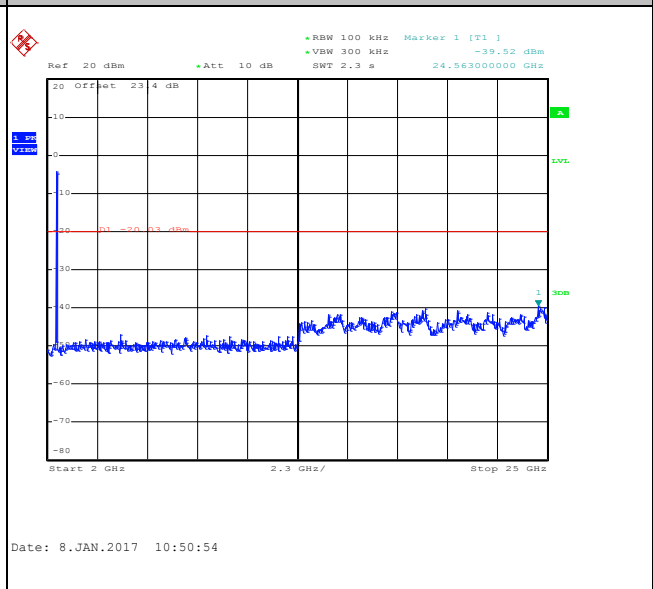



### 3.5 Radiated Band Edges and Spurious Emission Measurement

#### 3.5.1 Limit of Radiated band edge and Spurious Emission Measurement

In any 100 kHz bandwidth outside the intentional radiator frequency band, all harmonics/spurious must be at least 20 dB below the highest emission level within the authorized band. If the output power of this device was measured by spectrum analyzer, the attenuation under this paragraph shall be 30 dB instead of 20 dB. In addition, radiated emissions which fall in the restricted bands must also comply with the FCC section 15.209 limits as below.

Frequency (MHz)	Field Strength (microvolts/meter)	Measurement Distance (meters)
0.009 – 0.490	2400/F(kHz)	300
0.490 – 1.705	24000/F(kHz)	30
1.705 – 30.0	30	30
30 – 88	100	3
88 – 216	150	3
216 - 960	200	3
Above 960	500	3

#### 3.5.2 Measuring Instruments

The measuring equipment is listed in the section 4 of this test report.



### 3.5.3 Test Procedures

1. The testing follows FCC KDB Publication No. 558074 D01 DTS Meas. Guidance v03r05.
2. The EUT was arranged to its worst case and then tune the antenna tower (from 1 m to 4 m) and turntable (from 0 degree to 360 degrees) to find the maximum reading. A pre-amp and a high pass filter are used for the test in order to get better signal level.
3. The EUT was placed on a turntable with 0.8 meter for frequency below 1GHz and 1.5 meter for frequency above 1GHz respectively above ground.
4. The EUT was set 3 meters from the interference receiving antenna, which was mounted on the top of a variable height antenna tower.
5. Corrected Reading: Antenna Factor + Cable Loss + Read Level - Preamp Factor = Level
6. For measurement below 1GHz, If the emission level of the EUT measured by the peak detector is 3 dB lower than the applicable limit, the peak emission level will be reported. Otherwise, the emission measurement will be repeated using the quasi-peak detector and reported.
7. Use the following spectrum analyzer settings:
  - (1) Span shall wide enough to fully capture the emission being measured;
  - (2) Set RBW=100 kHz for  $f < 1$  GHz; VBW  $\geq$  RBW; Sweep = auto; Detector function = peak; Trace = max hold;
  - (3) Set RBW = 1 MHz, VBW= 3MHz for  $f \geq 1$  GHz for peak measurement.  
For average measurement:
    - VBW = 10 Hz, when duty cycle is no less than 98 percent.
    - VBW  $\geq 1/T$ , when duty cycle is less than 98 percent where T is the minimum transmission duration over which the transmitter is on and is transmitting at its maximum power control level for the tested mode of operation.

### 3.5.4 Test Setup

For radiated emissions below 30MHz

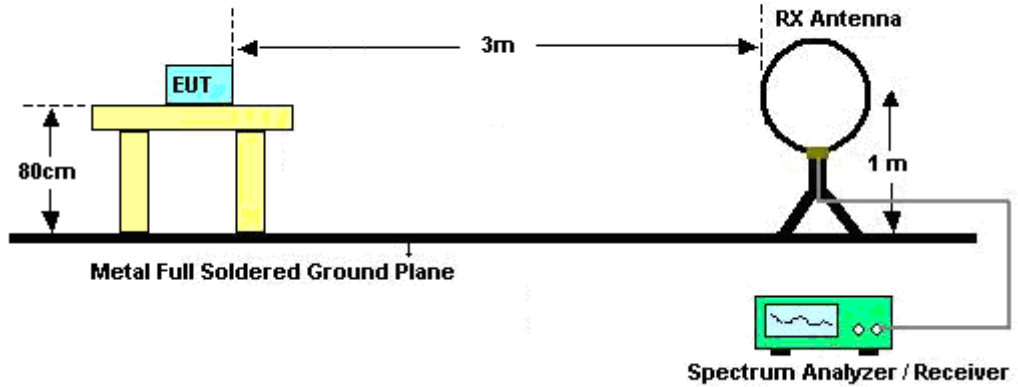

For radiated emissions from 30MHz to 1GHz

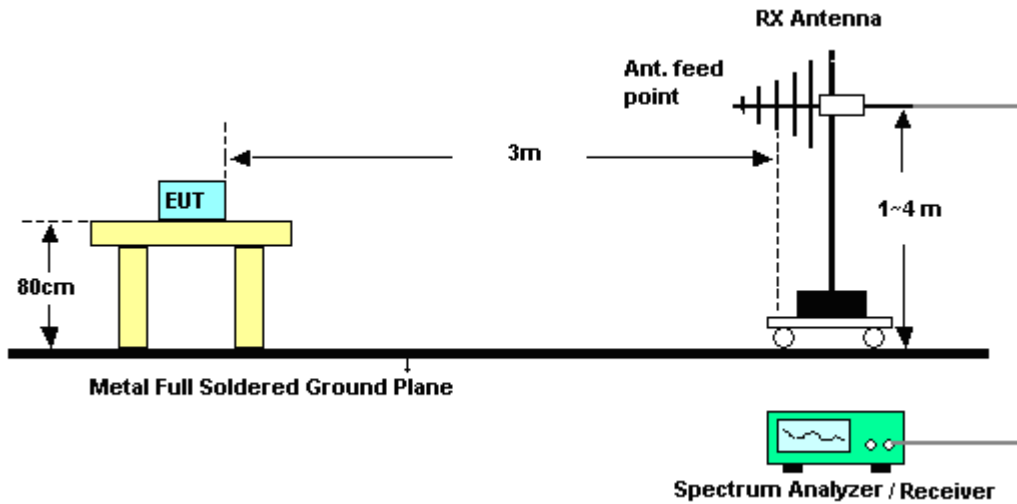

For radiated emissions above 1GHz

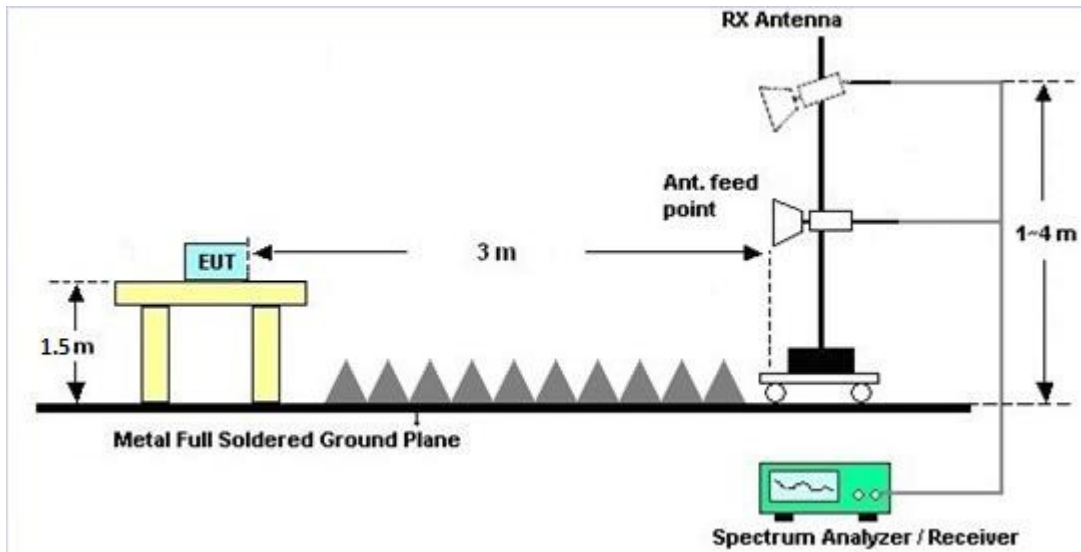

### 3.5.5 Test Results of Radiated Spurious Emissions (9kHz ~ 30MHz)

The low frequency, which started from 9 kHz to 30MHz, was pre-scanned and the result which was 20dB lower than the limit line per 15.31(o) was not reported.

### 3.5.6 Test Result of Radiated Spurious at Band Edges

Please refer to Appendix B and C.

### 3.5.7 Duty Cycle

Please refer to Appendix D.

### 3.5.8 Test Result of Radiated Spurious Emission (30MHz ~ 10<sup>th</sup> Harmonic)

Please refer to Appendix B and C.



### 3.6 AC Conducted Emission Measurement

#### 3.6.1 Limit of AC Conducted Emission

For equipment that is designed to be connected to the public utility (AC) power line, the radio frequency voltage that is conducted back onto the AC power line on any frequency or frequencies within the band 150 kHz to 30 MHz shall not exceed the limits in the following table.

Frequency of Emission (MHz)	Conducted Limit (dB $\mu$ V)	
	Quasi-Peak	Average
0.15-0.5	66 to 56*	56 to 46*
0.5-5	56	46
5-30	60	50

\*Decreases with the logarithm of the frequency.

#### 3.6.2 Measuring Instruments

The measuring equipment is listed in the section 4 of this test report.

#### 3.6.3 Test Procedures

1. The EUT was placed 0.4 meter from the conducting wall of the shielding room, and it was kept at least 80 centimeters from any other grounded conducting surface.
2. Connect EUT to the power mains through a line impedance stabilization network (LISN).
3. All the support units are connecting to the other LISN.
4. The LISN provides 50 ohm coupling impedance for the measuring instrument.
5. The FCC states that a 50 ohm, 50 microhenry LISN should be used.
6. Both sides of AC line were checked for maximum conducted interference.
7. The frequency range from 150 kHz to 30 MHz was searched.
8. Set the test-receiver system to Peak Detect Function and specified bandwidth (IF bandwidth = 9kHz) with Maximum Hold Mode.

### 3.6.4 Test Setup

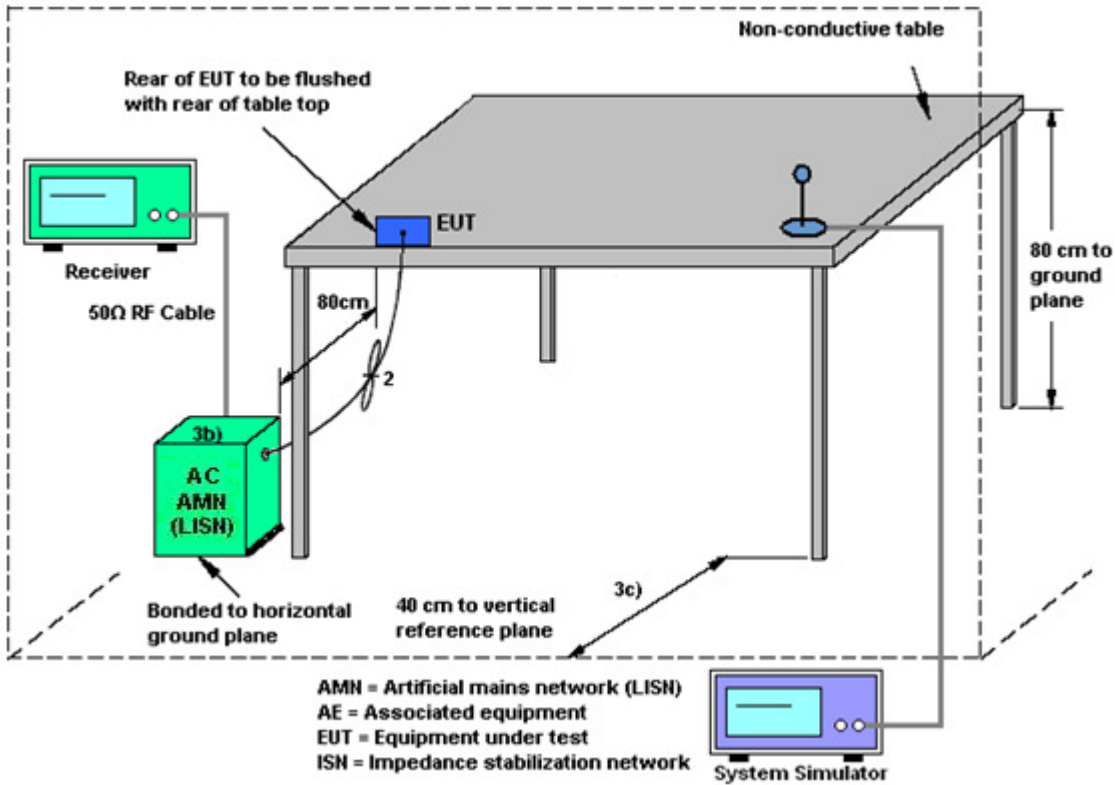



### 3.6.5 Test Result of AC Conducted Emission

Test Mode :	Mode 1	Temperature :	21~23°C
Test Engineer :	Arthur Hsieh	Relative Humidity :	50~52%
Test Voltage :	120Vac / 60Hz	Phase :	Line
Function Type :	GSM1900 Idle + Bluetooth Link + WLAN (2.4GHz) Link + MP3 + Earphone + Battery + USB Cable (Charging from Adapter)		

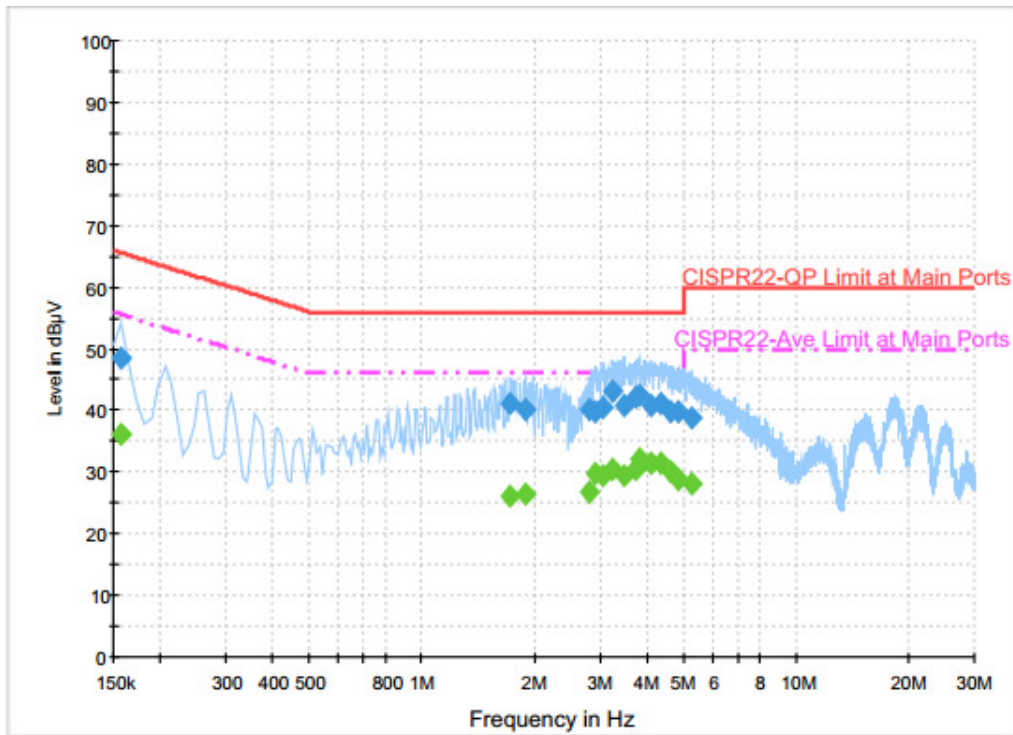

#### Final Result : Quasi-Peak

Frequency (MHz)	Quasi-Peak (dBμV)	Filter	Line	Corr. (dB)	Margin (dB)	Limit (dBμV)
0.158000	48.4	Off	L1	19.6	17.2	65.6
1.726000	41.1	Off	L1	19.6	14.9	56.0
1.886000	40.0	Off	L1	19.6	16.0	56.0
2.790000	40.1	Off	L1	19.5	15.9	56.0
2.910000	39.8	Off	L1	19.5	16.2	56.0
3.062000	40.5	Off	L1	19.6	15.5	56.0
3.246000	43.2	Off	L1	19.6	12.8	56.0
3.470000	40.9	Off	L1	19.6	15.1	56.0
3.718000	42.1	Off	L1	19.7	13.9	56.0
3.806000	42.3	Off	L1	19.7	13.7	56.0
4.118000	40.8	Off	L1	19.7	15.2	56.0
4.374000	41.1	Off	L1	19.7	14.9	56.0
4.630000	39.9	Off	L1	19.8	16.1	56.0
4.870000	39.7	Off	L1	19.8	16.3	56.0
5.286000	38.8	Off	L1	19.8	21.2	60.0



Test Mode :	Mode 1	Temperature :	21~23°C
Test Engineer :	Arthur Hsieh	Relative Humidity :	50~52%
Test Voltage :	120Vac / 60Hz	Phase :	Line
Function Type :	GSM1900 Idle + Bluetooth Link + WLAN (2.4GHz) Link + MP3 + Earphone + Battery + USB Cable (Charging from Adapter)		

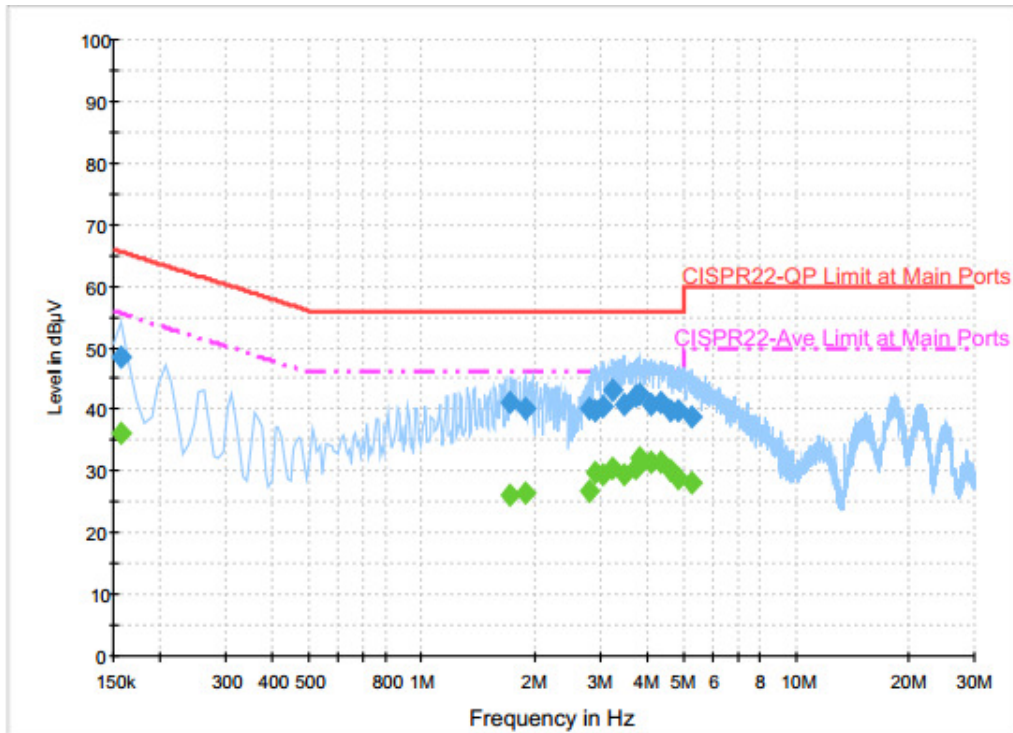

**Final Result : Average**

Frequency (MHz)	Average (dBµV)	Filter	Line	Corr. (dB)	Margin (dB)	Limit (dBµV)
0.158000	36.1	Off	L1	19.6	19.5	55.6
1.726000	26.3	Off	L1	19.6	19.7	46.0
1.886000	26.3	Off	L1	19.6	19.7	46.0
2.790000	26.9	Off	L1	19.5	19.1	46.0
2.910000	29.9	Off	L1	19.5	16.1	46.0
3.062000	29.3	Off	L1	19.6	16.7	46.0
3.246000	30.5	Off	L1	19.6	15.5	46.0
3.470000	29.5	Off	L1	19.6	16.5	46.0
3.718000	30.4	Off	L1	19.7	15.6	46.0
3.806000	32.1	Off	L1	19.7	13.9	46.0
4.118000	31.3	Off	L1	19.7	14.7	46.0
4.374000	31.4	Off	L1	19.7	14.6	46.0
4.630000	30.1	Off	L1	19.8	15.9	46.0
4.870000	28.7	Off	L1	19.8	17.3	46.0
5.286000	28.0	Off	L1	19.8	22.0	50.0



Test Mode :	Mode 1	Temperature :	21~23°C
Test Engineer :	Arthur Hsieh	Relative Humidity :	50~52%
Test Voltage :	120Vac / 60Hz	Phase :	Neutral
Function Type :	GSM1900 Idle + Bluetooth Link + WLAN (2.4GHz) Link + MP3 + Earphone + Battery + USB Cable (Charging from Adapter)		

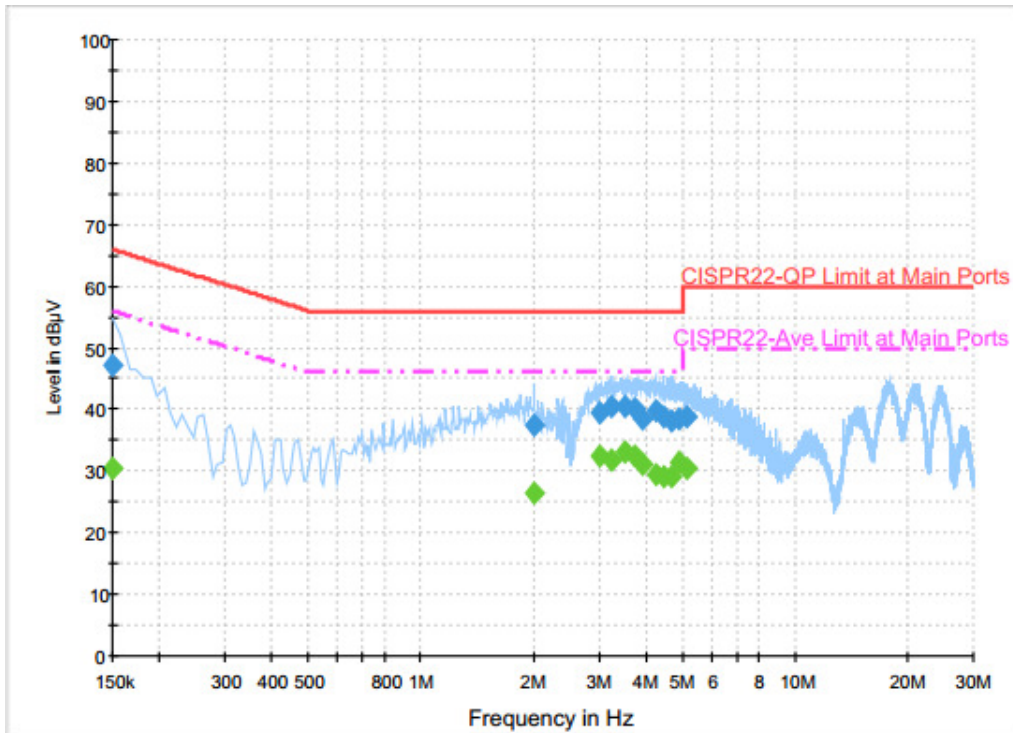

Final Result : Quasi-Peak

Frequency (MHz)	Quasi-Peak (dBµV)	Filter	Line	Corr. (dB)	Margin (dB)	Limit (dBµV)
0.150000	47.2	Off	N	19.6	18.8	66.0
2.014000	37.6	Off	N	19.6	18.4	56.0
3.014000	39.6	Off	N	19.5	16.4	56.0
3.230000	40.4	Off	N	19.6	15.6	56.0
3.534000	40.4	Off	N	19.6	15.6	56.0
3.718000	40.2	Off	N	19.7	15.8	56.0
3.894000	38.5	Off	N	19.7	17.5	56.0
4.238000	39.7	Off	N	19.7	16.3	56.0
4.446000	38.8	Off	N	19.7	17.2	56.0
4.710000	38.2	Off	N	19.7	17.8	56.0
4.886000	38.3	Off	N	19.8	17.7	56.0
5.150000	38.9	Off	N	19.8	21.1	60.0



Test Mode :	Mode 1	Temperature :	21~23°C
Test Engineer :	Arthur Hsieh	Relative Humidity :	50~52%
Test Voltage :	120Vac / 60Hz	Phase :	Neutral
Function Type :	GSM1900 Idle + Bluetooth Link + WLAN (2.4GHz) Link + MP3 + Earphone + Battery + USB Cable (Charging from Adapter)		

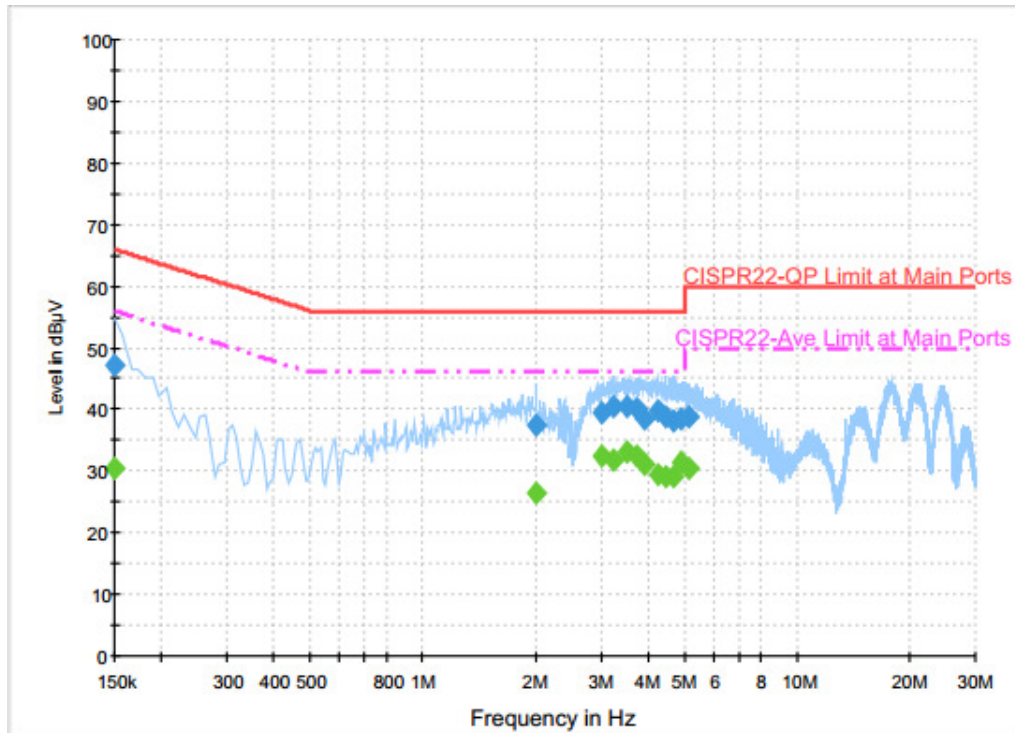

**Final Result : Average**

Frequency (MHz)	Average (dBµV)	Filter	Line	Corr. (dB)	Margin (dB)	Limit (dBµV)
0.150000	30.5	Off	N	19.6	25.5	56.0
2.014000	26.3	Off	N	19.6	19.7	46.0
3.014000	32.4	Off	N	19.5	13.6	46.0
3.230000	31.8	Off	N	19.6	14.2	46.0
3.534000	33.2	Off	N	19.6	12.8	46.0
3.718000	32.4	Off	N	19.7	13.6	46.0
3.894000	31.2	Off	N	19.7	14.8	46.0
4.238000	29.5	Off	N	19.7	16.5	46.0
4.446000	29.2	Off	N	19.7	16.8	46.0
4.710000	29.0	Off	N	19.7	17.0	46.0
4.886000	31.5	Off	N	19.8	14.5	46.0
5.150000	30.5	Off	N	19.8	19.5	50.0
0.150000	30.5	Off	N	19.6	25.5	56.0
2.014000	26.3	Off	N	19.6	19.7	46.0
3.014000	32.4	Off	N	19.5	13.6	46.0



## **3.7 Antenna Requirements**

### **3.7.1 Standard Applicable**

If directional gain of transmitting antennas is greater than 6dBi, the power shall be reduced by the same level in dB comparing to gain minus 6dBi. For the fixed point-to-point operation, the power shall be reduced by one dB for every 3 dB that the directional gain of the antenna exceeds 6 dBi. The use of a permanently attached antenna or of an antenna that uses a unique coupling to the intentional radiator shall be considered sufficient to comply with the FCC rule.

### **3.7.2 Antenna Anti-Replacement Construction**

An embedded-in antenna design is used.

### **3.7.3 Antenna Gain**

The antenna peak gain of EUT is less than 6 dBi. Therefore, it is not necessary to reduce maximum peak output power limit.



## 4 List of Measuring Equipment

Instrument	Manufacturer	Model No.	Serial No.	Characteristics	Calibration Date	Test Date	Due Date	Remark
Spectrum Analyzer	Rohde & Schwarz	FSP40	100055	9kHz-40GHz	Jul. 17, 2016	Jan. 03, 2017~ Jan. 08, 2017	Jul. 16, 2017	Conducted (TH05-HY)
Power Meter	Anritsu	ML2495A	0932001	300MHz~40GHz	Sep. 29, 2016	Jan. 03, 2017~ Jan. 08, 2017	Sep. 28, 2017	Conducted (TH05-HY)
Power Sensor	Anritsu	MA2411B	0846202	300MHz~40GHz	Sep. 29, 2016	Jan. 03, 2017~ Jan. 08, 2017	Sep. 28, 2017	Conducted (TH05-HY)
Hygrometer	Testo	608-H2	41410069	N/A	Aug. 28, 2016	Jan. 03, 2017~ Jan. 08, 2017	Aug. 27, 2017	Conducted (TH05-HY)
RF Cable	HUBER + SUHNER	SUCOFLEX 104	MY84209521	1GHz~26GHz	Dec. 02, 2016	Jan. 03, 2017~ Jan. 08, 2017	Dec. 01, 2017	Conducted (TH05-HY)
AC Power Source	ChainTek	APC-1000W	N/A	N/A	N/A	Jan. 09, 2017	N/A	Conduction (CO05-HY)
EMI Test Receiver	Rohde & Schwarz	ESCI 7	100724	9kHz~7GHz	Aug. 30, 2016	Jan. 09, 2017	Aug. 29, 2017	Conduction (CO05-HY)
Hygrometer	Testo	608-H1	34913912	N/A	Apr. 19, 2016	Jan. 09, 2017	Apr. 18, 2017	Conduction (CO05-HY)
LISN	Rohde & Schwarz	ENV216	100080	9kHz~30MHz	Nov. 29, 2016	Jan. 09, 2017	Nov. 28, 2017	Conduction (CO05-HY)
LF Cable	HUBER + SUHNER	RG-214/U	LF01	N/A	Jan. 05, 2017	Jan. 09, 2017	Jan. 04, 2018	Conduction (CO05-HY)
Test Software	N/A	EMC32	8.40.0	N/A	N/A	Jan. 09, 2017	N/A	Conduction (CO05-HY)
Loop Antenna	Rohde & Schwarz	HFH2-Z2	100488	9 kHz~30 MHz	Oct. 20, 2016	Jan. 12, 2017 ~ Jan. 16, 2017	Oct. 19, 2018	Radiation (03CH12-HY)
Bilog Antenna	TESEQ	CBL 6111D&00800N1D01N-06	37059&01	30MHz~1GHz	Oct. 15, 2016	Jan. 12, 2017 ~ Jan. 16, 2017	Oct. 14, 2017	Radiation (03CH12-HY)
Horn Antenna	SCHWARZBECK	BBHA 9120D	9120D-1328	1GHz ~ 18GHz	Oct. 25, 2016	Jan. 12, 2017 ~ Jan. 16, 2017	Oct. 24, 2017	Radiation (03CH12-HY)
SHF-EHF Horn Antenna	SCHWARZBECK	BBHA 9170	BBHA9170576	18GHz ~ 40GHz	Apr. 15, 2016	Jan. 12, 2017 ~ Jan. 16, 2017	Apr. 14, 2017	Radiation (03CH12-HY)
Spectrum Analyzer	Agilent	N9030A	MY52350276	3Hz~44GHz	Mar. 21, 2016	Jan. 12, 2017 ~ Jan. 16, 2017	Mar. 20, 2017	Radiation (03CH12-HY)
Amplifier	SONOMA	310N	187312	9kHz~1GHz	Nov. 10, 2016	Jan. 12, 2017 ~ Jan. 16, 2017	Nov. 09, 2017	Radiation (03CH12-HY)
Preamplifier	MITEQ	TTA0204	1872107	2GHz~40GHz	Feb. 15, 2016	Jan. 12, 2017 ~ Jan. 16, 2017	Feb. 14, 2017	Radiation (03CH12-HY)
Preamplifier	MITEQ	AMF-7D-00101800-30-10P	1815698	1GHz~18GHz	Dec. 01, 2016	Jan. 12, 2017 ~ Jan. 16, 2017	Nov. 30, 2017	Radiation (03CH12-HY)
Preamplifier	Keysight	83017A	MY53270195	1GHz~26.5GHz	Aug. 24, 2016	Jan. 12, 2017 ~ Jan. 16, 2017	Aug. 23, 2017	Radiation (03CH12-HY)



Instrument	Manufacturer	Model No.	Serial No.	Characteristics	Calibration Date	Test Date	Due Date	Remark
Hygrometer	TECEPEL	DTM-303B	TP140349	N/A	Nov. 14, 2016	Jan. 12, 2017 ~ Jan. 16, 2017	Nov. 13, 2017	Radiation (03CH12-HY)
RF Cable	HUBER + SUHNER	SUCOFLEX 104	MY24958/4, MY28653/4, MY9839/4P E	26GHz~40GHz	Jan. 10, 2017	Jan. 12, 2017 ~ Jan. 16, 2017	Jan. 09, 2018	Radiation (03CH12-HY)
RF Cable	HUBER + SUHNER	SUCOFLEX 104	MY24958/4, MY28653/4, MY9839/4P E	1GHz~26GHz	Jan. 10, 2017	Jan. 12, 2017 ~ Jan. 16, 2017	Jan. 09, 2018	Radiation (03CH12-HY)
RF Cable	HUBER + SUHNER	SUCOFLEX 104	MY24958/4, MY28653/4, MY9839/4P E	30MHz~1GHz	Jan. 10, 2017	Jan. 12, 2017 ~ Jan. 16, 2017	Jan. 09, 2018	Radiation (03CH12-HY)
RF Cable	HUBER + SUHNER	SUCOFLEX 104	MY24958/4, MY28653/4, MY9839/4P E	9K~30MHz	Jan. 10, 2017	Jan. 12, 2017 ~ Jan. 16, 2017	Jan. 09, 2018	Radiation (03CH12-HY)
Controller	EMEC	EM1000	N/A	Control Turn table & Ant Mast	N/A	Jan. 12, 2017 ~ Jan. 16, 2017	N/A	Radiation (03CH12-HY)
Antenna Mast	EMEC	AM-BS-450 0-B	N/A	1m~4m	N/A	Jan. 12, 2017 ~ Jan. 16, 2017	N/A	Radiation (03CH12-HY)
Turn Table	EMEC	TT2000	N/A	0~360 Degree	N/A	Jan. 12, 2017 ~ Jan. 16, 2017	N/A	Radiation (03CH12-HY)
Test Software	Audix	E3	6.2009-8-24	N/A	N/A	Jan. 12, 2017 ~ Jan. 16, 2017	N/A	Radiation (03CH12-HY)
Filter	Wainwright	WLKS1200- 12SS	SN2	1.2G Low Pass	Sep. 19, 2016	Jan. 12, 2017 ~ Jan. 16, 2017	Sep. 18, 2017	Radiation (03CH12-HY)
Filter	Microwave	H3G018G1	SN477220	3.0G High Pass	Aug. 25, 2016	Jan. 12, 2017 ~ Jan. 16, 2017	Aug. 24, 2017	Radiation (03CH12-HY)



## 5 Uncertainty of Evaluation

### Uncertainty of Conducted Emission Measurement (150 kHz ~ 30 MHz)

Measuring Uncertainty for a Level of Confidence of 95% ( $U = 2Uc(y)$ )	2.70
---	------

### Uncertainty of Radiated Emission Measurement (30 MHz ~ 1000 MHz)

Measuring Uncertainty for a Level of Confidence of 95% ( $U = 2Uc(y)$ )	5.10
---	------

### Uncertainty of Radiated Emission Measurement (1000 MHz ~ 18000 MHz)

Measuring Uncertainty for a Level of Confidence of 95% ( $U = 2Uc(y)$ )	5.20
---	------

### Uncertainty of Radiated Emission Measurement (18000 MHz ~ 40000 MHz)

Measuring Uncertainty for a Level of Confidence of 95% ( $U = 2Uc(y)$ )	4.70
---	------



**Appendix A. Test Result of Conducted Test Items**

Test Engineer:	Jeremy Lin	Temperature:	21~25	°C
Test Date:	2017/1/3~1/8	Relative Humidity:	51~54	%

**TEST RESULTS DATA**  
**6dB and 99% Occupied Bandwidth**

2.4GHz Band								
Mod.	Data Rate	N <sub>TX</sub>	CH.	Freq. (MHz)	99% Occupied BW (MHz)	6dB BW (MHz)	6dB BW Limit (MHz)	Pass/Fail
11b	1Mbps	1	1	2412	12.70	10.00	0.50	Pass
11b	1Mbps	1	6	2437	12.65	9.52	0.50	Pass
11b	1Mbps	1	11	2462	12.65	10.00	0.50	Pass
11g	6Mbps	1	1	2412	17.60	15.64	0.50	Pass
11g	6Mbps	1	6	2437	17.50	15.08	0.50	Pass
11g	6Mbps	1	11	2462	17.45	15.44	0.50	Pass
HT20	MCS0	1	1	2412	18.70	17.60	0.50	Pass
HT20	MCS0	1	6	2437	18.35	17.28	0.50	Pass
HT20	MCS0	1	11	2462	18.45	17.60	0.50	Pass

**TEST RESULTS DATA**  
**Peak Power Table**

2.4GHz Band										
Mod.	Data Rate	N <sub>TX</sub>	CH.	Freq. (MHz)	Peak Conducted Power (dBm)	Conducted Power Limit (dBm)	DG (dBi)	EIRP Power (dBm)	EIRP Power Limit (dBm)	Pass /Fail
11b	1Mbps	1	1	2412	19.37	30.00	0.70	20.07	36.00	Pass
11b	1Mbps	1	6	2437	19.72	30.00	0.70	20.42	36.00	Pass
11b	1Mbps	1	11	2462	19.20	30.00	0.70	19.90	36.00	Pass
11g	6Mbps	1	1	2412	22.86	30.00	0.70	23.56	36.00	Pass
11g	6Mbps	1	6	2437	23.17	30.00	0.70	23.87	36.00	Pass
11g	6Mbps	1	11	2462	23.10	30.00	0.70	23.80	36.00	Pass
HT20	MCS0	1	1	2412	21.31	30.00	0.70	22.01	36.00	Pass
HT20	MCS0	1	6	2437	21.24	30.00	0.70	21.94	36.00	Pass
HT20	MCS0	1	11	2462	21.25	30.00	0.70	21.95	36.00	Pass

**TEST RESULTS DATA**  
**Average Power Table**  
***(Reporting Only)***

2.4GHz Band						
Mod.	Data Rate	N <sub>TX</sub>	CH.	Freq. (MHz)	Duty Factor (dB)	Average Conducted Power (dBm)
11b	1Mbps	1	1	2412	0.00	16.39
11b	1Mbps	1	6	2437	0.00	16.78
11b	1Mbps	1	11	2462	0.00	16.27
11g	6Mbps	1	1	2412	0.15	14.36
11g	6Mbps	1	6	2437	0.15	14.85
11g	6Mbps	1	11	2462	0.15	14.75
HT20	MCS0	1	1	2412	0.13	11.49
HT20	MCS0	1	6	2437	0.13	11.43
HT20	MCS0	1	11	2462	0.13	11.48

**TEST RESULTS DATA**  
**Peak Power Density**

2.4GHz Band								
Mod.	Data Rate	N <sub>TX</sub>	CH.	Freq. (MHz)	Peak PSD (dBm /3kHz)	DG (dBi)	Peak PSD Limit (dBm /3kHz)	Pass/Fail
11b	1Mbps	1	1	2412	-6.79	0.70	8.00	Pass
11b	1Mbps	1	6	2437	-6.51	0.70	8.00	Pass
11b	1Mbps	1	11	2462	-6.21	0.70	8.00	Pass
11g	6Mbps	1	1	2412	-11.38	0.70	8.00	Pass
11g	6Mbps	1	6	2437	-10.18	0.70	8.00	Pass
11g	6Mbps	1	11	2462	-9.76	0.70	8.00	Pass
HT20	MCS0	1	1	2412	-14.91	0.70	8.00	Pass
HT20	MCS0	1	6	2437	-13.36	0.70	8.00	Pass
HT20	MCS0	1	11	2462	-14.16	0.70	8.00	Pass



## Appendix B. Radiated Spurious Emission

Test Engineer :	Nick Yu, Karl Hou, Peter Liao, and Citta Ke.	Temperature :	20~23°C
		Relative Humidity :	58~63%

### 2.4GHz 2400~2483.5MHz

#### WIFI 802.11b (Band Edge @ 3m)

WIFI Ant. 1	Note	Frequency ( MHz )	Level ( dBμV/m )	Over Limit ( dB )	Limit Line ( dBμV/m )	Read Level ( dBμV )	Antenna Factor ( dB/m )	Cable Loss ( dB )	Preamp Factor ( dB )	Ant Pos ( cm )	Table Pos ( deg )	Peak Avg. ( P/A )	Pol. ( H/V )	
802.11b CH 01 2412MHz		2353.26	55.79	-18.21	74	52.96	26.96	7.37	31.5	107	92	P	H	
		2390	44.29	-9.71	54	41.26	27.07	7.45	31.49	107	92	A	H	
	*	2412	106.79	-	-	103.69	27.14	7.45	31.49	107	92	P	H	
	*	2412	102.19	-	-	99.09	27.14	7.45	31.49	107	92	A	H	
													H	
														H
			2384.445	56.2	-17.8	74	53.19	27.05	7.45	31.49	360	46	P	V
			2390	43.97	-10.03	54	40.94	27.07	7.45	31.49	360	46	A	V
	*		2412	103.22	-	-	100.12	27.14	7.45	31.49	360	46	P	V
	*		2412	98.65	-	-	95.55	27.14	7.45	31.49	360	46	A	V
														V
														V
802.11b CH 06 2437MHz		2324.98	55.33	-18.67	74	52.67	26.87	7.3	31.51	100	88	P	H	
		2389.52	43.84	-10.16	54	40.81	27.07	7.45	31.49	100	88	A	H	
	*	2437	108.99	-	-	105.77	27.21	7.49	31.48	100	88	P	H	
	*	2437	104.35	-	-	101.13	27.21	7.49	31.48	100	88	A	H	
			2499.23	56.62	-17.38	74	53.15	27.4	7.53	31.46	100	88	P	H
			2484.67	44.24	-9.76	54	40.83	27.35	7.53	31.47	100	88	A	H
			2385.74	56.4	-17.6	74	53.38	27.06	7.45	31.49	396	64	P	V
			2389.94	43.72	-10.28	54	40.69	27.07	7.45	31.49	396	64	A	V
	*		2437	106.57	-	-	103.35	27.21	7.49	31.48	396	64	P	V
	*		2437	102	-	-	98.78	27.21	7.49	31.48	396	64	A	V
			2495.66	56.86	-17.14	74	53.4	27.39	7.53	31.46	396	64	P	V
			2484.88	44.03	-9.97	54	40.62	27.35	7.53	31.47	396	64	A	V



<b>802.11b</b> <b>CH 11</b> <b>2462MHz</b>	*	2462	106.81	-	-	103.46	27.29	7.53	31.47	128	88	P	H
	*	2462	102.13	-	-	98.78	27.29	7.53	31.47	128	88	A	H
		2486.32	57.1	-16.9	74	53.68	27.36	7.53	31.47	128	88	P	H
		2486.36	45.03	-8.97	54	41.61	27.36	7.53	31.47	128	88	A	H
													H
													H
	*	2462	104.27	-	-	100.92	27.29	7.53	31.47	345	47	P	V
	*	2462	99.6	-	-	96.25	27.29	7.53	31.47	345	47	A	V
		2485.72	56.24	-17.76	74	52.82	27.36	7.53	31.47	345	47	P	V
		2486.4	44.36	-9.64	54	40.94	27.36	7.53	31.47	345	47	A	V
													V
													V
<b>Remark</b>	1. No other spurious found. 2. All results are PASS against Peak and Average limit line.												



**2.4GHz 2400~2483.5MHz  
WIFI 802.11b (Harmonic @ 3m)**

WIFI Ant. 1	Note	Frequency ( MHz )	Level ( dBμV/m )	Over Limit ( dB )	Limit Line ( dBμV/m )	Read Level ( dBμV )	Antenna Factor ( dB/m )	Cable Loss ( dB )	Preamp Factor ( dB )	Ant Pos ( cm )	Table Pos ( deg )	Peak Avg. ( P/A )	Pol. ( H/V )
802.11b CH 01 2412MHz		4824	52.69	-21.31	74	67.91	32.18	10.74	58.14	100	188	P	H
		4824	50.29	-3.71	54	65.51	32.18	10.74	58.14	100	188	A	H
													H
													H
		4824	50.56	-23.44	74	65.78	32.18	10.74	58.14	100	145	P	V
		4824	47.89	-6.11	54	63.11	32.18	10.74	58.14	100	145	A	V
													V
													V
802.11b CH 06 2437MHz		4874	49.04	-24.96	74	63.98	32.27	10.89	58.1	100	0	P	H
		7311	44.27	-29.73	74	52.21	36.97	14.18	59.09	100	0	P	H
													H
													H
		4874	44.46	-29.54	74	59.4	32.27	10.89	58.1	100	0	P	V
		7311	44.3	-29.7	74	52.24	36.97	14.18	59.09	100	0	P	V
													V
													V
802.11b CH 11 2462MHz		4924	52.88	-21.12	74	67.54	32.36	11.04	58.06	100	181	P	H
		4924	50.55	-3.45	54	65.21	32.36	11.04	58.06	100	181	A	H
		7386	44.87	-29.13	74	52.56	37.18	14.27	59.14	100	0	P	H
													H
		4924	50.99	-23.01	74	65.65	32.36	11.04	58.06	120	145	P	V
		4924	48.35	-5.65	54	63.01	32.36	11.04	58.06	120	145	A	V
		7386	44.27	-29.73	74	51.96	37.18	14.27	59.14	100	0	P	V
													V
<b>Remark</b>	1. No other spurious found. 2. All results are PASS against Peak and Average limit line.												





**2.4GHz 2400~2483.5MHz**  
**WIFI 802.11g (Band Edge @ 3m)**

WIFI Ant. 1	Note	Frequency ( MHz )	Level ( dBμV/m )	Over Limit ( dB )	Limit Line ( dBμV/m )	Read Level ( dBμV )	Antenna Factor ( dB/m )	Cable Loss ( dB )	Preamp Factor ( dB )	Ant Pos ( cm )	Table Pos ( deg )	Peak Avg. ( P/A )	Pol. ( H/V )	
802.11g CH 01 2412MHz		2390	62.25	-11.75	74	59.22	27.07	7.45	31.49	100	91	P	H	
		2390	49.06	-4.94	54	46.03	27.07	7.45	31.49	100	91	A	H	
	*	2412	106.03	-	-	102.93	27.14	7.45	31.49	100	91	P	H	
	*	2412	96.47	-	-	93.37	27.14	7.45	31.49	100	91	A	H	
													H	
														H
			2389.8	62.28	-11.72	74	59.25	27.07	7.45	31.49	318	64	P	V
			2390	46.84	-7.16	54	43.81	27.07	7.45	31.49	318	64	A	V
	*		2412	102.25	-	-	99.15	27.14	7.45	31.49	318	64	P	V
	*		2412	92.37	-	-	89.27	27.14	7.45	31.49	318	64	A	V
														V
														V
802.11g CH 06 2437MHz		2336.88	56.31	-17.69	74	53.61	26.91	7.3	31.51	100	87	P	H	
		2389.66	44.74	-9.26	54	41.71	27.07	7.45	31.49	100	87	A	H	
	*	2437	107.88	-	-	104.66	27.21	7.49	31.48	100	87	P	H	
	*	2437	98.21	-	-	94.99	27.21	7.49	31.48	100	87	A	H	
			2490.13	56.21	-17.79	74	52.78	27.37	7.53	31.47	100	87	P	H
			2489.43	45.52	-8.48	54	42.09	27.37	7.53	31.47	100	87	A	H
			2327.64	55.69	-18.31	74	53.02	26.88	7.3	31.51	395	63	P	V
			2388.82	44.5	-9.5	54	41.47	27.07	7.45	31.49	395	63	A	V
	*		2437	105.62	-	-	102.4	27.21	7.49	31.48	395	63	P	V
	*		2437	95.62	-	-	92.4	27.21	7.49	31.48	395	63	A	V
			2487.75	56.09	-17.91	74	52.67	27.36	7.53	31.47	395	63	P	V
			2487.19	45.04	-8.96	54	41.62	27.36	7.53	31.47	395	63	A	V



<b>802.11g CH 11 2462MHz</b>	*	2462	108.63	-	-	105.28	27.29	7.53	31.47	120	85	P	H
	*	2462	98.38	-	-	95.03	27.29	7.53	31.47	120	85	A	H
		2483.68	66.07	-7.93	74	62.66	27.35	7.53	31.47	120	85	P	H
		2483.52	49.49	-4.51	54	46.08	27.35	7.53	31.47	120	85	A	H
													H
													H
	*	2462	103.76	-	-	100.41	27.29	7.53	31.47	389	65	P	V
	*	2462	94.84	-	-	91.49	27.29	7.53	31.47	389	65	A	V
		2483.84	63.66	-10.34	74	60.25	27.35	7.53	31.47	389	65	P	V
		2483.64	47.54	-6.46	54	44.13	27.35	7.53	31.47	389	65	A	V
													V
													V
<b>Remark</b>	1. No other spurious found. 2. All results are PASS against Peak and Average limit line.												



**2.4GHz 2400~2483.5MHz  
WIFI 802.11g (Harmonic @ 3m)**

WIFI Ant. 1	Note	Frequency ( MHz )	Level ( dBμV/m )	Over Limit ( dB )	Limit Line ( dBμV/m )	Read Level ( dBμV )	Antenna Factor ( dB/m )	Cable Loss ( dB )	Preamp Factor ( dB )	Ant Pos ( cm )	Table Pos ( deg )	Peak Avg. ( P/A )	Pol. ( H/V )	
802.11g CH 01 2412MHz		4824	55.1	-18.9	74	70.32	32.18	10.74	58.14	100	213	P	H	
		4824	40.09	-13.91	54	55.31	32.18	10.74	58.14	100	213	A	H	
													H	
													H	
		4824	44.34	-29.66	74	59.56	32.18	10.74	58.14	100	0	P	V	
														V
														V
802.11g CH 06 2437MHz		4874	46.46	-27.54	74	61.4	32.27	10.89	58.1	100	0	P	H	
		7311	42.92	-31.08	74	50.86	36.97	14.18	59.09	100	0	P	H	
													H	
													H	
		4874	40.9	-33.1	74	55.84	32.27	10.89	58.1	100	0	P	V	
		7311	42.69	-31.31	74	50.63	36.97	14.18	59.09	100	0	P	V	
														V
802.11g CH 11 2462MHz		4924	51.03	-22.97	74	65.69	32.36	11.04	58.06	100	0	P	H	
		7386	42.96	-31.04	74	50.65	37.18	14.27	59.14	100	0	P	H	
													H	
													H	
		4924	44.41	-29.59	74	59.07	32.36	11.04	58.06	100	0	P	V	
		7386	42.97	-31.03	74	50.66	37.18	14.27	59.14	100	0	P	V	
														V
Remark	1. No other spurious found.													
	2. All results are PASS against Peak and Average limit line.													



**2.4GHz 2400~2483.5MHz  
WIFI 802.11n HT20 (Band Edge @ 3m)**

WIFI Ant. 1	Note	Frequency ( MHz )	Level ( dBμV/m )	Over Limit ( dB )	Limit Line ( dBμV/m )	Read Level ( dBμV )	Antenna Factor ( dB/m )	Cable Loss ( dB )	Preamp Factor ( dB )	Ant Pos ( cm )	Table Pos ( deg )	Peak Avg. ( P/A )	Pol. ( H/V )	
802.11n HT20 CH 01 2412MHz		2389.065	60.47	-13.53	74	57.44	27.07	7.45	31.49	101	90	P	H	
		2389.8	47.28	-6.72	54	44.25	27.07	7.45	31.49	101	90	A	H	
	*	2412	105.28	-	-	102.18	27.14	7.45	31.49	101	90	P	H	
	*	2412	95.09	-	-	91.99	27.14	7.45	31.49	101	90	A	H	
													H	
														H
			2388.96	57.72	-16.28	74	54.69	27.07	7.45	31.49	316	64	P	V
			2389.905	45.67	-8.33	54	42.64	27.07	7.45	31.49	316	64	A	V
		*	2412	101.32	-	-	98.22	27.14	7.45	31.49	316	64	P	V
		*	2412	91.03	-	-	87.93	27.14	7.45	31.49	316	64	A	V
													V	
													V	
802.11n HT20 CH 06 2437MHz		2363.06	55.9	-18.1	74	53.04	26.99	7.37	31.5	100	87	P	H	
		2370.34	44.65	-9.35	54	41.76	27.01	7.37	31.49	100	87	A	H	
	*	2437	104.09	-	-	100.87	27.21	7.49	31.48	100	87	P	H	
	*	2437	93.97	-	-	90.75	27.21	7.49	31.48	100	87	A	H	
			2497.69	56.2	-17.8	74	52.74	27.39	7.53	31.46	100	87	P	H
			2488.45	45.07	-8.93	54	41.64	27.37	7.53	31.47	100	87	A	H
			2381.26	55.87	-18.13	74	52.87	27.04	7.45	31.49	395	64	P	V
			2386.86	44.72	-9.28	54	41.7	27.06	7.45	31.49	395	64	A	V
		*	2437	102.1	-	-	98.88	27.21	7.49	31.48	395	64	P	V
		*	2437	92.17	-	-	88.95	27.21	7.49	31.48	395	64	A	V
		2484.67	55.93	-18.07	74	52.52	27.35	7.53	31.47	395	64	P	V	
		2483.83	44.89	-9.11	54	41.48	27.35	7.53	31.47	395	64	A	V	



<b>802.11n HT20 CH 11 2462MHz</b>	*	2462	104.85	-	-	101.5	27.29	7.53	31.47	146	86	P	H
	*	2462	94.91	-	-	91.56	27.29	7.53	31.47	146	86	A	H
		2484.12	64.62	-9.38	74	61.21	27.35	7.53	31.47	146	86	P	H
		2483.8	47.03	-6.97	54	43.62	27.35	7.53	31.47	146	86	A	H
													H
													H
	*	2462	100.89	-	-	97.54	27.29	7.53	31.47	383	61	P	V
	*	2462	91.97	-	-	88.62	27.29	7.53	31.47	383	61	A	V
		2483.72	60.78	-13.22	74	57.37	27.35	7.53	31.47	383	61	P	V
		2484.04	46.5	-7.5	54	43.09	27.35	7.53	31.47	383	61	A	V
												V	
												V	
<b>Remark</b>	<ol style="list-style-type: none"> <li>No other spurious found.</li> <li>All results are PASS against Peak and Average limit line.</li> </ol>												



**2.4GHz 2400~2483.5MHz  
WIFI 802.11n HT20 (Harmonic @ 3m)**

WIFI Ant. 1	Note	Frequency ( MHz )	Level ( dBμV/m )	Over Limit ( dB )	Limit Line ( dBμV/m )	Read Level ( dBμV )	Antenna Factor ( dB/m )	Cable Loss ( dB )	Preamp Factor ( dB )	Ant Pos ( cm )	Table Pos ( deg )	Peak Avg. ( P/A )	Pol. ( H/V )	
802.11n HT20 CH 01 2412MHz		4824	46.33	-27.67	74	61.55	32.18	10.74	58.14	100	0	P	H	
													H	
													H	
													H	
			4824	40.87	-33.13	74	56.09	32.18	10.74	58.14	100	0	P	V
														V
														V
802.11n HT20 CH 06 2437MHz		4874	39.86	-34.14	74	54.8	32.27	10.89	58.1	100	0	P	H	
		7311	43.45	-30.55	74	51.39	36.97	14.18	59.09	100	0	P	H	
													H	
													H	
			4874	38.49	-35.51	74	53.43	32.27	10.89	58.1	100	0	P	V
			7311	43.44	-30.56	74	51.38	36.97	14.18	59.09	100	0	P	V
														V
802.11n HT20 CH 11 2462MHz		4924	44.8	-29.2	74	59.46	32.36	11.04	58.06	100	0	P	H	
		7386	43.9	-30.1	74	51.59	37.18	14.27	59.14	100	0	P	H	
													H	
													H	
			4924	41.4	-32.6	74	56.06	32.36	11.04	58.06	100	0	P	V
			7386	43.59	-30.41	74	51.28	37.18	14.27	59.14	100	0	P	V
														V
Remark	1. No other spurious found.													
	2. All results are PASS against Peak and Average limit line.													



2.4GHz 2400~2483.5MHz

Emission below 1GHz

2.4GHz WIFI 802.11b (LF)

WIFI Ant.	Note	Frequency	Level	Over Limit	Limit Line	Read Level	Antenna Factor	Cable Loss	Preamp Factor	Ant Pos	Table Pos	Peak Avg.	Pol.
1		( MHz )	( dBμV/m )	( dB )	( dBμV/m )	( dBμV )	( dB/m )	( dB )	( dB )	( cm )	( deg )	( P/A )	( H/V )
		30.27	23.56	-16.44	40	29.44	25.8	0.78	32.46			P	H
		152.58	30.53	-12.97	43.5	43.8	17.4	1.75	32.42			P	H
		245.73	24.76	-21.24	46	37.17	18.09	1.83	32.33			P	H
		340.6	30.04	-15.96	46	39.18	20.71	2.44	32.29			P	H
		746.6	38.22	-7.78	46	39.03	27.53	3.97	32.31	100	0	P	H
		952.4	33.18	-12.82	46	29.27	30.27	4.75	31.11			P	H
													H
													H
													H
													H
													H
2.4GHz													H
802.11b													H
LF		42.69	32.23	-7.77	40	45.29	18.62	0.78	32.46	100	0	P	V
		90.48	24.08	-19.42	43.5	40.66	14.8	1.06	32.44			P	V
		147.99	22.43	-21.07	43.5	35.55	17.55	1.75	32.42			P	V
		464.5	26.07	-19.93	46	32.02	23.36	3.08	32.39			P	V
		746.6	37.69	-8.31	46	38.5	27.53	3.97	32.31			P	V
		963.6	32.95	-21.05	54	29.07	30.14	4.75	31.01			P	V
													V
													V
													V
													V
													V
													V
													V
													V
Remark	1. No other spurious found. 2. All results are PASS against limit line.												



Emission below 1GHz  
2.4GHz WIFI 802.11g (LF)

WIFI	Note	Frequency	Level	Over	Limit	Read	Antenna	Cable	Preamp	Ant	Table	Peak	Pol.	
Ant.				Limit	Line	Level	Factor	Loss	Factor	Pos	Pos	Avg.		
1		( MHz )	( dBμV/m )	( dB )	( dBμV/m )	( dBμV )	( dB/m )	( dB )	( dB )	( cm )	( deg )	(P/A)	(H/V)	
2.4GHz 802.11g LF		31.35	23.34	-16.66	40	29.76	25.26	0.78	32.46			P	H	
		147.99	30.88	-12.62	43.5	44	17.55	1.75	32.42	100	0	P	H	
		196.59	26.01	-17.49	43.5	41.07	15.65	1.7	32.41			P	H	
		340.6	30.51	-15.49	46	39.65	20.71	2.44	32.29			P	H	
		746.6	31.86	-14.14	46	32.67	27.53	3.97	32.31			P	H	
		953.8	33.03	-12.97	46	29.12	30.25	4.75	31.09			P	H	
													H	
													H	
													H	
													H	
													H	
													H	
			42.42	32	-8	40	45.06	18.62	0.78	32.46			P	V
			85.62	28.69	-11.31	40	45.82	14.25	1.06	32.44			P	V
			98.58	29.89	-13.61	43.5	45.38	15.88	1.06	32.43			P	V
			650.7	28.28	-17.72	46	31.07	26.01	3.61	32.41			P	V
			746.6	38.99	-7.01	46	39.8	27.53	3.97	32.31	100	0	P	V
			939.1	33.05	-12.95	46	29.68	30	4.6	31.23			P	V
													V	
													V	
												V		
												V		
												V		
												V		
<b>Remark</b>	1. No other spurious found. 2. All results are PASS against limit line.													





Emission below 1GHz

2.4GHz WIFI 802.11n HT20 (LF)

WIFI	Note	Frequency	Level	Over	Limit	Read	Antenna	Cable	Preamp	Ant	Table	Peak	Pol.	
Ant.				Limit	Line	Level	Factor	Loss	Factor	Pos	Pos	Avg.		
1		( MHz )	( dBμV/m )	( dB )	( dBμV/m )	( dBμV )	( dB/m )	( dB )	( dB )	( cm )	( deg )	(P/A)	(H/V)	
2.4GHz 802.11n HT20 LF		30.81	23.42	-16.58	40	29.84	25.26	0.78	32.46			P	H	
		149.61	31.15	-12.35	43.5	44.29	17.53	1.75	32.42	100	0	P	H	
		243.57	25.6	-20.4	46	38.17	17.93	1.83	32.33			P	H	
		345.5	31.18	-14.82	46	40.17	20.86	2.44	32.29			P	H	
		747.3	31.94	-14.06	46	32.75	27.53	3.97	32.31			P	H	
		941.2	33.31	-12.69	46	29.72	30.05	4.75	31.21			P	H	
														H
														H
														H
														H
														H
														H
			43.5	32.24	-7.76	40	45.86	18.06	0.78	32.46	100	0	P	V
			97.77	24.01	-19.49	43.5	39.62	15.76	1.06	32.43			P	V
			120.45	32.1	-11.4	43.5	45.5	17.6	1.43	32.43			P	V
			435.8	25.35	-20.65	46	32	22.84	2.89	32.38			P	V
			866.3	31.34	-14.66	46	29.97	28.7	4.45	31.78			P	V
			934.9	32.97	-13.03	46	29.74	29.89	4.6	31.26			P	V
													V	
													V	
													V	
													V	
													V	
													V	
<b>Remark</b>	1. No other spurious found. 2. All results are PASS against limit line.													



**Note symbol**

*	<b>Fundamental Frequency</b> which can be ignored. However, the level of any unwanted emissions shall not exceed the level of the fundamental frequency.
!	Test result is <b>over limit</b> line.
P/A	<b>Peak</b> or <b>Average</b>
H/V	<b>Horizontal</b> or <b>Vertical</b>



A calculation example for radiated spurious emission is shown as below:

WIFI	Note	Frequency	Level	Over	Limit	Read	Antenna	Cable	Preamp	Ant	Table	Peak	Pol.
Ant.				Limit	Line	Level	Factor	Loss	Factor	Pos	Pos	Avg.	
1		( MHz )	( dBμV/m )	( dB )	( dBμV/m )	( dBμV )	( dB/m )	( dB )	( dB )	( cm )	( deg )	( P/A )	( H/V )
802.11b		2390	55.45	-18.55	74	54.51	32.22	4.58	35.86	103	308	P	H
CH 01													
2412MHz		2390	43.54	-10.46	54	42.6	32.22	4.58	35.86	103	308	A	H

- Level(dBμV/m) =  
Antenna Factor(dB/m) + Cable Loss(dB) + Read Level(dBμV) - Preamp Factor(dB)
- Over Limit(dB) = Level(dBμV/m) – Limit Line(dBμV/m)

**For Peak Limit @ 2390MHz:**

- Level(dBμV/m)  
= Antenna Factor(dB/m) + Cable Loss(dB) + Read Level(dBμV) - Preamp Factor(dB)  
= 32.22(dB/m) + 4.58(dB) + 54.51(dBμV) – 35.86 (dB)  
= 55.45 (dBμV/m)
- Over Limit(dB)  
= Level(dBμV/m) – Limit Line(dBμV/m)  
= 55.45(dBμV/m) – 74(dBμV/m)  
= -18.55(dB)

**For Average Limit @ 2390MHz:**

- Level(dBμV/m)  
= Antenna Factor(dB/m) + Cable Loss(dB) + Read Level(dBμV) - Preamp Factor(dB)  
= 32.22(dB/m) + 4.58(dB) + 42.6(dBμV) – 35.86 (dB)  
= 43.54 (dBμV/m)
- Over Limit(dB)  
= Level(dBμV/m) – Limit Line(dBμV/m)  
= 43.54(dBμV/m) – 54(dBμV/m)  
= -10.46(dB)

Both peak and average measured complies with the limit line, so test result is “PASS”.



## Appendix C. Radiated Spurious Emission Plots

<b>Test Engineer :</b>	Nick Yu, Karl Hou, Peter Liao, and Citta Ke.	<b>Temperature :</b>	20~23°C
		<b>Relative Humidity :</b>	58~63%

### Note symbol

-L	Low channel location
-R	High channel location



2.4GHz 2400~2483.5MHz  
WIFI 802.11b (Band Edge @ 3m)

WIFI	2.4GHz 2400~2483.5MHz Band Edge @ 3m	
ANT	802.11b CH01 2412MHz	
1	Horizontal	Fundamental
Peak	<p>Site Condition : 03CH12-HY : PEAK_BE_74 3m HORN_9120D_1328 HORIZONTAL : RBW:1000.000KHz VBW:3000.000KHz SWT:Auto</p>	<p>Site Condition : 03CH12-HY : PEAK_74 3m HORN_9120D_1328 HORIZONTAL : RBW:1000.000KHz VBW:3000.000KHz SWT:Auto</p>
Avg.	<p>Site Condition : 03CH12-HY : AVG_BE_54 3m HORN_9120D_1328 HORIZONTAL : RBW:1000.000KHz VBW:0.010KHz SWT:Auto</p>	<p>Site Condition : 03CH12-HY : AVG_54 3m HORN_9120D_1328 HORIZONTAL : RBW:1000.000KHz VBW:0.010KHz SWT:Auto</p>

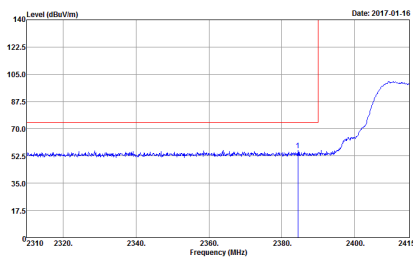
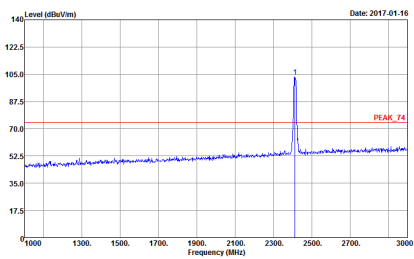
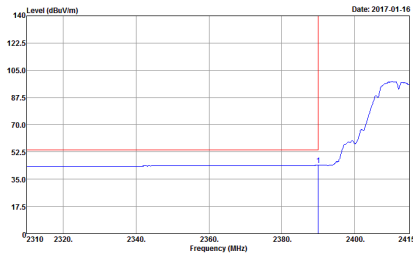
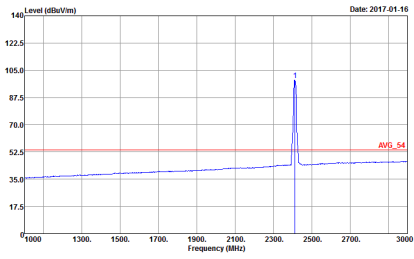

WIFI	2.4GHz 2400~2483.5MHz Band Edge @ 3m	
ANT	802.11b CH01 2412MHz	
1	Vertical	Fundamental
Peak	 <p>Level (dBu/m)</p> <p>Frequency (MHz)</p> <p>Date: 2017.01.16</p> <p>Site Condition : 03CH12-HY : PEAK_BE_74 3m HORN_9120D_1328 VERTICAL : RBW:1000.000KHz VBW:3000.000KHz SWT:Auto</p>	 <p>Level (dBu/m)</p> <p>Frequency (MHz)</p> <p>Date: 2017.01.16</p> <p>Site Condition : 03CH12-HY : PEAK_74 3m HORN_9120D_1328 VERTICAL : RBW:1000.000KHz VBW:3000.000KHz SWT:Auto</p>
Avg.	 <p>Level (dBu/m)</p> <p>Frequency (MHz)</p> <p>Date: 2017.01.16</p> <p>Site Condition : 03CH12-HY : AVG_BE_54 3m HORN_9120D_1328 VERTICAL : RBW:1000.000KHz VBW:0.010KHz SWT:Auto</p>	 <p>Level (dBu/m)</p> <p>Frequency (MHz)</p> <p>Date: 2017.01.16</p> <p>Site Condition : 03CH12-HY : AVG_54 3m HORN_9120D_1328 VERTICAL : RBW:1000.000KHz VBW:0.010KHz SWT:Auto</p>

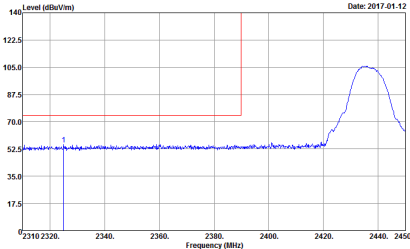
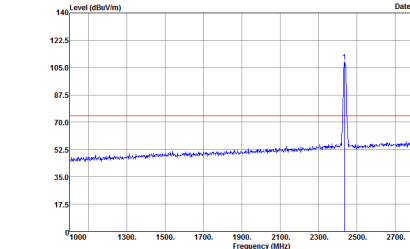
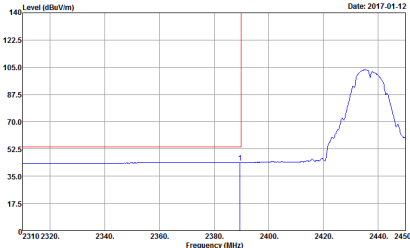
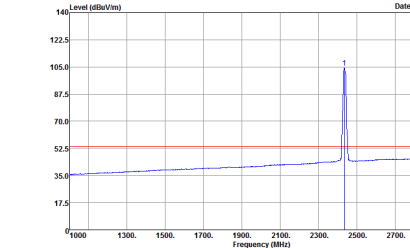

WIFI	2.4GHz 2400~2483.5MHz Band Edge @ 3m	
ANT	802.11b CH06 2437MHz - L	
1	Horizontal	Fundamental
Peak	 <p>Level (dBuV/m) vs Frequency (MHz) plot showing a peak at approximately 2437 MHz. The y-axis ranges from 0 to 140 dBuV/m, and the x-axis ranges from 2310 to 2450 MHz. A red vertical line is at 2437 MHz. The peak level is approximately 105 dBuV/m.</p> <p>Date: 2017.01.12</p> <p>Site Condition : :03CH12-HY : PEAK_BE_74 3m HORN_9120D_1328 HORIZONTAL : RBW:1000.000KHz VBW:3000.000KHz SWT:Auto</p>	 <p>Level (dBuV/m) vs Frequency (MHz) plot showing a sharp peak at approximately 2437 MHz. The y-axis ranges from 0 to 140 dBuV/m, and the x-axis ranges from 1000 to 3000 MHz. A red horizontal line is at approximately 70 dBuV/m, labeled 'PEAK_74'. The peak level is approximately 105 dBuV/m.</p> <p>Date: 2017.01.12</p> <p>Site Condition : :03CH12-HY : PEAK_74 3m HORN_9120D_1328 HORIZONTAL : RBW:1000.000KHz VBW:3000.000KHz SWT:Auto</p>
Avg.	 <p>Level (dBuV/m) vs Frequency (MHz) plot showing an average spectrum with a peak at approximately 2437 MHz. The y-axis ranges from 0 to 140 dBuV/m, and the x-axis ranges from 2310 to 2450 MHz. A red vertical line is at 2437 MHz. The peak level is approximately 105 dBuV/m.</p> <p>Date: 2017.01.12</p> <p>Site Condition : :03CH12-HY : AVG_BE_54 3m HORN_9120D_1328 HORIZONTAL : RBW:1000.000KHz VBW:0.010KHz SWT:Auto</p>	 <p>Level (dBuV/m) vs Frequency (MHz) plot showing an average spectrum with a sharp peak at approximately 2437 MHz. The y-axis ranges from 0 to 140 dBuV/m, and the x-axis ranges from 1000 to 3000 MHz. A red horizontal line is at approximately 54 dBuV/m, labeled 'AVG_54'. The peak level is approximately 105 dBuV/m.</p> <p>Date: 2017.01.12</p> <p>Site Condition : :03CH12-HY : AVG_54 3m HORN_9120D_1328 HORIZONTAL : RBW:1000.000KHz VBW:0.010KHz SWT:Auto</p>



WIFI	2.4GHz 2400~2483.5MHz Band Edge @ 3m	
ANT	802.11b CH06 2437MHz - R	
1	Horizontal	Fundamental
Peak	<p>Site Condition : :03CH12-HY :PEAK_BE_74 3m HORN_9120D_1328 HORIZONTAL :RBW:1000.000kHz VBW:3000.000kHz SWT:Auto</p>	Left blank
Avg.	<p>Site Condition : :03CH12-HY :AVG_BE_54 3m HORN_9120D_1328 HORIZONTAL :RBW:1000.000kHz VBW:0.010kHz SWT:Auto</p>	Left blank



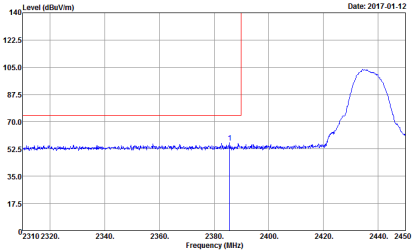
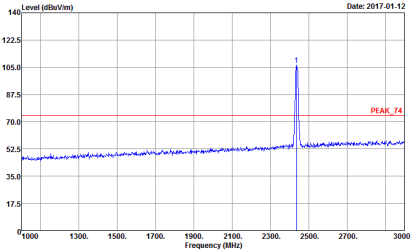
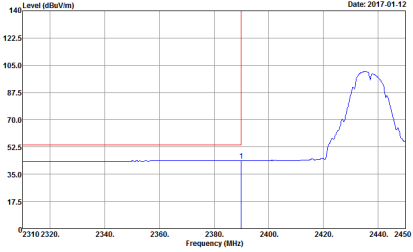
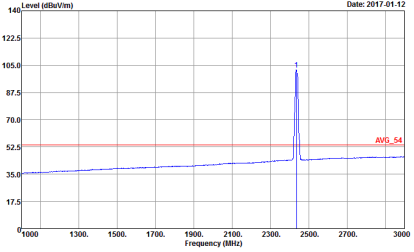

WIFI	2.4GHz 2400~2483.5MHz Band Edge @ 3m	
ANT	802.11b CH06 2437MHz - L	
1	<p style="text-align: center;"><b>Vertical</b></p>  <p><b>Peak</b></p> <p>Site Condition : :03CH12-HY : PEAK_BE_74 3m HORN_9120D_1328 VERTICAL : RBW:1000.000KHz VBW:3000.000KHz SWT:Auto</p>	<p style="text-align: center;"><b>Fundamental</b></p>  <p><b>PEAK_74</b></p> <p>Site Condition : :03CH12-HY : PEAK_74 3m HORN_9120D_1328 VERTICAL : RBW:1000.000KHz VBW:3000.000KHz SWT:Auto</p>
Avg.	 <p><b>Avg.</b></p> <p>Site Condition : :03CH12-HY : AVG_BE_54 3m HORN_9120D_1328 VERTICAL : RBW:1000.000KHz VBW:0.010KHz SWT:Auto</p>	 <p><b>AVG_54</b></p> <p>Site Condition : :03CH12-HY : AVG_54 3m HORN_9120D_1328 VERTICAL : RBW:1000.000KHz VBW:0.010KHz SWT:Auto</p>



WIFI	2.4GHz 2400~2483.5MHz Band Edge @ 3m	
ANT	802.11b CH06 2437MHz - R	
1	Vertical	Fundamental
Peak	<p>Site Condition : :03CH12-HY : PEAK_BE_74 3m HORN_9120D_1328 VERTICAL : RBW:1000.000KHz VBW:3000.000KHz SWT:Auto</p>	Left blank
Avg.	<p>Site Condition : :03CH12-HY : AVG_BE_54 3m HORN_9120D_1328 VERTICAL : RBW:1000.000KHz VBW:0.010KHz SWT:Auto</p>	Left blank

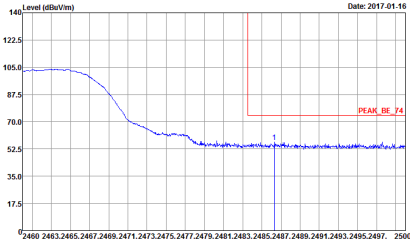
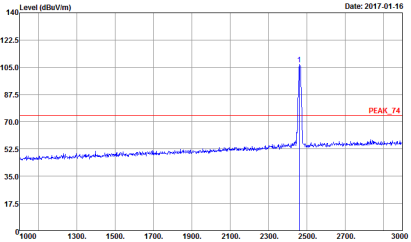
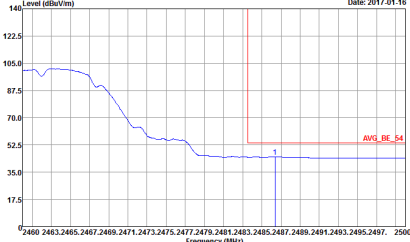
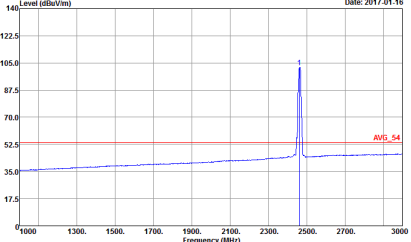

WIFI	2.4GHz 2400~2483.5MHz Band Edge @ 3m	
ANT	802.11b CH11 2462MHz	
1	Horizontal	Fundamental
Peak	 <p>Date: 2017.01.16</p> <p>Site Condition : :03CH12-HY : PEAK_BE_74 3m HORN_9120D_1328 HORIZONTAL : RBW:1000.000kHz VBW:3000.000kHz SWT:Auto</p>	 <p>Date: 2017.01.16</p> <p>Site Condition : :03CH12-HY : PEAK_74 3m HORN_9120D_1328 HORIZONTAL : RBW:1000.000kHz VBW:3000.000kHz SWT:Auto</p>
Avg.	 <p>Date: 2017.01.16</p> <p>Site Condition : :03CH12-HY : AVG_BE_54 3m HORN_9120D_1328 HORIZONTAL : RBW:1000.000kHz VBW:0.010kHz SWT:Auto</p>	 <p>Date: 2017.01.16</p> <p>Site Condition : :03CH12-HY : AVG_54 3m HORN_9120D_1328 HORIZONTAL : RBW:1000.000kHz VBW:0.010kHz SWT:Auto</p>

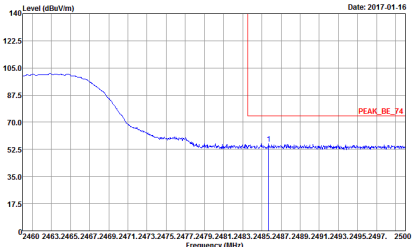
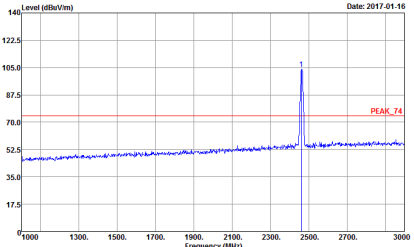
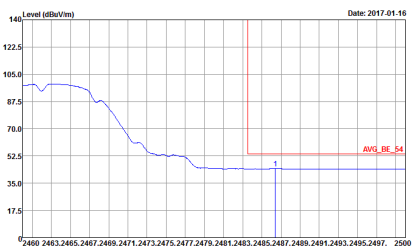
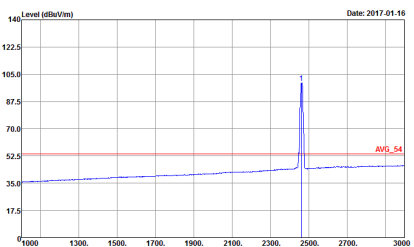

WIFI	2.4GHz 2400~2483.5MHz Band Edge @ 3m	
ANT	802.11b CH11 2462MHz	
1	Vertical	Fundamental
Peak	 <p>Date: 2017-01-16</p> <p>Site Condition : :03CH12-HY : PEAK_BE_74 3m HORN_9120D_1328 VERTICAL : RBW:1000.000KHz VBW:3000.000KHz SWT:Auto</p>	 <p>Date: 2017-01-16</p> <p>Site Condition : :03CH12-HY : PEAK_74 3m HORN_9120D_1328 VERTICAL : RBW:1000.000KHz VBW:3000.000KHz SWT:Auto</p>
Avg.	 <p>Date: 2017-01-16</p> <p>Site Condition : :03CH12-HY : AVG_BE_54 3m HORN_9120D_1328 VERTICAL : RBW:1000.000KHz VBW:0.010KHz SWT:Auto</p>	 <p>Date: 2017-01-16</p> <p>Site Condition : :03CH12-HY : AVG_54 3m HORN_9120D_1328 VERTICAL : RBW:1000.000KHz VBW:0.010KHz SWT:Auto</p>

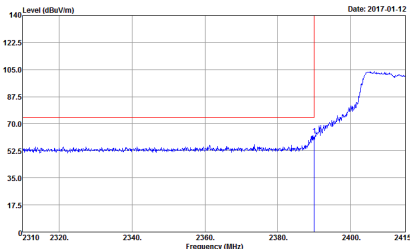
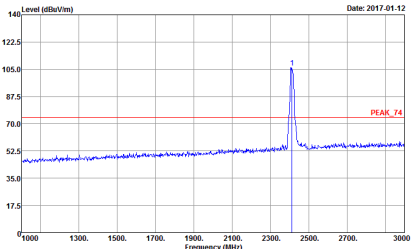
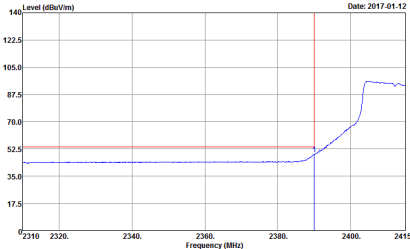
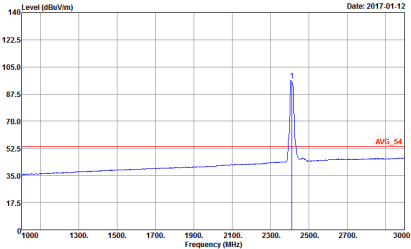

2.4GHz 2400~2483.5MHz  
WIFI 802.11g (Band Edge @ 3m)

WIFI	2.4GHz 2400~2483.5MHz Band Edge @ 3m	
ANT	802.11g CH01 2412MHz	
1	Horizontal	Fundamental
Peak	 <p>Site Condition : 03CH12-HY : PEAK_BE_74 3m HORN_9120D_1328 HORIZONTAL : RBW:1000.000KHz VBW:3000.000KHz SWT:Auto</p>	 <p>Site Condition : 03CH12-HY : PEAK_74 3m HORN_9120D_1328 HORIZONTAL : RBW:1000.000KHz VBW:3000.000KHz SWT:Auto</p>
Avg.	 <p>Site Condition : 03CH12-HY : AVG_BE_54 3m HORN_9120D_1328 HORIZONTAL : RBW:1000.000KHz VBW:1.000KHz SWT:Auto</p>	 <p>Site Condition : 03CH12-HY : AVG_54 3m HORN_9120D_1328 HORIZONTAL : RBW:1000.000KHz VBW:1.000KHz SWT:Auto</p>

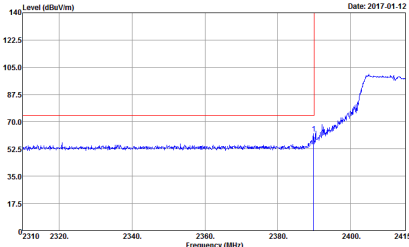
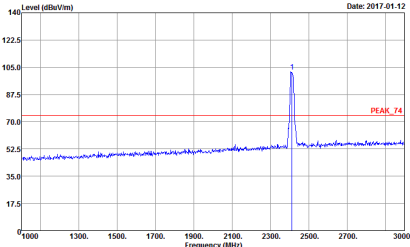
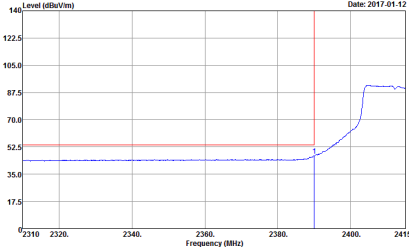
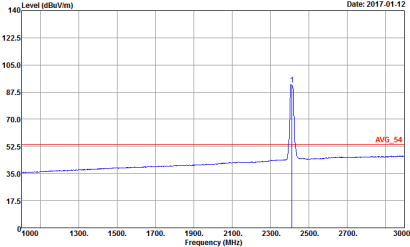

WIFI	2.4GHz 2400~2483.5MHz Band Edge @ 3m	
ANT	802.11g CH01 2412MHz	
1	<p style="text-align: center;"><b>Vertical</b></p>  <p>Level (dBu/m) vs Frequency (MHz) plot showing a peak at approximately 2412 MHz. The y-axis ranges from 0 to 140 dBu/m, and the x-axis ranges from 2310 to 2415 MHz. A red vertical line marks the peak frequency.</p> <p>Site Condition : 03CH12-HY : PEAK_BE_74 3m HORN_9120D_1328 VERTICAL : RBW:1000.000KHz VBW:3000.000KHz SWT:Auto</p>	<p style="text-align: center;"><b>Fundamental</b></p>  <p>Level (dBu/m) vs Frequency (MHz) plot showing a sharp peak at approximately 2412 MHz. The y-axis ranges from 0 to 140 dBu/m, and the x-axis ranges from 1000 to 3000 MHz. A red horizontal line indicates the peak level, labeled 'PEAK_74'.</p> <p>Site Condition : 03CH12-HY : PEAK_74 3m HORN_9120D_1328 VERTICAL : RBW:1000.000KHz VBW:3000.000KHz SWT:Auto</p>
Avg.	 <p>Level (dBu/m) vs Frequency (MHz) plot showing the average spectrum for the vertical polarization. The y-axis ranges from 0 to 140 dBu/m, and the x-axis ranges from 2310 to 2415 MHz. A red vertical line marks the peak frequency.</p> <p>Site Condition : 03CH12-HY : AVG_BE_54 3m HORN_9120D_1328 VERTICAL : RBW:1000.000KHz VBW:1.000KHz SWT:Auto</p>	 <p>Level (dBu/m) vs Frequency (MHz) plot showing the average spectrum for the fundamental component. The y-axis ranges from 0 to 140 dBu/m, and the x-axis ranges from 1000 to 3000 MHz. A red horizontal line indicates the average peak level, labeled 'AVG_54'.</p> <p>Site Condition : 03CH12-HY : AVG_54 3m HORN_9120D_1328 VERTICAL : RBW:1000.000KHz VBW:1.000KHz SWT:Auto</p>

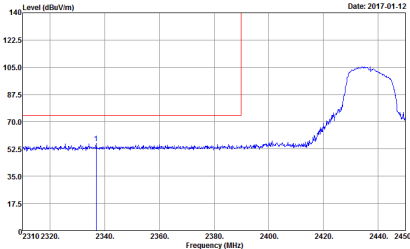
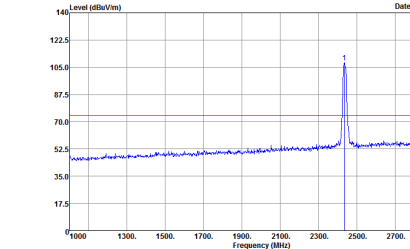
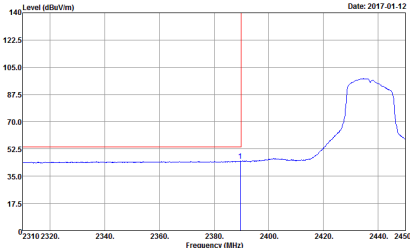
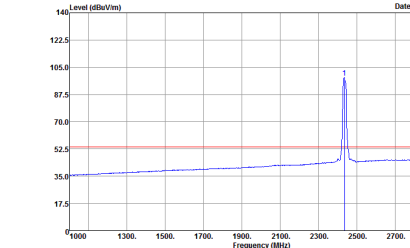

WIFI	2.4GHz 2400~2483.5MHz Band Edge @ 3m	
ANT	802.11g CH06 2437MHz - L	
1	Horizontal	Fundamental
Peak	 <p>Level (dBuV/m) vs Frequency (MHz) plot showing a peak at approximately 2437 MHz. The y-axis ranges from 0 to 140 dBuV/m, and the x-axis ranges from 2310 to 2450 MHz. A red vertical line marks the peak frequency.</p> <p>Date: 2017.01.12</p> <p>Site Condition : :03CH12-HY : PEAK_BE_74 3m HORN_9120D_1328 HORIZONTAL : RBW:1000.000KHz VBW:3000.000KHz SWT:Auto</p>	 <p>Level (dBuV/m) vs Frequency (MHz) plot showing a sharp peak at approximately 2437 MHz. The y-axis ranges from 0 to 140 dBuV/m, and the x-axis ranges from 1000 to 3000 MHz. A red horizontal line indicates the peak level, labeled 'PEAK_74'.</p> <p>Date: 2017.01.12</p> <p>Site Condition : :03CH12-HY : PEAK_74 3m HORN_9120D_1328 HORIZONTAL : RBW:1000.000KHz VBW:3000.000KHz SWT:Auto</p>
Avg.	 <p>Level (dBuV/m) vs Frequency (MHz) plot showing the average spectrum. The y-axis ranges from 0 to 140 dBuV/m, and the x-axis ranges from 2310 to 2450 MHz. A red vertical line marks the peak frequency.</p> <p>Date: 2017.01.12</p> <p>Site Condition : :03CH12-HY : AVG_BE_54 3m HORN_9120D_1328 HORIZONTAL : RBW:1000.000KHz VBW:1.000KHz SWT:Auto</p>	 <p>Level (dBuV/m) vs Frequency (MHz) plot showing the average spectrum. The y-axis ranges from 0 to 140 dBuV/m, and the x-axis ranges from 1000 to 3000 MHz. A red horizontal line indicates the average level, labeled 'AVG_54'.</p> <p>Date: 2017.01.12</p> <p>Site Condition : :03CH12-HY : AVG_54 3m HORN_9120D_1328 HORIZONTAL : RBW:1000.000KHz VBW:1.000KHz SWT:Auto</p>



WIFI	2.4GHz 2400~2483.5MHz Band Edge @ 3m	
ANT	802.11g CH06 2437MHz - R	
1	Horizontal	Fundamental
Peak	<p>Site Condition : 03CH12-HY : PEAK_BE_74 3m HORN_9120D_1328 HORIZONTAL : RBW:1000.000KHz VBW:3000.000KHz SWT:Auto</p>	Left blank
Avg.	<p>Site Condition : 03CH12-HY : AVG_BE_54 3m HORN_9120D_1328 HORIZONTAL : RBW:1000.000KHz VBW:1.000KHz SWT:Auto</p>	Left blank



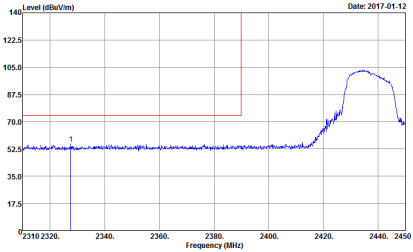
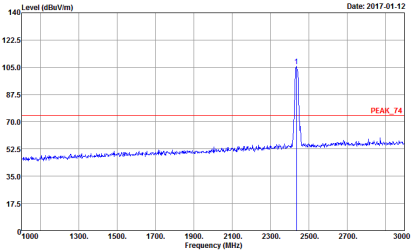
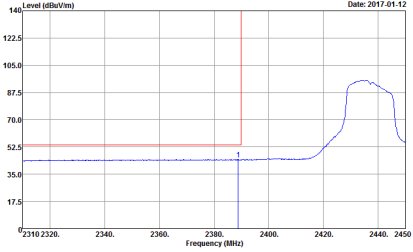
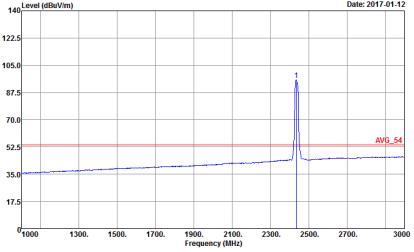

WIFI	2.4GHz 2400~2483.5MHz Band Edge @ 3m	
ANT	802.11g CH06 2437MHz - L	
1	Vertical	Fundamental
Peak	 <p>Date: 2017.01.12</p> <p>Site Condition : 03CH12-HY : PEAK_BE_74 3m HORN_9120D_1328 VERTICAL : RBW:1000.000KHz VBW:3000.000KHz SWT:Auto</p>	 <p>Date: 2017.01.12</p> <p>Site Condition : 03CH12-HY : PEAK_74 3m HORN_9120D_1328 VERTICAL : RBW:1000.000KHz VBW:3000.000KHz SWT:Auto</p>
Avg.	 <p>Date: 2017.01.12</p> <p>Site Condition : 03CH12-HY : AVG_BE_54 3m HORN_9120D_1328 VERTICAL : RBW:1000.000KHz VBW:1.000KHz SWT:Auto</p>	 <p>Date: 2017.01.12</p> <p>Site Condition : 03CH12-HY : AVG_54 3m HORN_9120D_1328 VERTICAL : RBW:1000.000KHz VBW:1.000KHz SWT:Auto</p>



WIFI	2.4GHz 2400~2483.5MHz Band Edge @ 3m	
ANT	802.11g CH06 2437MHz - R	
1	Vertical	Fundamental
Peak	<p>Site Condition : :03CH12-HY : PEAK_BE_74 3m HORN_9120D_1328 VERTICAL : RBW:1000.000KHz VBW:3000.000KHz SWT:Auto</p>	Left Blank
Avg.	<p>Site Condition : :03CH12-HY : AVG_BE_54 3m HORN_9120D_1328 VERTICAL : RBW:1000.000KHz VBW:1.000KHz SWT:Auto</p>	Left Blank

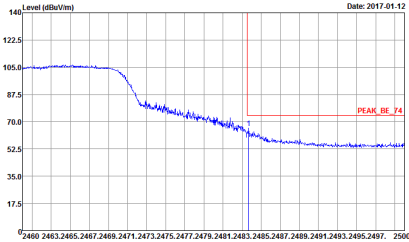
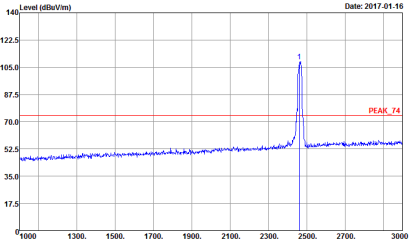
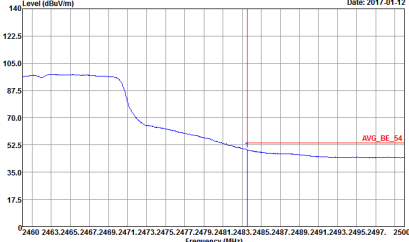
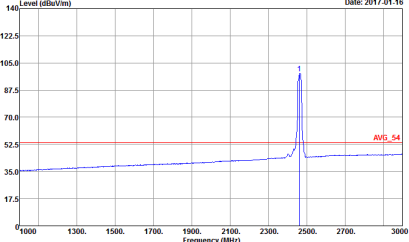

WIFI	2.4GHz 2400~2483.5MHz Band Edge @ 3m	
ANT	802.11g CH11 2462MHz	
1	Horizontal	Fundamental
Peak	 <p>Date: 2017.01.12</p> <p>Site Condition : :03CH12-HY : PEAK_BE_74 3m HORN_9120D_1328 HORIZONTAL : RBW:1000.000KHz VBW:3000.000KHz SWT:Auto</p>	 <p>Date: 2017.01.16</p> <p>Site Condition : :03CH12-HY : PEAK_74 3m HORN_9120D_1328 HORIZONTAL : RBW:1000.000KHz VBW:3000.000KHz SWT:Auto</p>
Avg.	 <p>Date: 2017.01.12</p> <p>Site Condition : :03CH12-HY : AVG_BE_54 3m HORN_9120D_1328 HORIZONTAL : RBW:1000.000KHz VBW:1.000KHz SWT:Auto</p>	 <p>Date: 2017.01.16</p> <p>Site Condition : :03CH12-HY : AVG_54 3m HORN_9120D_1328 HORIZONTAL : RBW:1000.000KHz VBW:1.000KHz SWT:Auto</p>

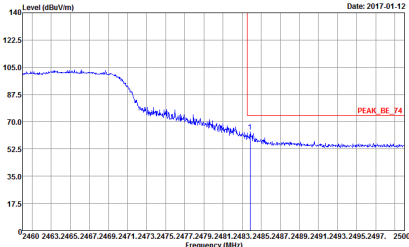
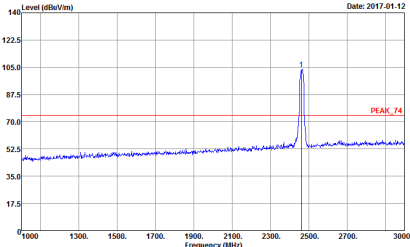
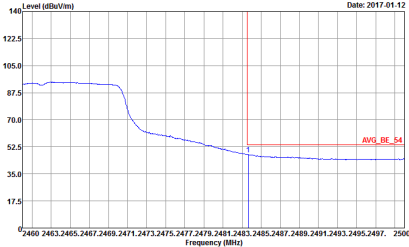
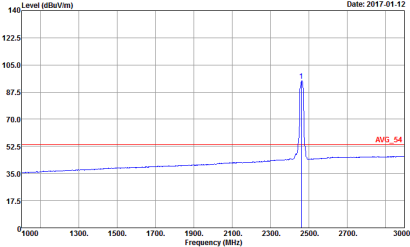

WIFI	2.4GHz 2400~2483.5MHz Band Edge @ 3m	
ANT	802.11g CH11 2462MHz	
1	<p style="text-align: center;"><b>Vertical</b></p>  <p>Level (dBuV/m) vs Frequency (MHz) plot showing a peak at 2462 MHz. The y-axis ranges from 0 to 140 dBuV/m, and the x-axis ranges from 2460 to 2500 MHz. A red vertical line marks the peak at 2462 MHz, labeled 'PEAK_BE_74'.</p> <p>Site Condition : 03CH12-HY : PEAK_BE_74 3m HORN_9120D_1328 VERTICAL : RBW:1000.000KHz VBW:3000.000KHz SWT:Auto</p>	<p style="text-align: center;"><b>Fundamental</b></p>  <p>Level (dBuV/m) vs Frequency (MHz) plot showing a peak at 2462 MHz. The y-axis ranges from 0 to 140 dBuV/m, and the x-axis ranges from 1000 to 3000 MHz. A red vertical line marks the peak at 2462 MHz, labeled 'PEAK_74'.</p> <p>Site Condition : 03CH12-HY : PEAK_74 3m HORN_9120D_1328 VERTICAL : RBW:1000.000KHz VBW:3000.000KHz SWT:Auto</p>
Peak	<p style="text-align: center;"><b>Vertical</b></p>  <p>Level (dBuV/m) vs Frequency (MHz) plot showing the average level. The y-axis ranges from 0 to 140 dBuV/m, and the x-axis ranges from 2460 to 2500 MHz. A red vertical line marks the average level at 2462 MHz, labeled 'AVG_BE_54'.</p> <p>Site Condition : 03CH12-HY : AVG_BE_54 3m HORN_9120D_1328 VERTICAL : RBW:1000.000KHz VBW:1.000KHz SWT:Auto</p>	<p style="text-align: center;"><b>Fundamental</b></p>  <p>Level (dBuV/m) vs Frequency (MHz) plot showing the average level. The y-axis ranges from 0 to 140 dBuV/m, and the x-axis ranges from 1000 to 3000 MHz. A red vertical line marks the average level at 2462 MHz, labeled 'AVG_54'.</p> <p>Site Condition : 03CH12-HY : AVG_54 3m HORN_9120D_1328 VERTICAL : RBW:1000.000KHz VBW:1.000KHz SWT:Auto</p>
Avg.		



2.4GHz 2400~2483.5MHz  
 WIFI 802.11n HT20 (Band Edge @ 3m)

WIFI	2.4GHz 2400~2483.5MHz Band Edge @ 3m	
ANT	802.11n HT20 CH01 2412MHz	
1	Horizontal	Fundamental
Peak	<p>Site Condition : 03CH12-HY        : PEAK_BE_74 3m HORN_9120D_1328 HORIZONTAL        : RBW:1000.000KHz VBW:3000.000KHz SWT:Auto</p>	<p>Site Condition : 03CH12-HY        : PEAK_74 3m HORN_9120D_1328 HORIZONTAL        : RBW:1000.000KHz VBW:3000.000KHz SWT:Auto</p>
Avg.	<p>Site Condition : 03CH12-HY        : AVG_BE_54 3m HORN_9120D_1328 HORIZONTAL        : RBW:1000.000KHz VBW:1.000KHz SWT:Auto</p>	<p>Site Condition : 03CH12-HY        : AVG_54 3m HORN_9120D_1328 HORIZONTAL        : RBW:1000.000KHz VBW:1.000KHz SWT:Auto</p>

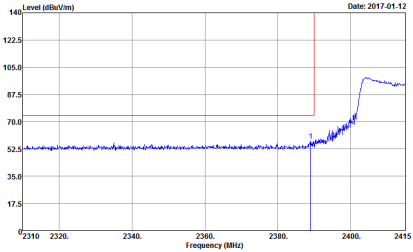
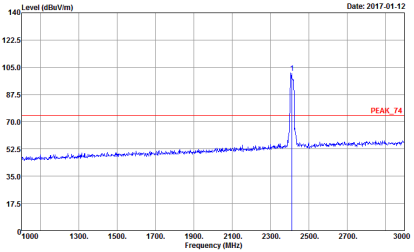
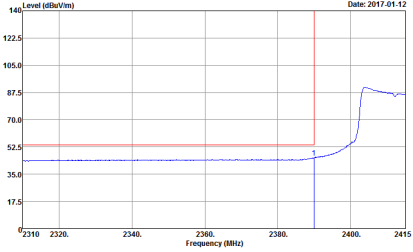
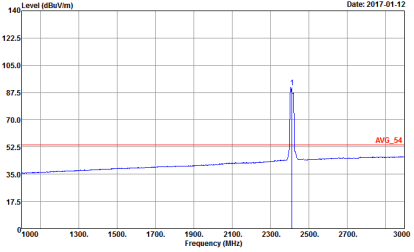

WIFI	2.4GHz 2400~2483.5MHz Band Edge @ 3m	
ANT	802.11n HT20 CH01 2412MHz	
1	Vertical	Fundamental
Peak	 <p>Date: 2017.01.12</p> <p>Site Condition : 03CH12-HY : PEAK_BE_74 3m HORN_9120D_1328 VERTICAL : RBW:1000.000KHz VBW:3000.000KHz SWT:Auto</p>	 <p>Date: 2017.01.12</p> <p>Site Condition : 03CH12-HY : PEAK_74 3m HORN_9120D_1328 VERTICAL : RBW:1000.000KHz VBW:3000.000KHz SWT:Auto</p>
Avg.	 <p>Date: 2017.01.12</p> <p>Site Condition : 03CH12-HY : AVG_BE_54 3m HORN_9120D_1328 VERTICAL : RBW:1000.000KHz VBW:1.000KHz SWT:Auto</p>	 <p>Date: 2017.01.12</p> <p>Site Condition : 03CH12-HY : AVG_54 3m HORN_9120D_1328 VERTICAL : RBW:1000.000KHz VBW:1.000KHz SWT:Auto</p>

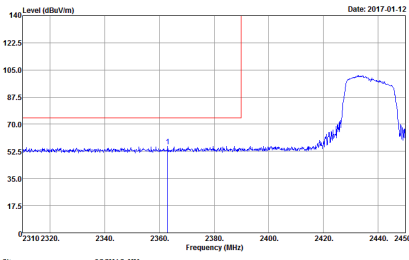
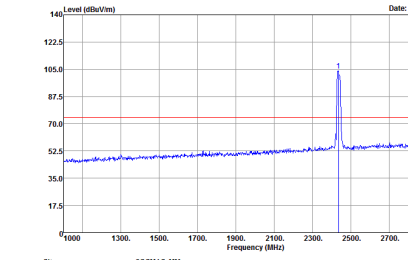
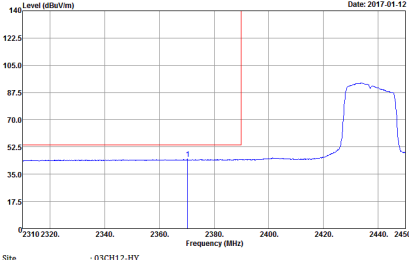
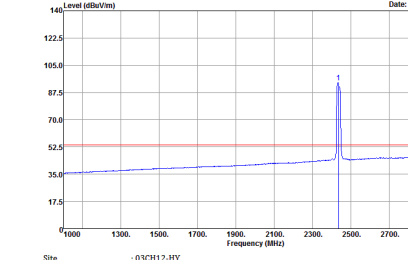

WIFI	2.4GHz 2400~2483.5MHz Band Edge @ 3m	
ANT	802.11n HT20 CH06 2437MHz - L	
1	Horizontal	Fundamental
Peak	 <p>Date: 2017.01.12</p> <p>Site Condition : :03CH12-HY : PEAK_BE_74 3m HORN_9120D_1328 HORIZONTAL : RBW:1000.000kHz VBW:3000.000kHz SWT:Auto</p>	 <p>Date: 2017.01.12</p> <p>Site Condition : :03CH12-HY : PEAK_74 3m HORN_9120D_1328 HORIZONTAL : RBW:1000.000kHz VBW:3000.000kHz SWT:Auto</p>
Avg.	 <p>Date: 2017.01.12</p> <p>Site Condition : :03CH12-HY : AVG_BE_54 3m HORN_9120D_1328 HORIZONTAL : RBW:1000.000kHz VBW:1.000kHz SWT:Auto</p>	 <p>Date: 2017.01.12</p> <p>Site Condition : :03CH12-HY : AVG_54 3m HORN_9120D_1328 HORIZONTAL : RBW:1000.000kHz VBW:1.000kHz SWT:Auto</p>



WIFI	2.4GHz 2400~2483.5MHz Band Edge @ 3m	
ANT	802.11n HT20 CH06 2437MHz - R	
1	Horizontal	Fundamental
Peak	<p>Site Condition : :03CH12-HY : PEAK_BE_74 3m HORN_9120D_1328 HORIZONTAL : RBW:1000.000KHz VBW:3000.000KHz SWT:Auto</p>	Left blank
Avg.	<p>Site Condition : :03CH12-HY : AVG_BE_54 3m HORN_9120D_1328 HORIZONTAL : RBW:1000.000KHz VBW:1.000KHz SWT:Auto</p>	Left blank



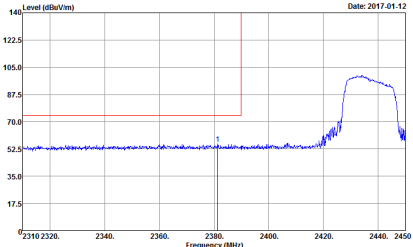
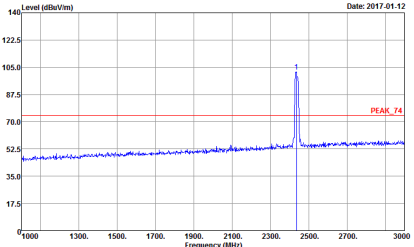
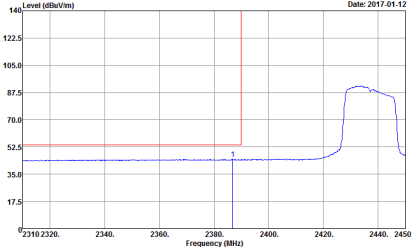
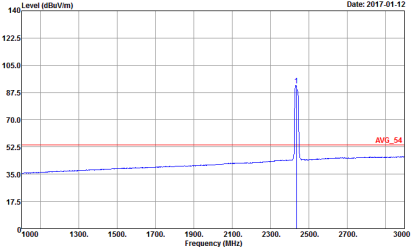

WIFI	2.4GHz 2400~2483.5MHz Band Edge @ 3m	
ANT	802.11n HT20 CH06 2437MHz - L	
1	Vertical	Fundamental
Peak	 <p>Date: 2017.01.12</p> <p>Site Condition : :03CH12-HY : PEAK_BE_74 3m HORN_9120D_1328 VERTICAL : RBW:1000.000KHz VBW:3000.000KHz SWT:Auto</p>	 <p>Date: 2017.01.12</p> <p>Site Condition : :03CH12-HY : PEAK_74 3m HORN_9120D_1328 VERTICAL : RBW:1000.000KHz VBW:3000.000KHz SWT:Auto</p>
Avg.	 <p>Date: 2017.01.12</p> <p>Site Condition : :03CH12-HY : AVG_BE_54 3m HORN_9120D_1328 VERTICAL : RBW:1000.000KHz VBW:1.000KHz SWT:Auto</p>	 <p>Date: 2017.01.12</p> <p>Site Condition : :03CH12-HY : AVG_54 3m HORN_9120D_1328 VERTICAL : RBW:1000.000KHz VBW:1.000KHz SWT:Auto</p>

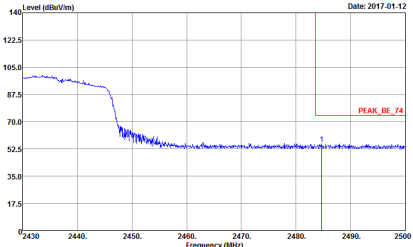
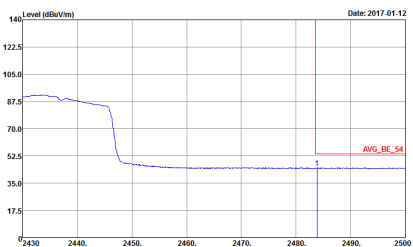

WIFI	2.4GHz 2400~2483.5MHz Band Edge @ 3m	
ANT	802.11n HT20 CH06 2437MHz - R	
1	Vertical	Fundamental
Peak	 <p>Site Condition : :03CH12-HY : PEAK_BE_74 3m HORN_9120D_1328 VERTICAL : RBW:1000.000KHz VBW:3000.000KHz SWT:Auto</p>	Left Blank
Avg.	 <p>Site Condition : :03CH12-HY : AVG_BE_54 3m HORN_9120D_1328 VERTICAL : RBW:1000.000KHz VBW:1.000KHz SWT:Auto</p>	Left Blank



WIFI	2.4GHz 2400~2483.5MHz Band Edge @ 3m	
ANT	802.11n HT20 CH11 2462MHz	
1	Horizontal	Fundamental
Peak	<p>Site Condition : 03CH12-HY : PEAK_BE_74 3m HORN_9120D_1328 HORIZONTAL : RBW:1000.000kHz VBW:3000.000kHz SWT:Auto</p>	<p>Site Condition : 03CH12-HY : PEAK_74 3m HORN_9120D_1328 HORIZONTAL : RBW:1000.000kHz VBW:3000.000kHz SWT:Auto</p>
Avg.	<p>Site Condition : 03CH12-HY : AVG_BE_54 3m HORN_9120D_1328 HORIZONTAL : RBW:1000.000kHz VBW:1.000kHz SWT:Auto</p>	<p>Site Condition : 03CH12-HY : AVG_54 3m HORN_9120D_1328 HORIZONTAL : RBW:1000.000kHz VBW:1.000kHz SWT:Auto</p>

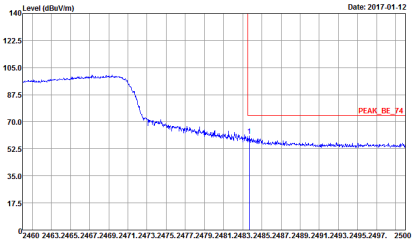
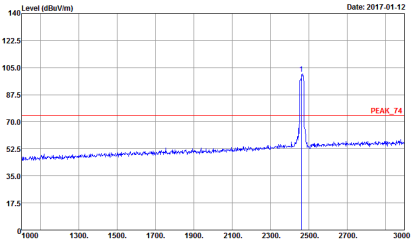
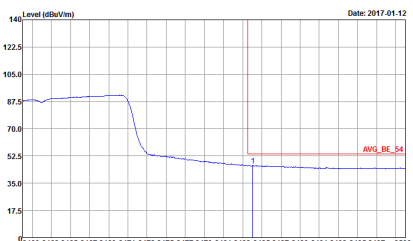
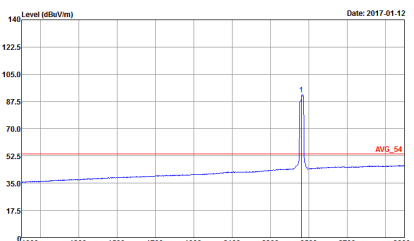

WIFI	2.4GHz 2400~2483.5MHz Fundamental @ 3m	
ANT	802.11n HT20 CH11 2462MHz	
1	Vertical	Fundamental
Peak	 <p>Date: 2017-01-12</p> <p>Site Condition : 03CH12-HY : PEAK_BE_74 3m HORN_9120D_1328 VERTICAL : RBW:1000.000KHz VBW:3000.000KHz SWT:Auto</p>	 <p>Date: 2017-01-12</p> <p>Site Condition : 03CH12-HY : PEAK_74 3m HORN_9120D_1328 VERTICAL : RBW:1000.000KHz VBW:3000.000KHz SWT:Auto</p>
Avg.	 <p>Date: 2017-01-12</p> <p>Site Condition : 03CH12-HY : AVG_BE_54 3m HORN_9120D_1328 VERTICAL : RBW:1000.000KHz VBW:1.000KHz SWT:Auto</p>	 <p>Date: 2017-01-12</p> <p>Site Condition : 03CH12-HY : AVG_54 3m HORN_9120D_1328 VERTICAL : RBW:1000.000KHz VBW:1.000KHz SWT:Auto</p>



2.4GHz 2400~2483.5MHz  
WIFI 802.11b (Harmonic @ 3m)

WIFI	2.4GHz 2400~2483.5MHz Harmonic @ 3m	
ANT	802.11b CH01 2412MHz	
1	Horizontal	Vertical
Peak Avg.	<p>Site : 03CH12-HY Condition : PEAK_74 3m HORN_9120D_1328 HORIZONTAL Detector : Peak</p>	<p>Site : 03CH12-HY Condition : PEAK_74 3m HORN_9120D_1328 VERTICAL Detector : Peak</p>



WIFI	2.4GHz 2400~2483.5MHz Harmonic @ 3m	
ANT	802.11b CH06 2437MHz	
1	Horizontal	Vertical
Peak Avg.	<p>Site Condition :03CH12-HY Detector :PEAK_74 3m HORN_9120D_1328 HORIZONTAL :Peak</p>	<p>Site Condition :03CH12-HY Detector :PEAK_74 3m HORN_9120D_1328 VERTICAL :Peak</p>



WIFI	2.4GHz 2400~2483.5MHz Harmonic @ 3m	
ANT	802.11b CH11 2462MHz	
1	Horizontal	Vertical
Peak Avg.	<p>Site Condition :03CH12-HY Detector :PEAK_74 3m HORN_9120D_1328 HORIZONTAL :Peak</p>	<p>Site Condition :03CH12-HY Detector :PEAK_74 3m HORN_9120D_1328 VERTICAL :Peak</p>



2.4GHz 2400~2483.5MHz  
 WIFI 802.11g (Harmonic @ 3m)

WIFI	2.4GHz 2400~2483.5MHz Harmonic @ 3m	
ANT	802.11g CH01 2412MHz	
1	Horizontal	Vertical
Peak Avg.	<p>Site : 03CH12-HY          Condition : PEAK_74 3m HORN_9120D_1328 HORIZONTAL          Detector : Peak</p>	<p>Site : 03CH12-HY          Condition : PEAK_74 3m HORN_9120D_1328 VERTICAL          Detector : Peak</p>



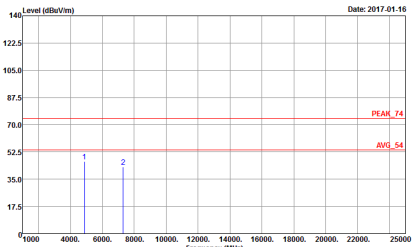
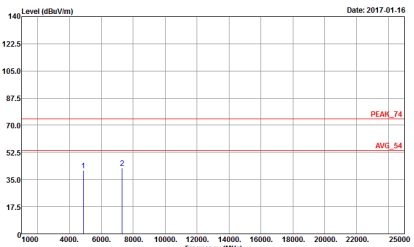

WIFI	2.4GHz 2400~2483.5MHz Harmonic @ 3m	
ANT	802.11g CH06 2437MHz	
1	Horizontal	Vertical
<p>Peak</p> <p>Avg.</p>	 <p>Site : 03CH12-HY Condition : PEAK_74 3m HORN_9120D_1328 HORIZONTAL Detector : Peak</p>	 <p>Site : 03CH12-HY Condition : PEAK_74 3m HORN_9120D_1328 VERTICAL Detector : Peak</p>

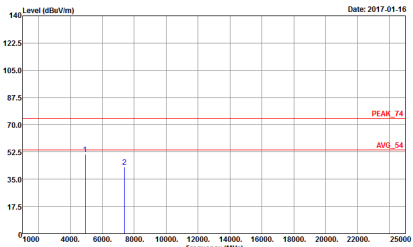
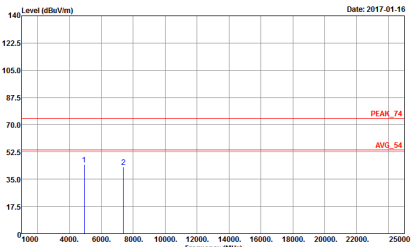

WIFI	2.4GHz 2400~2483.5MHz Harmonic @ 3m	
ANT	802.11g CH11 2462MHz	
1	Horizontal	Vertical
<p>Peak</p> <p>Avg.</p>	 <p>Site : 03CH12-HY Condition : PEAK_74 3m HORN_9120D_1328 HORIZONTAL Detector : Peak</p>	 <p>Site : 03CH12-HY Condition : PEAK_74 3m HORN_9120D_1328 VERTICAL Detector : Peak</p>



2.4GHz 2400~2483.5MHz  
 WIFI 802.11n HT20 (Harmonic @ 3m)

WIFI	2.4GHz 2400~2483.5MHz Harmonic @ 3m	
ANT	802.11n HT20 CH01 2412MHz	
1	Horizontal	Vertical
Peak Avg.	<p>Site : 03CH12-HY          Condition : PEAK_74 3m HORN_9120D_1328 HORIZONTAL          Detector : Peak</p>	<p>Site : 03CH12-HY          Condition : PEAK_74 3m HORN_9120D_1328 VERTICAL          Detector : Peak</p>

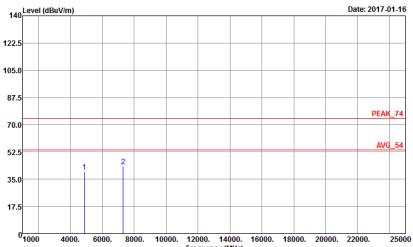
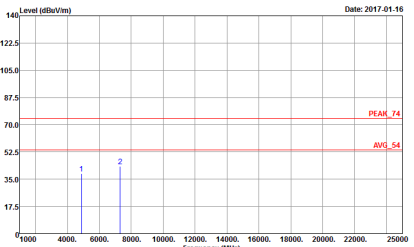

WIFI	2.4GHz 2400~2483.5MHz Harmonic @ 3m	
ANT	802.11n HT20 CH06 2437MHz	
1	Horizontal	Vertical
<p>Peak</p> <p>Avg.</p>	 <p>Site : 03CH12-HY Condition : PEAK_74 3m HORN_9120D_1328 HORIZONTAL Detector : Peak</p>	 <p>Site : 03CH12-HY Condition : PEAK_74 3m HORN_9120D_1328 VERTICAL Detector : Peak</p>

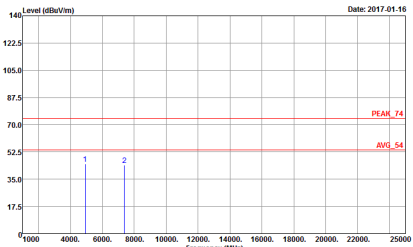
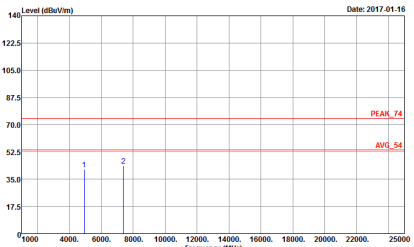

WIFI	2.4GHz 2400~2483.5MHz Harmonic @ 3m	
ANT	802.11n HT20 CH11 2462MHz	
1	Horizontal	Vertical
<p>Peak</p> <p>Avg.</p>	 <p>Site : 03CH12-HY Condition : PEAK_74 3m HORN_9120D_1328 HORIZONTAL Detector : Peak</p>	 <p>Site : 03CH12-HY Condition : PEAK_74 3m HORN_9120D_1328 VERTICAL Detector : Peak</p>



Emission below 1GHz  
2.4GHz WIFI 802.11b (LF)

WIFI	2.4GHz 2400~2483.5MHz	
ANT	802.11b LF	
1	Horizontal	Vertical
QP / Peak	<p>Site : 03CH12-HY Condition : QP 3m BILOG_6111D_37059 HORIZONTAL Detector : Peak</p>	<p>Site : 03CH12-HY Condition : QP 3m BILOG_6111D_37059 VERTICAL Detector : Peak</p>



Emission below 1GHz  
2.4GHz WIFI 802.11g (LF)

WIFI	2.4GHz 2400~2483.5MHz	
ANT	802.11g LF	
1	Horizontal	Vertical
QP / Peak	<p>Site : 03CH12-HY Condition : QP 3m BIL0G_6111D_37059 HORIZONTAL Detector : Peak</p>	<p>Site : 03CH12-HY Condition : QP 3m BIL0G_6111D_37059 VERTICAL Detector : Peak</p>



Emission below 1GHz  
2.4GHz WIFI 802.11n HT20 (LF)

WIFI	2.4GHz 2400~2483.5MHz	
ANT	802.11n HT20 LF	
1	Horizontal	Vertical
QP / Peak	<p>Site : 03CH12-HY Condition : QP 3m BILOG_6111D_37059 HORIZONTAL Detector : Peak</p>	<p>Site : 03CH12-HY Condition : QP 3m BILOG_6111D_37059 VERTICAL Detector : Peak</p>



## Appendix D. Duty Cycle Plots

Band	Duty Cycle(%)	T(us)	1/T(kHz)	VBW Setting
802.11b	100.00	-	-	10Hz
802.11g	96.53	1390	0.72	1kHz
2.4GHz 802.11n HT20	97.02	0.77	1kHz	

### 802.11b

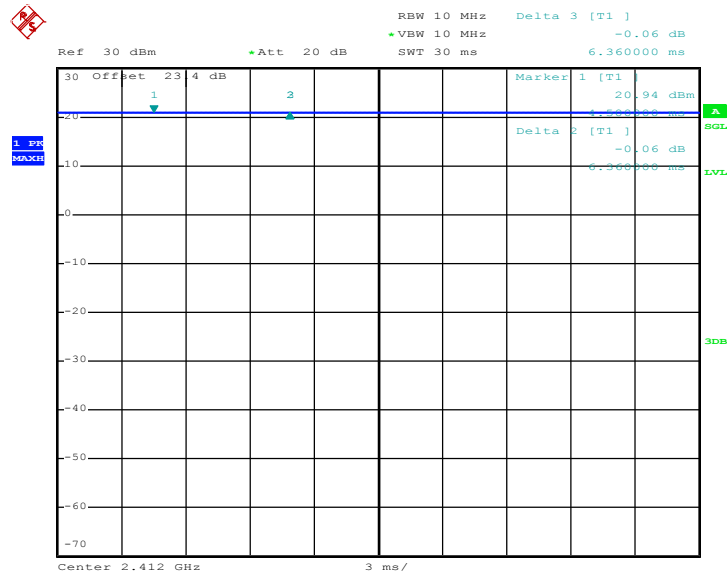

Date: 3.JAN.2017 17:02:49



802.11g

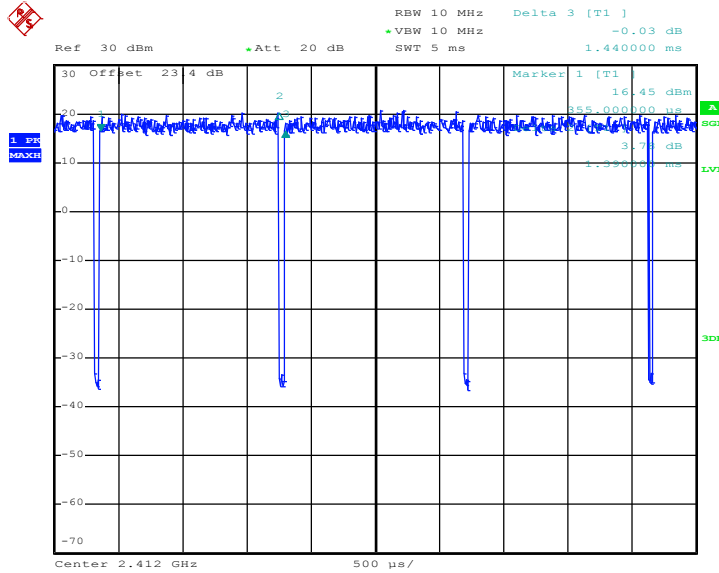

Date: 3.JAN.2017 17:11:10

2.4GHz 802.11n HT20

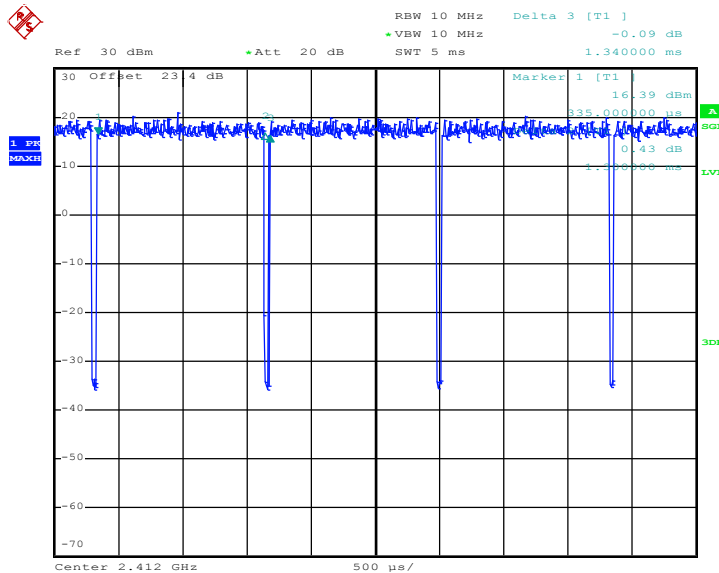

Date: 3.JAN.2017 17:37:53