



# FCC RF Test Report

**APPLICANT** : Sony Mobile Communications Inc.  
**EQUIPMENT** : GSM/WCDMA/LTE Phone+Bluetooth, DTS/UNII a/b/g/n and NFC  
**BRAND NAME** : Sony  
**FCC ID** : PY7-08618V  
**STANDARD** : FCC Part 15 Subpart C §15.225  
**CLASSIFICATION** : (DXC) Low Power Communication Device Transmitter

The testing was completed on Jan. 21, 2017. We, SPORTON INTERNATIONAL INC., would like to declare that the tested sample has been evaluated in accordance with the test procedures and has been in compliance with the applicable technical standards.

The test results in this report apply exclusively to the tested model / sample. Without written approval of SPORTON INTERNATIONAL INC., the test report shall not be reproduced except in full.

Reviewed by: Joseph Lin / Supervisor

Approved by: Jones Tsai / Manager



**SPORTON INTERNATIONAL INC.**

No. 52, Hwa Ya 1<sup>st</sup> Rd., Hwa Ya Technology Park, Kwei-Shan District, Tao Yuan City, Taiwan, R.O.C.



# TABLE OF CONTENTS

**SUMMARY OF THE TEST RESULT .....4**

**1. GENERAL INFORMATION.....5**

1.1 Applicant..... 5

1.2 Manufacturer ..... 5

1.3 Product Feature of Equipment Under Test ..... 5

1.4 Product Specification of Equipment Under Test ..... 6

1.5 Modification of EUT ..... 6

1.6 Testing Location ..... 7

1.7 Applicable Standards..... 7

**2. TEST CONFIGURATION OF EQUIPMENT UNDER TEST .....8**

2.1 Descriptions of Test Mode ..... 8

2.2 Connection Diagram of Test System ..... 8

2.3 Table for Supporting Units ..... 9

2.4 EUT Operation Test Setup ..... 9

**3. TEST RESULTS.....10**

3.1 AC Power Line Conducted Emissions Measurement ..... 10

3.2 20dB and 99% OBW Spectrum Bandwidth Measurement..... 12

3.3 Frequency Stability Measurement ..... 13

3.4 Field Strength of Fundamental Emissions and Mask Measurement..... 14

3.5 Radiated Emissions Measurement ..... 16

3.6 Antenna Requirements..... 19

**4. LIST OF MEASURING EQUIPMENT .....20**

**APPENDIX A. TEST RESULTS OF CONDUCTED EMISSION TEST**

**APPENDIX B. TEST RESULTS OF CONDUCTED TEST ITEMS**

B1. Test Result of 20dB Spectrum Bandwidth

B2. Test Result of Frequency Stability

**APPENDIX C. TEST RESULTS OF RADIATED TEST ITEMS**

C1. Test Result of Field Strength of Fundamental Emissions

C2. Results of Radiated Emissions (9 kHz~30MHz)

C3. Results of Radiated Emissions (30MHz~1GHz)

**APPENDIX D. VERIFICATION OF RADIATED SPURIOUS EMISSIONS AT OPEN-AREA TEST SITE**

D.1 Results of Radiated Emissions (9 kHz~30MHz)

D.2 LIST OF MEASURING EQUIPMENT



### REVISION HISTORY

REPORT NO.	VERSION	DESCRIPTION	ISSUED DATE
FR6D2925D	Rev. 01	Initial issue of report	Mar. 03, 2017
FR6D2925D	Rev. 02	Add the description of OBW in appendix b section b1.	Mar. 09, 2017



## SUMMARY OF THE TEST RESULT

Applied Standard: 47 CFR FCC Part 15 Subpart C				
Part	FCC Rule	Description of Test	Result	Under Limit
3.1	15.207	AC Power Line Conducted Emissions	Complies	13.60 dB at 3.310MHz
3.2	15.215(c)	20dB Spectrum Bandwidth	Complies	-
	-	99% OBW Spectrum Bandwidth	Complies	-
3.3	15.225(e)	Frequency Stability	Complies	-
3.4	15.225(a)(b)(c)	Field Strength of Fundamental Emissions	Complies	62.89 dB at 13.560 MHz
3.5	15.225(d) 15.209	Radiated Emissions	Complies	1.92 dB at 40.530 MHz for Quasi-Peak
3.6	15.203	Antenna Requirements	Complies	-

Test Items	Uncertainty	Remark
AC Power Line Conducted Emissions	±2.70dB	Confidence levels of 95%
Radiated Emissions (30MHz~1000MHz)	±5.70dB	Confidence levels of 95%



# 1. GENERAL INFORMATION

## 1.1 Applicant

Sony Mobile Communications Inc.

4-12-3 Higashi-Shinagawa, Shinagawa-ku, Tokyo, 140-0002, Japan

## 1.2 Manufacturer

Sony Mobile Communications Inc.

4-12-3 Higashi-Shinagawa, Shinagawa-ku, Tokyo, 140-0002, Japan

## 1.3 Product Feature of Equipment Under Test

GSM/WCDMA/LTE, Bluetooth, DTS/UNII, a/b/g/n, NFC, and GPS

Standards-related Product Specification			
Antenna Type / Gain		Loop Antenna	
EUT Information List			
HW Version	SW Version	S/N	Performed Test Item
A	1.21	WUJ01NNJAF	RF Conducted Measurement
		WUJ01NNPAN	Radiated Emission
		WUJ01NNPBW	AC Conducted Emission



Accessory List	
AC Adapter	Model No. : EP800
	S/N : 3015W42100643
Earphone	Model No. : MH410c
	S/N: N/A
USB Cable	Model No. : UCB20
	S/N : 1635A9100031498

**Note:**

1. Above EUT list and accessory list used are electrically identical per declared by manufacturer.
2. Above the accessories list are used to exercise the EUT during test.
3. For other wireless features of this EUT, test report will be issued separately.

### 1.4 Product Specification of Equipment Under Test

Standards-related Product Specification	
Tx/Rx Frequency Range	13.553 ~ 13.567MHz
Channel Number	1
20dBW	2.64 KHz
99%OBW	2.24 KHz
Type of Modulation	ASK

**Remark:** The above EUT's information was declared by manufacturer. Please refer to the specifications or user's manual for more detailed description.

### 1.5 Modification of EUT

No modifications are made to the EUT during all test items.



## 1.6 Testing Location

Sporton Lab is accredited to ISO 17025 by Taiwan Accreditation Foundation (TAF code : 1190) and the FCC designation No. TW1190 under the FCC 2.948(e) by Mutual Recognition Agreement (MRA) in FCC Test.

<b>Test Site</b>	SPORTON INTERNATIONAL INC.		
<b>Test Site Location</b>	No. 52, Hwa Ya 1 <sup>st</sup> Rd., Hwa Ya Technology Park, Kwei-Shan District, Tao Yuan City, Taiwan, R.O.C. TEL: +886-3-3273456 / FAX: +886-3-3284978		
<b>Test Site No.</b>	<b>Sporton Site No.</b>		
	TH03-HY	CO05-HY	03CH07-HY
<b>Test Engineer</b>	William Liao	Arthur Hsieh	Jess Wang
<b>Temperature</b>	22~24°C	21~23°C	21~22°C
<b>Relative Humidity</b>	53~55%	50~53%	49~50%

**Note:** The test site complies with ANSI C63.4 2014 requirement.

<b>Test Site</b>	SPORTON INTERNATIONAL INC.		
<b>Test Site Location</b>	No. 30-2, Dingfu Tsuen, Linkou District, New Taipei City, Taiwan 244, R.O.C. TEL: +886-2-2603-5367 / +886-2-2601-1640 FAX: +886-2-2601-1695		
<b>Test Site No.</b>	<b>Sporton Site No.</b>		
	OS03-LK		
<b>Test Engineer</b>	Eric Jeng		
<b>Temperature</b>	23~25°C		
<b>Relative Humidity</b>	51~54%		

**Note:** The test site complies with ANSI C63.4 2014 requirement.

## 1.7 Applicable Standards

According to the specifications of the manufacturer, the EUT must comply with the requirements of the following standards:

- ♦ FCC Part 15 Subpart C §15.225
- ♦ ANSI C63.10-2013

## 2. TEST CONFIGURATION OF EQUIPMENT UNDER TEST

### 2.1 Descriptions of Test Mode

Investigation has been done on all the possible configurations.

The following table is a list of the test modes shown in this test report.

Test Items	
AC Power Line Conducted Emissions	Field Strength of Fundamental Emissions
20dB Spectrum Bandwidth	Frequency Stability
Radiated Emissions 9kHz~30MHz	Radiated Emissions 30MHz~1GHz

The worst type (type F) declared by manufacturer was used and recorded in this report.

### 2.2 Connection Diagram of Test System

<AC Conducted Emissions>

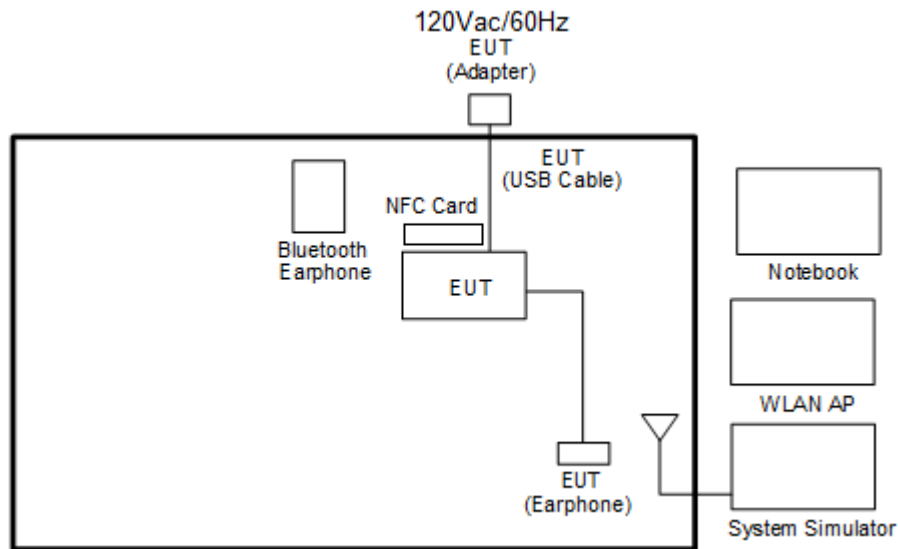



< For Fundamental Emissions and Mask and Radiated Emissions Measurement >

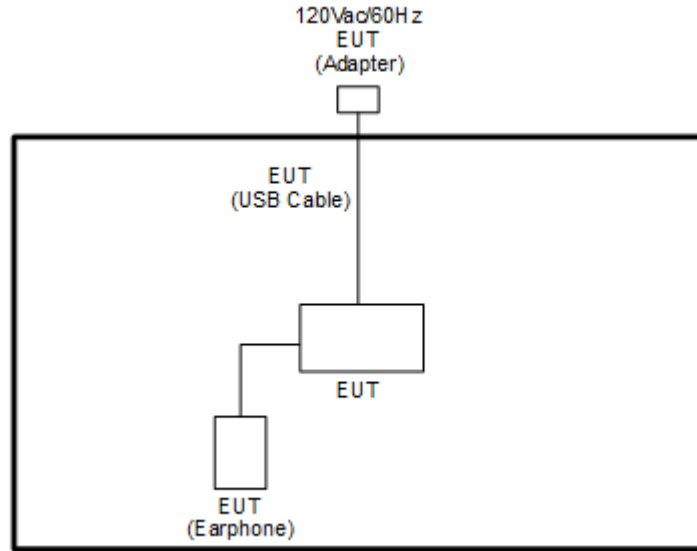

### 2.3 Table for Supporting Units

Support Unit	Manufacturer	Model	FCC ID
System Simulator	Anritsu	MT8820C	N/A
Bluetooth Earphone	Sony	SBH20	PY7-RD0010
WLAN AP	D-Link	DIR-628	KA2DIR628A2
Notebook	DELL	Latitude E6320	FCC DoC/ Contains FCC ID: QDS-BRCM1054
SD Card	SanDisk	MicroSD HC	FCC DoC
NFC Card	Metro Taipei	Easy Card	N/A

### 2.4 EUT Operation Test Setup

The EUT was programmed to be in continuously transmitting mode.

The ancillary equipment, NFC card, is used to make the EUT (NFC) continuously transmit at 13.56MHz and is placed around 3 cm gap to the EUT.



### 3. TEST RESULTS

#### 3.1 AC Power Line Conducted Emissions Measurement

##### 3.1.1 Limit of AC Conducted Emission

For equipment that is designed to be connected to the public utility (AC) power line, the radio frequency voltage that is conducted back onto the AC power line on any frequency or frequencies within the band 150 kHz to 30 MHz shall not exceed the limits in the following table.

Frequency of Emission (MHz)	Conducted Limit (dB $\mu$ V)	
	Quasi-Peak	Average
0.15-0.5	66 to 56*	56 to 46*
0.5-5	56	46
5-30	60	50

\*Decreases with the logarithm of the frequency.

For terminal test result, the testing follows FCC KDB 174176.

##### 3.1.2 Measuring Instruments

See list of measuring instruments of this test report.

##### 3.1.3 Test Procedures

1. The EUT was placed 0.4 meter from the conducting wall of the shielding room, and it was kept at least 80 centimeters from any other grounded conducting surface.
2. Connect EUT to the power mains through a line impedance stabilization network (LISN).
3. All the support units are connecting to the other LISN.
4. The LISN provides 50 ohm coupling impedance for the measuring instrument.
5. The FCC states that a 50 ohm, 50 microhenry LISN should be used.
6. Both sides of AC line were checked for maximum conducted interference.
7. The frequency range from 150 kHz to 30 MHz was searched.
8. Set the test-receiver system to Peak Detect Function and specified bandwidth (IF Bandwidth = 9kHz) with Maximum Hold Mode. Then measurement is also conducted by Average Detector and Quasi-Peak Detector Function respectively.

### 3.1.4 Test setup

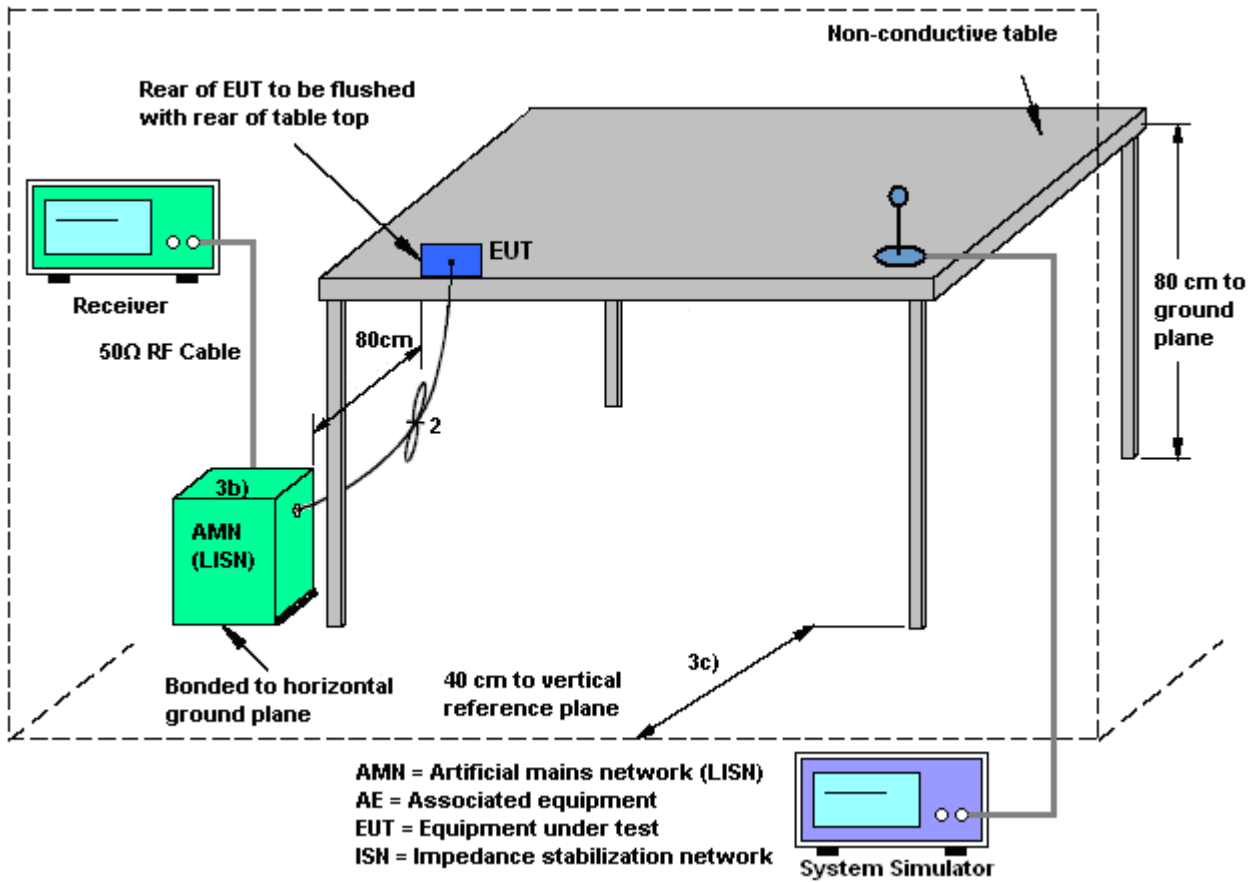

### 3.1.5 Test Result of AC Conducted Emission

Please refer to Appendix A.

## 3.2 20dB and 99% OBW Spectrum Bandwidth Measurement

### 3.2.1 Limit

Intentional radiators must be designed to ensure that the 20dB and 99% emission bandwidth in the specific band 13.553~13.567MHz.

### 3.2.2 Measuring Instruments

See list of measuring instruments of this test report.

### 3.2.3 Test Procedures

1. The spectrum analyzer connected via a receive antenna placed near the EUT in peak Max hold mode.
2. The resolution bandwidth of 1 kHz and the video bandwidth of 3 kHz were used.
3. Measured the spectrum width with power higher than 20dB below carrier.
4. Measured the 99% OBW.

### 3.2.4 Test Setup

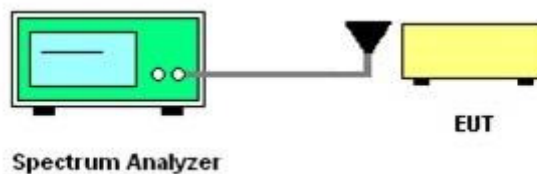

### 3.2.5 Test Result of Conducted Test Items

Please refer to Appendix B.

### 3.3 Frequency Stability Measurement

#### 3.3.1 Limit

The frequency tolerance of the carrier signal shall be maintained within +/- 0.01% (100ppm) of the operating frequency over a temperature variation of -20 degrees to +50 degrees C at normal supply voltage, and for a variation in the primary supply voltage from 85% to 115% of the rated supply voltage at a temperature of 20 degrees C. For battery operated equipment, the equipment tests shall be performed using a new battery.

#### 3.3.2 Measuring Instruments

See list of measuring instruments of this test report.

#### 3.3.3 Test Procedures

1. The spectrum analyzer connected via a receive antenna placed near the EUT.
2. EUT have transmitted signal and fixed channelize.
3. Set the spectrum analyzer span to view the entire emissions bandwidth.
4. Set RBW = 1 kHz, VBW = 3 kHz with peak detector and maxhold settings.
5. The  $f_c$  is declaring of channel frequency. Then the frequency error formula is  $(f_c - f) / f_c \times 10^6$  ppm and the limit is less than  $\pm 100$ ppm.
6. Extreme temperature rule is -20°C~50°C.

#### 3.3.4 Test Setup

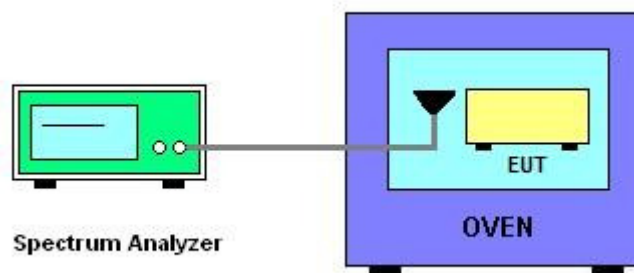

#### 3.3.5 Test Result of Conducted Test Items

Please refer to Appendix C.



### 3.4 Field Strength of Fundamental Emissions and Mask Measurement

#### 3.4.1 Limit

Rules and specifications	FCC CFR 47 Part 15 section 15.225			
Description	Compliance with the spectrum mask is tested with RBW set to 9kHz.			
Freq. of Emission (MHz)	Field Strength ( $\mu\text{V/m}$ ) at 30m	Field Strength ( $\text{dB}\mu\text{V/m}$ ) at 30m	Field Strength ( $\text{dB}\mu\text{V/m}$ ) at 10m	Field Strength ( $\text{dB}\mu\text{V/m}$ ) at 3m
1.705~13.110	30	29.5	48.58	69.5
13.110~13.410	106	40.5	59.58	80.5
13.410~13.553	334	50.5	69.58	90.5
13.553~13.567	15848	84.0	103.08	124.0
13.567~13.710	334	50.5	69.58	90.5
13.710~14.010	106	40.5	59.58	80.5
14.010~30.000	30	29.5	48.58	69.5

#### 3.4.2 Measuring Instruments

See list of measuring instruments of this test report.

### 3.4.3 Test Procedures

1. Configure the EUT according to ANSI C63.10. The EUT was placed on the top of the turntable 0.8 meter above ground. The phase center of the loop receiving antenna mounted antenna tower was placed 3 meters far away from the turntable.
2. Power on the EUT and all the supporting units. The turntable was rotated by 360 degrees to determine the position of the highest radiation.
3. The height of the receiving antenna was fixed at one meter above ground to find the maximum emissions field strength.
4. For Fundamental emissions, use the receiver to measure QP reading.
5. When the radiated emissions limits are expressed in terms of the average value of the emissions, and pulsed operation is employed, the measurement field strength shall be determined by averaging over one complete pulse train, including blanking intervals, as long as the pulse train does not exceed 0.1 seconds. As an alternative (provided the transmitter operates for longer than 0.1 seconds) or in cases where the pulse train exceeds 0.1 seconds, the measured field strength shall be determined from the average absolute voltage during a 0.1 second interval during which the field strength is at its maximum value.
6. Compliance with the spectrum mask is tested with RBW set to 9kHz.  
Note: Emission level (dB $\mu$ V/m) = 20 log Emission level ( $\mu$ V/m).

### 3.4.4 Test Setup

For radiated emissions below 30MHz

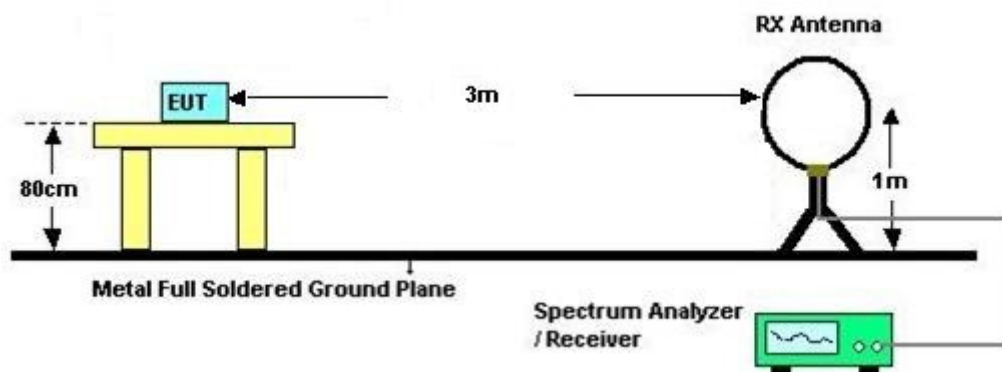

### 3.4.5 Test Result of Field Strength of Fundamental Emissions and Mask

Please refer to Appendix D.



### 3.5 Radiated Emissions Measurement

#### 3.5.1 Limit

The field strength of any emissions which appear outside of 13.110 ~14.010MHz band shall not exceed the general radiated emissions limits.

Frequencies (MHz)	Field Strength (µV/m)	Measurement Distance (meters)
0.009~0.490	2400/F(kHz)	300
0.490~1.705	24000/F(kHz)	30
1.705~30.0	30	30
30~88	100	3
88~216	150	3
216~960	200	3
Above 960	500	3

#### 3.5.2 Measuring Instruments

See list of measuring instruments of this test report.

#### 3.5.3 Measuring Instrument Setting

The following table is the setting of receiver.

Receiver Parameter	Setting
Attenuation	Auto
Frequency Range: 9kHz~150kHz	RBW 200Hz for QP
Frequency Range: 150kHz~30MHz	RBW 9kHz for QP
Frequency Range: 30MHz~1000MHz	RBW 120kHz for Peak

**Note:** The emission limits shown in the above table are based on measurements employing a CISPR quasi-peak detector except for the frequency bands 9-90 kHz, 110-490 kHz. Radiated emission limits in these two bands are based on measurements employing an average detector.





### **3.5.4 Test Procedures**

1. Configure the EUT according to ANSI C63.10. The EUT was placed on the top of the turntable 0.8 meter above ground. The phase center of the receiving antenna mounted on the top of a height-variable antenna tower was placed 3 meters far away from the turntable.
2. Power on the EUT and all the supporting units. The turntable was rotated by 360 degrees to determine the position of the highest radiation.
3. The height of the broadband receiving antenna was varied between one meter and four meters above ground to find the maximum emissions field strength of both horizontal and vertical polarization.
4. For each suspected emissions, the antenna tower was scan (from 1 M to 4 M) and then the turntable was rotated (from 0 degree to 360 degrees) to find the maximum reading.
5. Set the test-receiver system to Peak or CISPR quasi-peak Detect Function with specified bandwidth under Maximum Hold Mode.
6. When the radiated emissions limits are expressed in terms of the average value of the emissions, and pulsed operation is employed, the measurement field strength shall be determined by averaging over one complete pulse train, including blanking intervals, as long as the pulse train does not exceed 0.1 seconds. As an alternative (provided the transmitter operates for longer than 0.1 seconds) or in cases where the pulse train exceeds 0.1 seconds, the measured field strength shall be determined from the average absolute voltage during a 0.1 second interval during which the field strength is at its maximum value.
7. In case the emission is lower than 30MHz, loop antenna has to be used for measurement and the recorded data should be QP measured by receiver. Antenna Requirements

### 3.5.5 Test Setup

For radiated emissions below 30MHz

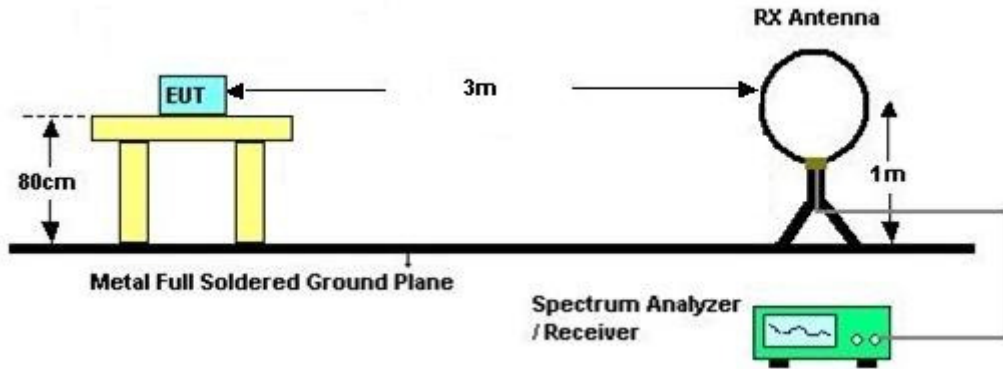

For radiated emissions above 30MHz

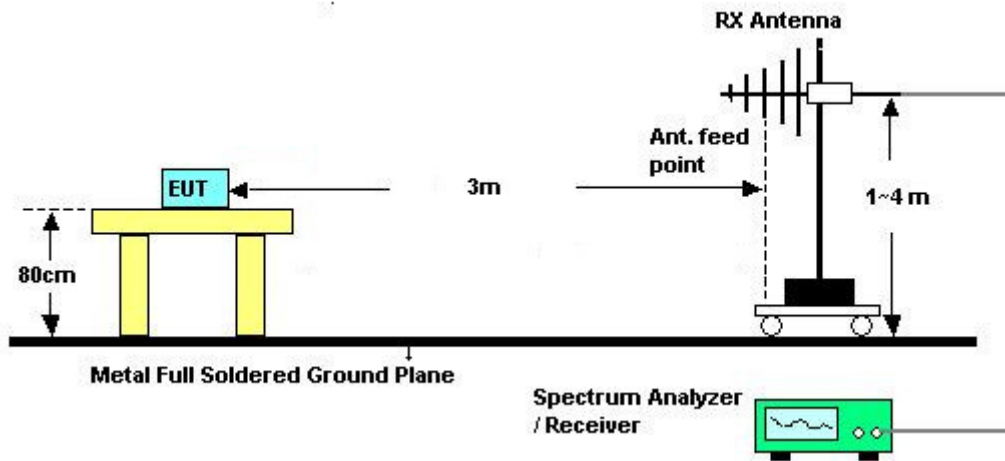

### 3.5.6 Test Result of Radiated Emissions Measurement

Please refer to Appendix D.



## **3.6 Antenna Requirements**

### **3.6.1 Standard Applicable**

Except for special regulations, the Low-power Radio-frequency Devices must not be equipped with any jacket for installing an antenna with extension cable. An intentional radiator shall be designed to ensure that no antenna other than that furnished by the responsible party shall be used with the device. The use of a permanently attached antenna or of an antenna that uses a unique coupling to the intentional radiator shall be considered sufficient to comply with the provisions of this Section. The manufacturer may design the unit so that the user can replace a broken antenna, but the use of a standard antenna jack or electrical connector is prohibited.

The use of a permanently attached antenna or of an antenna that uses a unique coupling to the intentional radiator shall be considered sufficient to comply with the FCC rule.

### **3.6.2 Antenna Anti-Replacement Construction**

An embedded-in antenna design is used.



### 4. LIST OF MEASURING EQUIPMENT

Instrument	Manufacturer	Model No.	Serial No.	Characteristics	Calibration Date	Test Date	Due Date	Remark
AC Power Source	AC POWER	AFC-500W	F104070011	50Hz~60Hz	Dec. 01, 2016	Jan. 09, 2017	Nov. 30, 2017	Conducted (TH03-HY)
Hygrometer	Testo	608-H1	34893241	N/A	May 03, 2016	Jan. 09, 2017	May 02, 2017	Conducted (TH03-HY)
Spectrum Analyzer	Rohde & Schwarz	FSP30	101329	9kHz~30GHz	Jun. 27, 2016	Jan. 09, 2017	Jun. 26, 2017	Conducted (TH03-HY)
Temperature Chamber	ESPEC	SU-641	92013721	-30°C ~70°C	Nov. 16, 2016	Jan. 09, 2017	Nov. 15, 2017	Conducted (TH03-HY)
AC Power Source	ChainTek	APC-1000W	N/A	N/A	N/A	Jan. 09, 2017~ Jan. 21, 2017	N/A	Conduction (CO05-HY)
EMI Test Receiver	Rohde & Schwarz	ESCI 7	100724	9kHz~7GHz	Aug. 30, 2016	Jan. 09, 2017~ Jan. 21, 2017	Aug. 29, 2017	Conduction (CO05-HY)
Hygrometer	Testo	608-H1	34913912	N/A	Apr. 19, 2016	Jan. 09, 2017~ Jan. 21, 2017	Apr. 18, 2017	Conduction (CO05-HY)
LISN	Rohde & Schwarz	ENV216	100080	9kHz~30MHz	Nov. 29, 2016	Jan. 09, 2017~ Jan. 21, 2017	Nov. 28, 2017	Conduction (CO05-HY)
LF Cable	HUBER + SUHNER	RG-214/U	LF01	N/A	Jan. 06, 2016	Jan. 09, 2017~ Jan. 21, 2017	Jan. 05, 2017	Conduction (CO05-HY)
Test Software	N/A	EMC32	8.40.0	N/A	N/A	Jan. 09, 2017~ Jan. 21, 2017	N/A	Conduction (CO05-HY)
Bilog Antenna	TESEQ	CBL 6111D&0080 0N1D01N-06	35419&03	30MHz to 1GHz	Jan. 07, 2017	Jan. 18, 2017~ Jan. 19, 2017	Jan. 06, 2018	Radiation (03CH07-HY)
Loop Antenna	Rohde & Schwarz	HFH2-Z2	100315	9 kHz~30 MHz	Sep. 02, 2015	Jan. 18, 2017~ Jan. 19, 2017	Sep. 01, 2017	Radiation (03CH07-HY)
EMI Test Receiver	Keysight	N9038A(MX E)	MY5413008 5	20Hz ~ 8.4GHz	Oct. 26, 2016	Jan. 18, 2017~ Jan. 19, 2017	Oct. 25, 2017	Radiation (03CH07-HY)
Preamplifier	COM-POWER	PA-103A	161241	10MHz-1GHz	Mar. 18, 2016	Jan. 18, 2017~ Jan. 19, 2017	Mar. 17, 2017	Radiation (03CH07-HY)
Spectrum Analyzer	Agilent	N9010A	MY5347011 8	10Hz~44GHz	Feb. 27, 2016	Jan. 18, 2017~ Jan. 19, 2017	Feb. 26, 2017	Radiation (03CH07-HY)
Hygrometer	Testo	608-H1	34897197	N/A	N/A	Jan. 18, 2017~ Jan. 19, 2017	N/A	Radiation (03CH07-HY)
Filter	Wainwright	WHK20/100 0C7/40SS	SN2	20M High Pass	Nov. 22, 2016	Jan. 18, 2017~ Jan. 19, 2017	Nov. 21, 2017	Radiation (03CH07-HY)
RF Cable	HUBER + SUHNER	SUCOFLEX 104	MY8420952 1	30MHz~1GHz	Dec. 01, 2016	Jan. 18, 2017~ Jan. 19, 2017	Nov. 30, 2017	Radiation (03CH07-HY)
RF Cable	HUBER + SUHNER	SUCOFLEX 104	MY8420952 1	9KHz~30MHz	Dec. 01, 2016	Jan. 18, 2017~ Jan. 19, 2017	Nov. 30, 2017	Radiation (03CH07-HY)
Controller	ChainTek	Chaintek 3000	N/A	Control Turn table	N/A	Jan. 18, 2017~ Jan. 19, 2017	N/A	Radiation (03CH07-HY)
Controller	Max-Full	MF7802	MF7802083 68	Control Ant Mast	N/A	Jan. 18, 2017~ Jan. 19, 2017	N/A	Radiation (03CH07-HY)
Antenna Mast	Max-Full	MFA520BS	N/A	1m~4m	N/A	Jan. 18, 2017~ Jan. 19, 2017	N/A	Radiation (03CH07-HY)
Turn Table	ChainTek	Chaintek 3000	N/A	0~360 Degree	N/A	Jan. 18, 2017~ Jan. 19, 2017	N/A	Radiation (03CH07-HY)
Test Software	Audix	E3	6.2009-8-24 (sporton)	N/A	N/A	Jan. 18, 2017~ Jan. 19, 2017	N/A	Radiation (03CH07-HY)



Instrument	Manufacturer	Model No.	Serial No.	Characteristics	Calibration Date	Test Date	Due Date	Remark
Open Area Test Site	SPORTON	OATS-10	OS03-LK	30 MHz ~ 1 GHz 10m, 3m	May 21, 2016	Jan. 20, 2017	May 20, 2017	Radiation (OS03-LK)
Spectrum Analyzer	R&S	FSP 7	100641	9 kHz ~ 7 GHz	Jun. 23, 2016	Jan. 20, 2017	Jun. 22, 2017	Radiation (OS03-LK)
Test Receiver	R&S	ESCS 30	836858/024	9 kHz ~ 2.75 GHz	Jun. 24, 2016	Jan. 20, 2017	Jun. 23, 2017	Radiation (OS03-LK)
Turn Table	EMCO	2080	9711-2021	0 ~ 360 degree	N/A	Jan. 20, 2017	N/A	Radiation (OS03-LK)
Antenna Mast	EMCO	2075	9711-2115	1 m ~ 4 m	N/A	Jan. 20, 2017	N/A	Radiation (OS03-LK)
Loop Antenna	Rohde & Schwarz	HFH2-Z2	100315	9 kHz~30 MHz	Sep. 02, 2015	Jan. 20, 2017	Sep. 01, 2017	Radiation (OS03-LK)
Preamplifier	COM-POWER	PA-103A	161241	10MHz-1GHz	Mar. 18, 2016	Jan. 20, 2017	Mar. 17, 2017	Radiation (OS03-LK)
Test Software	Audix	E3	4	N/A	N/A	Jan. 20, 2017	N/A	Radiation (OS03-LK)

## Appendix A. Test Results of Conducted Emission Test

<Original test result with NFC antenna>

Test Mode :	NFC Tx	Test Voltage :	120Vac / 60Hz
Function Type :	GSM1900 Idle + Bluetooth Link + WLAN (2.4GHz) Link + NFC Tx + MP3 + Battery + Earphone + USB Cable (Charging from Adapter)		

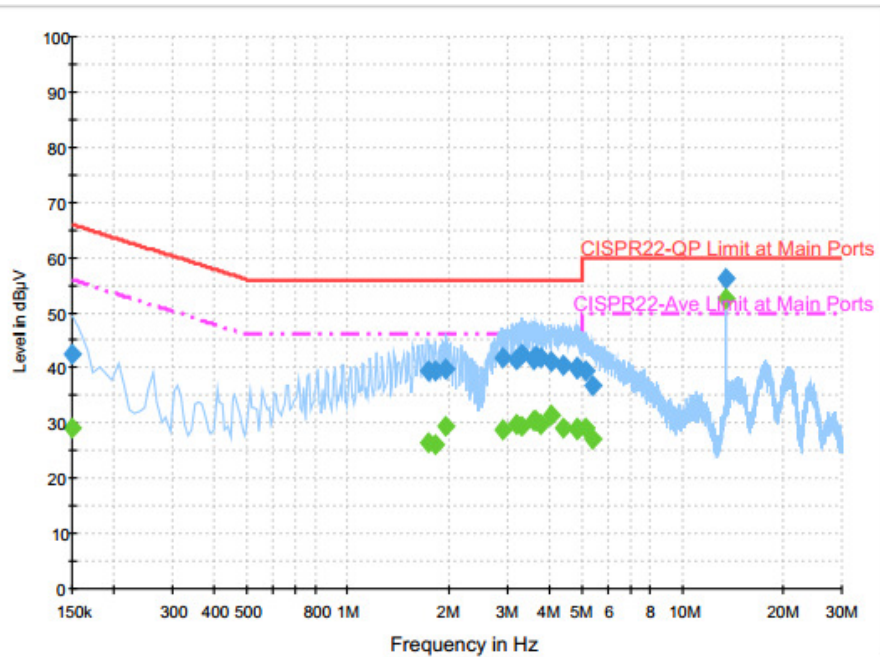

### Final Result : Quasi-Peak

Frequency (MHz)	Quasi-Peak (dBµV)	Filter	Line	Corr. (dB)	Margin (dB)	Limit (dBµV)
0.150000	42.4	Off	L1	19.6	23.6	66.0
1.734000	39.5	Off	L1	19.6	16.5	56.0
1.830000	39.4	Off	L1	19.6	16.6	56.0
1.974000	39.9	Off	L1	19.6	16.1	56.0
2.894000	41.8	Off	L1	19.5	14.2	56.0
3.190000	41.6	Off	L1	19.6	14.4	56.0
3.310000	42.4	Off	L1	19.6	13.6	56.0
3.598000	41.6	Off	L1	19.7	14.4	56.0
3.662000	42.2	Off	L1	19.7	13.8	56.0
3.758000	41.8	Off	L1	19.7	14.2	56.0
4.046000	41.1	Off	L1	19.7	14.9	56.0
4.430000	40.5	Off	L1	19.7	15.5	56.0
4.838000	40.1	Off	L1	19.8	15.9	56.0
4.838000	39.9	Off	L1	19.8	16.1	56.0
5.142000	39.4	Off	L1	19.8	20.6	60.0
5.430000	36.8	Off	L1	19.8	23.2	60.0
13.558000	56.1	Off	L1	20.2	3.9	60.0



<b>Test Mode :</b>	NFC Tx	<b>Test Voltage :</b>	120Vac / 60Hz
<b>Function Type :</b>	GSM1900 Idle + Bluetooth Link + WLAN (2.4GHz) Link + NFC Tx + MP3 + Battery + Earphone + USB Cable (Charging from Adapter)		

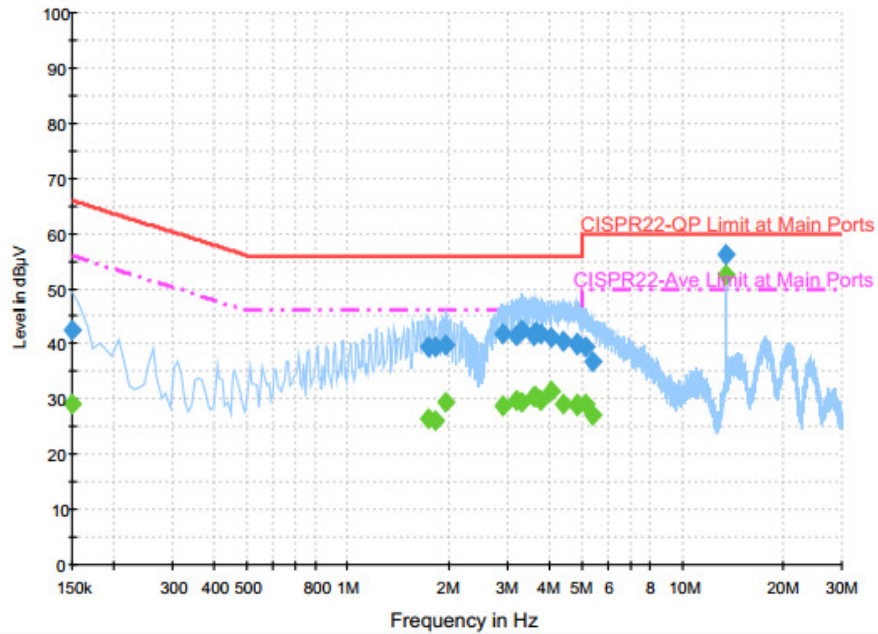

**Final Result : Average**

Frequency (MHz)	Average (dBµV)	Filter	Line	Corr. (dB)	Margin (dB)	Limit (dBµV)
0.150000	29.0	Off	L1	19.6	27.0	56.0
1.734000	26.4	Off	L1	19.6	19.6	46.0
1.830000	26.2	Off	L1	19.6	19.8	46.0
1.974000	29.3	Off	L1	19.6	16.7	46.0
2.894000	28.8	Off	L1	19.5	17.2	46.0
3.190000	29.7	Off	L1	19.6	16.3	46.0
3.310000	29.6	Off	L1	19.6	16.4	46.0
3.598000	30.3	Off	L1	19.7	15.7	46.0
3.662000	30.3	Off	L1	19.7	15.7	46.0
3.758000	29.9	Off	L1	19.7	16.1	46.0
4.046000	31.5	Off	L1	19.7	14.5	46.0
4.430000	29.1	Off	L1	19.7	16.9	46.0
4.838000	28.9	Off	L1	19.8	17.1	46.0
4.838000	29.0	Off	L1	19.8	17.0	46.0
5.142000	29.0	Off	L1	19.8	21.0	50.0
5.430000	27.1	Off	L1	19.8	22.9	50.0
13.558000	52.5	Off	L1	20.2	-2.5	50.0



Test Mode :	NFC Tx	Test Voltage :	120Vac / 60Hz
Function Type :	GSM1900 Idle + Bluetooth Link + WLAN (2.4GHz) Link + NFC Tx + MP3 + Battery + Earphone + USB Cable (Charging from Adapter)		

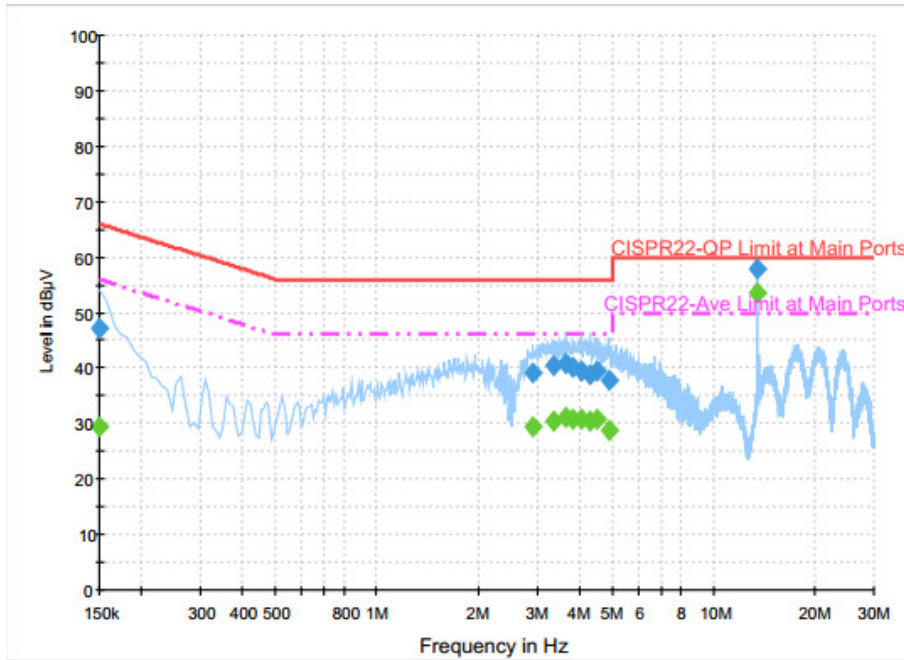

Final Result : Quasi-Peak

Frequency (MHz)	Quasi-Peak (dBµV)	Filter	Line	Corr. (dB)	Margin (dB)	Limit (dBµV)
0.150000	47.2	Off	N	19.6	18.8	66.0
2.910000	39.3	Off	N	19.5	16.7	56.0
3.342000	40.4	Off	N	19.6	15.6	56.0
3.662000	40.9	Off	N	19.7	15.1	56.0
3.814000	40.0	Off	N	19.7	16.0	56.0
4.078000	39.6	Off	N	19.7	16.4	56.0
4.286000	38.7	Off	N	19.7	17.3	56.0
4.502000	39.4	Off	N	19.7	16.6	56.0
4.886000	37.9	Off	N	19.8	18.1	56.0
13.558000	57.9	Off	N	20.3	2.1	60.0





Test Mode :	NFC Tx	Test Voltage :	120Vac / 60Hz
Function Type :	GSM1900 Idle + Bluetooth Link + WLAN (2.4GHz) Link + NFC Tx + MP3 + Battery + Earphone + USB Cable (Charging from Adapter)		

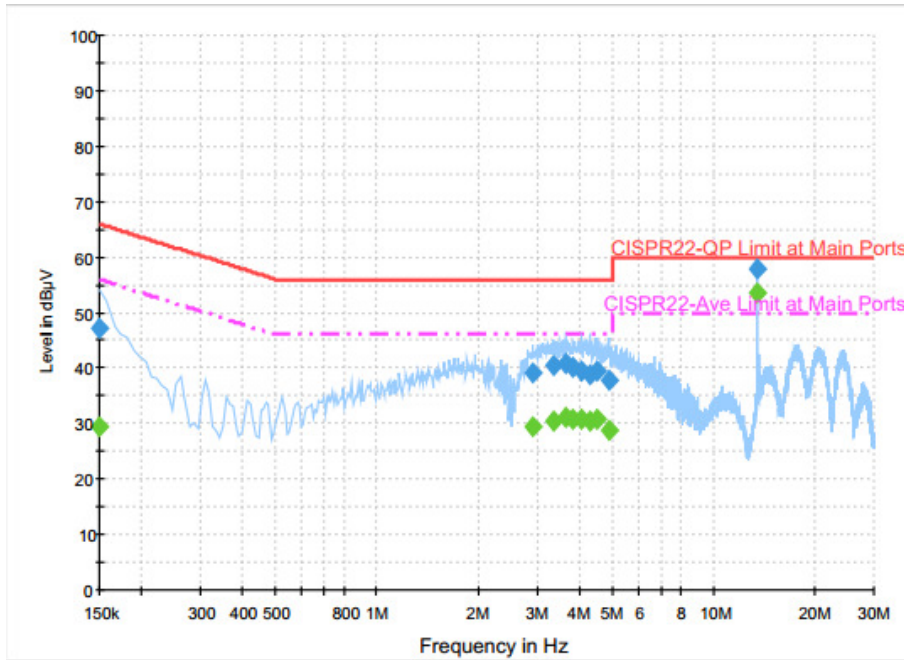

Final Result : Average

Frequency (MHz)	Average (dBµV)	Filter	Line	Corr. (dB)	Margin (dB)	Limit (dBµV)
0.150000	29.6	Off	N	19.6	26.4	56.0
2.910000	29.4	Off	N	19.5	16.6	46.0
3.342000	30.3	Off	N	19.6	15.7	46.0
3.662000	31.0	Off	N	19.7	15.0	46.0
3.814000	30.7	Off	N	19.7	15.3	46.0
4.078000	30.8	Off	N	19.7	15.2	46.0
4.286000	30.5	Off	N	19.7	15.5	46.0
4.502000	30.8	Off	N	19.7	15.2	46.0
4.886000	28.8	Off	N	19.8	17.2	46.0
13.558000	53.6	Off	N	20.3	-3.6	50.0

<Terminal test result with dummy load>

Test Mode :	NFC Tx	Test Voltage :	120Vac / 60Hz
Function Type :	GSM1900 Idle + Bluetooth Link + WLAN (2.4GHz) Link + NFC Tx + MP3 + Battery + Earphone + USB Cable (Charging from Adapter)		

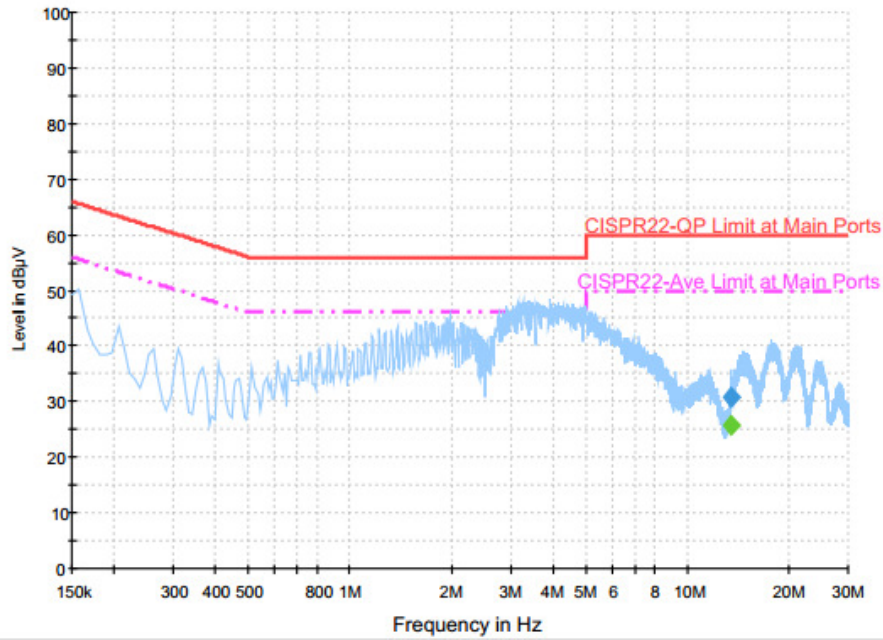

Final Result : Quasi-Peak

Frequency (MHz)	Quasi-Peak (dBµV)	Filter	Line	Corr. (dB)	Margin (dB)	Limit (dBµV)
13.558000	30.8	Off	L1	20.2	29.2	60.0

Final Result : Average

Frequency (MHz)	Average (dBµV)	Filter	Line	Corr. (dB)	Margin (dB)	Limit (dBµV)
13.558000	25.8	Off	L1	20.2	24.2	50.0



<b>Test Mode :</b>	NFC Tx	<b>Test Voltage :</b>	120Vac / 60Hz
<b>Function Type :</b>	GSM1900 Idle + Bluetooth Link + WLAN (2.4GHz) Link + NFC Tx + MP3 + Battery + Earphone + USB Cable (Charging from Adapter)		

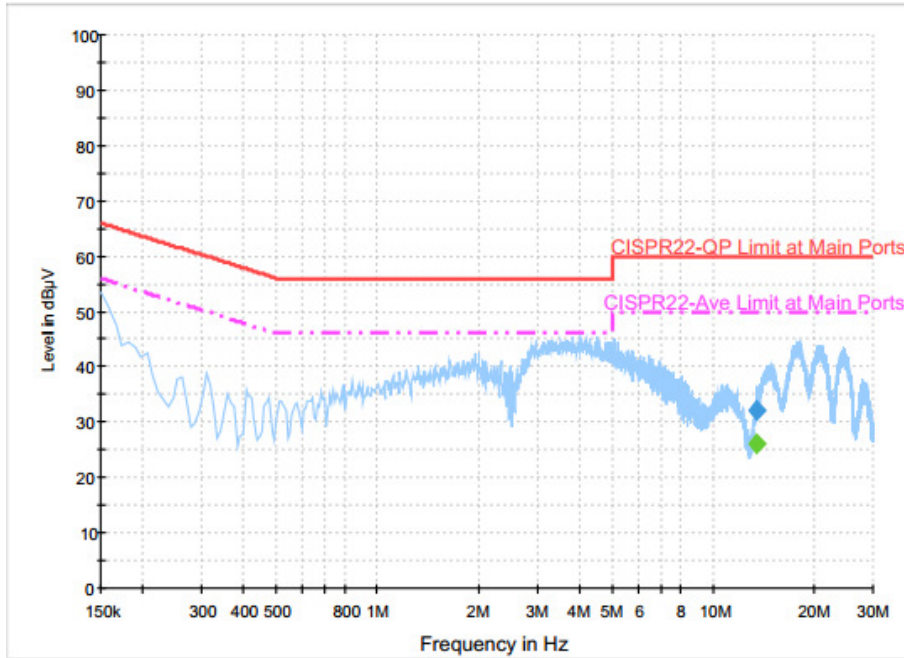

**Final Result : Quasi-Peak**

Frequency (MHz)	Quasi-Peak (dBµV)	Filter	Line	Corr. (dB)	Margin (dB)	Limit (dBµV)
13.558000	32.2	Off	N	20.3	27.8	60.0

**Final Result : Average**

Frequency (MHz)	Average (dBµV)	Filter	Line	Corr. (dB)	Margin (dB)	Limit (dBµV)
13.558000	25.9	Off	N	20.3	24.1	50.0

(1) with antenna

Remark: 13.558 MHz is the NFC RF fundamental signal.

(2) with dummy load

Remark: Only the fundamental NFC signal needs to be retested per C63.4.



## Appendix B. Test Results of Conducted Test Items

### B1. Test Result of 20dB Spectrum Bandwidth

Test mode	NFC Tx	Test Frequency (MHz)	13.56
Date:	6.JAN.2017 22:48:28	Date:	6.JAN.2017 22:48:59
<b>20dB Bandwidth (kHz)</b>	<b>2.64</b>	<b>99% OccupiedBW(kHz)</b>	<b>2.24</b>
<b>Frequency range (MHz)</b>	<b>f<sub>L</sub> &gt; 13.553</b>	13.55906	<b>Test Result</b>
	<b>f<sub>H</sub> &lt; 13.567</b>	13.56170	<b>Complies</b>

Remark:

Because the intentional signal is very narrowband, adjusting the RBW per ANSI C63.10 to be a value of between 1 – 5% of the OBW is impractical and above measurements were made to show that the 99% bandwidth is contained within the 14kHz range between 13.553-13.567 MHz.



B2. Test Result of Frequency Stability

B3. Voltage vs. Frequency Stability		Temperature vs. Frequency Stability		
Voltage (Vac)	Measurement Frequency (MHz)	Temperature (°C)	Time	Measurement Frequency (MHz)
120	13.560390	-20	0	13.560480
			2	13.560480
			5	13.560480
			10	13.560480
102	13.560400	-10	0	13.560480
			2	13.560480
			5	13.560480
			10	13.560480
138	13.560400	0	0	13.560420
			2	13.560420
			5	13.560410
			10	13.560410
		10	0	13.560400
			2	13.560400
			5	13.560400
			10	13.560400
		20	0	13.560360
			2	13.560360
			5	13.560360
			10	13.560360
		30	0	13.560360
			2	13.560360
			5	13.560360
			10	13.560360
		40	0	13.560360
			2	13.560360
			5	13.560360
			10	13.560360



Voltage vs. Frequency Stability		Temperature vs. Frequency Stability		
Voltage (Vac)	Measurement Frequency (MHz)	Temperature (°C)	Time	Measurement Frequency (MHz)
		50	0	13.560360
			2	13.560360
			5	13.560360
			10	13.560360
Max.Deviation (MHz)	0.000400	Max.Deviation (MHz)		0.000480
Max.Deviation (ppm)	29.4985	Max.Deviation (ppm)		35.3982
Limit	FS < ±100 ppm	Limit		FS < ±100 ppm
Test Result	PASS	Test Result		PASS



## Appendix C. Test Results of Radiated Test Items

### C1. Test Result of Field Strength of Fundamental Emissions

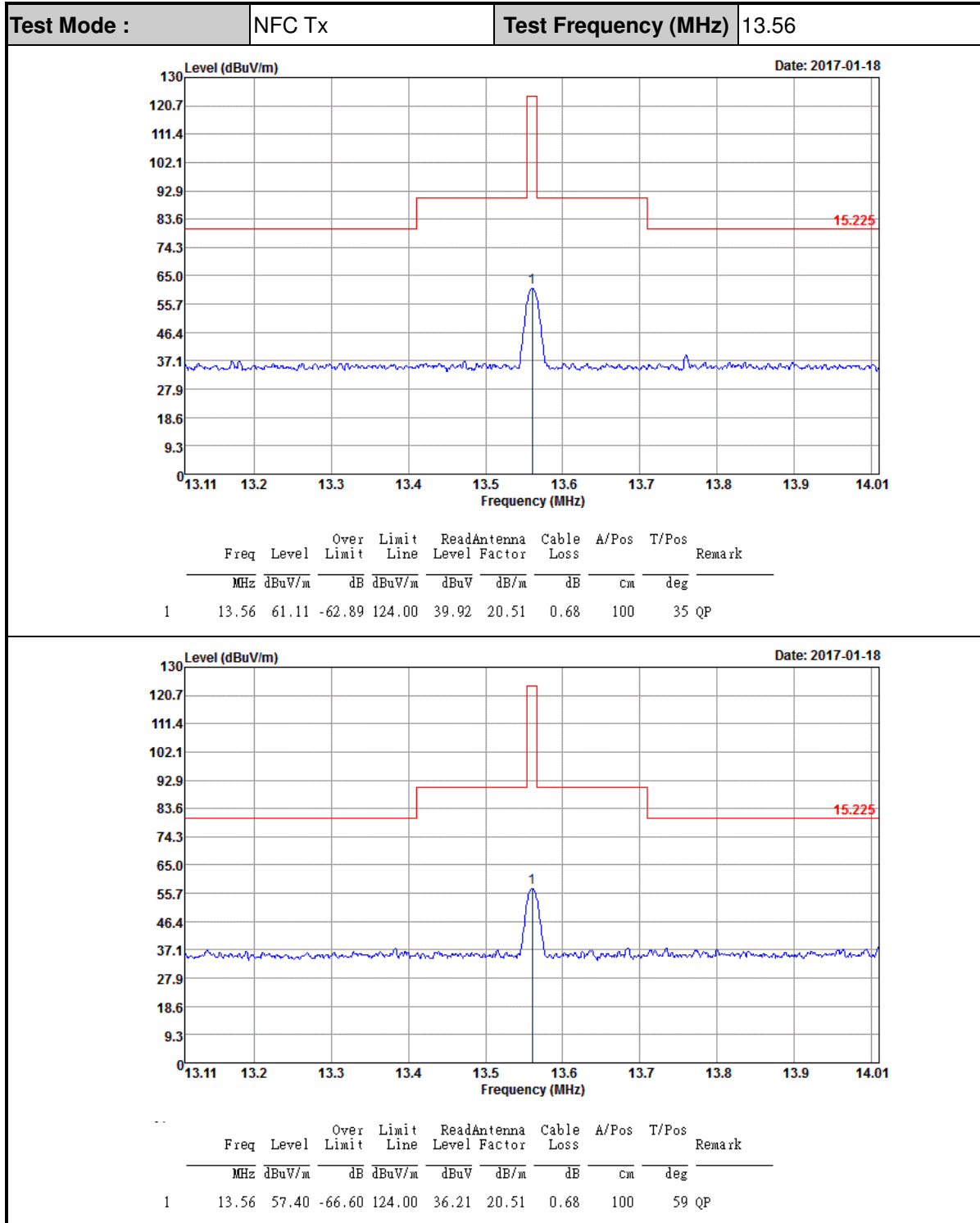



C2. Results of Radiated Spurious Emissions (9 kHz~30MHz)

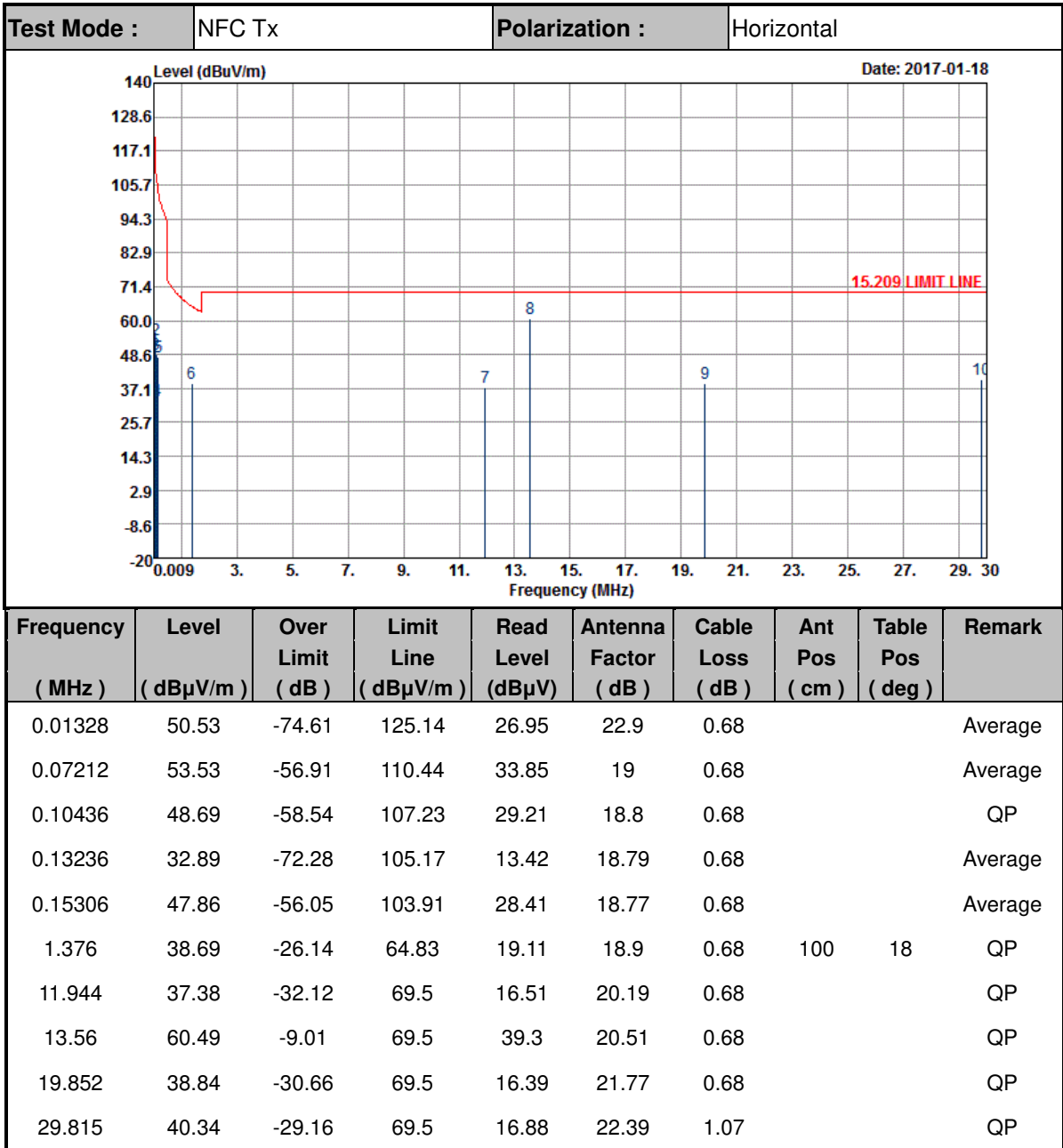



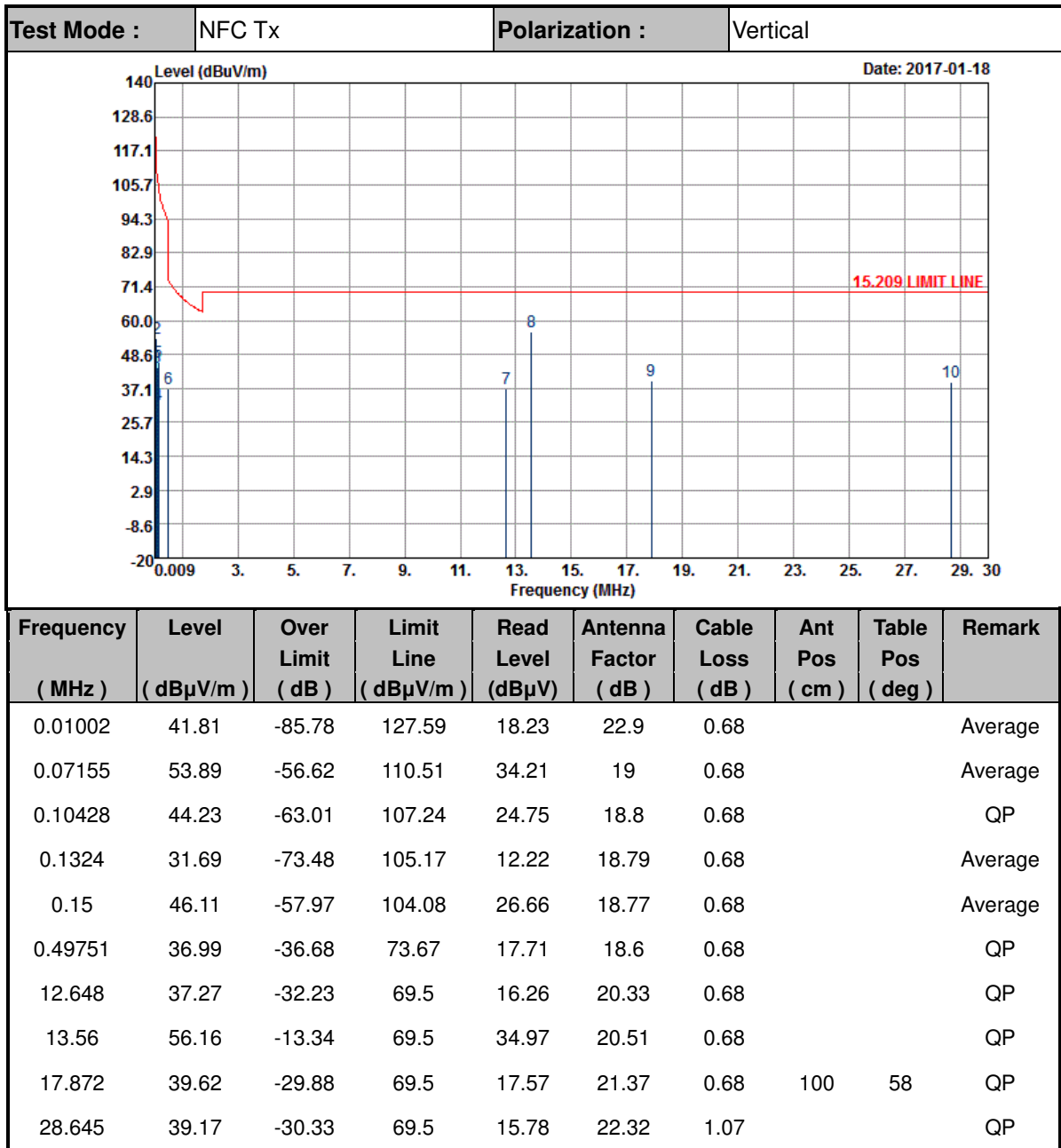

**Note:**

1. 13.56 MHz is fundamental signal which can be ignored.
2. The amplitude of spurious emissions which are attenuated by more than 20dB below the permissible value has no need to be reported.
3. Distance extrapolation factor = 40 log (specific distance / test distance) (dB);
4. Limit line = specific limits (dBμV) + distance extrapolation factor.



**C3. Results of Radiated Spurious Emissions (30MHz~1GHz)**

Test Mode :	NFC Tx	Polarization :	Horizontal
-------------	--------	----------------	------------

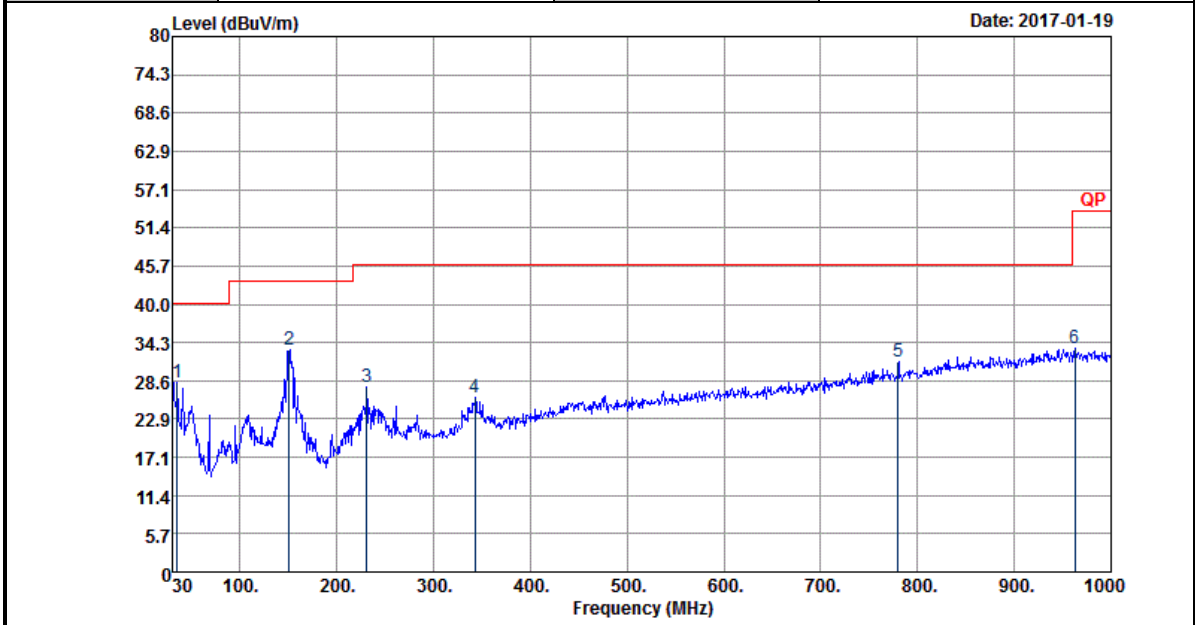

Frequency ( MHz )	Level ( dB $\mu$ V/m )	Over Limit ( dB )	Limit Line ( dB $\mu$ V/m )	Read Level ( dB $\mu$ V )	Antenna Factor ( dB )	Cable Loss ( dB )	Preamp Factor ( dB )	Ant Pos ( cm )	Table Pos ( deg )	Remark
34.86	28.26	-11.74	40	35.3	23.3	1.07	31.41			Peak
150.96	33.16	-10.34	43.5	45.25	17.63	1.78	31.5	100	0	Peak
230.61	27.74	-18.26	46	39.81	17.28	2.07	31.42			Peak
342.7	26.06	-19.94	46	33.81	20.98	2.5	31.23			Peak
780.2	31.31	-14.69	46	30.53	27.5	3.9	30.62			Peak
962.9	33.47	-20.53	54	29.7	30.23	4.07	30.53			Peak

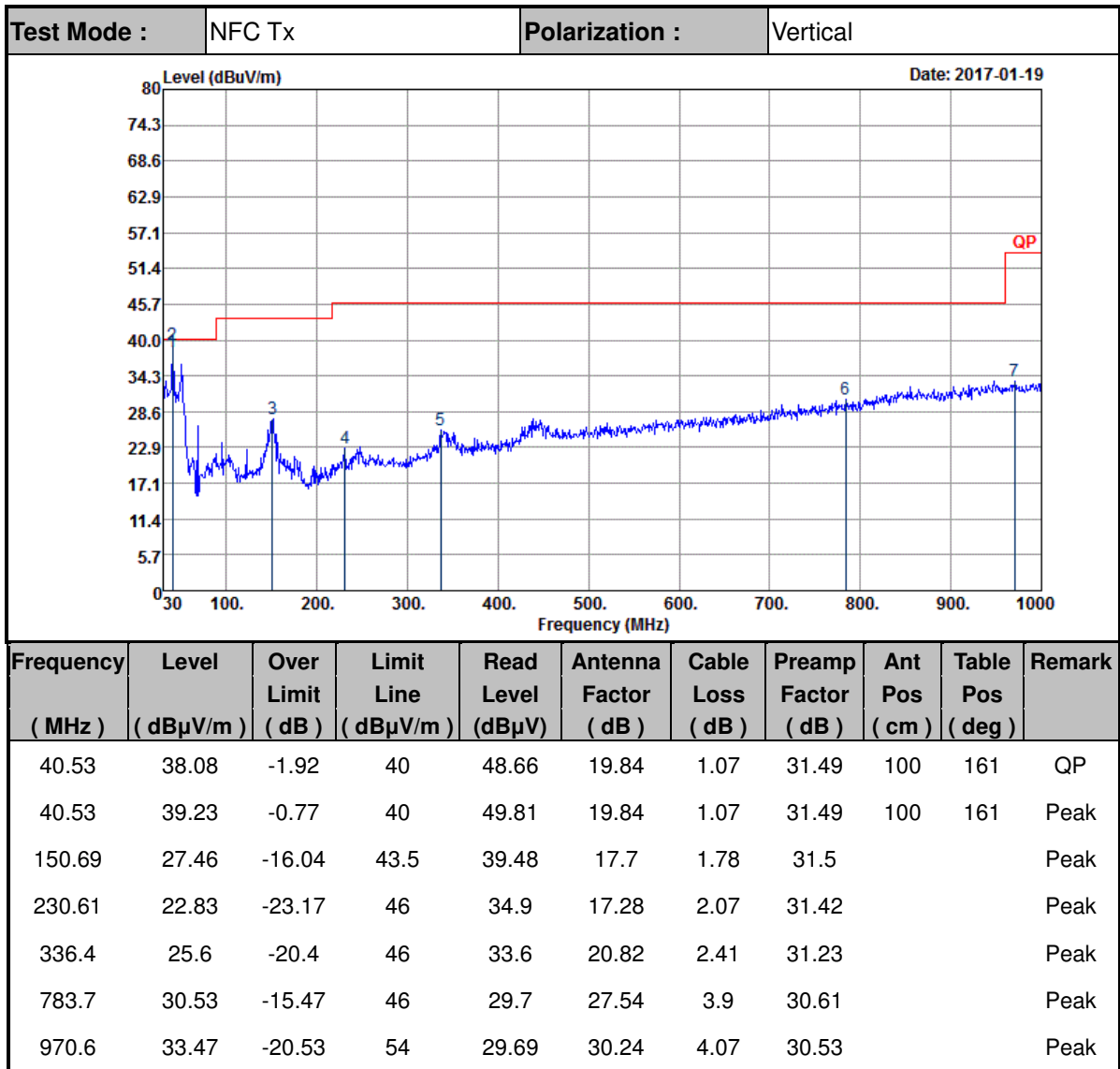

**Note:**

1. The amplitude of spurious emissions which are attenuated by more than 20dB below the permissible value has no need to be reported.
2. Emission level (dBμV/m) = 20 log Emission level (μV/m).
3. Corrected Reading: Antenna Factor + Cable Loss + Read Level - Preamp Factor= Level.



## Appendix D. Verification of Radiated Spurious Emissions at open-area test site

### D.1 Results of Radiated Emissions (9 kHz~30MHz)

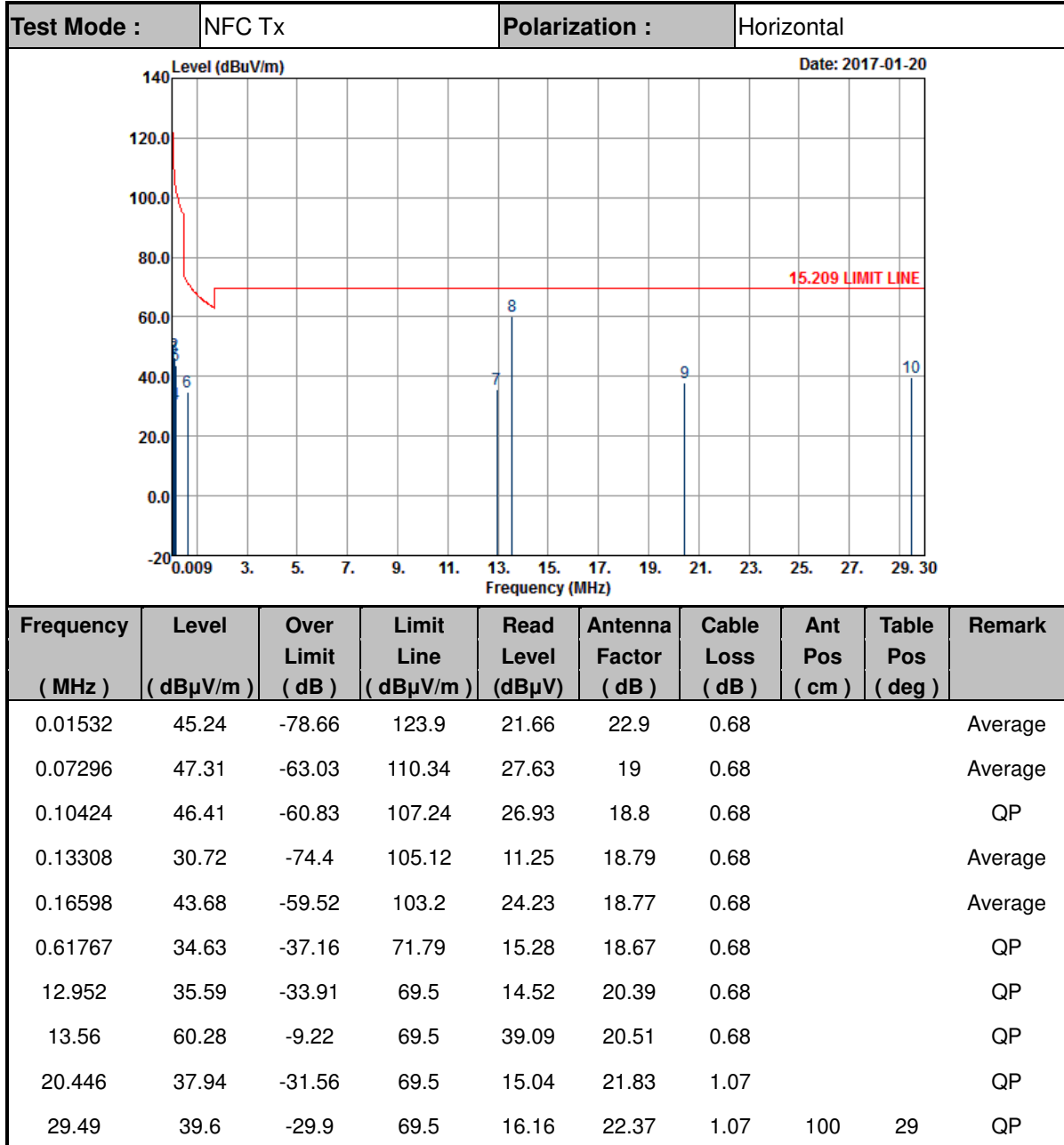

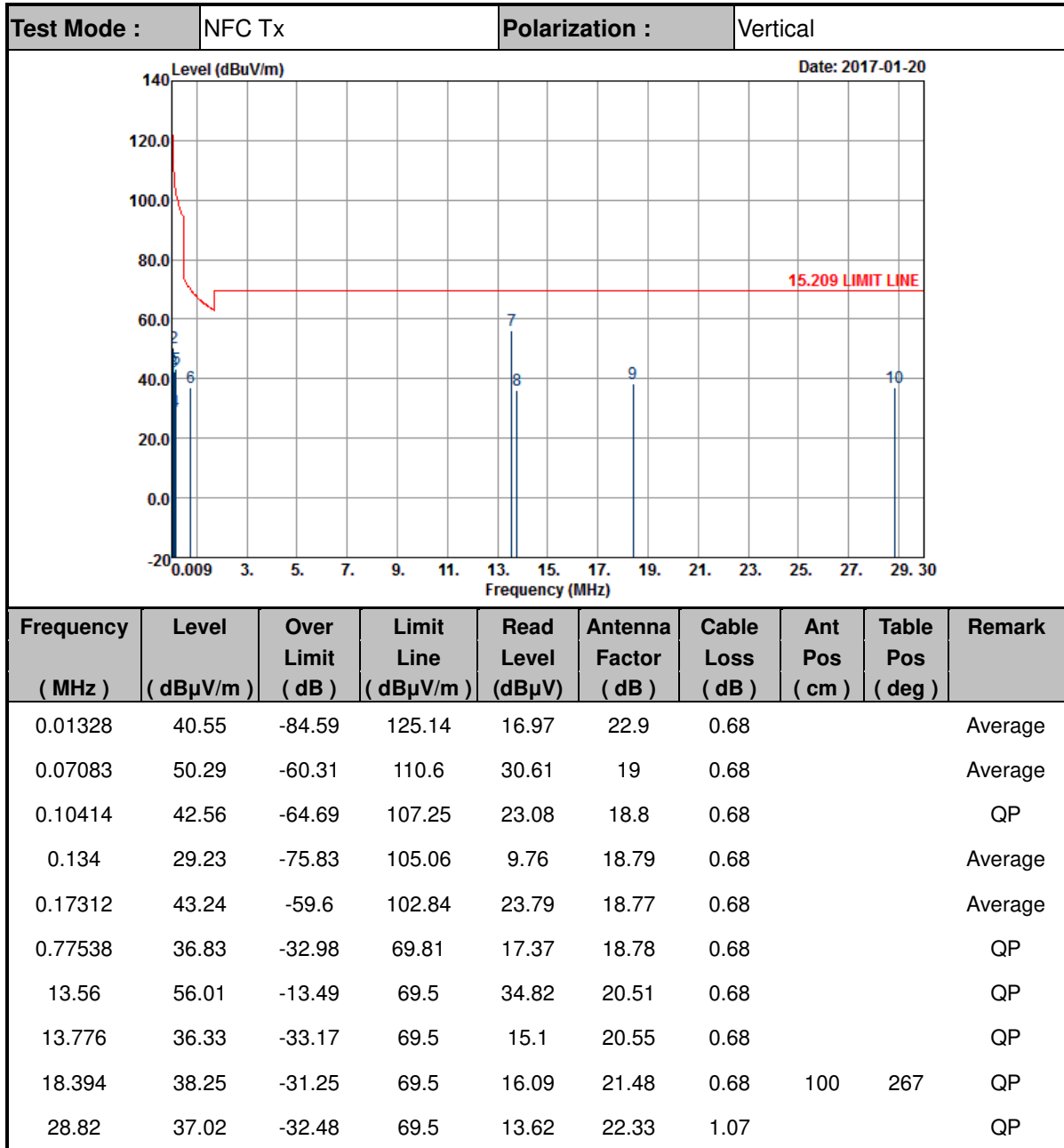

**Note:**

1. 13.56 MHz are fundamental signal which can be ignored.
2. The amplitude of spurious emissions which are attenuated by more than 20dB below the permissible value has no need to be reported.
3. Distance extrapolation factor = 40 log (specific distance / test distance) (dB);
4. Limit line = specific limits (dBuV) + distance extrapolation factor.
5. The test distance between the receiving antenna and the EUT is 3meter.