



CERTIFICATION TEST REPORT

Report Number. : 11760905-E5V4

Applicant : SONY MOBILE COMMUNICATIONS INC.
4-12-3 HIGASHI-SHINAGAWA, SHINAGAWA-KU
TOKYO, 140-0002, JAPAN

FCC ID : PY7-32042D

EUT Description : GSM/WCDMA/LTE PHONE with BT, DTS/UNII a/b/g/n/ac, GPS & NFC

Test Standard(s) : FCC 47 CFR PART 15 SUBPART E (EXCEPT DFS)

Date Of Issue:

July 26, 2017

Prepared by:

UL Verification Services Inc.
47173 Benicia Street
Fremont, CA 94538, U.S.A.
TEL: (510) 771-1000
FAX: (510) 661-0888



NVLAP LAB CODE 200065-0

Revision History

<u>Rev.</u>	<u>Issue Date</u>	<u>Revisions</u>	<u>Revised By</u>
V1	06/23/17	Initial Issue	D. Corona

TABLE OF CONTENTS

1. ATTESTATION OF TEST RESULTS	6
2. TEST METHODOLOGY.....	7
3. FACILITIES AND ACCREDITATION	7
4. CALIBRATION AND UNCERTAINTY	8
4.1. MEASURING INSTRUMENT CALIBRATION.....	8
4.2. SAMPLE CALCULATION.....	8
4.3. MEASUREMENT UNCERTAINTY.....	8
5. EQUIPMENT UNDER TEST	9
5.1. DESCRIPTION OF EUT.....	9
5.2. MAXIMUM OUTPUT POWER.....	9
5.3. DESCRIPTION OF AVAILABLE ANTENNAS.....	10
5.4. SOFTWARE AND FIRMWARE.....	10
5.5. LIST OF TEST REDUCTION AND MODES	10
5.6. WORST-CASE CONFIGURATION AND MODE	11
5.7. DESCRIPTION OF TEST SETUP.....	12
6. TEST AND MEASUREMENT EQUIPMENT	15
7. MEASUREMENT METHODS	16
8. SUMMARY TABLE.....	17
9. ON TIME, DUTY CYCLE AND MEASUREMENT METHODS.....	18
9.1. ON TIME AND DUTY CYCLE.....	18
10. ANTENNA PORT TEST RESULTS	21
10.1. 11a 2TX CDD MIMO MODE IN THE 5.2GHz BAND.....	21
10.1.1. 26 dB BANDWIDTH	21
10.1.2. 99% BANDWIDTH.....	25
10.1.3. OUTPUT POWER AND PPSD.....	29
10.2. 11n HT20 2TX CDD MIMO MODE IN THE 5.2GHz BAND.....	35
10.2.1. 26 dB BANDWIDTH	35
10.2.2. 99% BANDWIDTH.....	39
10.2.3. OUTPUT POWER AND PPSD.....	43
10.3. 11n HT40 2TX CDD MIMO MODE IN THE 5.2GHz BAND.....	49
10.3.1. 26 dB BANDWIDTH	49

10.3.2.	99% BANDWIDTH.....	52
10.3.3.	OUTPUT POWER AND PPSD.....	55
10.4.	<i>11ac VHT80 2TX CDD MIMO MODE IN THE 5.2GHz BAND.....</i>	<i>60</i>
10.4.1.	26 dB BANDWIDTH	60
10.4.2.	99% BANDWIDTH.....	62
10.4.3.	OUTPUT POWER AND PPSD.....	64
10.5.	<i>11a 2TX CDD MIMO MODE IN THE 5.3GHz BAND.....</i>	<i>68</i>
10.5.1.	26 dB BANDWIDTH	68
10.5.2.	99% BANDWIDTH.....	72
10.5.3.	OUTPUT POWER AND PPSD.....	76
10.6.	<i>11n HT20 2TX CDD MIMO MODE IN THE 5.3GHz BAND.....</i>	<i>81</i>
10.6.1.	26 dB BANDWIDTH	81
10.6.2.	99% BANDWIDTH.....	85
10.6.3.	OUTPUT POWER AND PPSD.....	89
10.7.	<i>11n HT40 2TX CDD MIMO MODE IN THE 5.3GHz BAND.....</i>	<i>94</i>
10.7.1.	26 dB BANDWIDTH	94
10.7.2.	99% BANDWIDTH.....	97
10.7.3.	OUTPUT POWER AND PPSD.....	100
10.8.	<i>11ac VHT80 2TX CDD MIMO MODE IN THE 5.3GHz BAND.....</i>	<i>104</i>
10.8.1.	26 dB BANDWIDTH	104
10.8.2.	99% BANDWIDTH.....	106
10.8.3.	OUTPUT POWER AND PPSD.....	108
10.9.	<i>11a 2TX CDD MIMO MODE IN THE 5.6GHz BAND.....</i>	<i>111</i>
10.9.1.	26 dB BANDWIDTH	111
10.9.2.	99% BANDWIDTH.....	117
10.9.3.	OUTPUT POWER AND PPSD.....	123
10.10.	<i>11n HT20 2TX CDD MIMO MODE IN THE 5.6GHz BAND.....</i>	<i>130</i>
10.10.1.	26 dB BANDWIDTH	130
10.10.2.	99% BANDWIDTH.....	136
10.10.3.	OUTPUT POWER AND PPSD.....	142
10.11.	<i>11n HT40 2TX CDD MIMO MODE IN THE 5.6GHz BAND.....</i>	<i>149</i>
10.11.1.	26 dB BANDWIDTH	149
10.11.2.	99% BANDWIDTH.....	155
10.11.3.	OUTPUT POWER AND PPSD.....	161
10.12.	<i>11ac VHT80 2TX CDD MIMO MODE IN THE 5.6GHz BAND.....</i>	<i>168</i>
10.12.1.	26 dB BANDWIDTH	168
10.12.2.	99% BANDWIDTH.....	172
10.12.3.	OUTPUT POWER AND PPSD.....	176
10.13.	<i>11a 2TX CDD MIMO MODE IN THE 5.8GHz BAND.....</i>	<i>181</i>
10.13.1.	6 dB BANDWIDTH	181
10.13.2.	99% BANDWIDTH.....	185
10.13.3.	OUTPUT POWER AND PSD	189
10.14.	<i>11n HT20 2TX CDD MIMO MODE IN THE 5.8GHz BAND.....</i>	<i>194</i>
10.14.1.	6 dB BANDWIDTH	194
10.14.2.	99% BANDWIDTH.....	198
10.14.3.	OUTPUT POWER AND PSD	202

10.15.	11n HT40 2TX CDD MIMO MODE IN THE 5.8GHz BAND	207
10.15.1.	6 dB BANDWIDTH	207
10.15.2.	99% BANDWIDTH.....	210
10.15.3.	OUTPUT POWER AND PSD	213
10.16.	11ac VHT80 2TX CDD MIMO MODE IN THE 5.8GHz BAND.....	217
10.16.1.	6 dB BANDWIDTH	217
10.16.2.	99% BANDWIDTH.....	219
10.16.3.	OUTPUT POWER AND PSD	221
11.	RADIATED TEST RESULTS	224
11.1.	LIMITS AND PROCEDURE.....	224
11.1.1.	11a 2TX CDD MIMO MODE IN THE 5.2GHz BAND.....	225
11.1.2.	11n HT20 2TX CDD MIMO MODE IN THE 5.2GHz BAND	233
11.1.3.	11n HT40 2TX CDD MIMO MODE IN THE 5.2GHz BAND	241
11.1.4.	11ac VHT80 2TX CDD MIMO MODE IN THE 5.2GHz BAND.....	247
11.1.5.	11a 2TX CDD MIMO MODE IN THE 5.3GHz BAND.....	251
11.1.6.	11n HT20 2TX CDD MIMO MODE IN THE 5.3GHz BAND	259
11.1.7.	11n HT40 2TX CDD MIMO MODE IN THE 5.3GHz BAND	267
11.1.8.	11ac VHT80 2TX CDD MIMO MODE IN THE 5.3GHz BAND.....	273
11.1.9.	11a 2TX CDD MIMO MODE IN THE 5.6GHz BAND.....	277
11.1.10.	11n HT20 2TX CDD MIMO MODE IN THE 5.6GHz BAND	289
11.1.11.	11n HT40 2TX CDD MIMO MODE IN THE 5.6GHz BAND	301
11.1.12.	11ac VHT80 2TX CDD MIMO MODE IN THE 5.6GHz BAND.....	313
11.1.13.	11a 2TX CDD MIMO MODE IN THE 5.8GHz BAND.....	321
11.1.14.	11n HT20 2TX CDD MIMO MODE IN THE 5.8GHz BAND	331
11.1.15.	11n HT40 2TX CDD MIMO MODE IN THE 5.8GHz BAND	341
11.1.16.	11ac VHT80 2TX CDD MIMO MODE IN THE 5.8GHz BAND.....	349
11.2.	WORST CASE BELOW 30 MHz	355
11.3.	WORST-CASE BELOW 1 GHz	357
11.4.	WORST-CASE 18 to 26 GHz	359
11.5.	WORST-CASE 26 to 40 GHz	361
12.	AC POWER LINE CONDUCTED EMISSIONS	363
12.1.	SETUP PHOTOS.....	366

1. ATTESTATION OF TEST RESULTS

COMPANY NAME: SONY MOBILE COMMUNICATIONS INC.
4-12-3 HIGASHI-SHINAGAWA, SHINAGAWA-KU
TOKYO, 140-0002, JAPAN

EUT DESCRIPTION: GSM/WCDMA/LTE PHONE with BT, DTS/UNII a/b/g/n/ac, GPS & NFC

SERIAL NUMBER: BH9000TN7W & BH9000VC7W (CONDUCTED)
BH9000TM85 & BH9000HE85 (RADIATED)

DATE TESTED: JULY 08 – 25 , 2017

APPLICABLE STANDARDS	
STANDARD	TEST RESULTS
CFR 47 Part 15 Subpart E	Pass

UL Verification Services Inc. tested the above equipment in accordance with the requirements set forth in the above standards. All indications of Pass/Fail in this report are opinions expressed by UL Verification Services Inc. based on interpretations and/or observations of test results. Measurement Uncertainties were not taken into account and are published for informational purposes only. The test results show that the equipment tested is capable of demonstrating compliance with the requirements as documented in this report.

Note: The results documented in this report apply only to the tested sample, under the conditions and modes of operation as described herein. This document may not be altered or revised in any way unless done so by UL Verification Services Inc. and all revisions are duly noted in the revisions section. Any alteration of this document not carried out by UL Verification Services Inc. will constitute fraud and shall nullify the document. This report must not be used by the client to claim product certification, approval, or endorsement by NVLAP, NIST, any agency of the Federal Government, or any agency of any government.

Approved & Released For
UL Verification Services Inc. By:

Prepared By:



DAN CORONIA
PROJECT LEAD
UL VERIFICATION SERVICES INC.

GLENN ESCANO
WISE LAB ENGINEER
UL VERIFICATION SERVICES INC.

2. TEST METHODOLOGY

FCC: The tests documented in this report were performed in accordance with FCC CFR 47 Part 2, FCC CFR 47 Part 15, FCC 14-30, FCC KDB 662911 D01 v02r01, FCC KDB 789033 D02 v01r04, FCC KDB 644545 D03 v01, ANSI C63.10-2013.

3. FACILITIES AND ACCREDITATION

The test sites and measurement facilities used to collect data are located at 47173 and 47266 Benicia Street, Fremont, California, USA. Line conducted emissions are measured only at the 47173 address. The following table identifies which facilities were utilized for radiated emission measurements documented in this report. Specific facilities are also identified in the test results sections.

47173 Benicia Street	47266 Benicia Street
<input checked="" type="checkbox"/> Chamber A(IC: 2324B-1)	<input type="checkbox"/> Chamber D(IC: 22541-1)
<input checked="" type="checkbox"/> Chamber B(IC: 2324B-2)	<input type="checkbox"/> Chamber E(IC: 22541-2)
<input checked="" type="checkbox"/> Chamber C(IC: 2324B-3)	<input type="checkbox"/> Chamber F(IC: 22541-3)
	<input type="checkbox"/> Chamber G(IC: 22541-4)
	<input type="checkbox"/> Chamber H(IC: 22541-5)

The above test sites and facilities are covered under FCC Test Firm Registration # 208313. UL Verification Services Inc. is accredited by NVLAP, Laboratory Code 200065-0. Chambers A through C are covered under Industry Canada company address code 2324B with site numbers 2324B -1 through 2324B-3, respectively. Chambers D through H are covered under Industry Canada company address code 22541 with site numbers 22541 -1 through 22541-5, respectively.

4. CALIBRATION AND UNCERTAINTY

4.1. MEASURING INSTRUMENT CALIBRATION

The measuring equipment utilized to perform the tests documented in this report has been calibrated in accordance with the manufacturer's recommendations, and is traceable to recognized national standards.

4.2. SAMPLE CALCULATION

Where relevant, the following sample calculation is provided:

$$\text{Field Strength (dBuV/m)} = \text{Measured Voltage (dBuV)} + \text{Antenna Factor (dB/m)} + \text{Cable Loss (dB)} - \text{Preamp Gain (dB)}$$

$$36.5 \text{ dBuV} + 18.7 \text{ dB/m} + 0.6 \text{ dB} - 26.9 \text{ dB} = 28.9 \text{ dBuV/m}$$

4.3. MEASUREMENT UNCERTAINTY

Where relevant, the following measurement uncertainty levels have been estimated for tests performed on the apparatus:

Where relevant, the following measurement uncertainty levels have been estimated for tests performed on the apparatus:

Parameter	Uncertainty
Worst Case Conducted Disturbance, 9KHz to 0.15 MHz	3.84 dB
Worst Case Conducted Disturbance, 0.15 to 30 MHz	3.65 dB
Worst Case Radiated Disturbance, 9KHz to 30 MHz	3.15 dB
Worst Case Radiated Disturbance, 30 to 1000 MHz	5.36 dB
Worst Case Radiated Disturbance, 1000 to 18000 MHz	4.32 dB
Worst Case Radiated Disturbance, 18000 to 26000 MHz	4.45 dB
Worst Case Radiated Disturbance, 26000 to 40000 MHz	5.24 dB

Uncertainty figures are valid to a confidence level of 95%.

5. EQUIPMENT UNDER TEST

5.1. DESCRIPTION OF EUT

The EUT is a GSM/WCDMA/LTE Phone with BT, DTS/UNII a/b/g/n/ac, GPS & NFC.

5.2. MAXIMUM OUTPUT POWER

The transmitter has a maximum conducted output power as follows:

5.2GHz Band

Frequency Range (MHz)	Mode	Output Power (dBm)	Output Power (mW)
5180 - 5240	802.11a CDD 2TX	16.55	45.19
	802.11n HT20 CDD 2TX	16.63	46.03
5190 - 5230	802.11n HT40 CDD 2TX	16.37	43.35
5210	802.11ac VHT80 CDD 2TX	16.09	40.64

5.3GHz Band

Frequency Range (MHz)	Mode	Output Power (dBm)	Output Power (mW)
5260 - 5320	802.11a CDD 2TX	16.39	43.55
	802.11n HT20 CDD 2TX	16.20	41.69
5270 - 5310	802.11n HT40 CDD 2TX	16.25	42.17
5290	802.11ac VHT80 CDD 2TX	16.40	43.65

5.6GHz Band

Frequency Range (MHz)	Mode	Output Power (dBm)	Output Power (mW)
5500 - 5720	802.11a CDD 2TX	16.39	43.55
5500 - 5720	802.11n HT20 CDD 2TX	16.36	43.25
5510 - 5710	802.11n HT40 CDD 2TX	16.44	44.06
5530-5710	802.11ac VHT80 CDD 2TX	16.42	43.85

5.8GHz Band

Frequency Range (MHz)	Mode	Output Power (dBm)	Output Power (mW)
5745 - 5825	802.11a CDD 2TX	16.29	42.56
5745 - 5825	802.11n HT20 CDD 2TX	16.31	42.76
5755 - 5795	802.11n HT40 CDD 2TX	16.30	42.66
5775	802.11ac VHT80 CDD 2TX	16.21	41.78

5.3. DESCRIPTION OF AVAILABLE ANTENNAS

The radio utilizes two integrated antennas, with the following maximum gains:

Frequency (GHz)	Peak Antenna Gain (dBi)	
	Main (Chain 0)	Sub (Chain 1)
5180-5320	0.1	1.6
5500-5700	-1.6	0.7
5725-5850	-2.1	-0.3

5.4. SOFTWARE AND FIRMWARE

The firmware installed in the EUT during testing was SONY, s_atp_1_00139_B_10_5.
 The test utility software used during testing was Tera Term Ver 4.79.

5.5. LIST OF TEST REDUCTION AND MODES

Antenna port & Radiated Testing	
Mode	Covered by
802.11a Legacy	802.11a 2TX CDD
802.11HT20 2TX	802.11n HT20 2TX CDD
802.11ac VHT20 2TX	802.11n HT20 2TX CDD
802.11n HT40 2TX	802.11n HT40 2TX CDD
802.11ac VHT40 2TX	802.11n HT40 2TX CDD
802.11ac VHT80 2TX	802.11ac VHT80 2TX CDD

5.6. WORST-CASE CONFIGURATION AND MODE

Radiated emission below 1GHz and power line conducted emissions were performed with the EUT set to transmit at the channel with highest output power as worst-case scenario.

The fundamental of the EUT was investigated in three orthogonal orientations X, Y, Z, it was determined that X was worst-case orientations. Therefore, all final radiated testing was performed with the EUT in Y orientation.

Worst-case data rates as provided by the client were:

802.11a mode: 6 Mbps
802.11n HT20 mode: 13 Mbps (MCS8)
802.11n HT40 mode: 27 Mbps (MCS8)
802.11ac VHT80 mode: 58.5 Mbps (MCS0)

802.11ac VHT20 and VHT40 mode are different from 802.11n HT20 and HT40 only in control messages and have the same power settings.

The simultaneous mode (SISO 2.4GHz Chain 0 and 5GHz chain 1) was checked and stand-alone (MIMO) 2.4 GHz / 5GHz remain worst case.

5.7. DESCRIPTION OF TEST SETUP

SUPPORT EQUIPMENT

Support Equipment List				
Description	Manufacturer	Model	Serial Number	FCC ID
Laptop	Lenovo	20B7S0A200	PC015REW	NA
AC Adapter	SONY	1300-7137.1	4016W40310044	NA
Headphones	SONY	N/A	N/A	N/A

I/O CABLES (CONDUCTED TEST)

I/O Cable List						
Cable No	Port	# of identical ports	Connector Type	Cable Type	Cable Length (m)	Remarks
1	Antenna	1	RF	Shielded	0.2	To spectrum Analyzer
2	USB	1	USB	Shielded	1	N/A
3	DC	1	DC	Shielded	0.3	N/A

I/O CABLES (RADIATED AND CONDUCTED EMISSIONS)

I/O Cable List						
Cable No	Port	# of identical ports	Connector Type	Cable Type	Cable Length (m)	Remarks
1	USB	1	USB	Shielded	3	N/A
2	Audio	1	3.5mm	Shielded	1	N/A

TEST SETUP

CONDCUTED TEST SETUP DIAGRAM

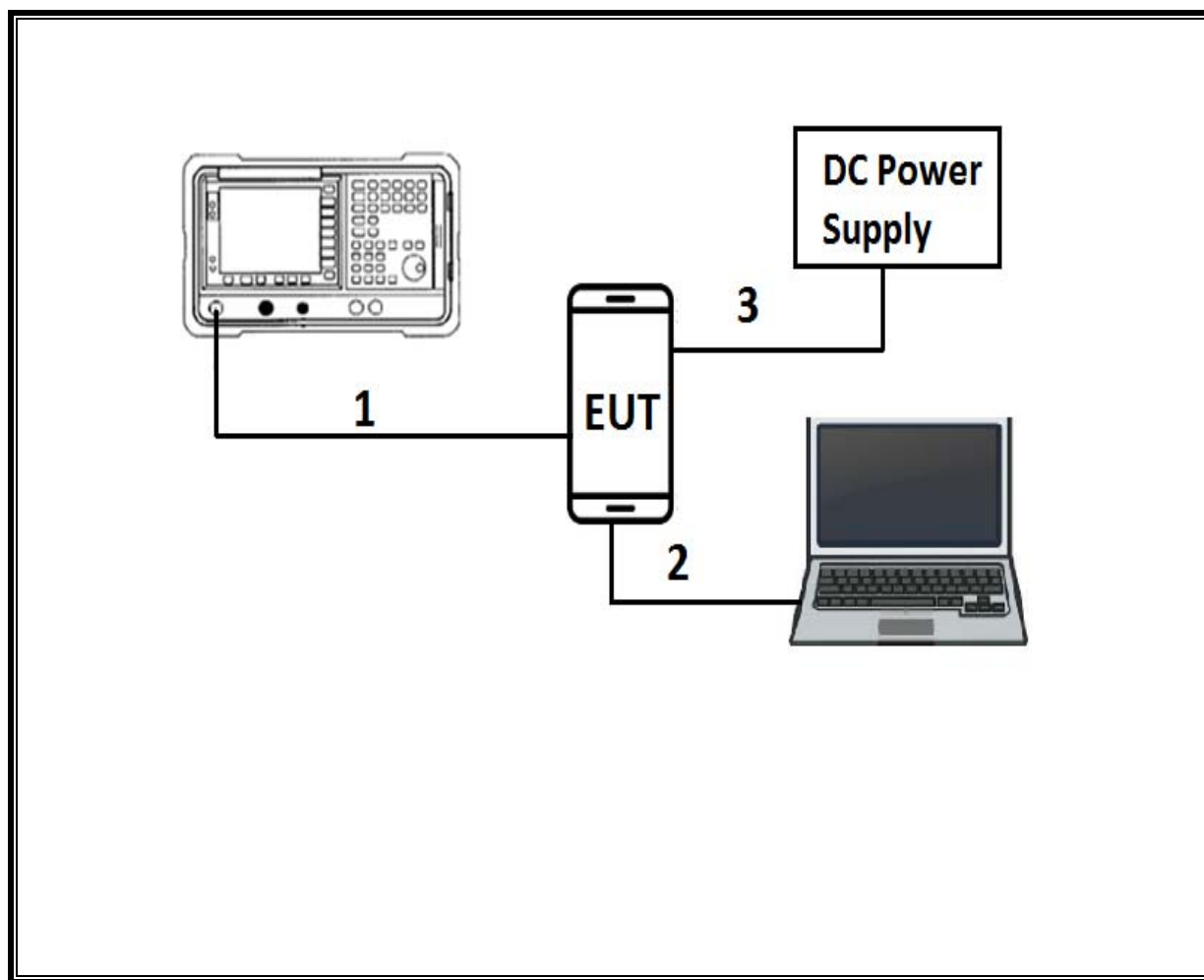

TEST SETUP

RADIATED AND AC LINE CONDUCTED EMISSIONS SETUP DIAGRAM

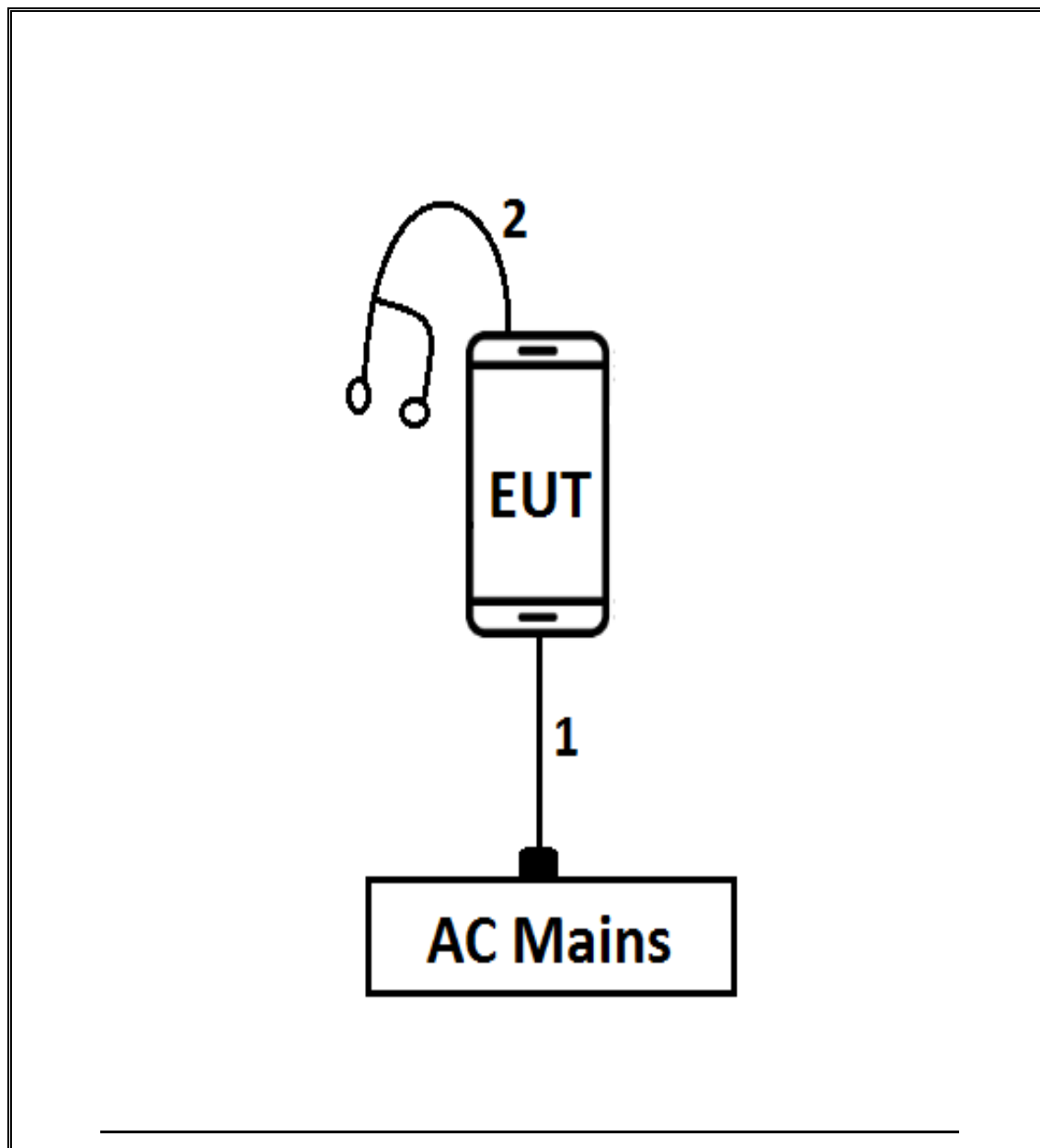

6. TEST AND MEASUREMENT EQUIPMENT

TEST EQUIPMENT LIST				
Description	Manufacturer	Model	Asset	Cal Due
Antenna, Broadband Hybrid, 30MHz to 2000MHz w/4dB Pad	Sunol Sciences Corp.	JB3	T477	06/22/2018
Antenna, Active Loop 9kHz-30MHz	ETS-Lindgren	6502	T1683	02/17/2018
Antenna, Horn 1-18GHz	ETS-Lindgren	3117	T712	01/30/2018
Antenna, Horn 18-26.5GHz	ARA	MWH-1826/B	T449	06/12/2018
Power Meter, P-series single channel	Agilent (Keysight) Technologies	N1911A	T1264	07/08/2018
Power Sensor, P – series, 50MHz to 18GHz, Wideband	Agilent (Keysight) Technologies	N1921A	T413	06/20/2018
Amplifier, 1-26.5GHz	MITEQ	AFS42-00101800-25-S-42	T1165	08/01/2017
Amplifier, 1-26.5GHz	Agilent (Keysight) Technologies	8449B	T404	07/05/2018
Amplifier, 10kHz-1GHz	Agilent (Keysight) Technologies	8447D	T15	08/26/2017
Amplifier, 1-8 GHz	MITEQ	AMF-4D-01000800-30-29P	T1170	04/28/2018
Spectrum Analyzer, PSA, 3Hz to 26.5GHz	Agilent (Keysight) Technologies	E4440A	T199	07/22/2018
Spectrum Analyzer, PSA, 3Hz to 26.5GHz	Agilent (Keysight) Technologies	E4440A	T908	04/13/2018
Spectrum Analyzer, PXA, 3Hz to 44GHz	Agilent (Keysight) Technologies	N9030A	T907	01/23/2018
Spectrum Analyzer, PSA, 3Hz to 26.5GHz	Agilent (Keysight) Technologies	E9030A	T905	01/11/2018
LISN	FISCHER	FCC-LISN-50/250-25-2-01	T1310	06/08/2018

Test Software List			
Description	Manufacturer	Model	Version
Radiated Software	UL	UL EMC	Ver 9.5, Apr 26, 2016
Antenna Port Software	UL	UL RF	Ver 5.1.1, July 15, 2016

The following test and measurement equipment was utilized for the tests documented in this report:

NOTE: *testing is completed before equipment calibration expiration date.

7. MEASUREMENT METHODS

On Time and Duty Cycle: KDB 789033 D02 v01r04, Section B.

6 dB Emission BW: KDB 789033 D02 v01r04, Section C.2.

26 dB Emission BW: KDB 789033 D02 v01r04, Section C.2.1.

99% Occupied BW: KDB 789033 D02 v01r04, Section D.

Conducted Output Power: KDB 789033 D02 v01r04, Section E.3.b (Method PM-G) and KDB 662911 D01 v02r01.

Power Spectral Density: KDB 789033 D02 v01r04, Section F and KDB 662911 D01 v02r01.

Unwanted emissions in restricted bands: KDB 789033 D02 v01r04, Sections G.3, G.4, G.5, and G.6, and KDB 662911 D01 v02r01.

Unwanted emissions in non-restricted bands: KDB 789033 D02 v01r04, Sections G.3, G.4, and G.5, and KDB 662911 D01 v02r01.

AC Power Line Conducted Emissions: ANSI C63.10-2013, Section 6.2.

8. SUMMARY TABLE

FCC Part Section	Test Description	Test Limit	Test Condition	Test Result
§15.407 (a)	Occupied Band width (26dB)	N/A	Conducted	Pass
§15.407	6dB Band width (5.8 GHz)	>500KHz		Pass
§15.407 (a)(1)	TX Cond. Power 5.15-5.25 GHz	<24dBm (FCC) / <23 dBm EIRP or <10+10Log(99% BW) EIRP (IC)		Pass
§15.407 (a)(2)	TX Cond. Power 5.25-5.35 & 5.47-5.725 GHz	<24dBm or <11+10log (OBW) (FCC) / <24 dBm or <11+10Log(99% BW) (IC)		Pass
§15.407 (a)(3)	TX Cond. Power 5.725-5.850 GHz	<30dBm		Pass
§15.407 (a)(1)	PSD (5.15-5.25 GHz)	<11dBm/MHz (FCC) <10 dBm/MHz EIRP (IC)		Pass
§15.407 (a)(2)	PSD (5.3,5.5 GHz)	<11dBm/MHz		Pass
§15.407 (a)(3)	PSD (5.8 GHz)	<30dBm per 500kHz		Pass
§15.207 (a) §15.407(b) (6)	AC Power Line conducted emissions	Section 10		Pass
§15.407 (b) & 15.209	Radiated Spurious Emission	<54dBuV/m	Radiated	Pass

9. ON TIME, DUTY CYCLE AND MEASUREMENT METHODS

9.1. ON TIME AND DUTY CYCLE

LIMITS

None; for reporting purposes only.

PROCEDURE

KDB 789033 Zero-Span Spectrum Analyzer Method.

RESULTS

Mode	ON Time B (msec)	Period (msec)	Duty Cycle x (linear)	Duty Cycle (%)	Duty Cycle Correction Factor (dB)	1/T Minimum VBW (kHz)
802.11a	2.028	2.142	0.947	94.7%	0.24	0.493
802.11n HT20	2.508	2.622	0.957	95.7%	0.19	0.399
802.11n HT40	1.228	1.342	0.915	91.5%	0.39	0.814
802.11ac VHT80	0.592	0.697	0.849	84.9%	0.71	1.689

DUTY CYCLE PLOTS

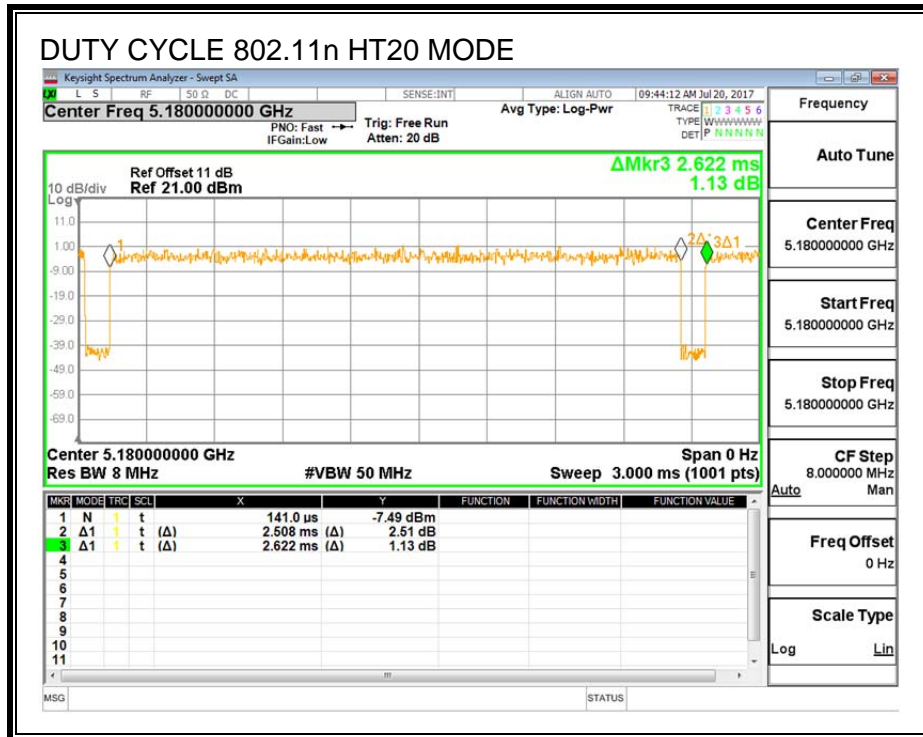
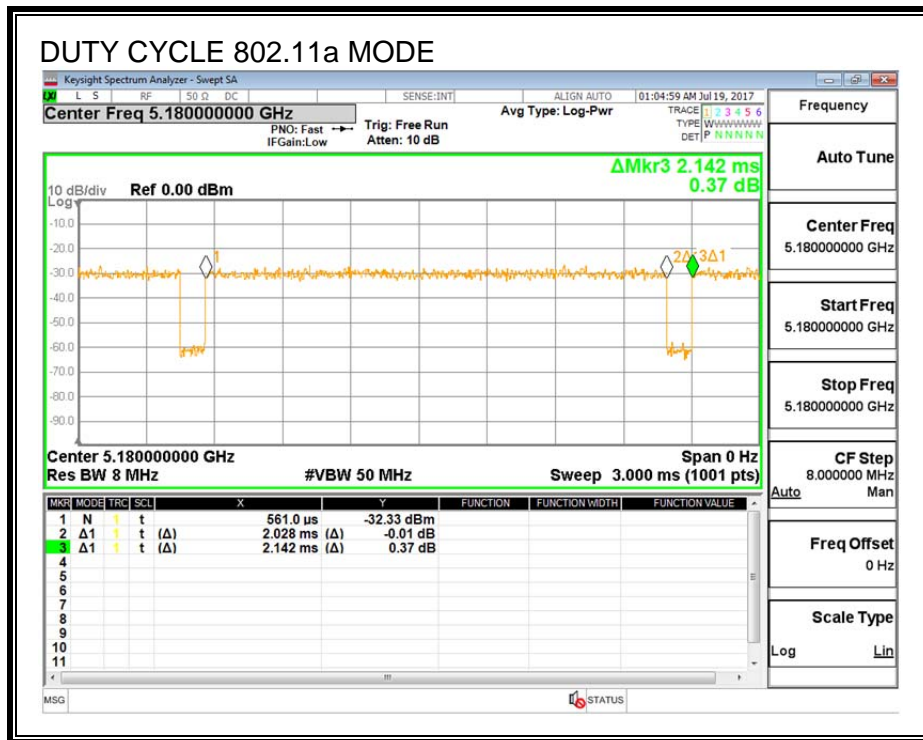

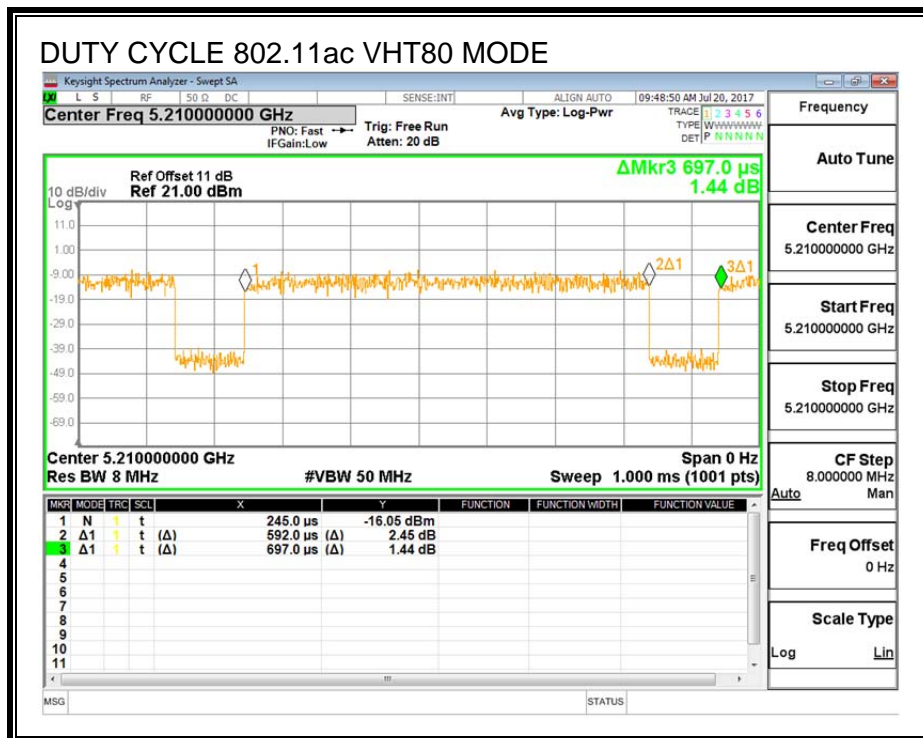
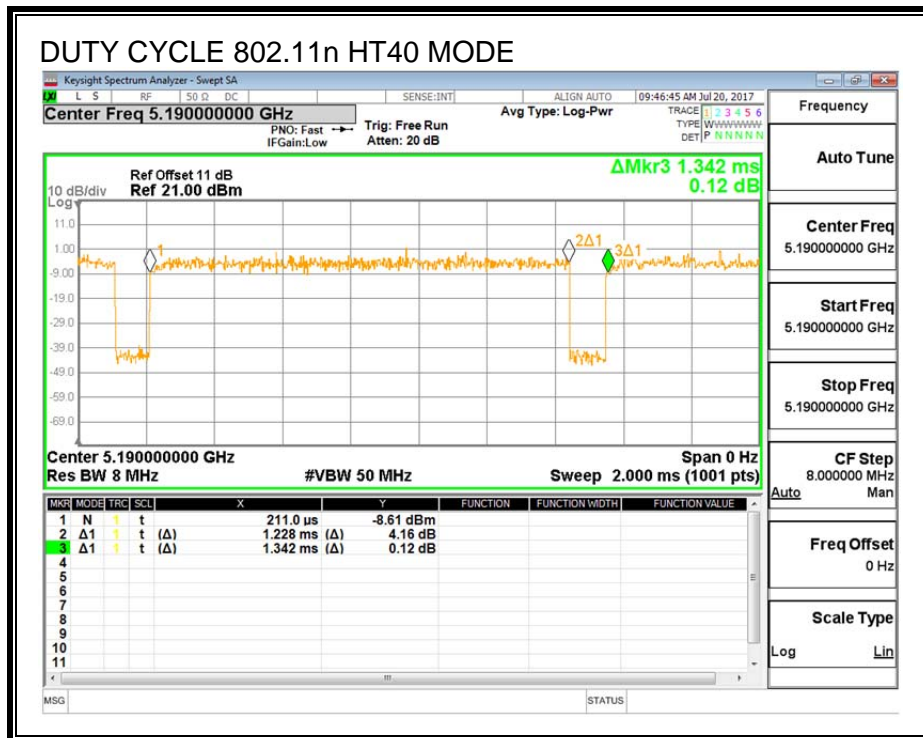

10. ANTENNA PORT TEST RESULTS

10.1. 11a 2TX CDD MIMO MODE IN THE 5.2GHz BAND

10.1.1. 26 dB BANDWIDTH

LIMITS

None; for reporting purposes only.

RESULTS

Channel	Frequency	26 dB BW Chain 0 (MHz)	26 dB BW Chain 1 (MHz)
Low	5180	23.60	22.00
Mid	5200	23.35	22.10
High	5240	23.30	22.15

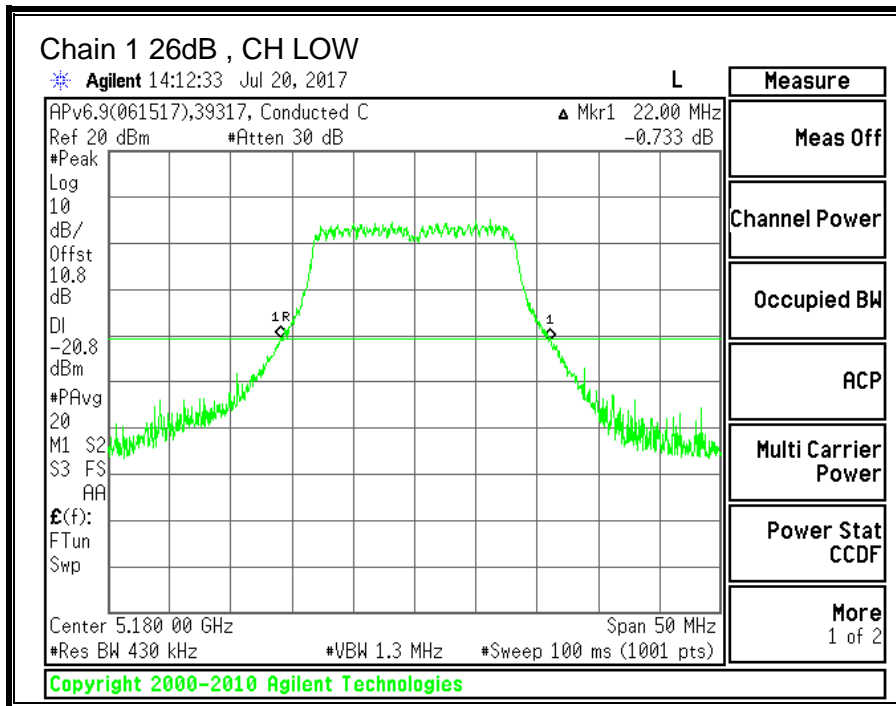
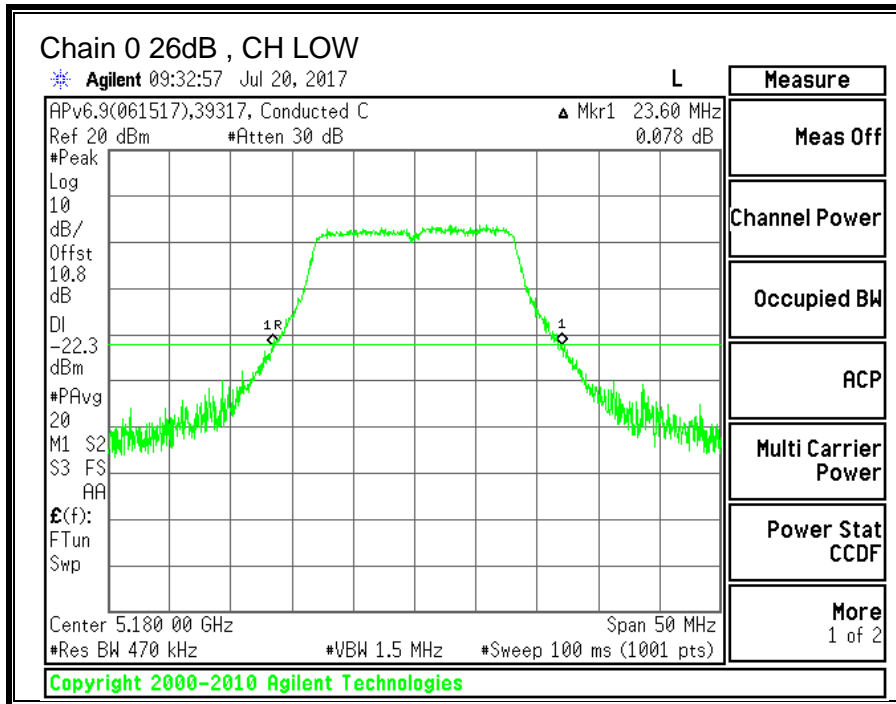

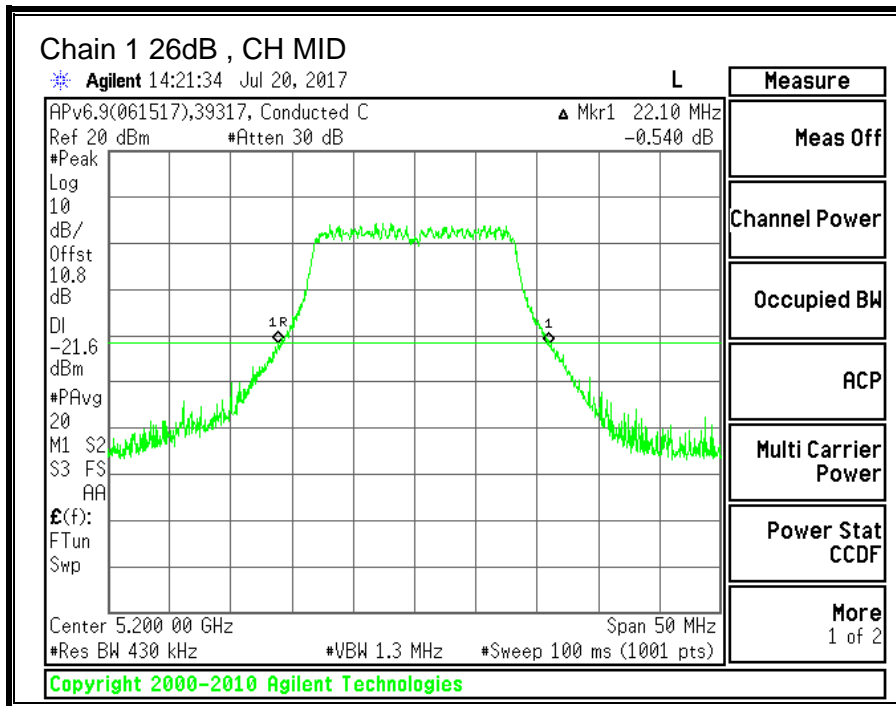
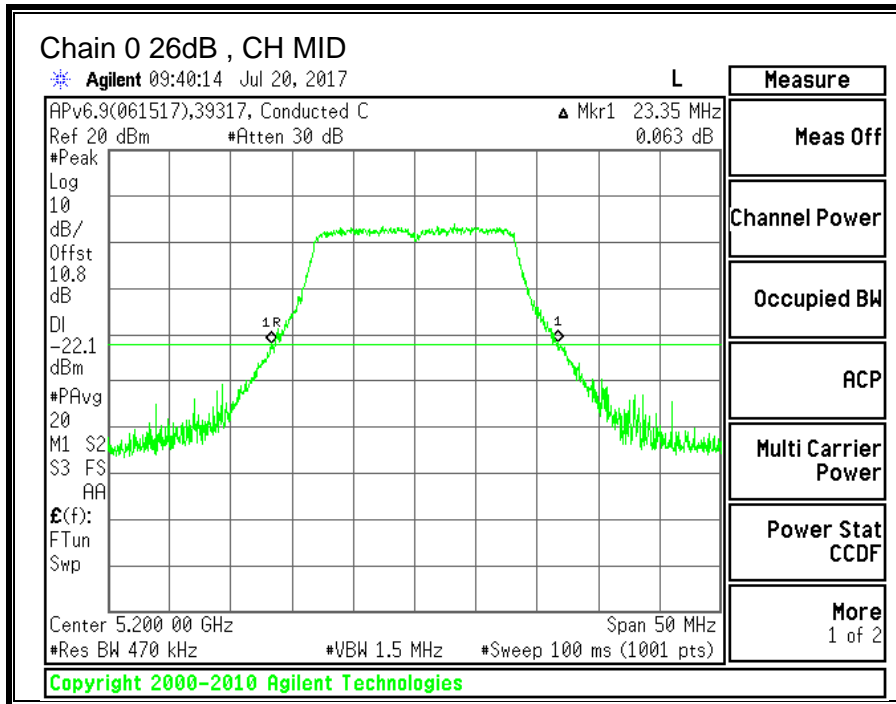

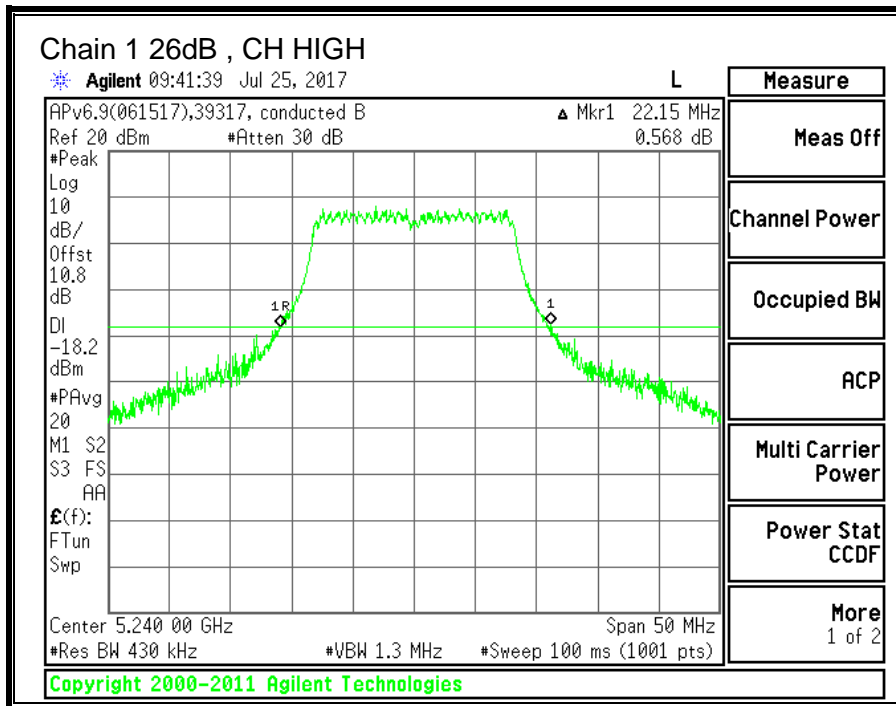
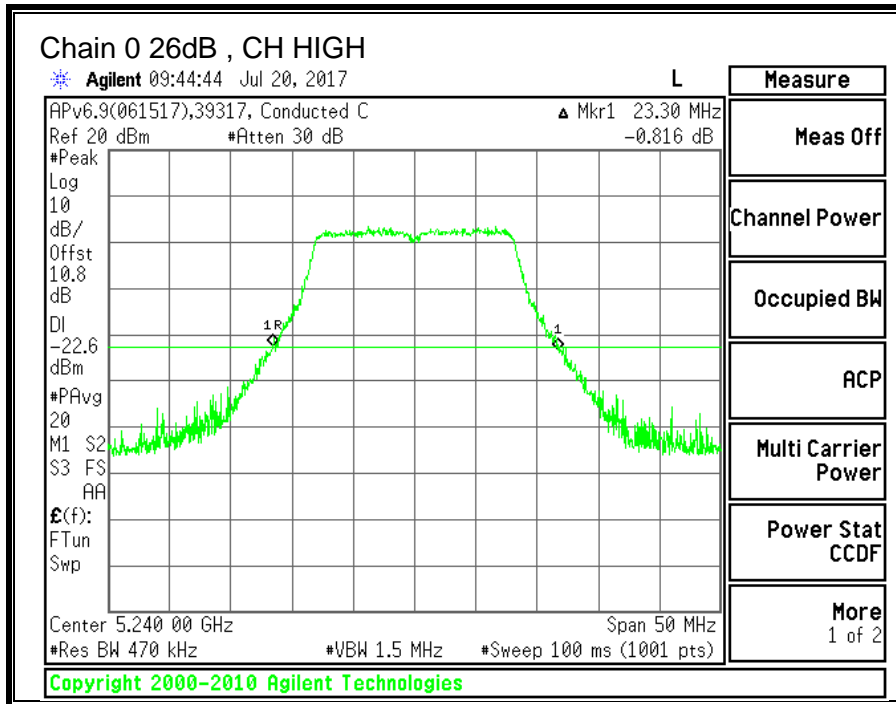

10.1.2. 99% BANDWIDTH

LIMITS

None; for reporting purposes only.

RESULTS

Channel	Frequency	99% BW Chain 0 (MHz)	99% BW Chain 1 (MHz)
Low	5180	16.5259	16.4170
Mid	5200	16.1501	16.3334
High	5240	16.1811	16.2230

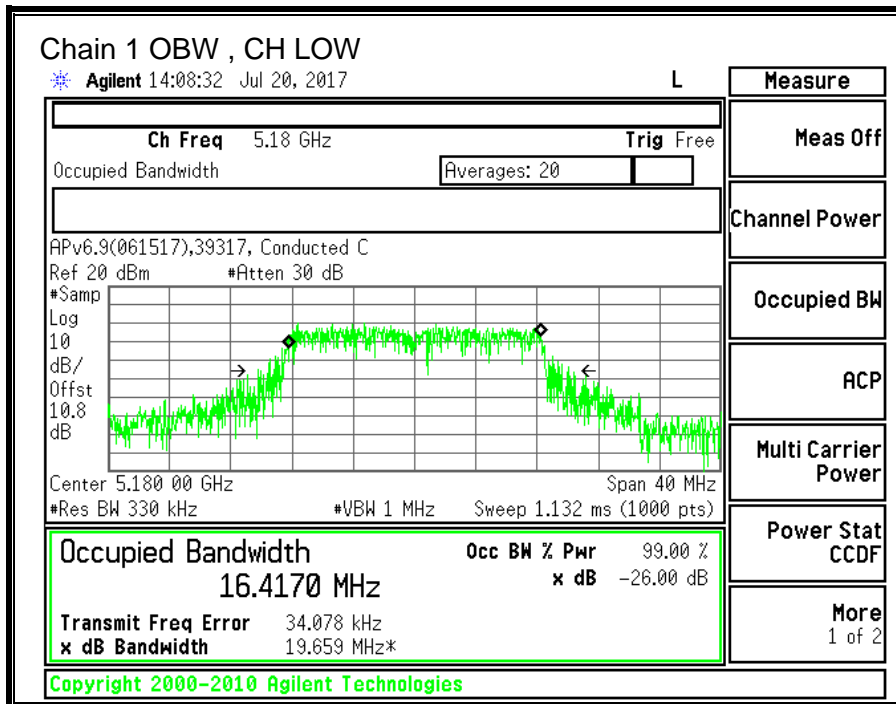
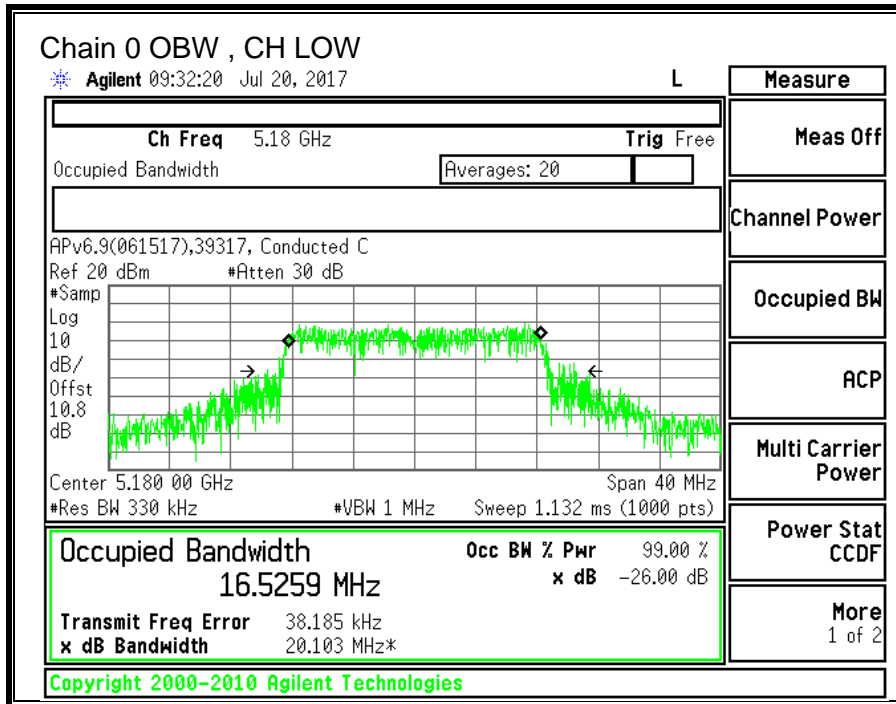

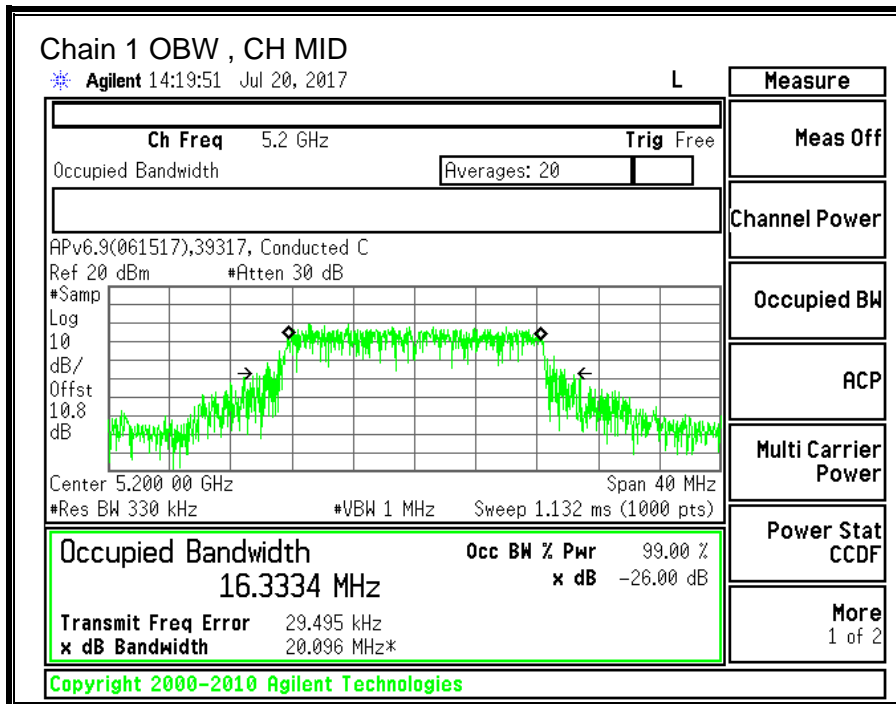
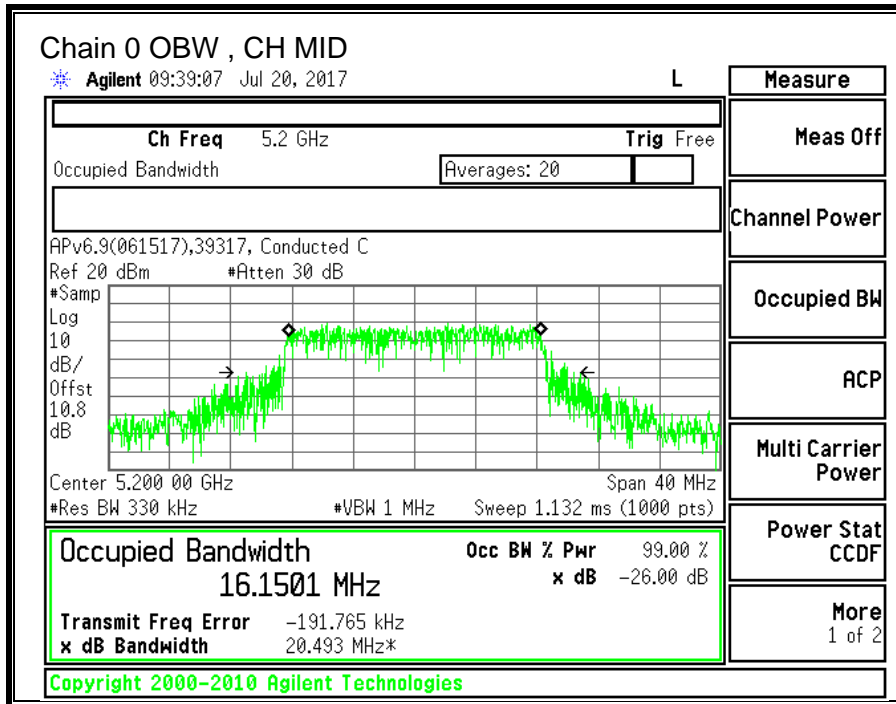

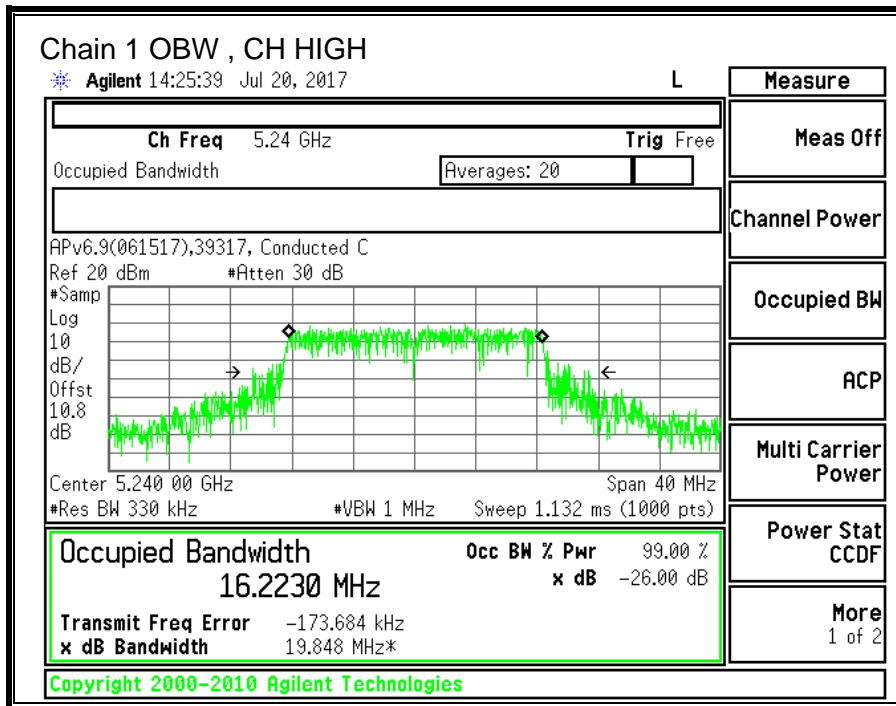
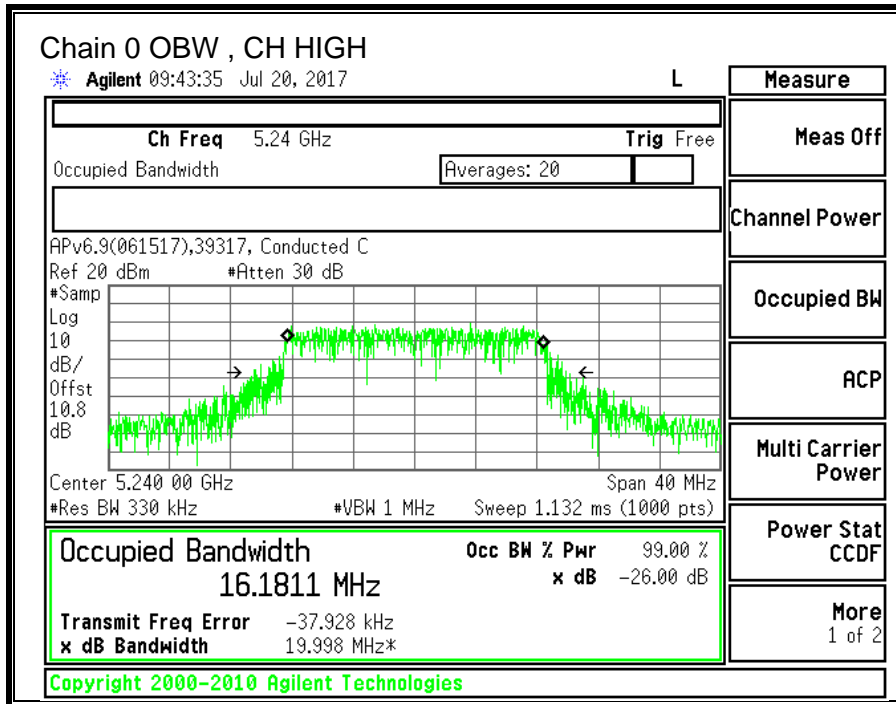

10.1.3. OUTPUT POWER AND PPSD

LIMITS

FCC §15.407 (a) (1)

(i) For an outdoor access point operating in the band 5.15-5.25 GHz, the maximum conducted output power over the frequency band of operation shall not exceed 1 W provided the maximum antenna gain does not exceed 6 dBi. In addition, the maximum power spectral density shall not exceed 17 dBm in any 1 megahertz band. If transmitting antennas of directional gain greater than 6 dBi are used, both the maximum conducted output power and the maximum power spectral density shall be reduced by the amount in dB that the directional gain of the antenna exceeds 6 dBi. The maximum e.i.r.p. at any elevation angle above 30 degrees as measured from the horizon must not exceed 125 mW (21 dBm).

(ii) For an indoor access point operating in the band 5.15-5.25 GHz, the maximum conducted output power over the frequency band of operation shall not exceed 1 W provided the maximum antenna gain does not exceed 6 dBi. In addition, the maximum power spectral density shall not exceed 17 dBm in any 1 megahertz band. If transmitting antennas of directional gain greater than 6 dBi are used, both the maximum conducted output power and the maximum power spectral density shall be reduced by the amount in dB that the directional gain of the antenna exceeds 6 dBi.

(iii) For fixed point-to-point access points operating in the band 5.15-5.25 GHz, the maximum conducted output power over the frequency band of operation shall not exceed 1 W. Fixed point-to-point U-NII devices may employ antennas with directional gain up to 23 dBi without any corresponding reduction in the maximum conducted output power or maximum power spectral density. For fixed point-to-point transmitters that employ a directional antenna gain greater than 23 dBi, a 1 dB reduction in maximum conducted output power and maximum power spectral density is required for each 1 dB of antenna gain in excess of 23 dBi. Fixed, point-to-point operations exclude the use of point-to-multipoint systems, omnidirectional applications, and multiple collocated transmitters transmitting the same information. The operator of the U-NII device, or if the equipment is professionally installed, the installer, is responsible for ensuring that systems employing high gain directional antennas are used exclusively for fixed, point-to-point operations.

(iv) For mobile and portable client devices in the 5.15-5.25 GHz band, the maximum conducted output power over the frequency band of operation shall not exceed 250 mW provided the maximum antenna gain does not exceed 6 dBi. In addition, the maximum power spectral density shall not exceed 11 dBm in any 1 megahertz band. If transmitting antennas of directional gain greater than 6 dBi are used, both the maximum conducted output power and the maximum power spectral density shall be reduced by the amount in dB that the directional gain of the antenna exceeds 6 dBi.

TEST PROCEDURE

Measurements perform using a wideband gated RF power meter provided that the gate parameters are adjusted such that the power is measured only when the EUT is transmitting at its maximum power control level. Since the measurement is made only during the ON time of the transmitter, no duty cycle correction factor is required.

DIRECTIONAL ANTENNA GAIN

For power, the TX chains are uncorrelated and the antenna gain is unequal among the chains. The directional gain is:

5150-5250 MHz

Chain 0 Antenna Gain (dBi)	Chain 1 Antenna Gain (dBi)	Uncorrelated Chains Directional Gain (dBi)
0.10	1.60	0.91

For PSD the TX chains are correlated and the antenna gain is unequal among the chains. The directional gain is:

5150-5250 MHz

Chain 0 Antenna Gain (dBi)	Chain 1 Antenna Gain (dBi)	Correlated Chains Directional Gain (dBi)
0.10	1.60	3.89

RESULTS

ID:	39317	Date:	07/21/17
------------	-------	--------------	----------

Bandwidth and Antenna Gain

Channel	Frequency (MHz)	Min 26 dB BW (MHz)	Min 99% BW (MHz)	Directional Gain for Power (dBi)	Directional Gain for PPSD (dBi)
Low	5180	22.00	16.42	0.91	3.89
Mid	5200	22.10	16.15	0.91	3.89
High	5240	22.15	16.18	0.91	3.89

Limits

Channel	Frequency (MHz)	FCC Power Limit (dBm)	IC EIRP Limit (dBm)	Max IC Power (dBm)	Power Limit (dBm)	FCC PPSD Limit (dBm)	IC eirp PSD Limit (dBm)	PPSD Limit (dBm)
Low	5180	24.00	22.15	21.24	21.24	11.00	10.00	6.11
Mid	5200	24.00	22.08	21.17	21.17	11.00	10.00	6.11
High	5240	24.00	22.09	21.18	21.18	11.00	10.00	6.11

Duty Cycle CF (dB)	0.24	Included in Calculations of Corr'd PPSD
---------------------------	------	--

Output Power Results

Channel	Frequency (MHz)	Chain 0 Meas Power (dBm)	Chain 1 Meas Power (dBm)	Total Corr'd Power (dBm)	Power Limit (dBm)	Power Margin (dB)
Low	5180	13.28	13.47	16.39	21.24	-4.86
Mid	5200	13.02	13.48	16.27	21.17	-4.91
High	5240	13.36	13.72	16.55	21.18	-4.63

PPSD Results

Channel	Frequency (MHz)	Chain 0 Meas PPSD (dBm)	Chain 1 Meas PPSD (dBm)	Total Corr'd PPSD (dBm)	PPSD Limit (dBm)	PPSD Margin (dB)
Low	5180	2.003	2.406	5.46	6.11	-0.65
Mid	5200	1.683	2.302	5.25	6.11	-0.86
High	5240	2.326	2.520	5.67	6.11	-0.44

Note: the power readings above were measured with gated method, and the measurement was taken only during the ON time. No duty cycle correction was necessary.

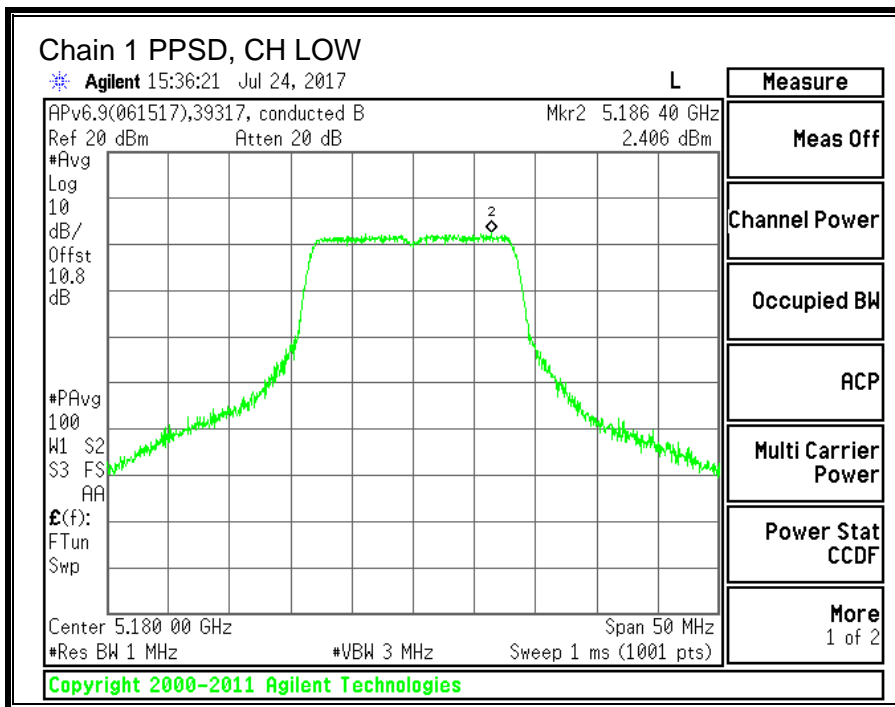
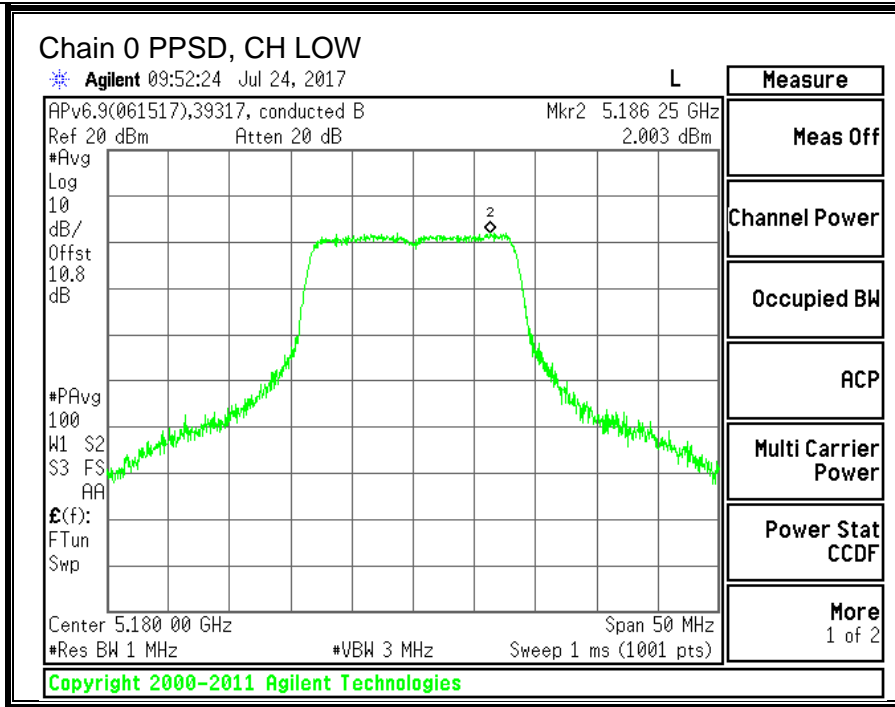

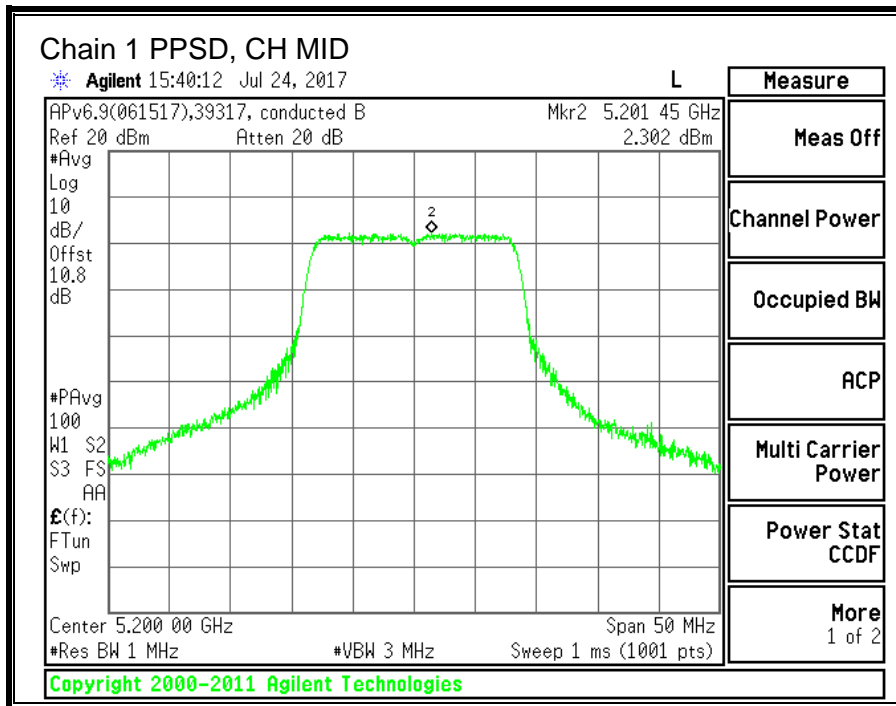
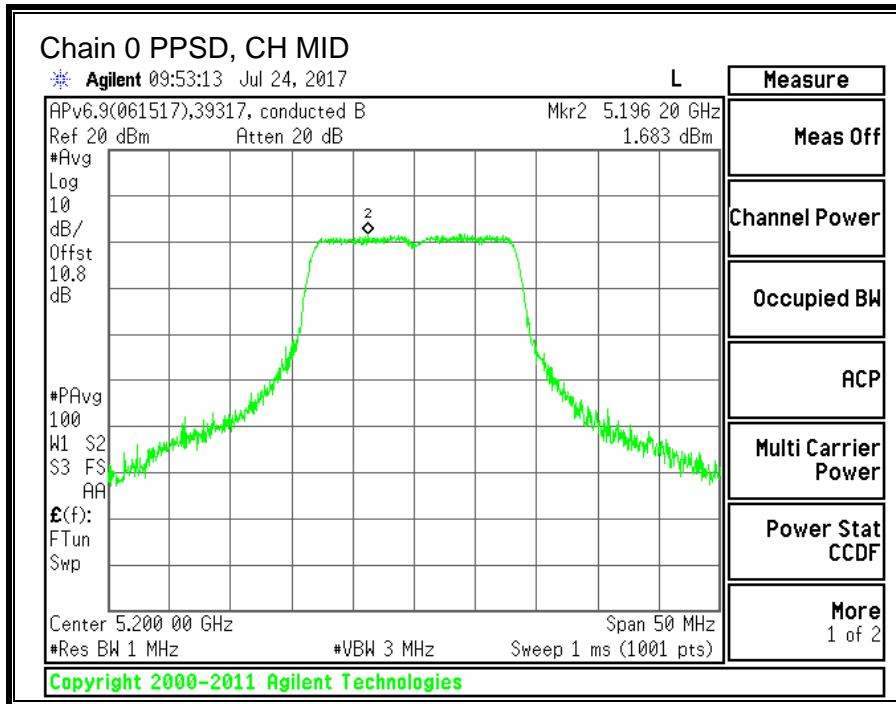

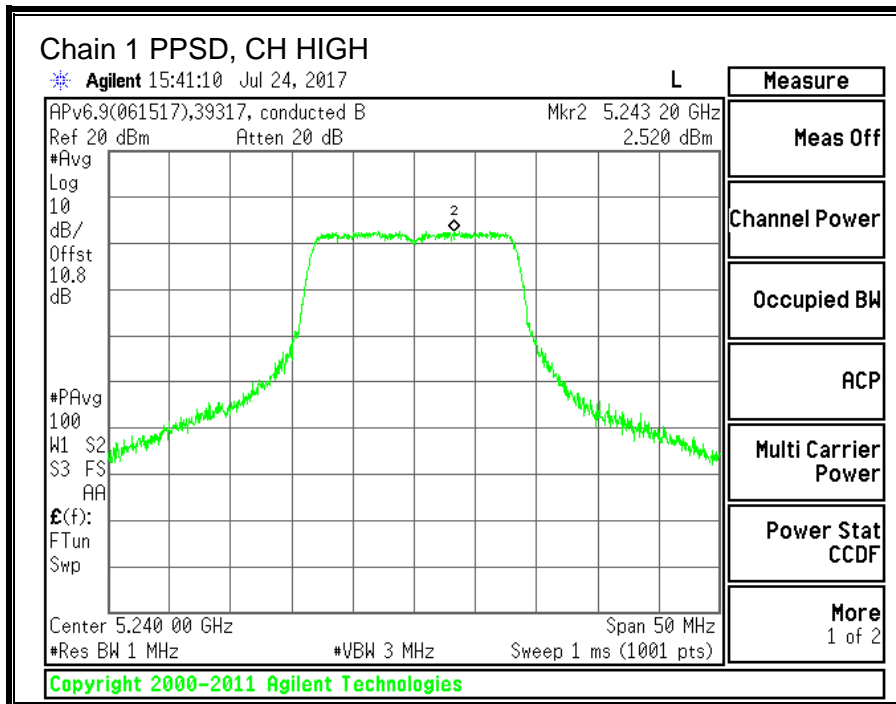
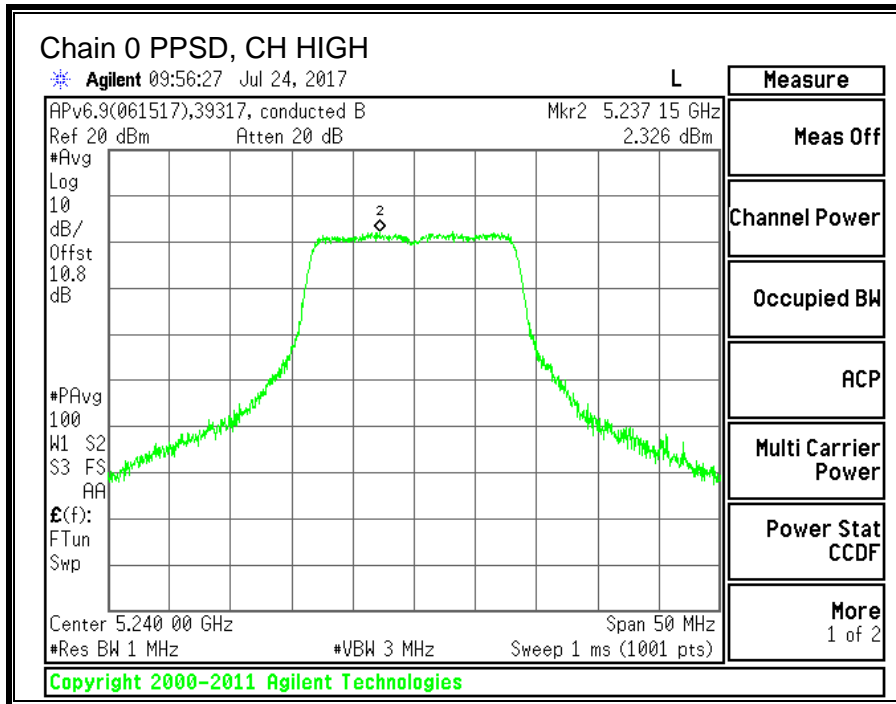

10.2. 11n HT20 2TX CDD MIMO MODE IN THE 5.2GHz BAND

10.2.1. 26 dB BANDWIDTH

LIMITS

None; for reporting purposes only.

RESULTS

Channel	Frequency	26 dB BW Chain 0 (MHz)	26 dB BW Chain 1 (MHz)
Low	5180	24.25	22.60
Mid	5200	24.85	23.15
High	5240	24.90	23.20

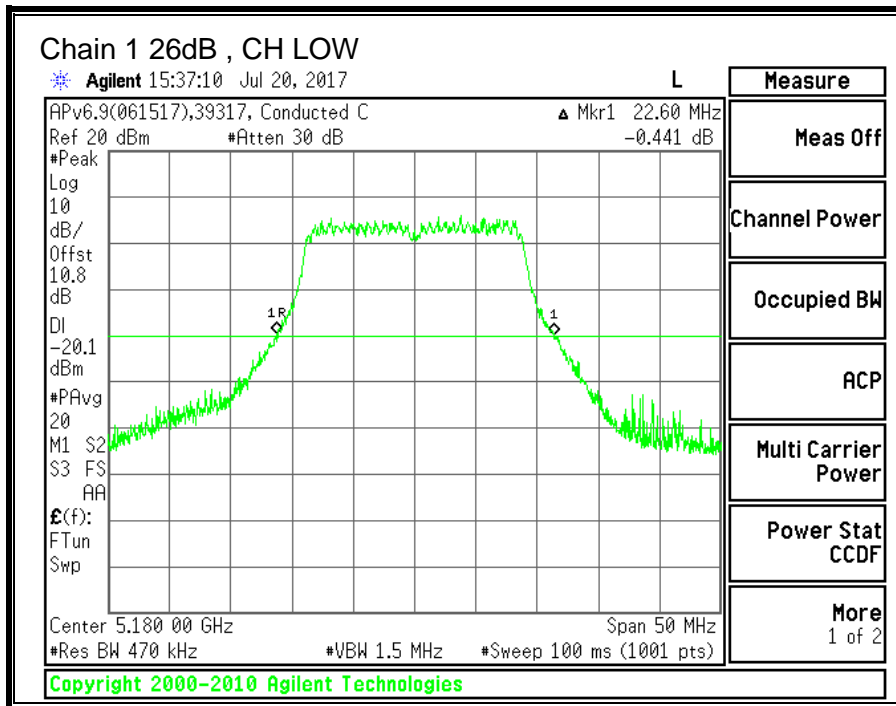
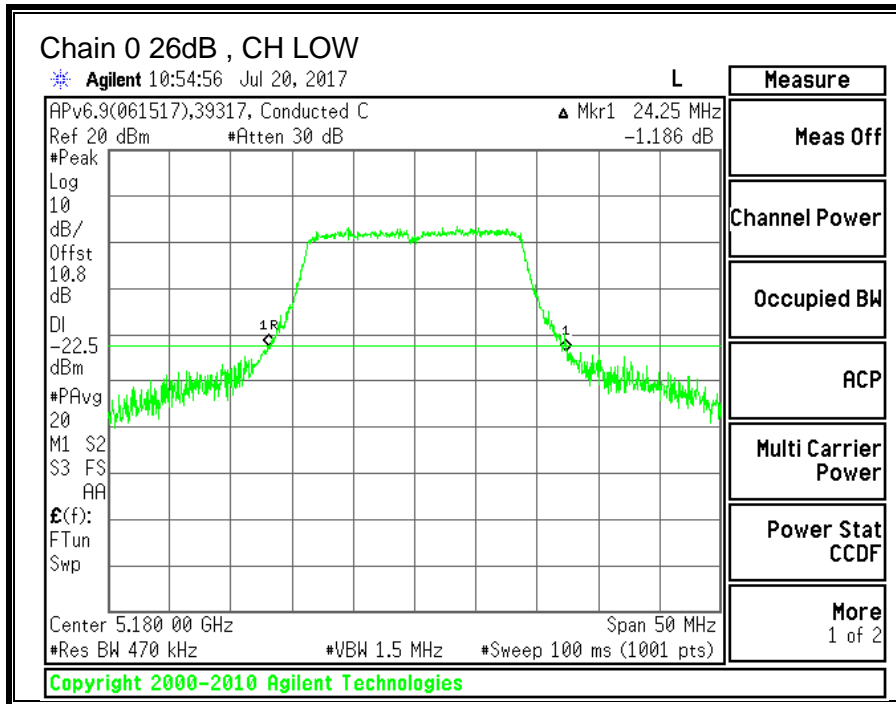

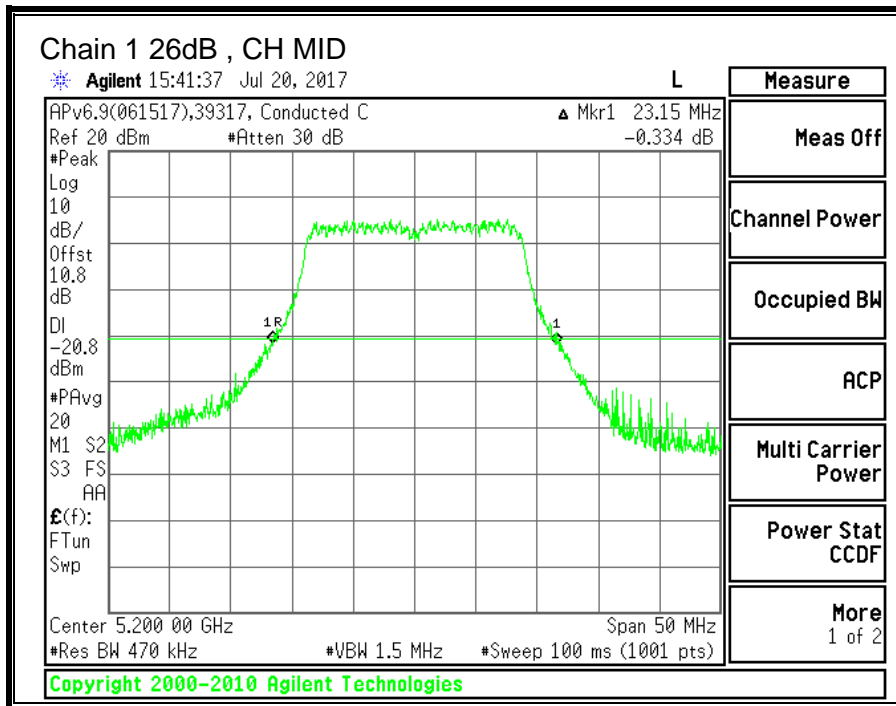
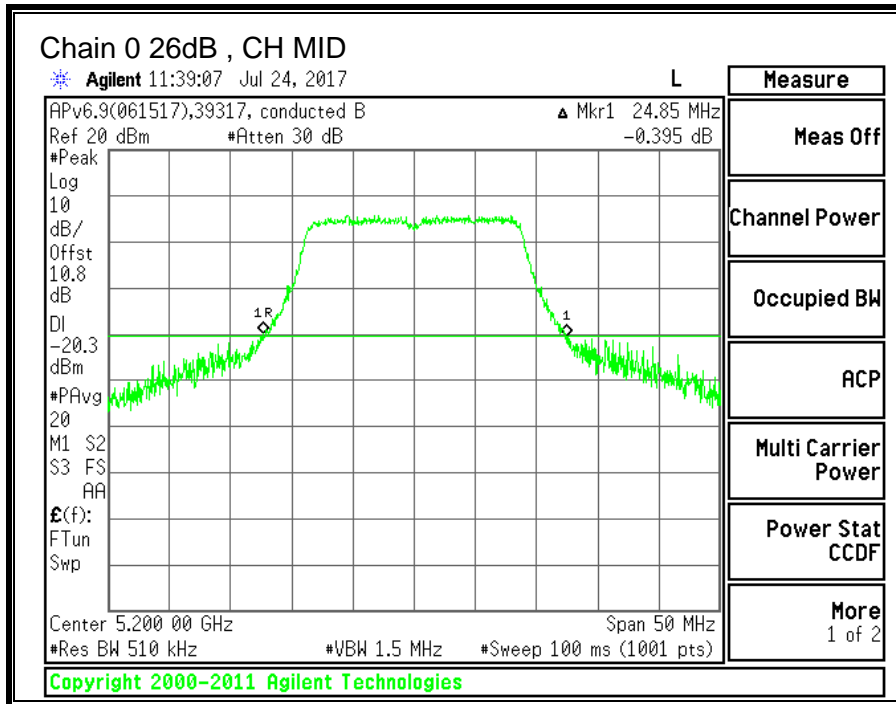

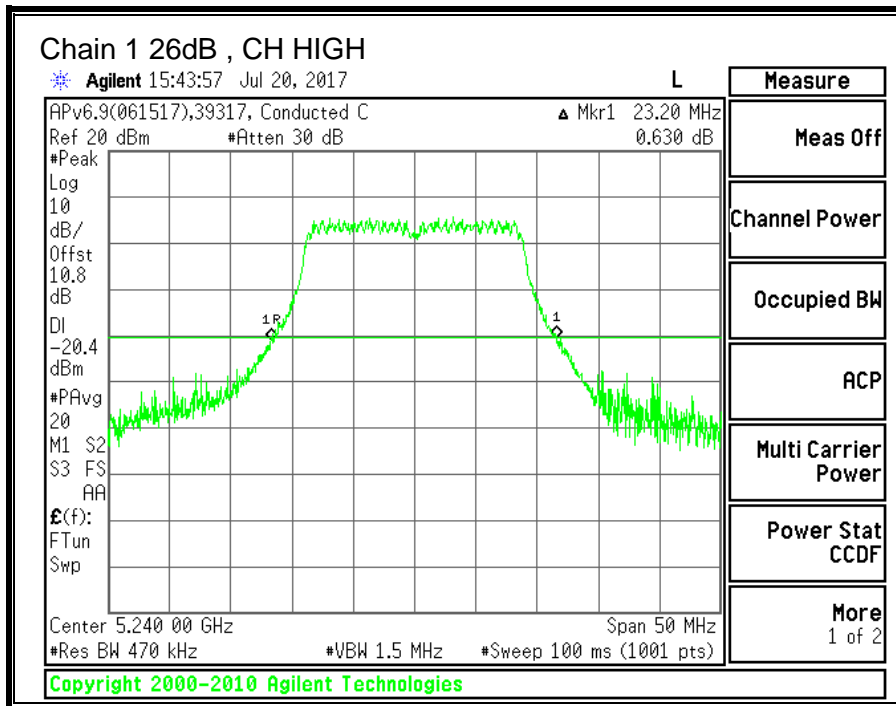
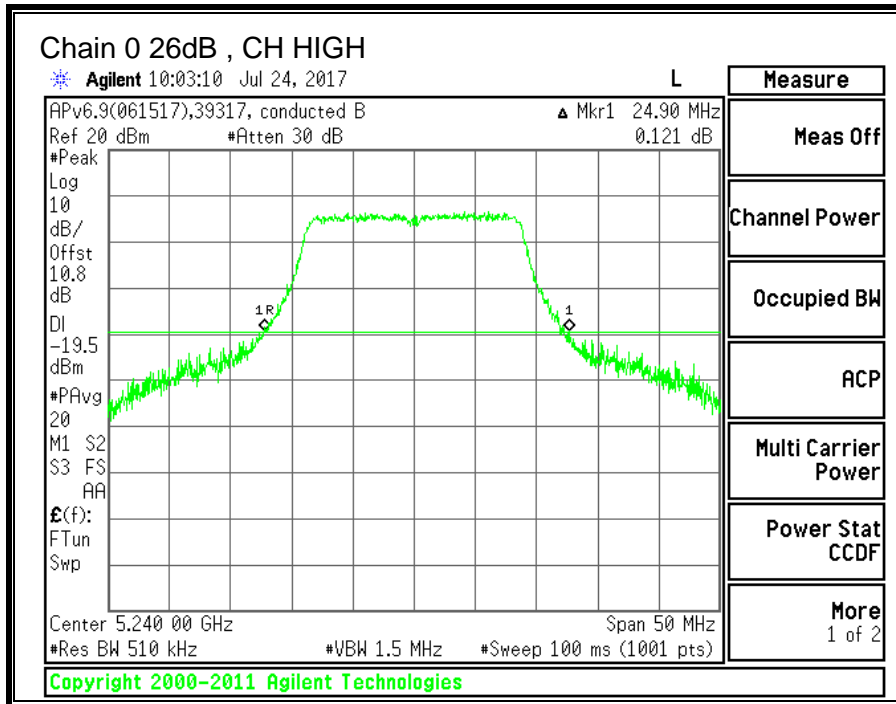

10.2.2. 99% BANDWIDTH

LIMITS

None; for reporting purposes only.

RESULTS

Channel	Frequency	99% BW Chain 0 (MHz)	99% BW Chain 1 (MHz)
Low	5180	17.3620	17.3973
Mid	5200	17.7846	17.4641
High	5240	17.4698	17.5249

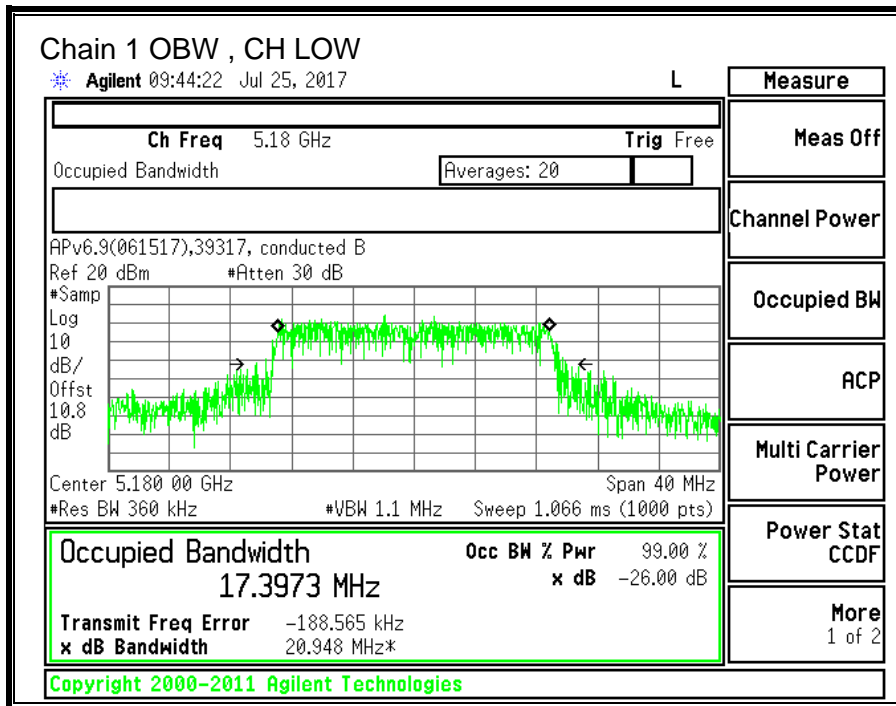
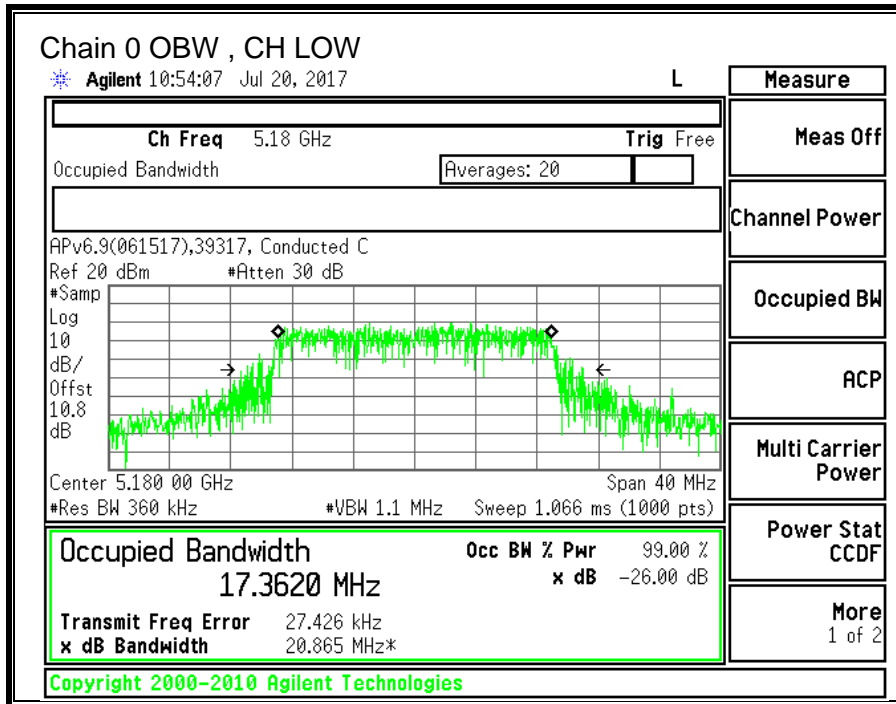

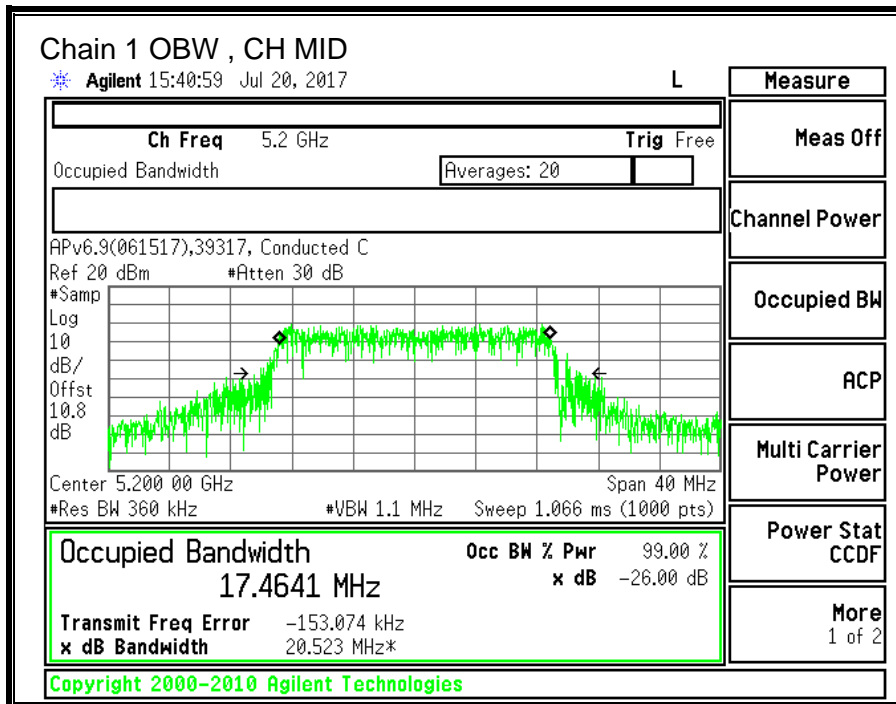
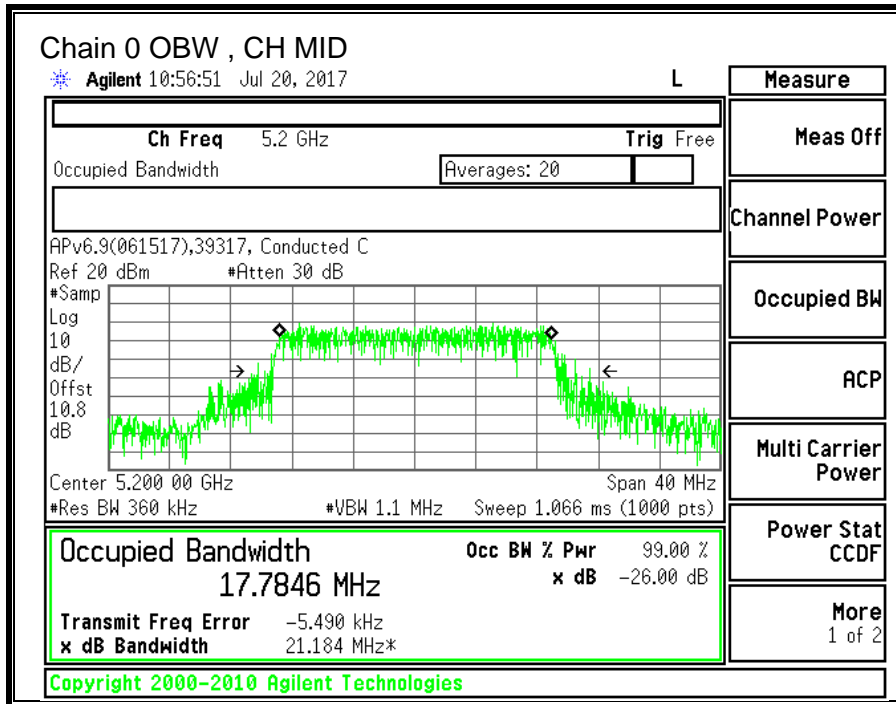

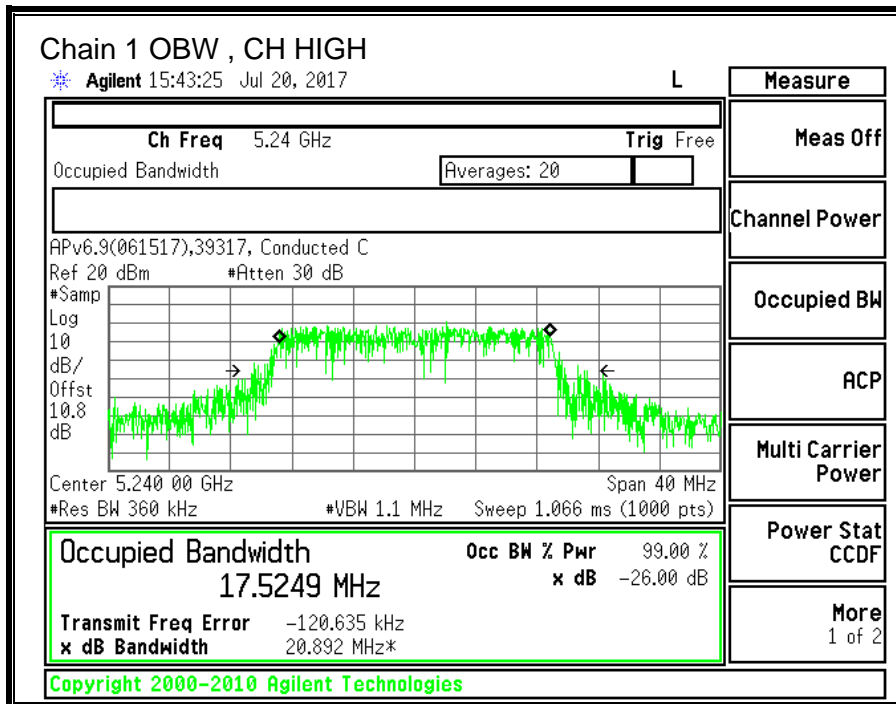
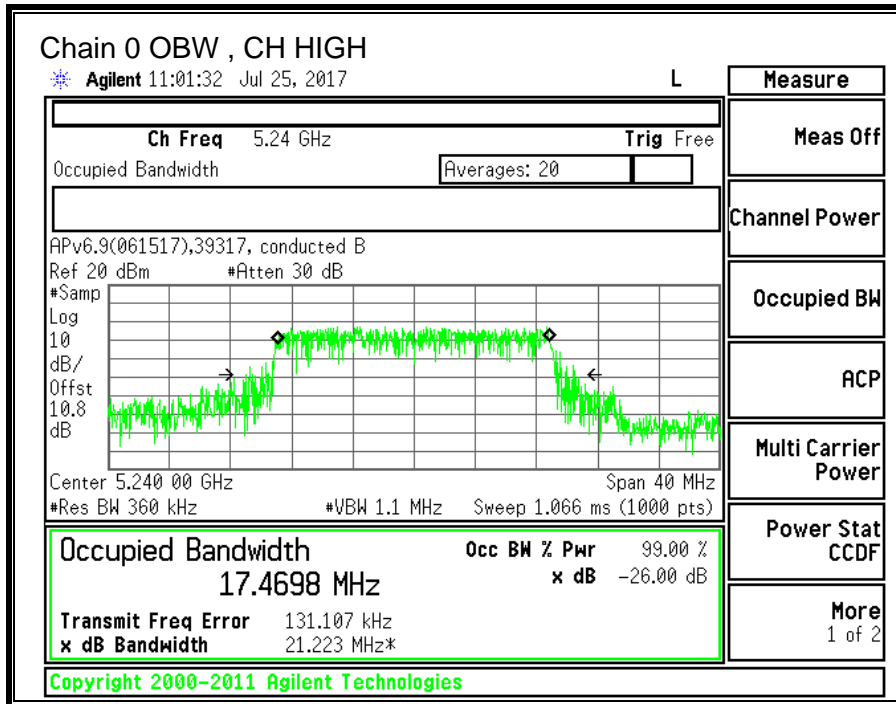

10.2.3. OUTPUT POWER AND PPSD

LIMITS

FCC §15.407 (a) (1)

(i) For an outdoor access point operating in the band 5.15-5.25 GHz, the maximum conducted output power over the frequency band of operation shall not exceed 1 W provided the maximum antenna gain does not exceed 6 dBi. In addition, the maximum power spectral density shall not exceed 17 dBm in any 1 megahertz band. If transmitting antennas of directional gain greater than 6 dBi are used, both the maximum conducted output power and the maximum power spectral density shall be reduced by the amount in dB that the directional gain of the antenna exceeds 6 dBi. The maximum e.i.r.p. at any elevation angle above 30 degrees as measured from the horizon must not exceed 125 mW (21 dBm).

(ii) For an indoor access point operating in the band 5.15-5.25 GHz, the maximum conducted output power over the frequency band of operation shall not exceed 1 W provided the maximum antenna gain does not exceed 6 dBi. In addition, the maximum power spectral density shall not exceed 17 dBm in any 1 megahertz band. If transmitting antennas of directional gain greater than 6 dBi are used, both the maximum conducted output power and the maximum power spectral density shall be reduced by the amount in dB that the directional gain of the antenna exceeds 6 dBi.

(iii) For fixed point-to-point access points operating in the band 5.15-5.25 GHz, the maximum conducted output power over the frequency band of operation shall not exceed 1 W. Fixed point-to-point U-NII devices may employ antennas with directional gain up to 23 dBi without any corresponding reduction in the maximum conducted output power or maximum power spectral density. For fixed point-to-point transmitters that employ a directional antenna gain greater than 23 dBi, a 1 dB reduction in maximum conducted output power and maximum power spectral density is required for each 1 dB of antenna gain in excess of 23 dBi. Fixed, point-to-point operations exclude the use of point-to-multipoint systems, omnidirectional applications, and multiple collocated transmitters transmitting the same information. The operator of the U-NII device, or if the equipment is professionally installed, the installer, is responsible for ensuring that systems employing high gain directional antennas are used exclusively for fixed, point-to-point operations.

(iv) For mobile and portable client devices in the 5.15-5.25 GHz band, the maximum conducted output power over the frequency band of operation shall not exceed 250 mW provided the maximum antenna gain does not exceed 6 dBi. In addition, the maximum power spectral density shall not exceed 11 dBm in any 1 megahertz band. If transmitting antennas of directional gain greater than 6 dBi are used, both the maximum conducted output power and the maximum power spectral density shall be reduced by the amount in dB that the directional gain of the antenna exceeds 6 dBi.

TEST PROCEDURE

Measurements perform using a wideband gated RF power meter provided that the gate parameters are adjusted such that the power is measured only when the EUT is transmitting at its maximum power control level. Since the measurement is made only during the ON time of the transmitter, no duty cycle correction factor is required.

DIRECTIONAL ANTENNA GAIN

For power, the TX chains are uncorrelated and the antenna gain is unequal among the chains. The directional gain is:

5150-5250 MHz

Chain 0 Antenna Gain (dBi)	Chain 1 Antenna Gain (dBi)	Uncorrelated Chains Directional Gain (dBi)
0.10	1.60	0.91

For PSD the TX chains are correlated and the antenna gain is unequal among the chains. The directional gain is:

5150-5250 MHz

Chain 0 Antenna Gain (dBi)	Chain 1 Antenna Gain (dBi)	Correlated Chains Directional Gain (dBi)
0.10	1.60	3.89

RESULTS

ID:	39317	Date:	07/21/17
------------	-------	--------------	----------

Bandwidth and Antenna Gain

Channel	Frequency (MHz)	Min 26 dB BW (MHz)	Min 99% BW (MHz)	Directional Gain for Power (dBi)	Directional Gain for PPSD (dBi)
Low	5180	22.60	17.36	0.91	3.89
Mid	5200	23.15	17.46	0.91	3.89
High	5240	23.20	17.47	0.91	3.89

Limits

Channel	Frequency (MHz)	FCC Power Limit (dBm)	IC EIRP Limit (dBm)	Max IC Power (dBm)	Power Limit (dBm)	FCC PPSD Limit (dBm)	IC eirp PSD Limit (dBm)	PPSD Limit (dBm)
Low	5180	24.00	22.40	21.49	21.49	11.00	10.00	6.11
Mid	5200	24.00	22.42	21.51	21.51	11.00	10.00	6.11
High	5240	24.00	22.42	21.51	21.51	11.00	10.00	6.11

Duty Cycle CF (dB)	0.19	Included in Calculations of Corr'd PPSD
---------------------------	------	--

Output Power Results

Channel	Frequency (MHz)	Chain 0 Meas Power (dBm)	Chain 1 Meas Power (dBm)	Total Corr'd Power (dBm)	Power Limit (dBm)	Power Margin (dB)
Low	5180	12.87	13.48	16.20	21.49	-5.29
Mid	5200	12.99	13.46	16.24	21.51	-5.27
High	5240	13.36	13.87	16.63	21.51	-4.88

PPSD Results

Channel	Frequency (MHz)	Chain 0 Meas PPSD (dBm)	Chain 1 Meas PPSD (dBm)	Total Corr'd PPSD (dBm)	PPSD Limit (dBm)	PPSD Margin (dB)
Low	5180	1.507	2.156	5.04	6.11	-1.07
Mid	5200	1.667	2.279	5.18	6.11	-0.93
High	5240	1.532	1.672	4.80	6.11	-1.31

Note: the power readings above were measured with gated method, and the measurement was taken only during the ON time. No duty cycle correction was necessary.

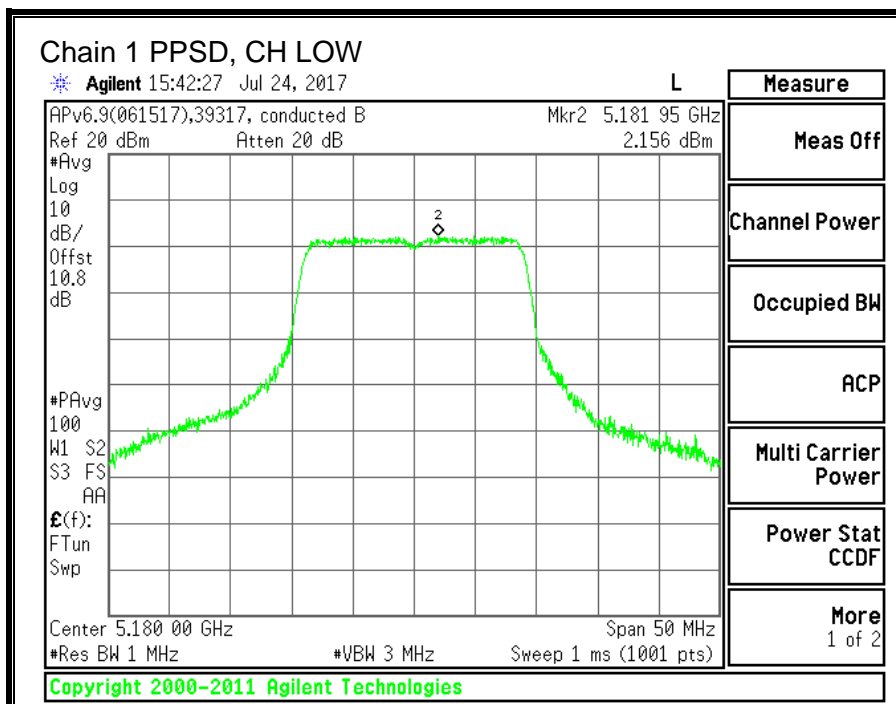
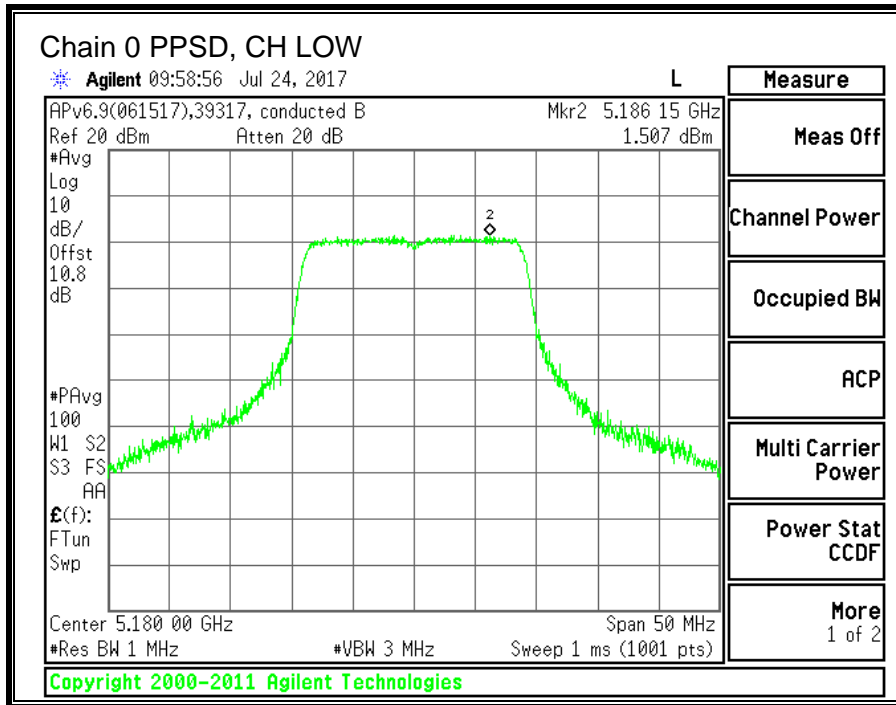

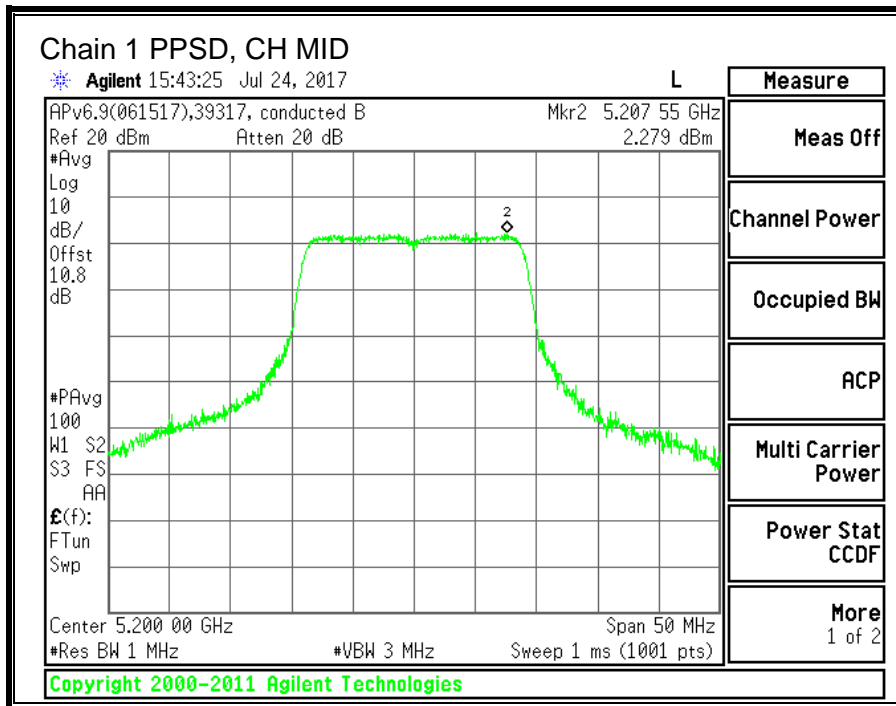
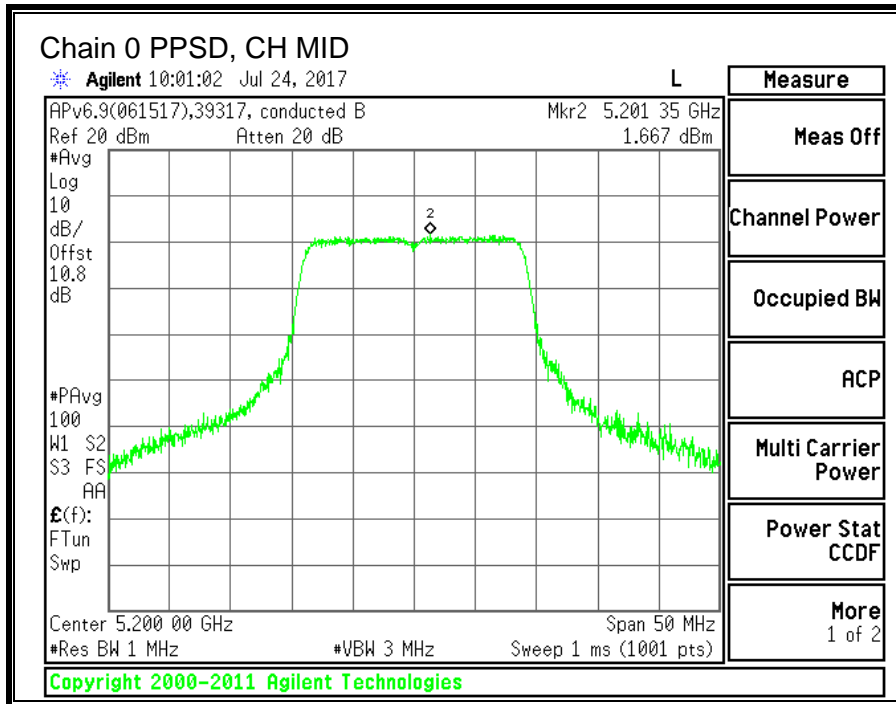

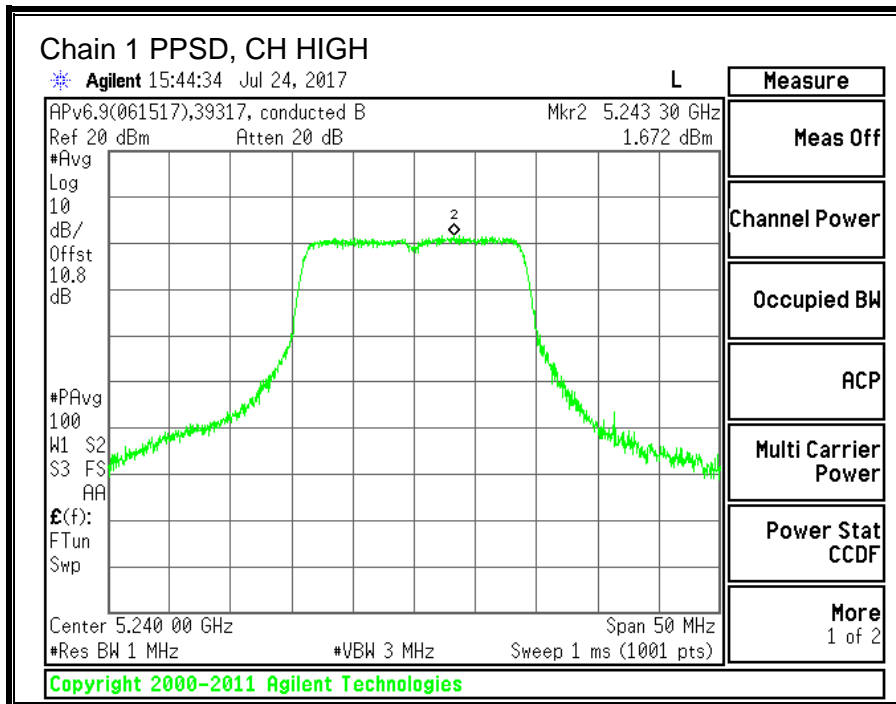
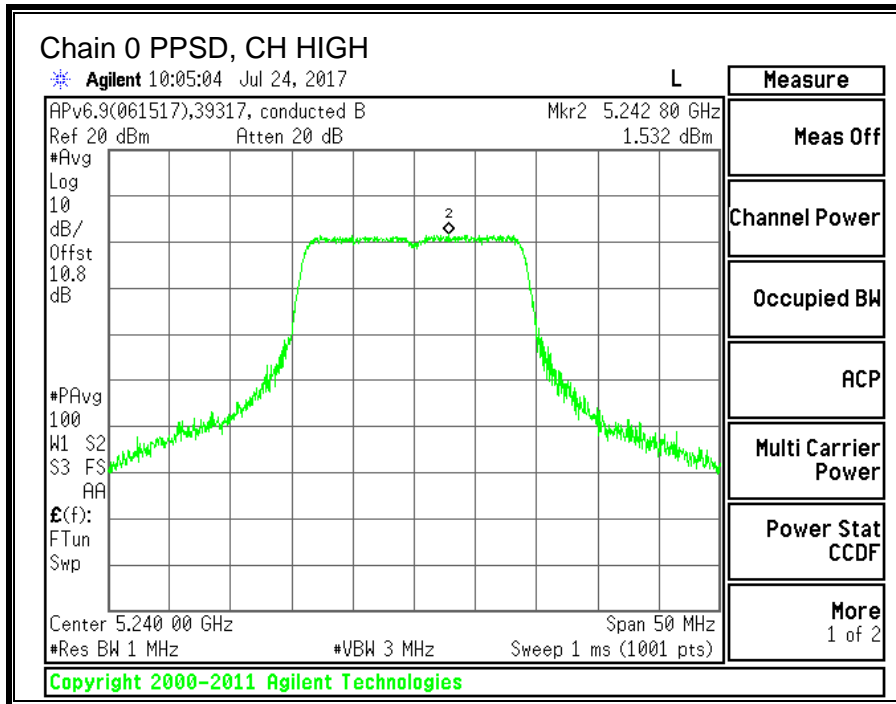

10.3. 11n HT40 2TX CDD MIMO MODE IN THE 5.2GHz BAND

10.3.1. 26 dB BANDWIDTH

LIMITS

None; for reporting purposes only.

RESULTS

Channel	Frequency	26 dB BW Chain 0 (MHz)	26 dB BW Chain 1 (MHz)
Low	5190	46.40	42.40
High	5230	43.20	42.80

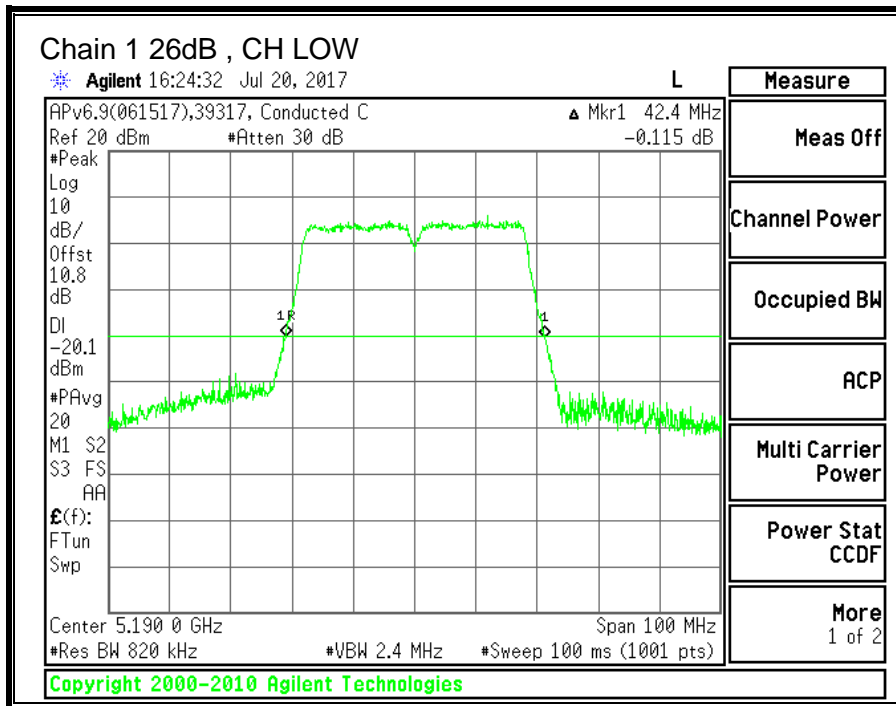
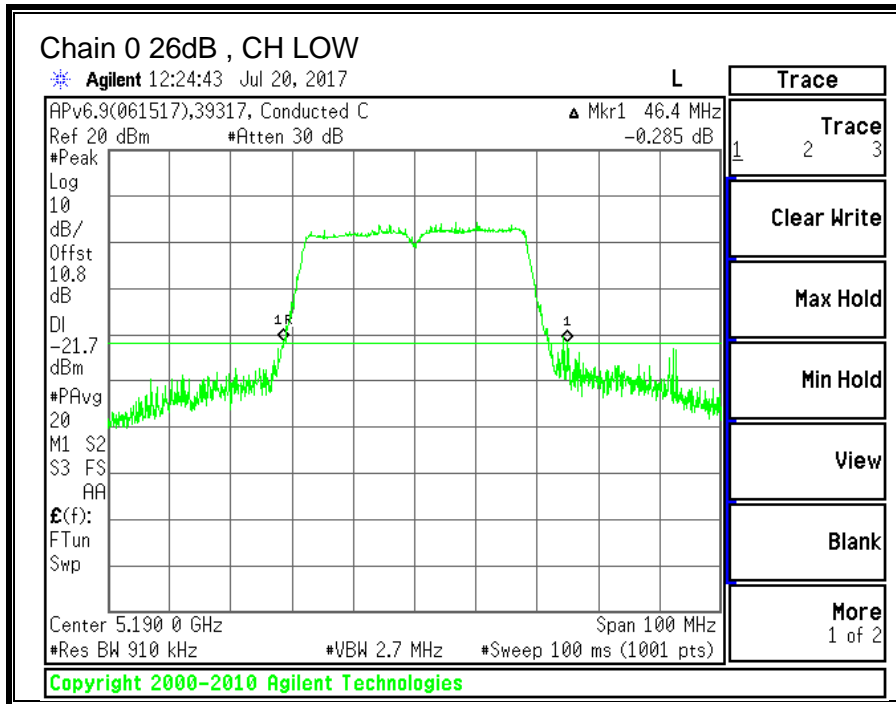

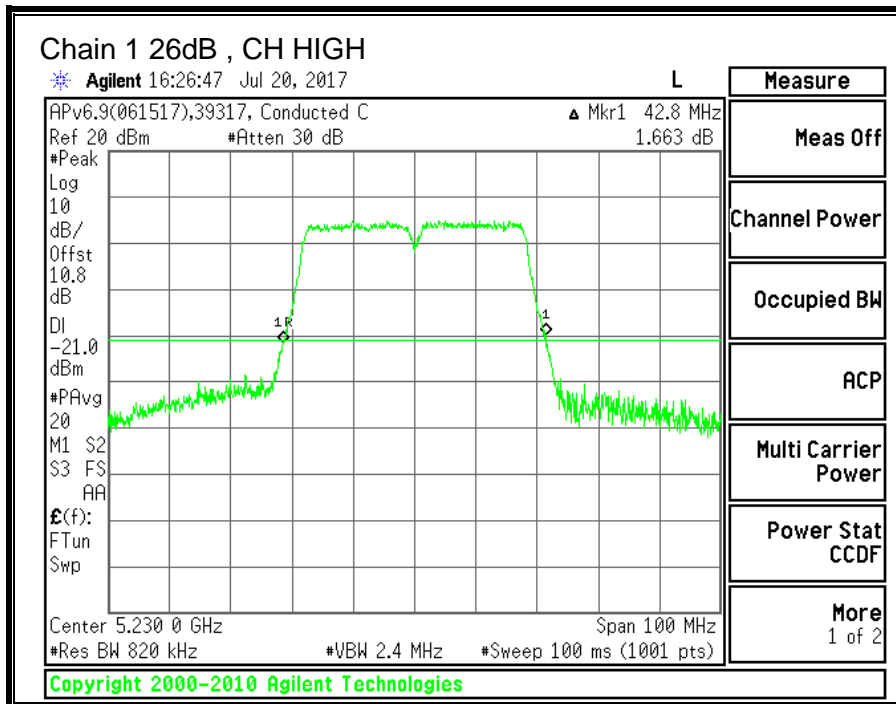
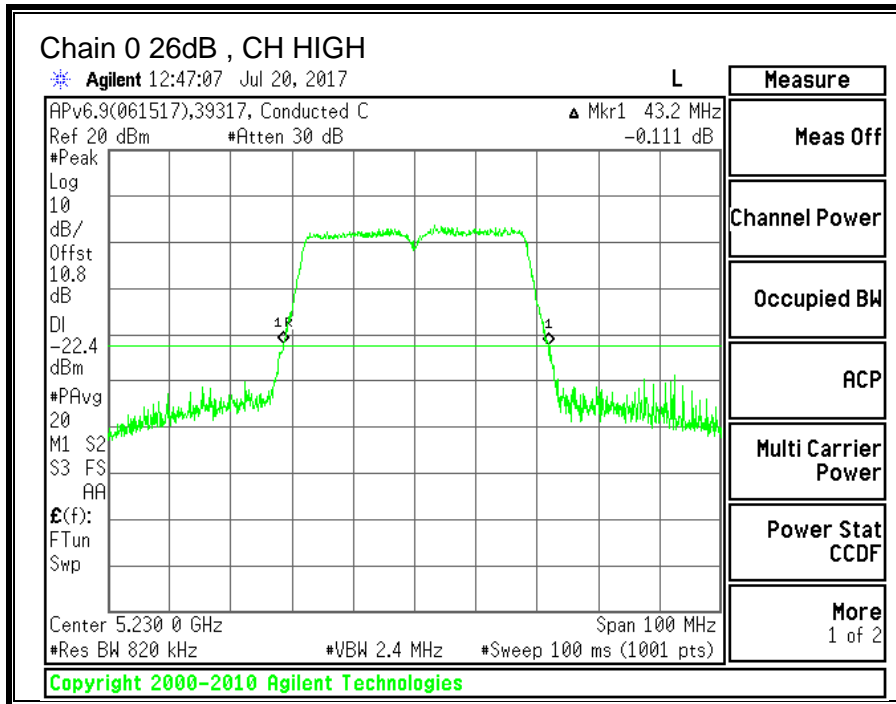

10.3.2. 99% BANDWIDTH

LIMITS

None; for reporting purposes only.

RESULTS

Channel	Frequency	99% BW Chain 0 (MHz)	99% BW Chain 1 (MHz)
Low	5190	36.1281	35.2392
High	5230	35.5328	35.8965

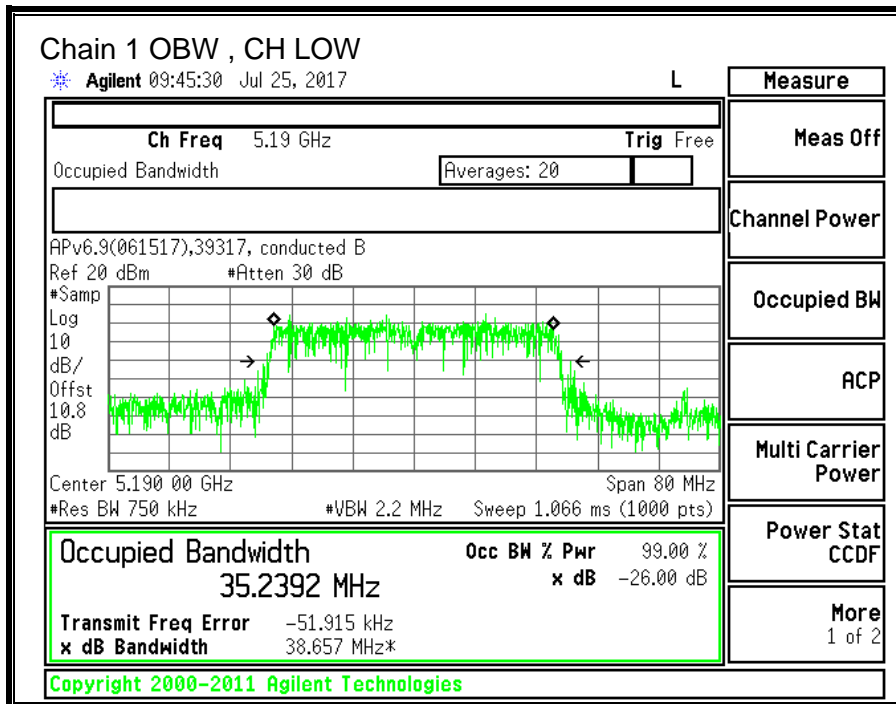
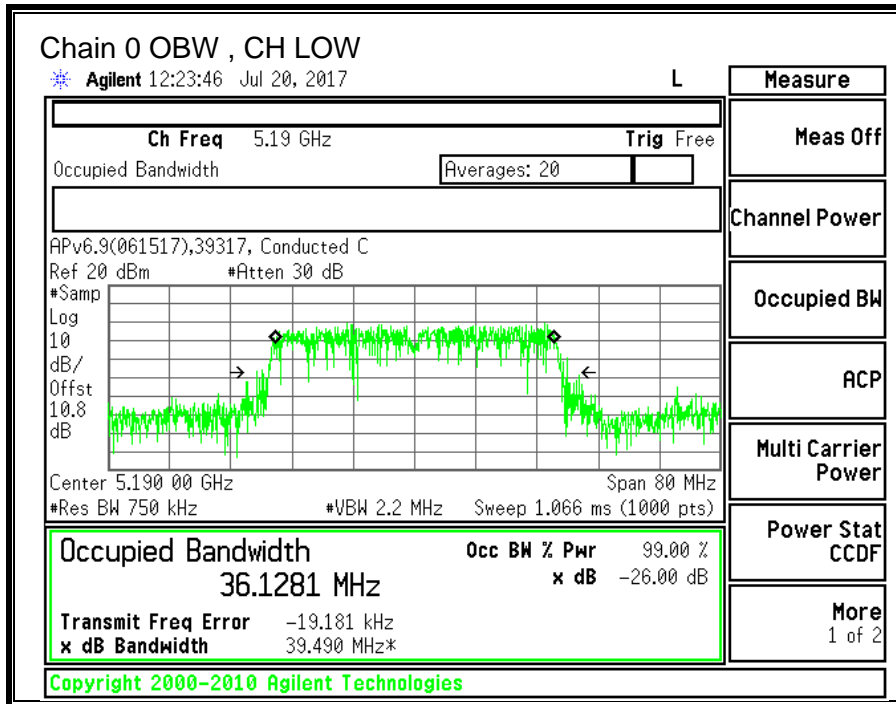

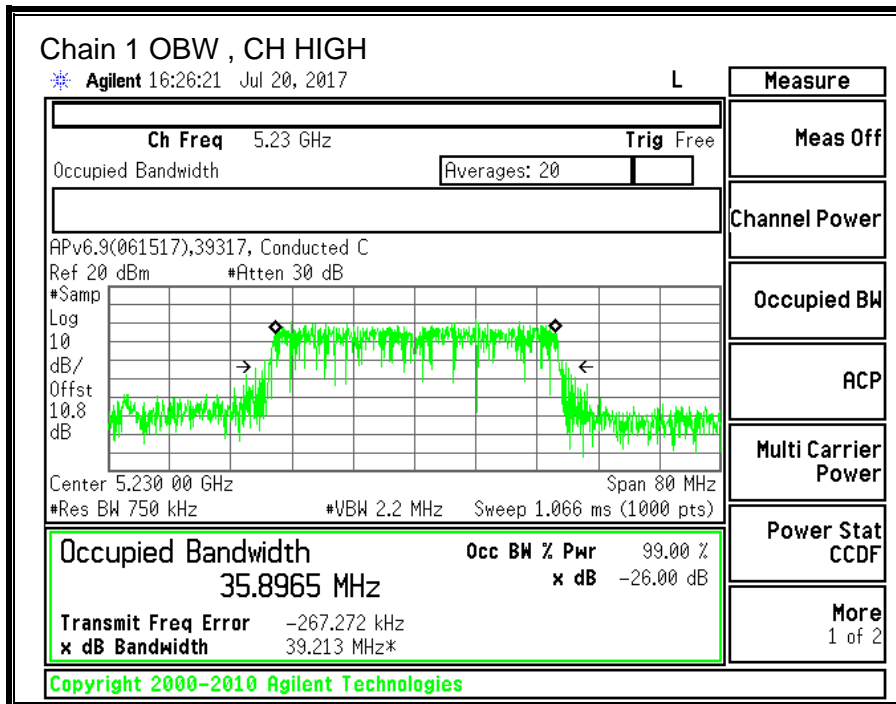
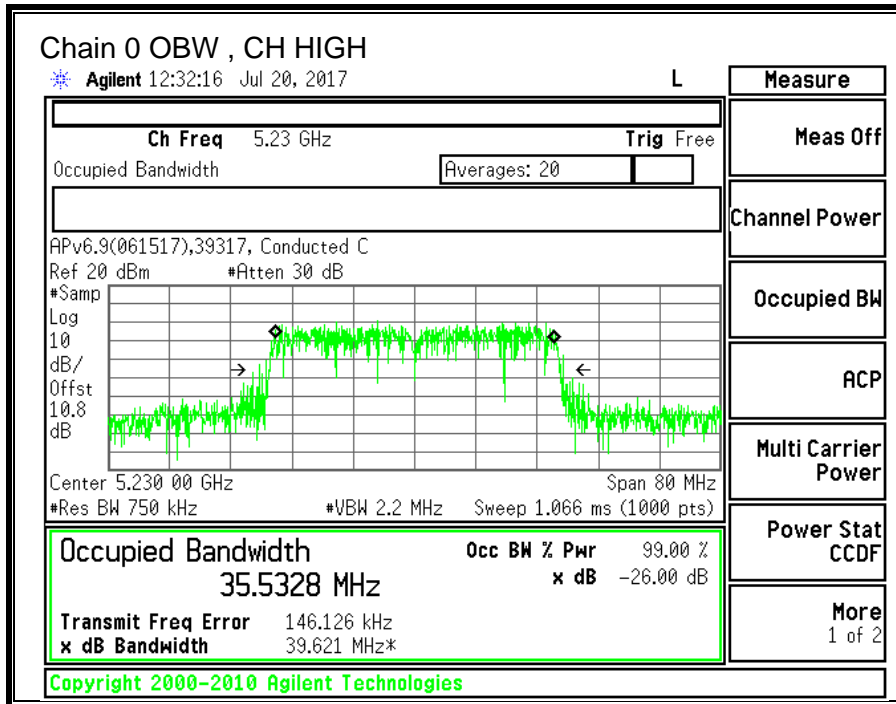

10.3.3. OUTPUT POWER AND PPSD

LIMITS

FCC §15.407 (a) (1)

(i) For an outdoor access point operating in the band 5.15-5.25 GHz, the maximum conducted output power over the frequency band of operation shall not exceed 1 W provided the maximum antenna gain does not exceed 6 dBi. In addition, the maximum power spectral density shall not exceed 17 dBm in any 1 megahertz band. If transmitting antennas of directional gain greater than 6 dBi are used, both the maximum conducted output power and the maximum power spectral density shall be reduced by the amount in dB that the directional gain of the antenna exceeds 6 dBi. The maximum e.i.r.p. at any elevation angle above 30 degrees as measured from the horizon must not exceed 125 mW (21 dBm).

(ii) For an indoor access point operating in the band 5.15-5.25 GHz, the maximum conducted output power over the frequency band of operation shall not exceed 1 W provided the maximum antenna gain does not exceed 6 dBi. In addition, the maximum power spectral density shall not exceed 17 dBm in any 1 megahertz band. If transmitting antennas of directional gain greater than 6 dBi are used, both the maximum conducted output power and the maximum power spectral density shall be reduced by the amount in dB that the directional gain of the antenna exceeds 6 dBi.

(iii) For fixed point-to-point access points operating in the band 5.15-5.25 GHz, the maximum conducted output power over the frequency band of operation shall not exceed 1 W. Fixed point-to-point U-NII devices may employ antennas with directional gain up to 23 dBi without any corresponding reduction in the maximum conducted output power or maximum power spectral density. For fixed point-to-point transmitters that employ a directional antenna gain greater than 23 dBi, a 1 dB reduction in maximum conducted output power and maximum power spectral density is required for each 1 dB of antenna gain in excess of 23 dBi. Fixed, point-to-point operations exclude the use of point-to-multipoint systems, omnidirectional applications, and multiple collocated transmitters transmitting the same information. The operator of the U-NII device, or if the equipment is professionally installed, the installer, is responsible for ensuring that systems employing high gain directional antennas are used exclusively for fixed, point-to-point operations.

(iv) For mobile and portable client devices in the 5.15-5.25 GHz band, the maximum conducted output power over the frequency band of operation shall not exceed 250 mW provided the maximum antenna gain does not exceed 6 dBi. In addition, the maximum power spectral density shall not exceed 11 dBm in any 1 megahertz band. If transmitting antennas of directional gain greater than 6 dBi are used, both the maximum conducted output power and the maximum power spectral density shall be reduced by the amount in dB that the directional gain of the antenna exceeds 6 dBi.

TEST PROCEDURE

Measurements perform using a wideband gated RF power meter provided that the gate parameters are adjusted such that the power is measured only when the EUT is transmitting at its maximum power control level. Since the measurement is made only during the ON time of the transmitter, no duty cycle correction factor is required.

DIRECTIONAL ANTENNA GAIN

For power, the TX chains are uncorrelated and the antenna gain is unequal among the chains. The directional gain is:

5150-5250 MHz

Chain 0 Antenna Gain (dBi)	Chain 1 Antenna Gain (dBi)	Uncorrelated Chains Directional Gain (dBi)
0.10	1.60	0.91

For PSD the TX chains are correlated and the antenna gain is unequal among the chains. The directional gain is:

5150-5250 MHz

Chain 0 Antenna Gain (dBi)	Chain 1 Antenna Gain (dBi)	Correlated Chains Directional Gain (dBi)
0.10	1.60	3.89

RESULTS

ID:	39317	Date:	07/21/17
------------	-------	--------------	----------

Bandwidth and Antenna Gain

Channel	Frequency (MHz)	Min 26 dB BW (MHz)	Min 99% BW (MHz)	Directional Gain for Power (dBi)	Directional Gain for PPSD (dBi)
Low	5190	42.40	35.24	0.91	3.89
High	5230	42.80	35.53	0.91	3.89

Limits

Channel	Frequency (MHz)	FCC Power Limit (dBm)	IC EIRP Limit (dBm)	Max IC Power (dBm)	Power Limit (dBm)	FCC PPSD Limit (dBm)	IC eirp PSD Limit (dBm)	PPSD Limit (dBm)
Low	5190	24.00	23.00	22.09	22.09	11.00	10.00	6.11
High	5230	24.00	23.00	22.09	22.09	11.00	10.00	6.11

Duty Cycle CF (dB)	0.39	Included in Calculations of Corr'd PPSD
---------------------------	------	--

Output Power Results

Channel	Frequency (MHz)	Chain 0 Meas Power (dBm)	Chain 1 Meas Power (dBm)	Total Corr'd Power (dBm)	Power Limit (dBm)	Power Margin (dB)
Low	5190	13.25	13.41	16.34	22.09	-5.75
High	5230	13.32	13.39	16.37	22.09	-5.72

PPSD Results

Channel	Frequency (MHz)	Chain 0 Meas PPSD (dBm)	Chain 1 Meas PPSD (dBm)	Total Corr'd PPSD (dBm)	PPSD Limit (dBm)	PPSD Margin (dB)
Low	5190	-1.240	-0.701	2.44	6.11	-3.67
High	5230	-1.181	-0.886	2.37	6.11	-3.74

Note: the power readings above were measured with gated method, and the measurement was taken only during the ON time. No duty cycle correction was necessary.

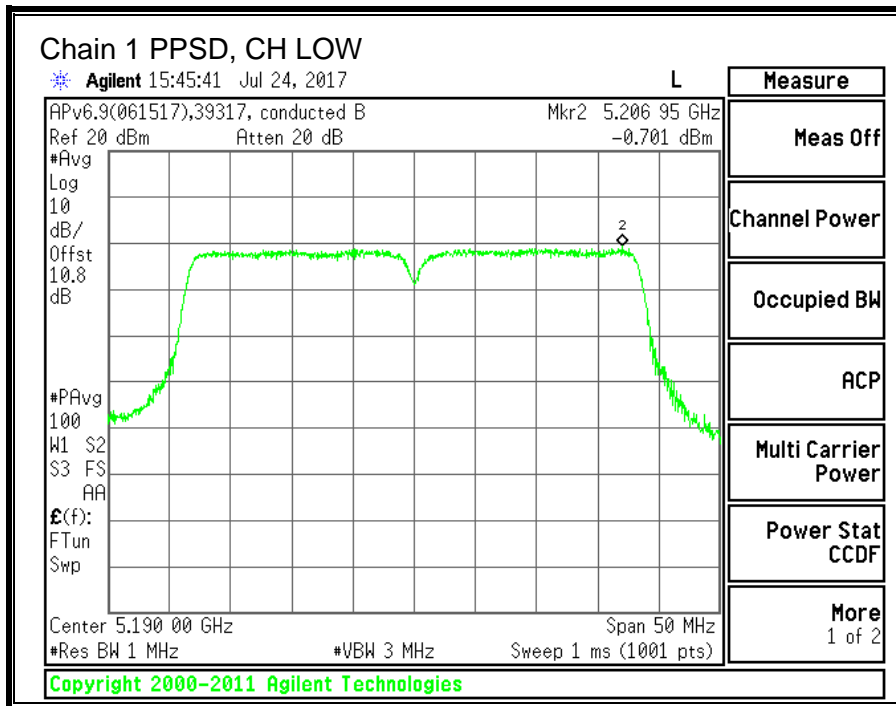
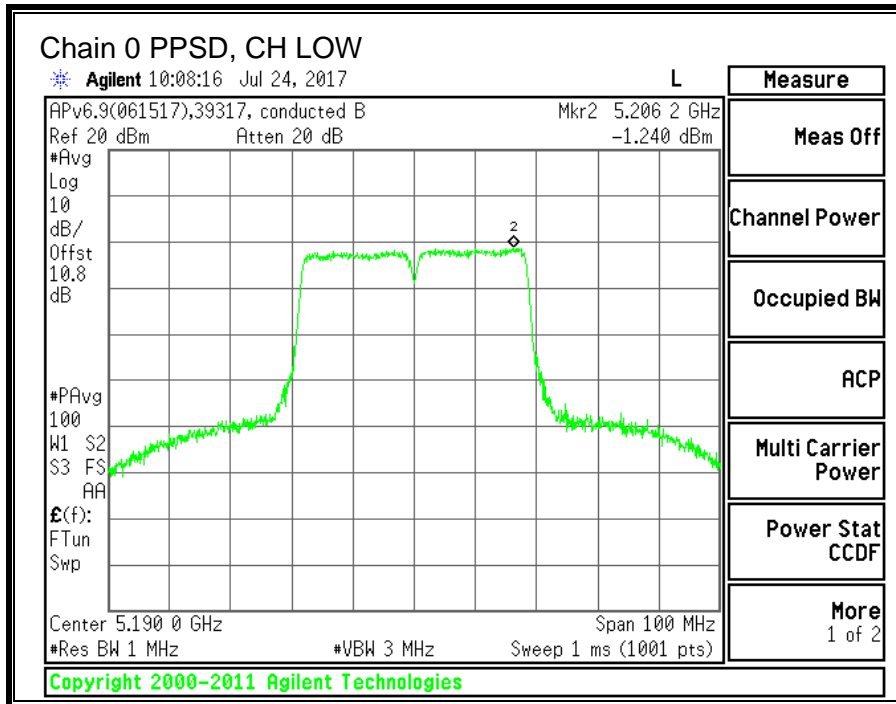

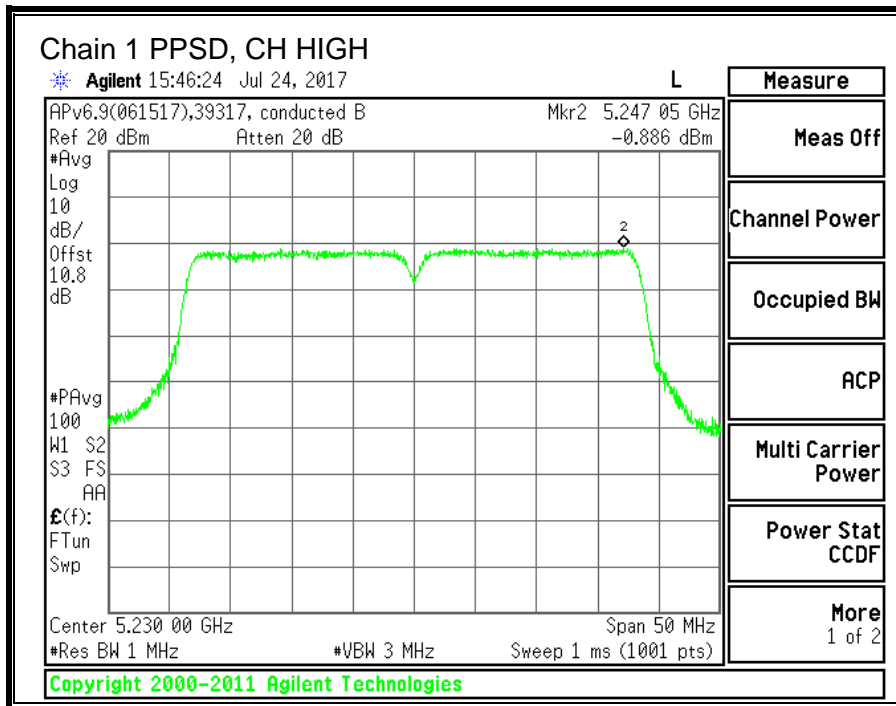
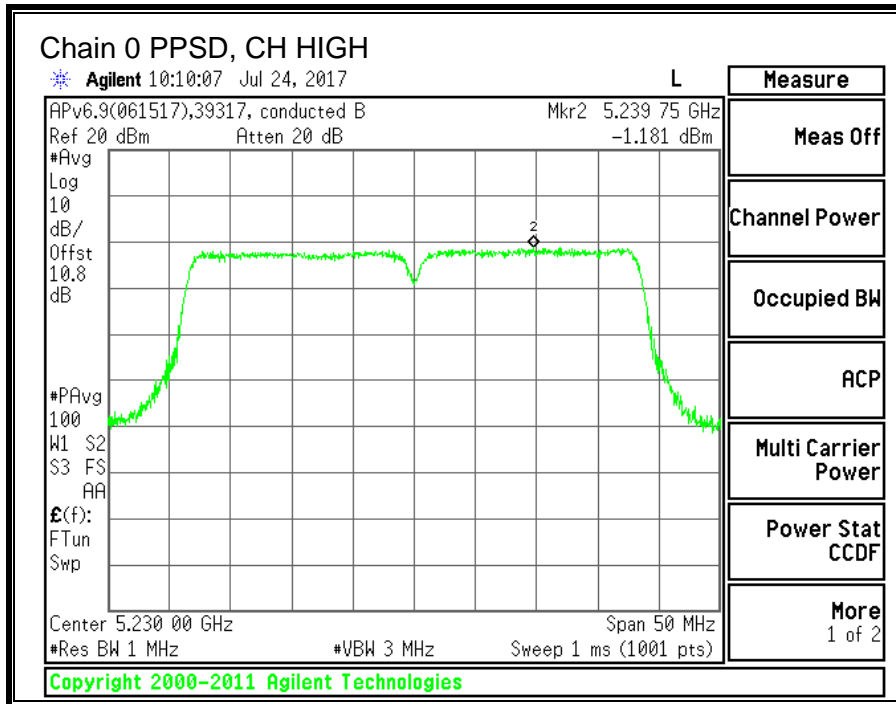

10.4. 11ac VHT80 2TX CDD MIMO MODE IN THE 5.2GHz BAND

10.4.1. 26 dB BANDWIDTH

LIMITS

None; for reporting purposes only.

RESULTS

Channel	Frequency	26 dB BW Chain 0 (MHz)	26 dB BW Chain 1 (MHz)
Mid	5210	85.80	85.00

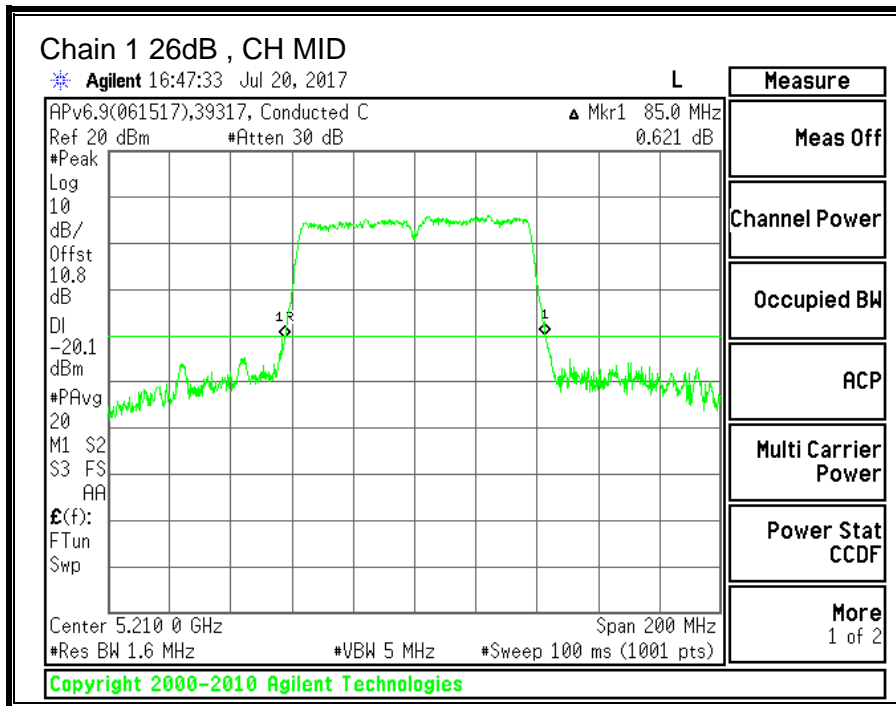
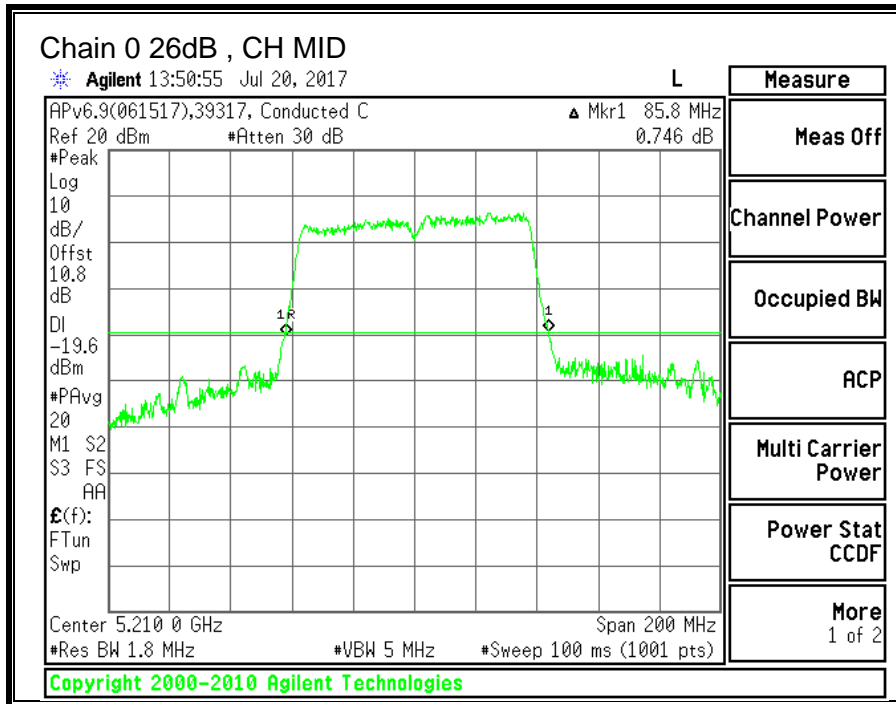

10.4.2. 99% BANDWIDTH

LIMITS

None; for reporting purposes only.

RESULTS

Channel	Frequency	99% BW Chain 0 (MHz)	99% BW Chain 1 (MHz)
Mid	5210	74.1994	72.0578

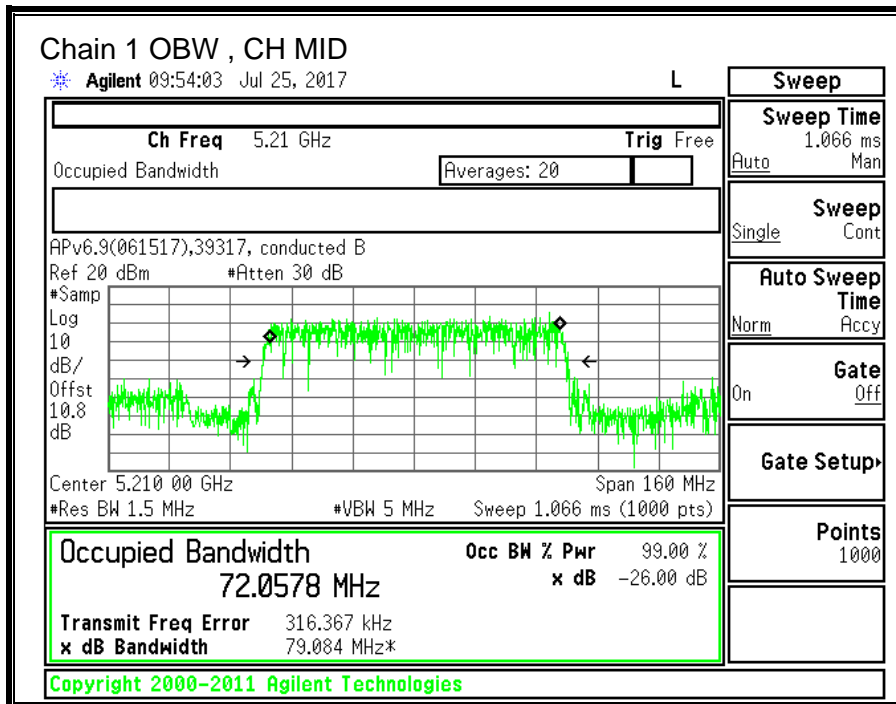
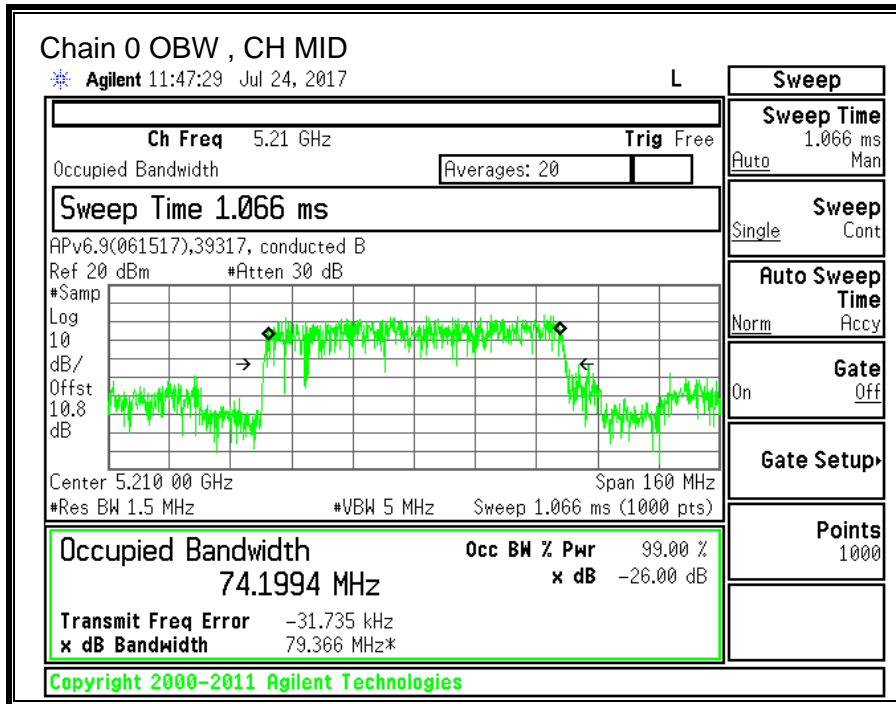

10.4.3. OUTPUT POWER AND PPSD

LIMITS

FCC §15.407 (a) (1)

(i) For an outdoor access point operating in the band 5.15-5.25 GHz, the maximum conducted output power over the frequency band of operation shall not exceed 1 W provided the maximum antenna gain does not exceed 6 dBi. In addition, the maximum power spectral density shall not exceed 17 dBm in any 1 megahertz band. If transmitting antennas of directional gain greater than 6 dBi are used, both the maximum conducted output power and the maximum power spectral density shall be reduced by the amount in dB that the directional gain of the antenna exceeds 6 dBi. The maximum e.i.r.p. at any elevation angle above 30 degrees as measured from the horizon must not exceed 125 mW (21 dBm).

(ii) For an indoor access point operating in the band 5.15-5.25 GHz, the maximum conducted output power over the frequency band of operation shall not exceed 1 W provided the maximum antenna gain does not exceed 6 dBi. In addition, the maximum power spectral density shall not exceed 17 dBm in any 1 megahertz band. If transmitting antennas of directional gain greater than 6 dBi are used, both the maximum conducted output power and the maximum power spectral density shall be reduced by the amount in dB that the directional gain of the antenna exceeds 6 dBi.

(iii) For fixed point-to-point access points operating in the band 5.15-5.25 GHz, the maximum conducted output power over the frequency band of operation shall not exceed 1 W. Fixed point-to-point U-NII devices may employ antennas with directional gain up to 23 dBi without any corresponding reduction in the maximum conducted output power or maximum power spectral density. For fixed point-to-point transmitters that employ a directional antenna gain greater than 23 dBi, a 1 dB reduction in maximum conducted output power and maximum power spectral density is required for each 1 dB of antenna gain in excess of 23 dBi. Fixed, point-to-point operations exclude the use of point-to-multipoint systems, omnidirectional applications, and multiple collocated transmitters transmitting the same information. The operator of the U-NII device, or if the equipment is professionally installed, the installer, is responsible for ensuring that systems employing high gain directional antennas are used exclusively for fixed, point-to-point operations.

(iv) For mobile and portable client devices in the 5.15-5.25 GHz band, the maximum conducted output power over the frequency band of operation shall not exceed 250 mW provided the maximum antenna gain does not exceed 6 dBi. In addition, the maximum power spectral density shall not exceed 11 dBm in any 1 megahertz band. If transmitting antennas of directional gain greater than 6 dBi are used, both the maximum conducted output power and the maximum power spectral density shall be reduced by the amount in dB that the directional gain of the antenna exceeds 6 dBi.

TEST PROCEDURE

Measurements perform using a wideband gated RF power meter provided that the gate parameters are adjusted such that the power is measured only when the EUT is transmitting at its maximum power control level. Since the measurement is made only during the ON time of the transmitter, no duty cycle correction factor is required.

DIRECTIONAL ANTENNA GAIN

For power, the TX chains are uncorrelated and the antenna gain is unequal among the chains. The directional gain is:

5150-5250 MHz

Chain 0 Antenna Gain (dBi)	Chain 1 Antenna Gain (dBi)	Uncorrelated Chains Directional Gain (dBi)
0.10	1.60	0.91

For PSD the TX chains are correlated and the antenna gain is unequal among the chains. The directional gain is:

5150-5250 MHz

Chain 0 Antenna Gain (dBi)	Chain 1 Antenna Gain (dBi)	Correlated Chains Directional Gain (dBi)
0.10	1.60	3.89

RESULTS

ID:	39317	Date:	07/21/17
------------	-------	--------------	----------

Bandwidth and Antenna Gain

Channel	Frequency (MHz)	Min 26 dB BW (MHz)	Min 99% BW (MHz)	Directional Gain for Power (dBi)	Directional Gain for PPSD (dBi)
Low	5210	85.00	72.06	0.91	3.89

Limits

Channel	Frequency (MHz)	FCC Power Limit (dBm)	IC EIRP Limit (dBm)	Max IC Power (dBm)	Power Limit (dBm)	FCC PPSD Limit (dBm)	IC eirp PSD Limit (dBm)	PPSD Limit (dBm)
Low	5210	24.00	23.00	22.09	22.09	11.00	10.00	6.11

Duty Cycle CF (dB)	0.71	Included in Calculations of Corr'd PPSD
---------------------------	------	--

Output Power Results

Channel	Frequency (MHz)	Chain 0 Meas Power (dBm)	Chain 1 Meas Power (dBm)	Total Corr'd Power (dBm)	Power Limit (dBm)	Power Margin (dB)
Low	5210	12.74	13.40	16.09	22.09	-6.00

PPSD Results

Channel	Frequency (MHz)	Chain 0 Meas PPSD (dBm)	Chain 1 Meas PPSD (dBm)	Total Corr'd PPSD (dBm)	PPSD Limit (dBm)	PPSD Margin (dB)
Low	5210	-4.268	-4.098	-0.46	6.11	-6.57

Note: the power readings above were measured with gated method, and the measurement was taken only during the ON time. No duty cycle correction was necessary.

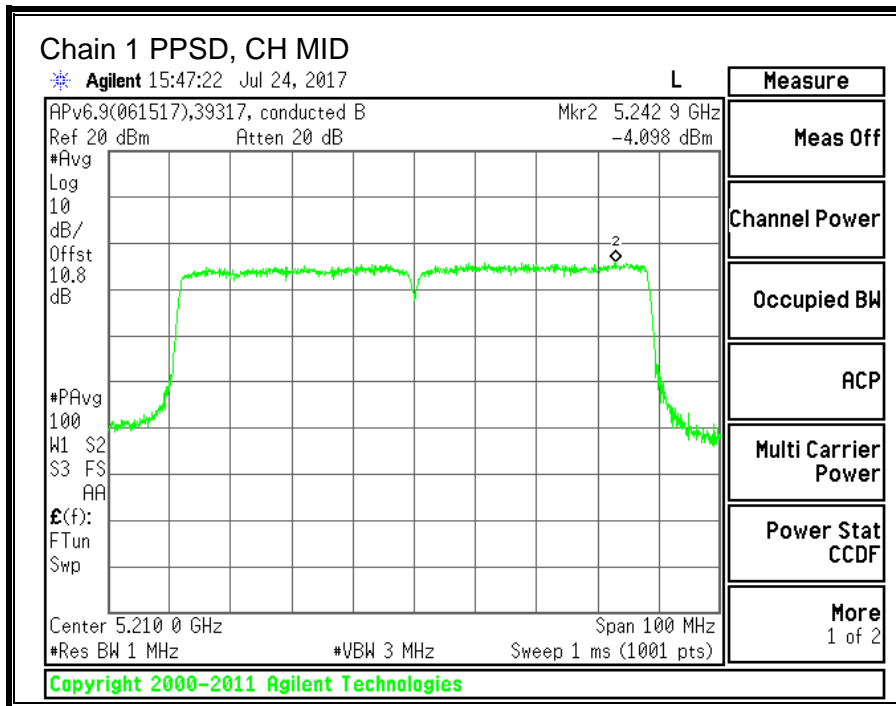
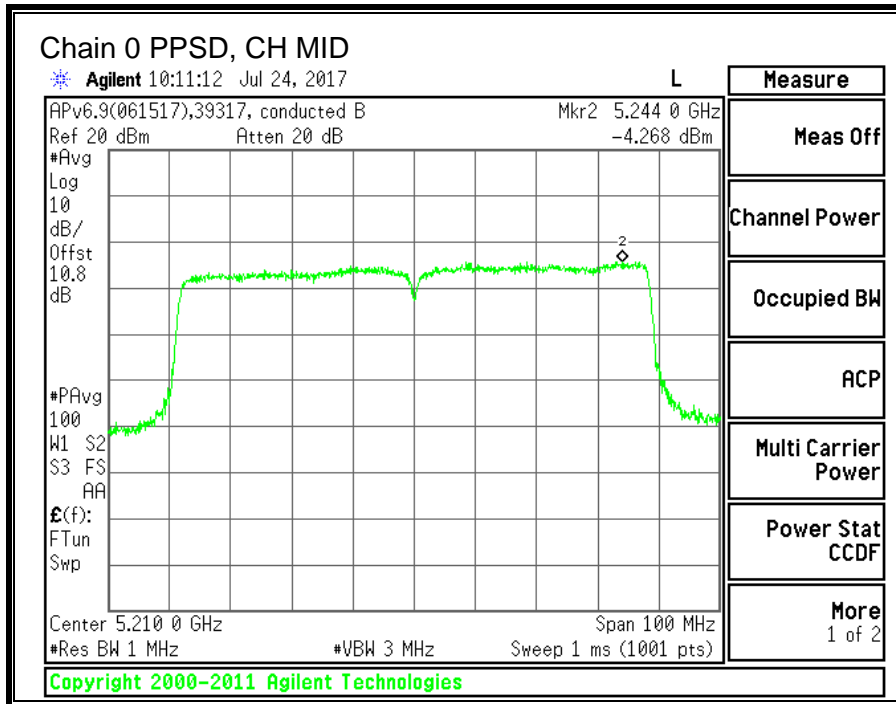

10.5. 11a 2TX CDD MIMO MODE IN THE 5.3GHz BAND

10.5.1. 26 dB BANDWIDTH

LIMITS

None; for reporting purposes only.

RESULTS

Channel	Frequency	26 dB BW Chain 0 (MHz)	26 dB BW Chain 1 (MHz)
Low	5260	23.65	22.10
Mid	5300	23.50	21.90
High	5320	23.70	22.25

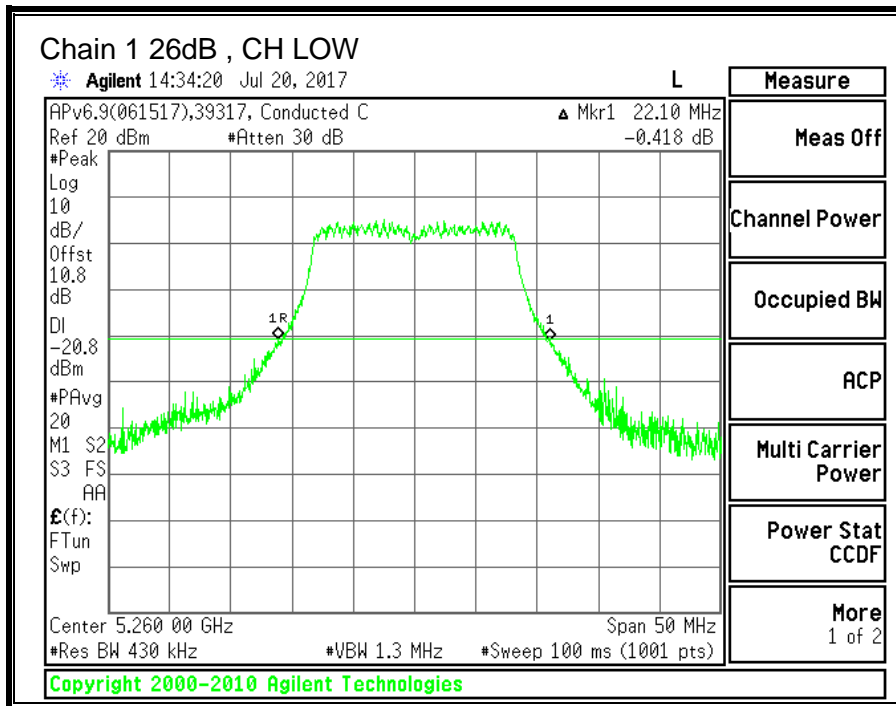
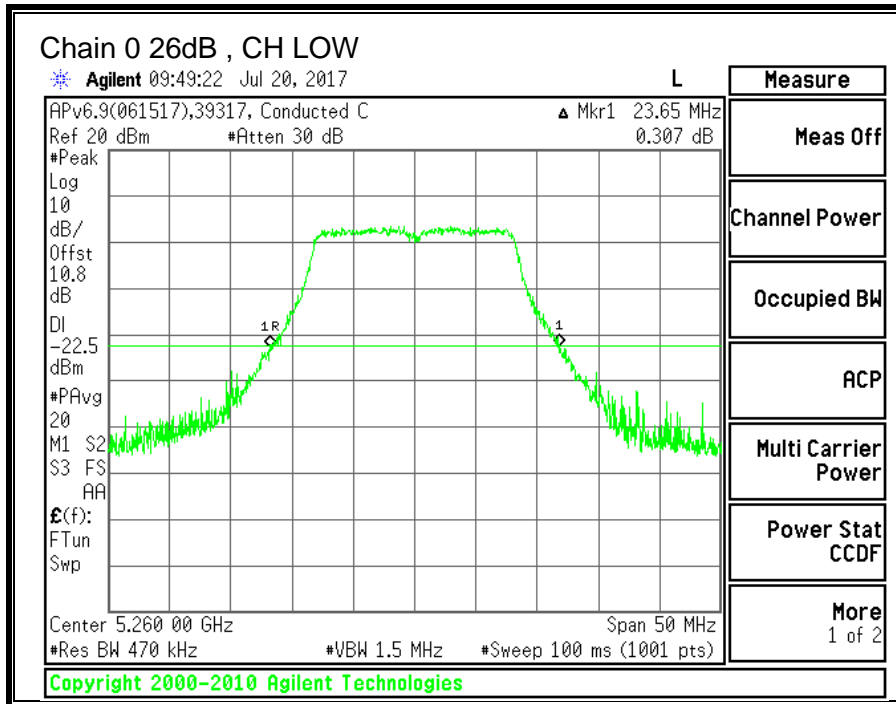

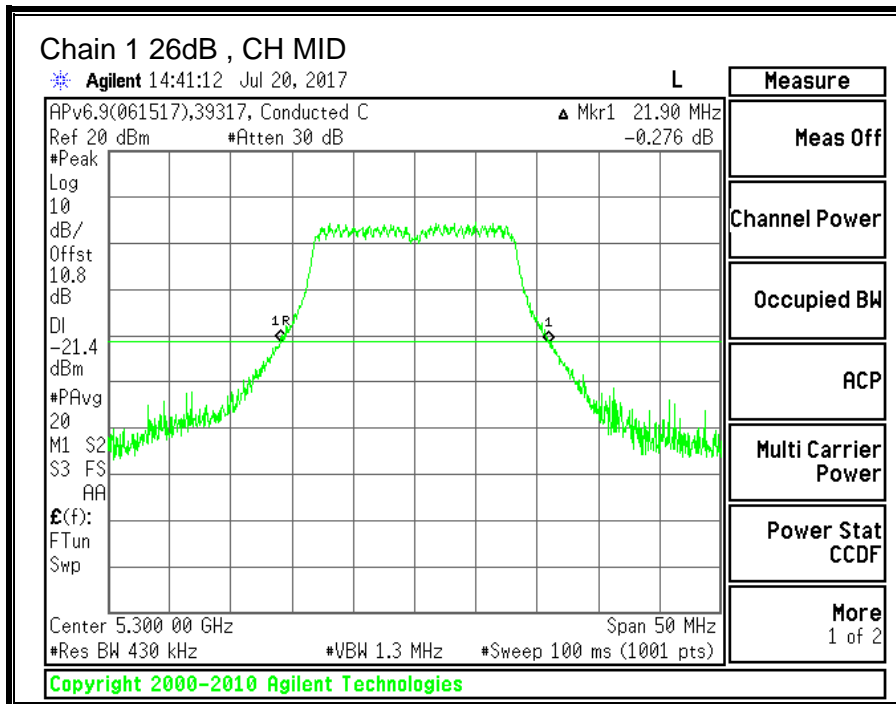
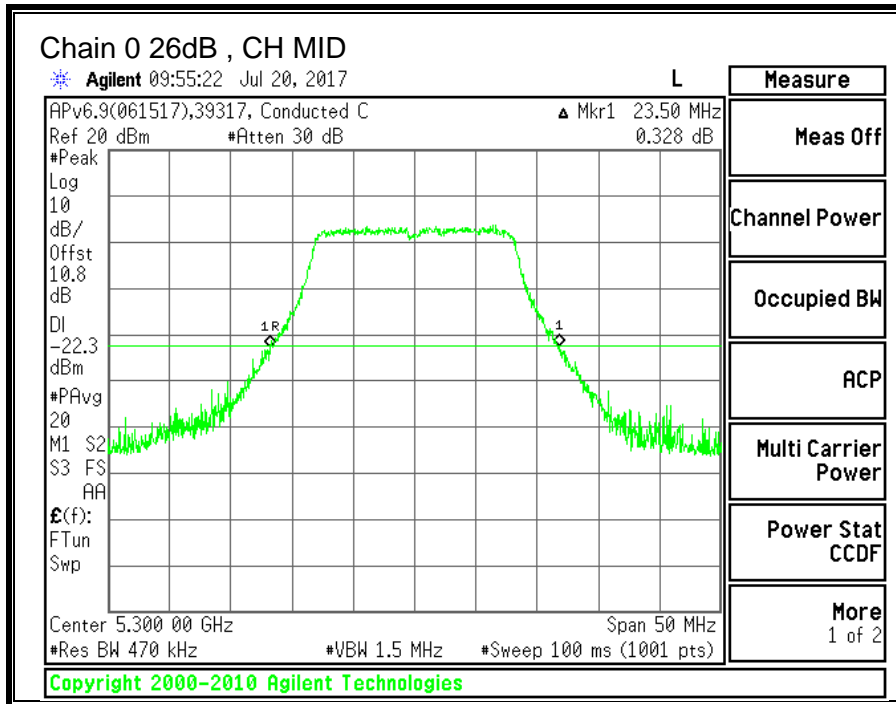

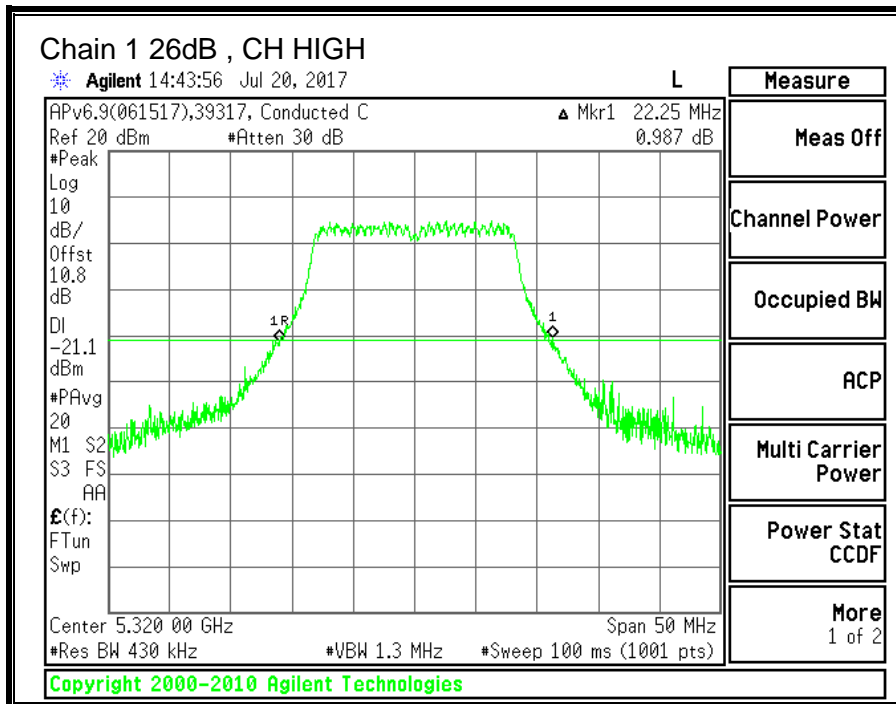
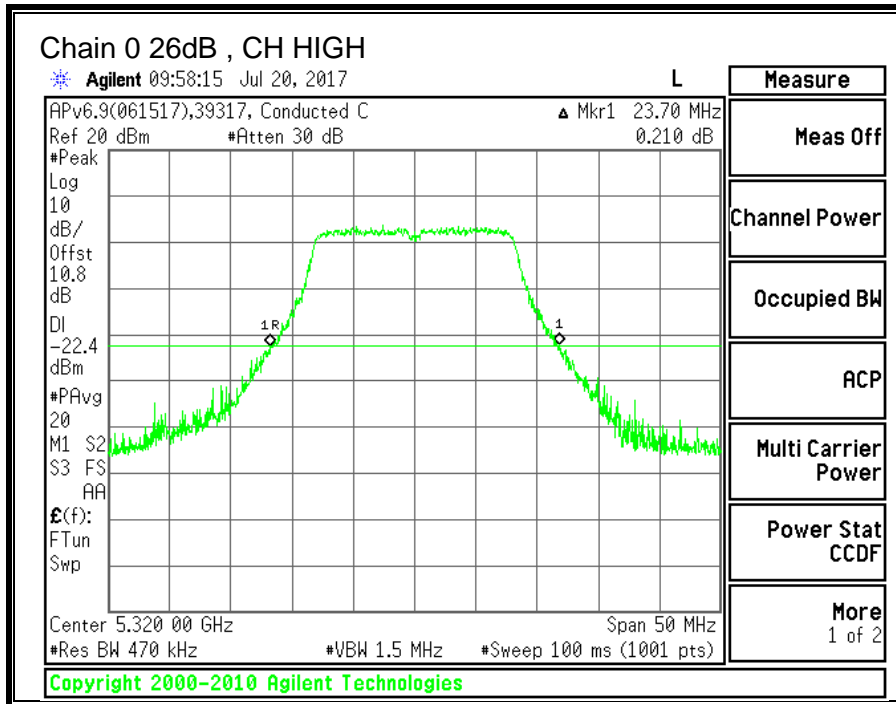

10.5.2. 99% BANDWIDTH

LIMITS

None; for reporting purposes only.

RESULTS

Channel	Frequency	99% BW Chain 0 (MHz)	99% BW Chain 1 (MHz)
Low	5260	16.5635	16.5590
Mid	5300	16.2431	16.4174
High	5320	16.2783	16.3923

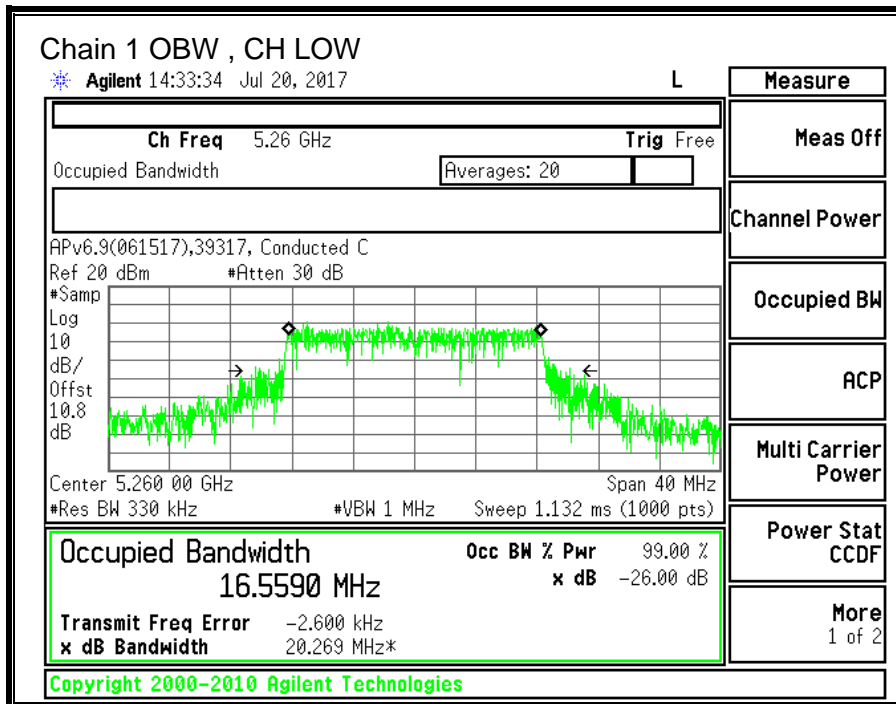
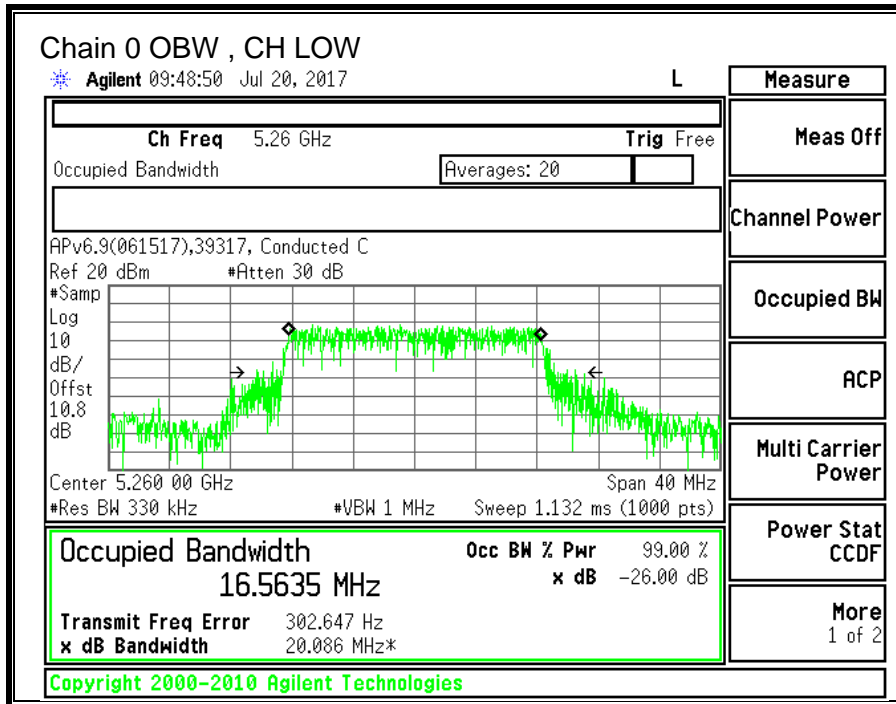

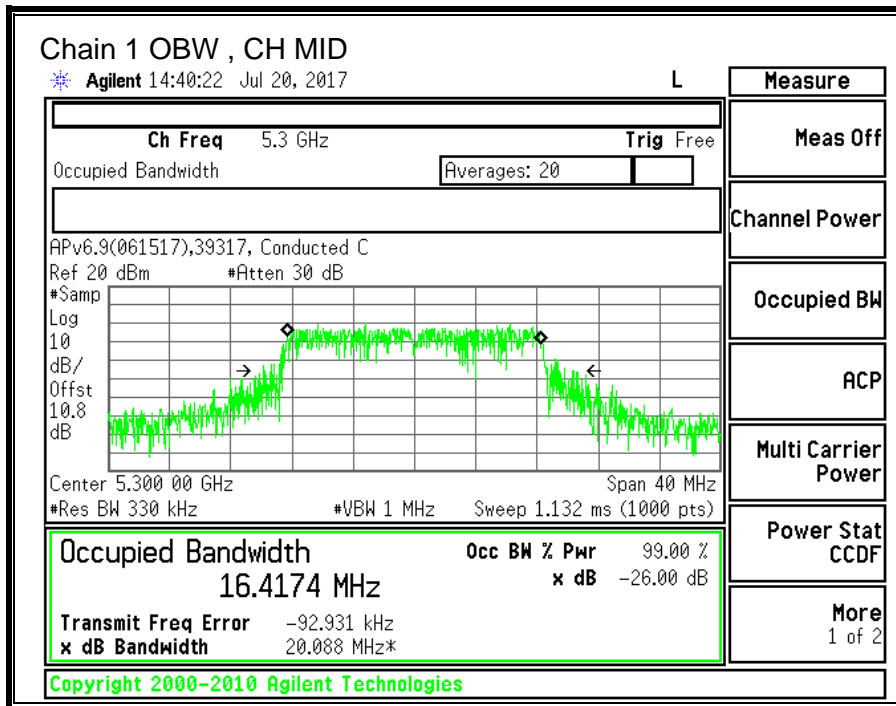
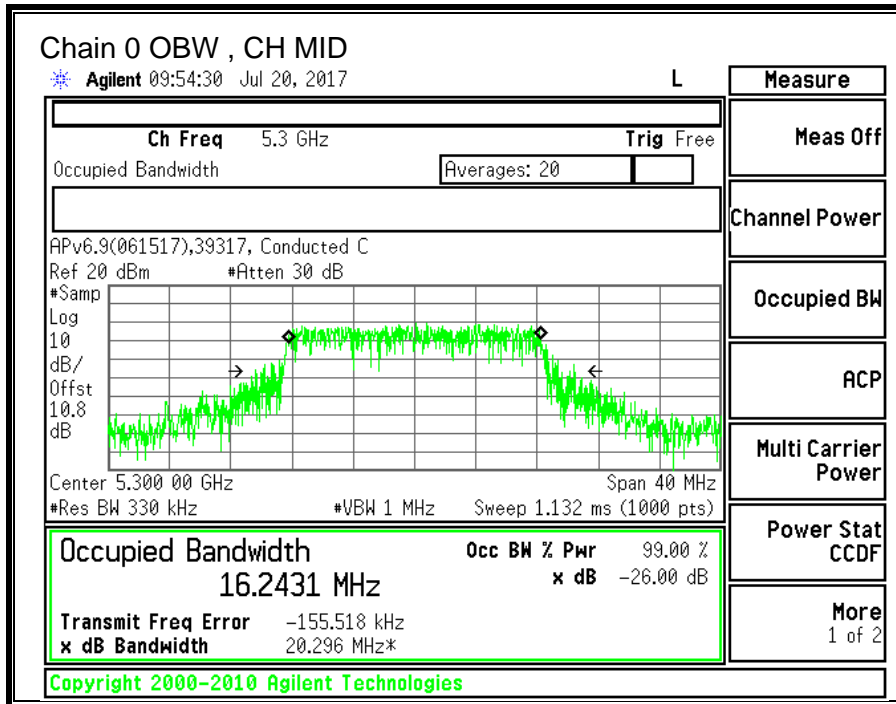

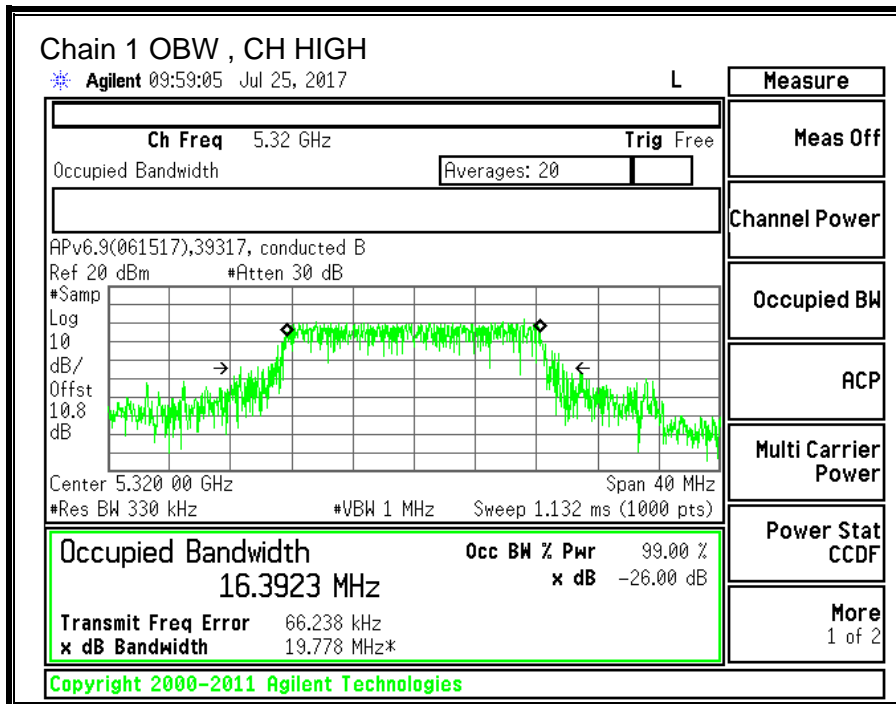
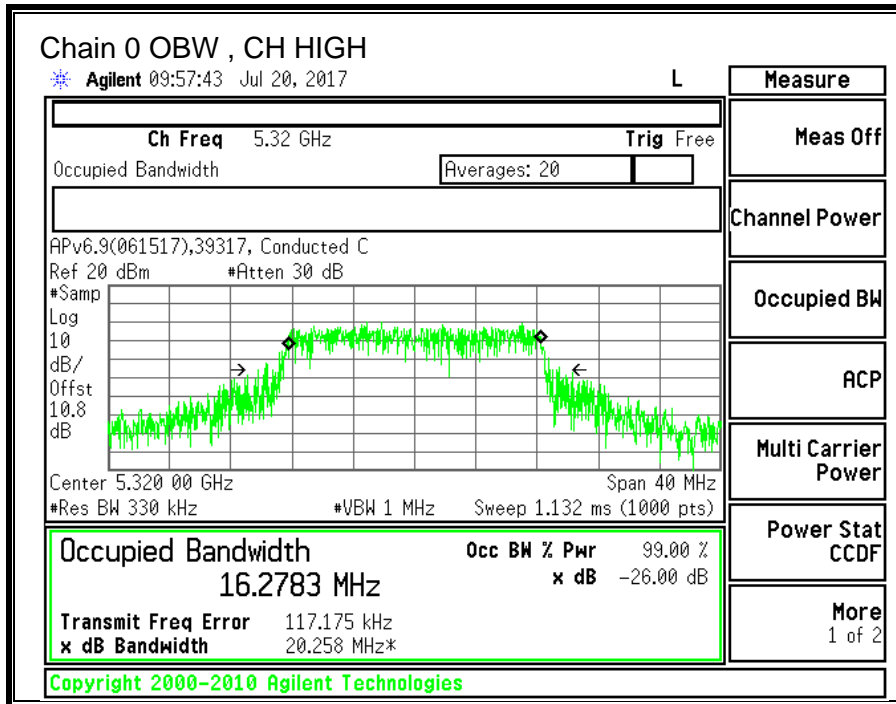

10.5.3. OUTPUT POWER AND PPSD

LIMITS

FCC §15.407 (a) (2)

For the band 5.25–5.35 GHz, the maximum conducted output power over the frequency band of operation shall not exceed the lesser of 250 mW or 11 dBm + 10 log B, where B is the 26–dB emission bandwidth in MHz. In addition, the maximum power spectral density shall not exceed 11 dBm in any 1–MHz band. If transmitting antennas of directional gain greater than 6 dBi are used, both the maximum conducted output power and the peak power spectral density shall be reduced by the amount in dB that the directional gain of the antenna exceeds 6 dBi.

TEST PROCEDURE

Measurements perform using a wideband gated RF power meter provided that the gate parameters are adjusted such that the power is measured only when the EUT is transmitting at its maximum power control level. Since the measurement is made only during the ON time of the transmitter, no duty cycle correction factor is required.

DIRECTIONAL ANTENNA GAIN

For power, the TX chains are uncorrelated and the antenna gain is unequal among the chains. The directional gain is:

5250-5350 MHz

Chain 0 Antenna Gain (dBi)	Chain 1 Antenna Gain (dBi)	Uncorrelated Chains Directional Gain (dBi)
0.10	1.60	0.91

For PSD the TX chains are correlated and the antenna gain is unequal among the chains. The directional gain is:

5250-5230 MHz

Chain 0 Antenna Gain (dBi)	Chain 1 Antenna Gain (dBi)	Correlated Chains Directional Gain (dBi)
0.10	1.60	3.89

RESULTS

ID:	39317	Date:	07/21/17
------------	-------	--------------	----------

Bandwidth and Antenna Gain

Channel	Frequency (MHz)	Min 26 dB BW (MHz)	Min 99% BW (MHz)	Directional Gain for Power (dBi)	Directional Gain for PPSD (dBi)
Low	5260	22.10	16.56	0.91	3.89
Mid	5300	21.90	16.24	0.91	3.89
High	5320	22.25	16.28	0.91	3.89

Limits

Channel	Frequency (MHz)	FCC Power Limit (dBm)	IC Power Limit (dBm)	IC EIRP Limit (dBm)	Power Limit (dBm)	FCC PPSD Limit (dBm)	IC PSD Limit (dBm)	PPSD Limit (dBm)
Low	5260	24.00	23.19	29.19	23.19	11.00	11.00	11.00
Mid	5300	24.00	23.11	29.11	23.11	11.00	11.00	11.00
High	5320	24.00	23.12	29.12	23.12	11.00	11.00	11.00

Duty Cycle CF (dB)	0.24	Included in Calculations of Corr'd PPSD
---------------------------	------	--

Output Power Results

Channel	Frequency (MHz)	Chain 0 Meas Power (dBm)	Chain 1 Meas Power (dBm)	Total Corr'd Power (dBm)	Power Limit (dBm)	Power Margin (dB)
Low	5260	13.02	13.71	16.39	23.19	-6.80
Mid	5300	13.01	13.39	16.21	23.11	-6.89
High	5320	13.04	13.42	16.24	23.12	-6.87

PPSD Results

Channel	Frequency (MHz)	Chain 0 Meas PPSD (dBm)	Chain 1 Meas PPSD (dBm)	Total Corr'd PPSD (dBm)	PPSD Limit (dBm)	PPSD Margin (dB)
Low	5260	1.582	2.696	5.42	11.00	-5.58
Mid	5300	1.742	2.194	5.22	11.00	-5.78
High	5320	1.768	2.550	5.43	11.00	-5.57

Note: the power readings above were measured with gated method, and the measurement was taken only during the ON time. No duty cycle correction was necessary.

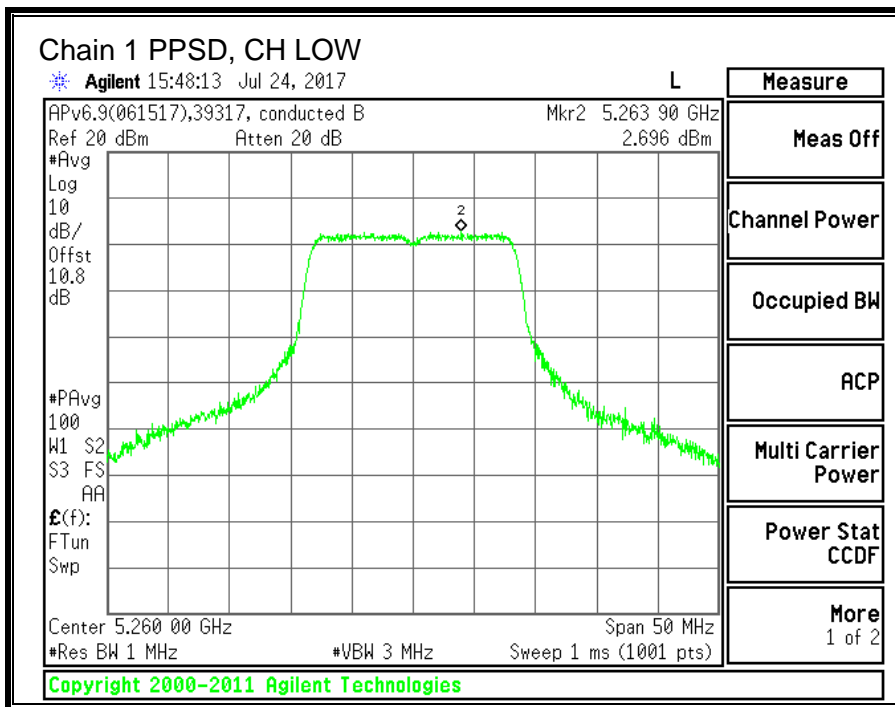
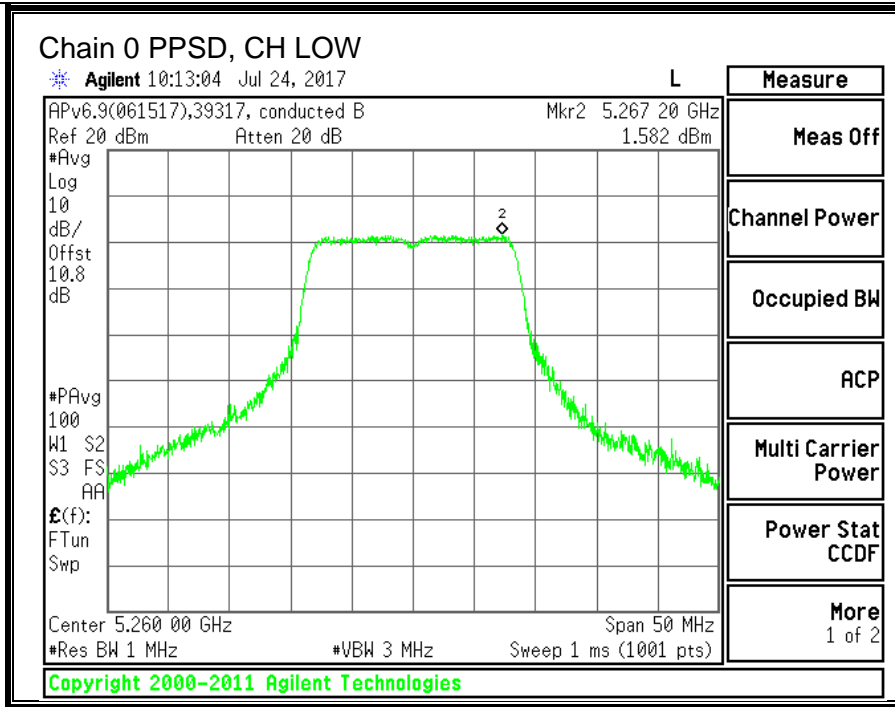

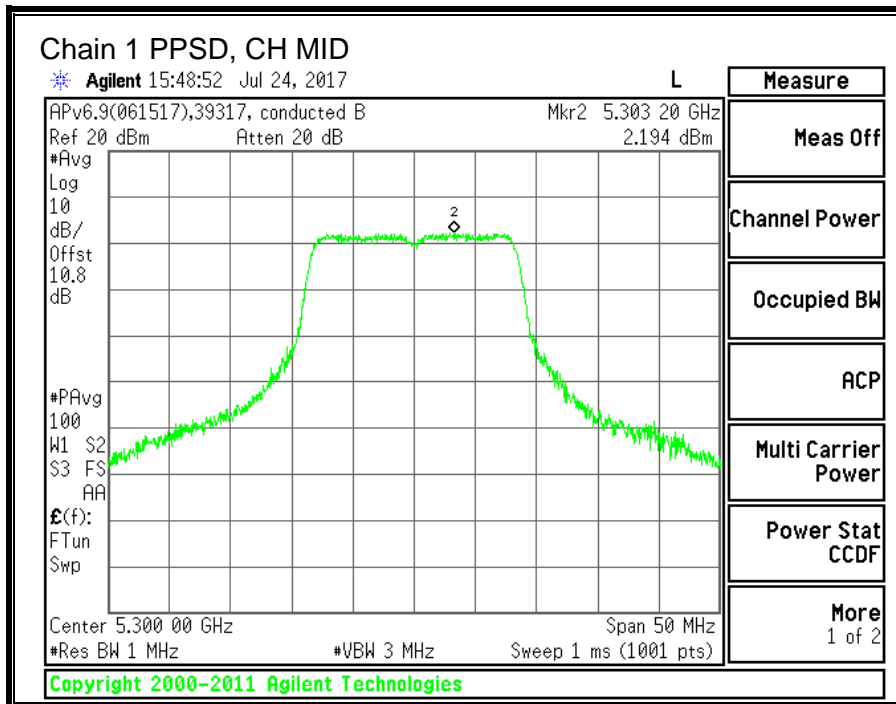
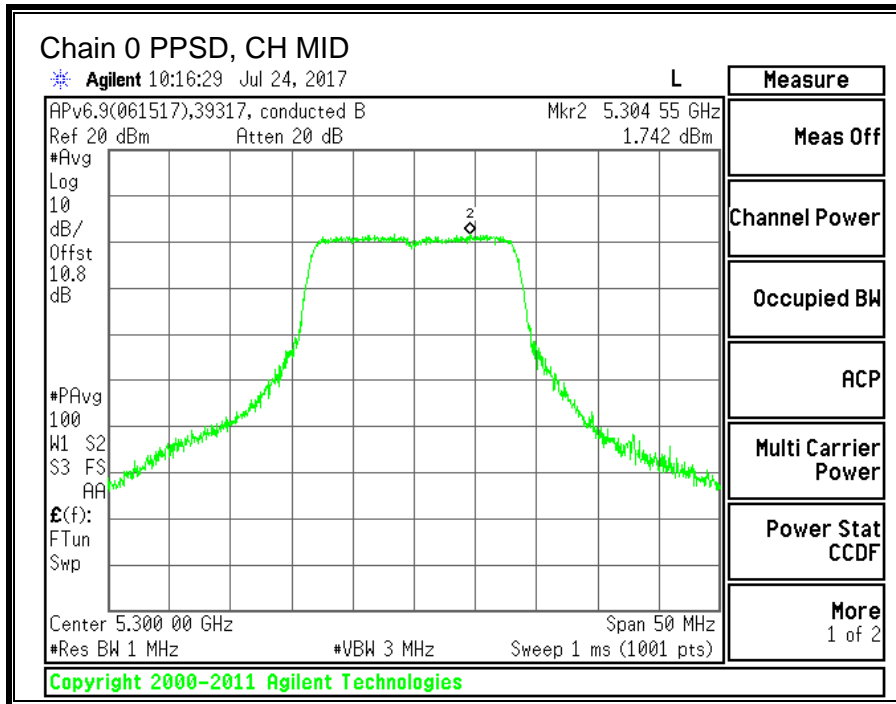

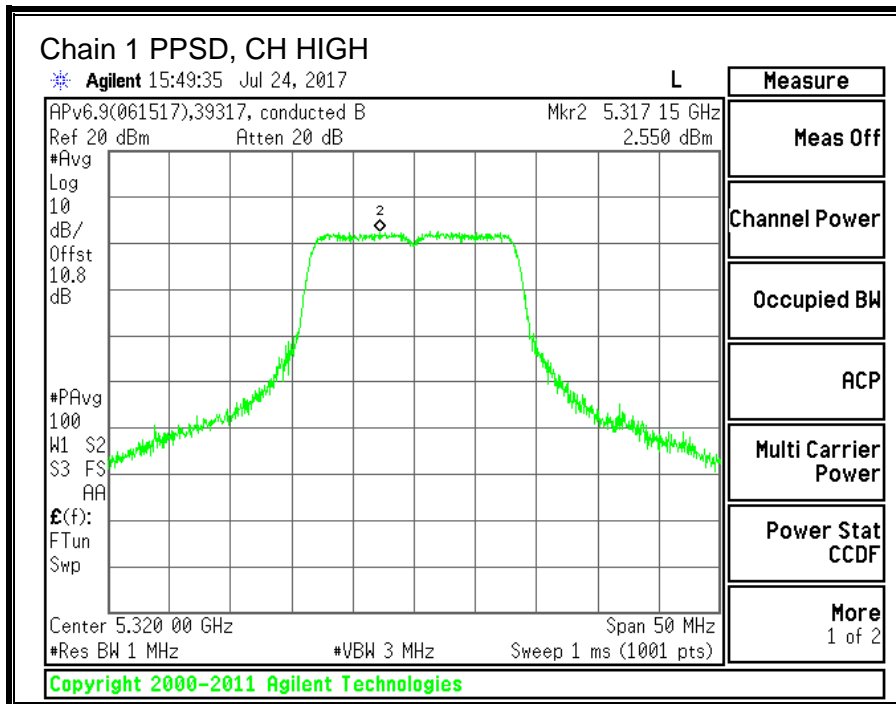
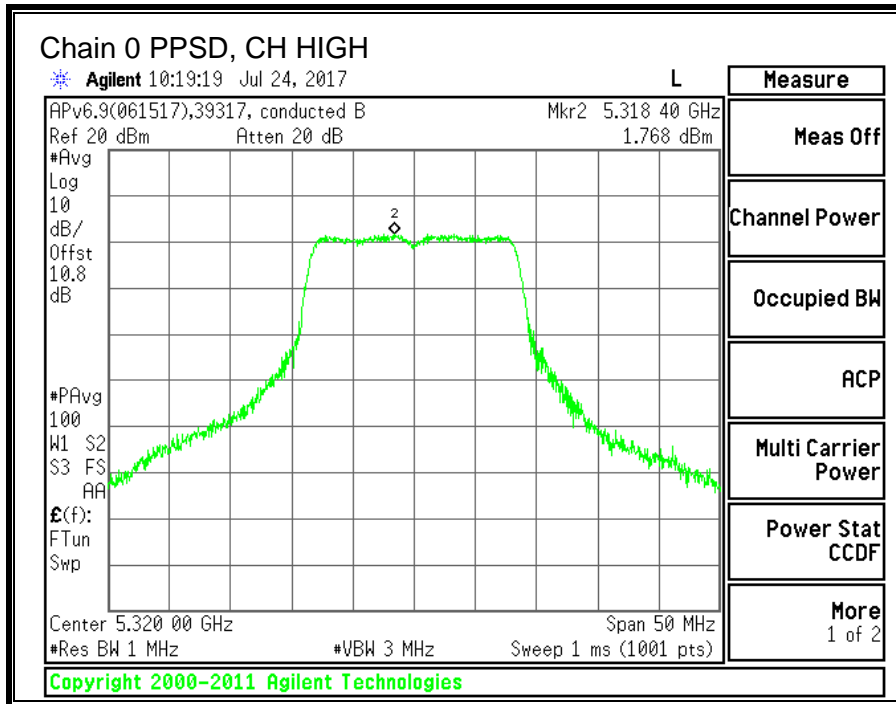

10.6. 11n HT20 2TX CDD MIMO MODE IN THE 5.3GHz BAND

10.6.1. 26 dB BANDWIDTH

LIMITS

None; for reporting purposes only.

RESULTS

Channel	Frequency	26 dB BW Chain 0 (MHz)	26 dB BW Chain 1 (MHz)
Low	5260	24.50	22.95
Mid	5300	25.10	23.10
High	5320	24.55	23.00

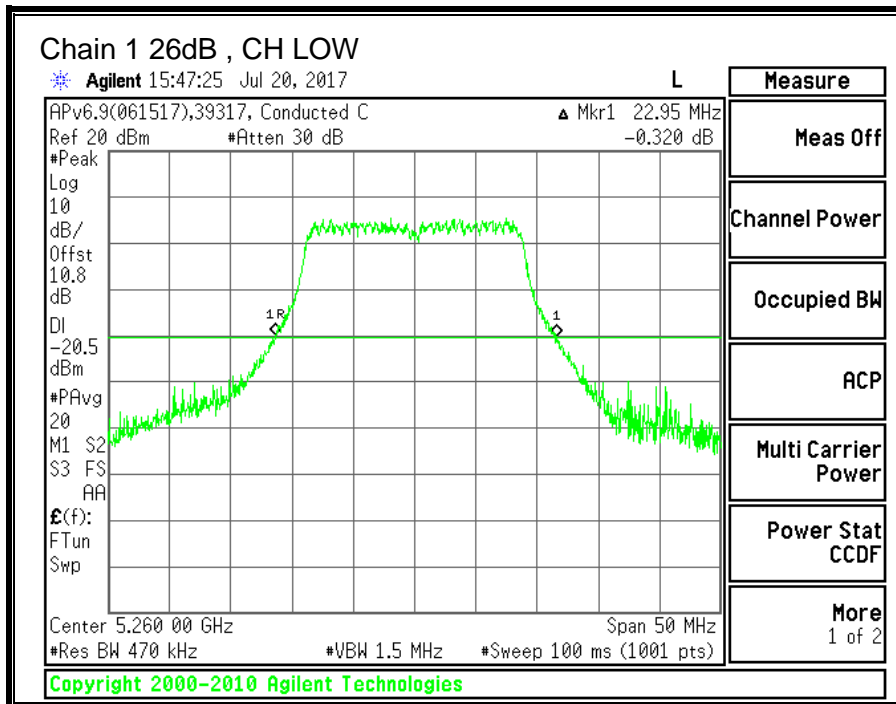
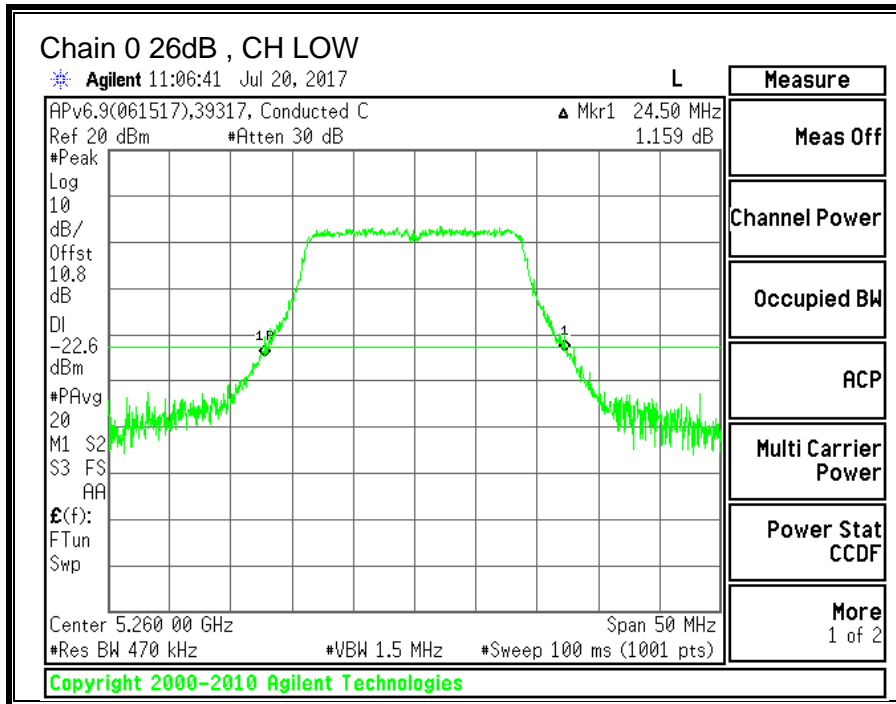

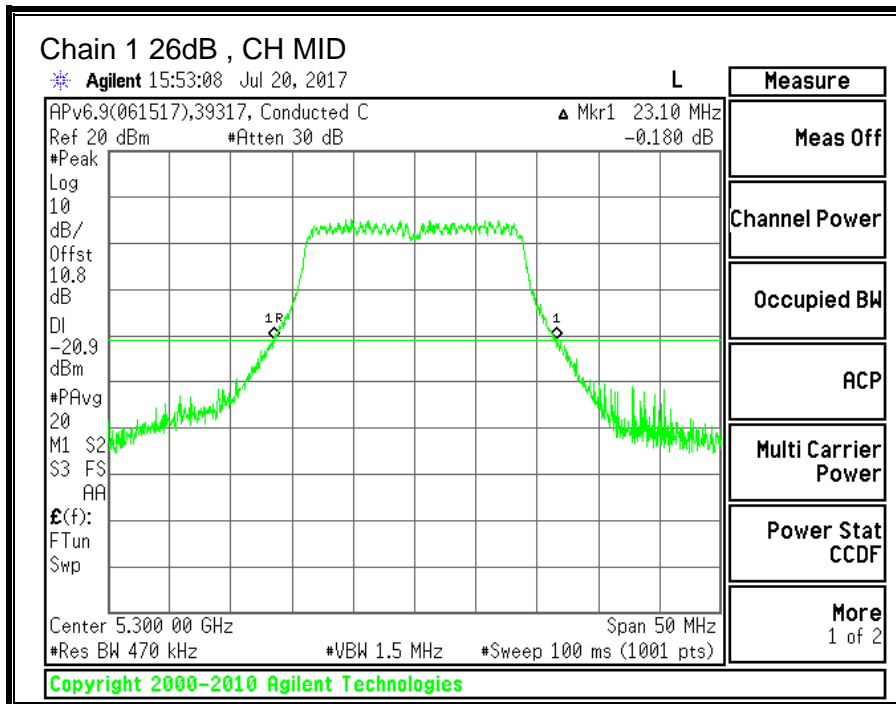
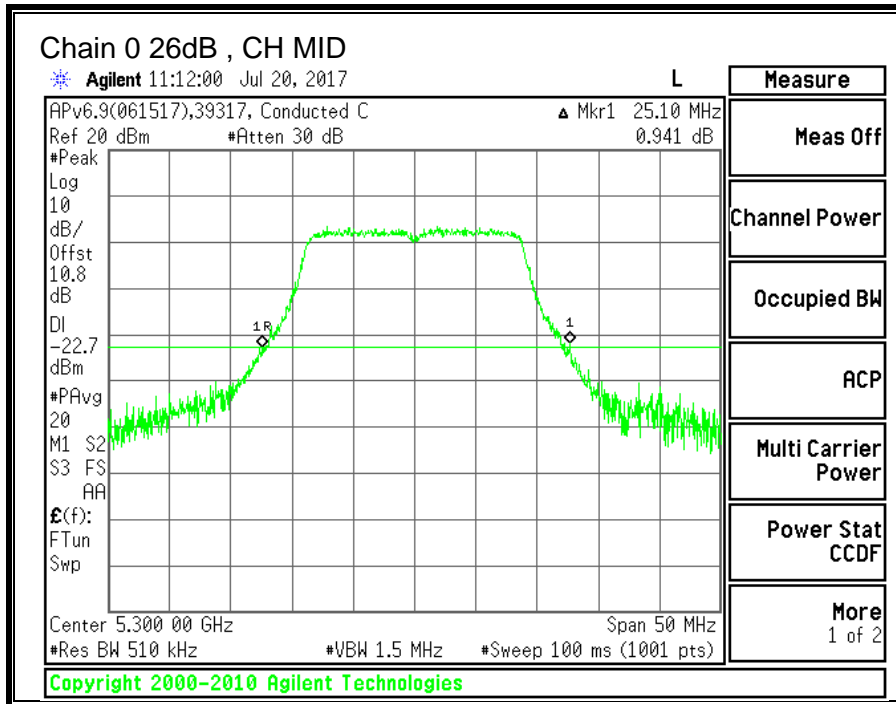

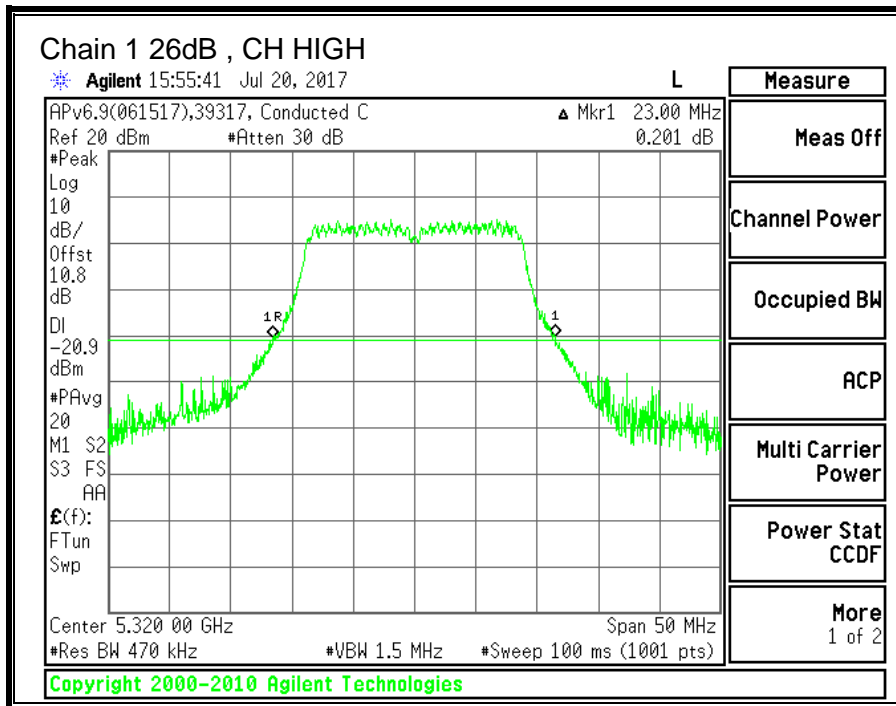
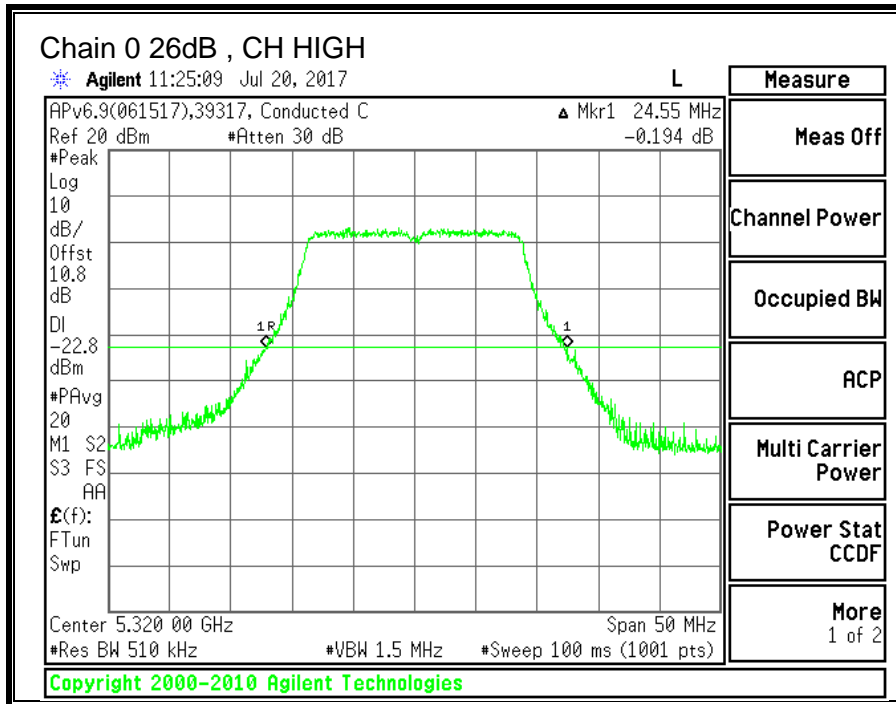

10.6.2. 99% BANDWIDTH

LIMITS

None; for reporting purposes only.

RESULTS

Channel	Frequency	99% BW Chain 0 (MHz)	99% BW Chain 1 (MHz)
Low	5260	17.6308	17.6738
Mid	5300	17.5348	17.3029
High	5320	17.6881	17.5852

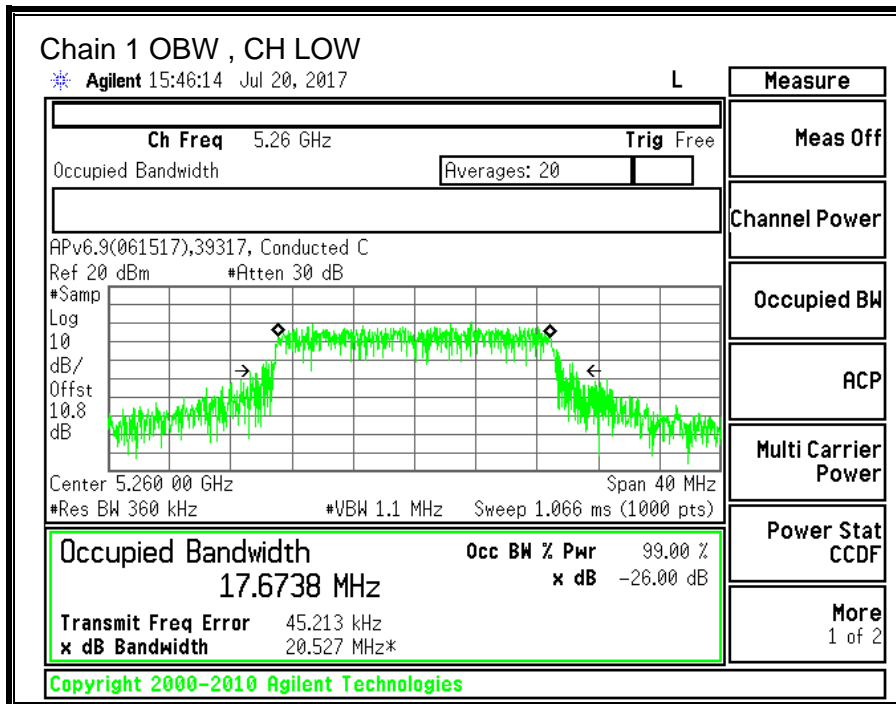
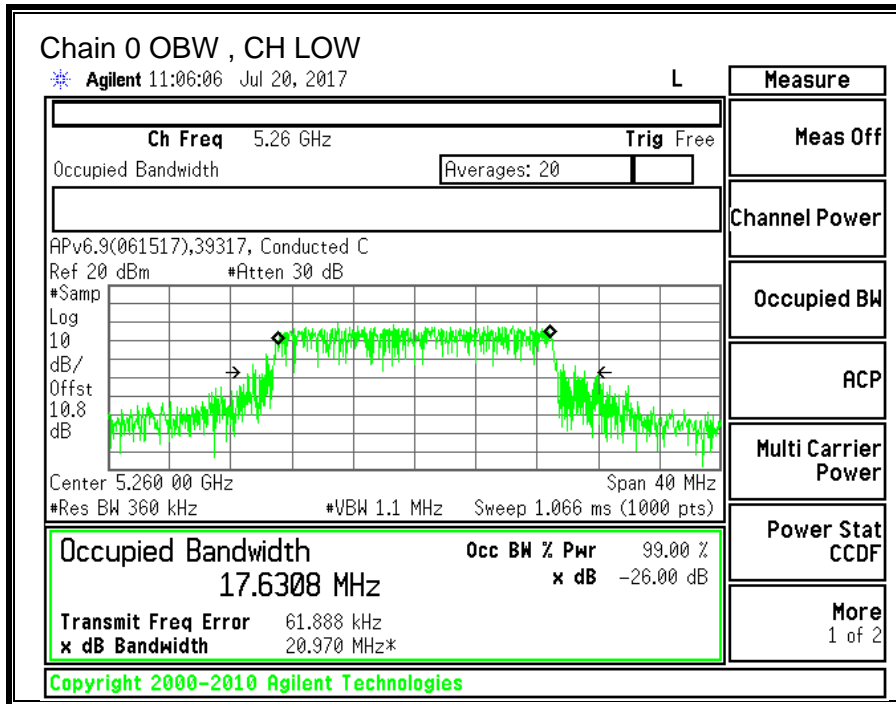

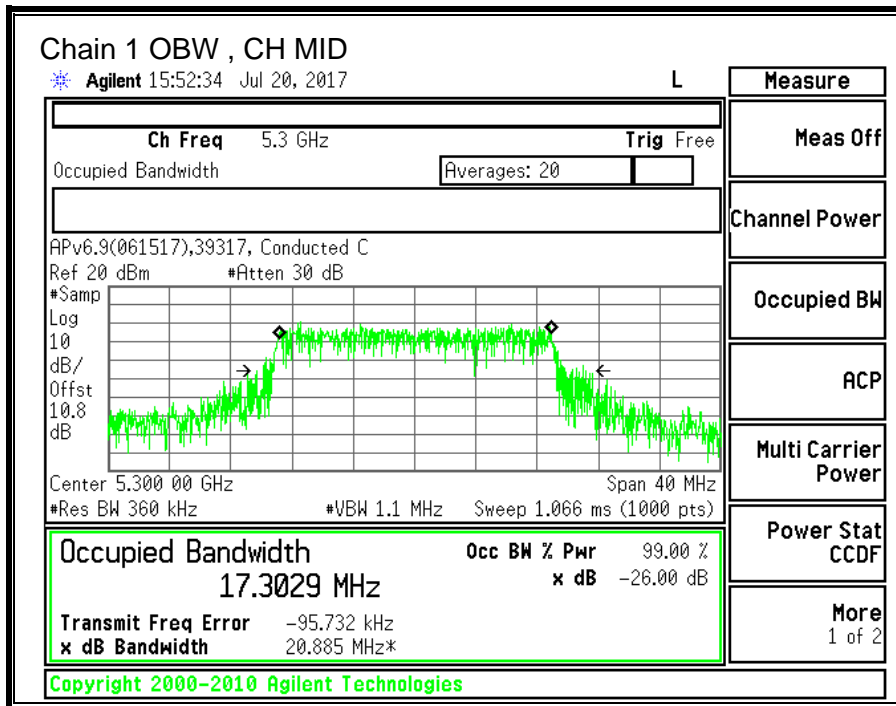
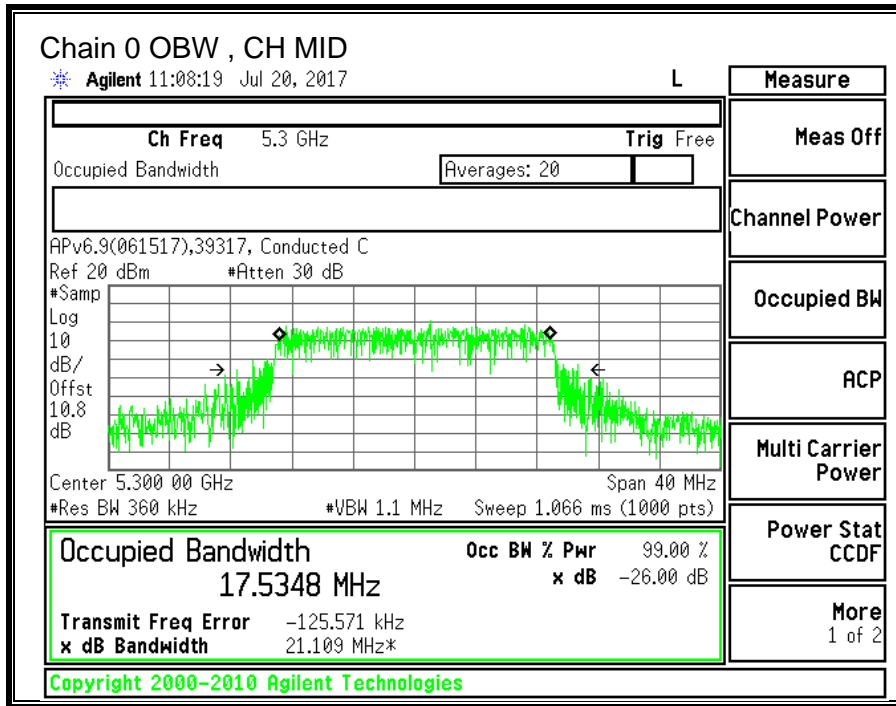

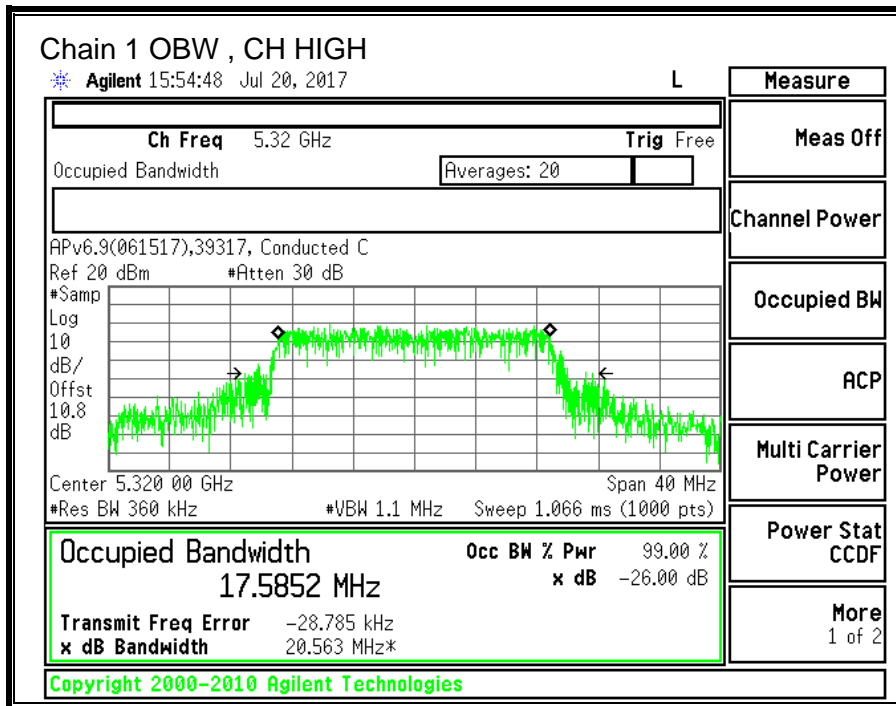
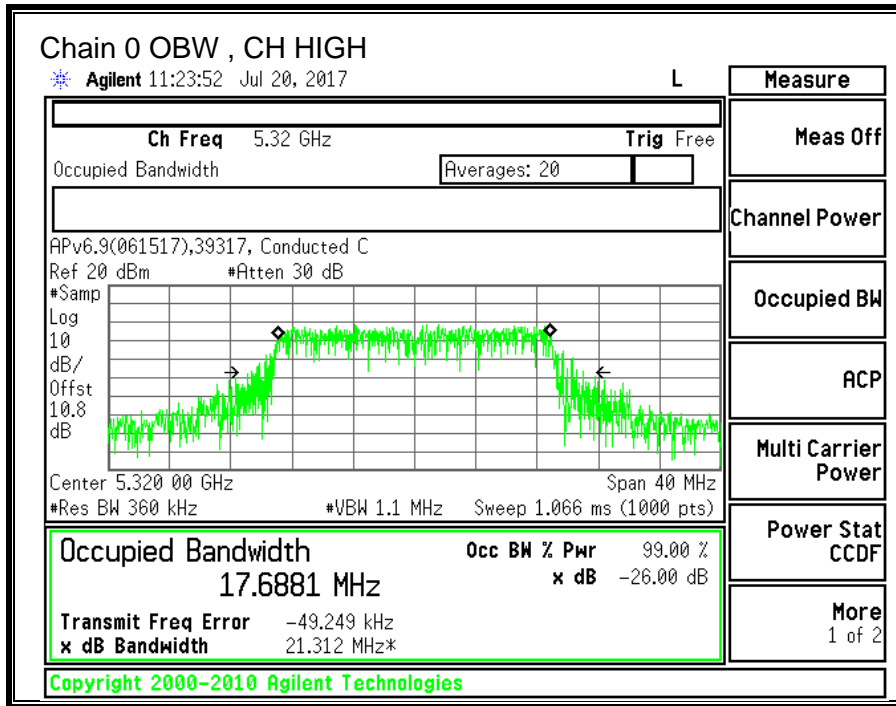

10.6.3. OUTPUT POWER AND PPSD

LIMITS

FCC §15.407 (a) (2)

For the band 5.25–5.35 GHz, the maximum conducted output power over the frequency band of operation shall not exceed the lesser of 250 mW or 11 dBm + 10 log B, where B is the 26–dB emission bandwidth in MHz. In addition, the maximum power spectral density shall not exceed 11 dBm in any 1–MHz band. If transmitting antennas of directional gain greater than 6 dBi are used, both the maximum conducted output power and the peak power spectral density shall be reduced by the amount in dB that the directional gain of the antenna exceeds 6 dBi.

TEST PROCEDURE

Measurements perform using a wideband gated RF power meter provided that the gate parameters are adjusted such that the power is measured only when the EUT is transmitting at its maximum power control level. Since the measurement is made only during the ON time of the transmitter, no duty cycle correction factor is required.

DIRECTIONAL ANTENNA GAIN

For power, the TX chains are uncorrelated and the antenna gain is unequal among the chains. The directional gain is:

5250-5350 MHz

Chain 0 Antenna Gain (dBi)	Chain 1 Antenna Gain (dBi)	Uncorrelated Chains Directional Gain (dBi)
0.10	1.60	0.91

For PSD the TX chains are correlated and the antenna gain is unequal among the chains. The directional gain is:

5250-5230 MHz

Chain 0 Antenna Gain (dBi)	Chain 1 Antenna Gain (dBi)	Correlated Chains Directional Gain (dBi)
0.10	1.60	3.89

RESULTS

ID:	39317	Date:	07/21/17
------------	-------	--------------	----------

Bandwidth and Antenna Gain

Channel	Frequency (MHz)	Min 26 dB BW (MHz)	Min 99% BW (MHz)	Directional Gain for Power (dBi)	Directional Gain for PPSD (dBi)
Low	5260	22.95	17.63	0.91	3.89
Mid	5300	23.10	17.30	0.91	3.89
High	5320	23.00	17.59	0.91	3.89

Limits

Channel	Frequency (MHz)	FCC Power Limit (dBm)	IC Power Limit (dBm)	IC EIRP Limit (dBm)	Power Limit (dBm)	FCC PSD Limit (dBm)	IC PSD Limit (dBm)	PPSD Limit (dBm)
Low	5260	24.00	23.46	29.46	23.46	11.00	11.00	11.00
Mid	5300	24.00	23.38	29.38	23.38	11.00	11.00	11.00
High	5320	24.00	23.45	29.45	23.45	11.00	11.00	11.00

Duty Cycle CF (dB)	0.19	Included in Calculations of Corr'd PPSD
---------------------------	------	--

Output Power Results

Channel	Frequency (MHz)	Chain 0 Meas Power (dBm)	Chain 1 Meas Power (dBm)	Total Corr'd Power (dBm)	Power Limit (dBm)	Power Margin (dB)
Low	5260	13.05	13.32	16.20	23.46	-7.27
Mid	5300	12.81	13.36	16.10	23.38	-7.28
High	5320	12.91	13.38	16.16	23.45	-7.29

PPSD Results

Channel	Frequency (MHz)	Chain 0 Meas PPSD (dBm)	Chain 1 Meas PPSD (dBm)	Total Corr'd PPSD (dBm)	PPSD Limit (dBm)	PPSD Margin (dB)
Low	5260	1.591	1.955	4.98	11.00	-6.02
Mid	5300	1.113	2.034	4.80	11.00	-6.20
High	5320	1.630	2.100	5.07	11.00	-5.93

Note: the power readings above were measured with gated method, and the measurement was taken only during the ON time. No duty cycle correction was necessary.

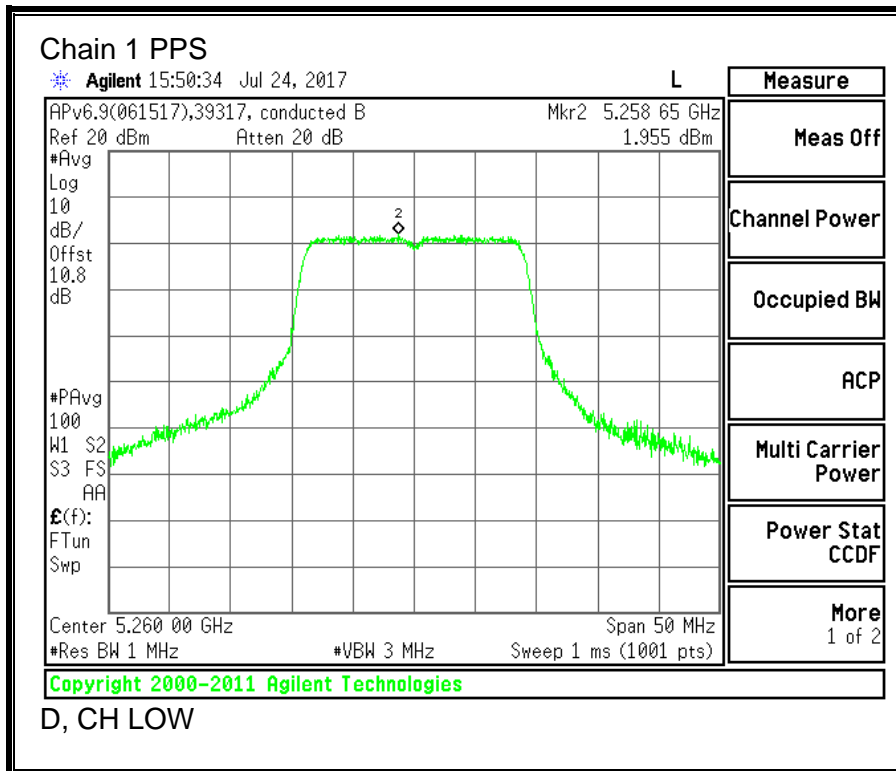
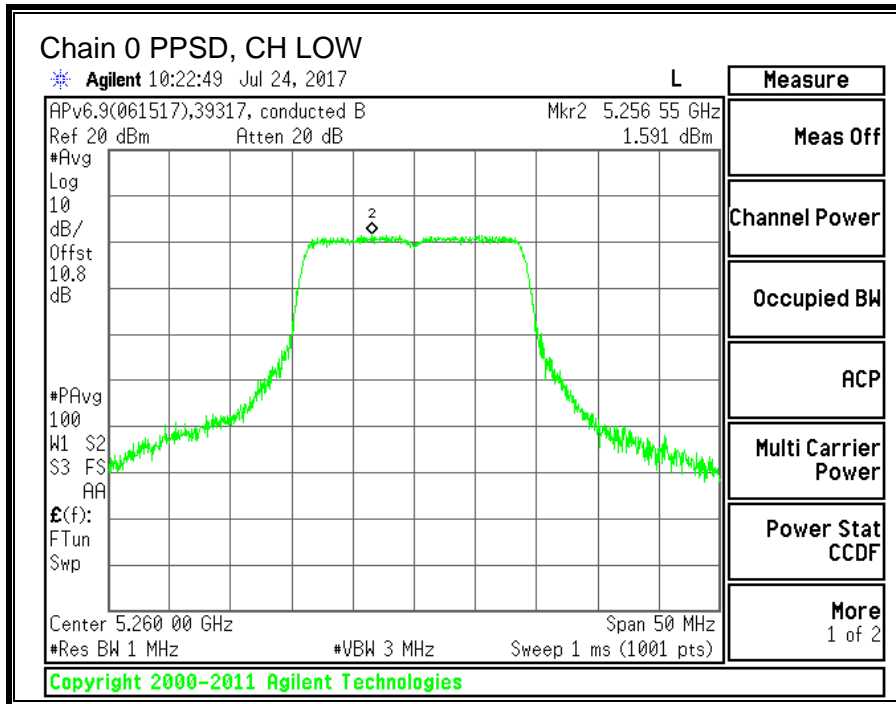

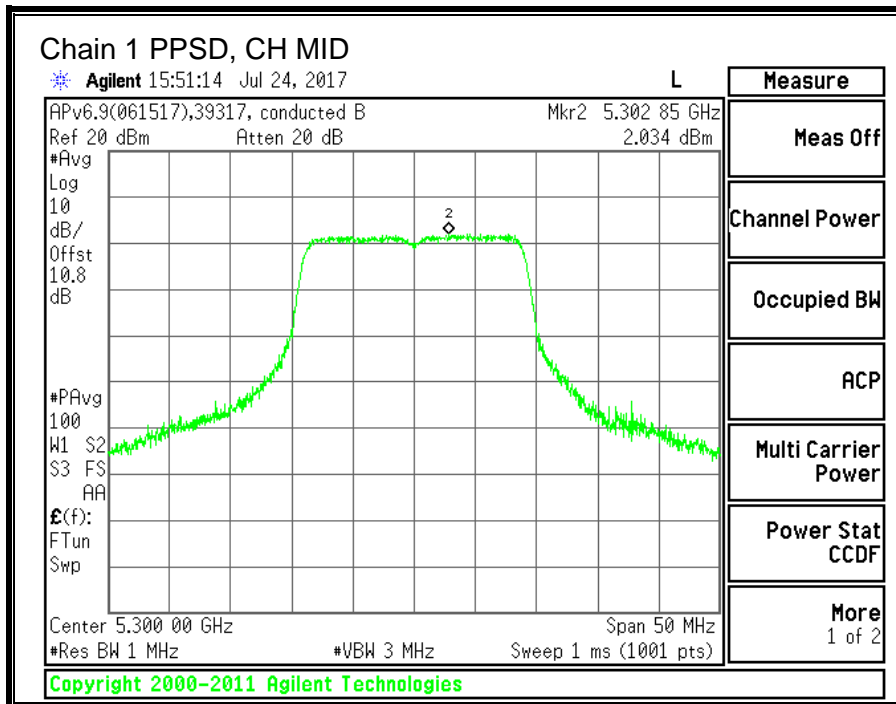
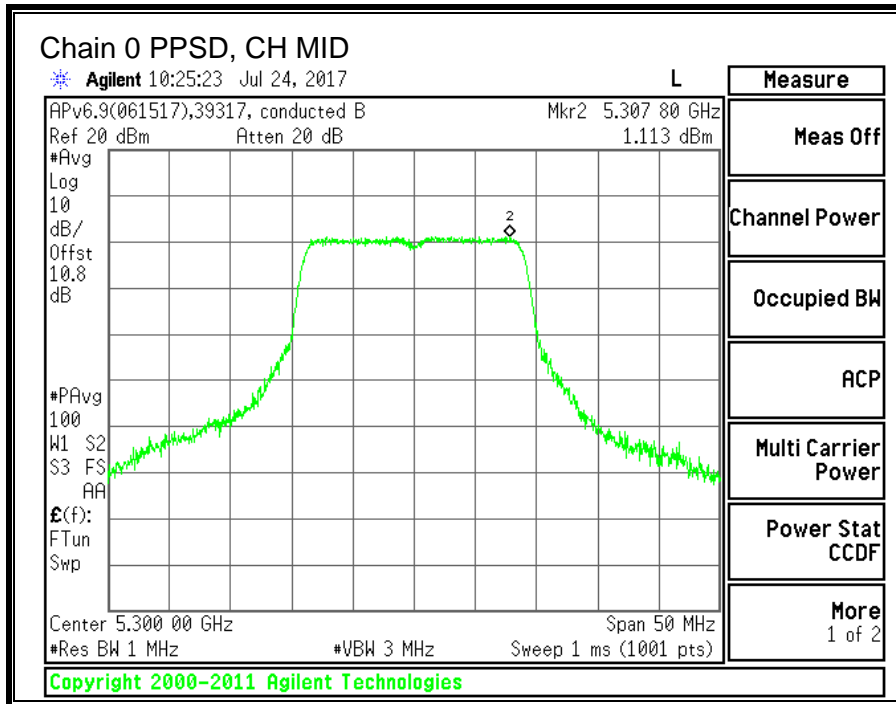

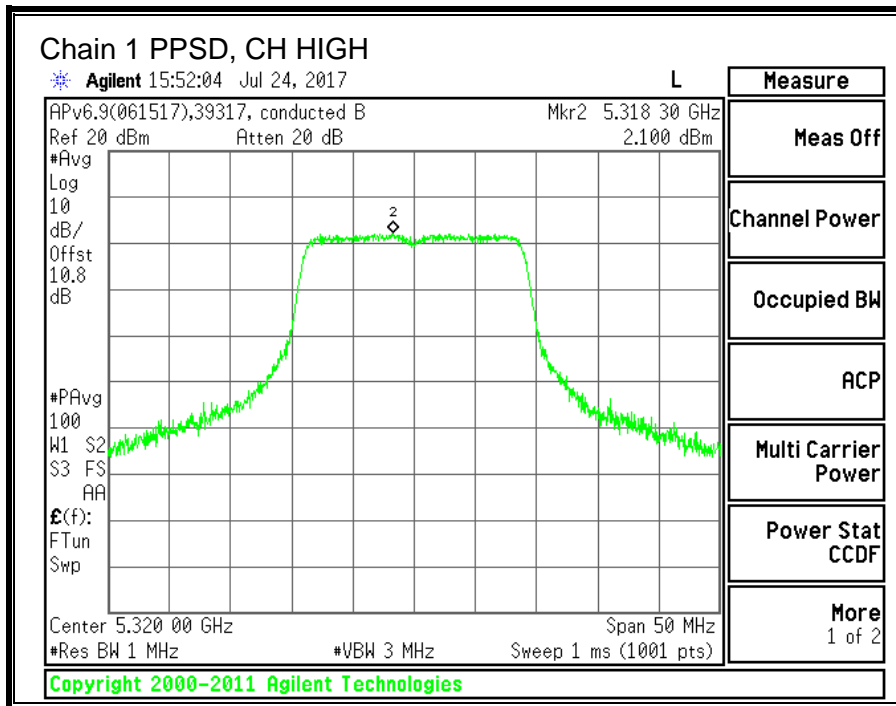
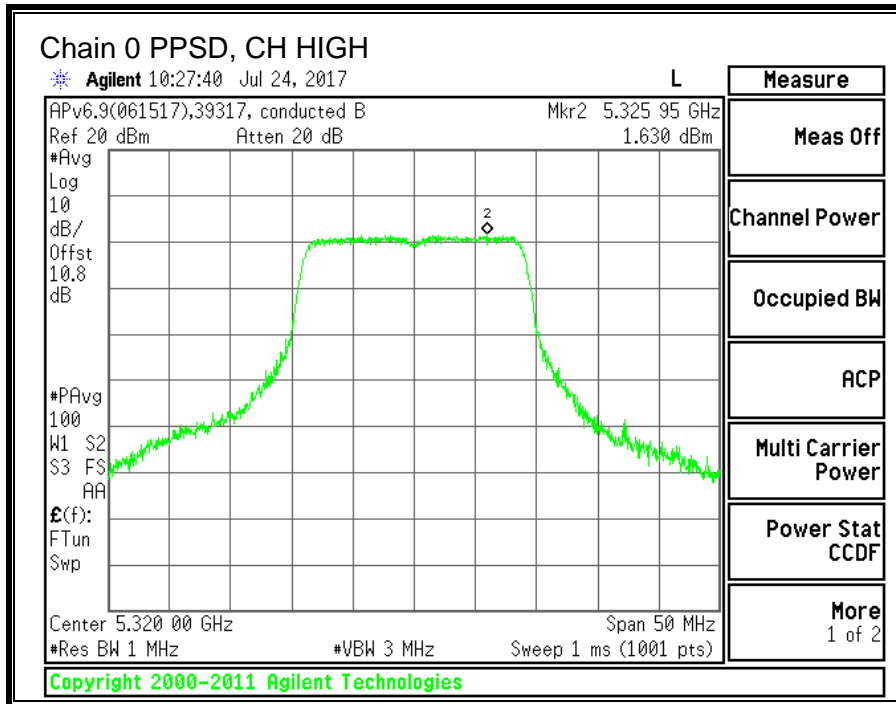

10.7. 11n HT40 2TX CDD MIMO MODE IN THE 5.3GHz BAND

10.7.1. 26 dB BANDWIDTH

LIMITS

None; for reporting purposes only.

RESULTS

Channel	Frequency	26 dB BW Chain 0 (MHz)	26 dB BW Chain 1 (MHz)
Low	5270	43.50	42.60
High	5310	43.10	42.60

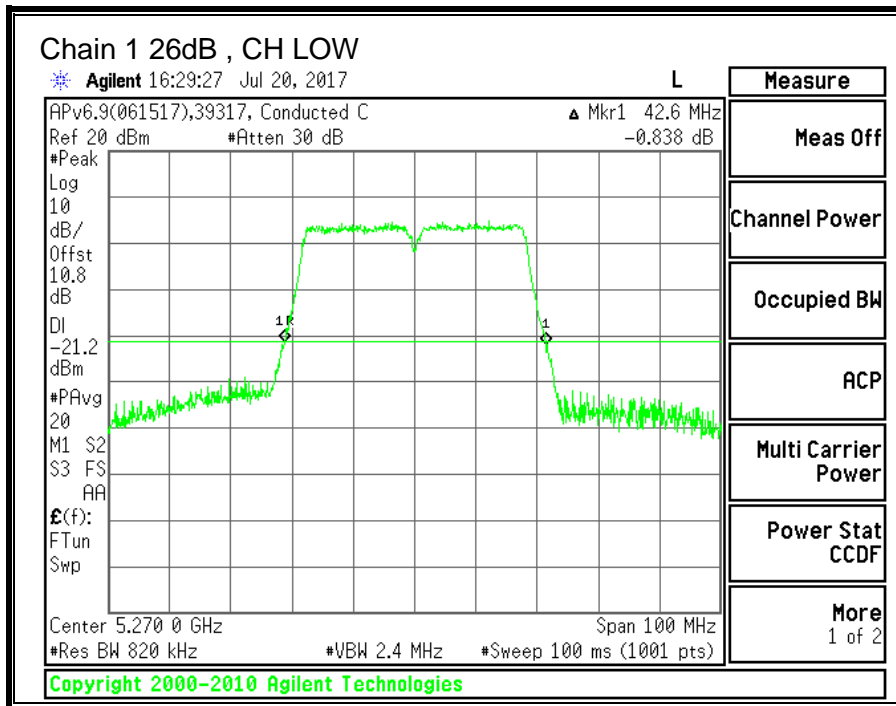
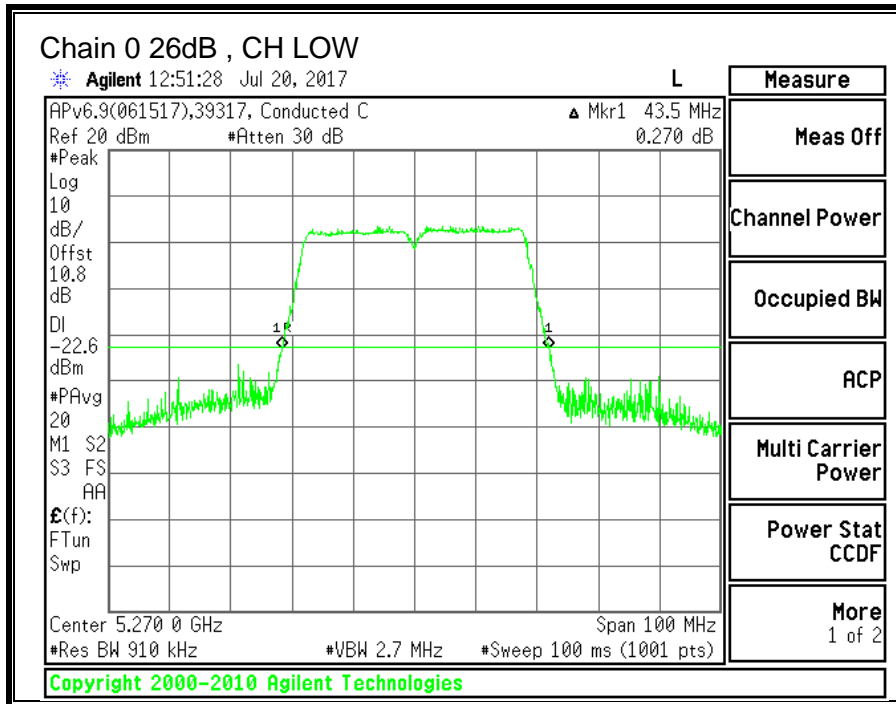

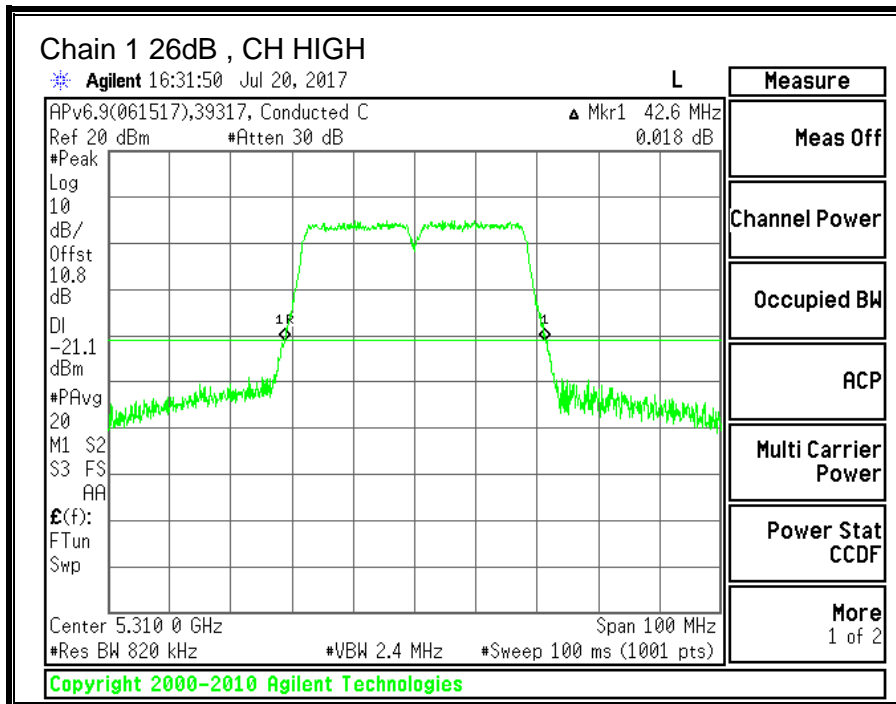
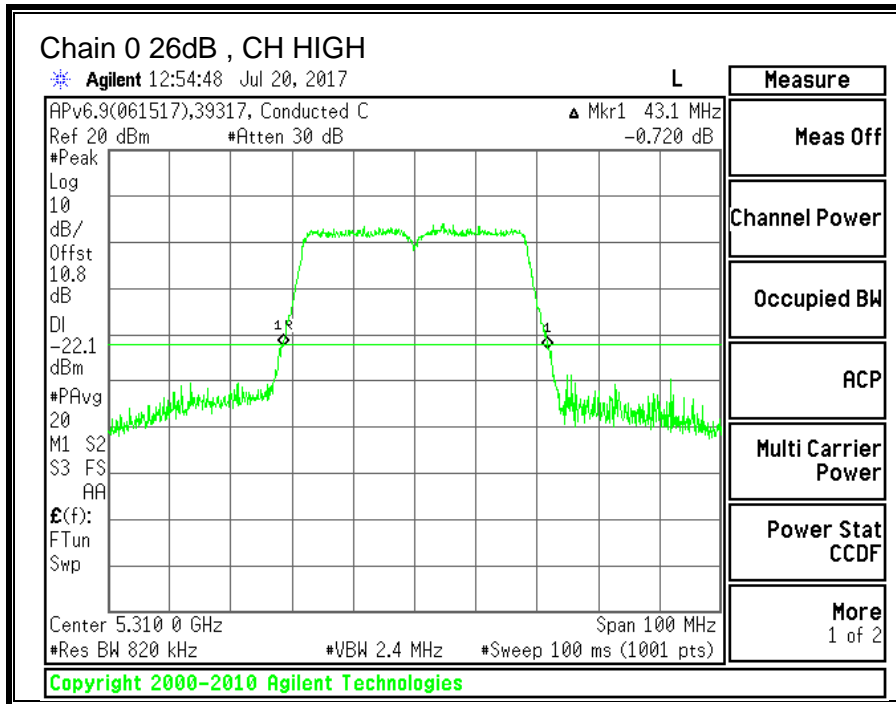

10.7.2. 99% BANDWIDTH

LIMITS

None; for reporting purposes only.

RESULTS

Channel	Frequency	99% BW Chain 0 (MHz)	99% BW Chain 1 (MHz)
Low	5270	35.1488	35.8963
High	5310	36.4068	34.9158

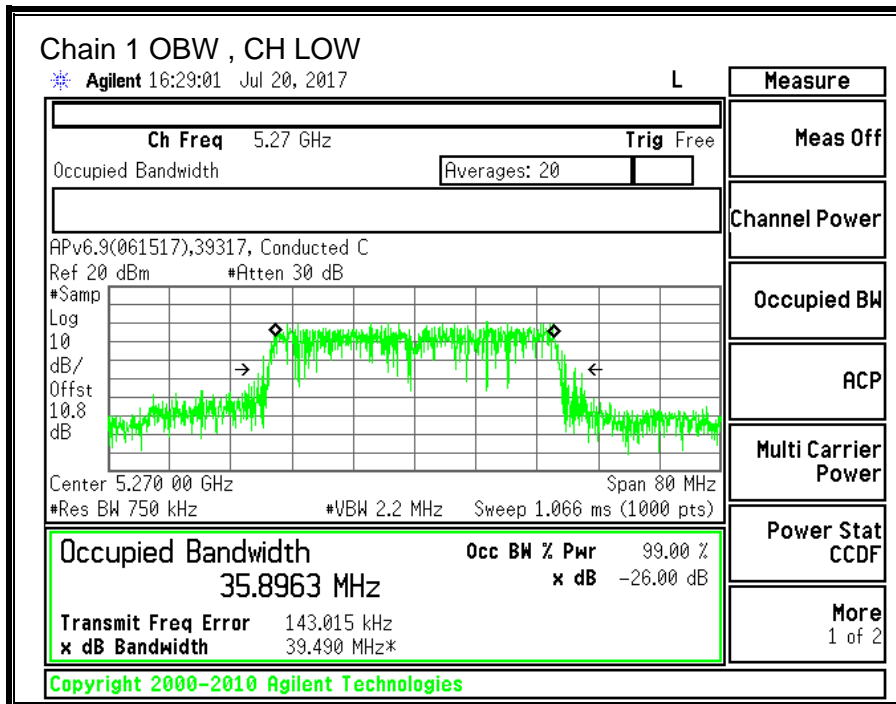
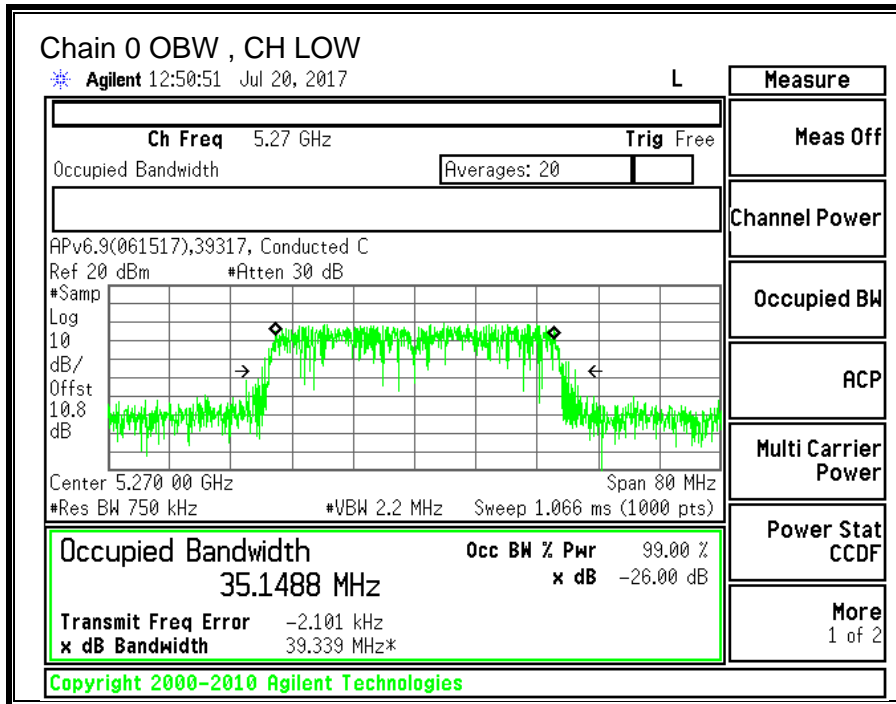

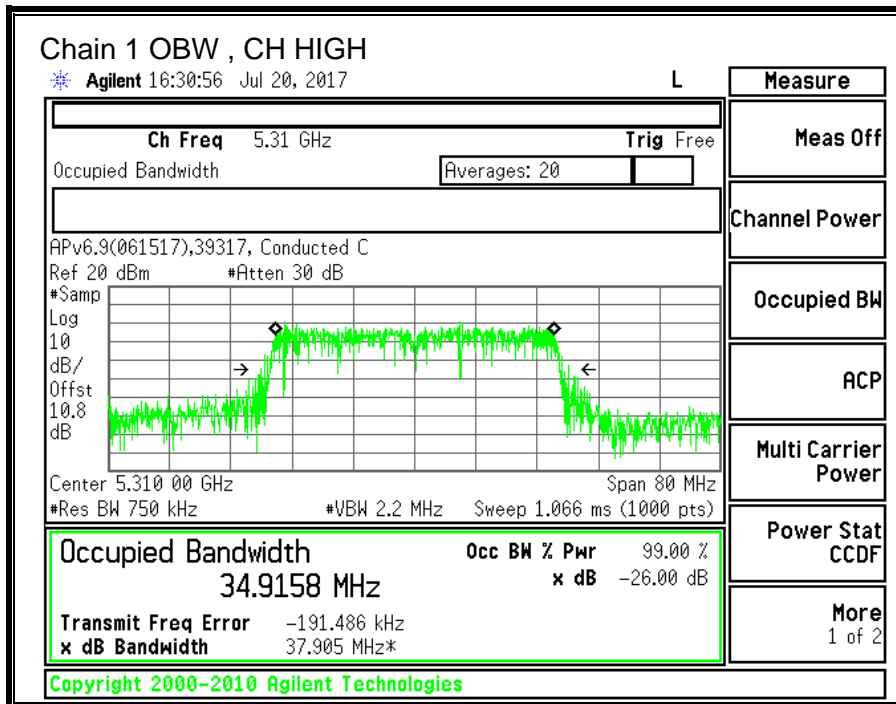
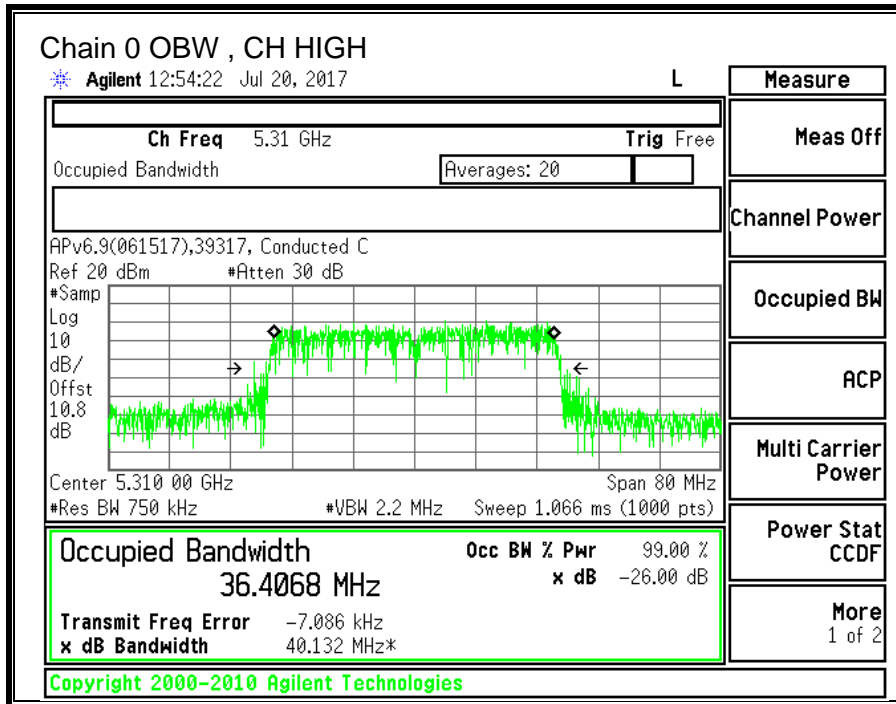

10.7.3. OUTPUT POWER AND PPSD

LIMITS

FCC §15.407 (a) (2)

For the band 5.25–5.35 GHz, the maximum conducted output power over the frequency band of operation shall not exceed the lesser of 250 mW or 11 dBm + 10 log B, where B is the 26–dB emission bandwidth in MHz. In addition, the maximum power spectral density shall not exceed 11 dBm in any 1–MHz band. If transmitting antennas of directional gain greater than 6 dBi are used, both the maximum conducted output power and the peak power spectral density shall be reduced by the amount in dB that the directional gain of the antenna exceeds 6 dBi.

TEST PROCEDURE

Measurements perform using a wideband gated RF power meter provided that the gate parameters are adjusted such that the power is measured only when the EUT is transmitting at its maximum power control level. Since the measurement is made only during the ON time of the transmitter, no duty cycle correction factor is required.

DIRECTIONAL ANTENNA GAIN

For power, the TX chains are uncorrelated and the antenna gain is unequal among the chains. The directional gain is:

5250-5350 MHz

Chain 0 Antenna Gain (dBi)	Chain 1 Antenna Gain (dBi)	Uncorrelated Chains Directional Gain (dBi)
0.10	1.60	0.91

For PSD the TX chains are correlated and the antenna gain is unequal among the chains. The directional gain is:

5250-5230 MHz

Chain 0 Antenna Gain (dBi)	Chain 1 Antenna Gain (dBi)	Correlated Chains Directional Gain (dBi)
0.10	1.60	3.89

RESULTS

ID:	39317	Date:	07/21/17
------------	-------	--------------	----------

Channel	Frequency (MHz)	Min 26 dB BW (MHz)	Min 99% BW (MHz)	Directional Gain for Power (dBi)	Directional Gain for PPSD (dBi)
Low	5270	42.60	35.15	0.91	3.89
High	5310	42.60	34.92	0.91	3.89

Limits

Channel	Frequency (MHz)	FCC Power Limit (dBm)	IC Power Limit (dBm)	IC EIRP Limit (dBm)	Power Limit (dBm)	FCC PPSD Limit (dBm)	IC PSD Limit (dBm)	PPSD Limit (dBm)
Low	5270	24.00	24.00	30.00	24.00	11.00	11.00	11.00
High	5310	24.00	24.00	30.00	24.00	11.00	11.00	11.00

Duty Cycle CF (dB)	0.39	Included in Calculations of Corr'd PPSD
---------------------------	------	--

Output Power Results

Channel	Frequency (MHz)	Chain 0 Meas Power (dBm)	Chain 1 Meas Power (dBm)	Total Corr'd Power (dBm)	Power Limit (dBm)	Power Margin (dB)
Low	5270	12.84	13.60	16.25	24.00	-7.75
High	5310	12.92	13.39	16.17	24.00	-7.83

PPSD Results

Channel	Frequency (MHz)	Chain 0 Meas PPSD (dBm)	Chain 1 Meas PPSD (dBm)	Total Corr'd PPSD (dBm)	PPSD Limit (dBm)	PPSD Margin (dB)
Low	5270	-1.880	-0.423	2.31	11.00	-8.69
High	5310	-1.263	-0.681	2.44	11.00	-8.56

Note: the power readings above were measured with gated method, and the measurement was taken only during the ON time. No duty cycle correction was necessary.

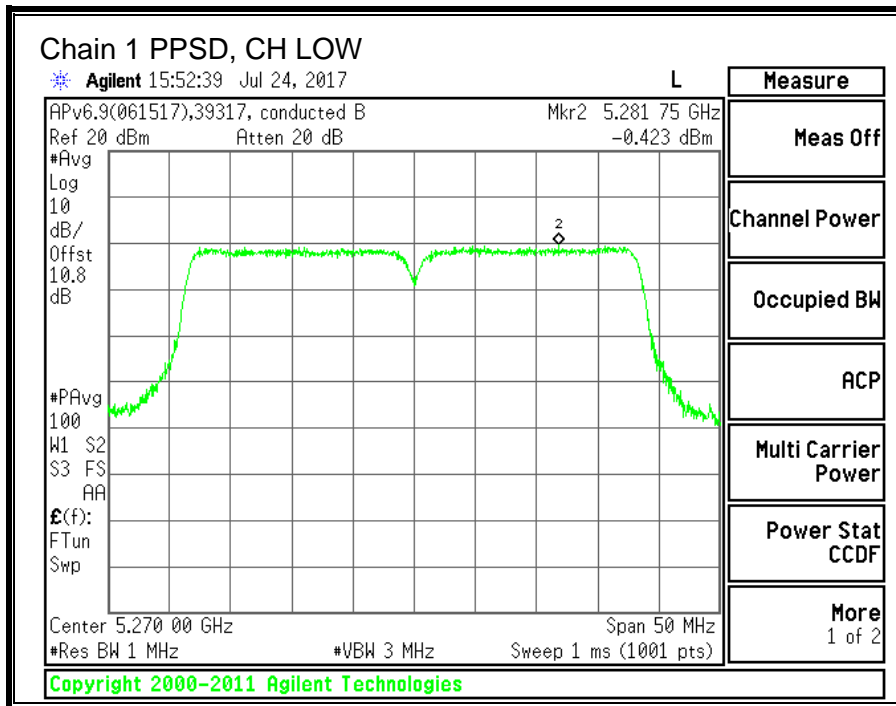
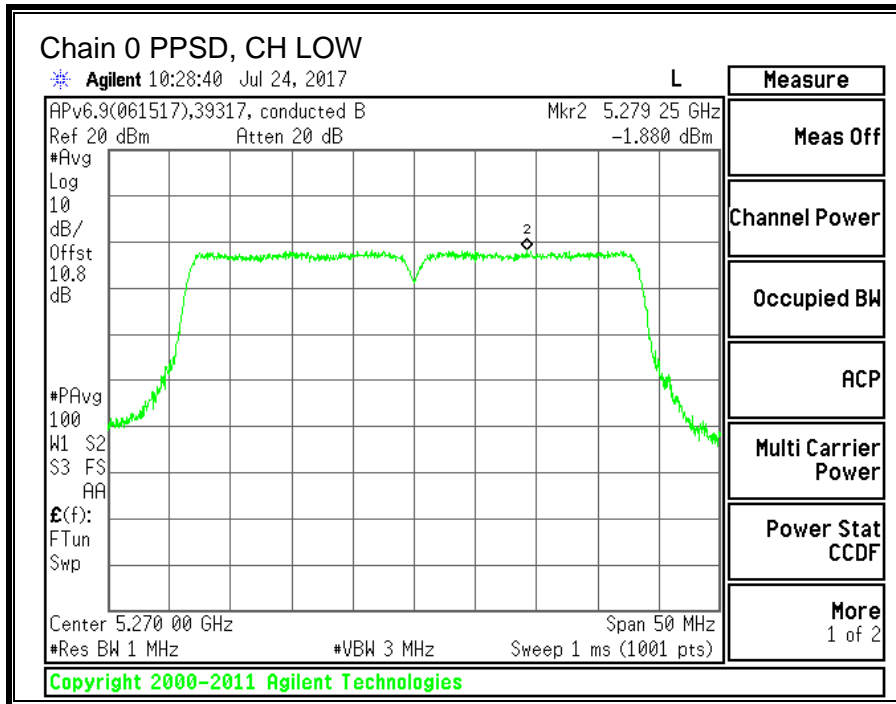

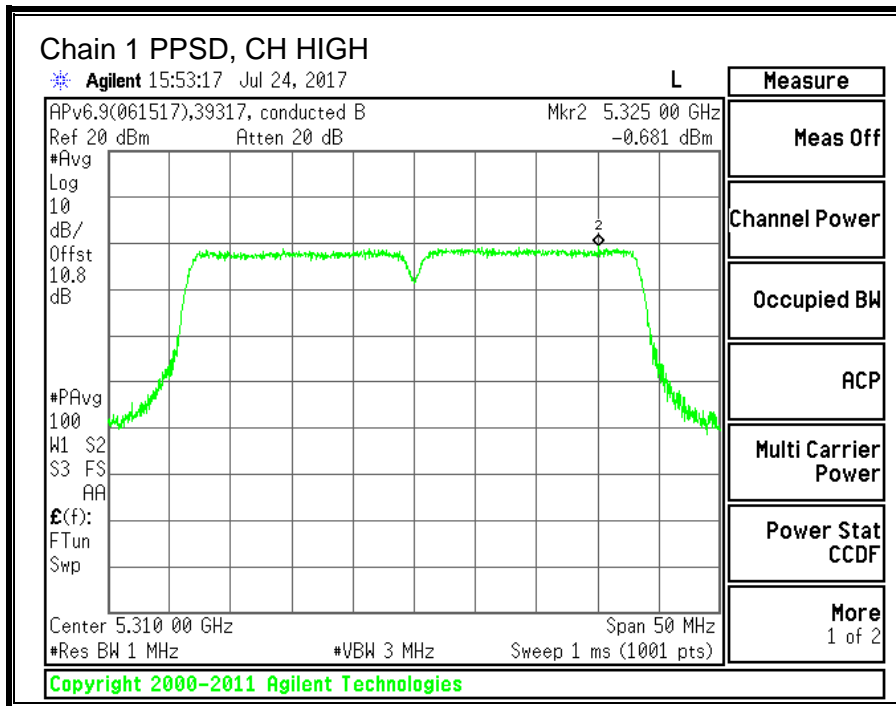
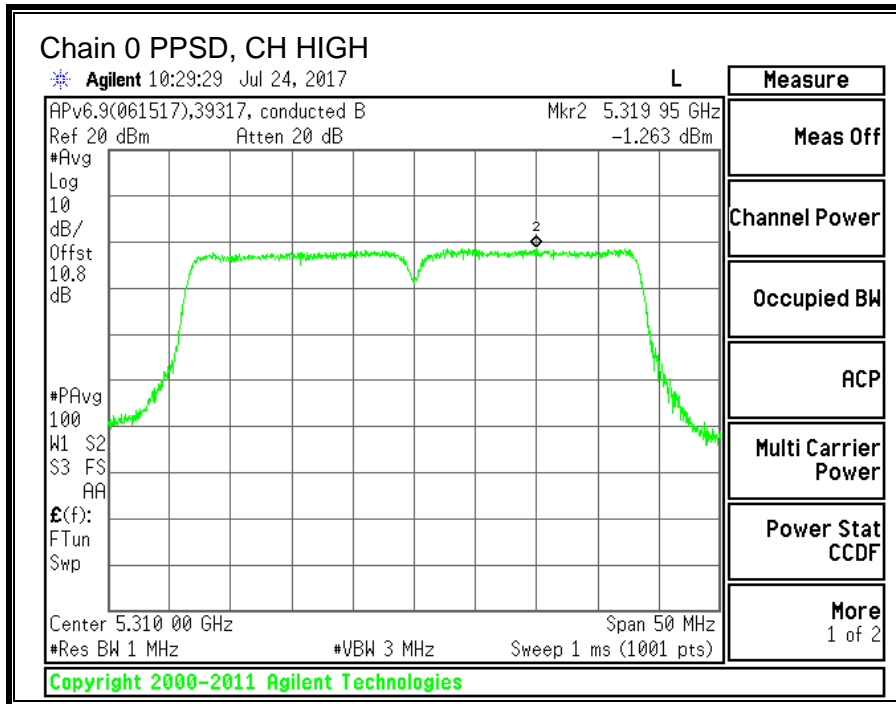

10.8. 11ac VHT80 2TX CDD MIMO MODE IN THE 5.3GHz BAND

10.8.1. 26 dB BANDWIDTH

LIMITS

None; for reporting purposes only.

RESULTS

Channel	Frequency	26 dB BW Chain 0 (MHz)	26 dB BW Chain 1 (MHz)
Mid	5290	87.00	86.00

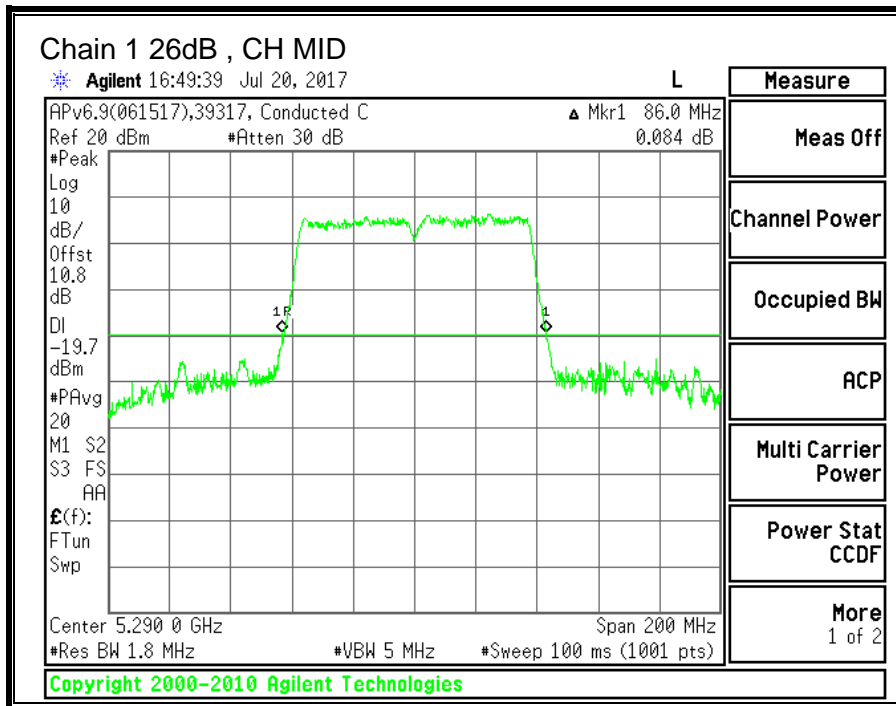
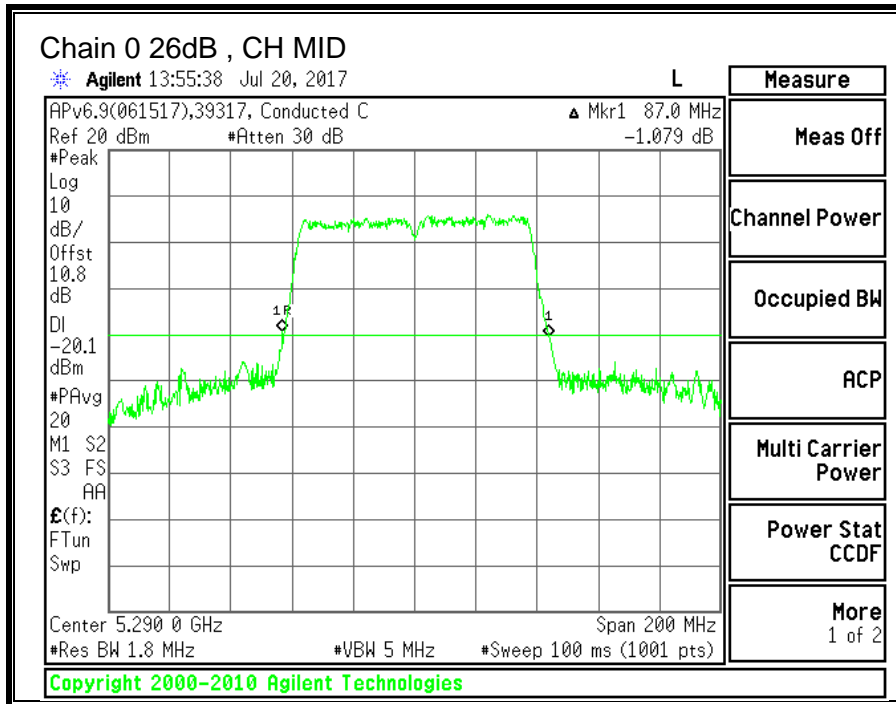

10.8.2. 99% BANDWIDTH

LIMITS

None; for reporting purposes only.

RESULTS

Channel	Frequency	99% BW Chain 0 (MHz)	99% BW Chain 1 (MHz)
Mid	5290	73.5167	73.8460

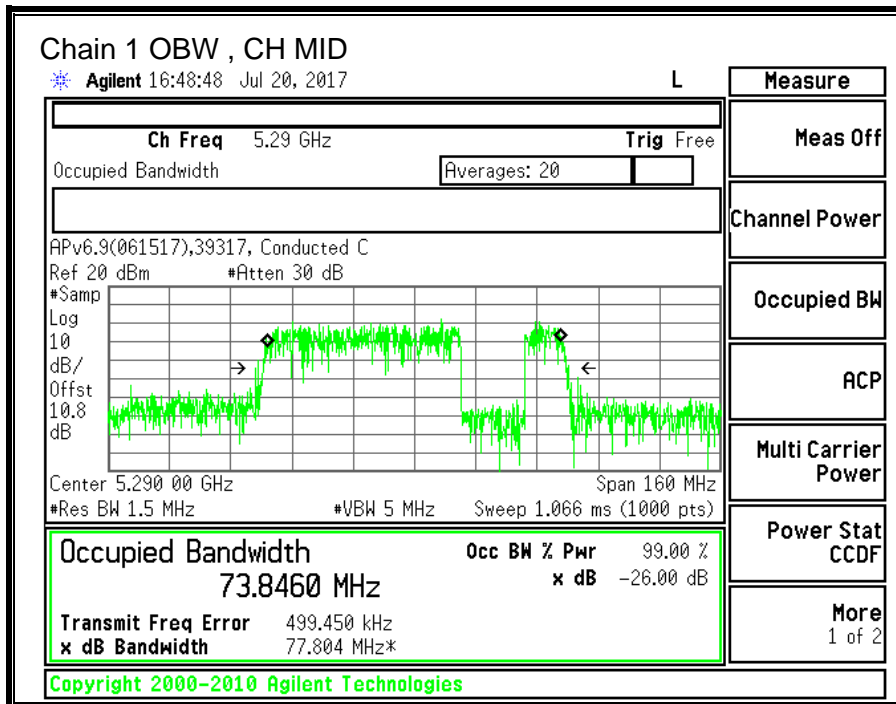
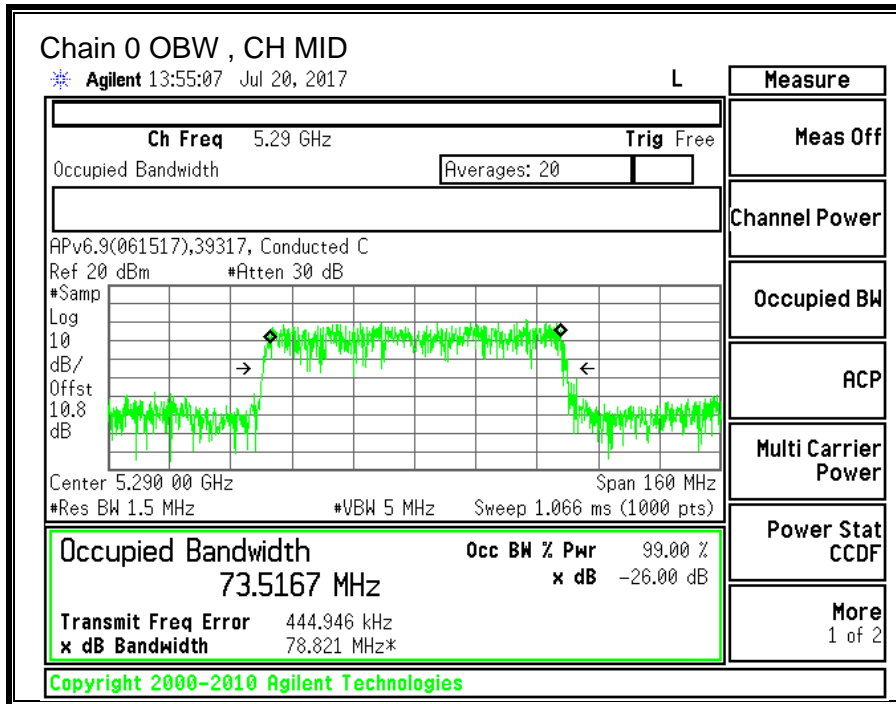

10.8.3. OUTPUT POWER AND PPSD

LIMITS

FCC §15.407 (a) (2)

For the band 5.25–5.35 GHz, the maximum conducted output power over the frequency band of operation shall not exceed the lesser of 250 mW or 11 dBm + 10 log B, where B is the 26–dB emission bandwidth in MHz. In addition, the maximum power spectral density shall not exceed 11 dBm in any 1–MHz band. If transmitting antennas of directional gain greater than 6 dBi are used, both the maximum conducted output power and the peak power spectral density shall be reduced by the amount in dB that the directional gain of the antenna exceeds 6 dBi.

TEST PROCEDURE

Measurements perform using a wideband gated RF power meter provided that the gate parameters are adjusted such that the power is measured only when the EUT is transmitting at its maximum power control level. Since the measurement is made only during the ON time of the transmitter, no duty cycle correction factor is required.

DIRECTIONAL ANTENNA GAIN

For power, the TX chains are uncorrelated and the antenna gain is unequal among the chains. The directional gain is:

5250-5350 MHz

Chain 0 Antenna Gain (dBi)	Chain 1 Antenna Gain (dBi)	Uncorrelated Chains Directional Gain (dBi)
0.10	1.60	0.91

For PSD the TX chains are correlated and the antenna gain is unequal among the chains. The directional gain is:

5250-5230 MHz

Chain 0 Antenna Gain (dBi)	Chain 1 Antenna Gain (dBi)	Correlated Chains Directional Gain (dBi)
0.10	1.60	3.89

RESULTS

ID:	39317	Date:	07/21/17
------------	-------	--------------	----------

Bandwidth and Antenna Gain

Channel	Frequency (MHz)	Min 26 dB BW (MHz)	Min 99% BW (MHz)	Directional Gain for Power (dBi)	Directional Gain for PPSD (dBi)
Low	5290	86.00	73.52	0.91	3.89

Limits

Channel	Frequency (MHz)	FCC Power Limit (dBm)	IC Power Limit (dBm)	IC EIRP Limit (dBm)	Power Limit (dBm)	FCC PPSD Limit (dBm)	IC PSD Limit (dBm)	PPSD Limit (dBm)
Low	5290	24.00	24.00	30.00	24.00	11.00	11.00	11.00

Duty Cycle CF (dB)	0.71	Included in Calculations of Corr'd PPSD
---------------------------	------	--

Output Power Results

Channel	Frequency (MHz)	Chain 0 Meas Power (dBm)	Chain 1 Meas Power (dBm)	Total Corr'd Power (dBm)	Power Limit (dBm)	Power Margin (dB)
Low	5290	13.11	13.66	16.40	24.00	-7.60

PPSD Results

Channel	Frequency (MHz)	Chain 0 Meas PPSD (dBm)	Chain 1 Meas PPSD (dBm)	Total Corr'd PPSD (dBm)	PPSD Limit (dBm)	PPSD Margin (dB)
Low	5290	-4.298	-3.709	-0.27	11.00	-11.27

Note: the power readings above were measured with gated method, and the measurement was taken only during the ON time. No duty cycle correction was necessary.

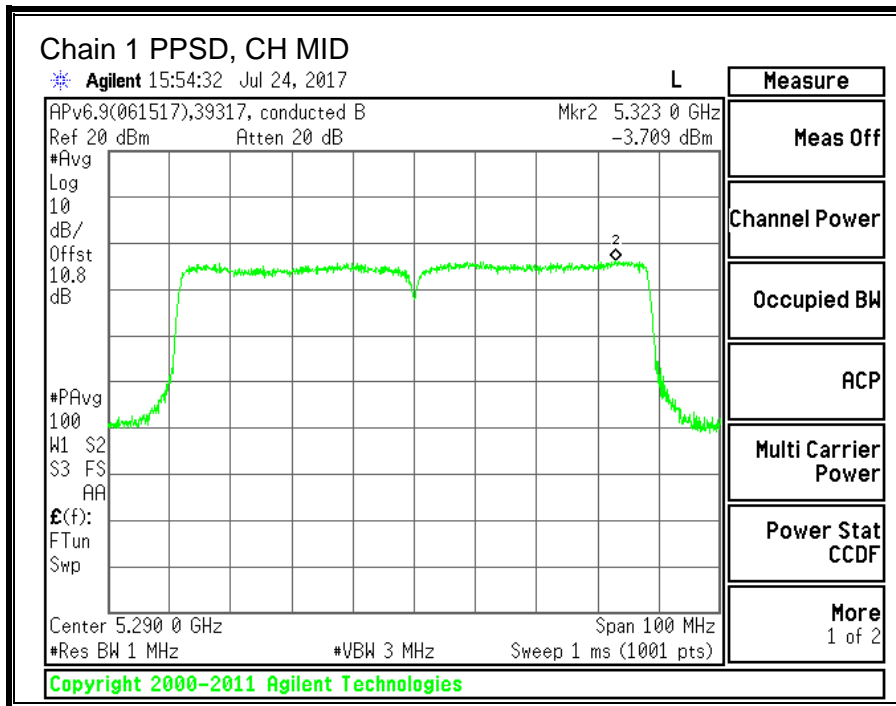
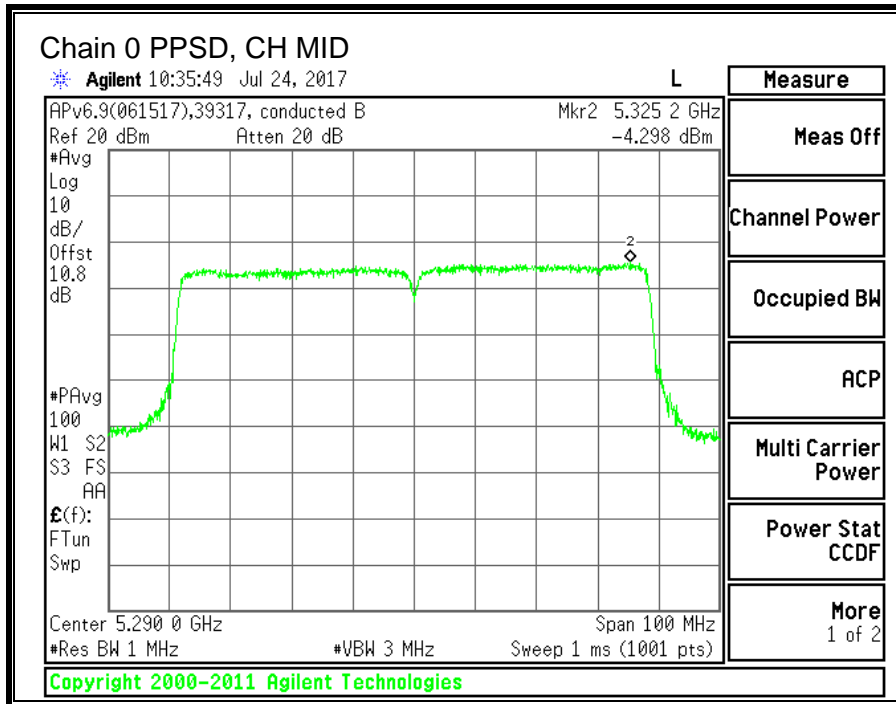

10.9. 11a 2TX CDD MIMO MODE IN THE 5.6GHz BAND

10.9.1. 26 dB BANDWIDTH

LIMITS

None; for reporting purposes only.

RESULTS

Channel	Frequency	26 dB BW Chain 0 (MHz)	26 dB BW Chain 1 (MHz)
Low	5500	23.35	22.00
Mid	5580	23.55	22.35
Mid (FCC)	5640	23.92	25.16
High	5700	23.30	22.15
144	5720	25.50	22.15

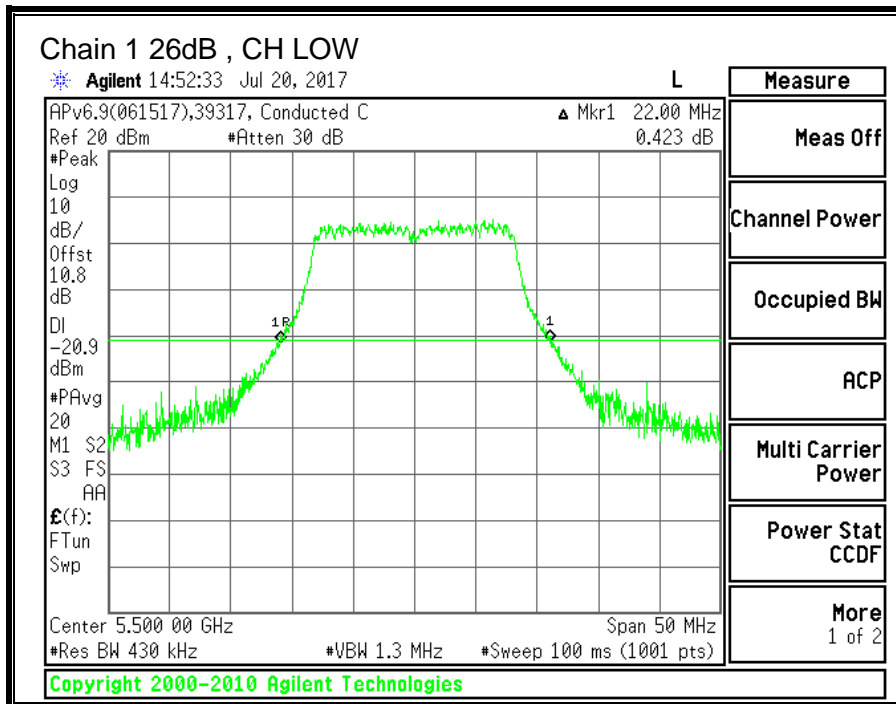
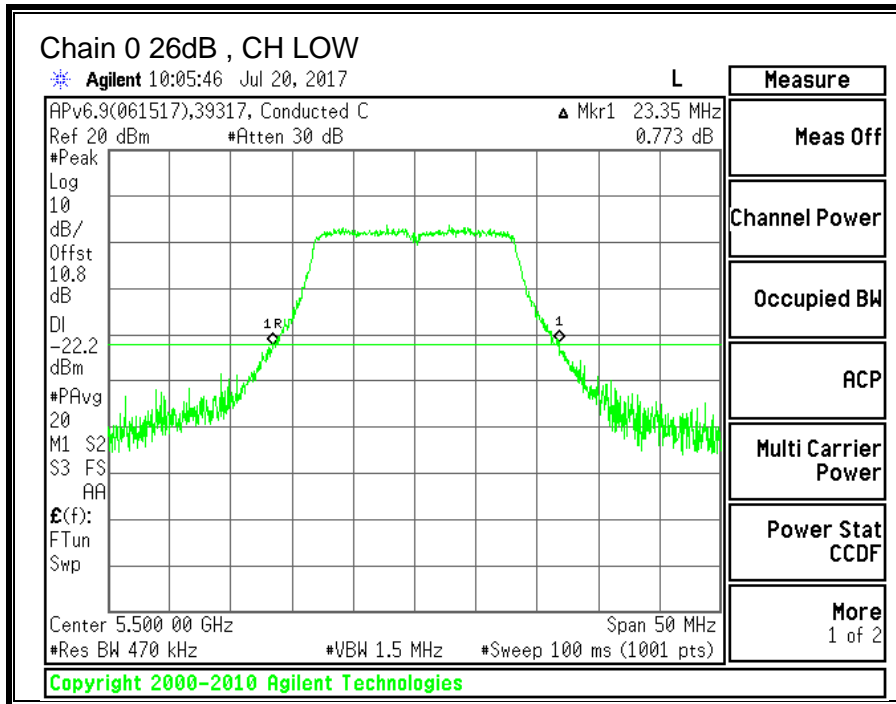

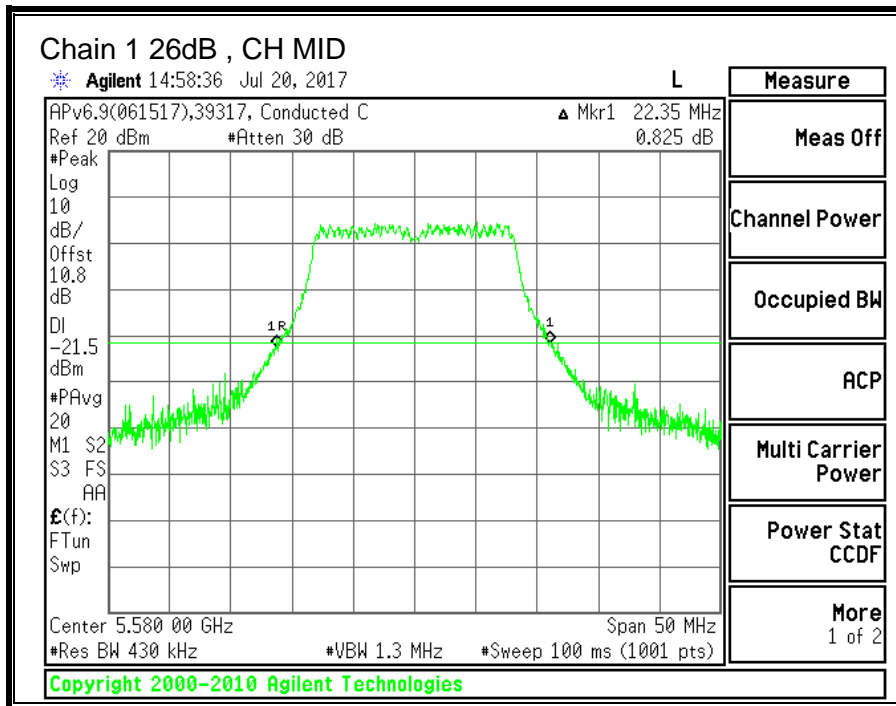
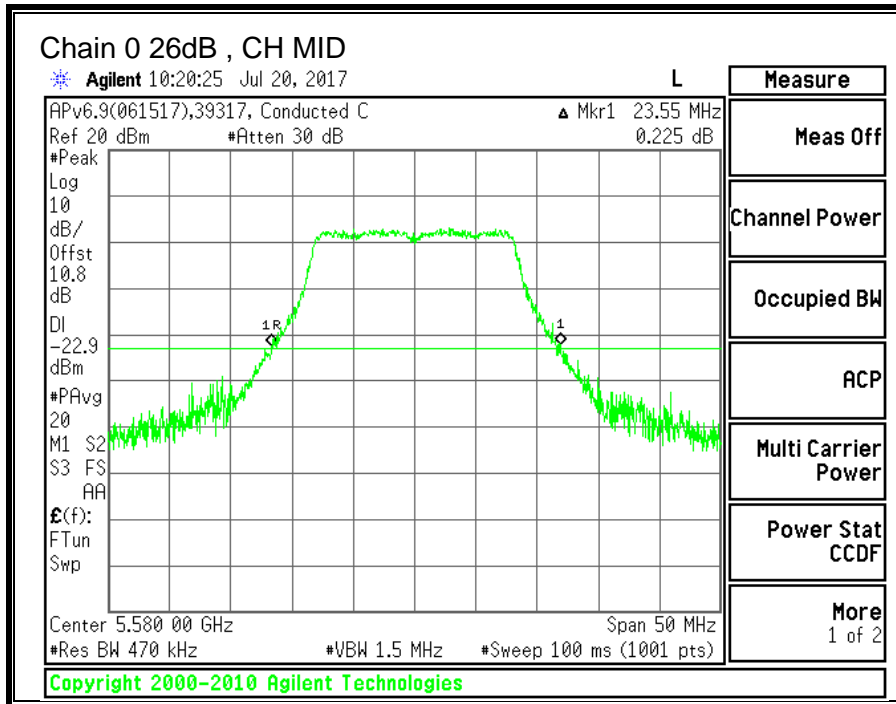

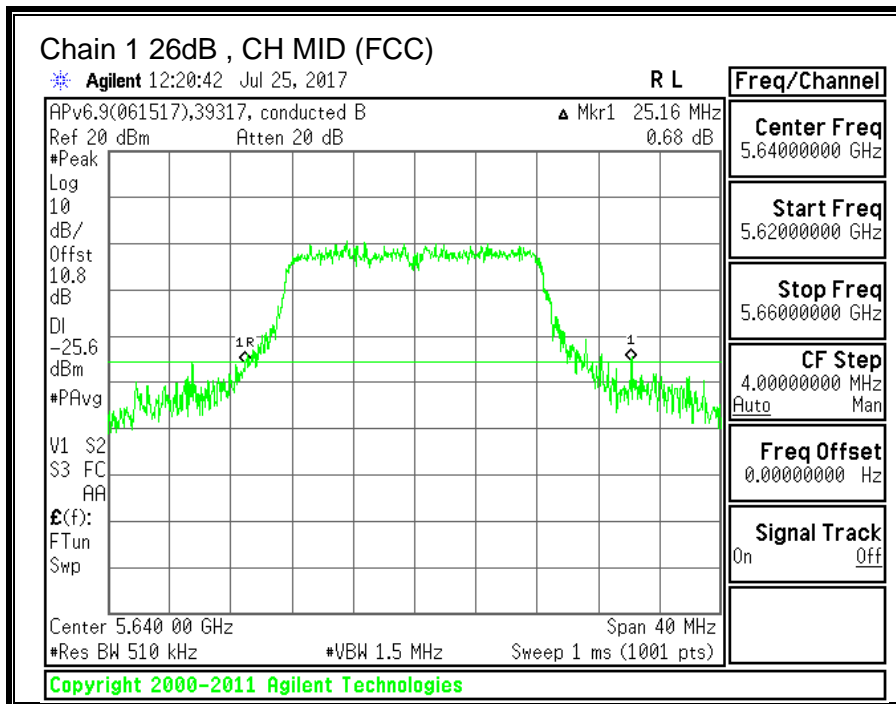
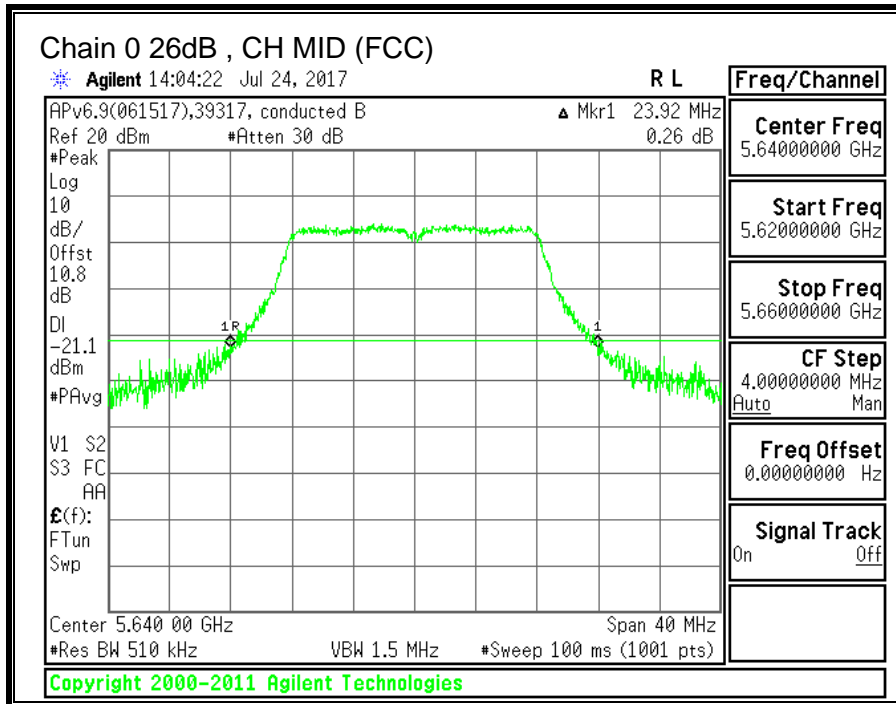

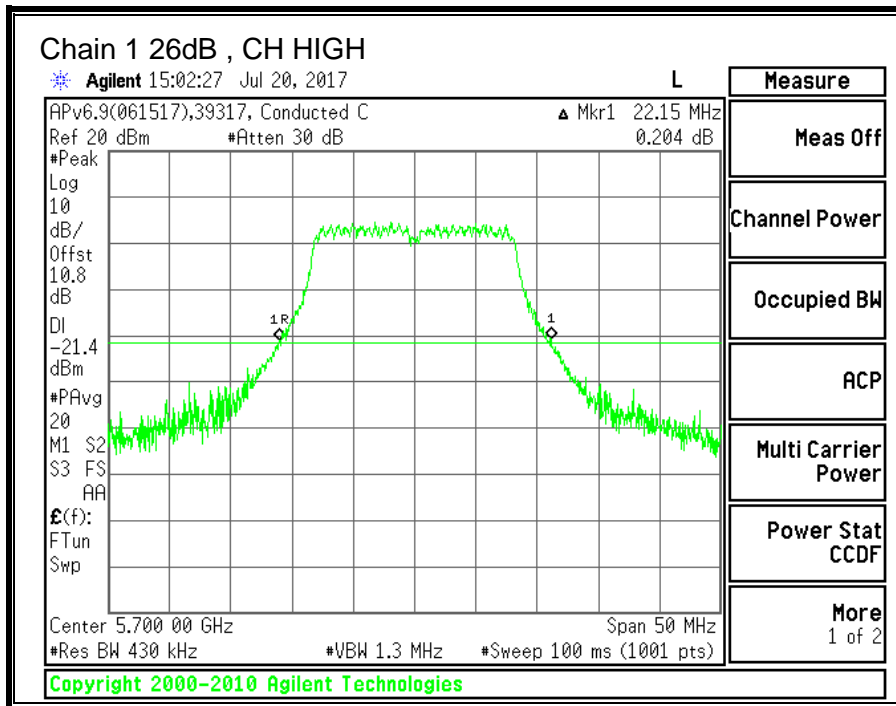
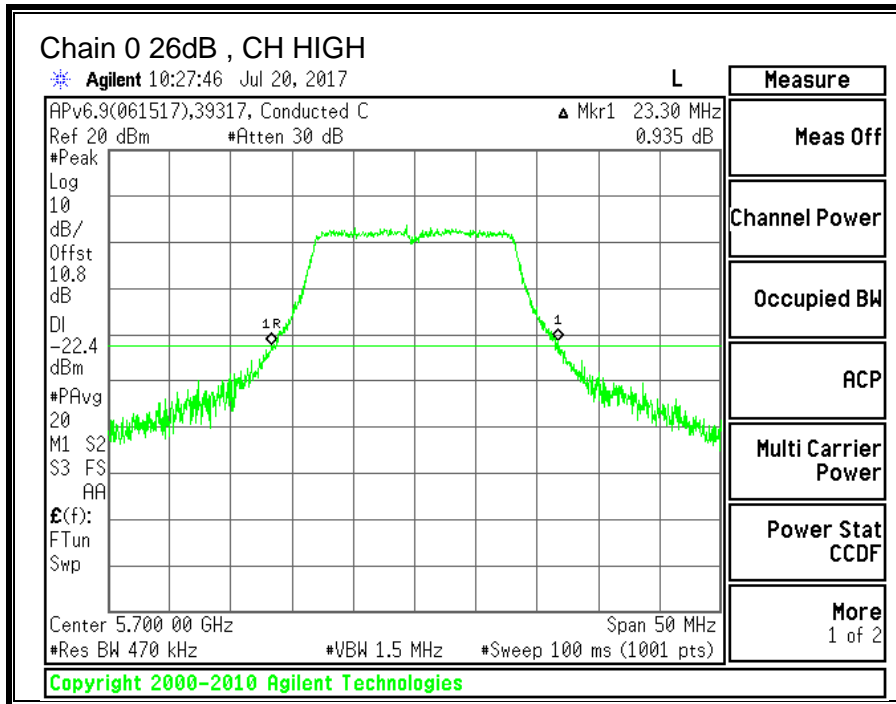

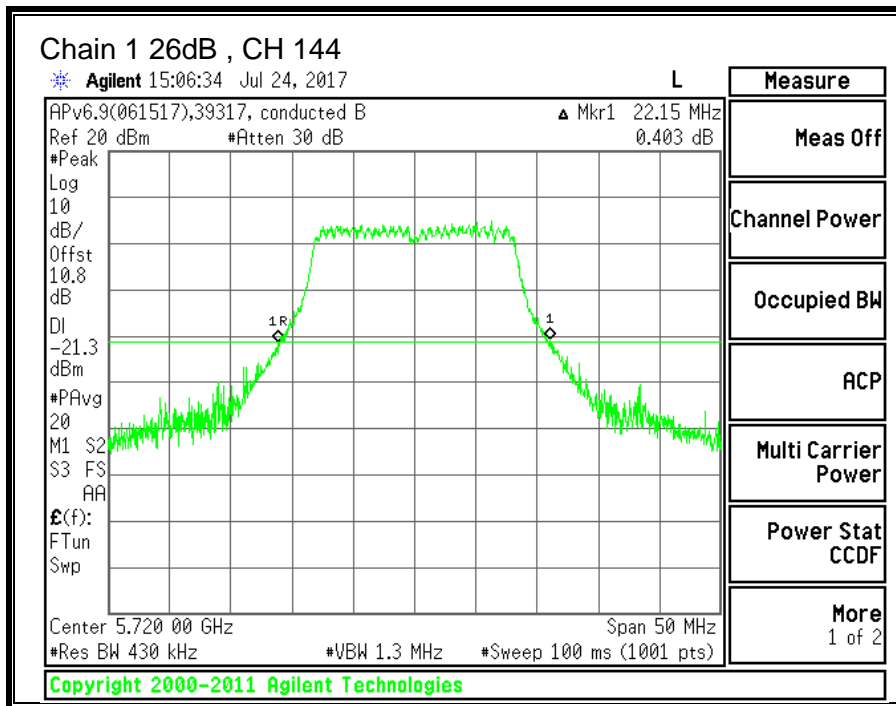
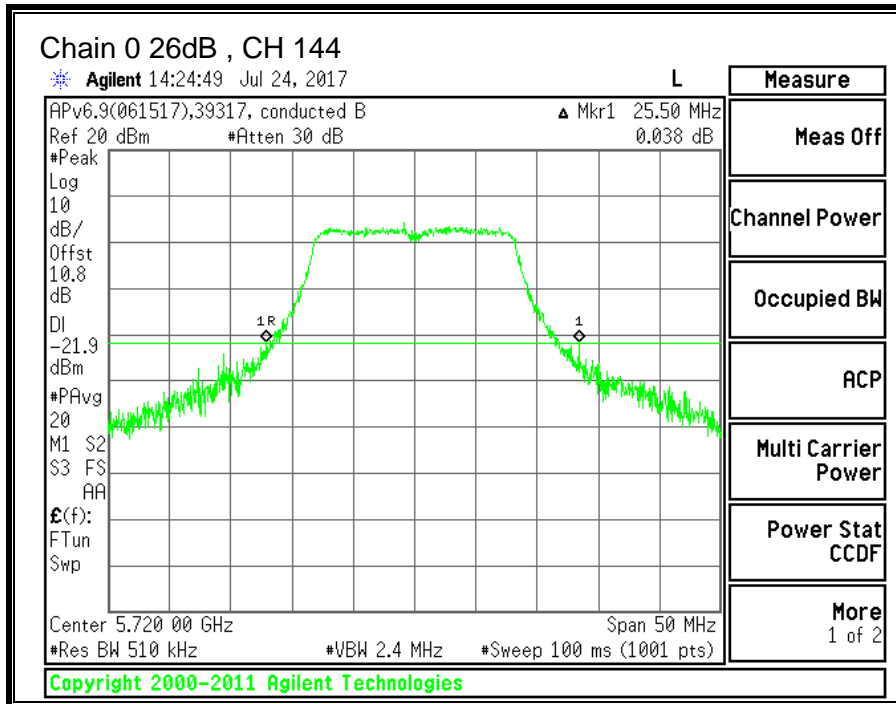

10.9.2. 99% BANDWIDTH

LIMITS

None; for reporting purposes only.

RESULTS

Channel	Frequency	99% BW Chain 0 (MHz)	99% BW Chain 1 (MHz)
Low	5500	16.0647	16.1052
Mid	5580	16.3997	16.0619
Mid (FCC)	5640	16.2478	16.4194
High	5700	16.2155	16.4654
144	5720	16.5795	16.4875

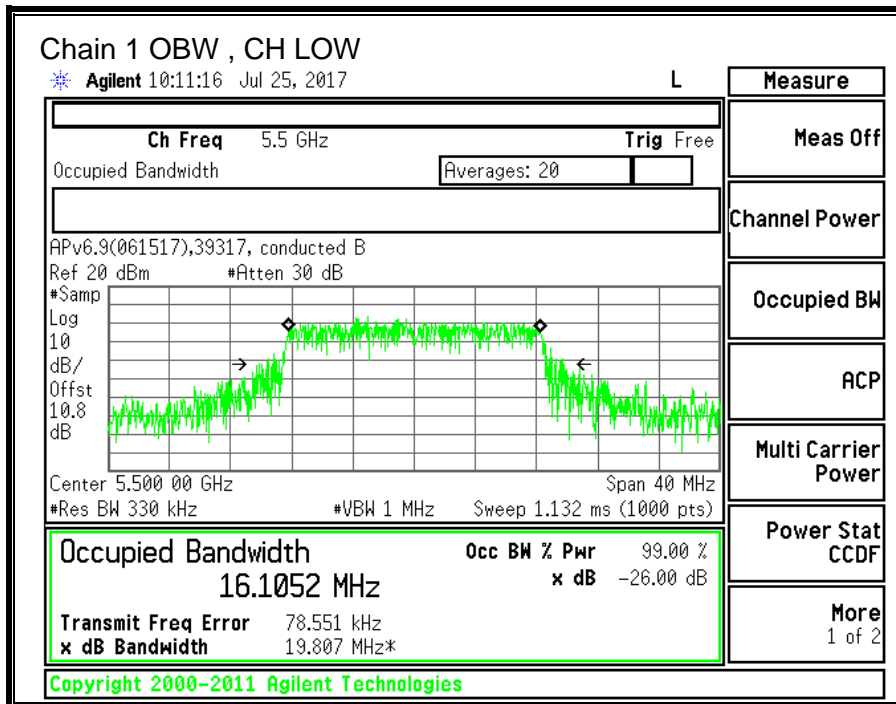
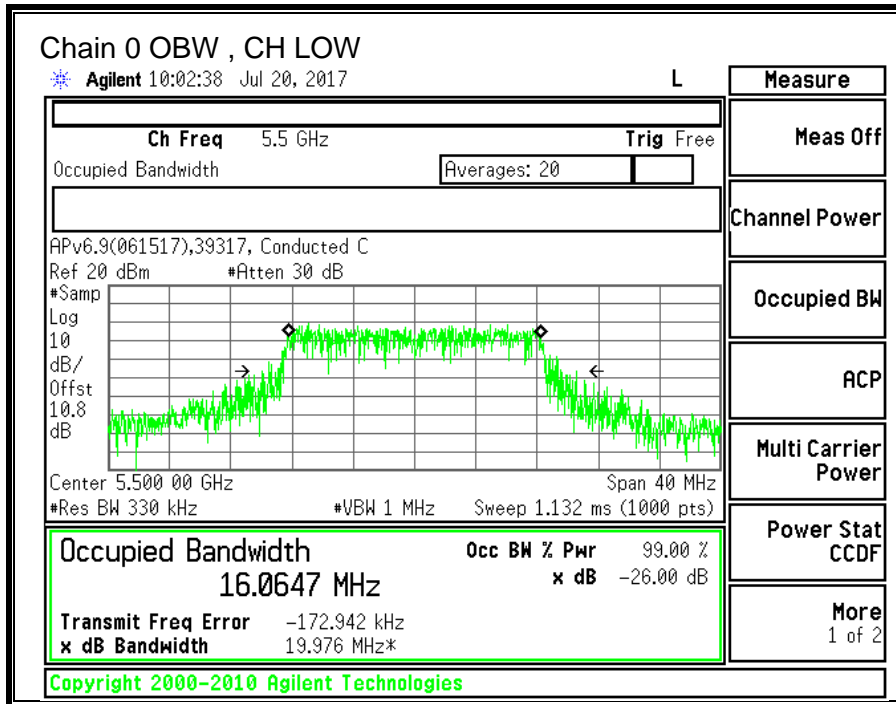

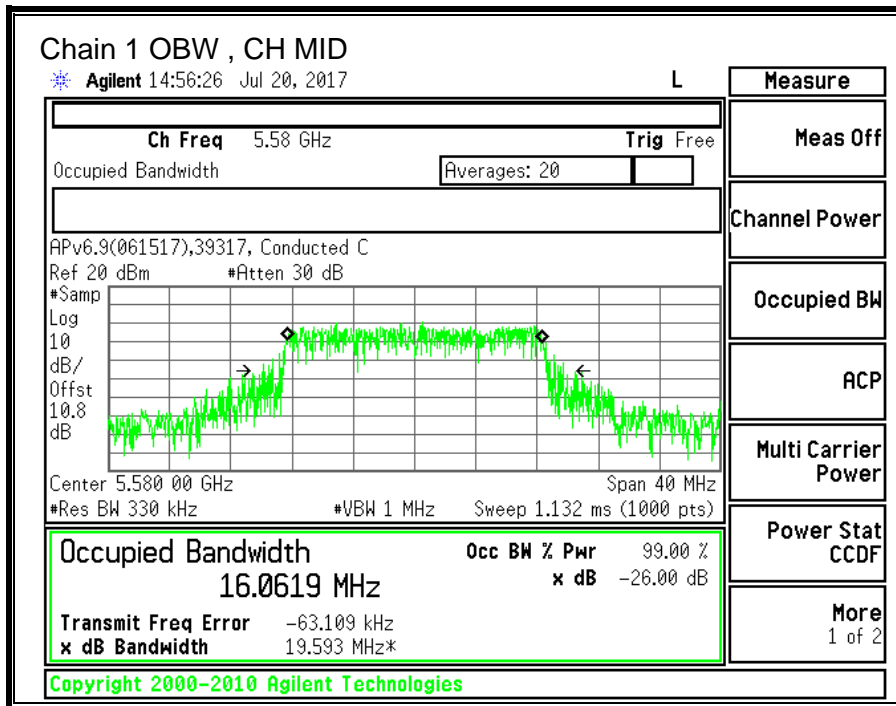
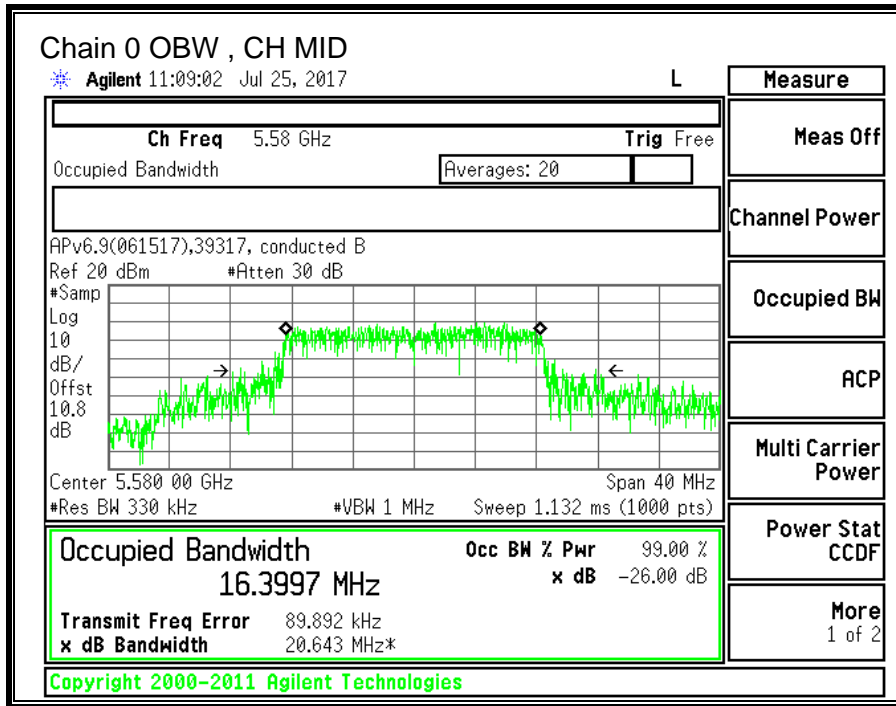

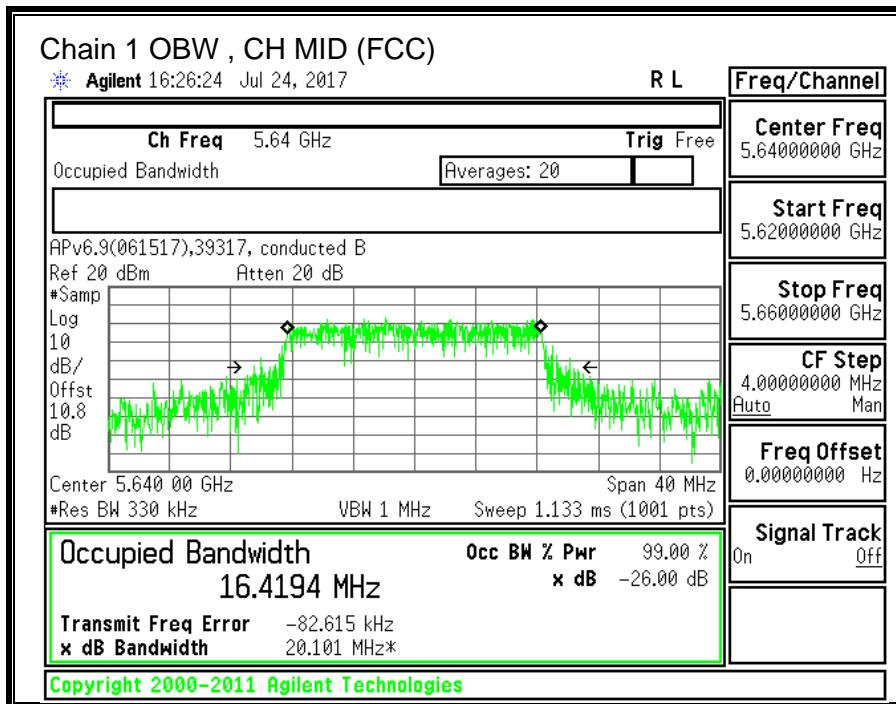
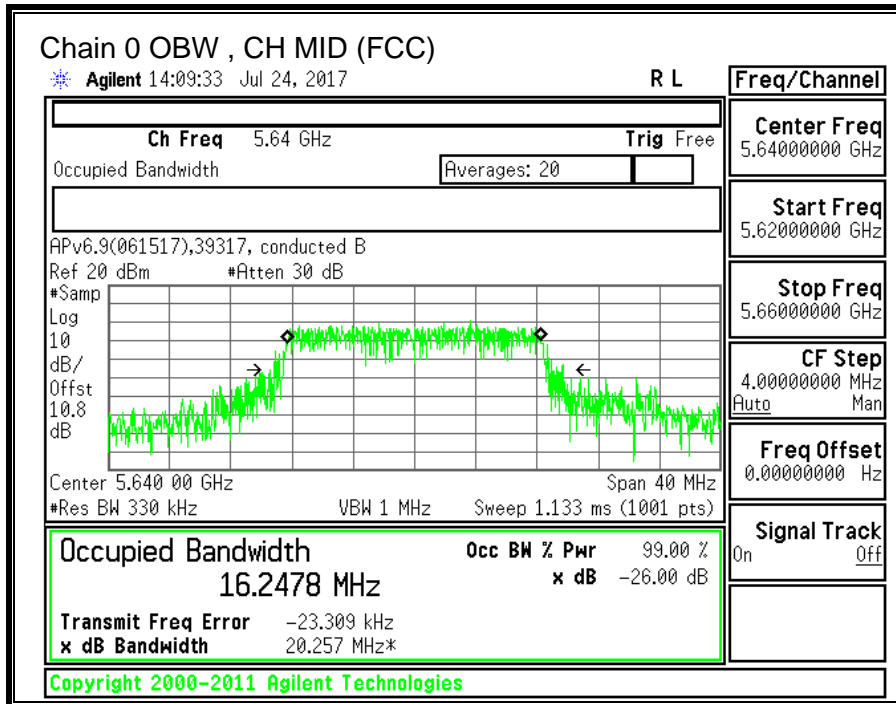

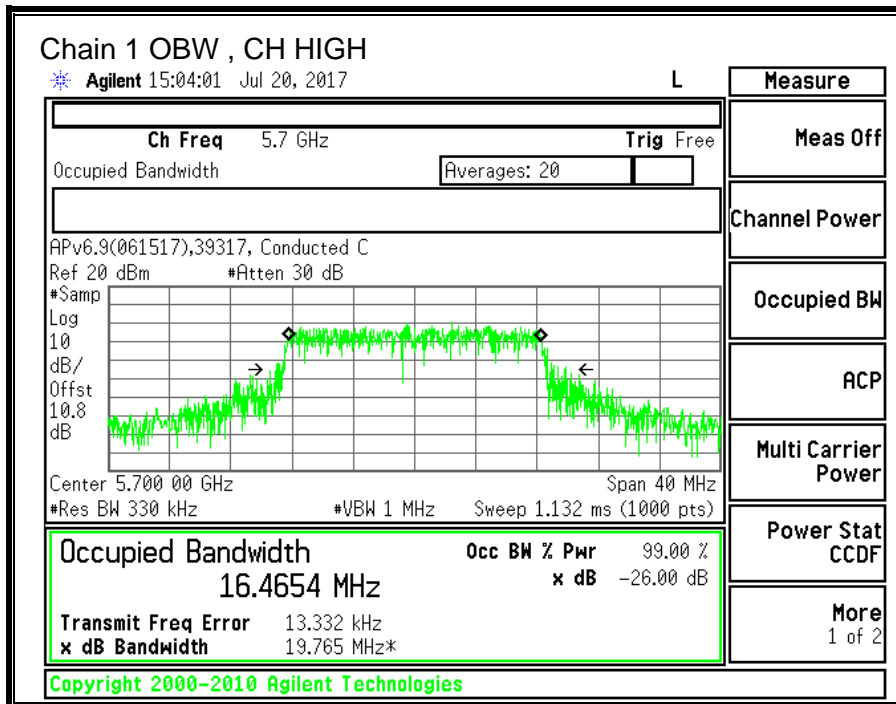
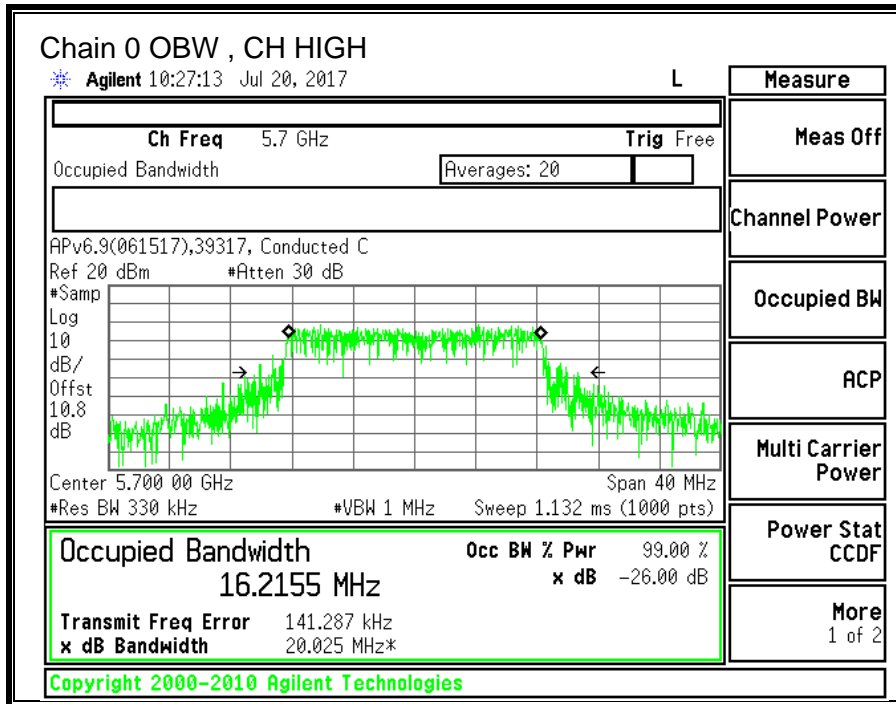

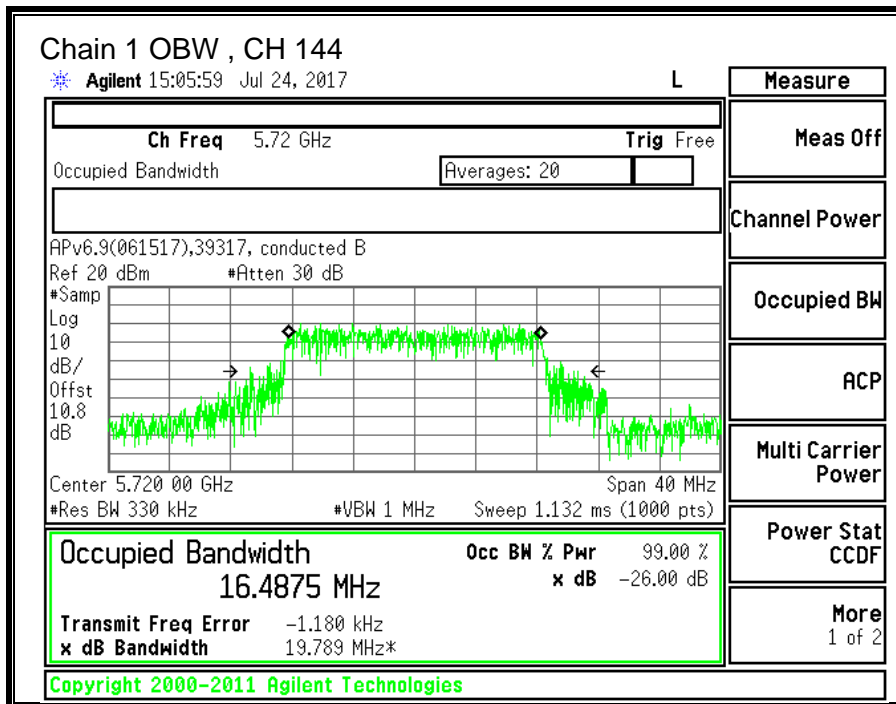
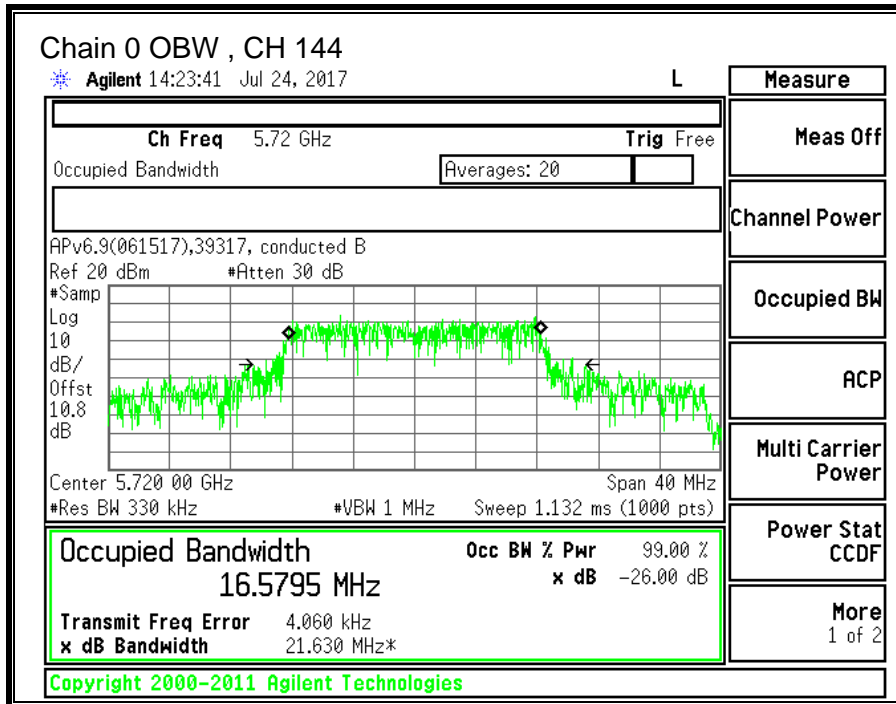

10.9.3. OUTPUT POWER AND PPSD

LIMITS

FCC §15.407 (a) (2)

For the band 5.47–5.725 GHz, the maximum conducted output power over the frequency band of operation shall not exceed the lesser of 250 mW or 11 dBm + 10 log B, where B is the 26–dB emission bandwidth in MHz. In addition, the maximum power spectral density shall not exceed 11 dBm in any 1–MHz band. If transmitting antennas of directional gain greater than 6 dBi are used, both the maximum conducted output power and the peak power spectral density shall be reduced by the amount in dB that the directional gain of the antenna exceeds 6 dBi.

TEST PROCEDURE

Measurements perform using a wideband gated RF power meter provided that the gate parameters are adjusted such that the power is measured only when the EUT is transmitting at its maximum power control level. Since the measurement is made only during the ON time of the transmitter, no duty cycle correction factor is required.

Straddle channel power is measured using PXA spectrum analyzer, duty cycle correction factor is required.

DIRECTIONAL ANTENNA GAIN

For power, the TX chains are uncorrelated and the antenna gain is unequal among the chains. The directional gain is:

5470-5725 MHz

Chain 0 Antenna Gain (dBi)	Chain 1 Antenna Gain (dBi)	Uncorrelated Chains Directional Gain (dBi)
-1.60	0.70	-0.30

For PSD the TX chains are correlated and the antenna gain is unequal among the chains. The directional gain is:

5470-5725 MHz

Chain 0 Antenna Gain (dBi)	Chain 1 Antenna Gain (dBi)	Correlated Chains Directional Gain (dBi)
-1.60	0.70	2.64

RESULTS

ID:	39317	Date:	07/21/17
------------	-------	--------------	----------

Bandwidth and Antenna Gain

Channel	Frequency (MHz)	Min 26 dB BW (MHz)	Min 99% BW (MHz)	Directional Gain for Power (dBi)	Directional Gain for PPSD (dBi)
Low	5500	22.00	16.06	-0.30	2.64
Mid	5580	22.35	16.06	-0.30	2.64
Mid (FCC)	5640	23.92	16.25	-0.30	2.64
High	5700	22.15	16.22	-0.30	2.64
144	5720	22.15	16.49	-0.30	2.64

Limits

Channel	Frequency (MHz)	FCC Power Limit (dBm)	IC Power Limit (dBm)	IC EIRP Limit (dBm)	Power Limit (dBm)	FCC PPSD Limit (dBm)	IC PSD Limit (dBm)	PPSD Limit (dBm)
Low	5500	24.00	23.06	29.06	23.06	11.00	11.00	11.00
Mid	5580	24.00	23.06	29.06	23.06	11.00	11.00	11.00
Mid (FCC)	5640	24.00	23.11	29.11	23.11	11.00	11.00	11.00
High	5700	24.00	23.10	29.10	23.10	11.00	11.00	11.00
144	5720	24.00	23.17	29.17	23.17	11.00	11.00	11.00

Duty Cycle CF (dB)	0.24	Included in Calculations of Corr'd PPSD
---------------------------	------	--

Output Power Results

Channel	Frequency (MHz)	Chain 0 Meas Power (dBm)	Chain 1 Meas Power (dBm)	Total Corr'd Power (dBm)	Power Limit (dBm)	Power Margin (dB)
Low	5500	12.91	13.81	16.39	23.06	-6.66
Mid	5580	12.76	13.58	16.20	23.06	-6.86
Mid (FCC)	5640	12.84	13.26	16.07	23.11	-7.04
High	5700	13.05	13.64	16.37	23.10	-6.74
144	5720	13.07	13.41	16.25	23.17	-6.92

PPSD Results

Channel	Frequency (MHz)	Chain 0 Meas PPSD (dBm)	Chain 1 Meas PPSD (dBm)	Total Corr'd PPSD (dBm)	PPSD Limit (dBm)	PPSD Margin (dB)
Low	5500	1.459	2.685	5.37	11.00	-5.63
Mid	5580	1.507	2.547	5.31	11.00	-5.69
Mid (FCC)	5640	1.765	2.350	5.32	11.00	-5.68
High	5700	1.719	2.427	5.34	11.00	-5.66
144	5720	1.988	2.606	5.56	11.00	-5.44

Note: the power readings above were measured with gated method, and the measurement was taken only during the ON time. No duty cycle correction was necessary.

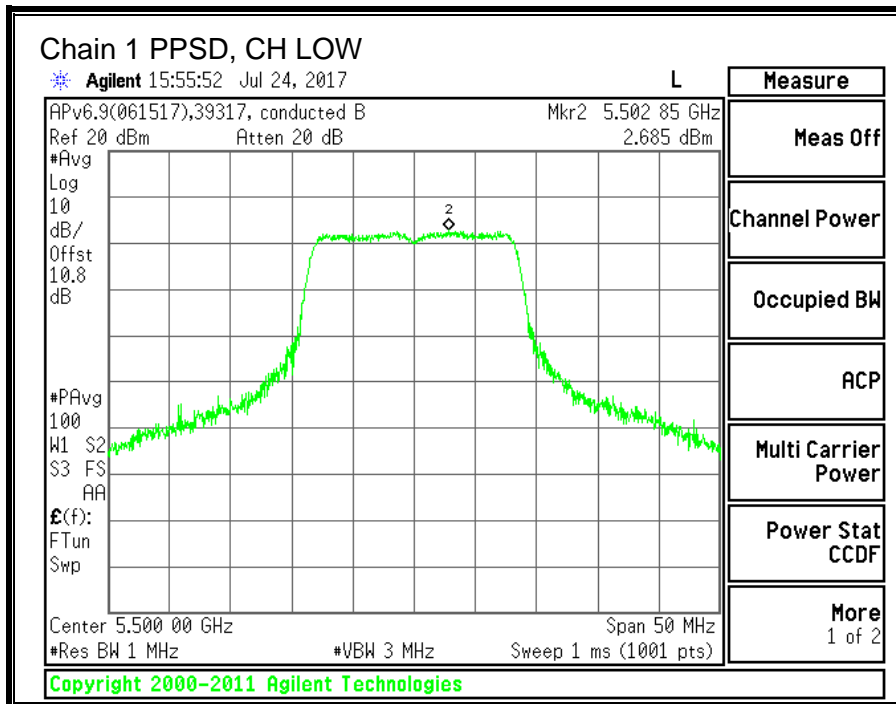
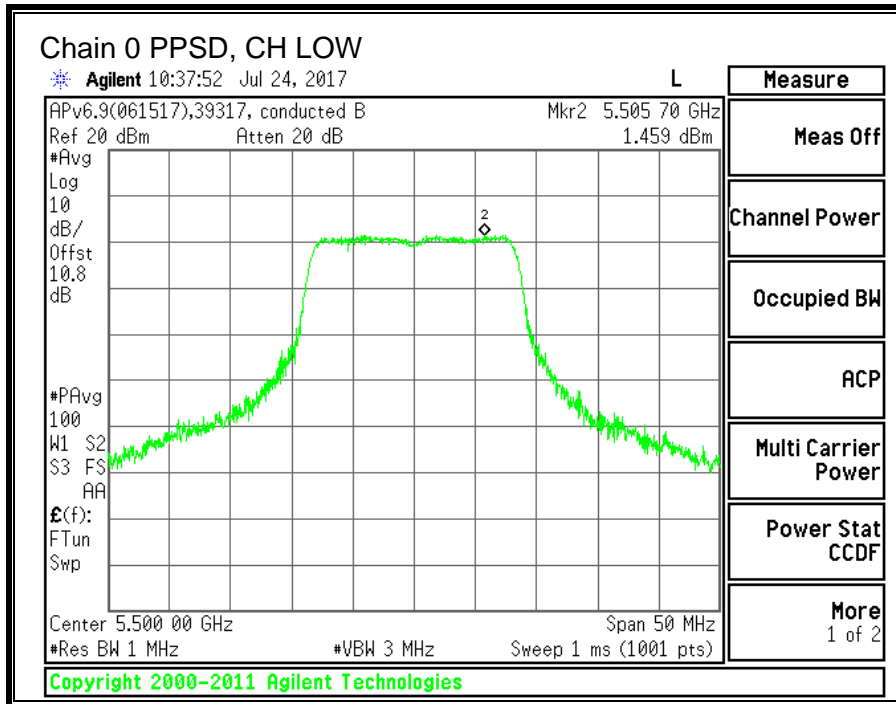

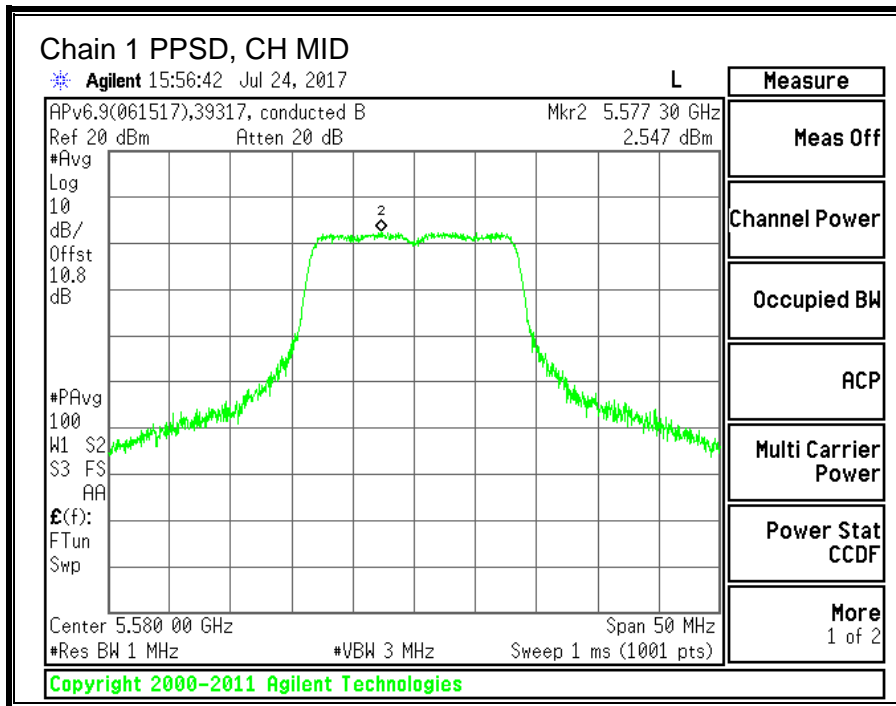
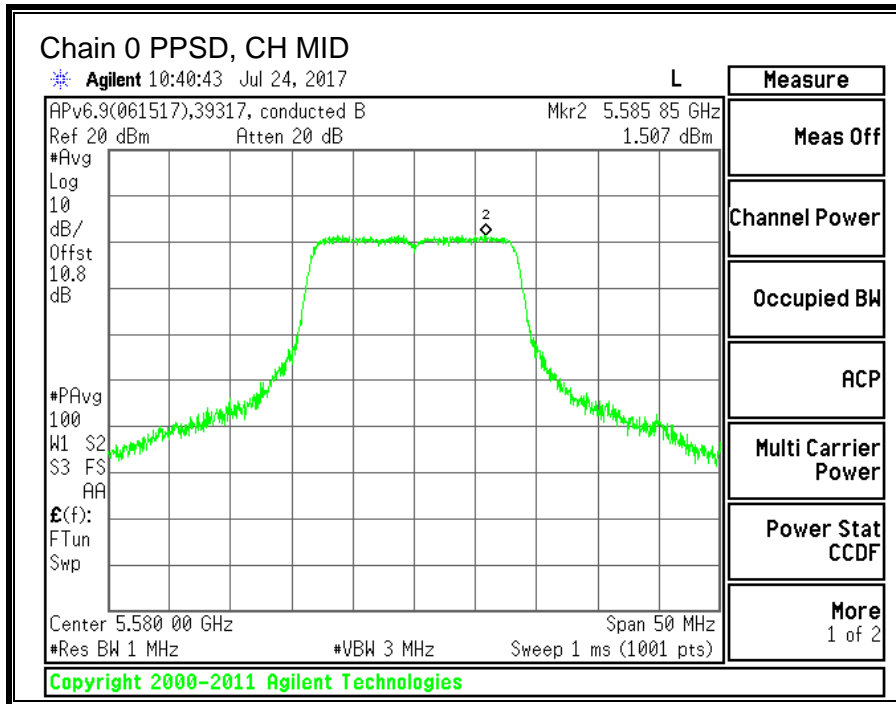

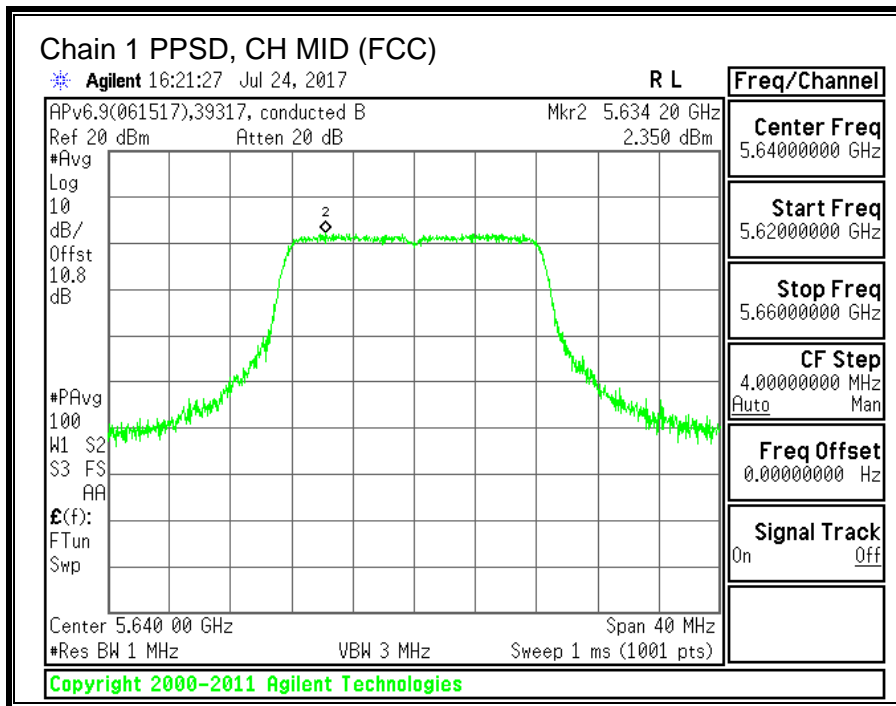
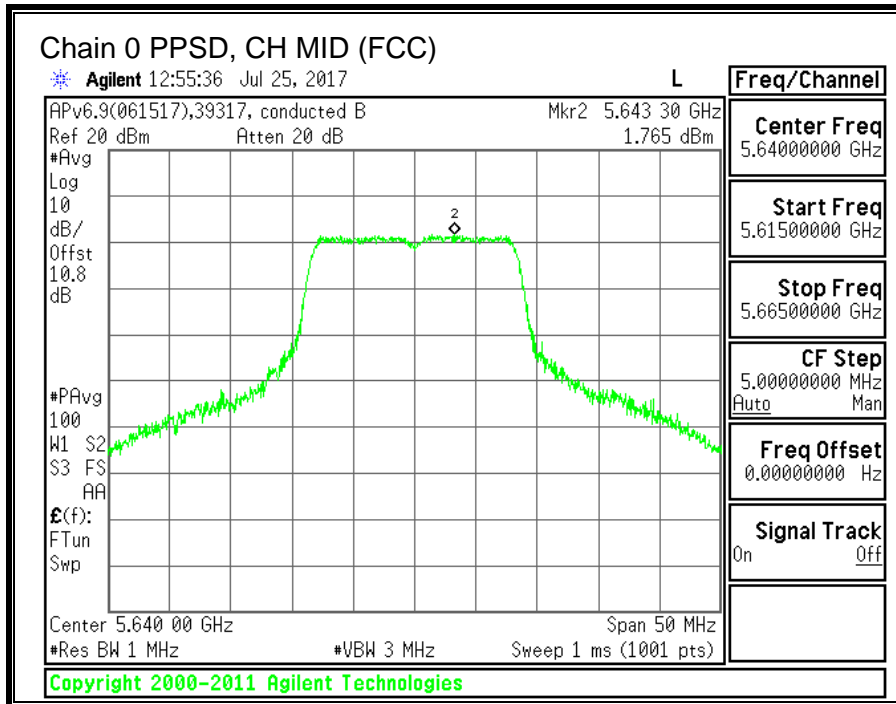

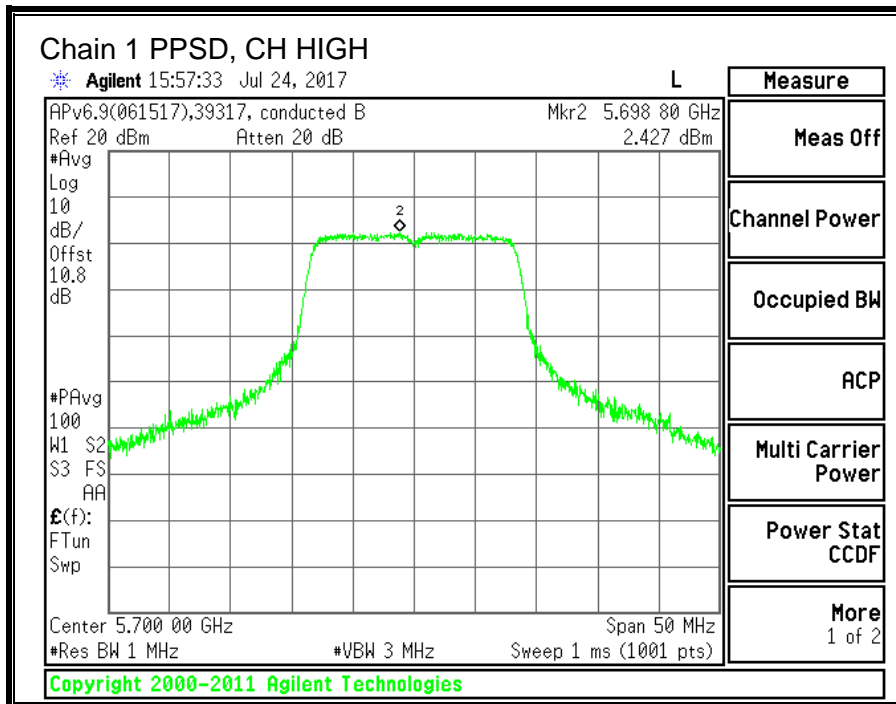
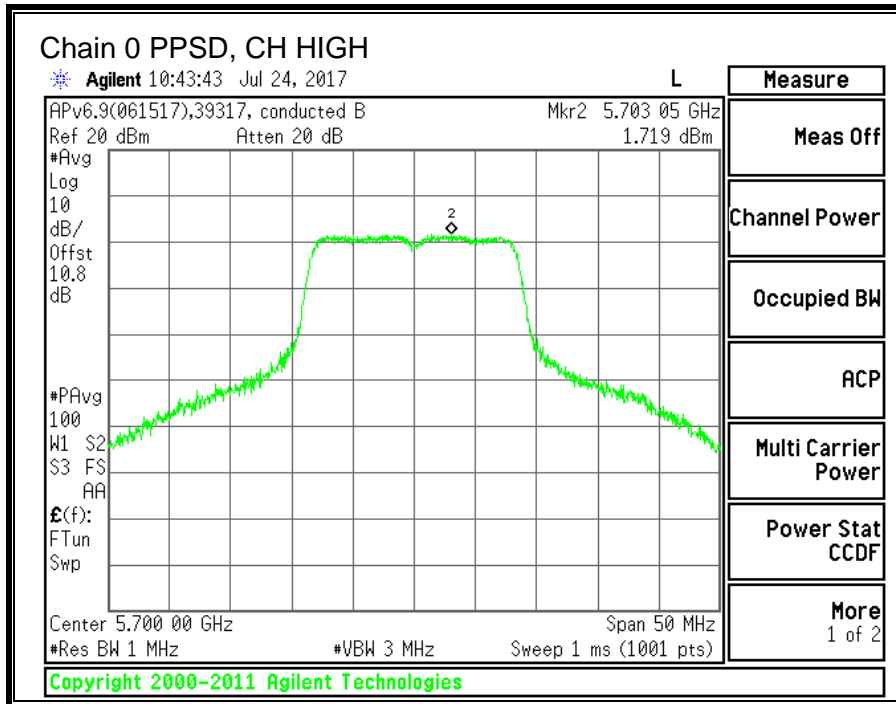

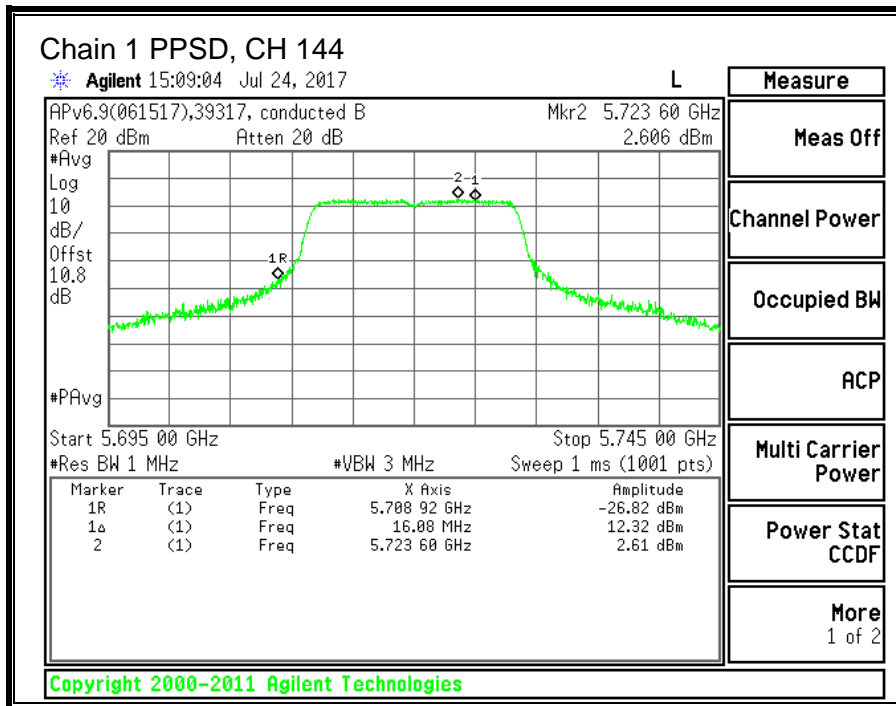
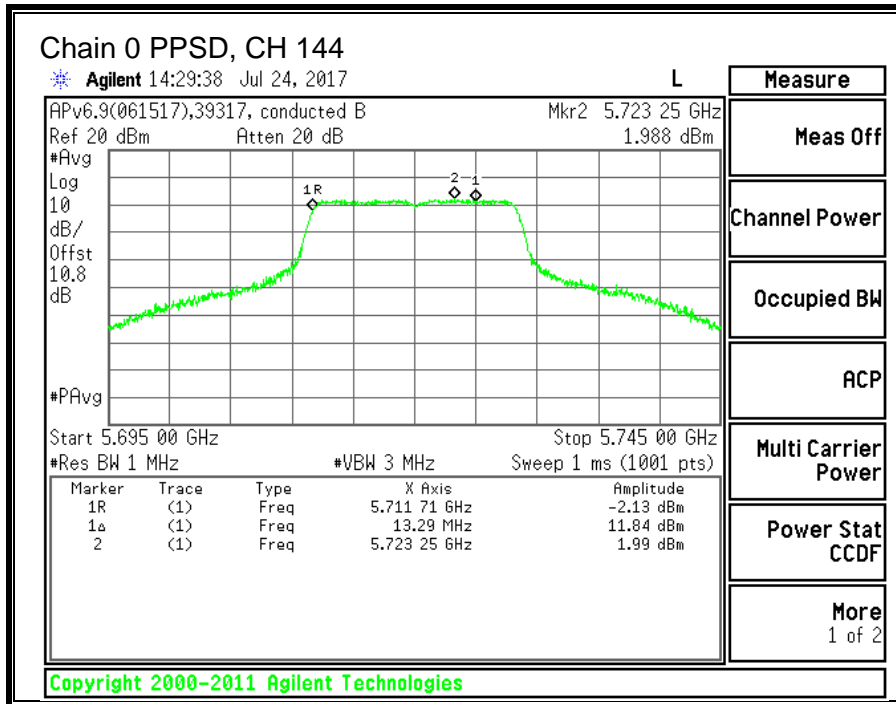

10.10. 11n HT20 2TX CDD MIMO MODE IN THE 5.6GHz BAND

10.10.1.26 dB BANDWIDTH

LIMITS

None; for reporting purposes only.

RESULTS

Channel	Frequency	26 dB BW Chain 0 (MHz)	26 dB BW Chain 1 (MHz)
Low	5500	25.30	23.00
Mid	5580	24.50	23.05
Mid (FCC)	5640	24.00	31.00
High	5700	24.90	23.05
144	5720	25.25	22.80

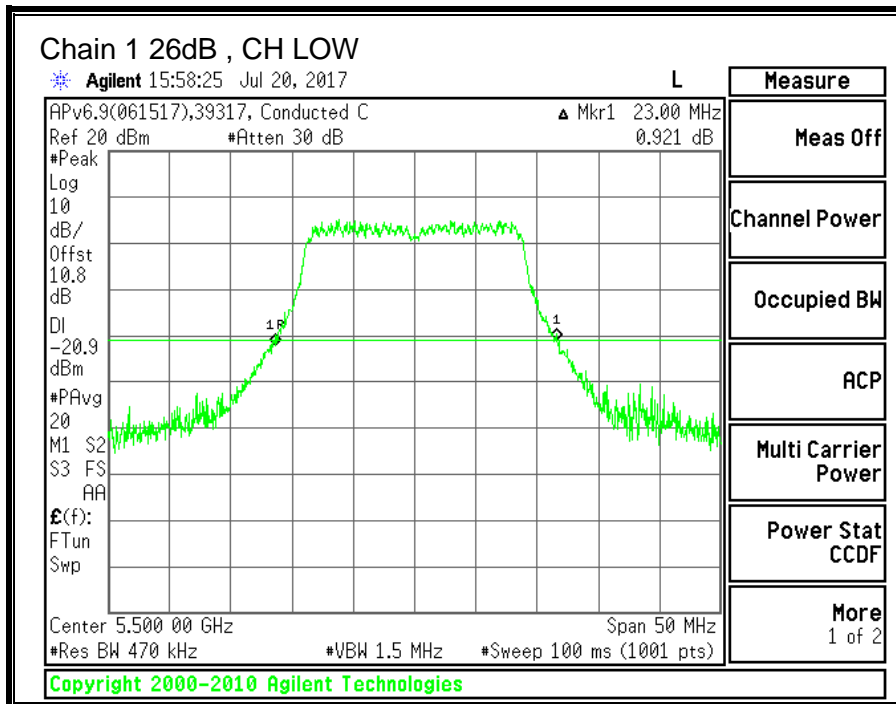
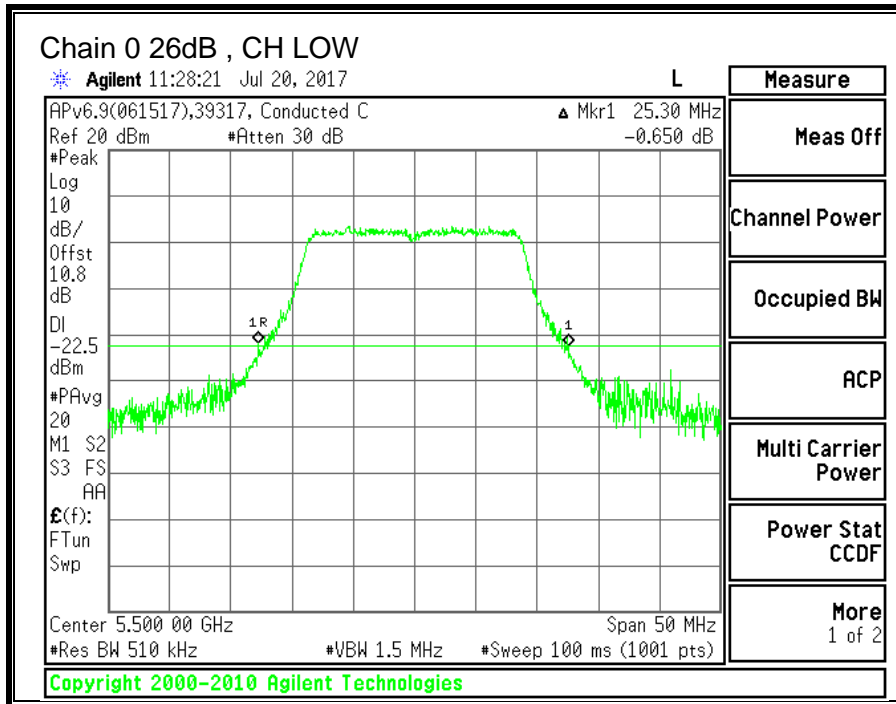

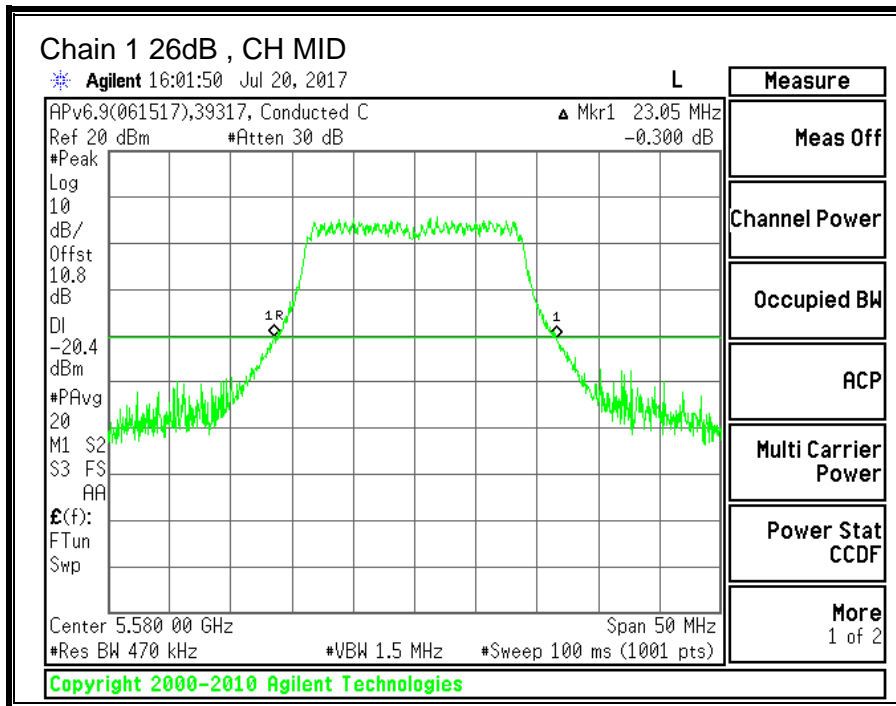
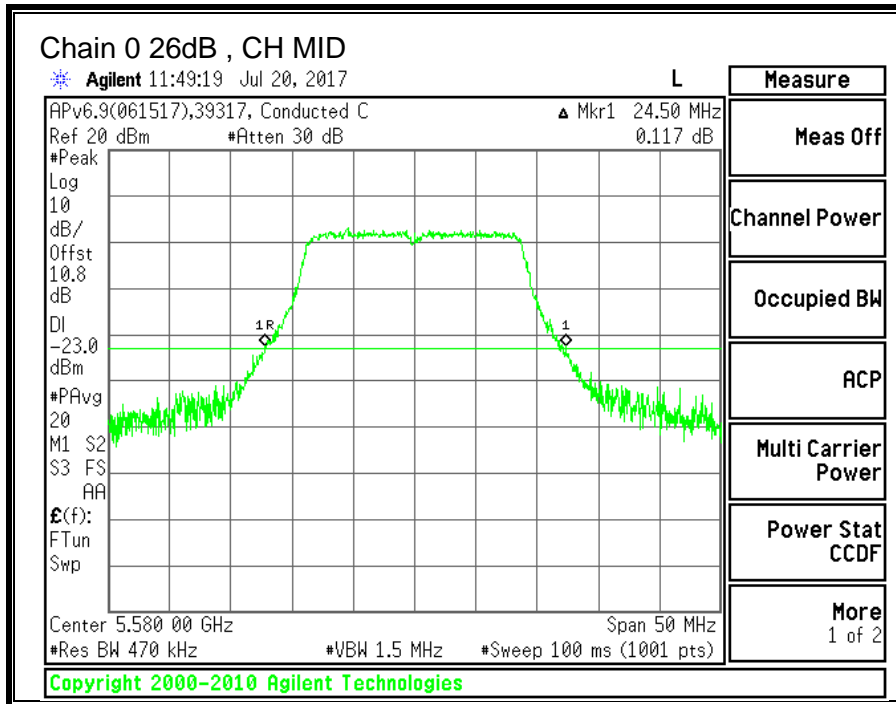

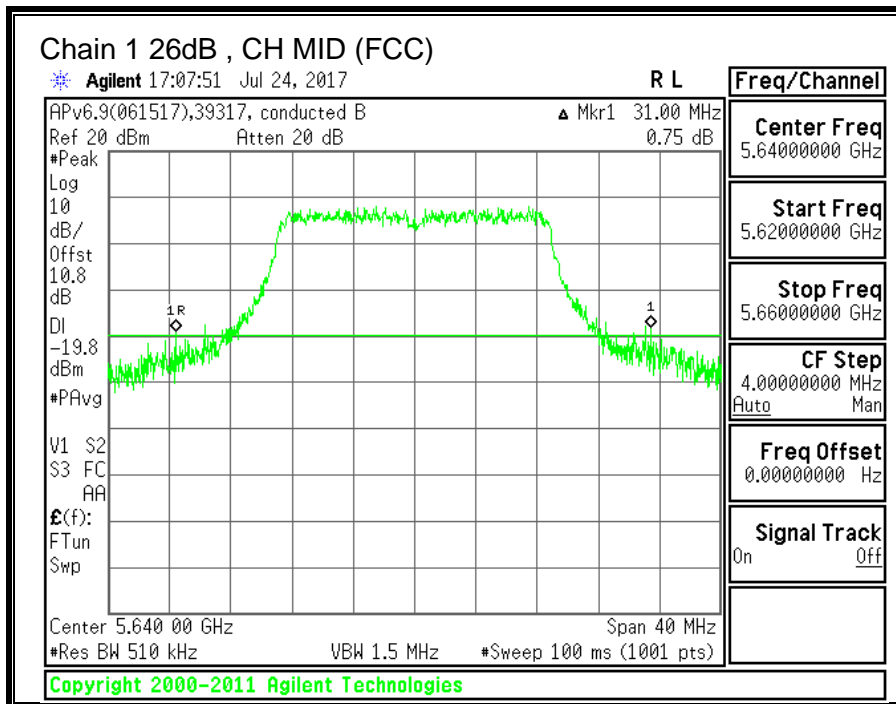
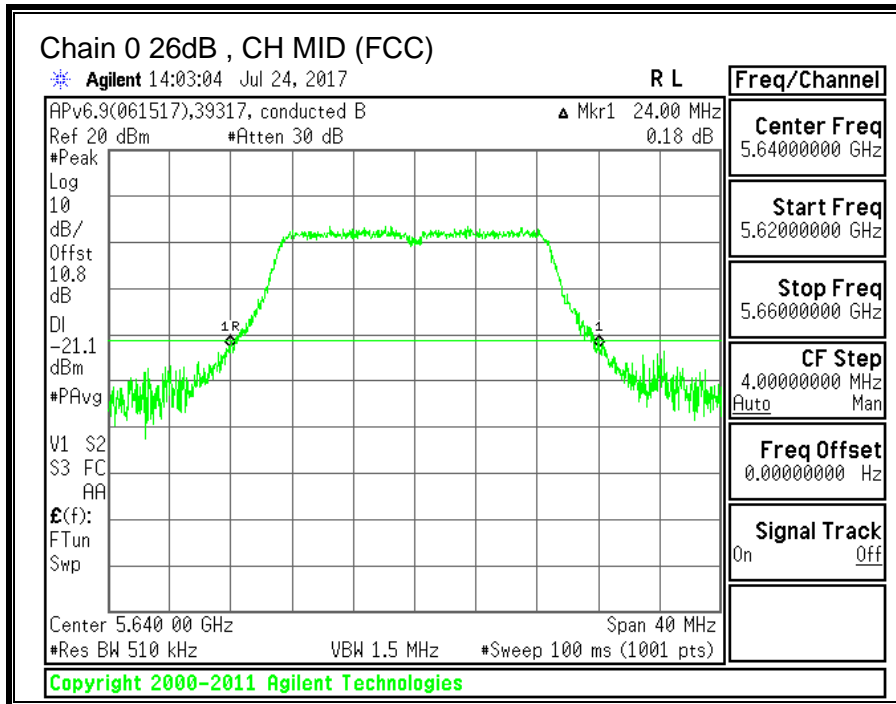

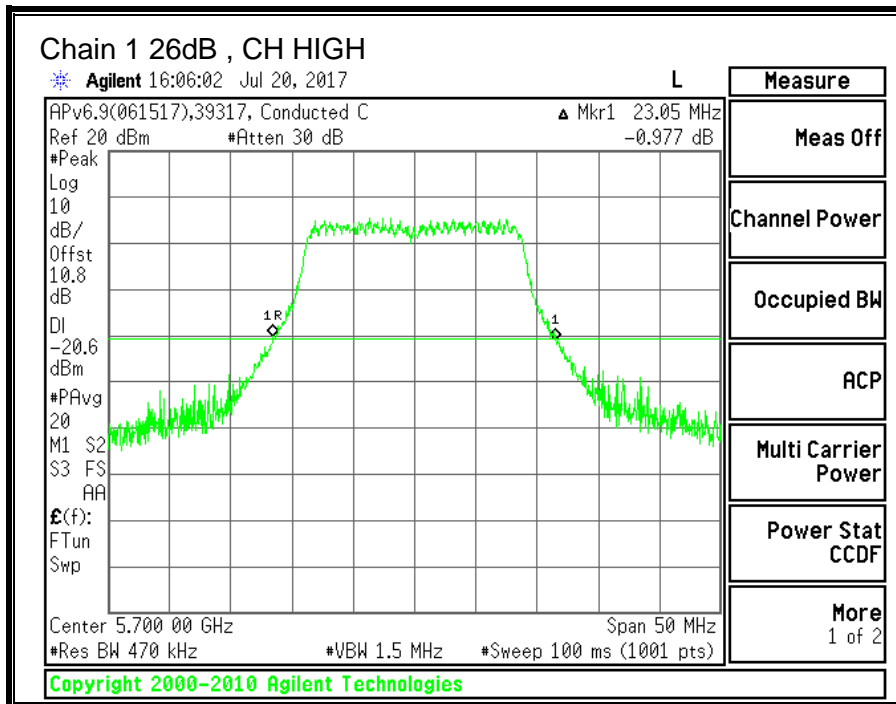
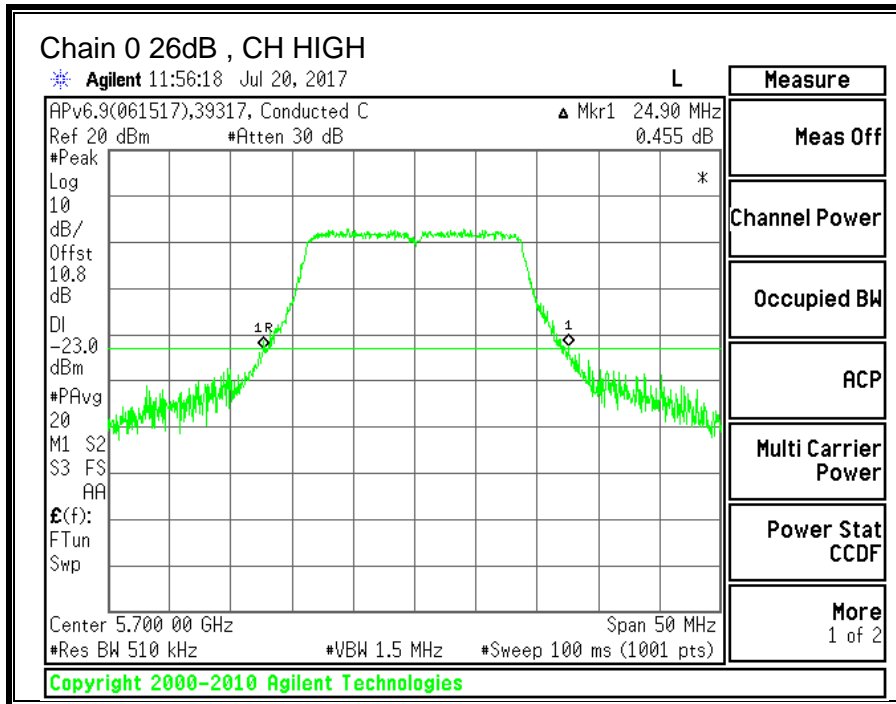

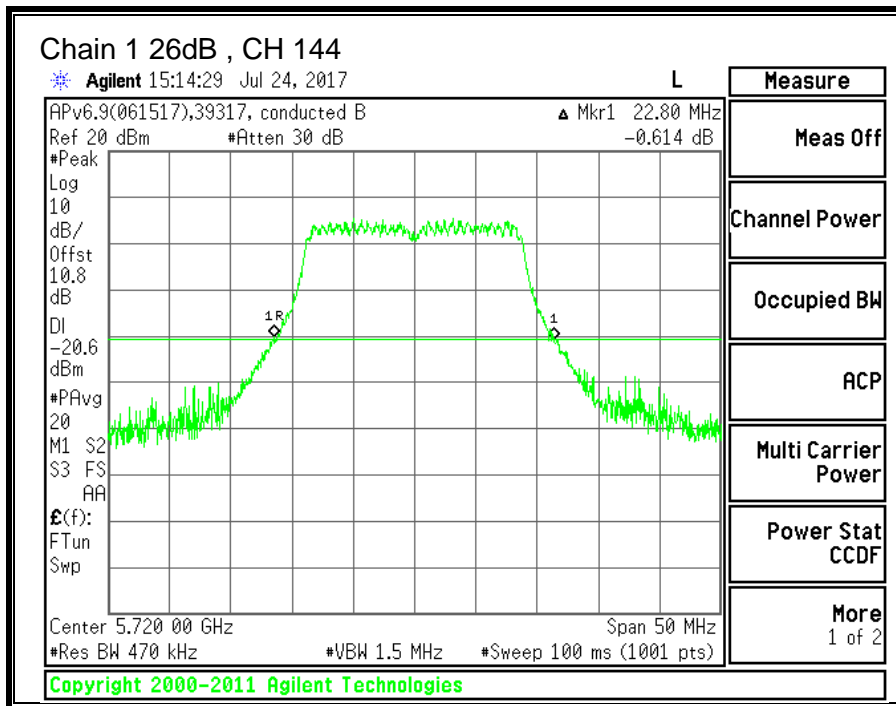
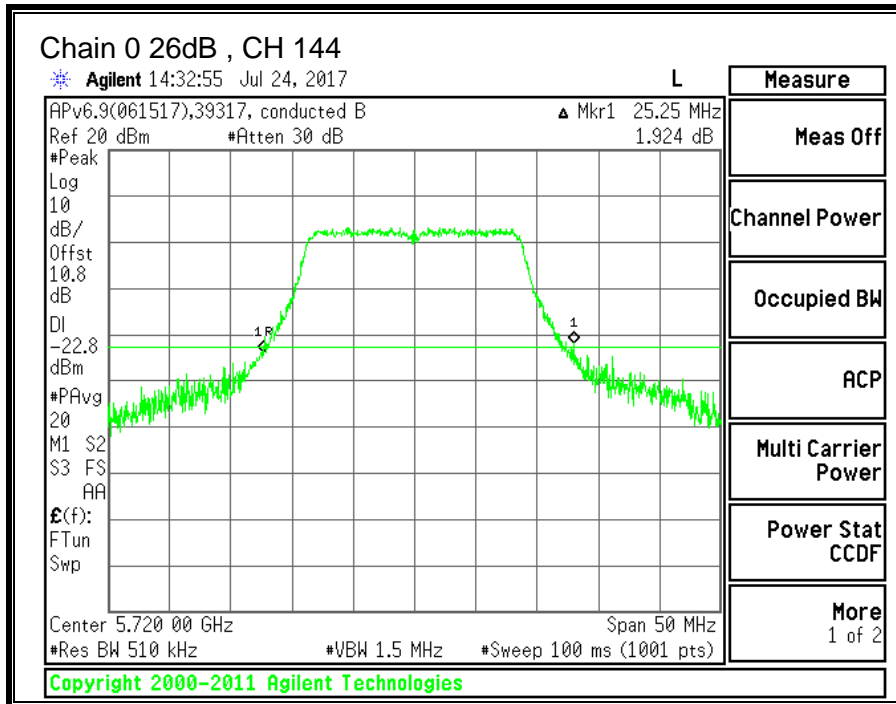

10.10.2. 99% BANDWIDTH

LIMITS

None; for reporting purposes only.

RESULTS

Channel	Frequency	99% BW Chain 0 (MHz)	99% BW Chain 1 (MHz)
Low	5500	17.5096	17.6731
Mid	5580	17.3031	17.5151
Mid (FCC)	5640	17.7478	17.4378
High	5700	17.7563	17.6119
144	5720	17.7153	17.6693

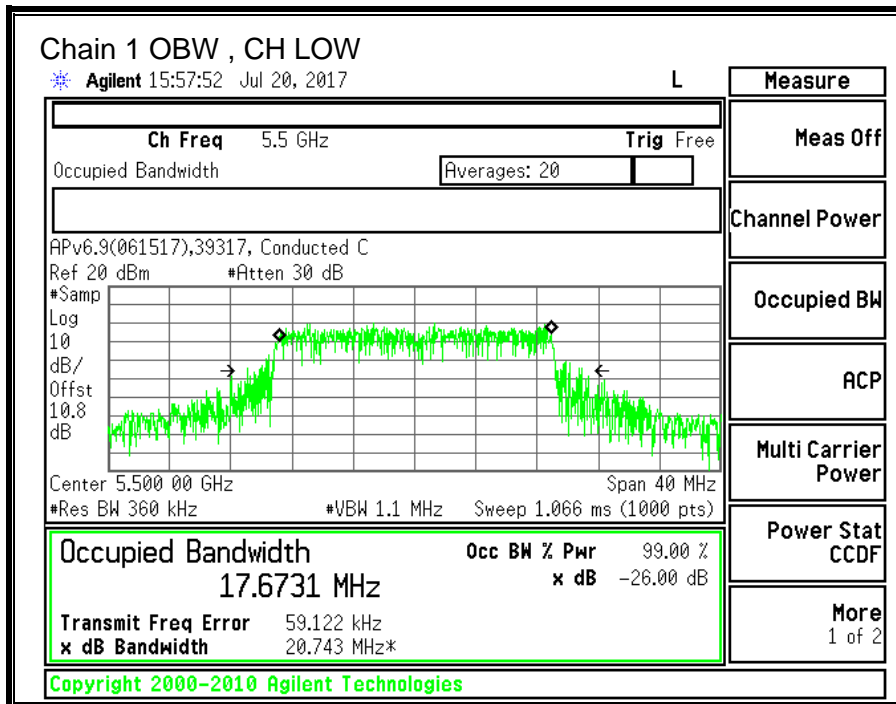
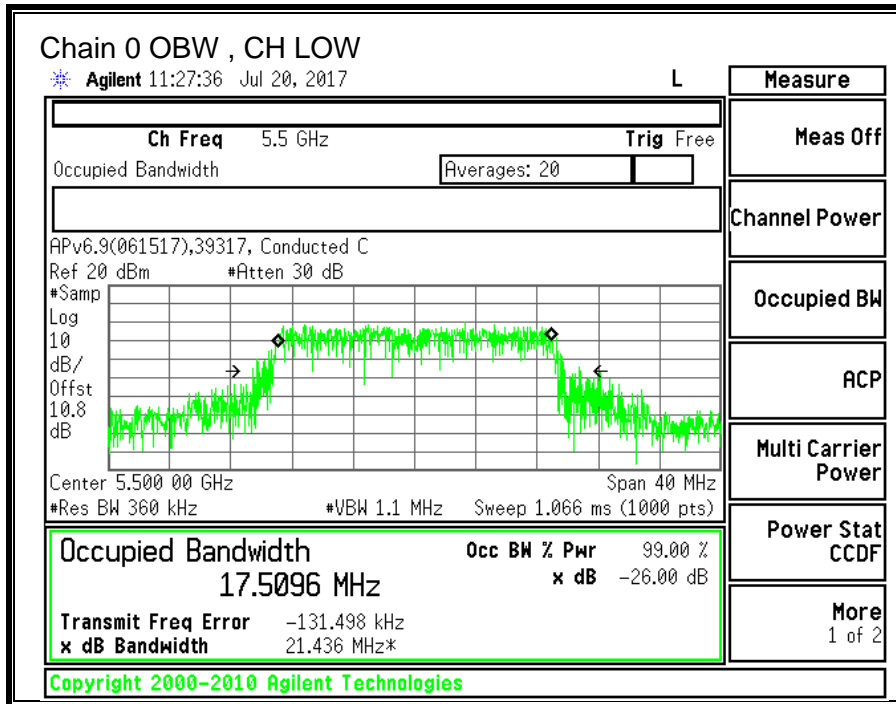

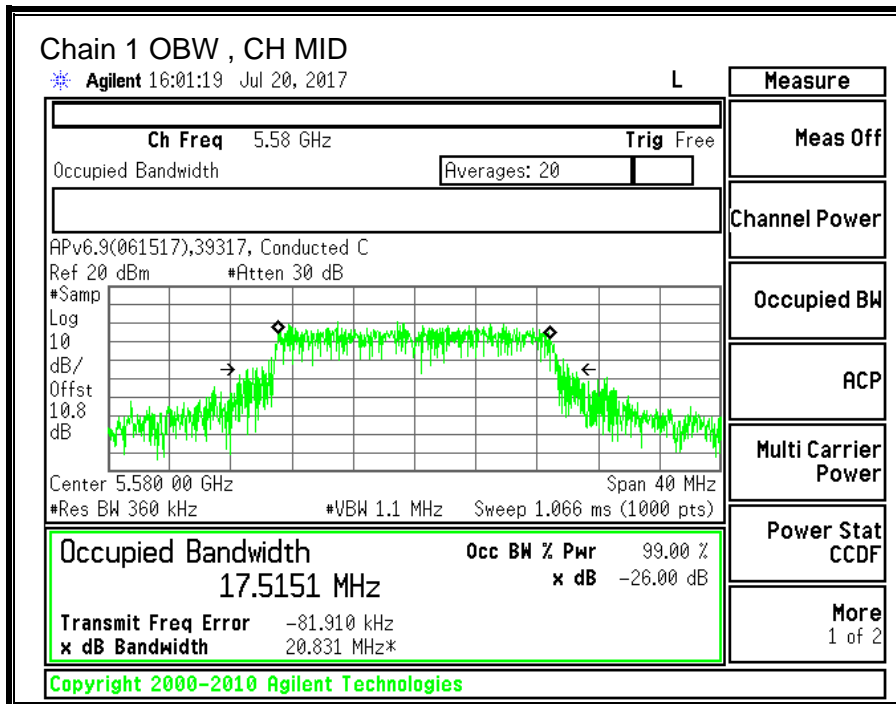
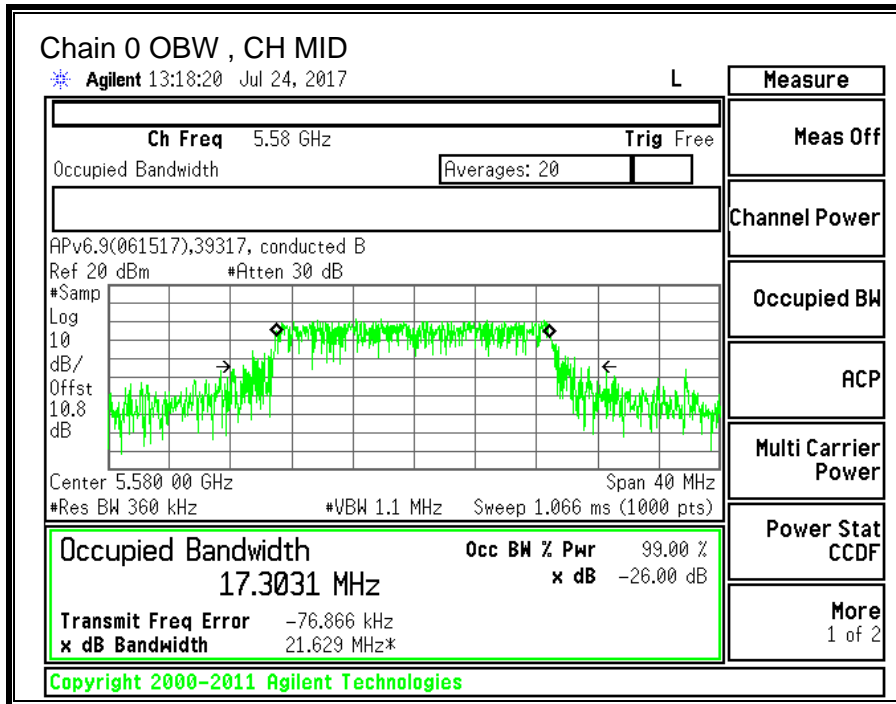

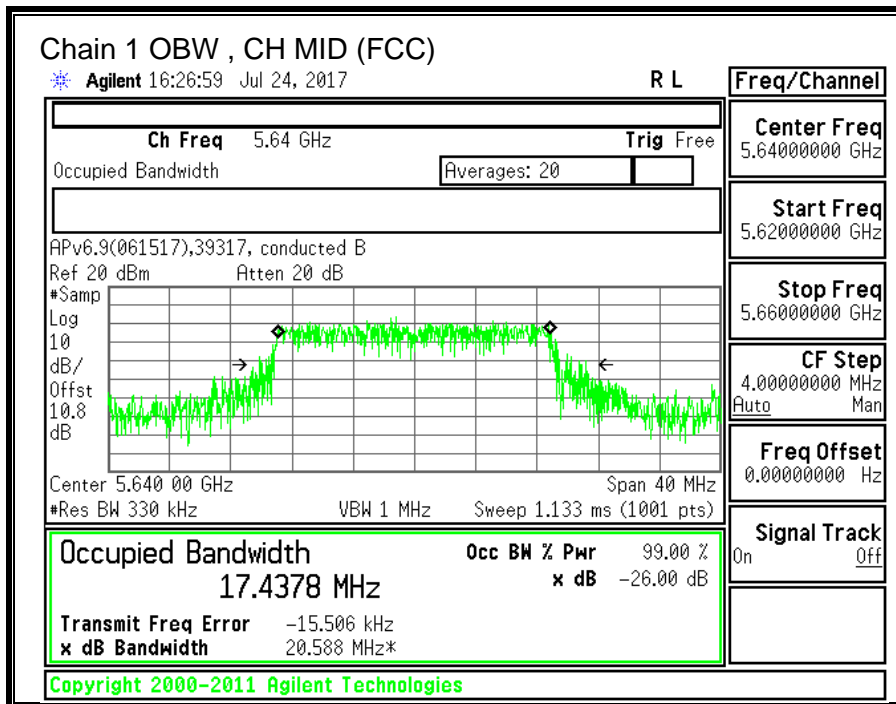
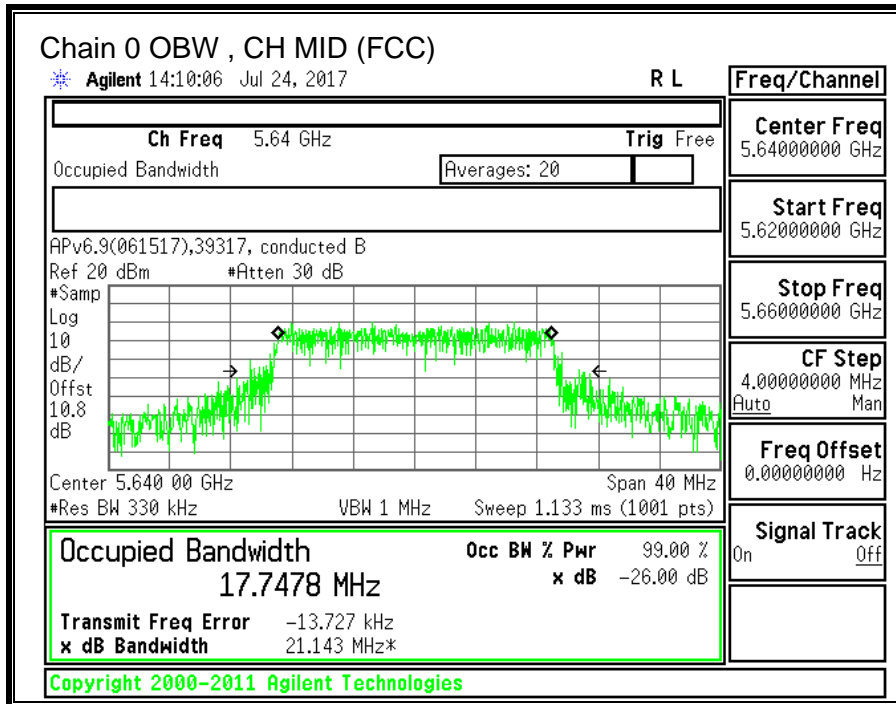

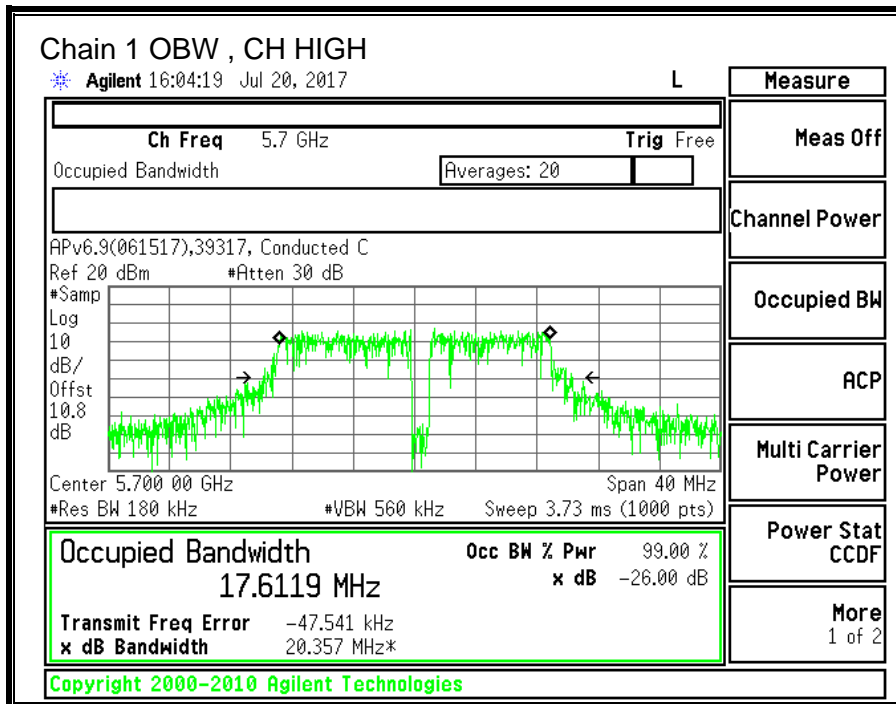
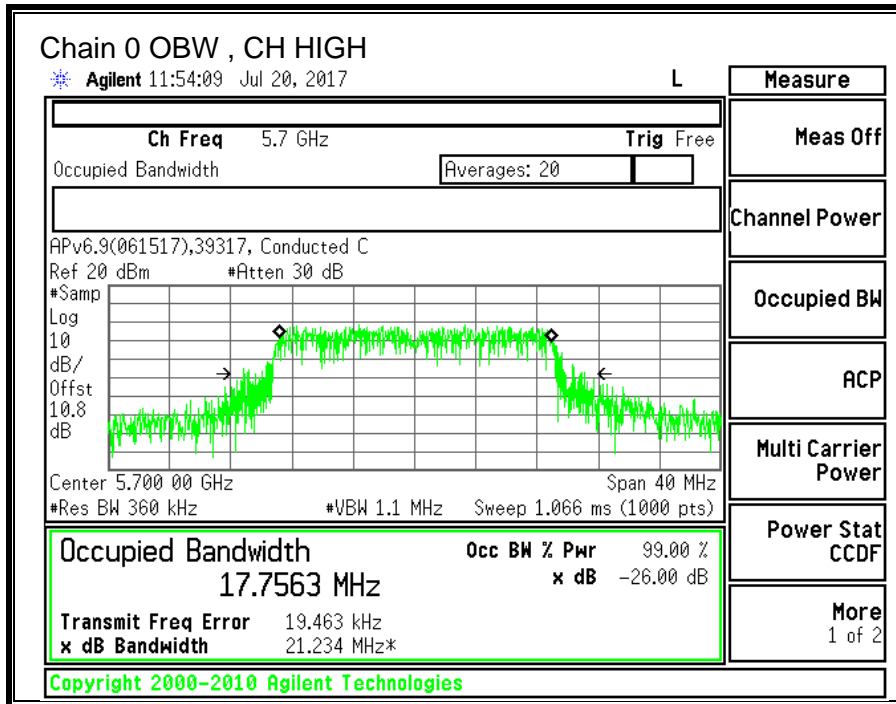

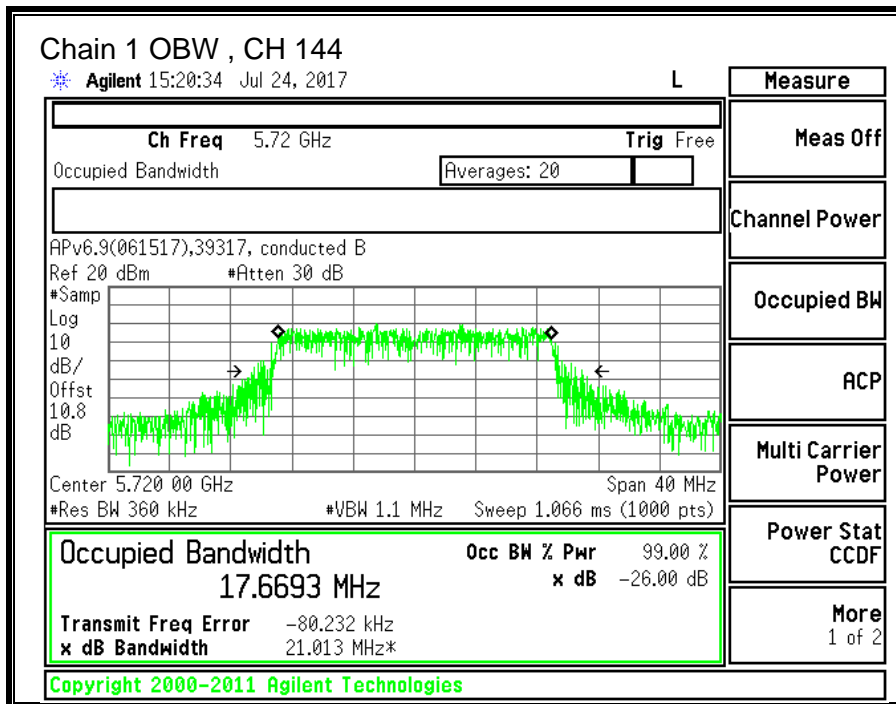
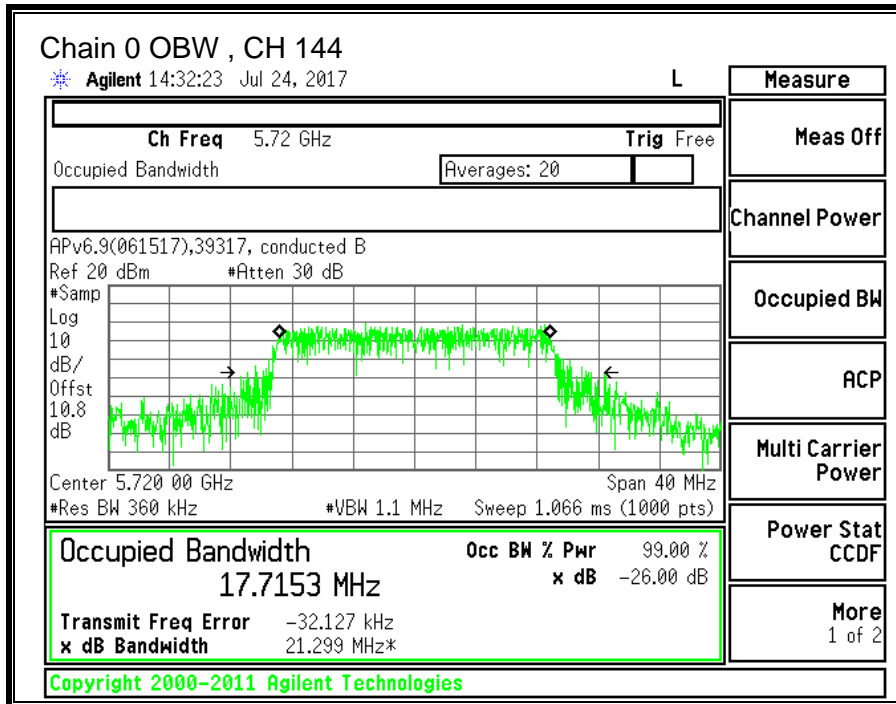

10.10.3. OUTPUT POWER AND PPSD

LIMITS

FCC §15.407 (a) (2)

For the band 5.47–5.725 GHz, the maximum conducted output power over the frequency band of operation shall not exceed the lesser of 250 mW or 11 dBm + 10 log B, where B is the 26–dB emission bandwidth in MHz. In addition, the maximum power spectral density shall not exceed 11 dBm in any 1–MHz band. If transmitting antennas of directional gain greater than 6 dBi are used, both the maximum conducted output power and the peak power spectral density shall be reduced by the amount in dB that the directional gain of the antenna exceeds 6 dBi.

TEST PROCEDURE

Measurements perform using a wideband gated RF power meter provided that the gate parameters are adjusted such that the power is measured only when the EUT is transmitting at its maximum power control level. Since the measurement is made only during the ON time of the transmitter, no duty cycle correction factor is required.

Straddle channel power is measured using PXA spectrum analyzer, duty cycle correction factor is required.

DIRECTIONAL ANTENNA GAIN

For power, the TX chains are uncorrelated and the antenna gain is unequal among the chains. The directional gain is:

5470-5725 MHz

Chain 0 Antenna Gain (dBi)	Chain 1 Antenna Gain (dBi)	Uncorrelated Chains Directional Gain (dBi)
-1.60	0.70	-0.30

For PSD the TX chains are correlated and the antenna gain is unequal among the chains. The directional gain is:

5470-5725 MHz

Chain 0 Antenna Gain (dBi)	Chain 1 Antenna Gain (dBi)	Correlated Chains Directional Gain (dBi)
-1.60	0.70	2.64

RESULTS

ID:	39317	Date:	07/21/17
------------	-------	--------------	----------

Bandwidth and Antenna Gain

Channel	Frequency (MHz)	Min 26 dB BW (MHz)	Min 99% BW (MHz)	Directional Gain for Power (dBi)	Directional Gain for PPSD (dBi)
Low	5500	23.00	17.51	-0.30	2.64
Mid	5580	23.05	17.30	-0.30	2.64
Mid (FCC)	5640	24.00	17.44	-0.30	2.64
High	5700	23.05	17.61	-0.30	2.64
144	5720	22.80	17.67	-0.30	2.64

Limits

Channel	Frequency (MHz)	FCC Power Limit (dBm)	IC Power Limit (dBm)	IC EIRP Limit (dBm)	Power Limit (dBm)	FCC PPSD Limit (dBm)	IC PSD Limit (dBm)	PPSD Limit (dBm)
Low	5500	24.00	23.43	29.43	23.43	11.00	11.00	11.00
Mid	5580	24.00	23.38	29.38	23.38	11.00	11.00	11.00
Mid (FCC)	5640	24.00	23.42	29.42	23.42	11.00	11.00	11.00
High	5700	24.00	23.46	29.46	23.46	11.00	11.00	11.00
144	5720	24.00	23.47	29.47	23.47	11.00	11.00	11.00

Duty Cycle CF (dB)	0.19	Included in Calculations of Corr'd PPSD
---------------------------	------	--

Output Power Results

Channel	Frequency (MHz)	Chain 0 Meas Power (dBm)	Chain 1 Meas Power (dBm)	Total Corr'd Power (dBm)	Power Limit (dBm)	Power Margin (dB)
Low	5500	12.91	13.44	16.19	23.43	-7.24
Mid	5580	12.83	13.57	16.23	23.38	-7.15
Mid (FCC)	5640	12.89	13.25	16.08	23.42	-7.33
High	5700	13.07	13.62	16.36	23.46	-7.09
144	5720	12.97	13.45	16.23	23.47	-7.25

PPSD Results

Channel	Frequency (MHz)	Chain 0 Meas PPSD (dBm)	Chain 1 Meas PPSD (dBm)	Total Corr'd PPSD (dBm)	PPSD Limit (dBm)	PPSD Margin (dB)
Low	5500	1.154	2.094	4.85	11.00	-6.15
Mid	5580	1.106	2.259	4.92	11.00	-6.08
Mid (FCC)	5640	1.301	1.886	4.80	11.00	-6.20
High	5700	1.607	2.288	5.16	11.00	-5.84
144	5720	1.080	2.114	4.83	11.00	-6.17

Note: the power readings above were measured with gated method, and the measurement was taken only during the ON time. No duty cycle correction was necessary.

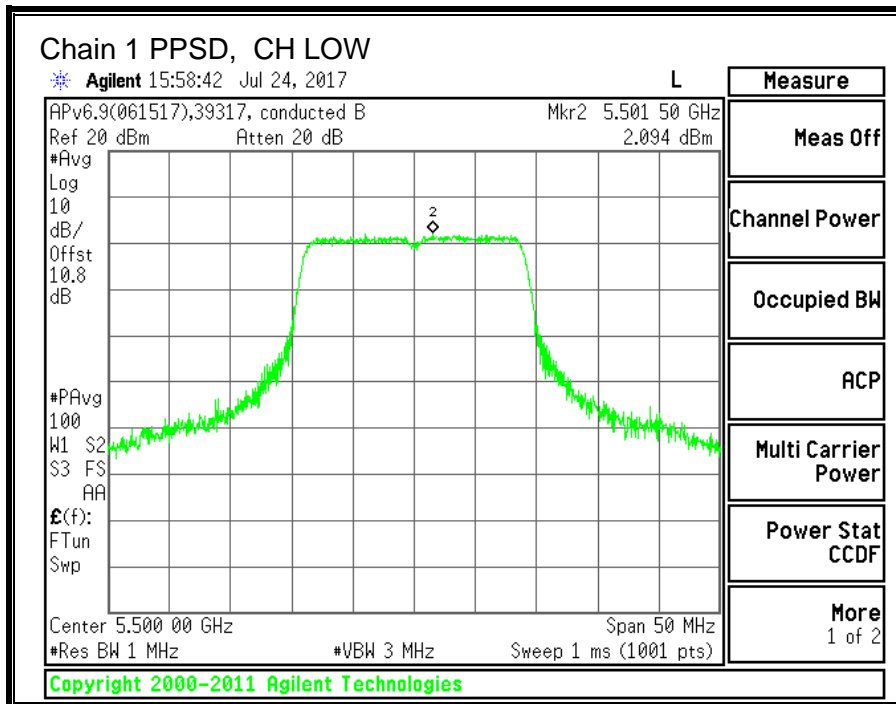
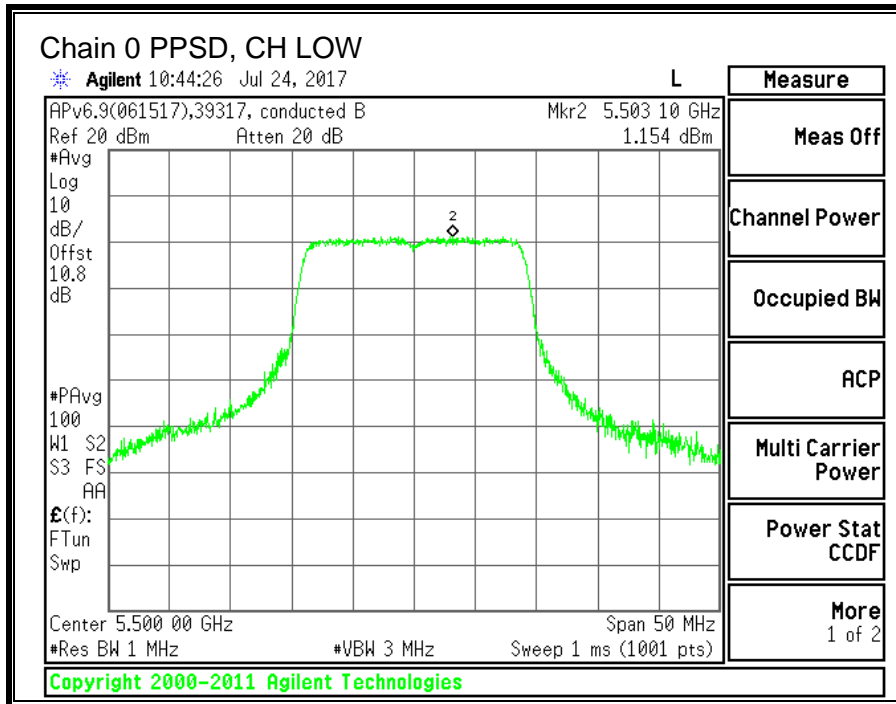

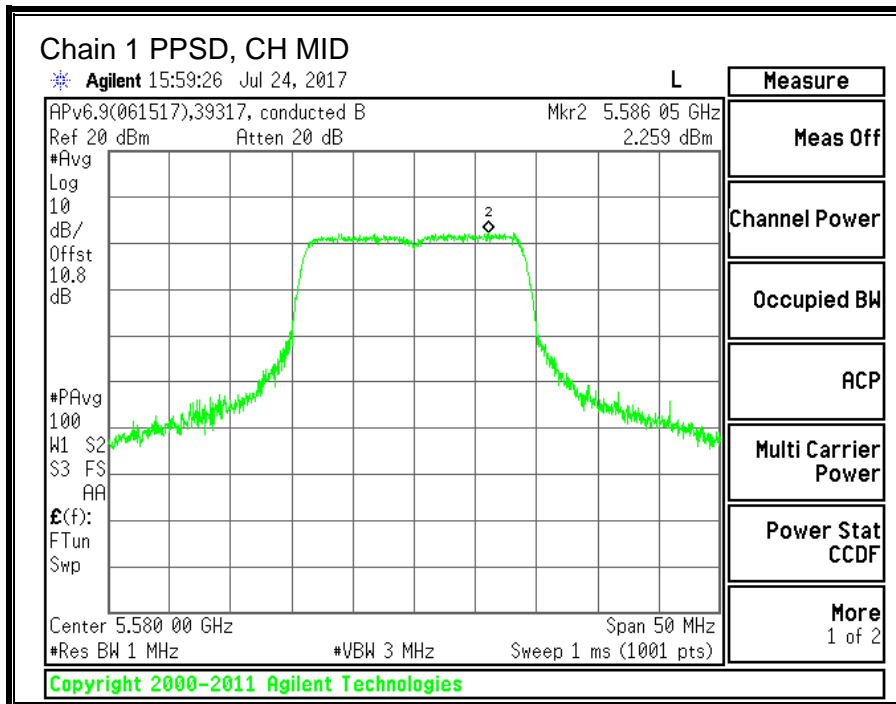
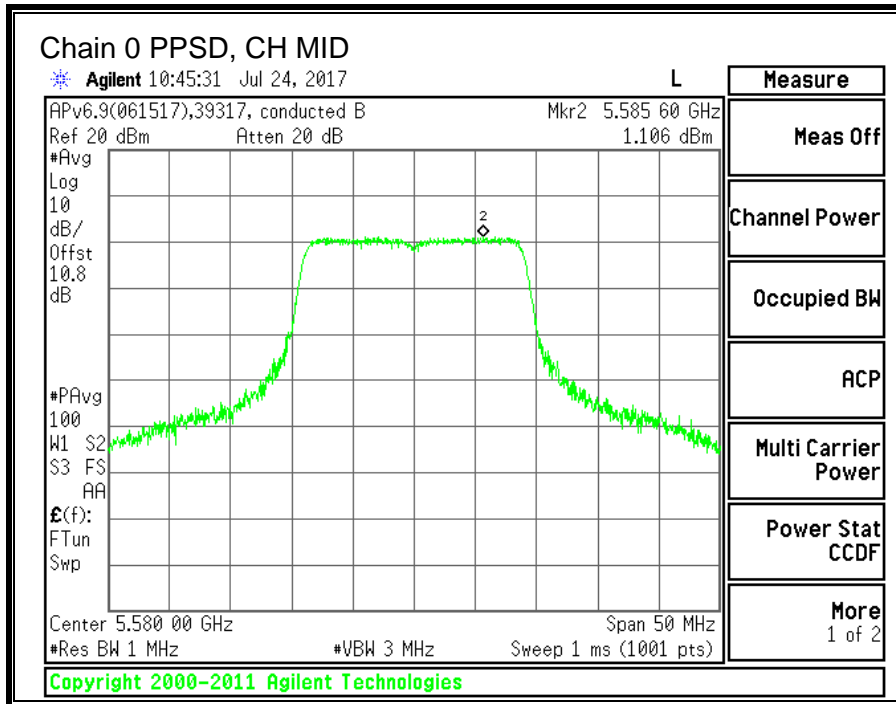

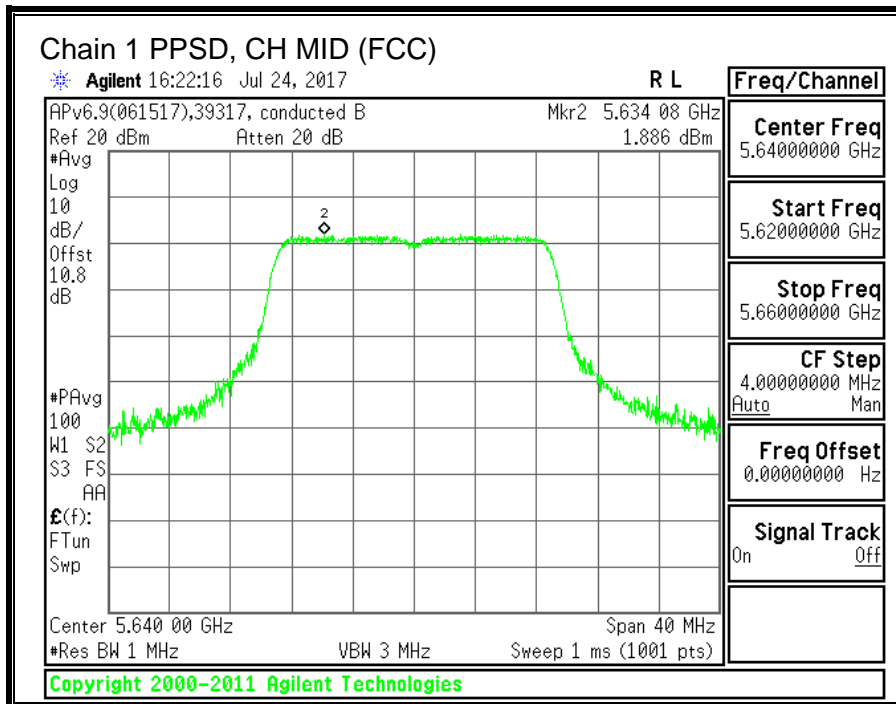
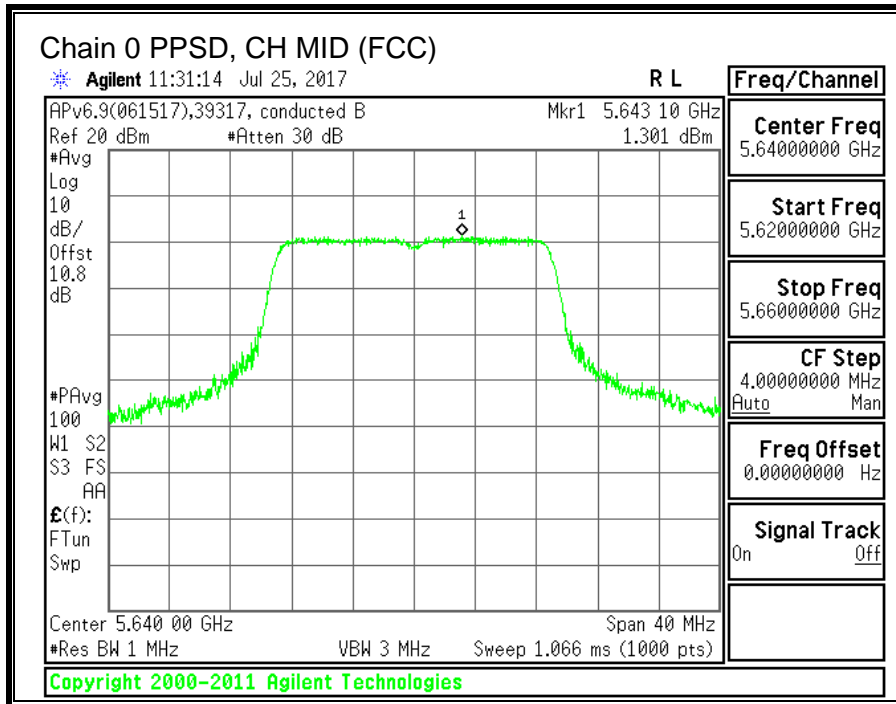

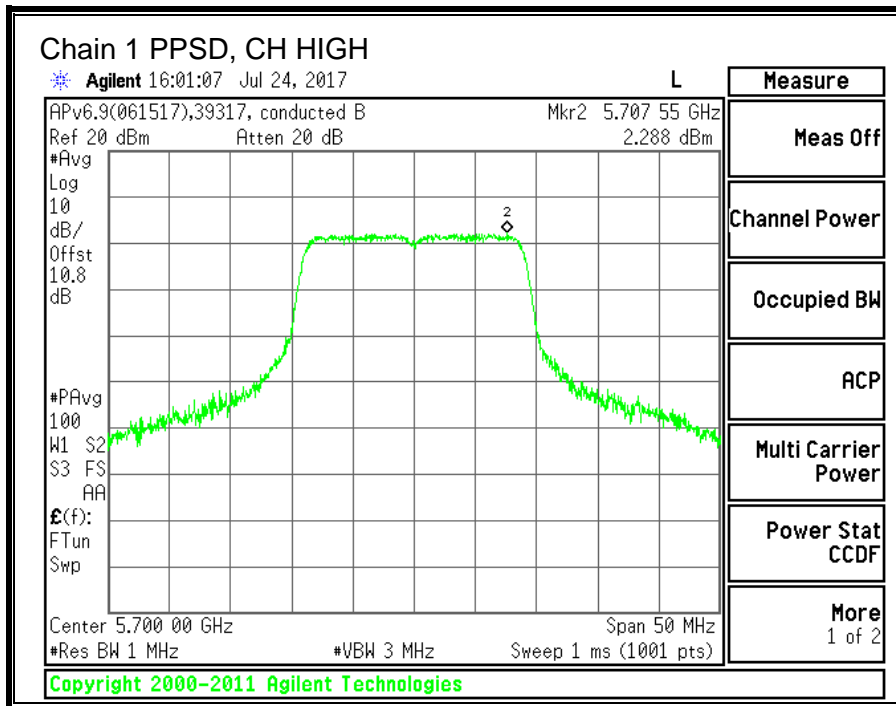
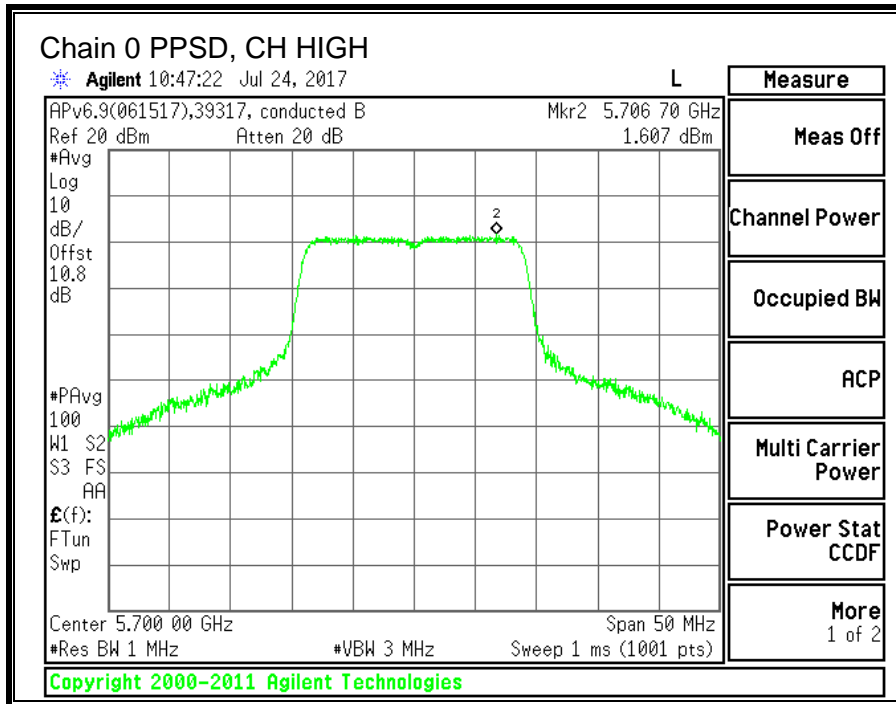

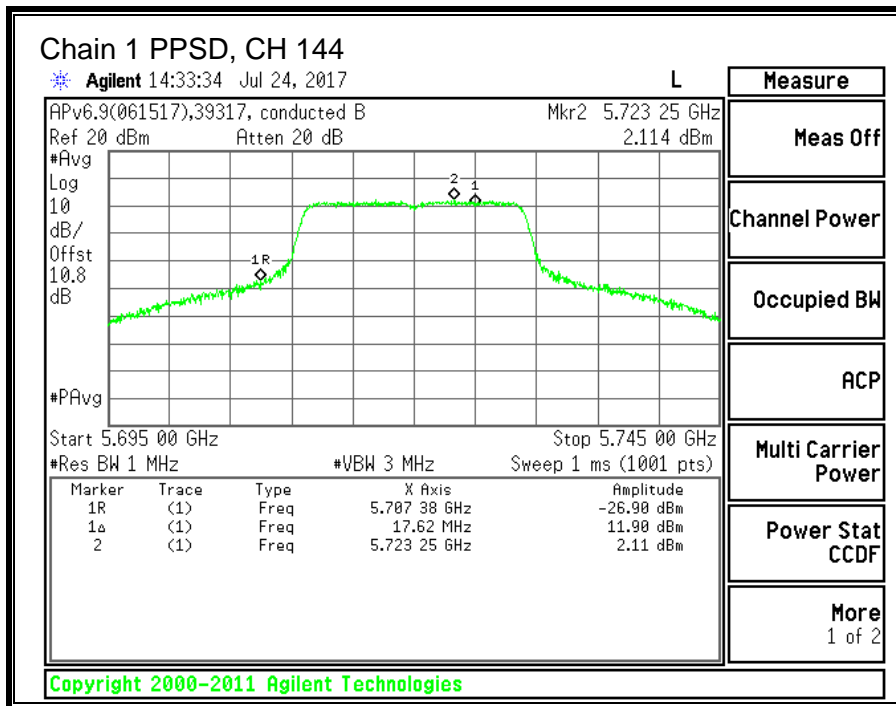
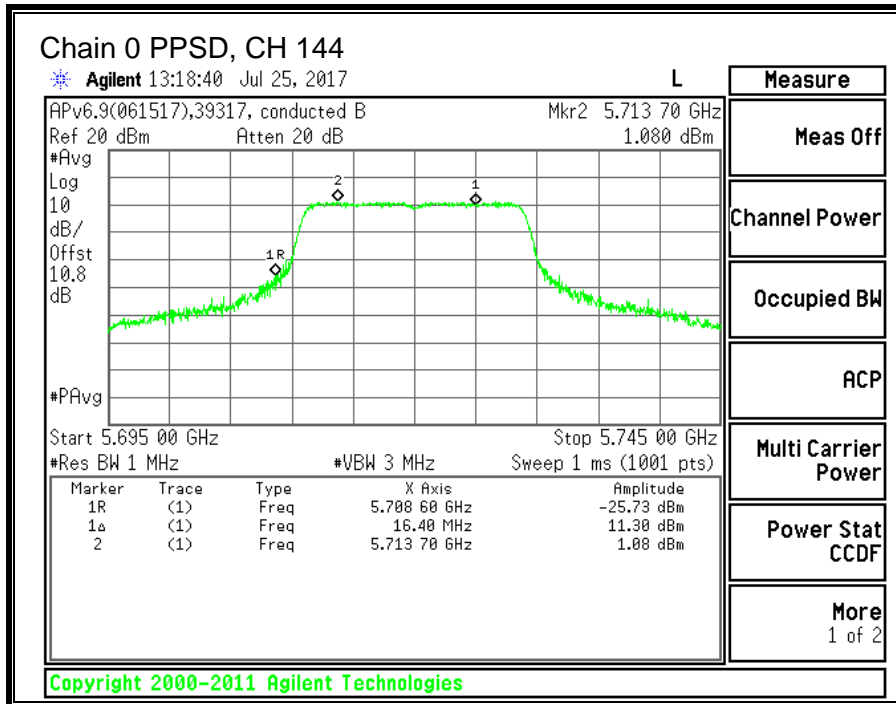

10.11. 11n HT40 2TX CDD MIMO MODE IN THE 5.6GHz BAND

10.11.1. 26 dB BANDWIDTH

LIMITS

None; for reporting purposes only.

RESULTS

Channel	Frequency	26 dB BW Chain 0 (MHz)	26 dB BW Chain 1 (MHz)
Low	5510	43.0	42.7
Mid	5550	43.0	42.6
Mid (FCC)	5630	42.5	49.3
High	5670	44.0	42.6
142	5710	43.8	42.7

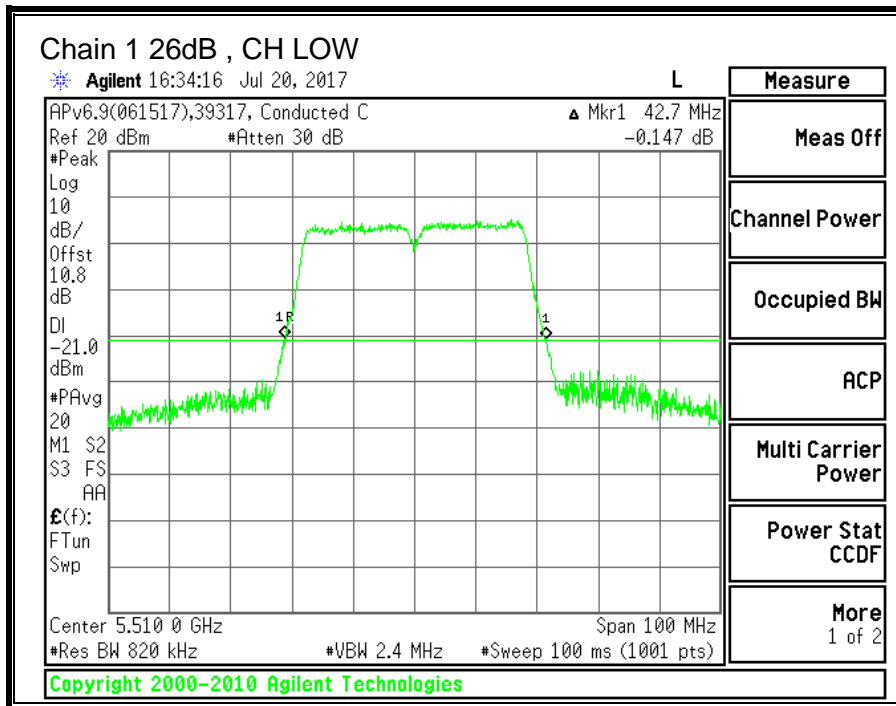
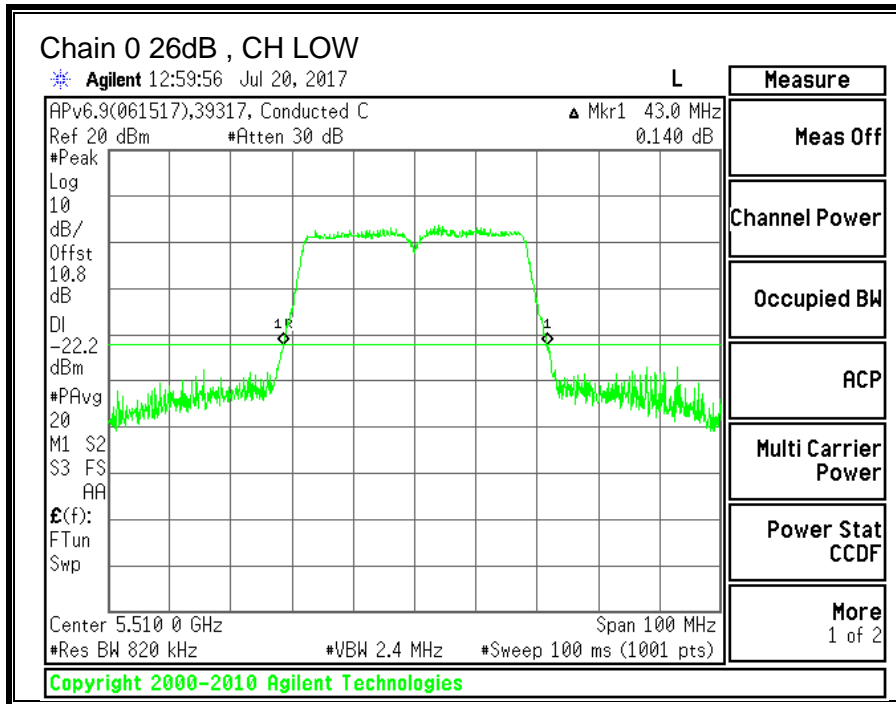

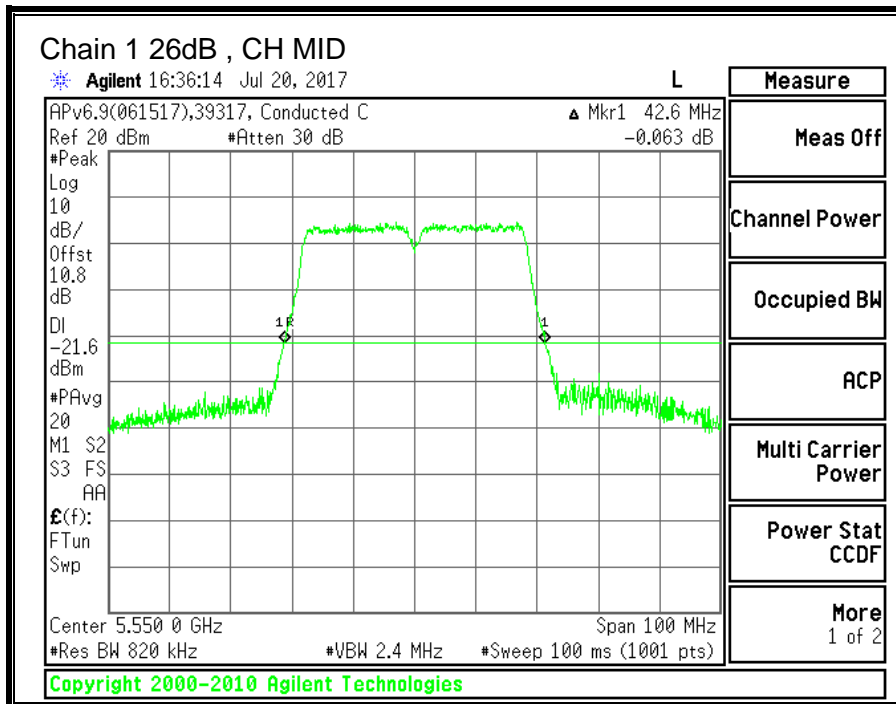
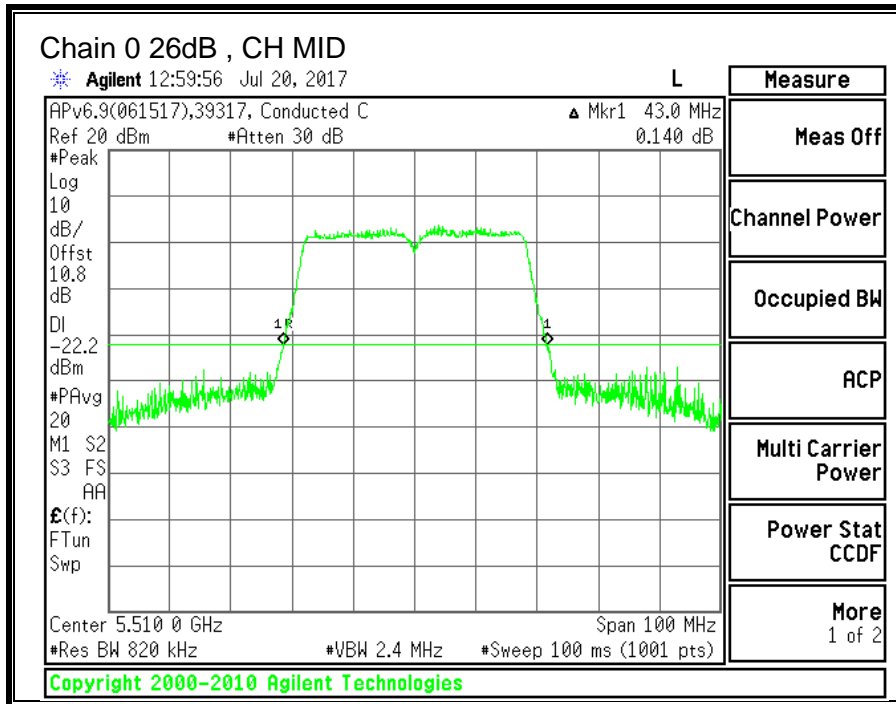

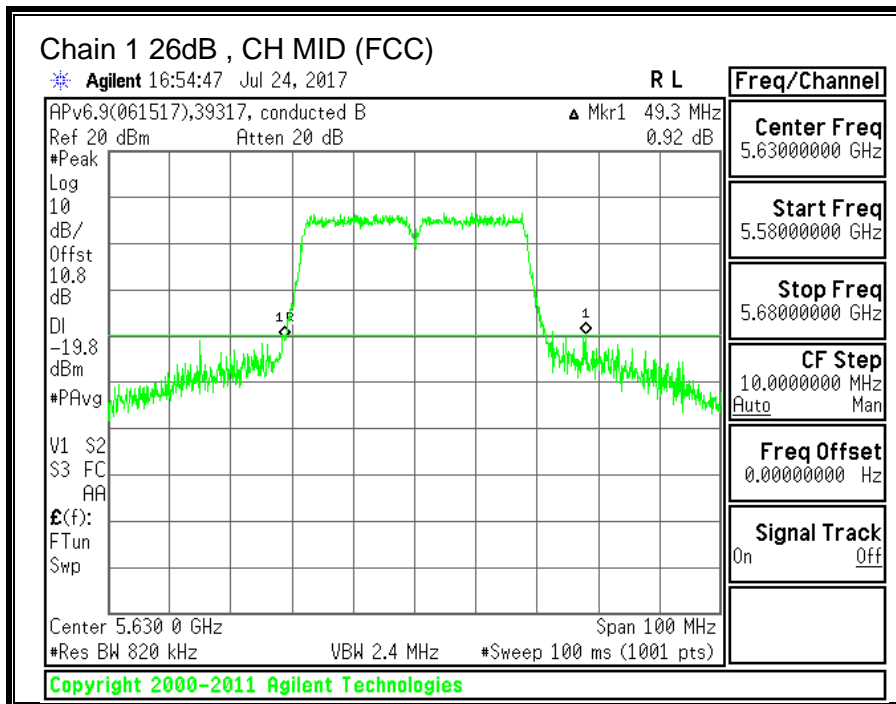
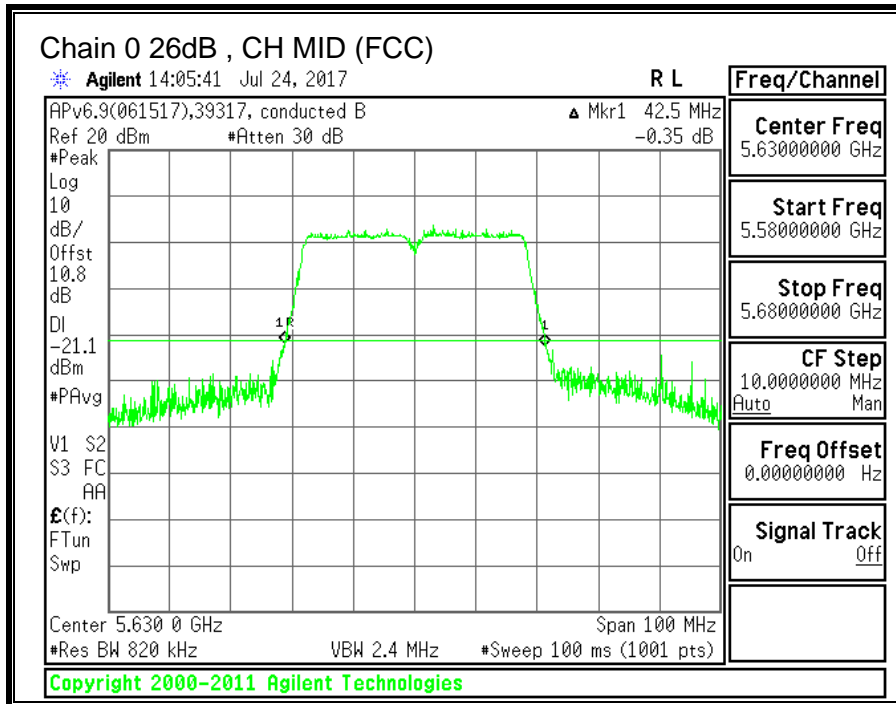

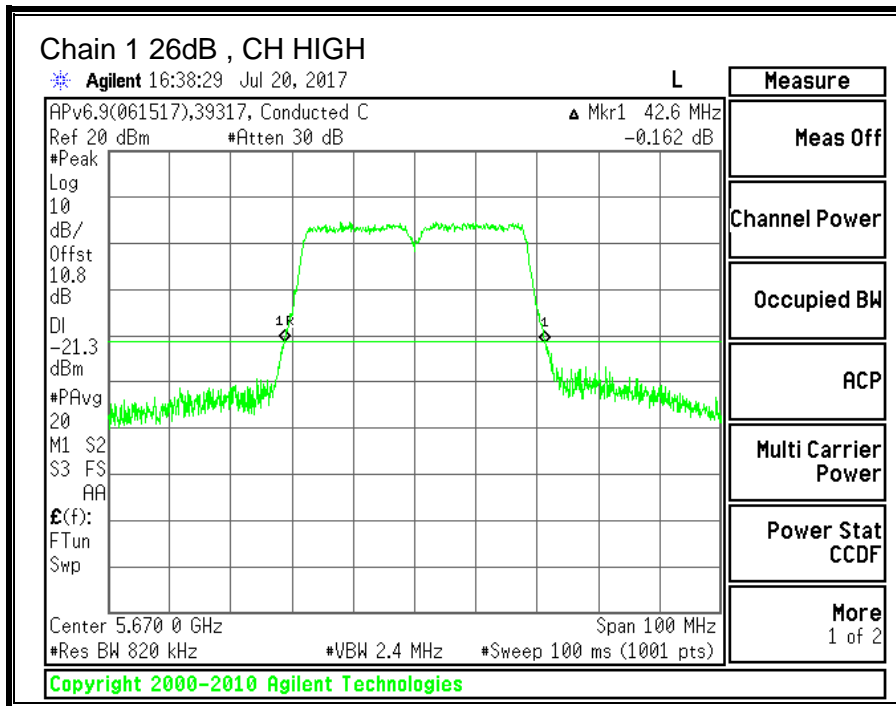
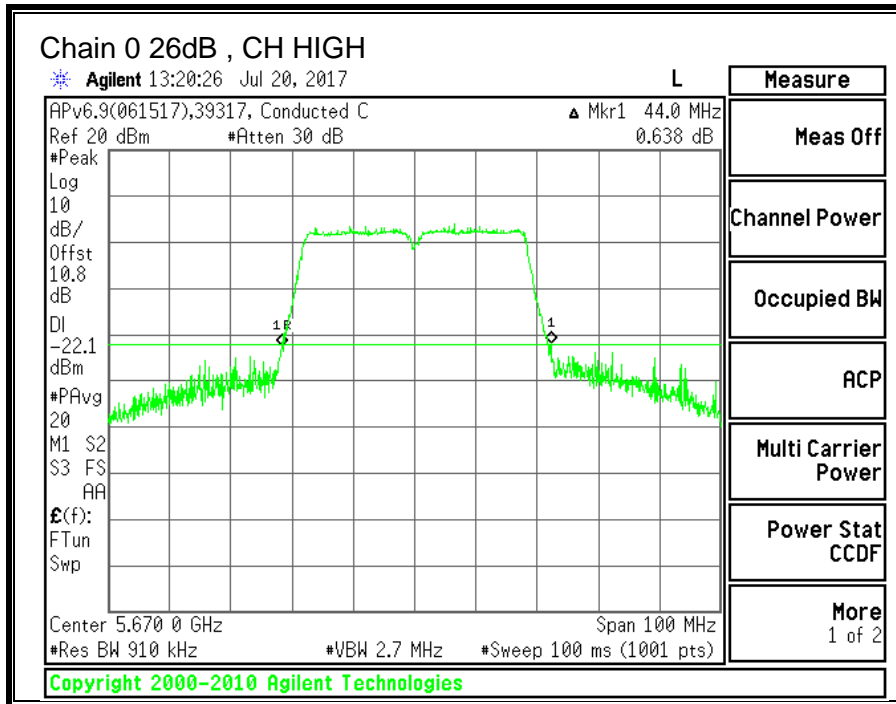

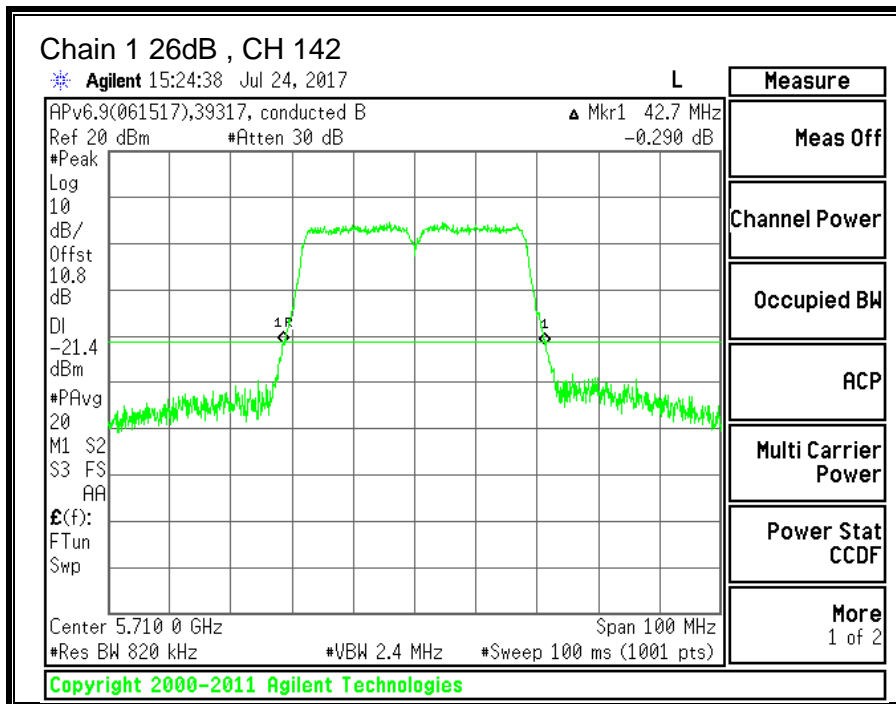
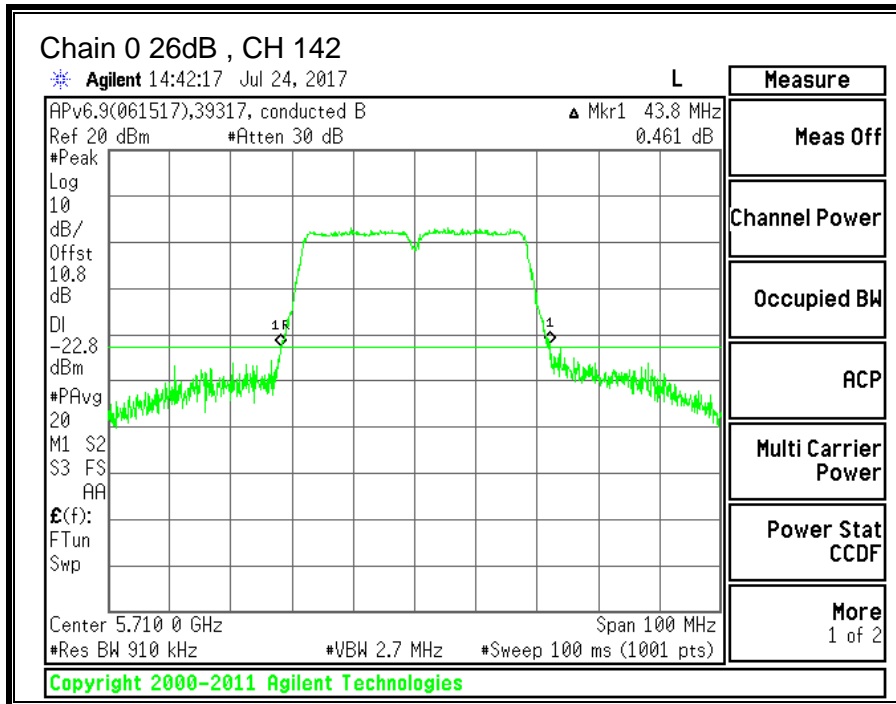

10.11.2. 99% BANDWIDTH

LIMITS

None; for reporting purposes only.

RESULTS

Channel	Frequency	99% BW Chain 0 (MHz)	99% BW Chain 1 (MHz)
Low	5510	35.7373	35.3693
Mid	5550	35.7403	36.0149
Mid (FCC)	5630	36.3841	36.0575
High	5670	36.2939	36.1110
142	5710	35.6576	35.6104

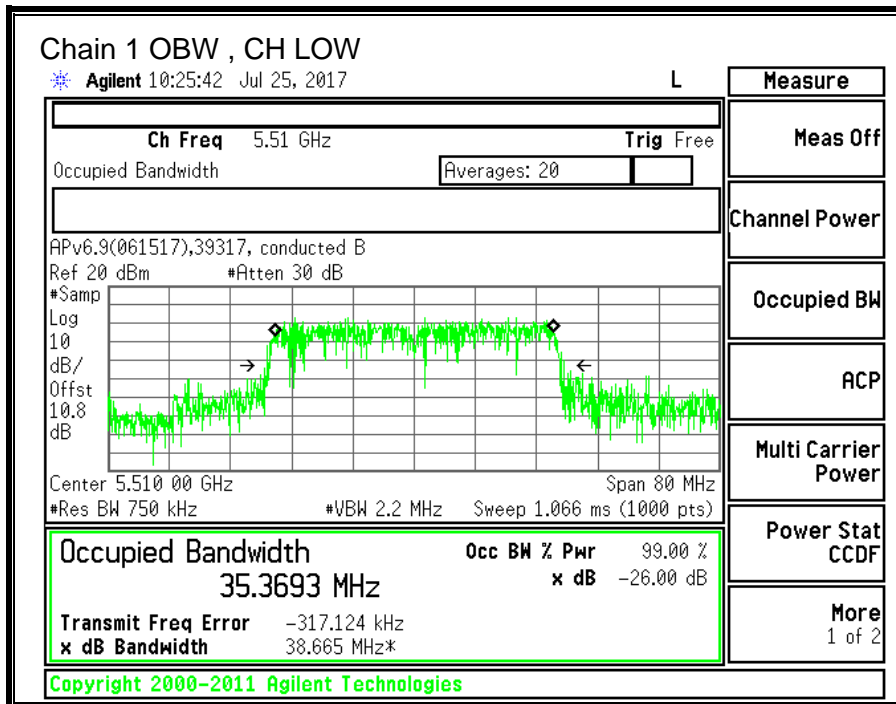
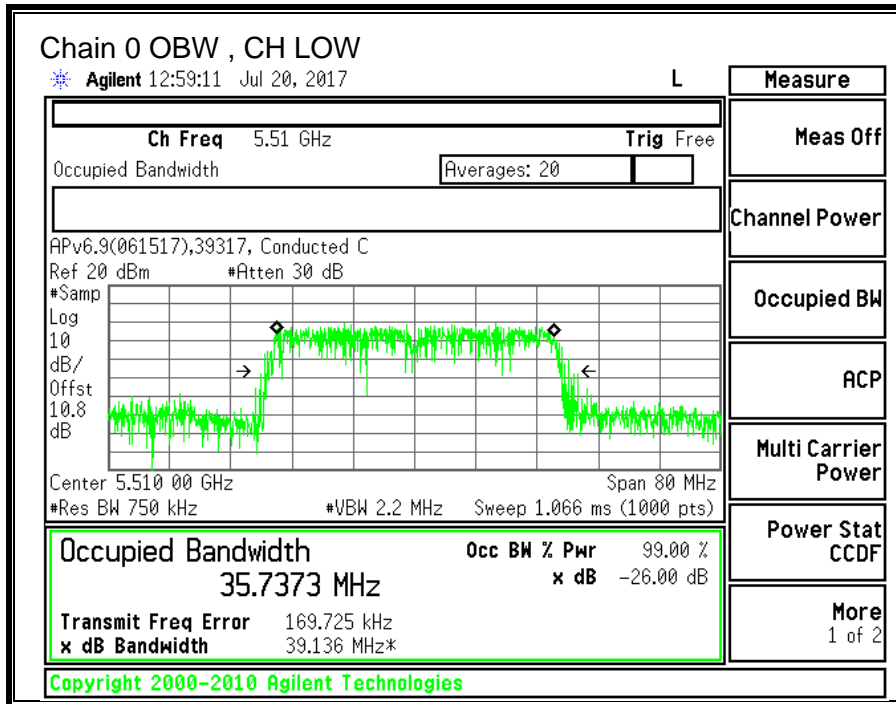

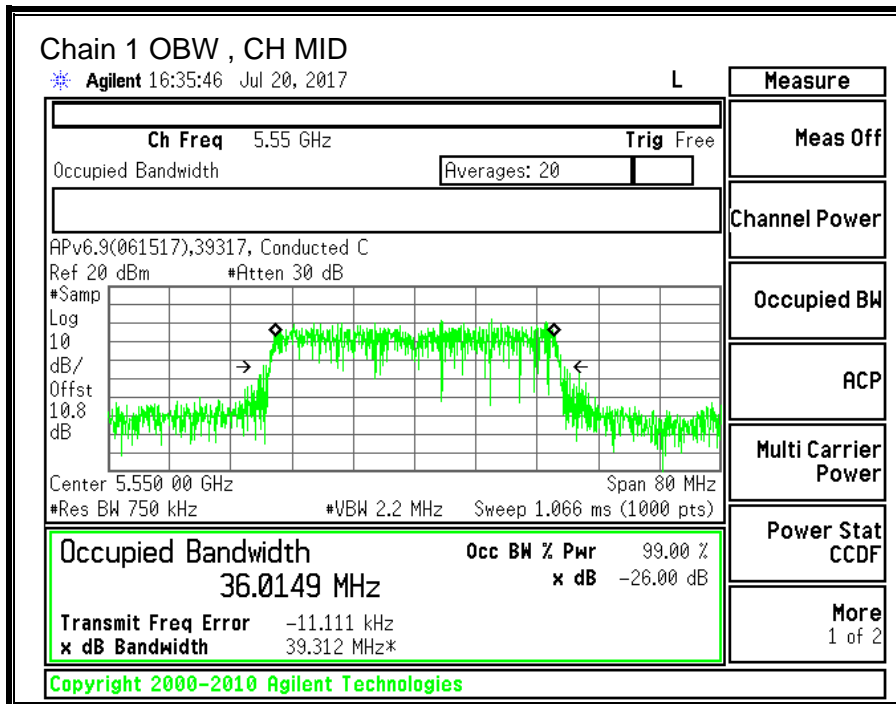
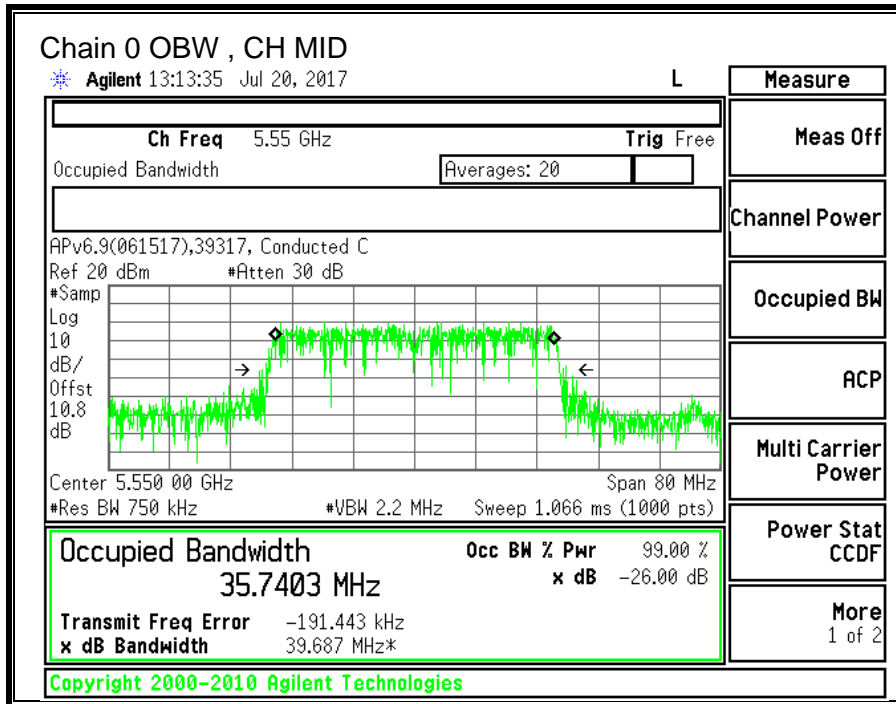

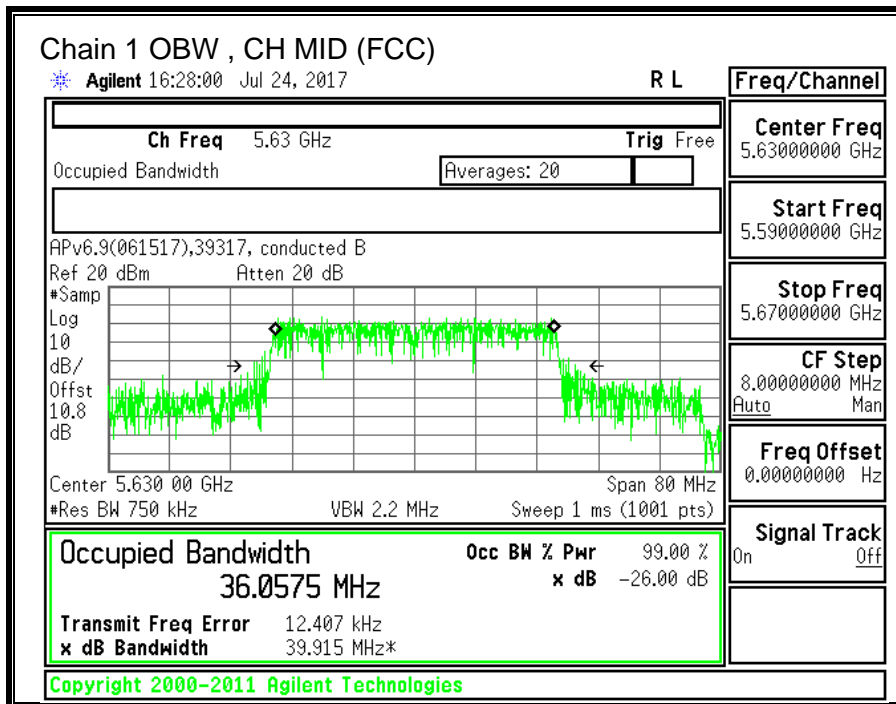
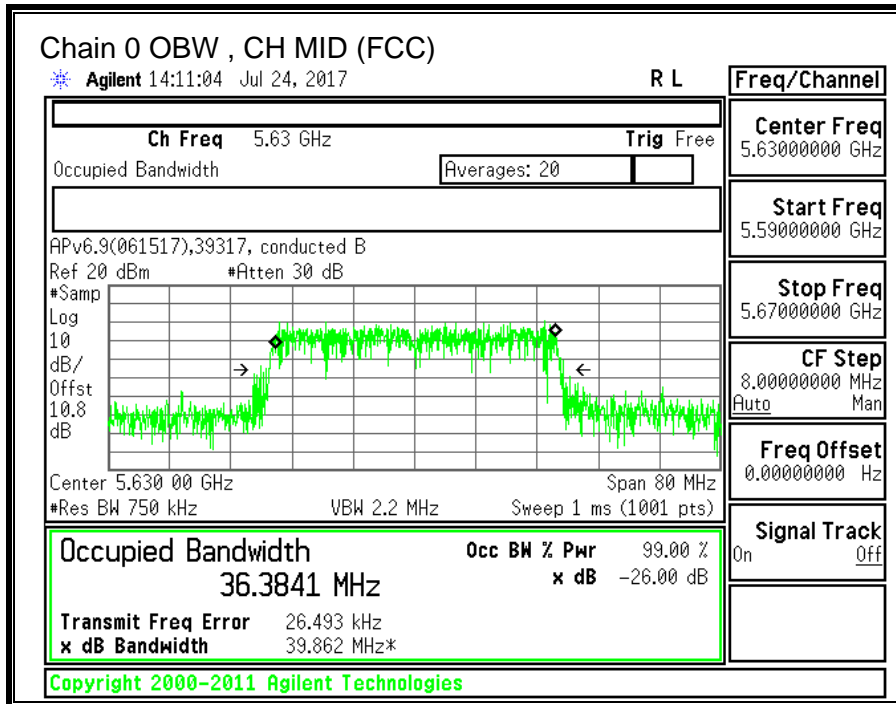

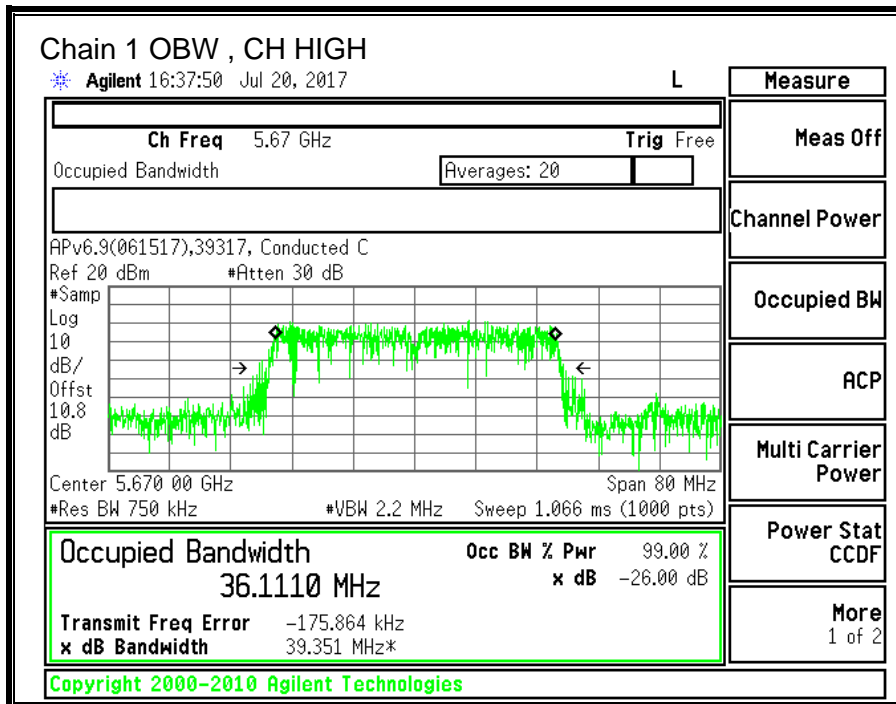
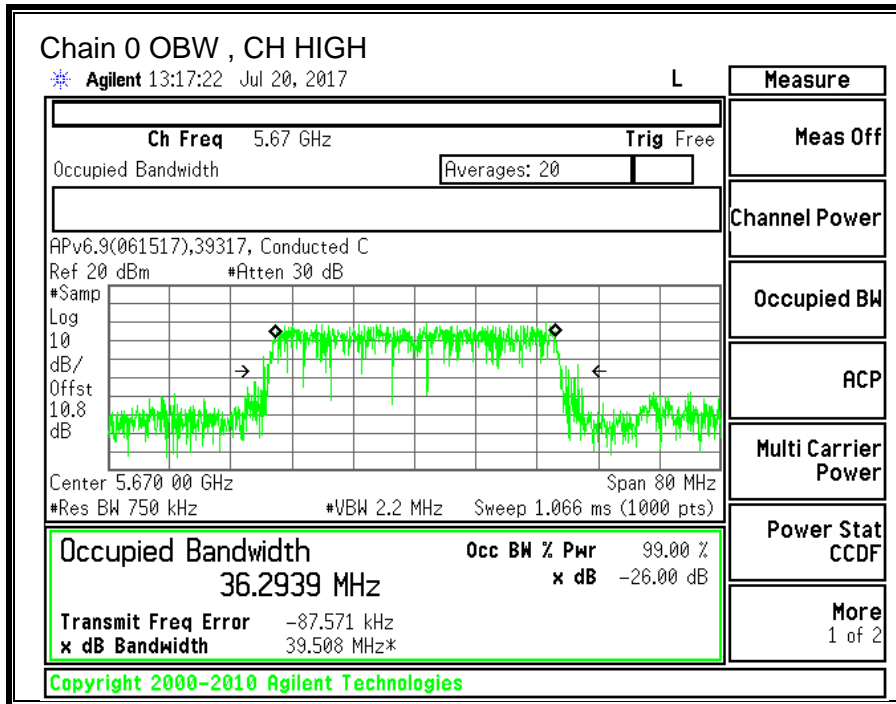

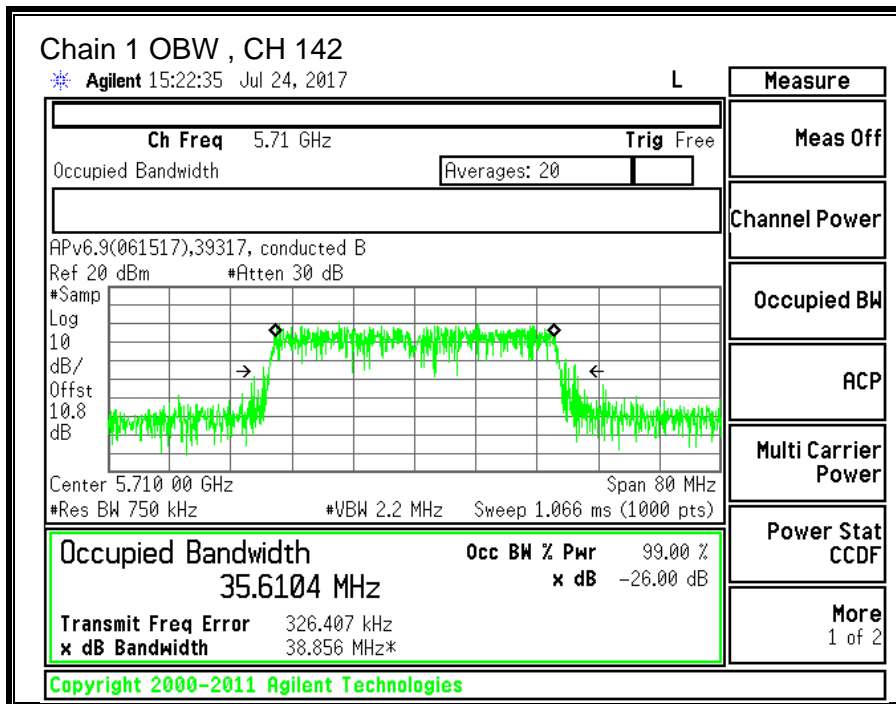
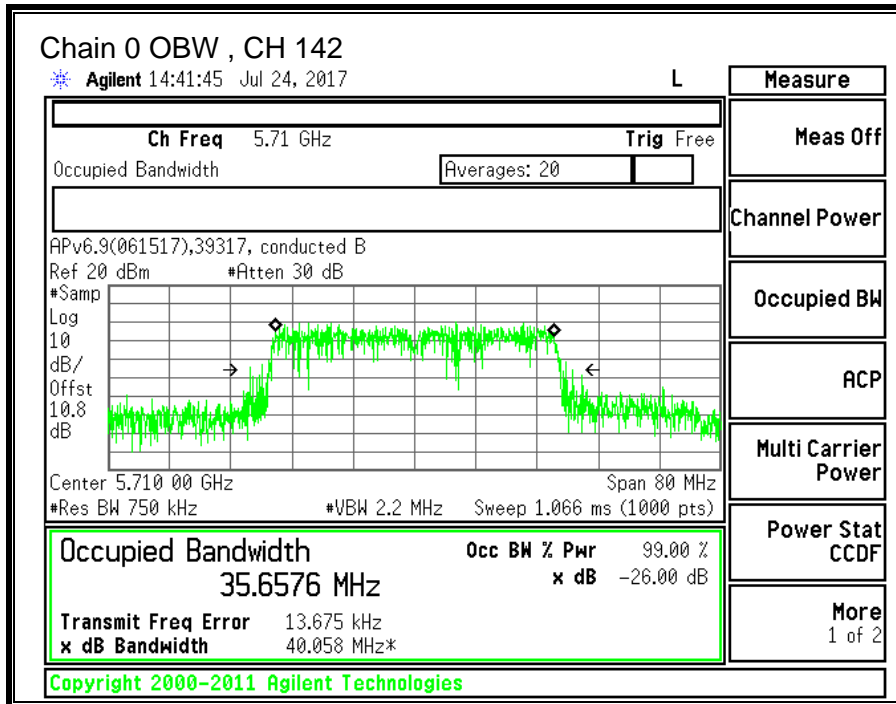

10.11.3. OUTPUT POWER AND PPSD

LIMITS

FCC §15.407 (a) (2)

For the band 5.47–5.725 GHz, the maximum conducted output power over the frequency band of operation shall not exceed the lesser of 250 mW or 11 dBm + 10 log B, where B is the 26–dB emission bandwidth in MHz. In addition, the maximum power spectral density shall not exceed 11 dBm in any 1–MHz band. If transmitting antennas of directional gain greater than 6 dBi are used, both the maximum conducted output power and the peak power spectral density shall be reduced by the amount in dB that the directional gain of the antenna exceeds 6 dBi.

TEST PROCEDURE

Measurements perform using a wideband gated RF power meter provided that the gate parameters are adjusted such that the power is measured only when the EUT is transmitting at its maximum power control level. Since the measurement is made only during the ON time of the transmitter, no duty cycle correction factor is required.

Straddle channel power is measured using PXA spectrum analyzer, duty cycle correction factor is required.

DIRECTIONAL ANTENNA GAIN

For power, the TX chains are uncorrelated and the antenna gain is unequal among the chains. The directional gain is:

5470-5725 MHz

Chain 0 Antenna Gain (dBi)	Chain 1 Antenna Gain (dBi)	Uncorrelated Chains Directional Gain (dBi)
-1.60	0.70	-0.30

For PSD the TX chains are correlated and the antenna gain is unequal among the chains. The directional gain is:

5470-5725 MHz

Chain 0 Antenna Gain (dBi)	Chain 1 Antenna Gain (dBi)	Correlated Chains Directional Gain (dBi)
-1.60	0.70	2.64

RESULTS

ID:	39317	Date:	07/21/17
------------	-------	--------------	----------

Bandwidth and Antenna Gain

Channel	Frequency (MHz)	Min 26 dB BW (MHz)	Min 99% BW (MHz)	Directional Gain for Power (dBi)	Directional Gain for PPSD (dBi)
Low	5510	42.70	35.37	0.30	2.64
Mid	5550	42.60	35.74	0.30	2.64
Mid (FCC)	5630	42.50	36.06	0.30	2.64
High	5670	42.60	36.11	0.30	2.64
142	5710	42.70	35.61	0.30	2.64

Limits

Channel	Frequency (MHz)	FCC Power Limit (dBm)	IC Power Limit (dBm)	IC EIRP Limit (dBm)	Power Limit (dBm)	FCC PPSD Limit (dBm)	IC PSD Limit (dBm)	PPSD Limit (dBm)
Low	5510	24.00	24.00	30.00	24.00	11.00	11.00	11.00
Mid	5550	24.00	24.00	30.00	24.00	11.00	11.00	11.00
Mid (FCC)	5630	24.00	24.00	30.00	24.00	11.00	11.00	11.00
High	5670	24.00	24.00	30.00	24.00	11.00	11.00	11.00
142	5710	24.00	24.00	30.00	24.00	11.00	11.00	11.00

Duty Cycle CF (dB)	0.39	Included in Calculations of Corr'd PPSD
---------------------------	------	--

Output Power Results

Channel	Frequency (MHz)	Chain 0 Meas Power (dBm)	Chain 1 Meas Power (dBm)	Total Corr'd Power (dBm)	Power Limit (dBm)	Power Margin (dB)
Low	5510	12.77	13.28	16.04	24.00	-7.96
Mid	5550	12.87	13.56	16.24	24.00	-7.76
Mid (FCC)	5630	13.21	13.63	16.44	24.00	-7.56
High	5670	12.99	13.45	16.24	24.00	-7.76
142	5710	12.91	13.46	16.20	24.00	-7.80

PPSD Results

Channel	Frequency (MHz)	Chain 0 Meas PPSD (dBm)	Chain 1 Meas PPSD (dBm)	Total Corr'd PPSD (dBm)	PPSD Limit (dBm)	PPSD Margin (dB)
Low	5510	-1.516	-1.258	2.02	11.00	-8.98
Mid	5550	-1.509	-0.445	2.46	11.00	-8.54
Mid (FCC)	5630	-1.448	-0.700	2.34	11.00	-8.66
High	5670	-1.358	-0.731	2.37	11.00	-8.63
142	5710	-1.296	-1.391	2.06	11.00	-8.94

Note: the power readings above were measured with gated method, and the measurement was taken only during the ON time. No duty cycle correction was necessary.

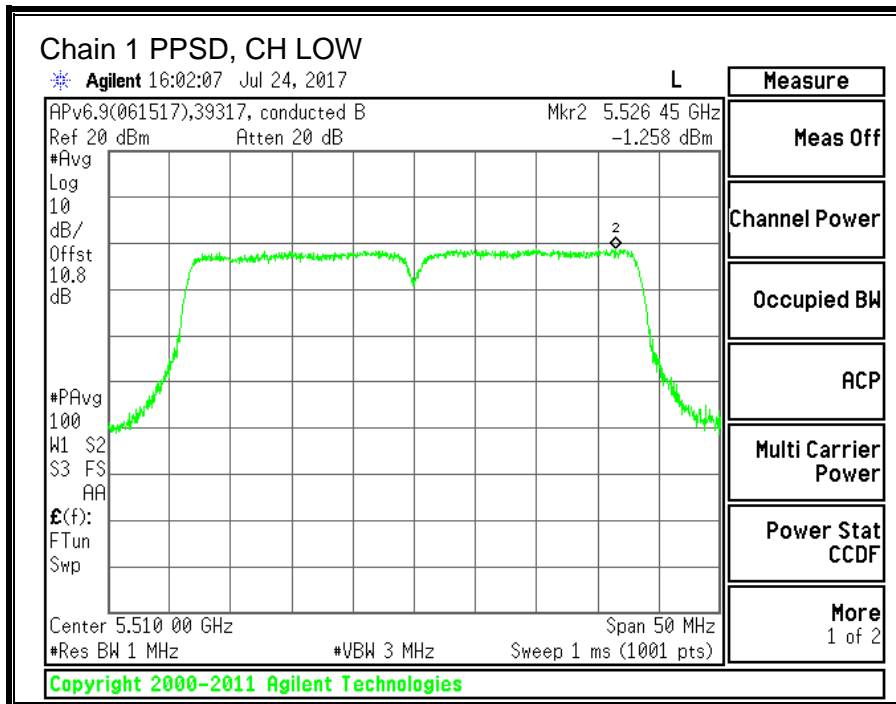
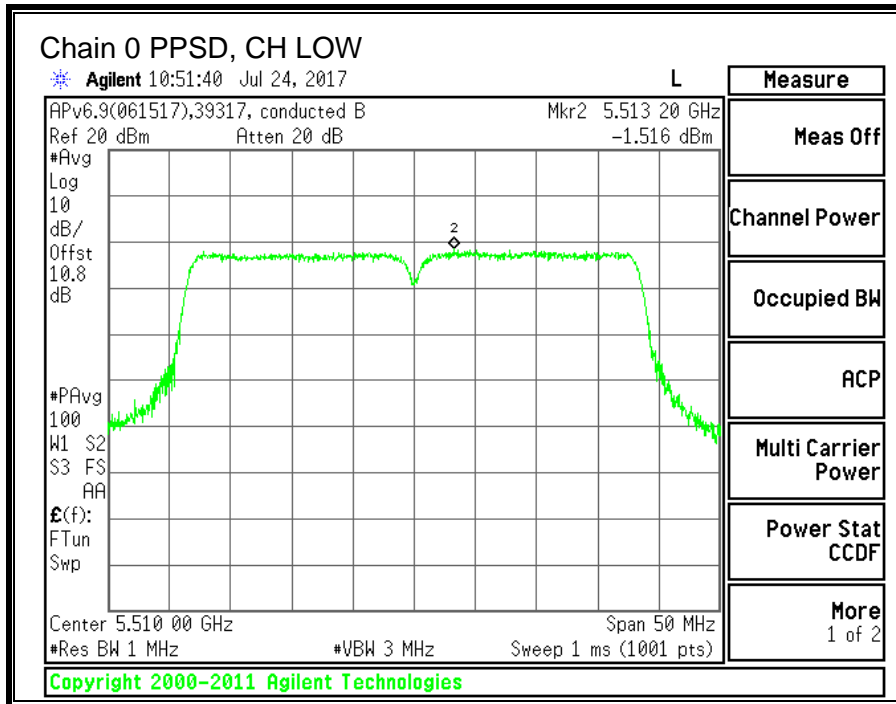

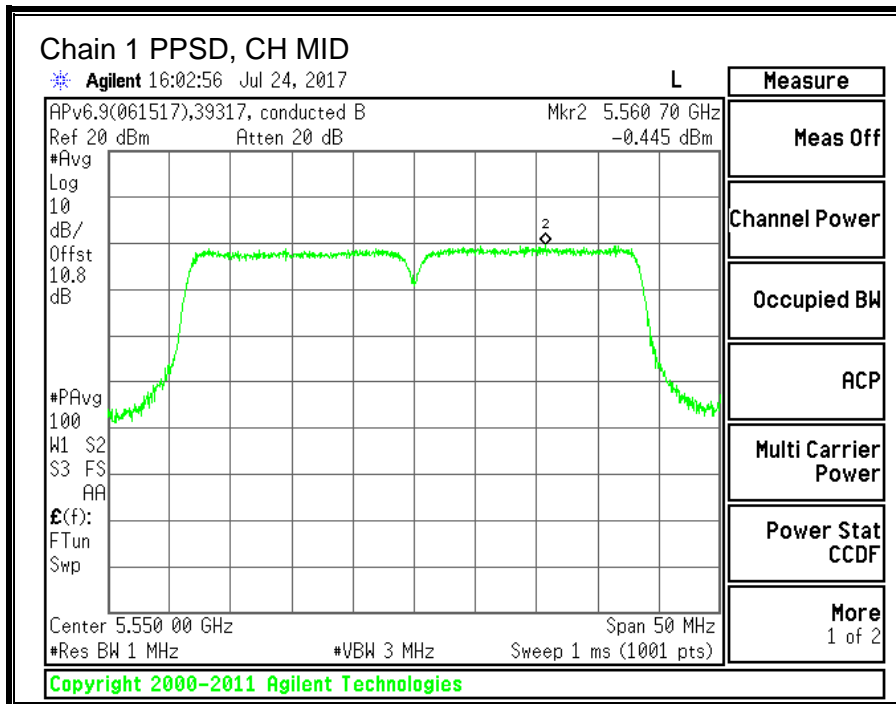
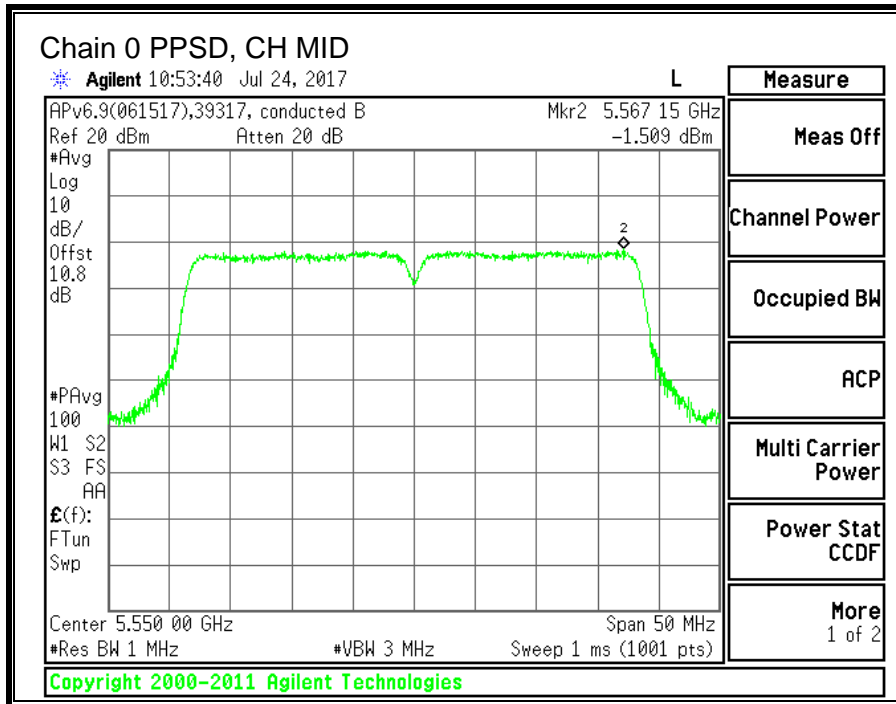

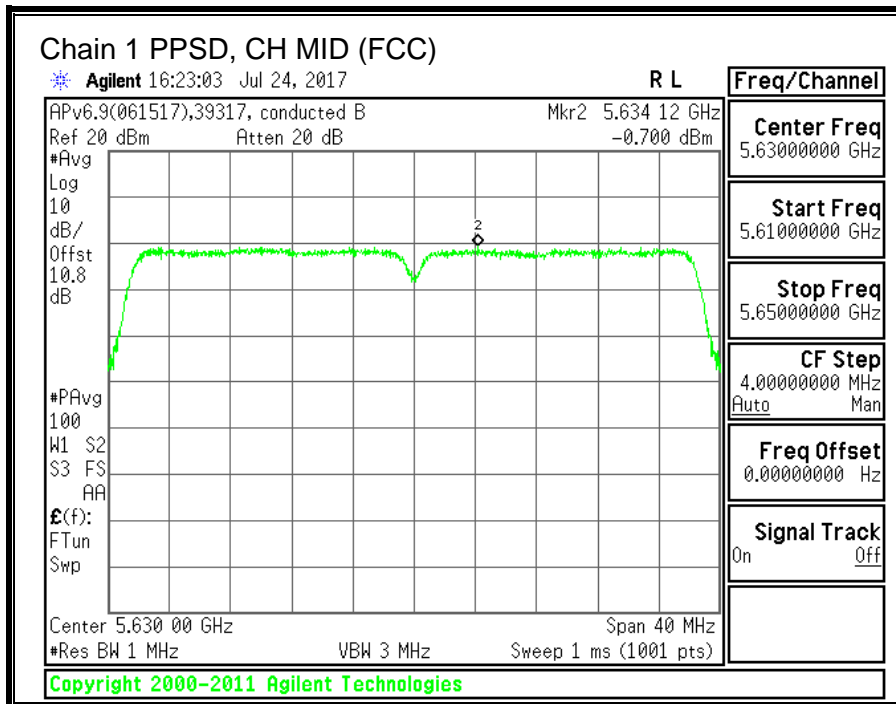
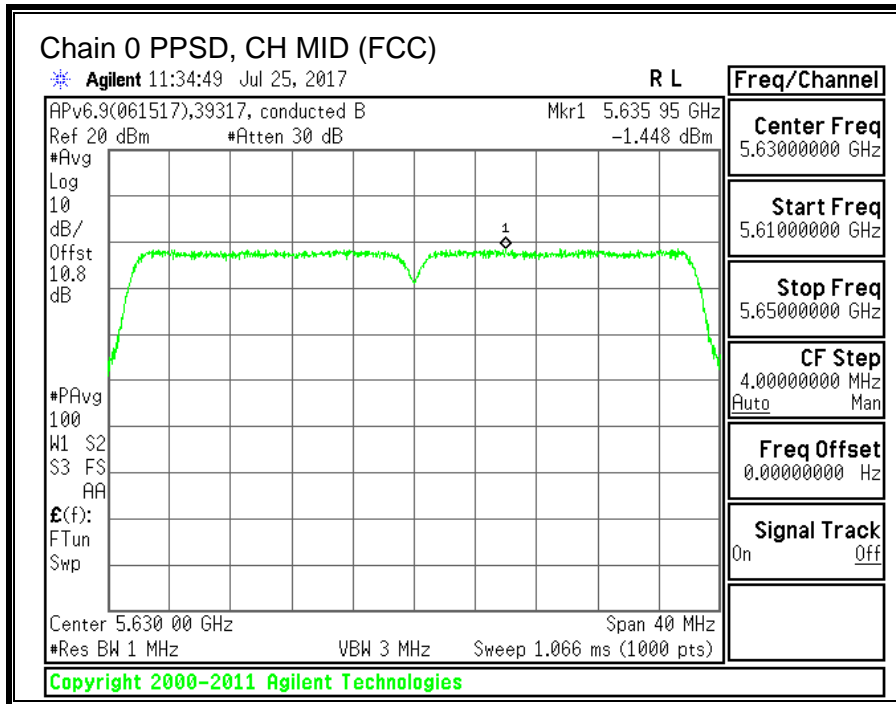

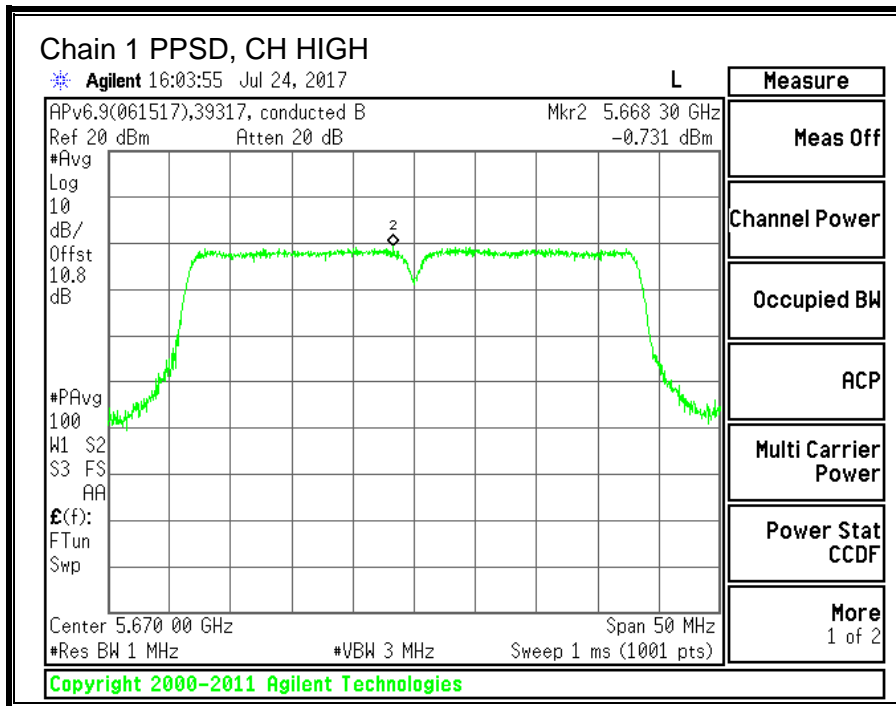
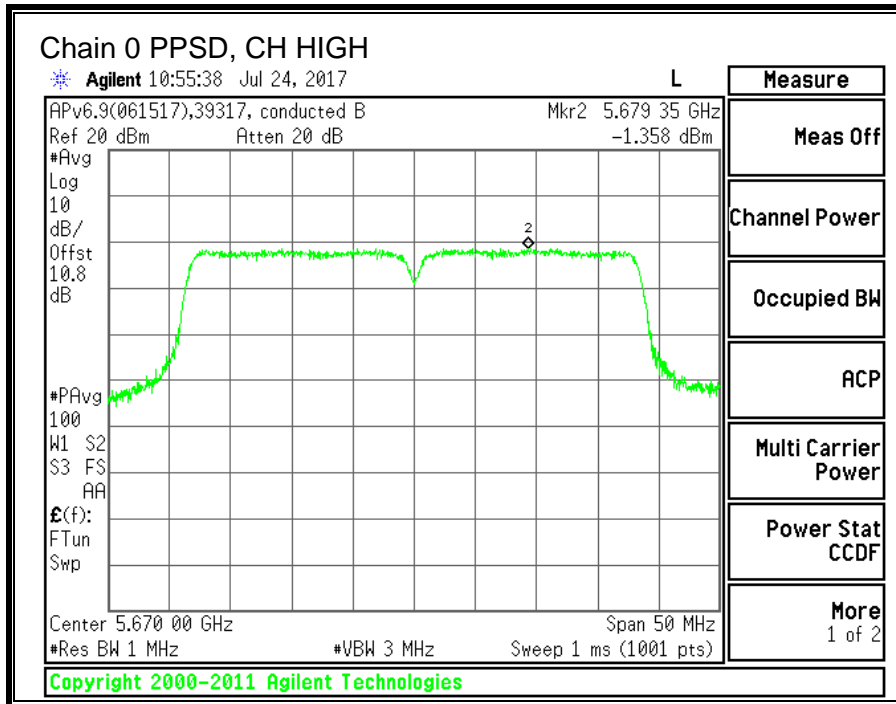

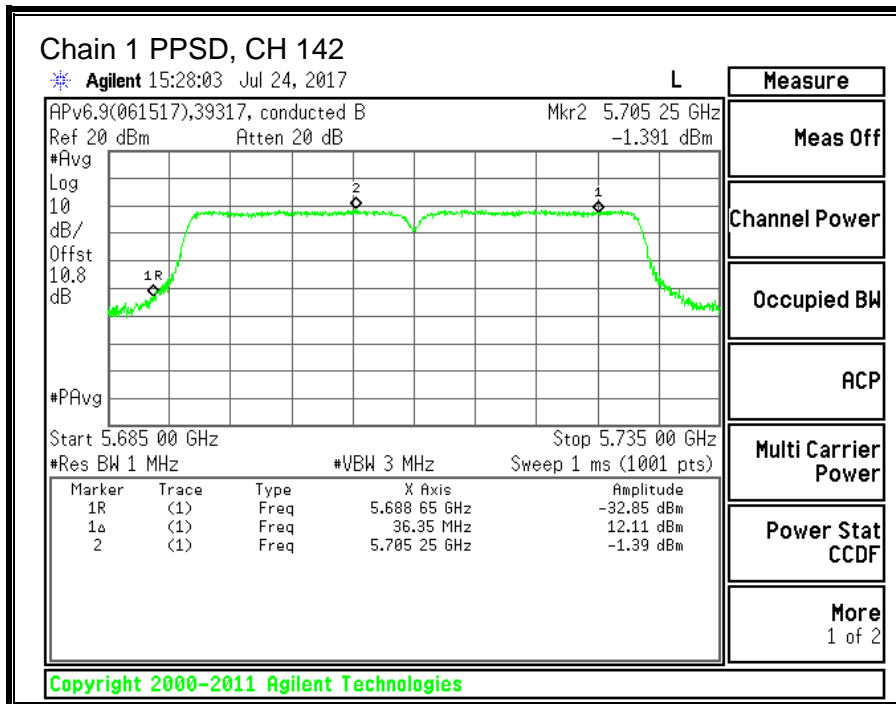
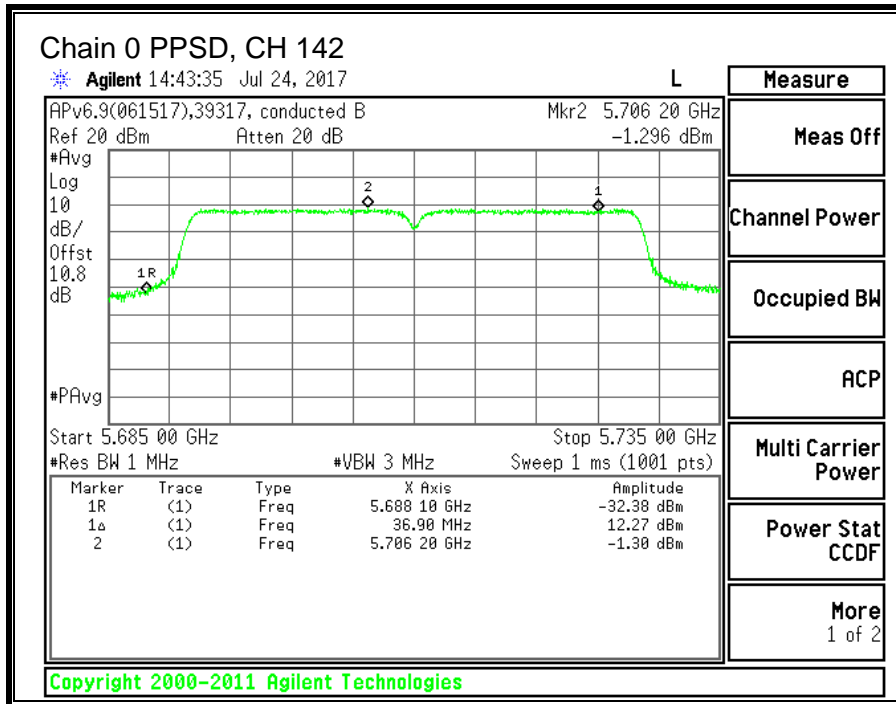

10.12. 11ac VHT80 2TX CDD MIMO MODE IN THE 5.6GHz BAND

10.12.1.26 dB BANDWIDTH

LIMITS

None; for reporting purposes only.

RESULTS

Channel	Frequency	26 dB BW Chain 0 (MHz)	26 dB BW Chain 1 (MHz)
Low	5530	86.60	85.20
Mid	5610	87.00	85.80
138	5690	111.4	85.60

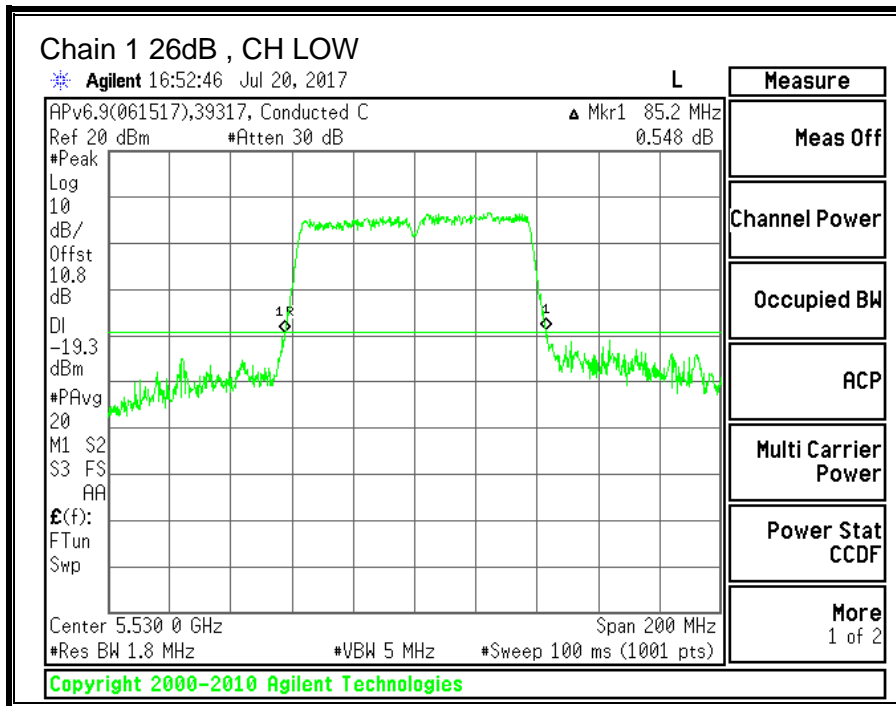
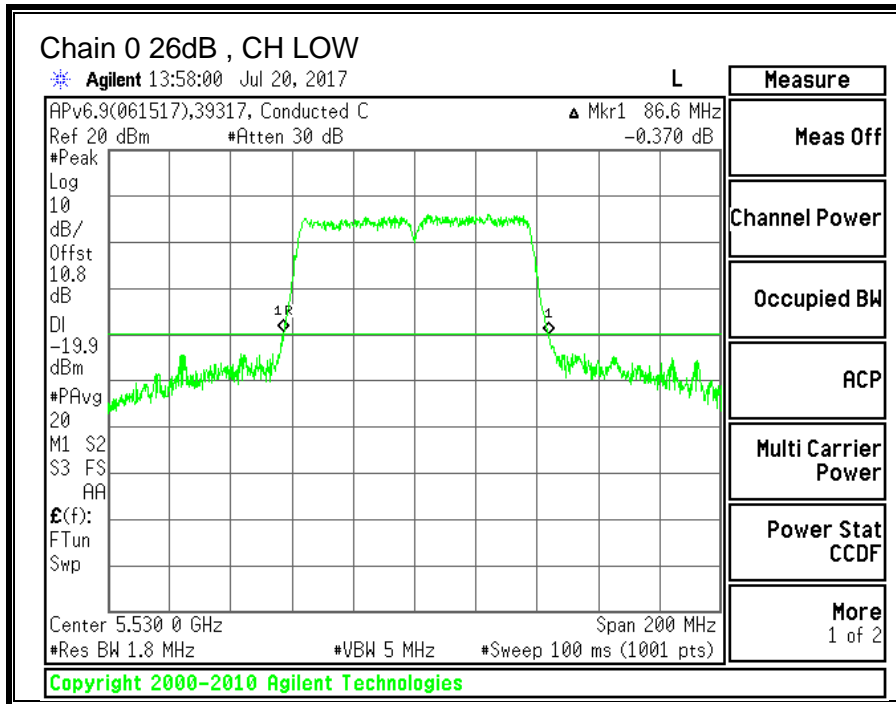

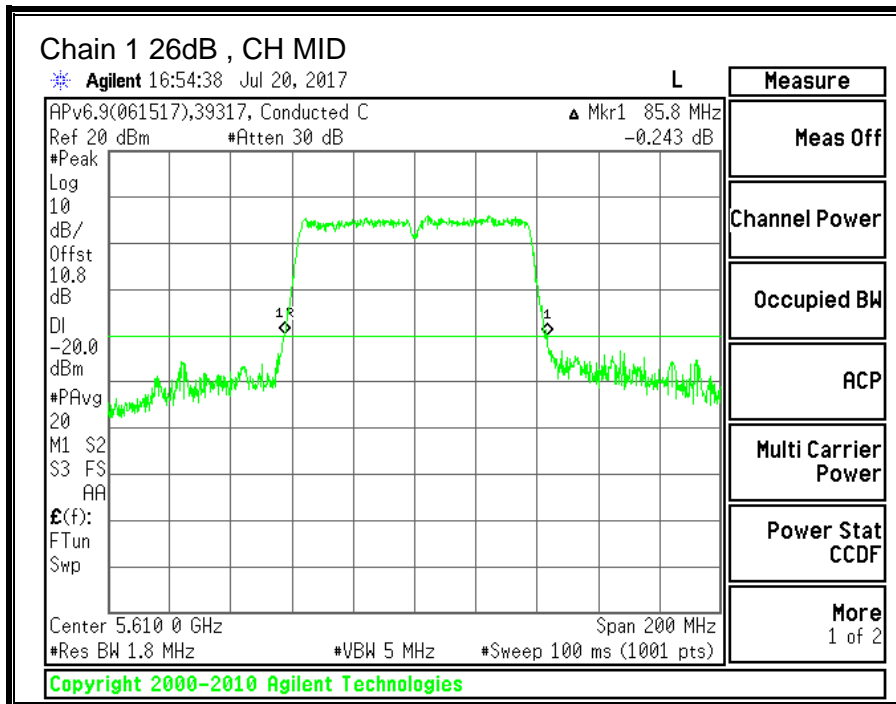
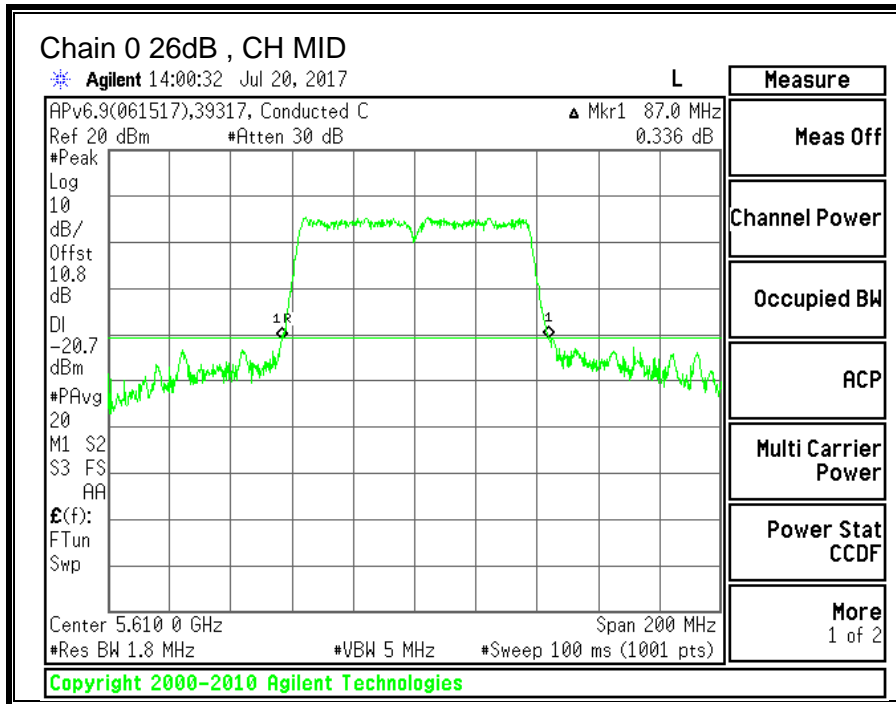

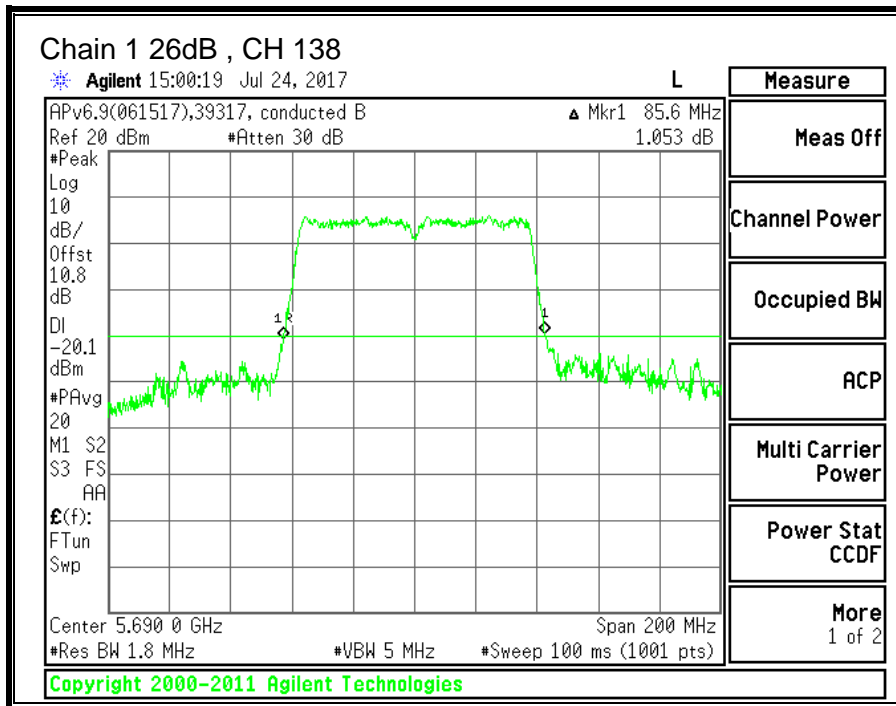
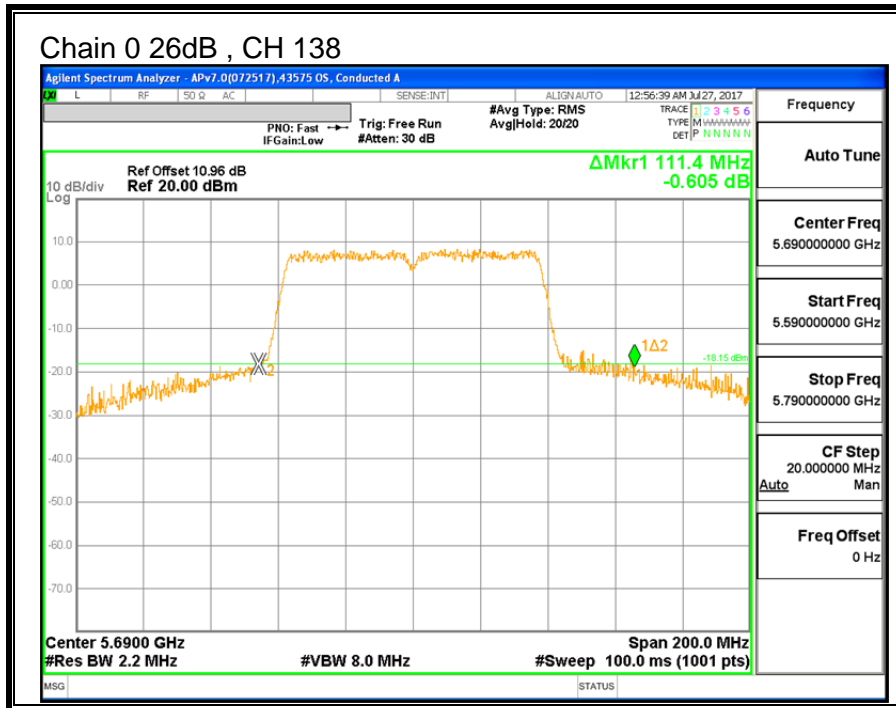

10.12.2. 99% BANDWIDTH

LIMITS

None; for reporting purposes only.

RESULTS

Channel	Frequency	99% BW Chain 0 (MHz)	99% BW Chain 1 (MHz)
Low	5530	74.4478	73.2688
Mid	5610	73.0748	74.0859
138	5690	74.8490	72.9579

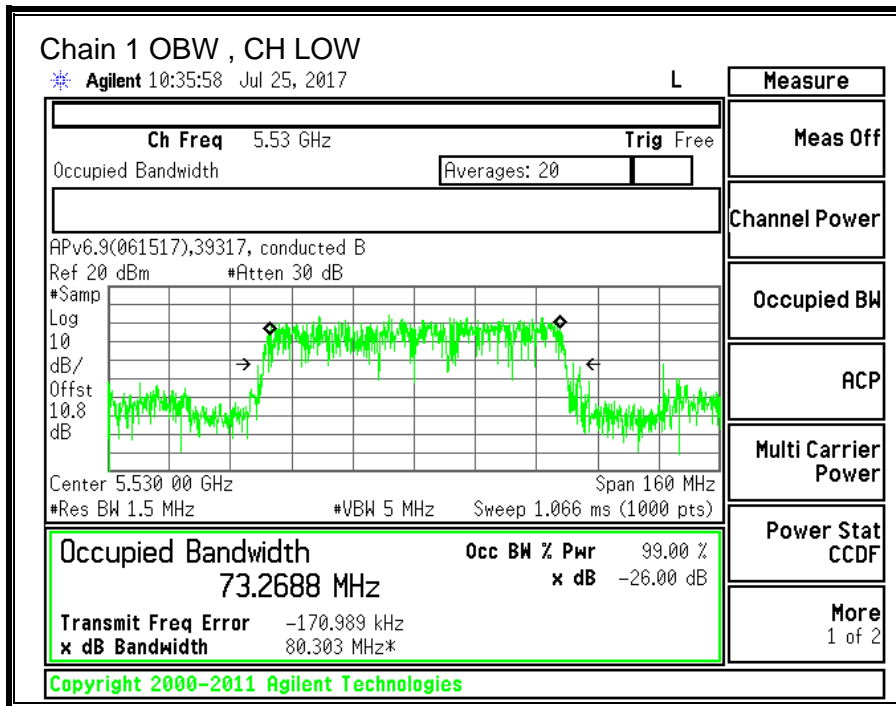
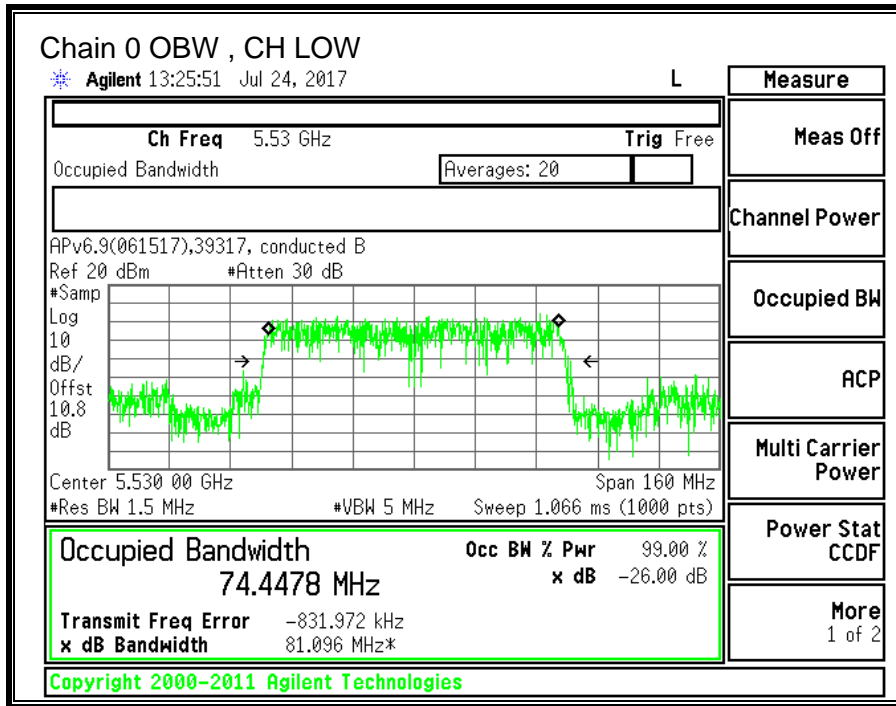

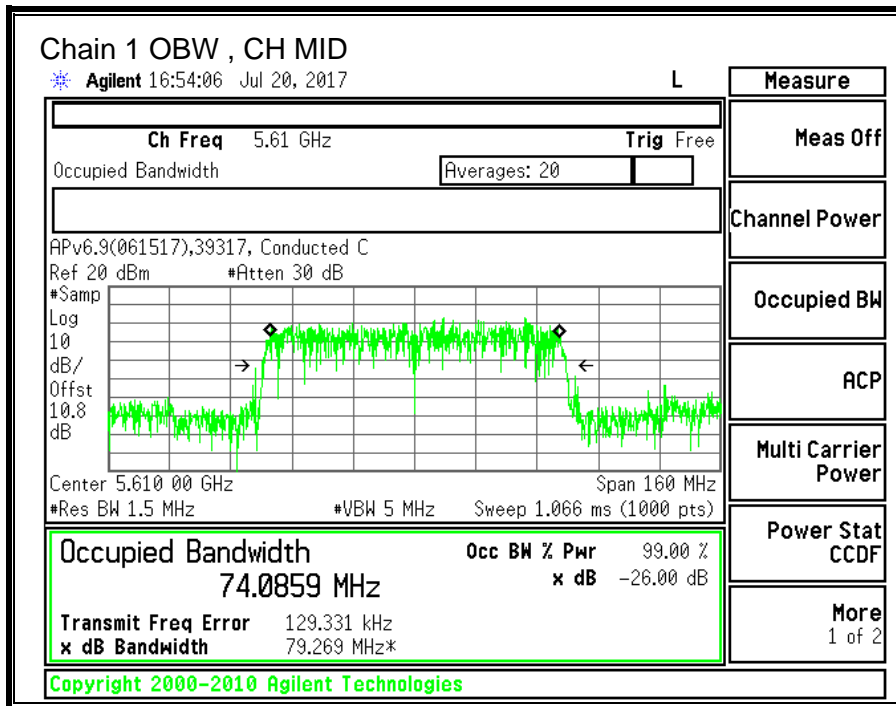
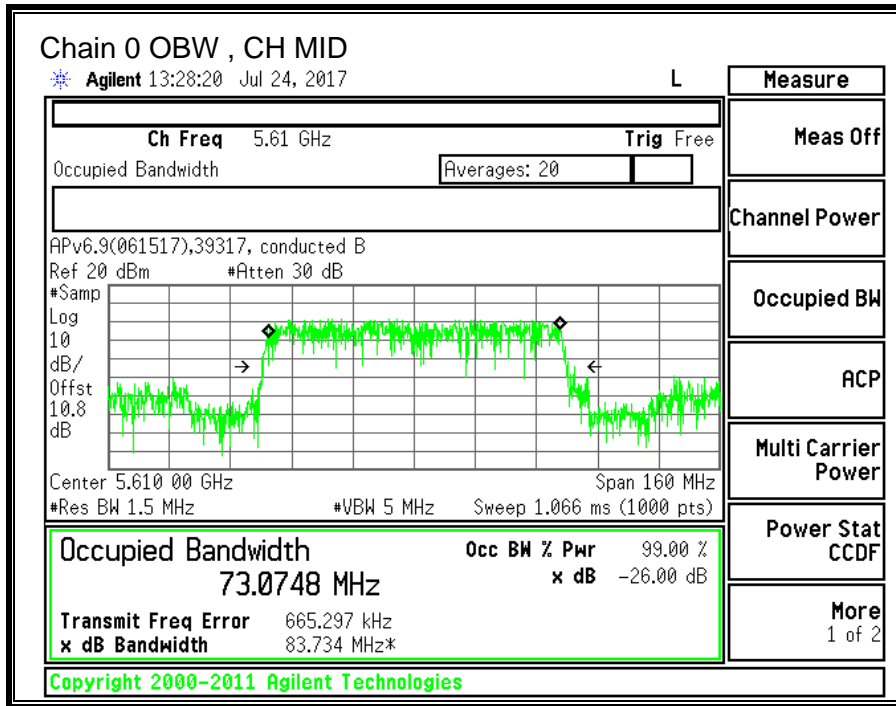

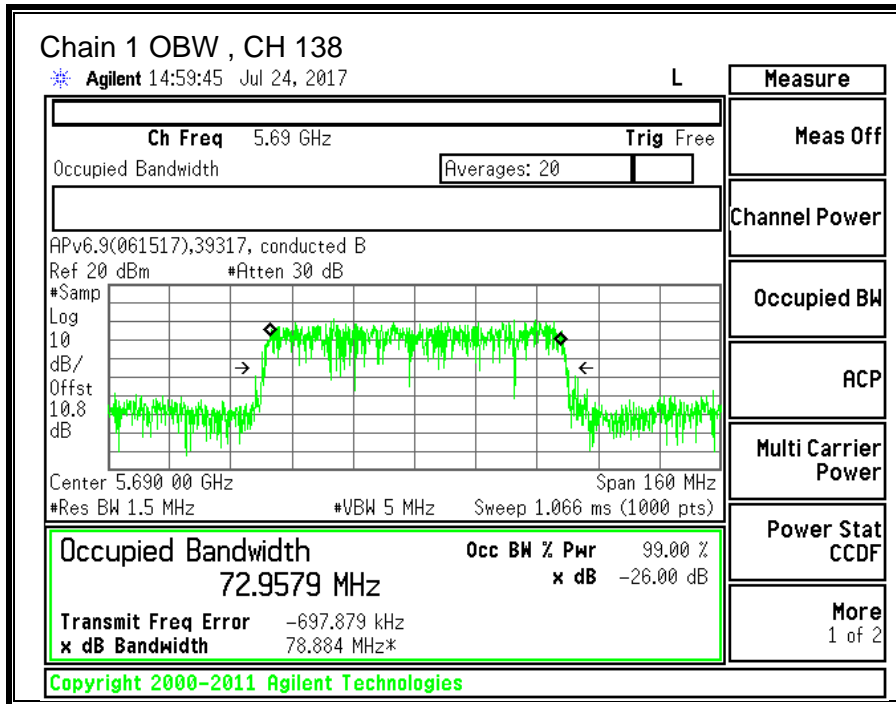
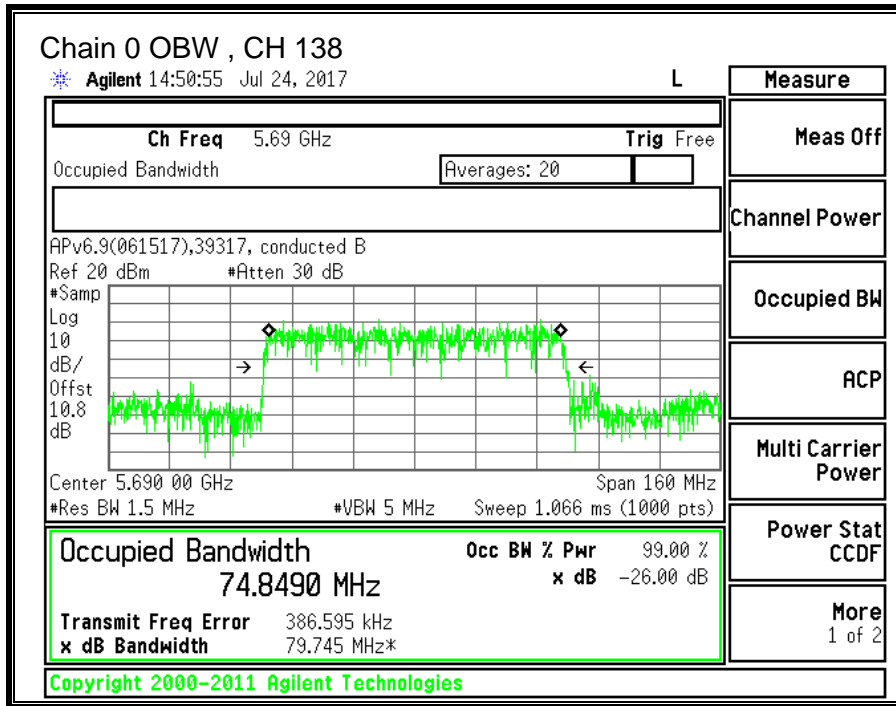

10.12.3. OUTPUT POWER AND PPSD

LIMITS

FCC §15.407 (a) (2)

For the band 5.47–5.725 GHz, the maximum conducted output power over the frequency band of operation shall not exceed the lesser of 250 mW or 11 dBm + 10 log B, where B is the 26–dB emission bandwidth in MHz. In addition, the maximum power spectral density shall not exceed 11 dBm in any 1–MHz band. If transmitting antennas of directional gain greater than 6 dBi are used, both the maximum conducted output power and the peak power spectral density shall be reduced by the amount in dB that the directional gain of the antenna exceeds 6 dBi.

TEST PROCEDURE

Measurements perform using a wideband gated RF power meter provided that the gate parameters are adjusted such that the power is measured only when the EUT is transmitting at its maximum power control level. Since the measurement is made only during the ON time of the transmitter, no duty cycle correction factor is required.

Straddle channel power is measured using PXA spectrum analyzer, duty cycle correction factor is required.

DIRECTIONAL ANTENNA GAIN

For power, the TX chains are uncorrelated and the antenna gain is unequal among the chains. The directional gain is:

5470-5725 MHz

Chain 0 Antenna Gain (dBi)	Chain 1 Antenna Gain (dBi)	Uncorrelated Chains Directional Gain (dBi)
-1.60	0.70	-0.30

For PSD the TX chains are correlated and the antenna gain is unequal among the chains. The directional gain is:

5470-5725 MHz

Chain 0 Antenna Gain (dBi)	Chain 1 Antenna Gain (dBi)	Correlated Chains Directional Gain (dBi)
-1.60	0.70	2.64

RESULTS

ID:	39317	Date:	07/21/17
------------	-------	--------------	----------

Bandwidth and Antenna Gain

Channel	Frequency (MHz)	Min 26 dB BW (MHz)	Min 99% BW (MHz)	Directional Gain for Power (dBi)	Directional Gain for PPSD (dBi)
Low	5530	85.20	73.27	-0.30	2.64
Mid	5610	85.80	73.07	-0.30	2.64
138	5690	85.60	72.96	-0.30	2.64

Limits

Channel	Frequency (MHz)	FCC Power Limit (dBm)	IC Power Limit (dBm)	IC EIRP Limit (dBm)	Power Limit (dBm)	FCC PPSD Limit (dBm)	IC PSD Limit (dBm)	PPSD Limit (dBm)
Low	5530	24.00	24.00	30.00	24.00	11.00	11.00	11.00
Mid	5610	24.00	24.00	30.00	24.00	11.00	11.00	11.00
138	5690	24.00	24.00	30.00	24.00	11.00	11.00	11.00

Duty Cycle CF (dB)	0.71	Included in Calculations of Corr'd PPSD
---------------------------	------	--

Output Power Results

Channel	Frequency (MHz)	Chain 0 Meas Power (dBm)	Chain 1 Meas Power (dBm)	Total Corr'd Power (dBm)	Power Limit (dBm)	Power Margin (dB)
Low	5530	13.05	13.73	16.41	24.00	-7.59
Mid	5610	13.01	13.77	16.42	24.00	-7.58
138	5690	13.02	13.63	16.35	24.00	-7.65

PPSD Results

Channel	Frequency (MHz)	Chain 0 Meas PPSD (dBm)	Chain 1 Meas PPSD (dBm)	Total Corr'd PPSD (dBm)	PPSD Limit (dBm)	PPSD Margin (dB)
Low	5530	-4.719	-3.519	-0.36	11.00	-11.36
Mid	5610	-4.472	-3.660	-0.33	11.00	-11.33
138	5690	-4.600	-3.755	-0.44	11.00	-11.44

Note: the power readings above were measured with gated method, and the measurement was taken only during the ON time. No duty cycle correction was necessary.

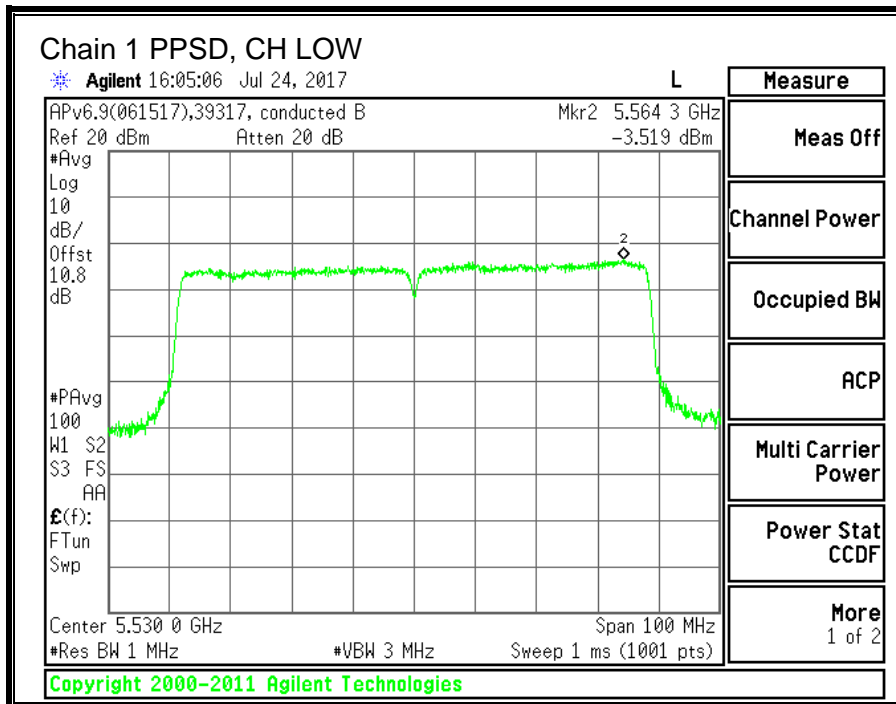
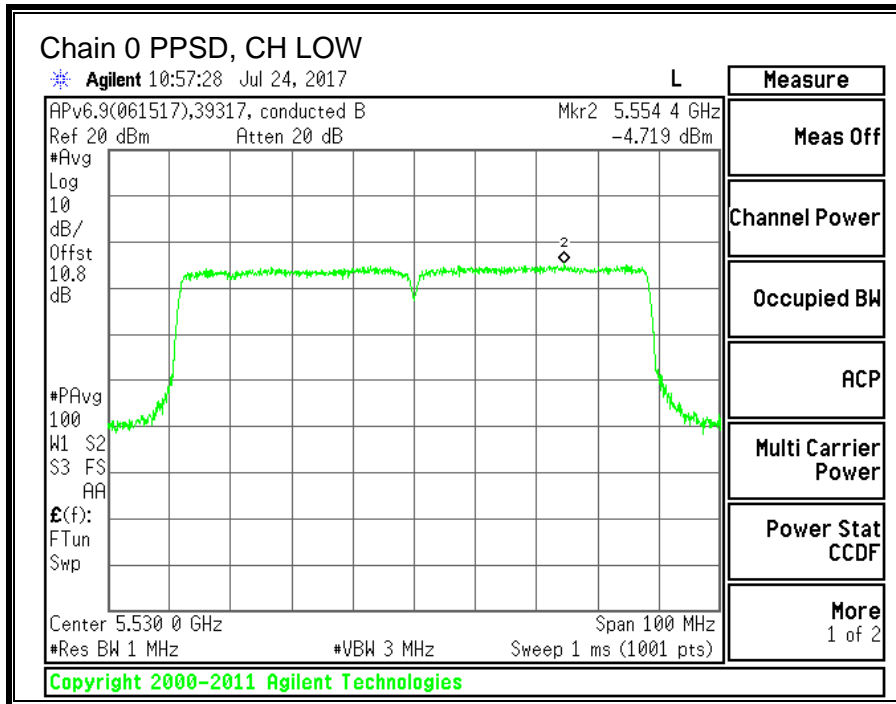

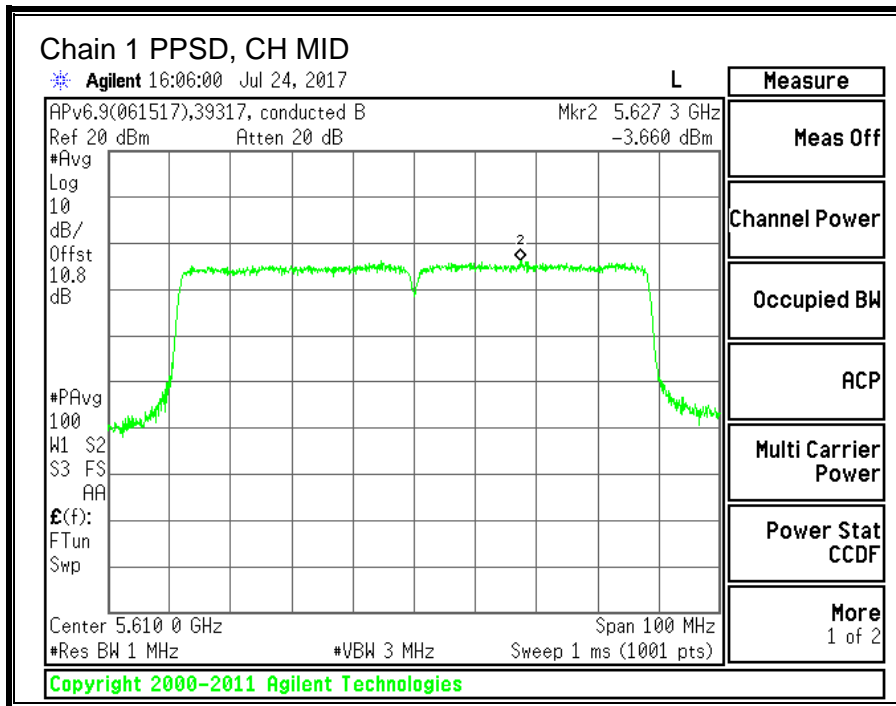
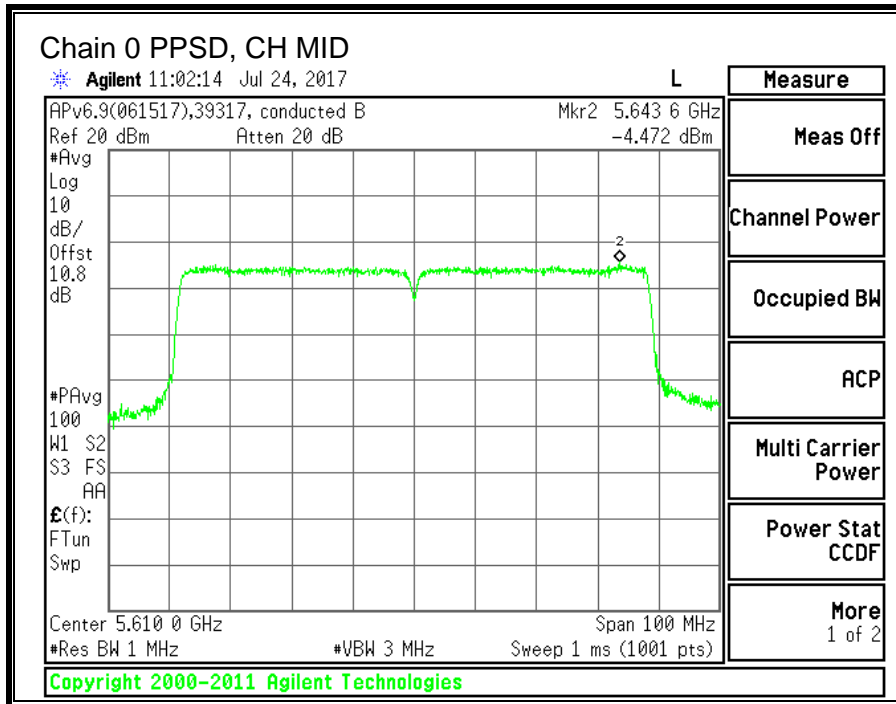

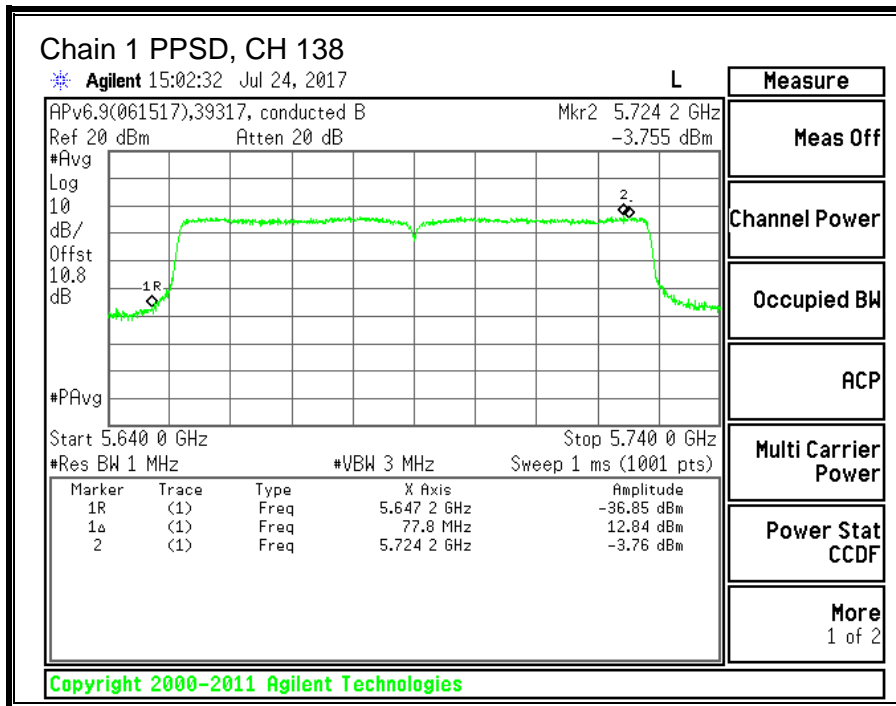
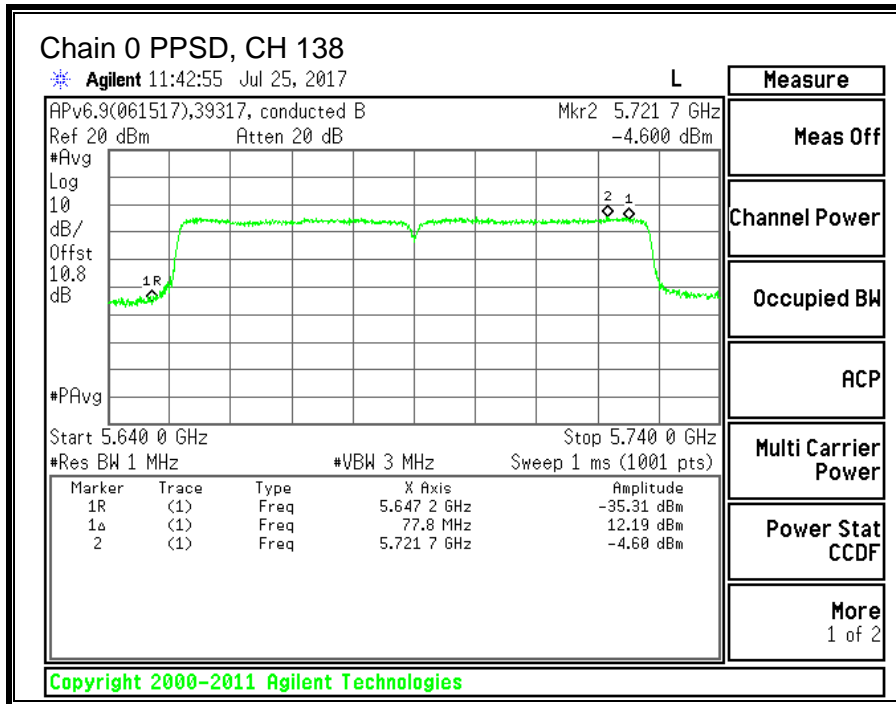

10.13. 11a 2TX CDD MIMO MODE IN THE 5.8GHz BAND

10.13.1. 6 dB BANDWIDTH

LIMITS

FCC §15.407 (e)

The minimum 6 dB bandwidth shall be at least 500 kHz.

RESULTS

Channel	Frequency	6 dB BW Chain 0 (MHz)	6 dB BW Chain 1 (MHz)	Minimum Limit (MHz)
Low	5745	16.40	16.45	0.5
Mid	5785	16.40	16.40	0.5
High	5825	16.40	16.40	0.5

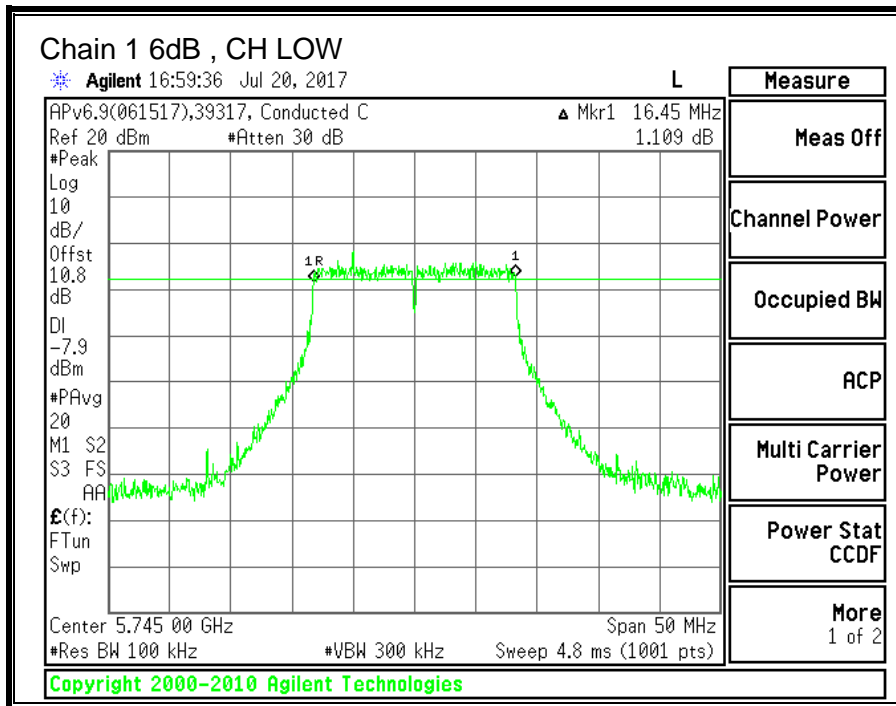
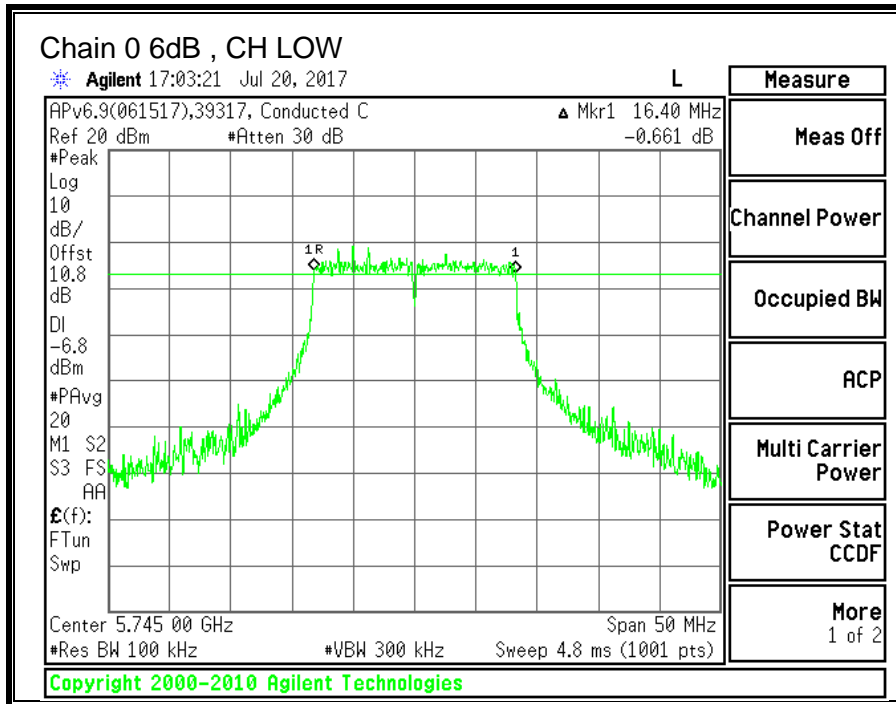

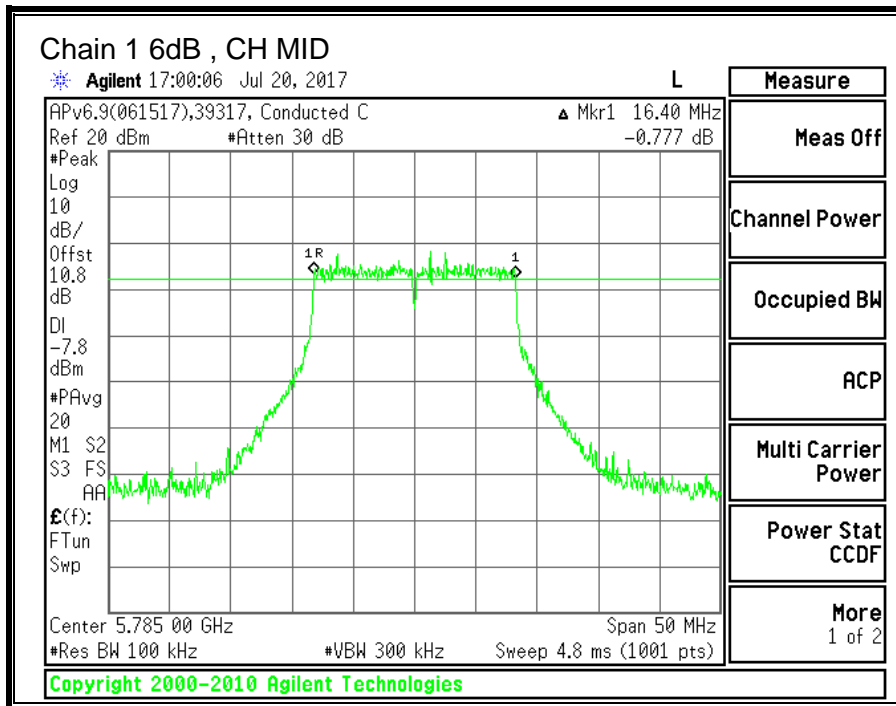
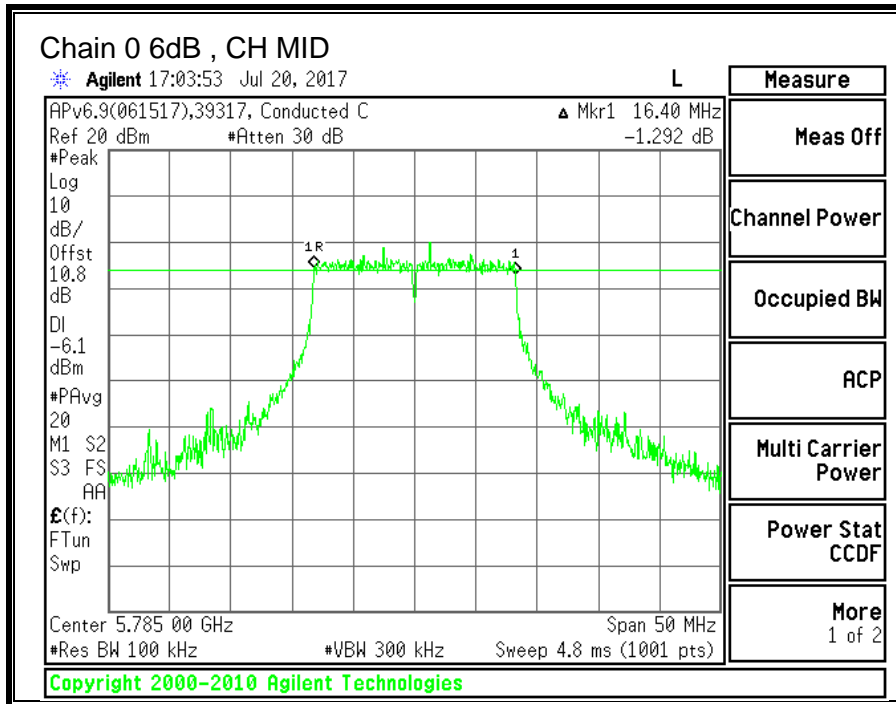

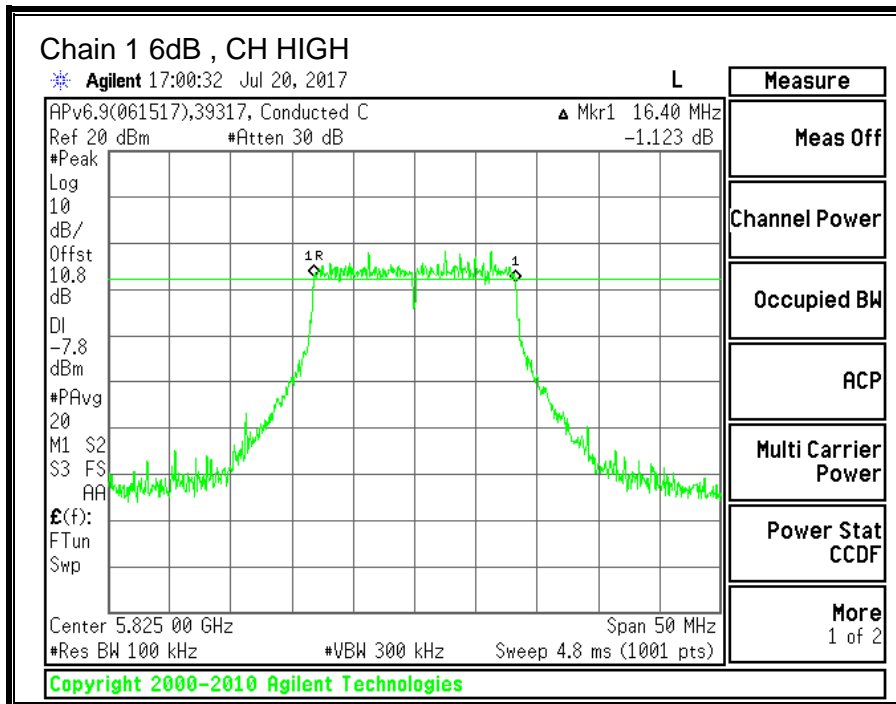
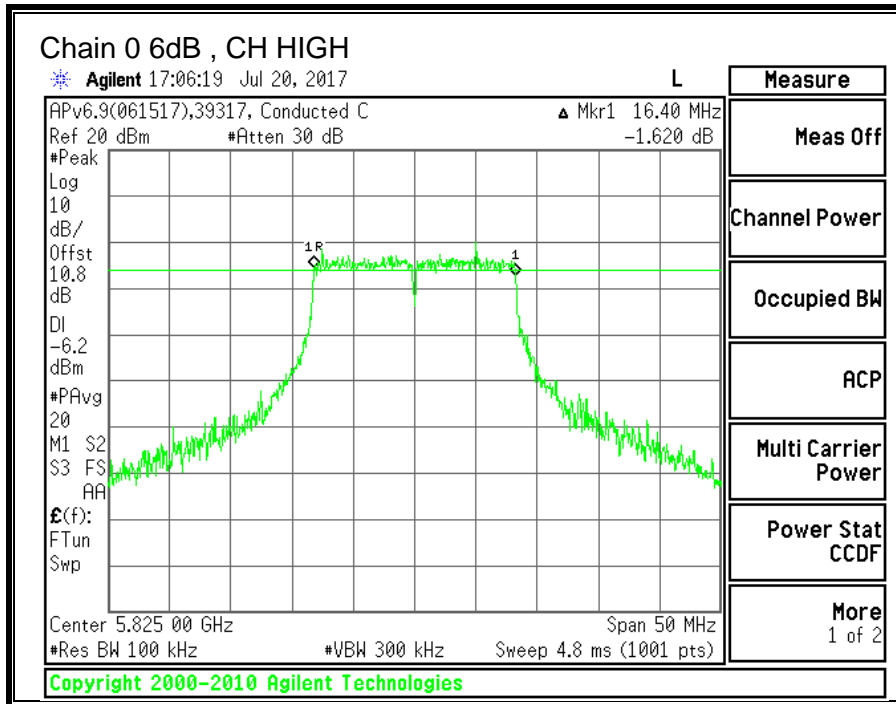

10.13.2. 99% BANDWIDTH

LIMITS

None; for reporting purposes only.

RESULTS

Channel	Frequency	99% BW Chain 0 (MHz)	99% BW Chain 1 (MHz)
Low	5745	16.1867	16.4260
Mid	5785	16.4330	16.3329
High	5825	16.1359	16.0817

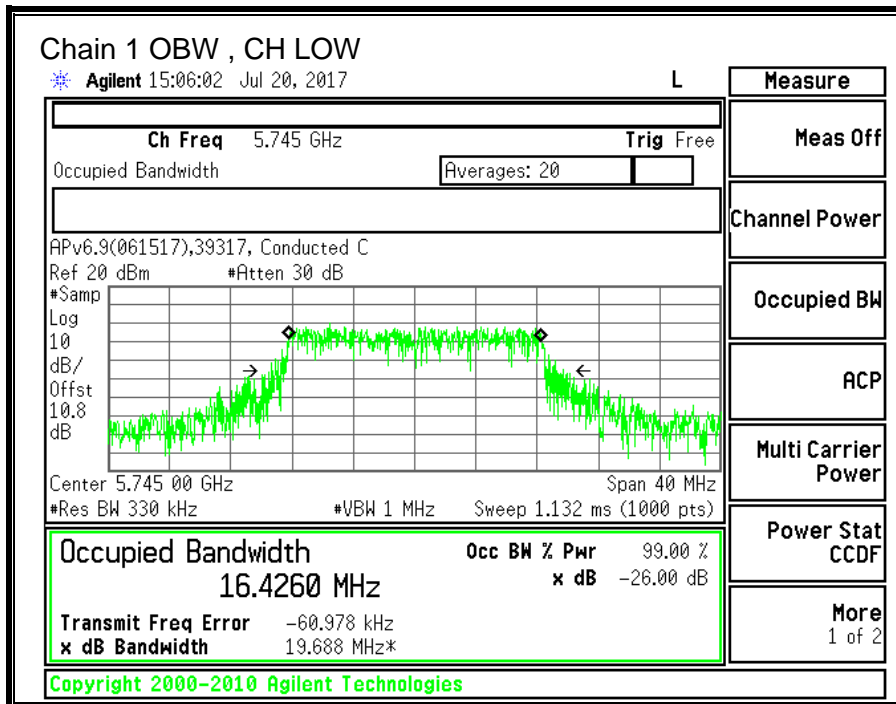
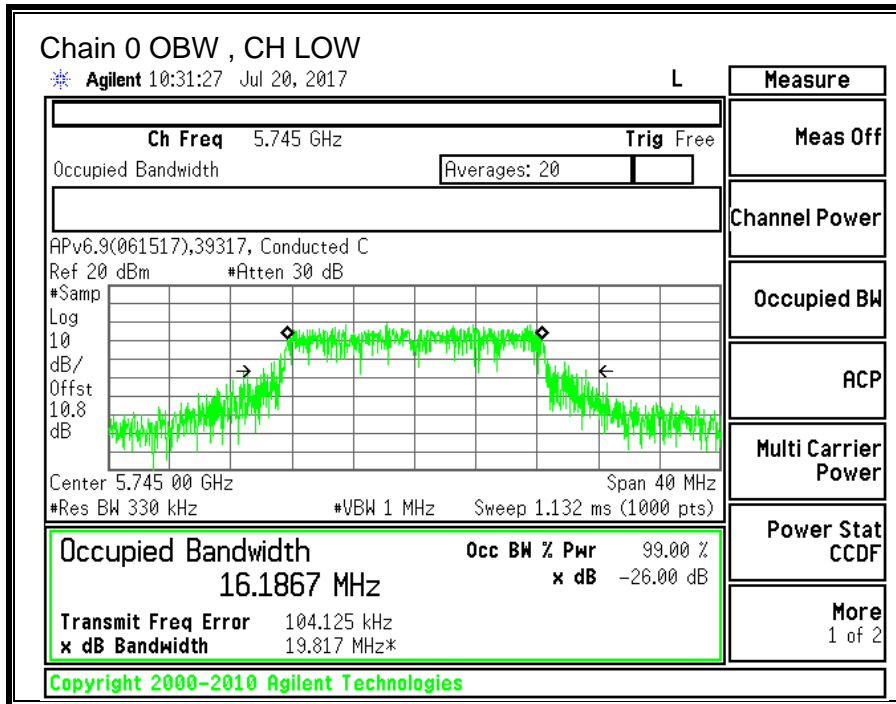

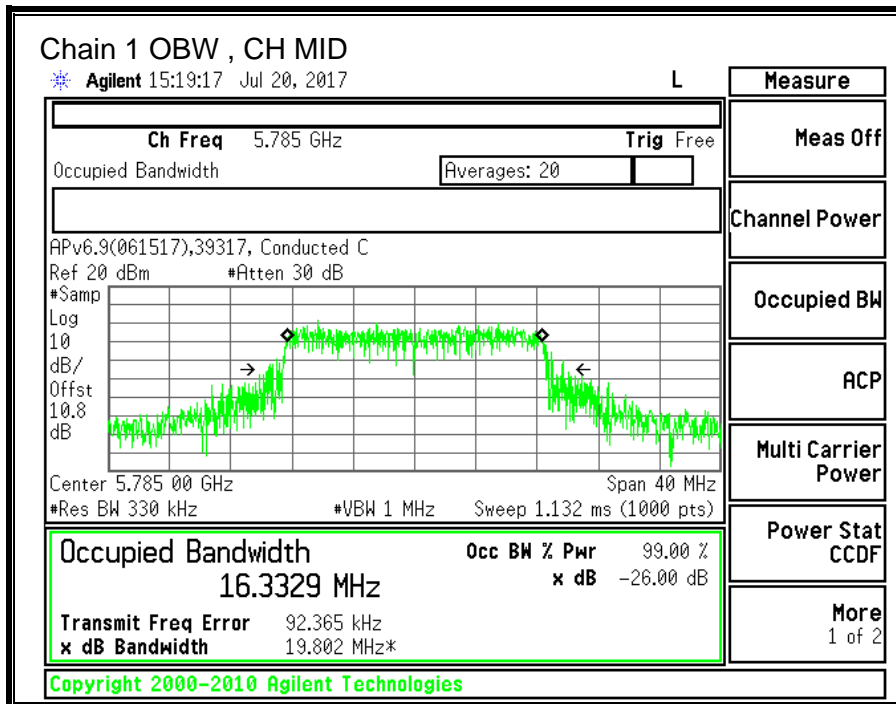
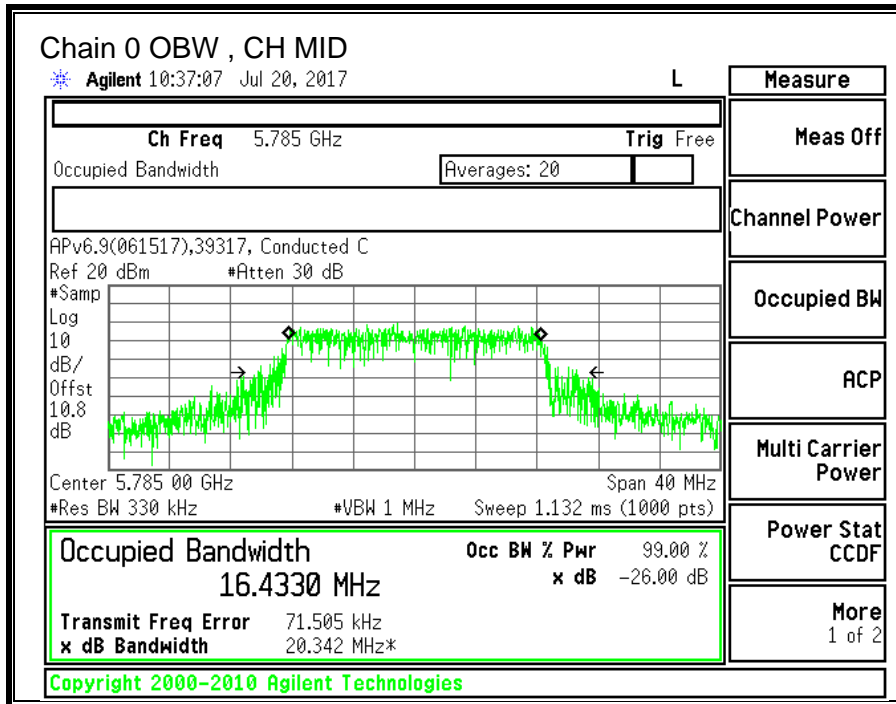

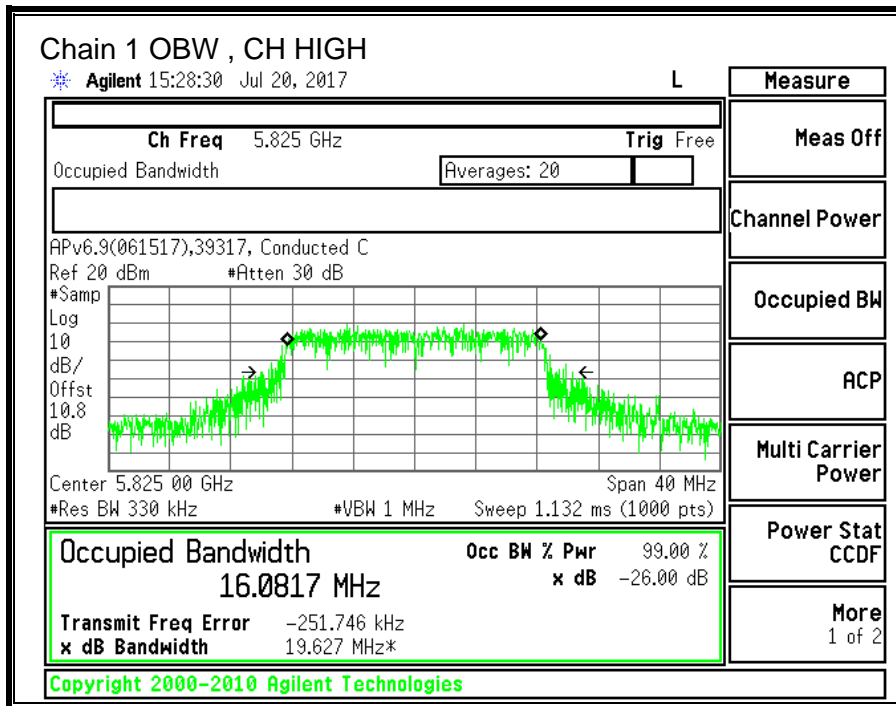
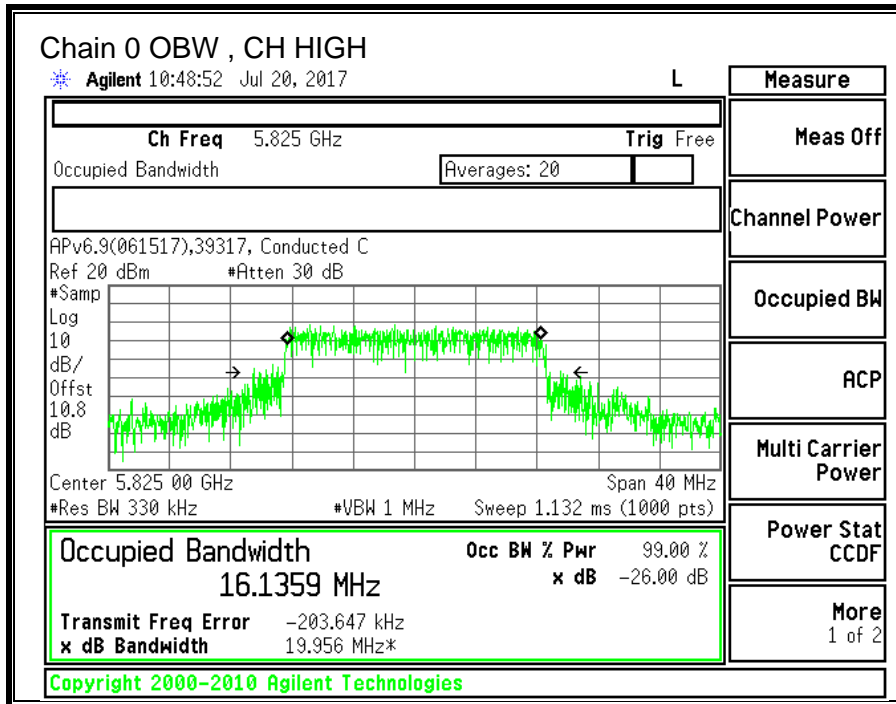

10.13.3. OUTPUT POWER AND PSD

LIMITS

FCC §15.407 (a) (3)

For the band 5.725-5.85 GHz, the maximum conducted output power over the frequency band of operation shall not exceed 1 W. In addition, the maximum power spectral density shall not exceed 30 dBm in any 500-kHz band. If transmitting antennas of directional gain greater than 6 dBi are used, both the maximum conducted output power and the maximum power spectral density shall be reduced by the amount in dB that the directional gain of the antenna exceeds 6 dBi.

TEST PROCEDURE

Measurements perform using a wideband gated RF power meter provided that the gate parameters are adjusted such that the power is measured only when the EUT is transmitting at its maximum power control level. Since the measurement is made only during the ON time of the transmitter, no duty cycle correction factor is required.

DIRECTIONAL ANTENNA GAIN

For power, the TX chains are uncorrelated and the antenna gain is unequal among the chains. The directional gain is:

5725-5850 MHz

Chain 0 Antenna Gain (dBi)	Chain 1 Antenna Gain (dBi)	Uncorrelated Chains Directional Gain (dBi)
-2.10	-0.30	-1.11

For PSD the TX chains are correlated and the antenna gain is unequal among the chains. The directional gain is:

5725-5850 MHz

Chain 0 Antenna Gain (dBi)	Chain 1 Antenna Gain (dBi)	Correlated Chains Directional Gain (dBi)
-2.10	-0.30	1.86

RESULTS

ID:	39317	Date:	07/21/17
------------	-------	--------------	----------

Antenna Gain and Limit

Channel	Frequency (MHz)	Directional Gain for Power (dBi)	Directional Gain for PSD (dBi)	Power Limit (dBm)	Power Limit (dBm)
Low	5745	-1.11	1.86	30.00	30.00
Mid	5785	-1.11	1.86	30.00	30.00
High	5825	-1.11	1.86	30.00	30.00

Duty Cycle CF (dB)	0.24	Included in Calculations of Corr'd PSD
---------------------------	------	---

Output Power Results

Channel	Frequency (MHz)	Chain 0 Meas Power (dBm)	Chain 1 Meas Power (dBm)	Total Corr'd Power (dBm)	Power Limit (dBm)	Power Margin (dB)
Low	5745	13.06	13.48	16.29	30.00	-13.71
Mid	5785	13.01	13.38	16.21	30.00	-13.79
High	5825	12.79	13.39	16.11	30.00	-13.89

PSD Results

Channel	Frequency (MHz)	Chain 0 Meas PSD (dBm)	Chain 1 Meas PSD (dBm)	Total Corr'd PSD (dBm)	PSD Limit (dBm)	PSD Margin (dB)
Low	5745	-0.830	-0.030	2.84	30.00	-27.16
Mid	5785	-1.000	-0.684	2.41	30.00	-27.59
High	5825	-0.939	-0.167	2.71	30.00	-27.29

Note: the power readings above were measured with gated method, and the measurement was taken only during the ON time. No duty cycle correction was necessary.

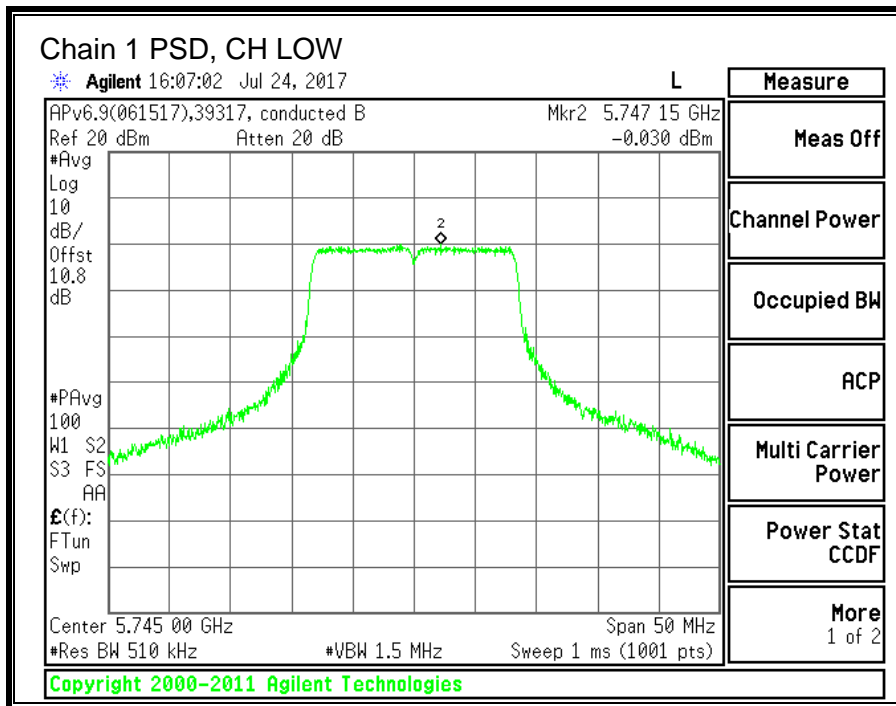
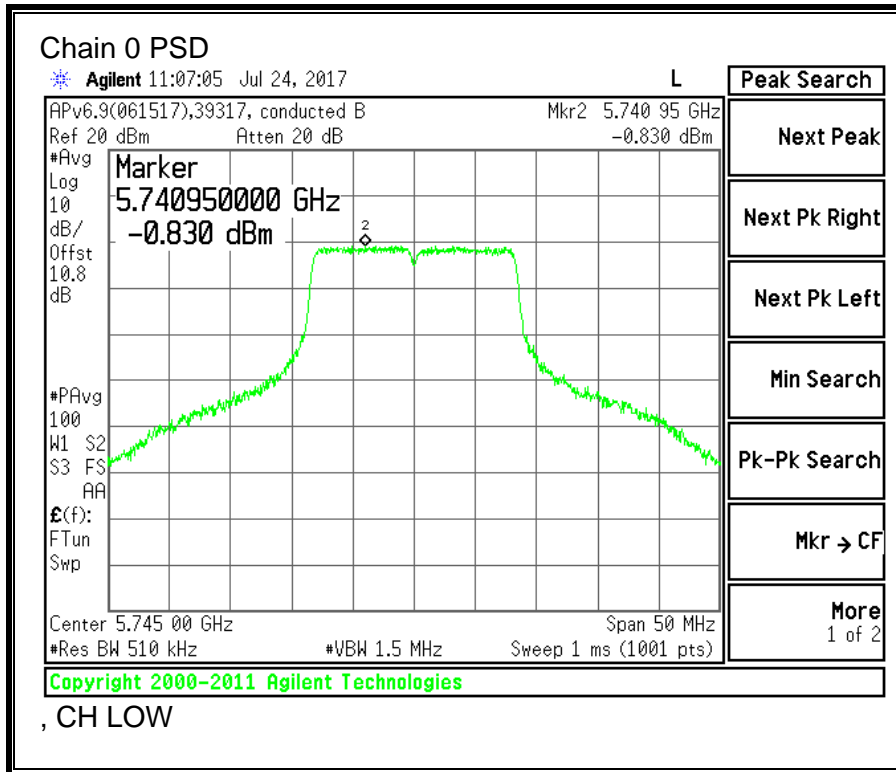

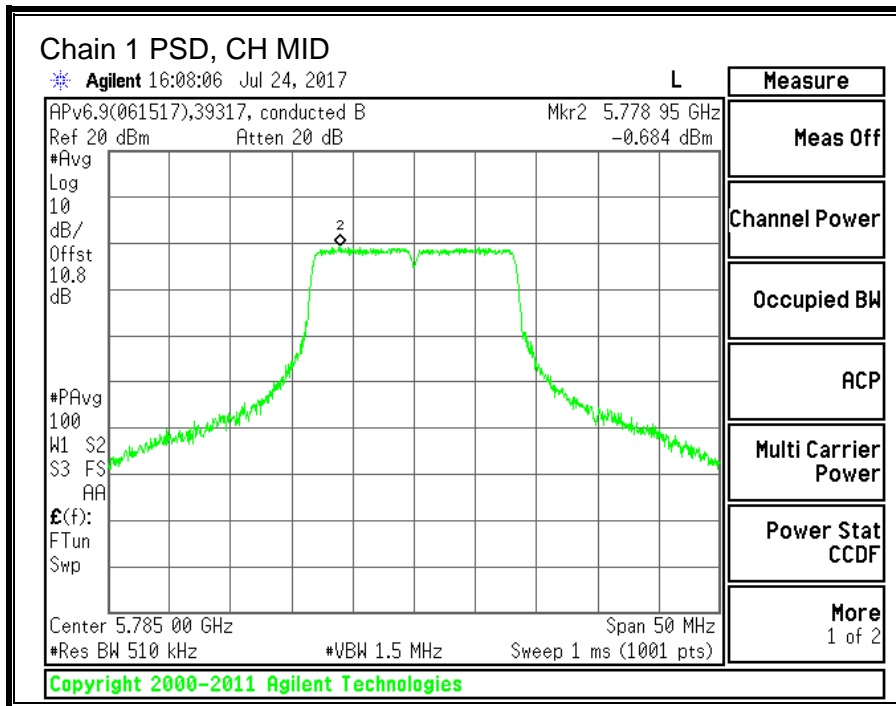
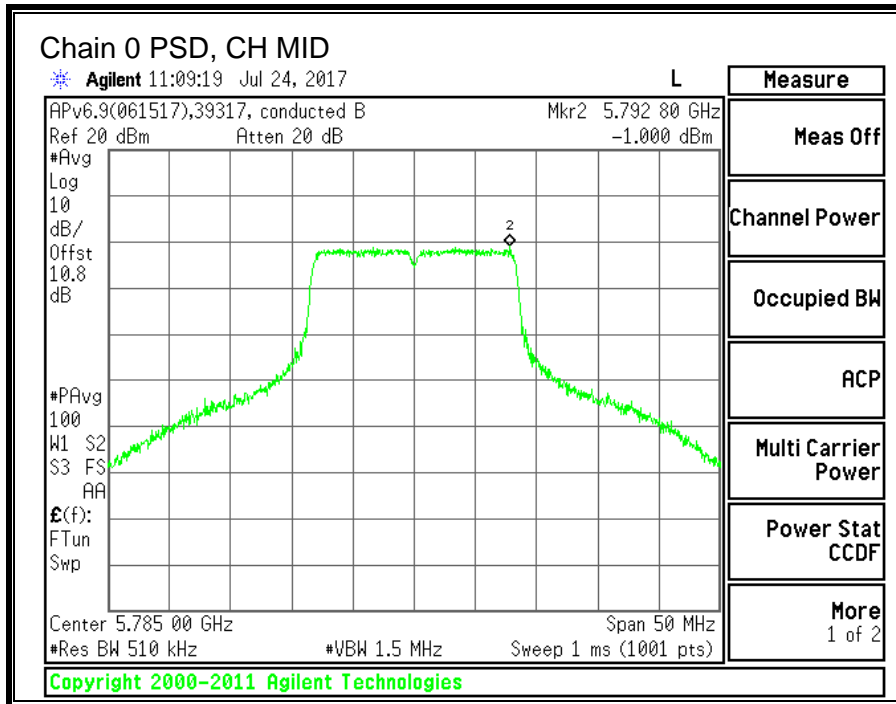

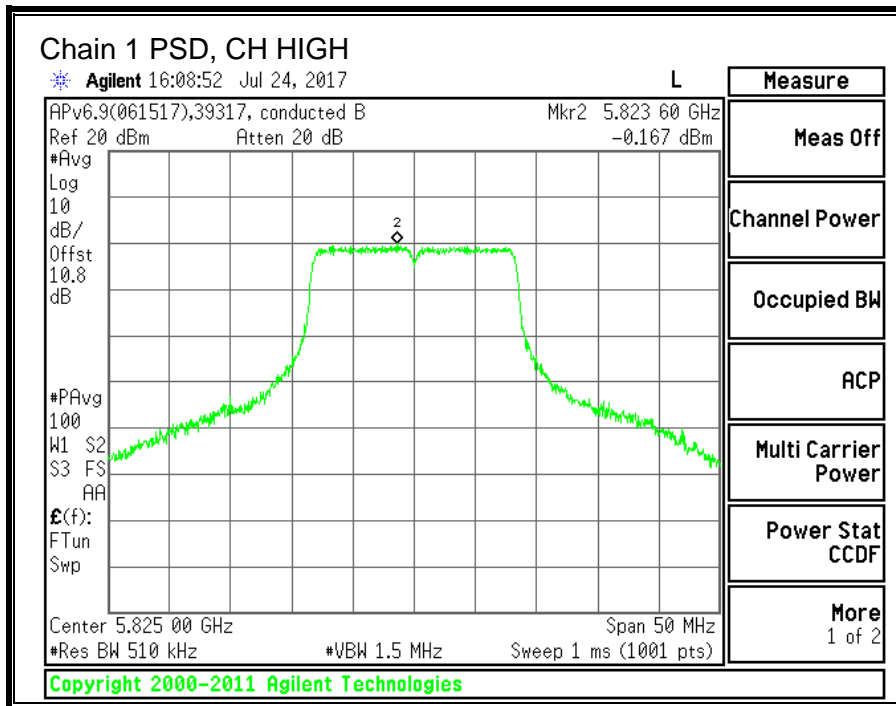
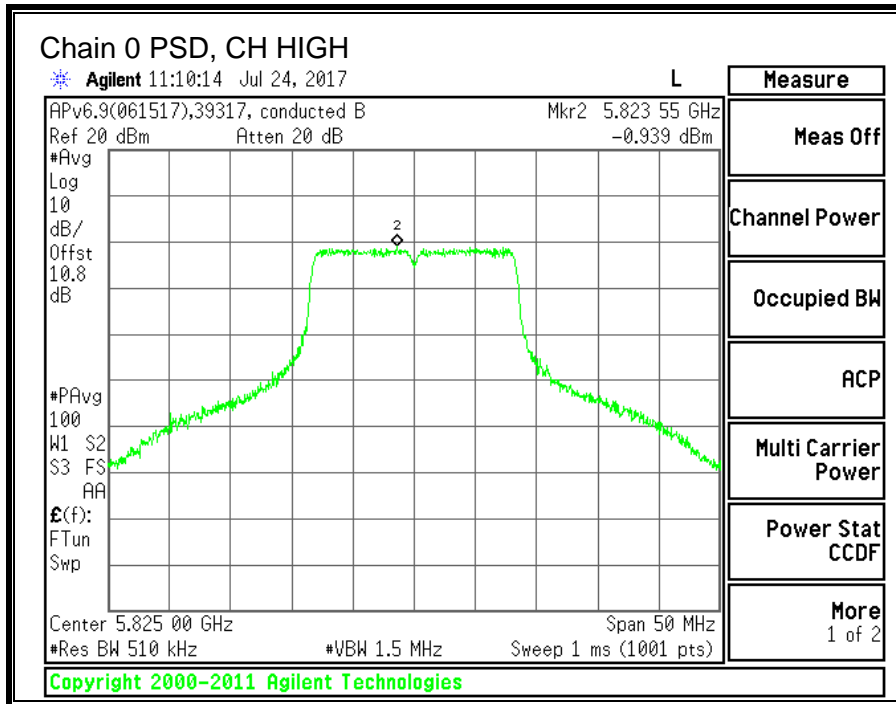

10.14. 11n HT20 2TX CDD MIMO MODE IN THE 5.8GHz BAND

10.14.1. 6 dB BANDWIDTH

LIMITS

FCC §15.407 (e)

The minimum 6 dB bandwidth shall be at least 500 kHz.

RESULTS

Channel	Frequency	6 dB BW Chain 0 (MHz)	6 dB BW Chain 1 (MHz)	Minimum Limit (MHz)
Low	5745	17.60	17.70	0.5
Mid	5785	17.55	17.65	0.5
High	5825	17.65	17.65	0.5

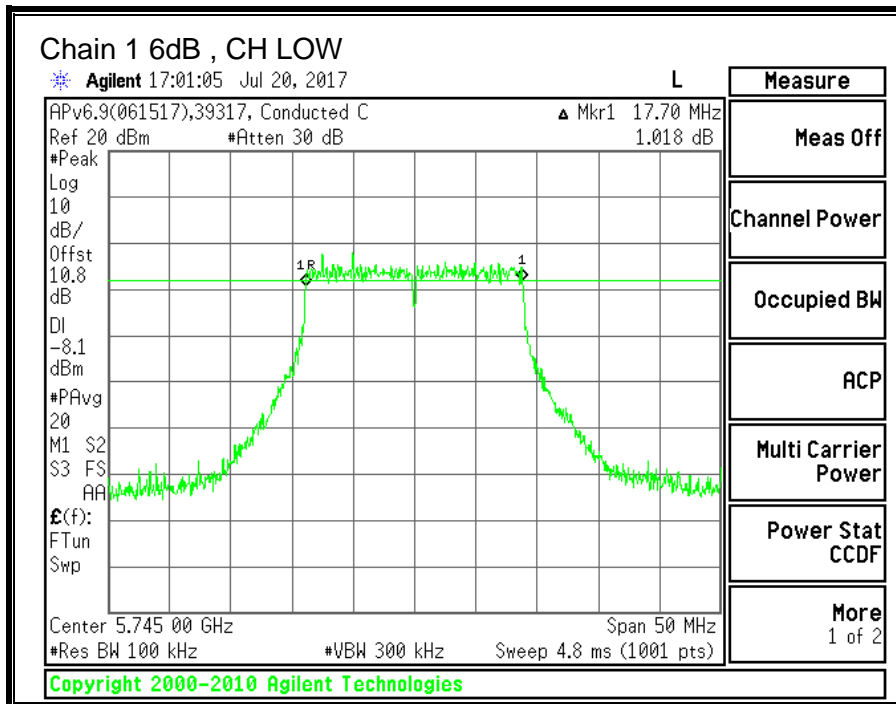
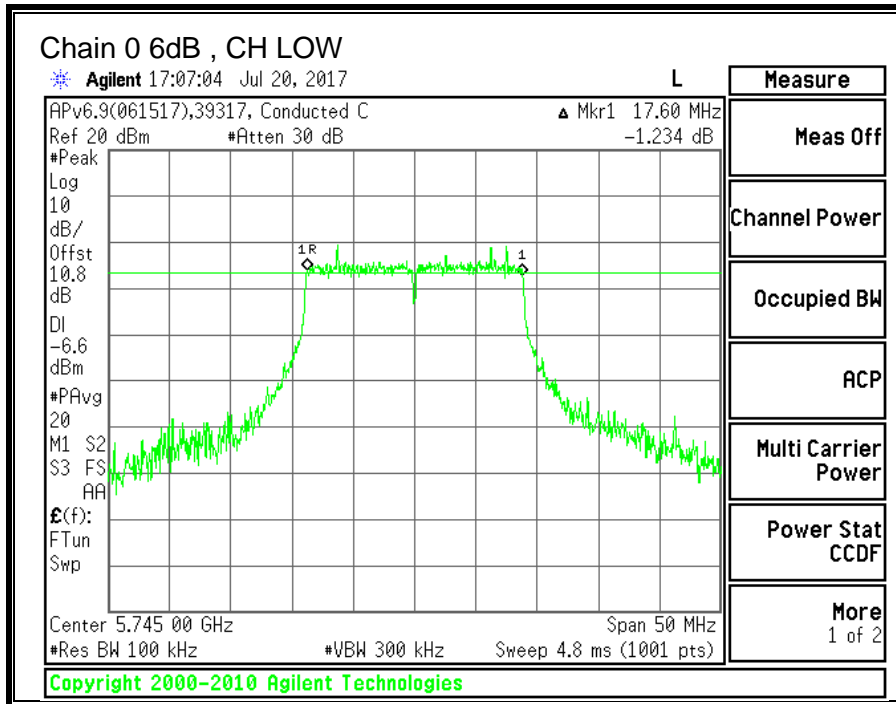

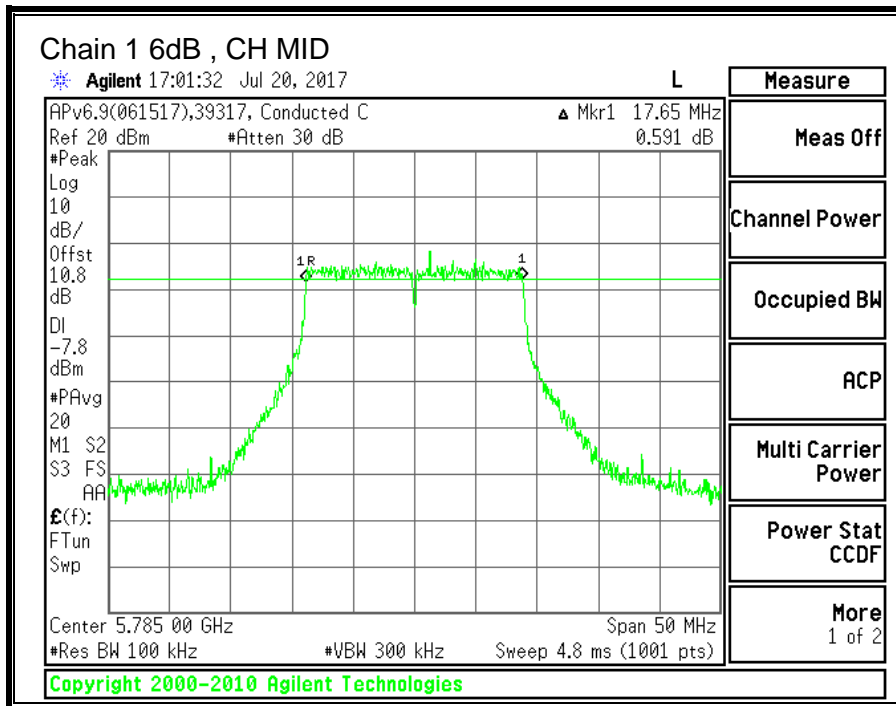
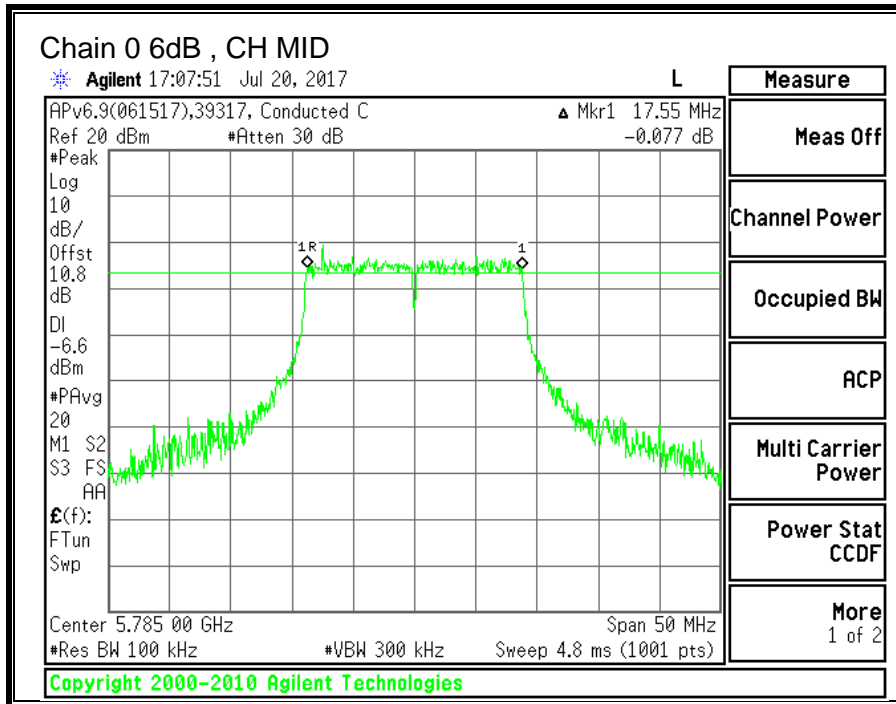

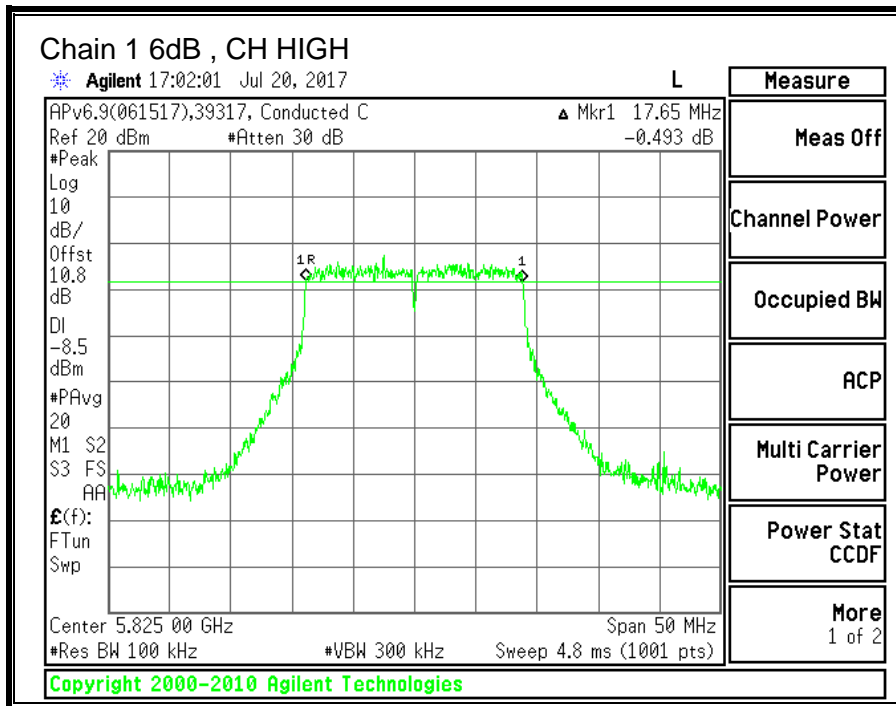
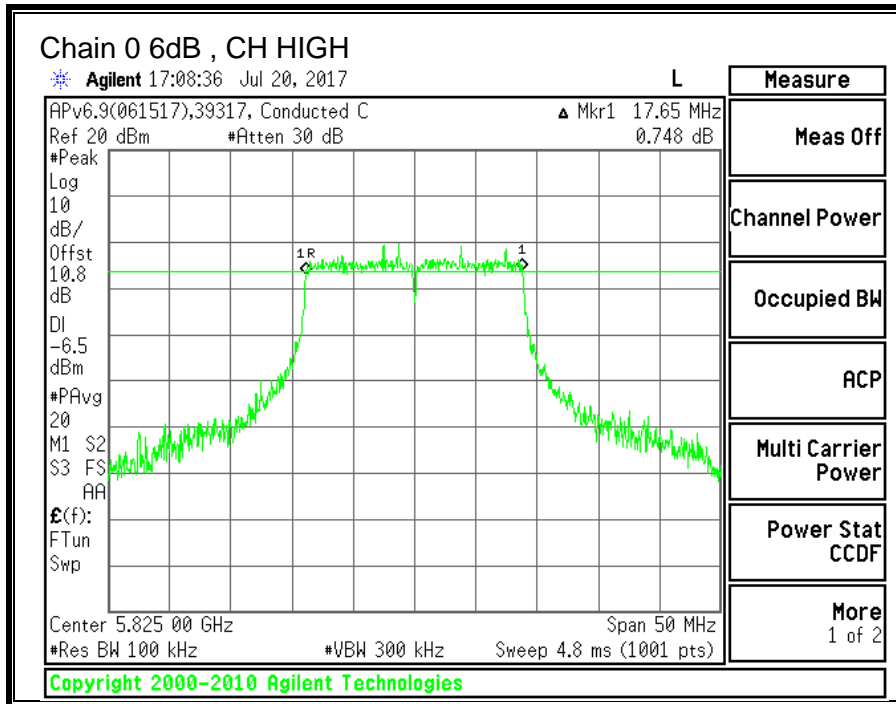

10.14.2. 99% BANDWIDTH

LIMITS

None; for reporting purposes only.

RESULTS

Channel	Frequency	99% BW Chain 0 (MHz)	99% BW Chain 1 (MHz)
Low	5745	17.4308	17.7317
Mid	5785	17.7317	17.6676
High	5825	17.7698	17.6721

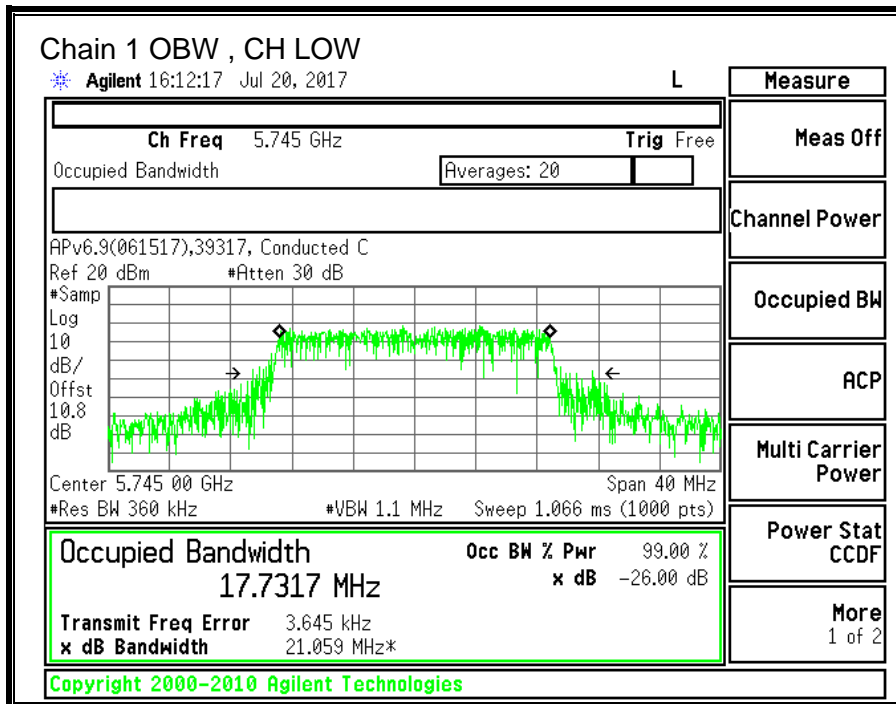
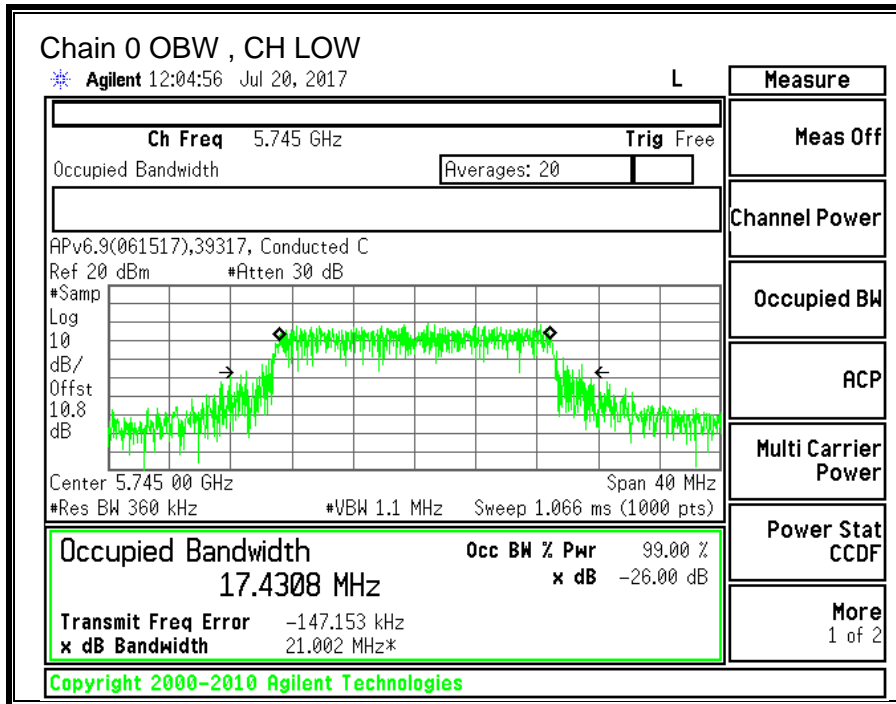

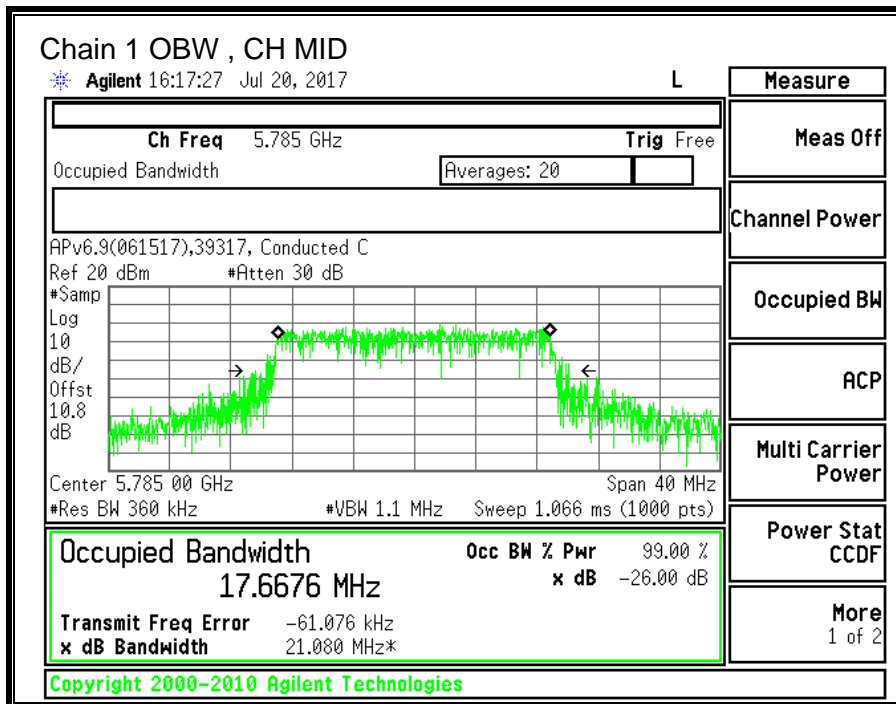
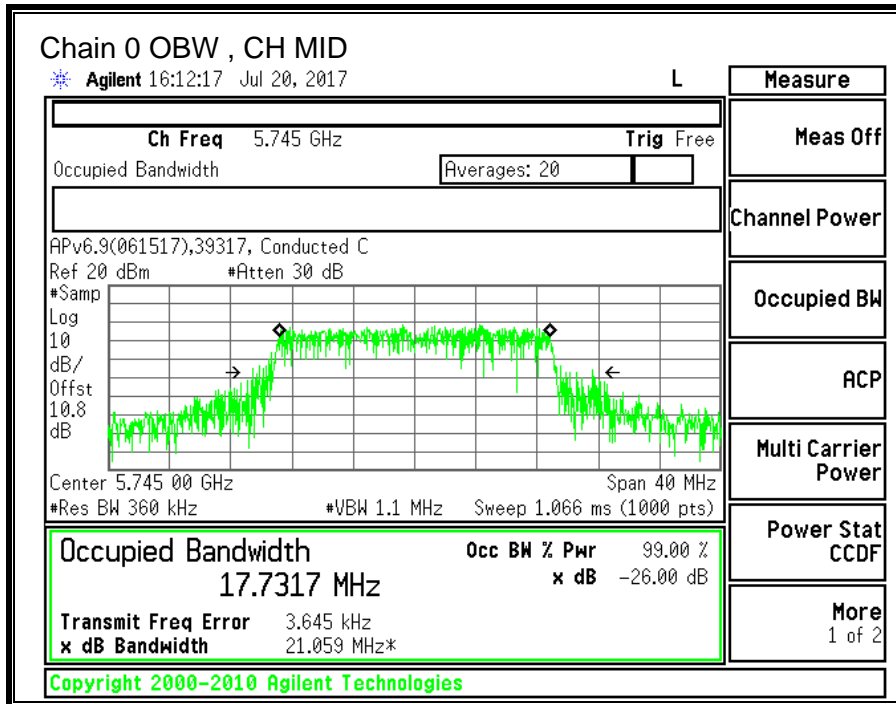

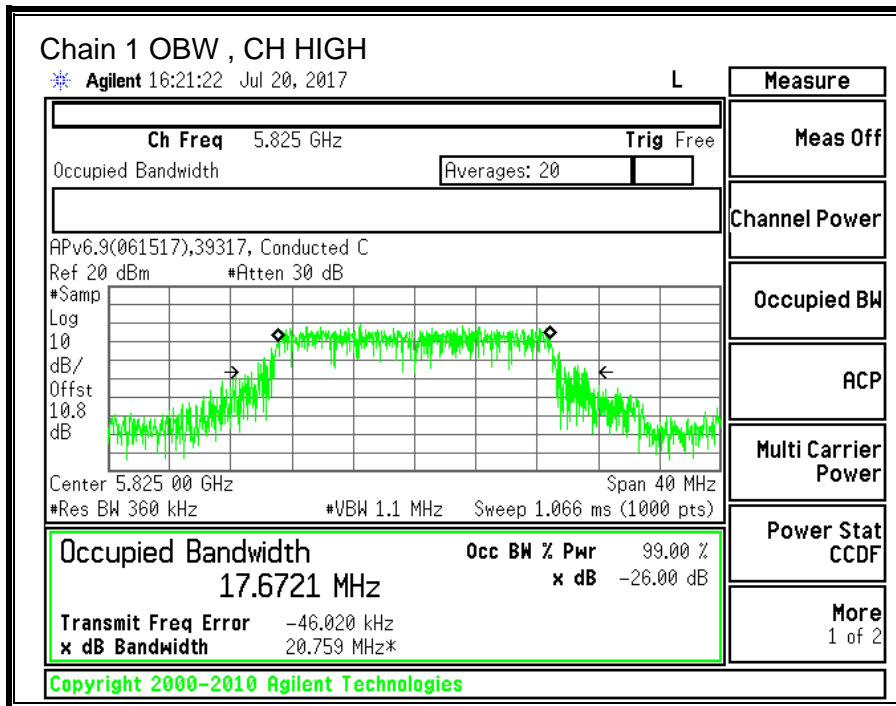
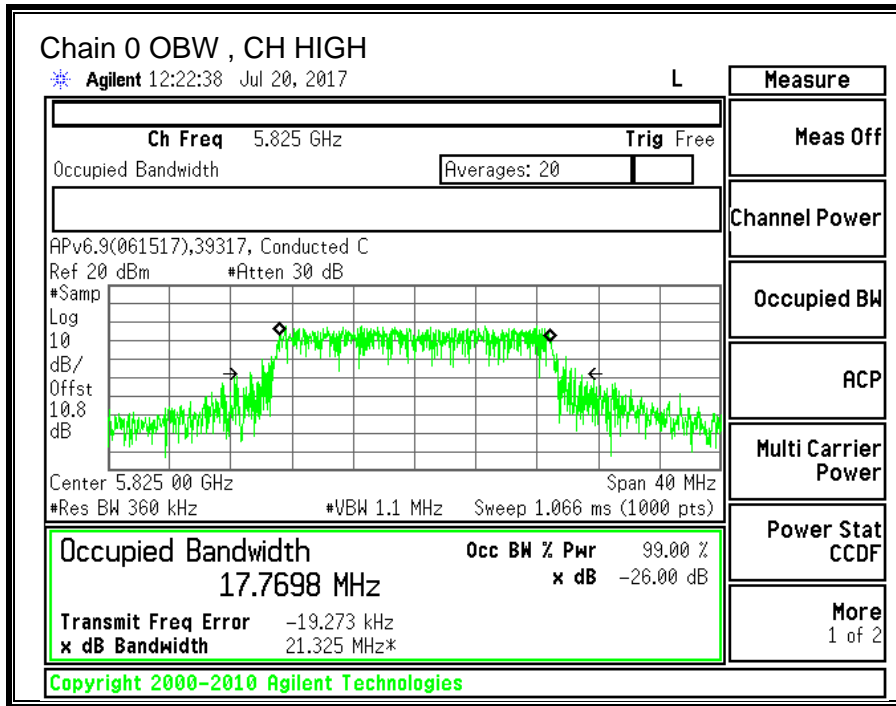

10.14.3. OUTPUT POWER AND PSD

LIMITS

FCC §15.407 (a) (3)

For the band 5.725-5.85 GHz, the maximum conducted output power over the frequency band of operation shall not exceed 1 W. In addition, the maximum power spectral density shall not exceed 30 dBm in any 500-kHz band. If transmitting antennas of directional gain greater than 6 dBi are used, both the maximum conducted output power and the maximum power spectral density shall be reduced by the amount in dB that the directional gain of the antenna exceeds 6 dBi.

TEST PROCEDURE

Measurements perform using a wideband gated RF power meter provided that the gate parameters are adjusted such that the power is measured only when the EUT is transmitting at its maximum power control level. Since the measurement is made only during the ON time of the transmitter, no duty cycle correction factor is required.

DIRECTIONAL ANTENNA GAIN

For power, the TX chains are uncorrelated and the antenna gain is unequal among the chains. The directional gain is:

5725-5850 MHz

Chain 0 Antenna Gain (dBi)	Chain 1 Antenna Gain (dBi)	Uncorrelated Chains Directional Gain (dBi)
-2.10	-0.30	-1.11

For PSD the TX chains are correlated and the antenna gain is unequal among the chains. The directional gain is:

5725-5850 MHz

Chain 0 Antenna Gain (dBi)	Chain 1 Antenna Gain (dBi)	Correlated Chains Directional Gain (dBi)
-2.10	-0.30	1.86

RESULTS

ID:	39317	Date:	07/21/17
------------	-------	--------------	----------

Antenna Gain and Limit

Channel	Frequency (MHz)	Directional Gain for Power (dBi)	Directional Gain for PSD (dBi)	Power Limit (dBm)	Power Limit (dBm)
Low	5745	-1.11	1.86	30.00	30.00
Mid	5785	-1.11	1.86	30.00	30.00
High	5825	-1.11	1.86	30.00	30.00

Duty Cycle CF (dB)	0.19	Included in Calculations of Corr'd PSD
---------------------------	------	---

Output Power Results

Channel	Frequency (MHz)	Chain 0 Meas Power (dBm)	Chain 1 Meas Power (dBm)	Total Corr'd Power (dBm)	Power Limit (dBm)	Power Margin (dB)
Low	5745	13.07	13.52	16.31	30.00	-13.69
Mid	5785	12.93	13.43	16.20	30.00	-13.80
High	5825	12.79	13.49	16.16	30.00	-13.84

PSD Results

Channel	Frequency (MHz)	Chain 0 Meas PSD (dBm)	Chain 1 Meas PSD (dBm)	Total Corr'd PSD (dBm)	PSD Limit (dBm)	PSD Margin (dB)
Low	5745	-0.808	-0.472	2.56	30.00	-27.44
Mid	5785	-1.617	-0.895	1.96	30.00	-28.04
High	5825	-1.514	-0.577	2.18	30.00	-27.82

Note: the power readings above were measured with gated method, and the measurement was taken only during the ON time. No duty cycle correction was necessary.

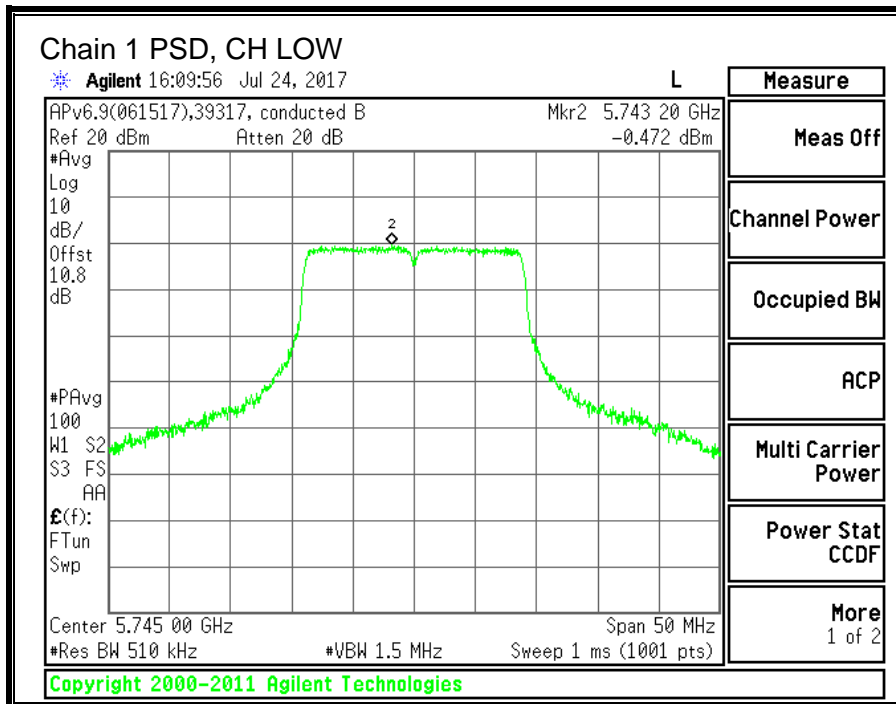
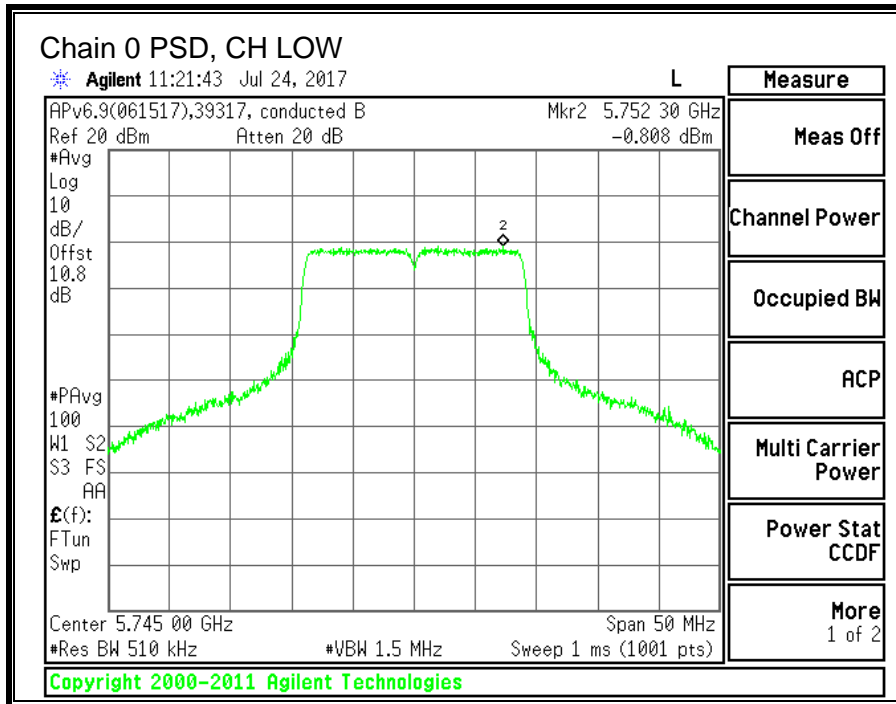

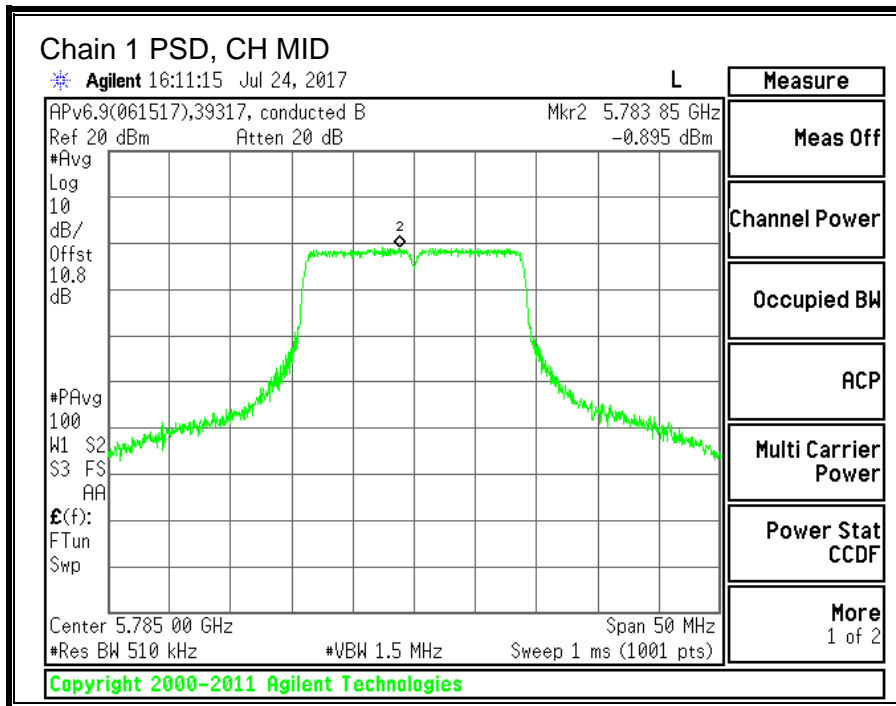
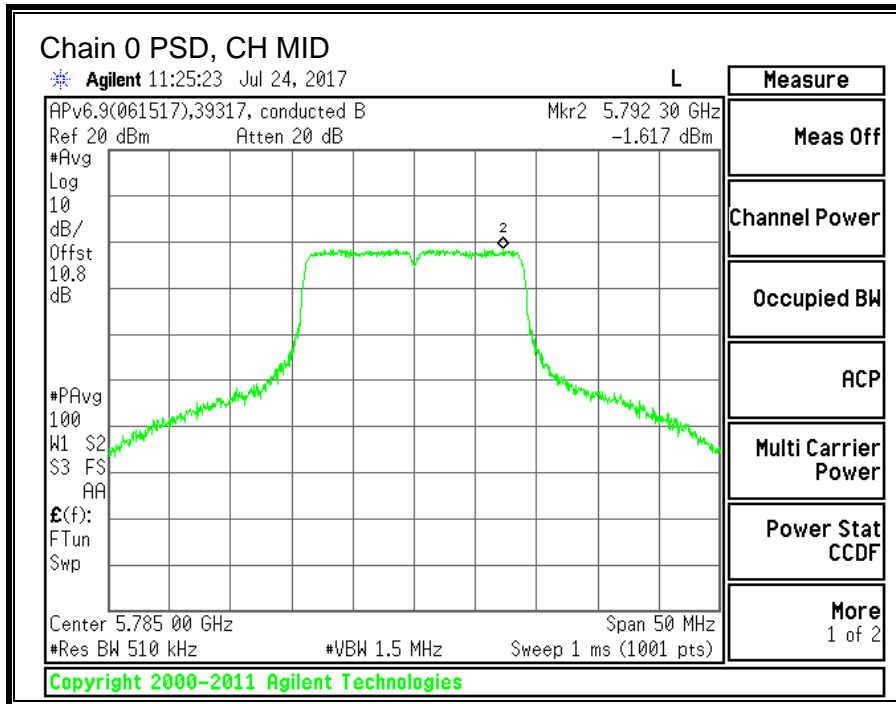

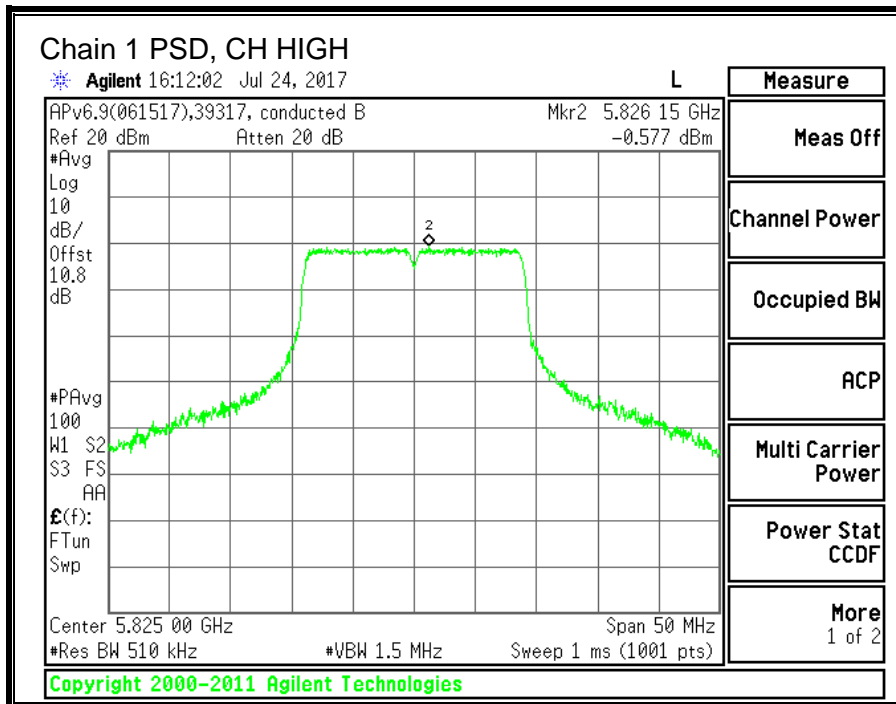
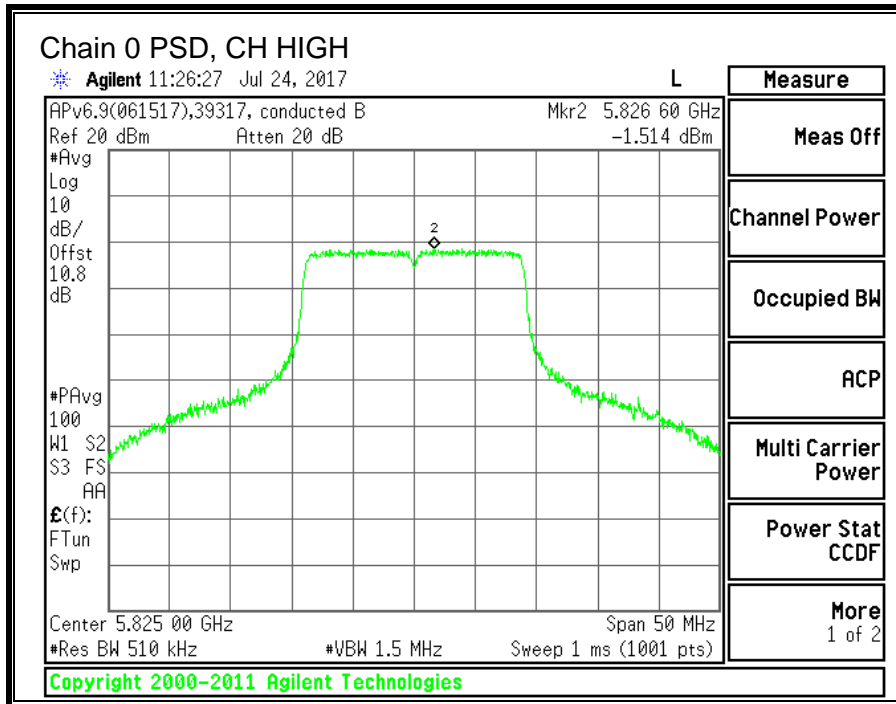

10.15. 11n HT40 2TX CDD MIMO MODE IN THE 5.8GHz BAND

10.15.1. 6 dB BANDWIDTH

LIMITS

FCC §15.407 (e)

The minimum 6 dB bandwidth shall be at least 500 kHz.

RESULTS

Channel	Frequency	6 dB BW Chain 0 (MHz)	6 dB BW Chain 1 (MHz)	Minimum Limit (MHz)
Low	5755	36.40	36.50	0.5
High	5795	36.40	36.40	0.5

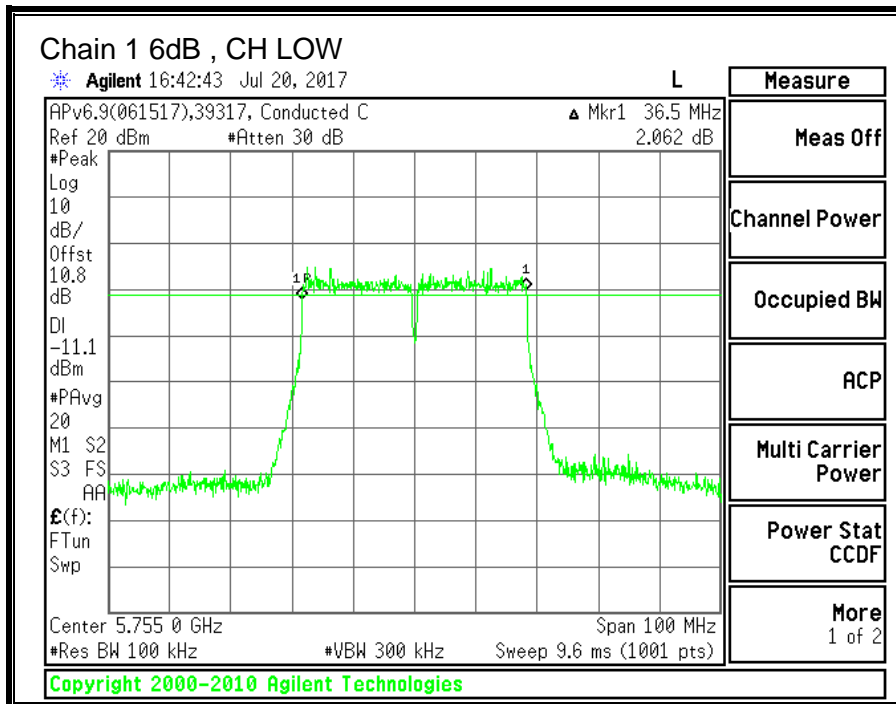
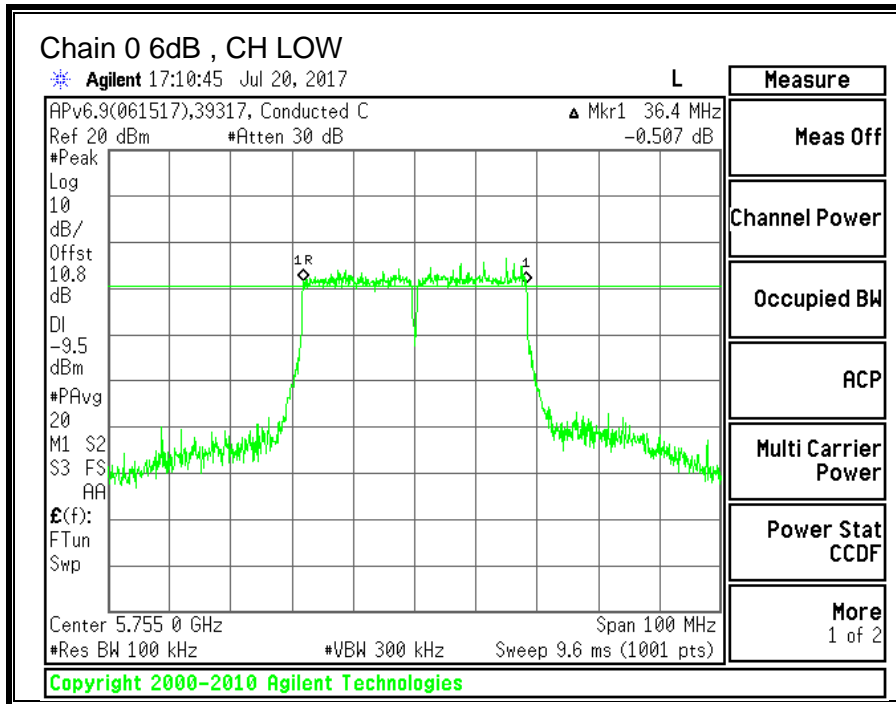

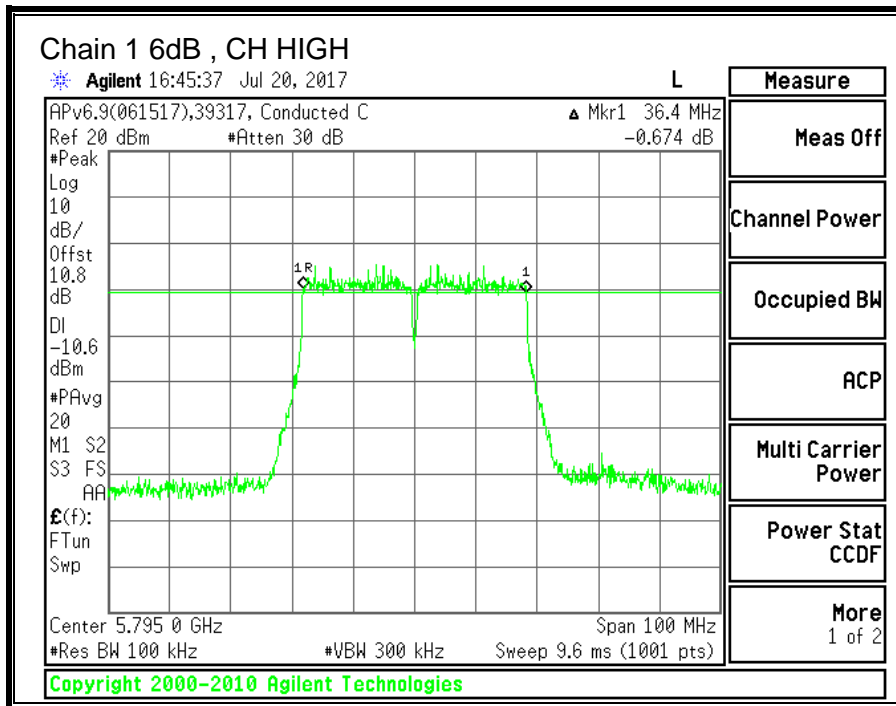
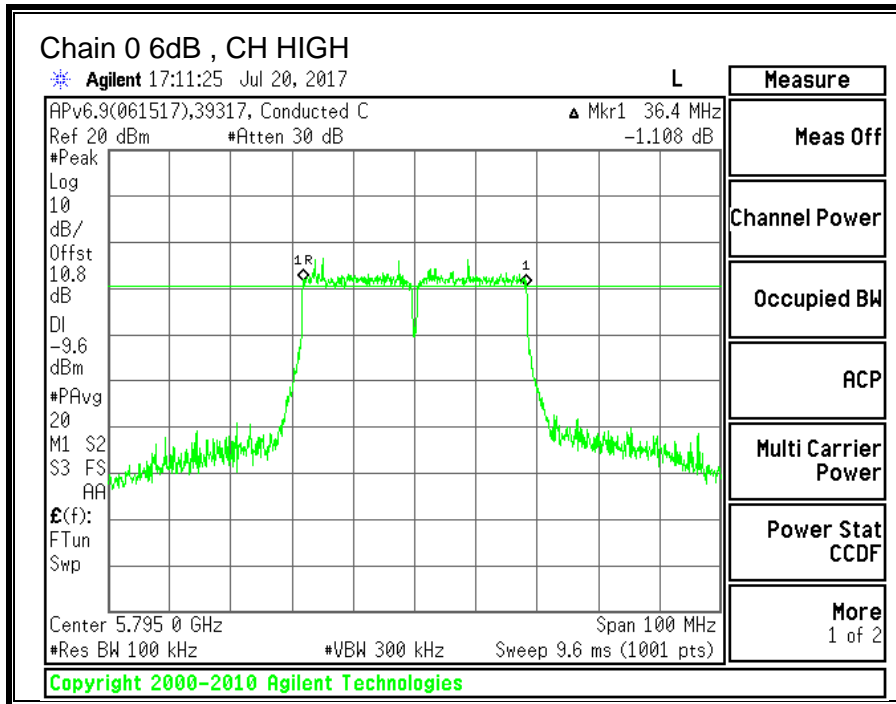

10.15.2. 99% BANDWIDTH

LIMITS

None; for reporting purposes only.

RESULTS

Channel	Frequency	99% BW Chain 0 (MHz)	99% BW Chain 1 (MHz)
Low	5755	35.8779	35.6115
High	5795	35.8220	36.2596

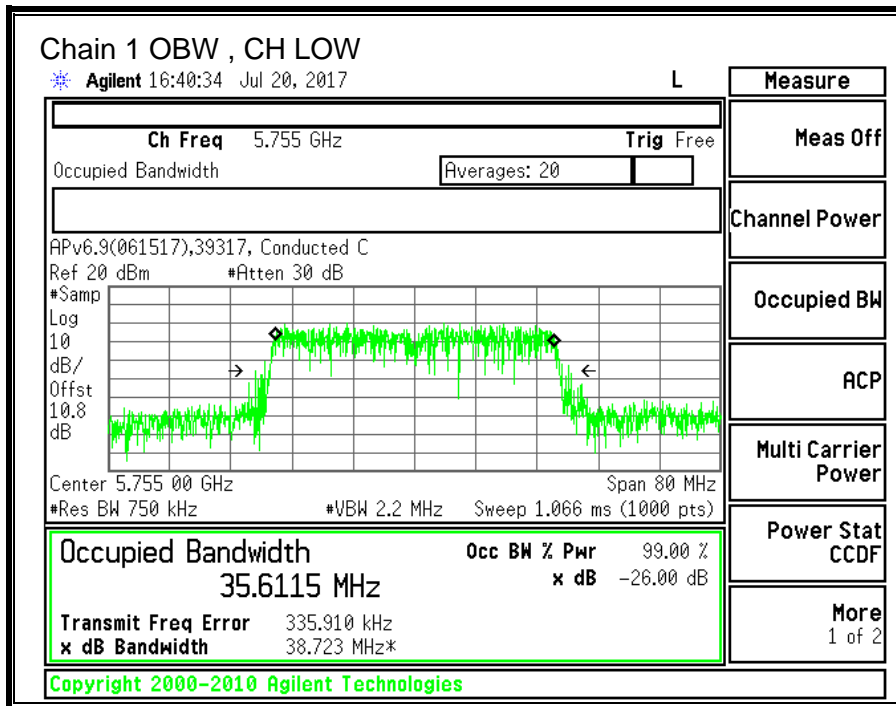
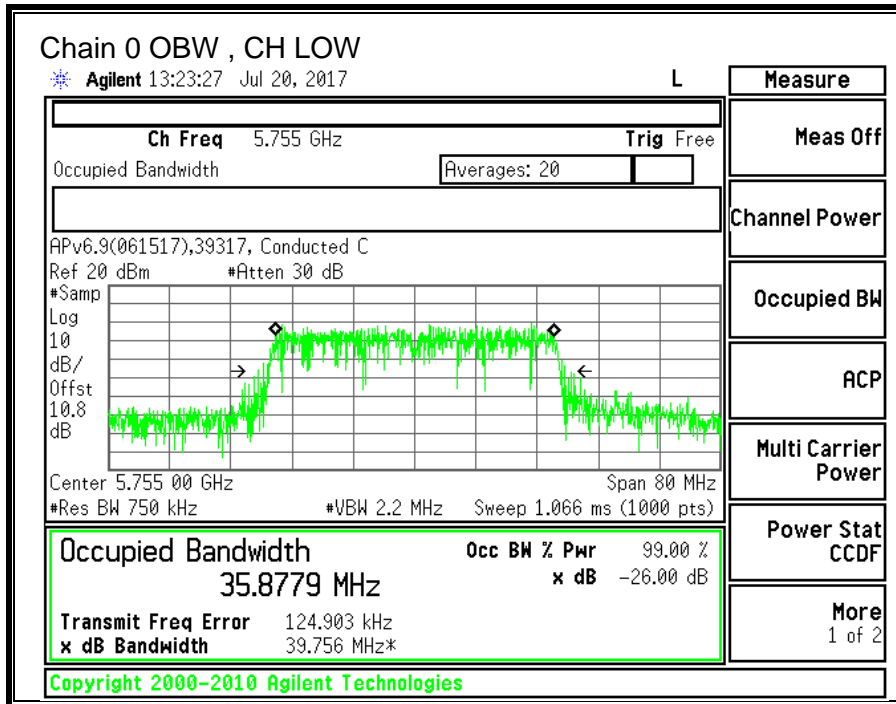

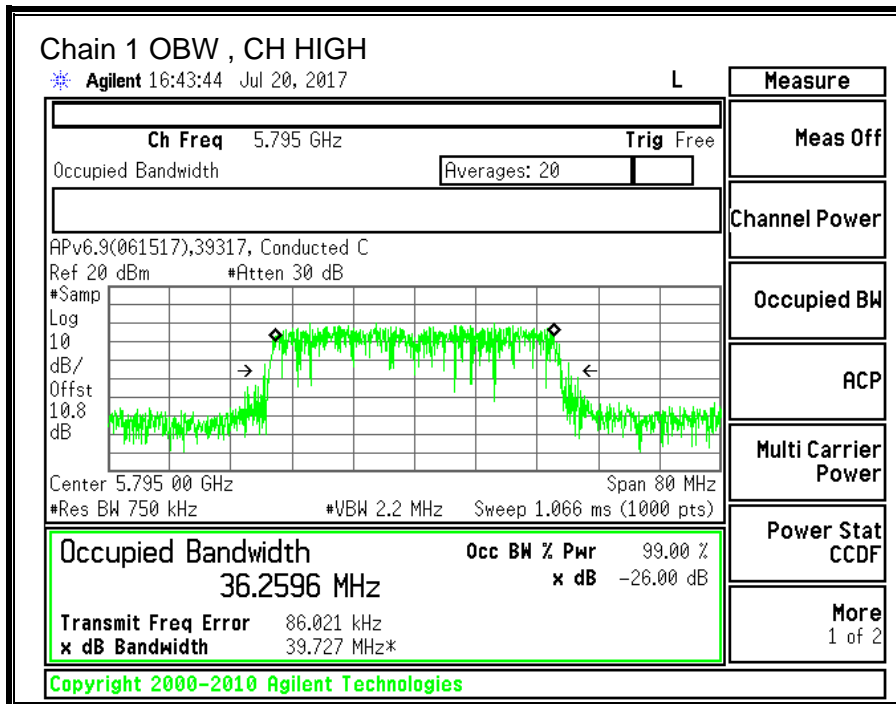
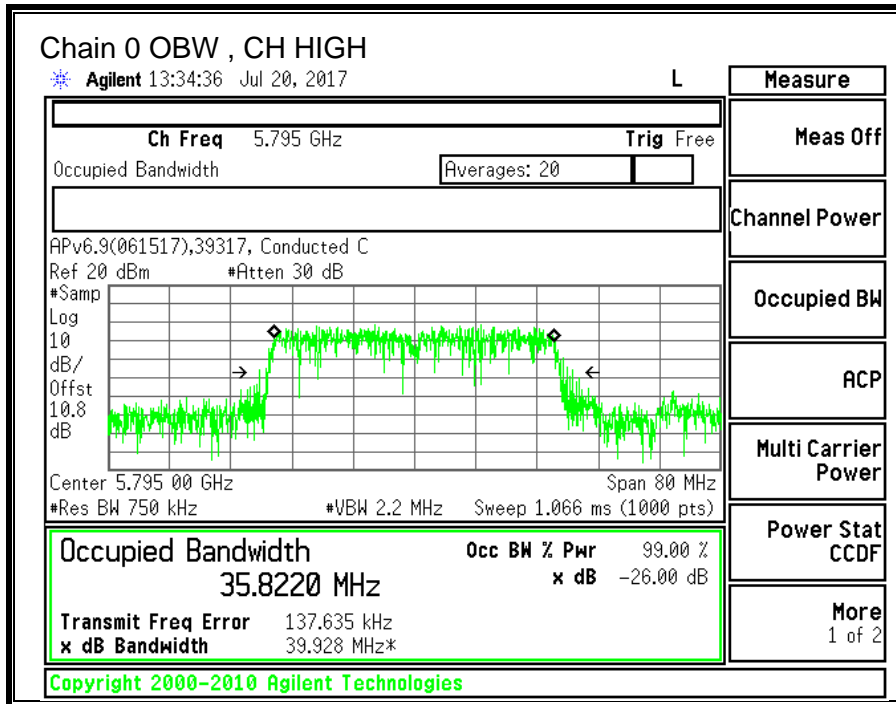

10.15.3. OUTPUT POWER AND PSD

LIMITS

FCC §15.407 (a) (3)

For the band 5.725-5.85 GHz, the maximum conducted output power over the frequency band of operation shall not exceed 1 W. In addition, the maximum power spectral density shall not exceed 30 dBm in any 500-kHz band. If transmitting antennas of directional gain greater than 6 dBi are used, both the maximum conducted output power and the maximum power spectral density shall be reduced by the amount in dB that the directional gain of the antenna exceeds 6 dBi.

TEST PROCEDURE

Measurements perform using a wideband gated RF power meter provided that the gate parameters are adjusted such that the power is measured only when the EUT is transmitting at its maximum power control level. Since the measurement is made only during the ON time of the transmitter, no duty cycle correction factor is required.

DIRECTIONAL ANTENNA GAIN

For power, the TX chains are uncorrelated and the antenna gain is unequal among the chains. The directional gain is:

5725-5850 MHz

Chain 0 Antenna Gain (dBi)	Chain 1 Antenna Gain (dBi)	Uncorrelated Chains Directional Gain (dBi)
-2.10	-0.30	-1.11

For PSD the TX chains are correlated and the antenna gain is unequal among the chains. The directional gain is:

5725-5850 MHz

Chain 0 Antenna Gain (dBi)	Chain 1 Antenna Gain (dBi)	Correlated Chains Directional Gain (dBi)
-2.10	-0.30	1.86

RESULTS

ID:	39317	Date:	07/21/17
------------	-------	--------------	----------

Antenna Gain and Limit

Channel	Frequency (MHz)	Directional Gain For Power (dBi)	Directional Gain For PSD (dBi)	Power Limit (dBm)	Power Limit (dBm)
Low	5755	-1.11	1.86	30.00	30.00
High	5795	-1.11	1.86	30.00	30.00

Duty Cycle CF (dB)	0.39	Included in Calculations of Corr'd PSD
---------------------------	------	---

Output Power Results

Channel	Frequency (MHz)	Chain 0 Meas Power (dBm)	Chain 1 Meas Power (dBm)	Total Corr'd Power (dBm)	Power Limit (dBm)	Power Margin (dB)
Low	5755	13.03	13.47	16.27	30.00	-13.73
High	5795	12.89	13.66	16.30	30.00	-13.70

Output Power Results

Channel	Frequency (MHz)	Chain 0 Meas PSD (dBm)	Chain 1 Meas PSD (dBm)	Total Corr'd PSD (dBm)	PSD Limit (dBm)	PSD Margin (dB)
Low	5755	-4.095	-3.628	-0.45	30.00	-30.45
High	5795	-4.432	-3.669	-0.63	30.00	-30.63

Note: the power readings above were measured with gated method, and the measurement was taken only during the ON time. No duty cycle correction was necessary.

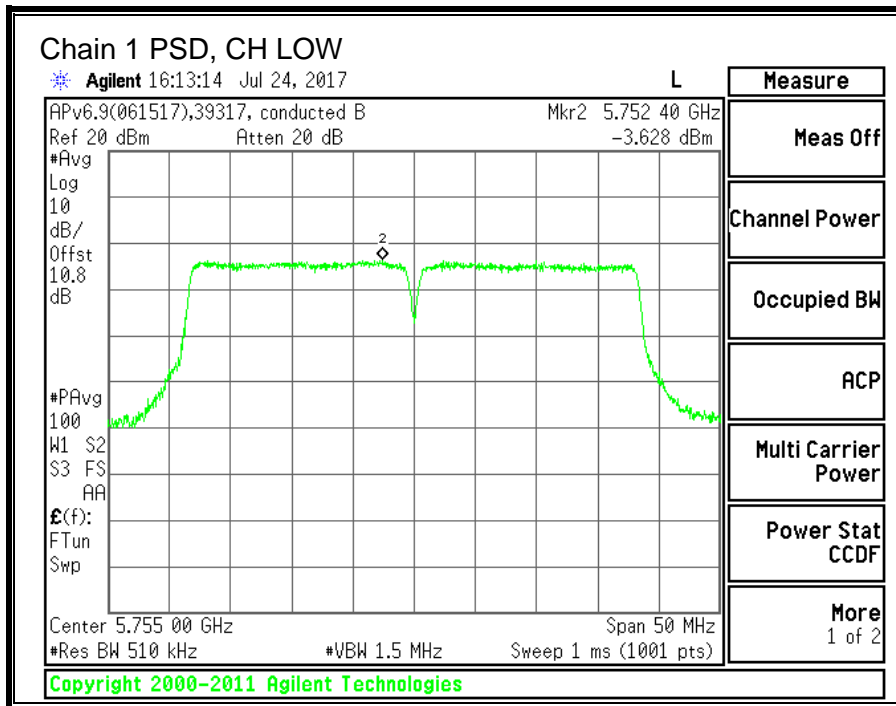
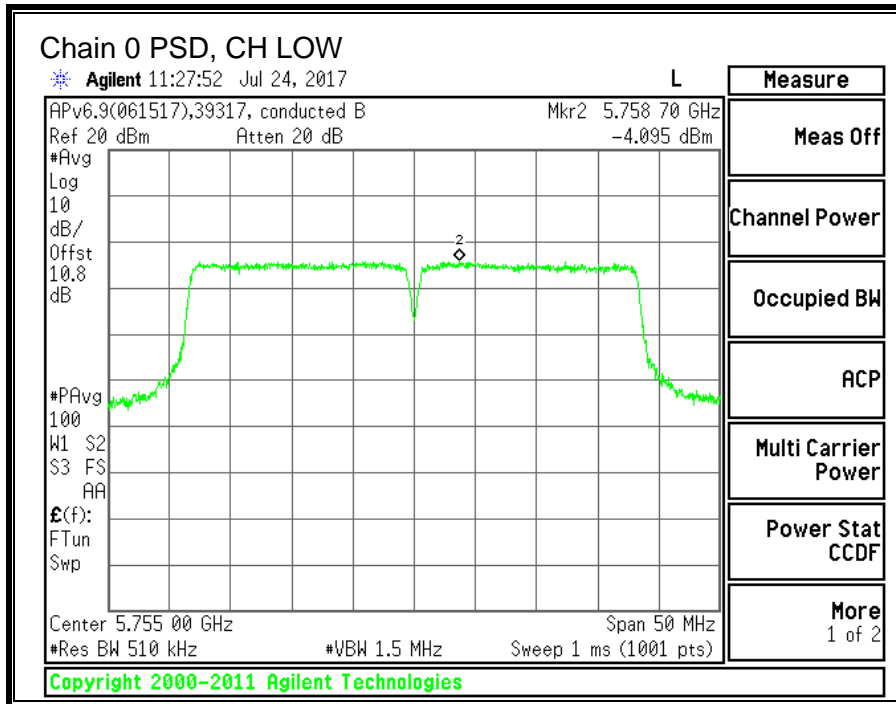

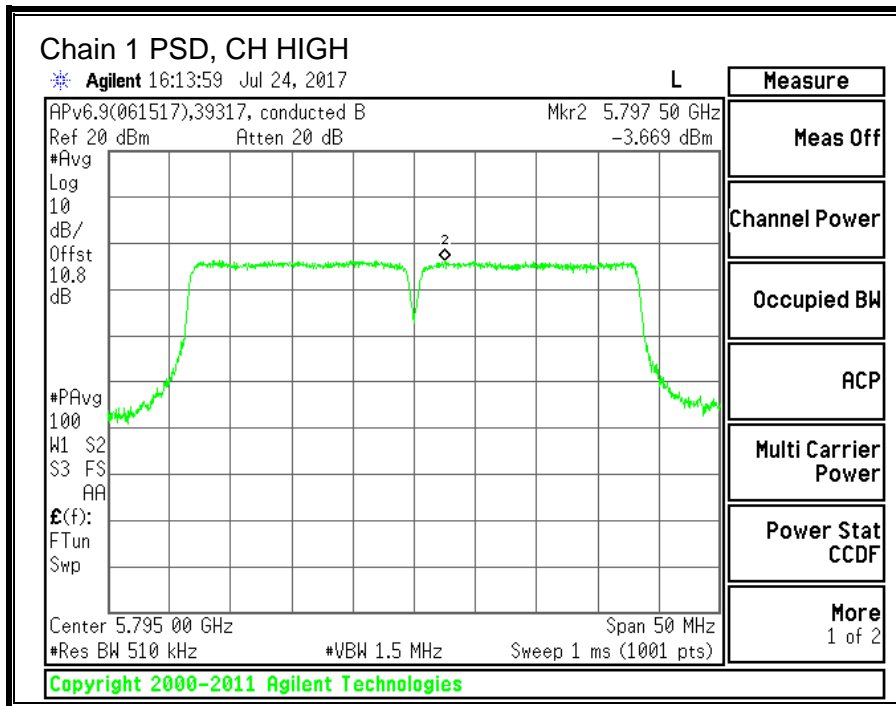
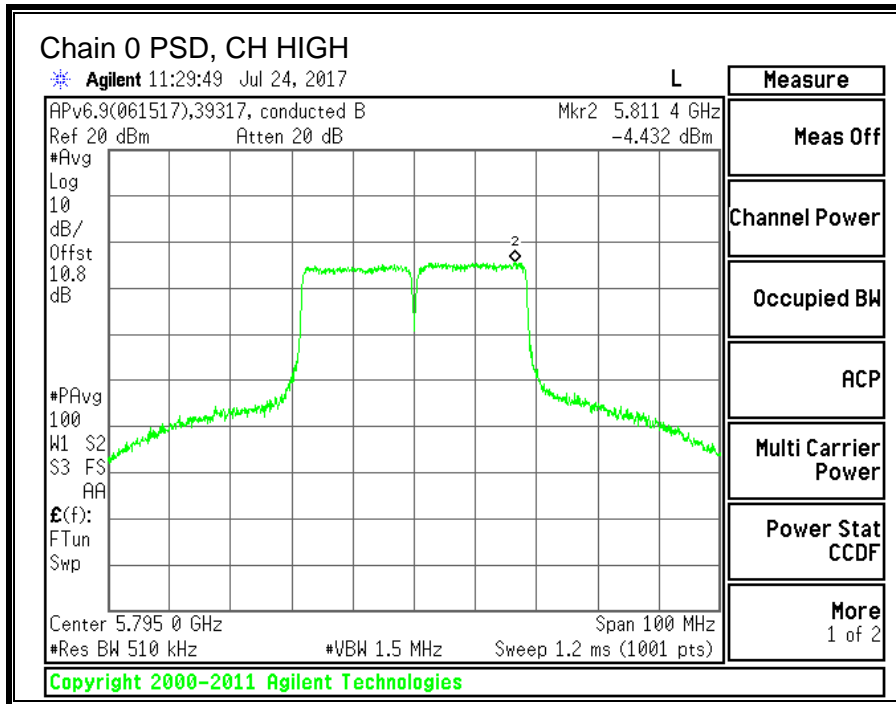

10.16. 11ac VHT80 2TX CDD MIMO MODE IN THE 5.8GHz BAND

10.16.1.6 dB BANDWIDTH

LIMITS

FCC §15.407 (e)

The minimum 6 dB bandwidth shall be at least 500 kHz.

RESULTS

Channel	Frequency	6 dB BW Chain 0 (MHz)	6 dB BW Chain 1 (MHz)	Minimum Limit (MHz)
Mid	5775	76.20	76.40	0.5

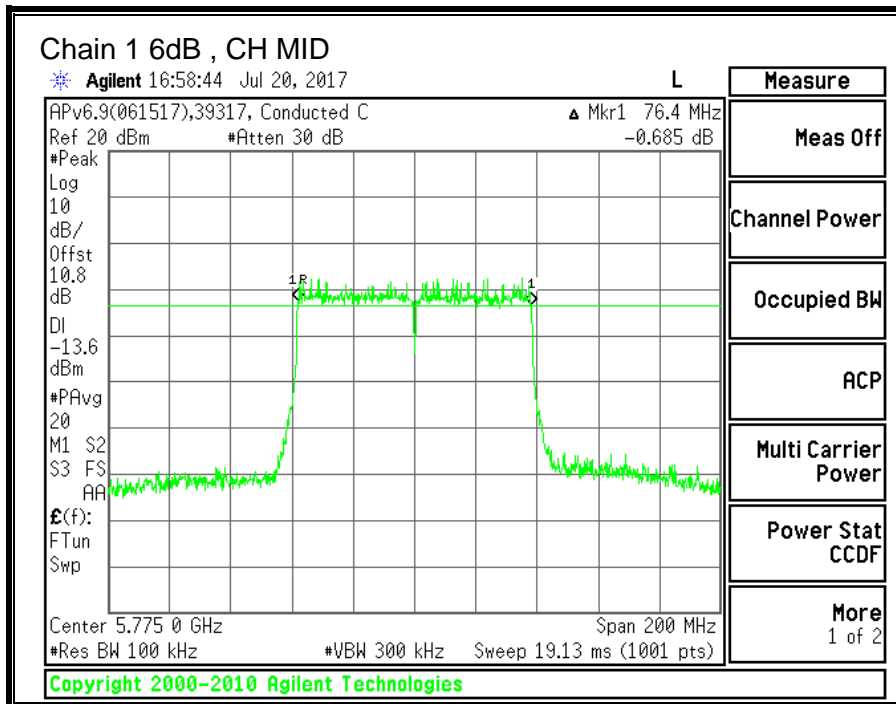
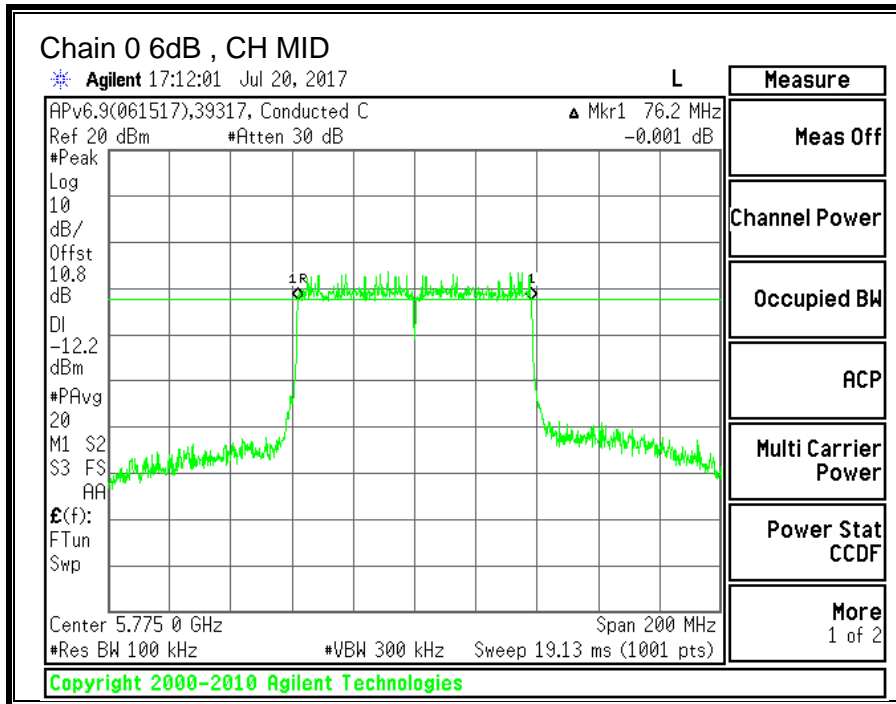

10.16.2. 99% BANDWIDTH

LIMITS

None; for reporting purposes only.

RESULTS

Channel	Frequency	99% BW Chain 0 (MHz)	99% BW Chain 1 (MHz)
Mid	5775	75.5045	73.3018

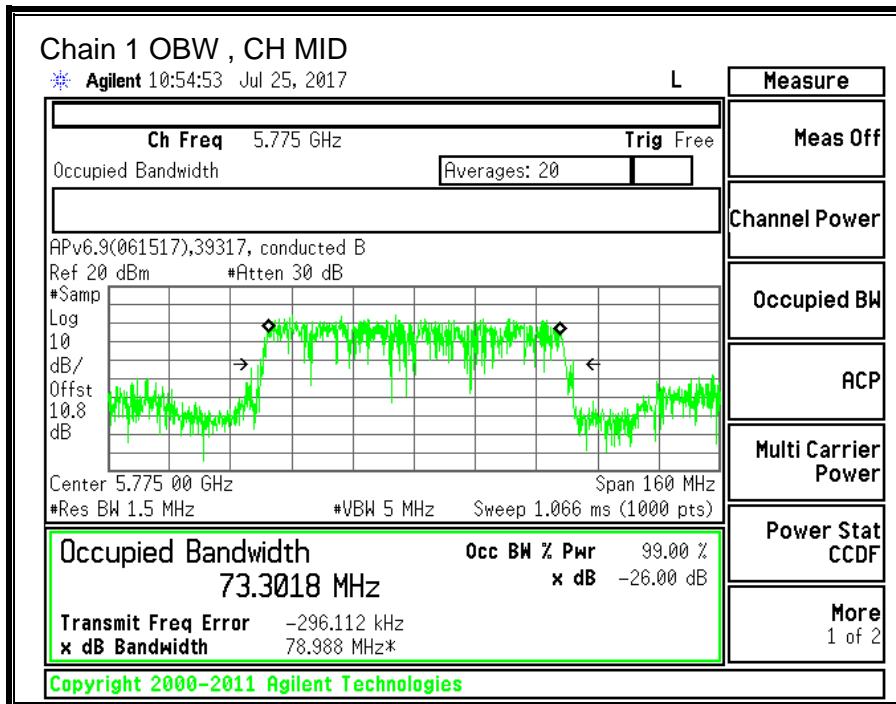
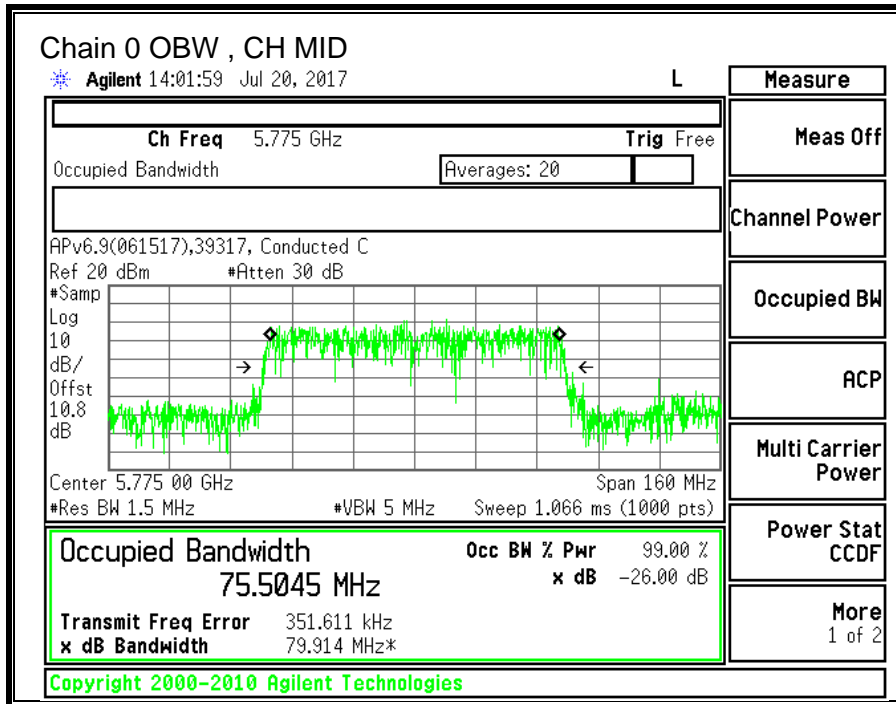

10.16.3. OUTPUT POWER AND PSD

LIMITS

FCC §15.407 (a) (3)

For the band 5.725-5.85 GHz, the maximum conducted output power over the frequency band of operation shall not exceed 1 W. In addition, the maximum power spectral density shall not exceed 30 dBm in any 500-kHz band. If transmitting antennas of directional gain greater than 6 dBi are used, both the maximum conducted output power and the maximum power spectral density shall be reduced by the amount in dB that the directional gain of the antenna exceeds 6 dBi.

TEST PROCEDURE

Measurements perform using a wideband gated RF power meter provided that the gate parameters are adjusted such that the power is measured only when the EUT is transmitting at its maximum power control level. Since the measurement is made only during the ON time of the transmitter, no duty cycle correction factor is required.

DIRECTIONAL ANTENNA GAIN

For power, the TX chains are uncorrelated and the antenna gain is unequal among the chains. The directional gain is:

5725-5850 MHz

Chain 0 Antenna Gain (dBi)	Chain 1 Antenna Gain (dBi)	Uncorrelated Chains Directional Gain (dBi)
-2.10	-0.30	-1.11

For PSD the TX chains are correlated and the antenna gain is unequal among the chains. The directional gain is:

5725-5850 MHz

Chain 0 Antenna Gain (dBi)	Chain 1 Antenna Gain (dBi)	Correlated Chains Directional Gain (dBi)
-2.10	-0.30	1.86

RESULTS

ID:	39317	Date:	07/21/17
------------	-------	--------------	----------

Antenna Gain and Limit

Channel	Frequency (MHz)	Directional Gain for Power (dBi)	Power Limit for PSD (dBi)	Power Limit (dBm)	PSD Limit (dBm)
Mid	5775	-1.11	1.86	30.00	30.00

Duty Cycle CF (dB)	0.71	Included in Calculations of Corr'd PSD
---------------------------	------	---

Output Power Results

Channel	Frequency (MHz)	Chain 0 Meas Power (dBm)	Chain 1 Meas Power (dBm)	Total Corr'd Power (dBm)	Power Limit (dBm)	Power Margin (dB)
Mid	5775	13.18	13.22	16.21	30.00	-13.79

PSD Results

Channel	Frequency (MHz)	Chain 0 Meas Power (dBm)	Chain 1 Meas Power (dBm)	Total Corr'd Power (dBm)	Power Limit (dBm)	Power Margin (dB)
Mid	5775	-7.208	-6.281	-3.00	30.00	-33.00

Note: the power readings above were measured with gated method, and the measurement was taken only during the ON time. No duty cycle correction was necessary.

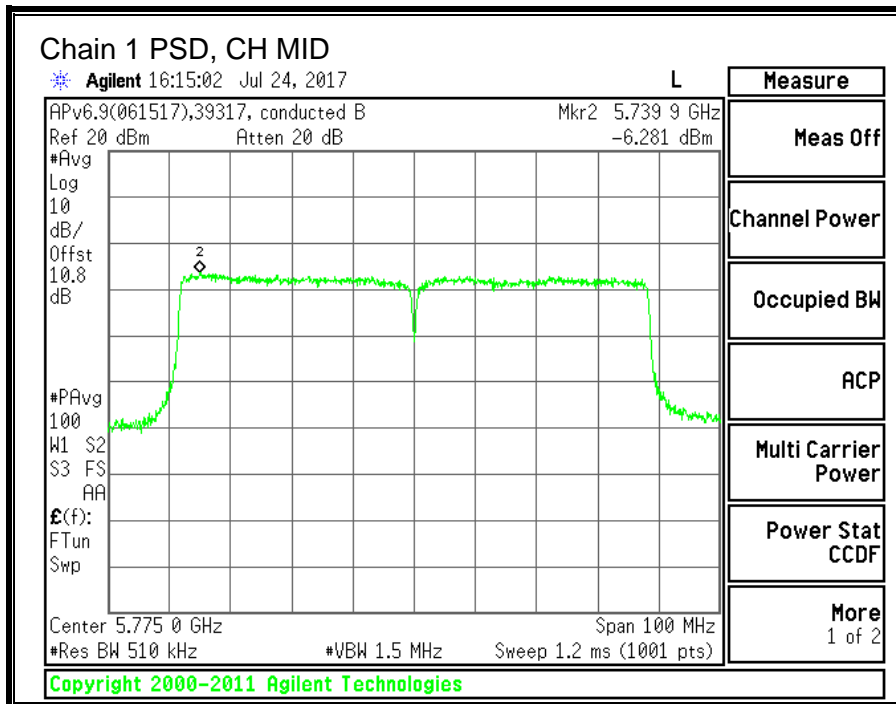
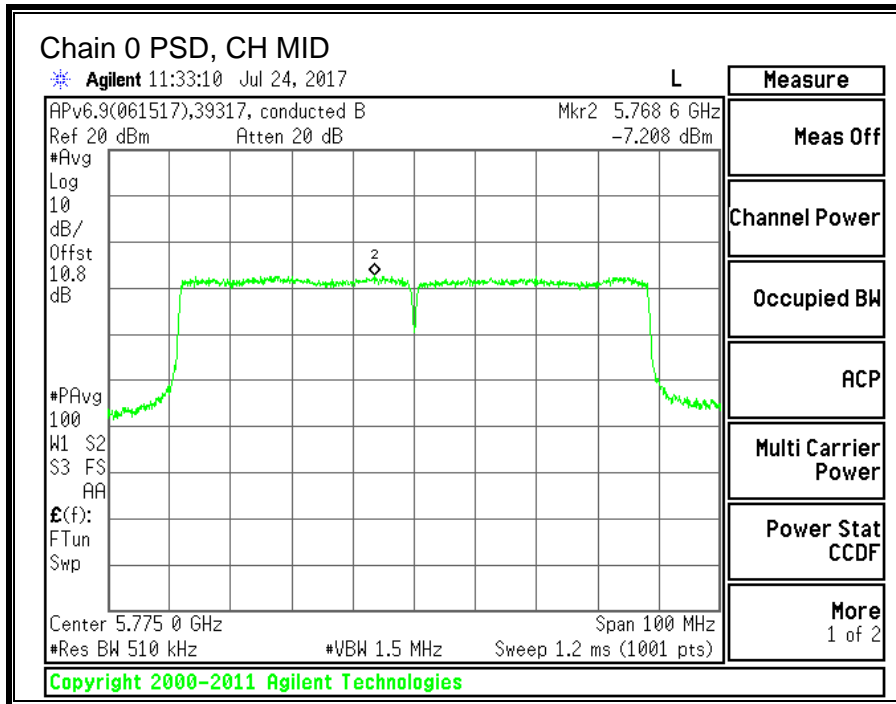

11. RADIATED TEST RESULTS

11.1. LIMITS AND PROCEDURE

LIMITS

FCC §15.205 and §15.209

Frequency Range (MHz)	Field Strength Limit (uV/m) at 3 m	Field Strength Limit (dBuV/m) at 3 m
30 - 88	100	40
88 - 216	150	43.5
216 - 960	200	46
Above 960	500	54

TEST PROCEDURE

The EUT is placed on a non-conducting table 80 cm above the ground plane for measurement below 1GHz; 1.5 m above the ground plane for measurement above 1GHz. The antenna to EUT distance is 3 meters. The EUT is configured in accordance with ANSI C63.10. The EUT is set to transmit in a continuous mode.

For measurements below 1 GHz the resolution bandwidth is set to 100 kHz for peak detection measurements or 120 kHz for quasi-peak detection measurements. Peak detection is used unless otherwise noted as quasi-peak.

For pre-scans above 1 GHz the resolution bandwidth is set to 1 MHz; the video bandwidth is set to 30 KHz for peak measurements.

For measurements above 1 GHz the resolution bandwidth is set to 1 MHz; the video bandwidth is set to 3 MHz for peak measurements and add duty cycle factor for average measurements.

The spectrum from 1 GHz to 18 GHz is investigated with the transmitter set to the lowest, middle, and highest channels in each applicable band. Below 1GHz and above 18GHz emissions, the channel with the highest output power was tested.

The frequency range of interest is monitored at a fixed antenna height and EUT azimuth. The EUT is rotated through 360 degrees to maximize emissions received. The antenna is scanned from 1 to 4 meters above the ground plane to further maximize the emission. Measurements are made with the antenna polarized in both the vertical and the horizontal positions.

Radiated emission were performed with the EUT set to transmit at the channel with highest output power as worst-case scenario.

11.1.1. 11a 2TX CDD MIMO MODE IN THE 5.2GHZ BAND

RESTRICTED BANDEDGE (LOW CHANNEL)

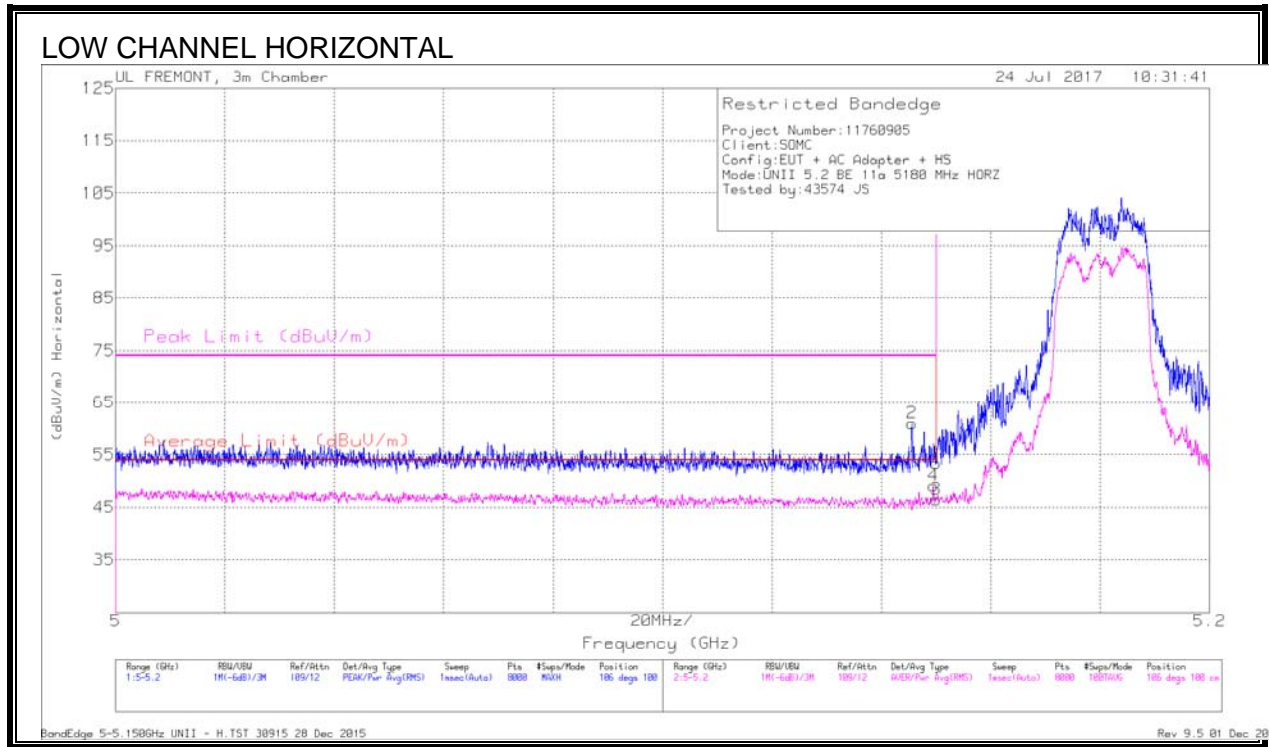

Trace Markers

Marker	Frequency (GHz)	Meter Reading (dBuV)	Det	AF T712 (dB/m)	Amp/Cbl/Filt/Pad (dB)	DC Corr (dB)	Corrected Reading (dBuV/m)	Average Limit (dBuV/m)	Margin (dB)	Peak Limit (dBuV/m)	PK Margin (dB)	Azimuth (Degs)	Height (cm)	Polarity
2	5.146	45.26	Pk	34.2	-18.5	0	60.96	-	-	74	-13.04	106	100	H
4	5.149	33.1	RMS	34.2	-18.5	-24	49.04	54	-4.96	-	-	106	100	H
1	5.15	37.67	Pk	34.2	-18.5	0	53.37	-	-	74	-20.63	106	100	H
3	5.15	30.54	RMS	34.2	-18.5	-24	46.48	54	-7.52	-	-	106	100	H

Pk - Peak detector
 RMS - RMS detection

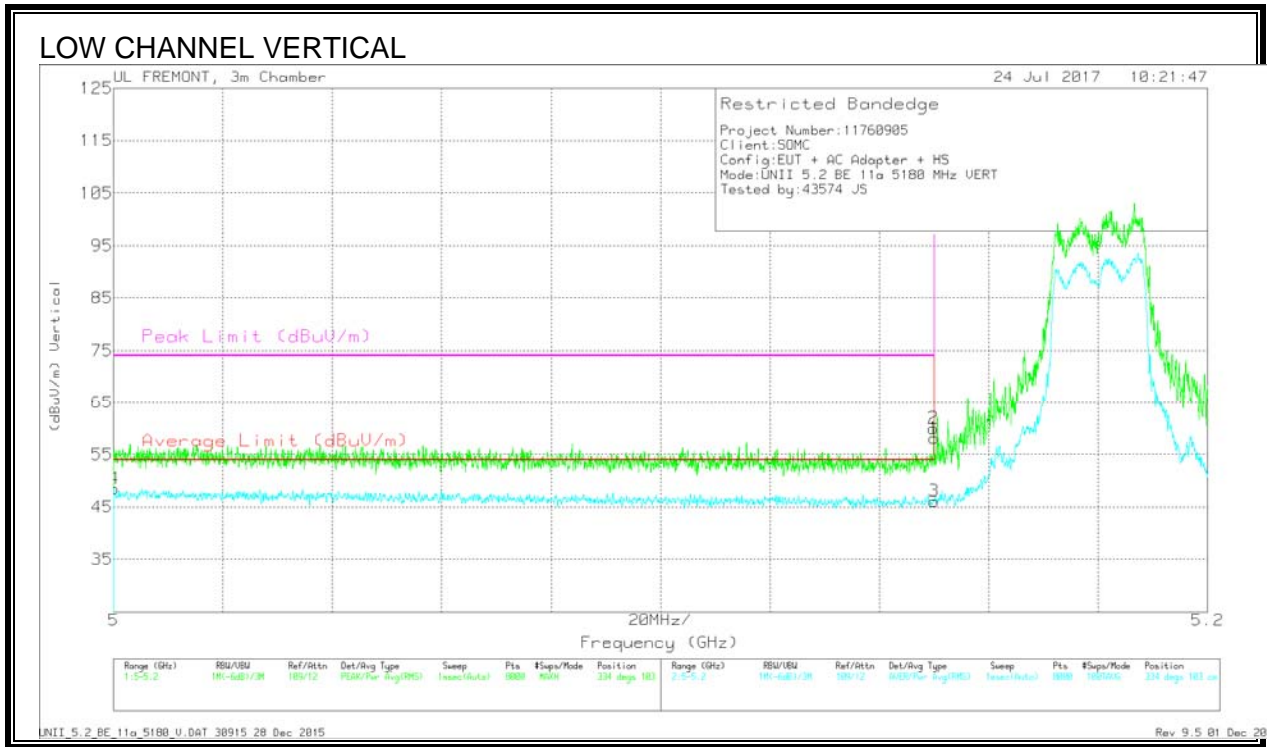

Trace Markers

Marker	Frequency (GHz)	Meter Reading (dBuV)	Det	AFT712 (dB/m)	Amp/Cbl/Ftr/Pad (dB)	DC Corr (dB)	Corrected Reading (dBuV/m)	Average Limit (dBuV/m)	Margin (dB)	Peak Limit (dBuV/m)	PK Margin (dB)	Azimuth (Degs)	Height (cm)	Polarity
4	5	32.22	RMS	34.1	-18.1	-24	-48.46	54	-5.54	-	-	334	103	V
1	5.15	42.39	PK	34.2	-18.5	0	58.09	-	-	74	-15.91	334	103	V
2	5.15	44.24	PK	34.2	-18.5	0	59.94	-	-	74	-14.06	334	103	V
3	5.15	30.13	RMS	34.2	-18.5	-24	46.07	54	-7.93	-	-	334	103	V

Pk - Peak detector
 RMS - RMS detection

HARMONICS AND SPURIOUS EMISSIONS

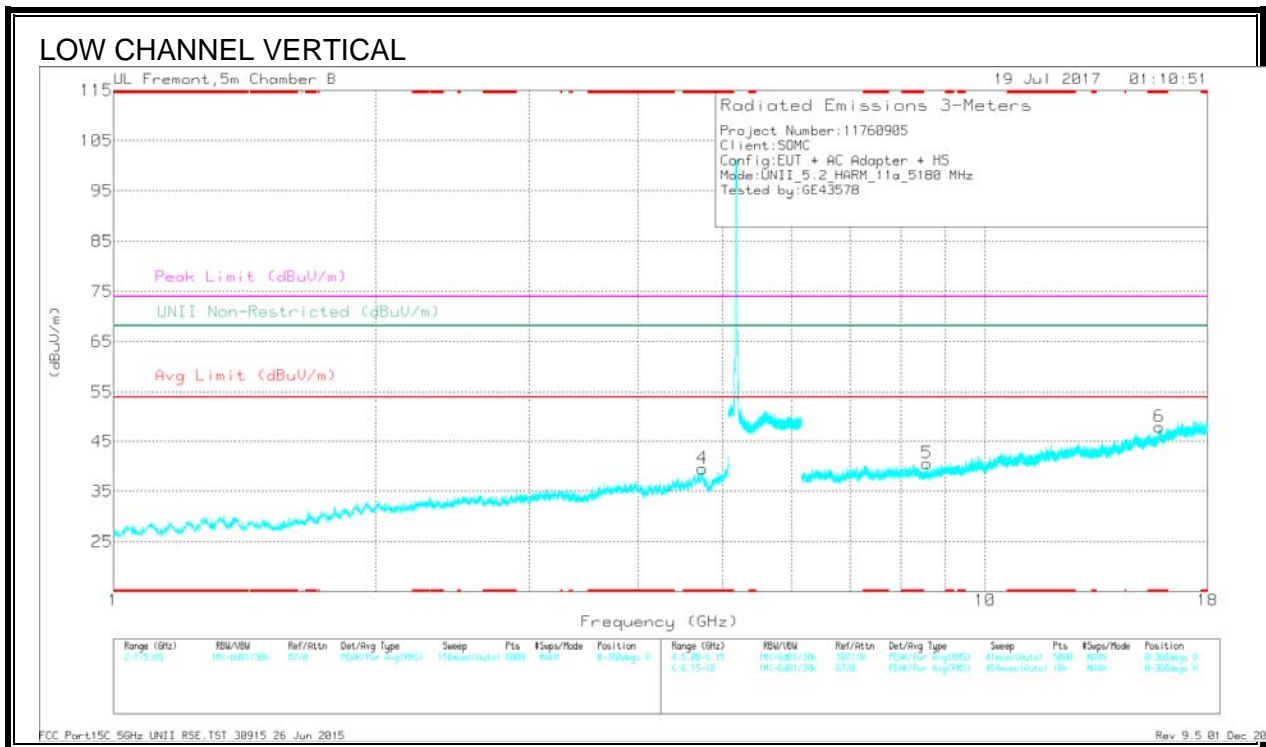
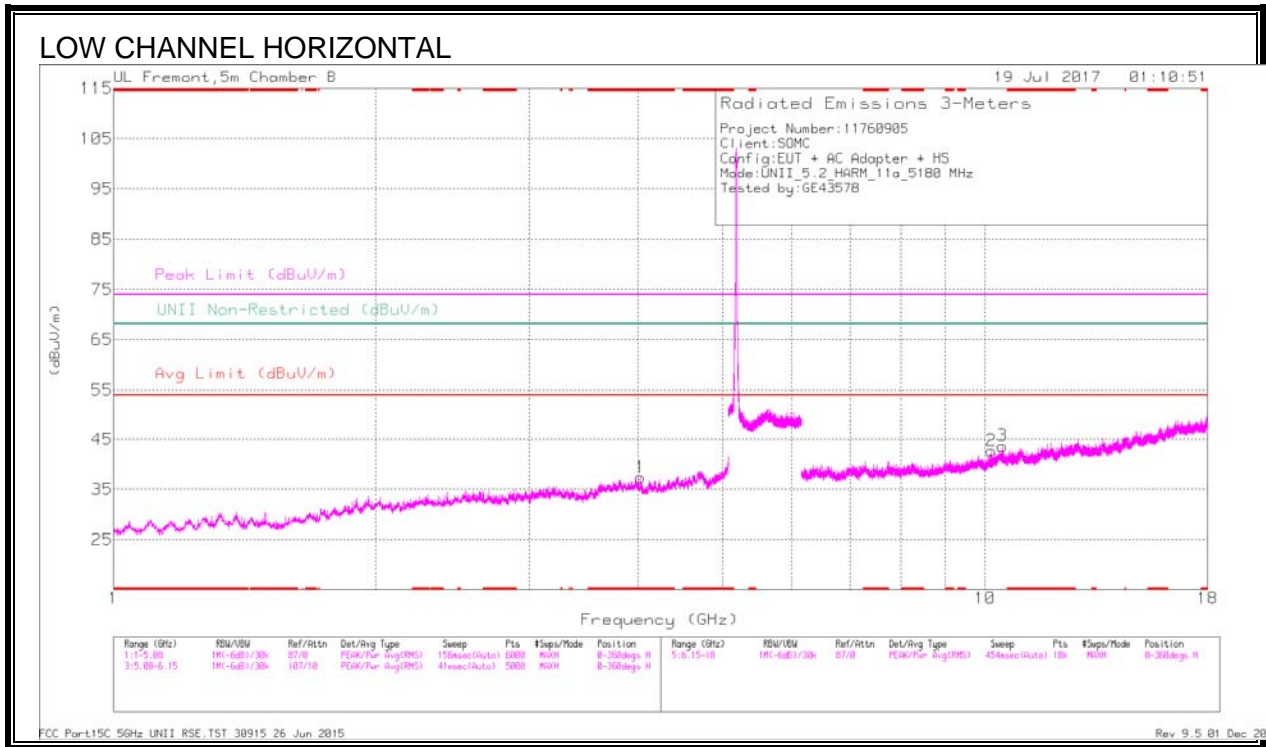

Trace Markers

Marker	Frequency (GHz)	Meter Reading (dBuV)	Det	AF TMS3 (dB/m)	Amp/Cli/Fix/Pad (dB)	DC Corr (dB)	Corrected Reading (dBuV/m)	Avg Limit (dBuV/m)	Margin (dB)	Peak Limit (dBuV/m)	PK Margin (dB)	U-NII Non-Restricted (dBuV/m)	PK Margin (dB)	Altitude (Degs)	Height (cm)	Polarity
1	* 4.028	34.02	Pk	33.5	-30.1	0	37.42	-	-	74	-36.58	-	-	0-360	199	H
4	* 4.735	34.41	Pk	34.2	-29	0	39.61	-	-	74	-34.39	-	-	0-360	200	V
6	* 15.855	25.62	Pk	41	-18.7	0	47.92	-	-	74	-26.08	-	-	0-360	200	V
5	8.576	30.38	Pk	36	-25.7	0	40.68	-	-	-	-	68.2	-27.52	0-360	200	V
2	10.169	29.36	Pk	37.4	-24	0	42.76	-	-	-	-	68.2	-25.44	0-360	199	H
3	10.474	28.99	Pk	37.5	-22.8	0	43.69	-	-	-	-	68.2	-24.51	0-360	199	H

* - indicates frequency in CFR47 Pt 15 / IC RSS-Restricted Band
 Pk - Peak detector

Radiated Emissions

Frequency (GHz)	Meter Reading (dBuV)	Det	AF TMS3 (dB/m)	Amp/Cli/Fix/Pad (dB)	DC Corr (dB)	Corrected Reading (dBuV/m)	Avg Limit (dBuV/m)	Margin (dB)	Peak Limit (dBuV/m)	PK Margin (dB)	U-NII Non-Restricted (dBuV/m)	PK Margin (dB)	Altitude (Degs)	Height (cm)	Polarity
* 4.028	39.64	PK-U	33.5	-30	0	43.14	-	-	74	-30.86	-	-	51	199	H
* 4.028	27.58	ADR	33.5	-30.1	.24	31.22	54	-22.78	-	-	-	-	51	199	H
* 4.734	40.2	PK-U	34.2	-29	0	45.4	-	-	74	-28.6	-	-	285	199	V
* 4.734	28.25	ADR	34.2	-29	.24	33.69	54	-20.31	-	-	-	-	285	199	V
* 15.855	31.86	PK-U	41	-18.7	0	54.16	-	-	74	-19.84	-	-	55	199	V
* 15.855	20.33	ADR	41	-18.7	.24	42.87	54	-11.13	-	-	-	-	55	199	V
8.575	35.74	PK-U	36	-25.7	0	46.04	-	-	-	-	68.2	-22.16	124	199	V
10.168	33.71	PK-U	37.4	-24	0	47.11	-	-	-	-	68.2	-21.09	325	199	H
10.472	33.16	PK-U	37.5	-22.8	0	47.86	-	-	-	-	68.2	-20.34	92	199	H

* - indicates frequency in CFR47 Pt 15 / IC RSS-Restricted Band
 PK-U - U-NII: Maximum Peak
 ADR - U-NII AD primary method, RMS average

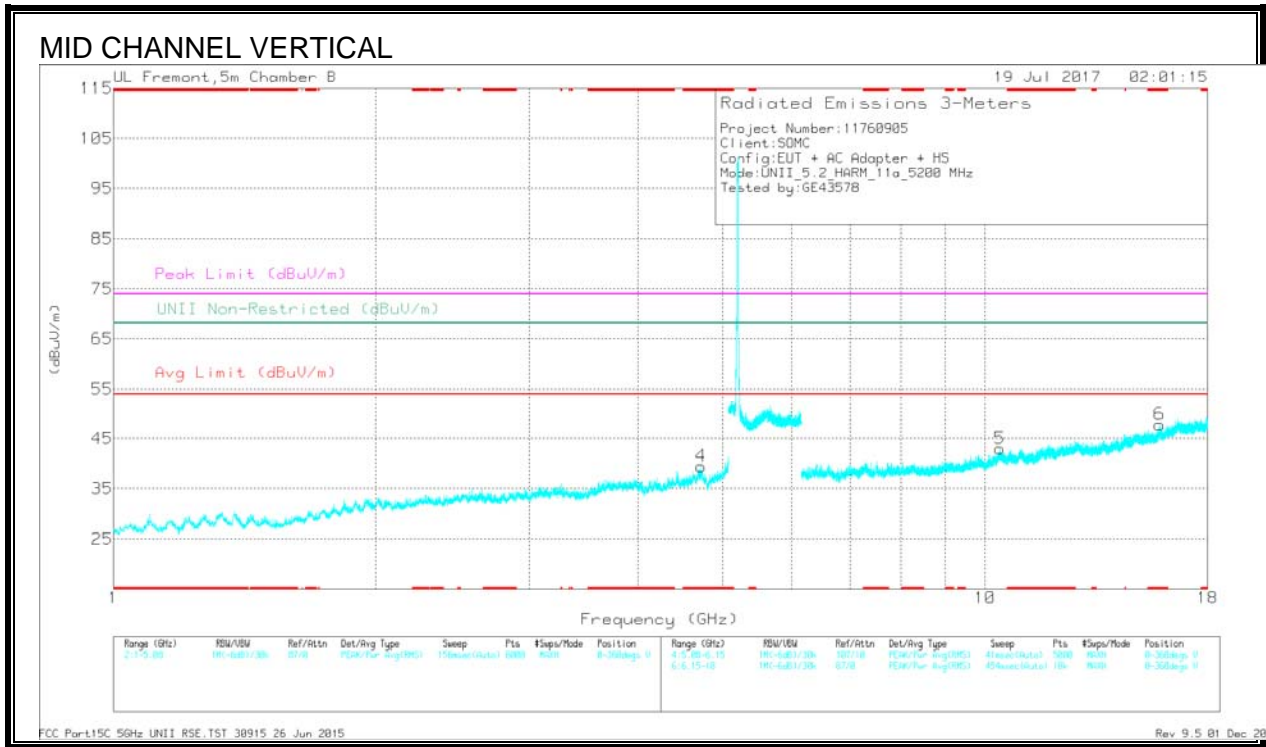
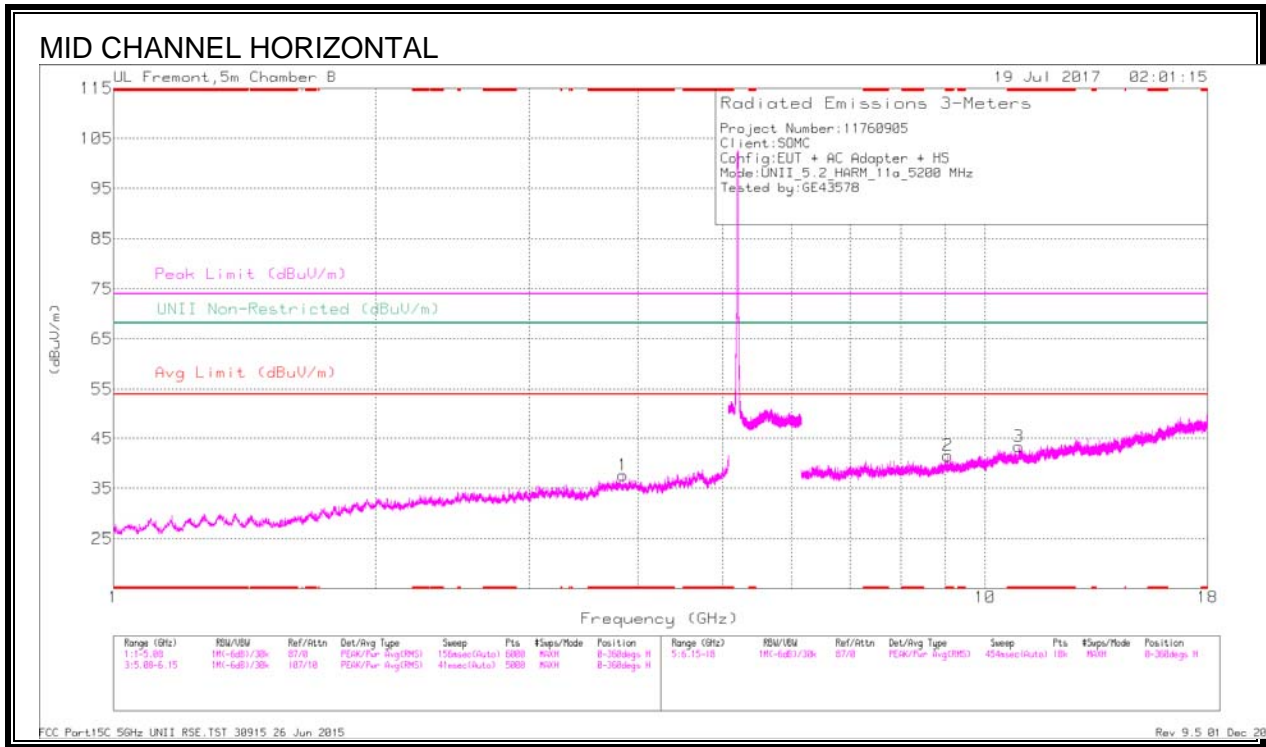

Trace Markers

Marker	Frequency (GHz)	Meter Reading (dBuV)	Det	AF TMS3 (dB/m)	Amp/Cb/Ftr/Pad (dB)	DC Corr (dB)	Corrected Reading (dBuV/m)	Avg Limit (dBuV/m)	Margin (dB)	Peak Limit (dBuV/m)	PK Margin (dB)	U-NII Non-Restricted (dBuV/m)	PK Margin (dB)	Altitude (Degs)	Height (cm)	Polarity
1	* 3.843	35.18	Pk	33.5	-31	0	37.68	-	-	74	-36.32	-	-	0-360	199	H
4	* 4.722	34.36	Pk	34.2	-29.1	0	39.46	-	-	74	-34.54	-	-	0-360	199	V
2	* 9.063	30.25	Pk	36.3	-25	0	41.55	-	-	74	-32.45	-	-	0-360	199	H
3	* 10.935	28.11	Pk	37.7	-22.4	0	43.41	-	-	74	-30.59	-	-	0-360	102	H
6	* 15.858	25.33	Pk	41	-18.6	0	47.73	-	-	74	-26.27	-	-	0-360	200	V
5	10.4	27.99	Pk	37.5	-22.5	0	42.99	-	-	-	-	68.2	-25.21	0-360	200	V

* - indicates frequency in CFR47 Pt 15 / IC RSS-Restricted Band
 Pk - Peak detector

Radiated Emissions

Frequency (GHz)	Meter Reading (dBuV)	Det	AF TMS3 (dB/m)	Amp/Cb/Ftr/Pad (dB)	DC Corr (dB)	Corrected Reading (dBuV/m)	Avg Limit (dBuV/m)	Margin (dB)	Peak Limit (dBuV/m)	PK Margin (dB)	U-NII Non-Restricted (dBuV/m)	PK Margin (dB)	Altitude (Degs)	Height (cm)	Polarity
* 3.842	41.06	PK-U	33.5	-31	0	43.56	-	-	74	-30.44	-	-	127	200	H
* 3.843	28.19	ADR	33.5	-31	.24	30.93	54	-23.07	-	-	-	-	127	200	H
* 4.722	39.46	PK-U	34.2	-29.1	0	44.56	-	-	74	-29.44	-	-	0	200	V
* 4.722	28.01	ADR	34.2	-29.1	.24	33.35	54	-20.65	-	-	-	-	0	200	V
* 9.063	35.76	PK-U	36.3	-25	0	47.06	-	-	74	-26.94	-	-	33	200	H
* 9.063	24.11	ADR	36.3	-25	.24	35.65	54	-18.35	-	-	-	-	33	200	H
* 10.935	34.41	PK-U	37.7	-22.4	0	49.71	-	-	74	-24.29	-	-	151	104	H
* 10.935	22.48	ADR	37.7	-22.4	.24	38.02	54	-15.98	-	-	-	-	151	104	H
* 15.859	32.15	PK-U	41	-18.6	0	54.55	-	-	74	-19.45	-	-	291	200	V
* 15.857	20.6	ADR	41	-18.6	.24	43.24	54	-10.76	-	-	-	-	291	200	V
10.401	33.59	PK-U	37.5	-22.5	0	48.59	-	-	-	-	68.2	-19.61	316	200	V

* - indicates frequency in CFR47 Pt 15 / IC RSS-Restricted Band
 PK-U - U-NII: Maximum Peak
 ADR - U-NII AD primary method, RMS average

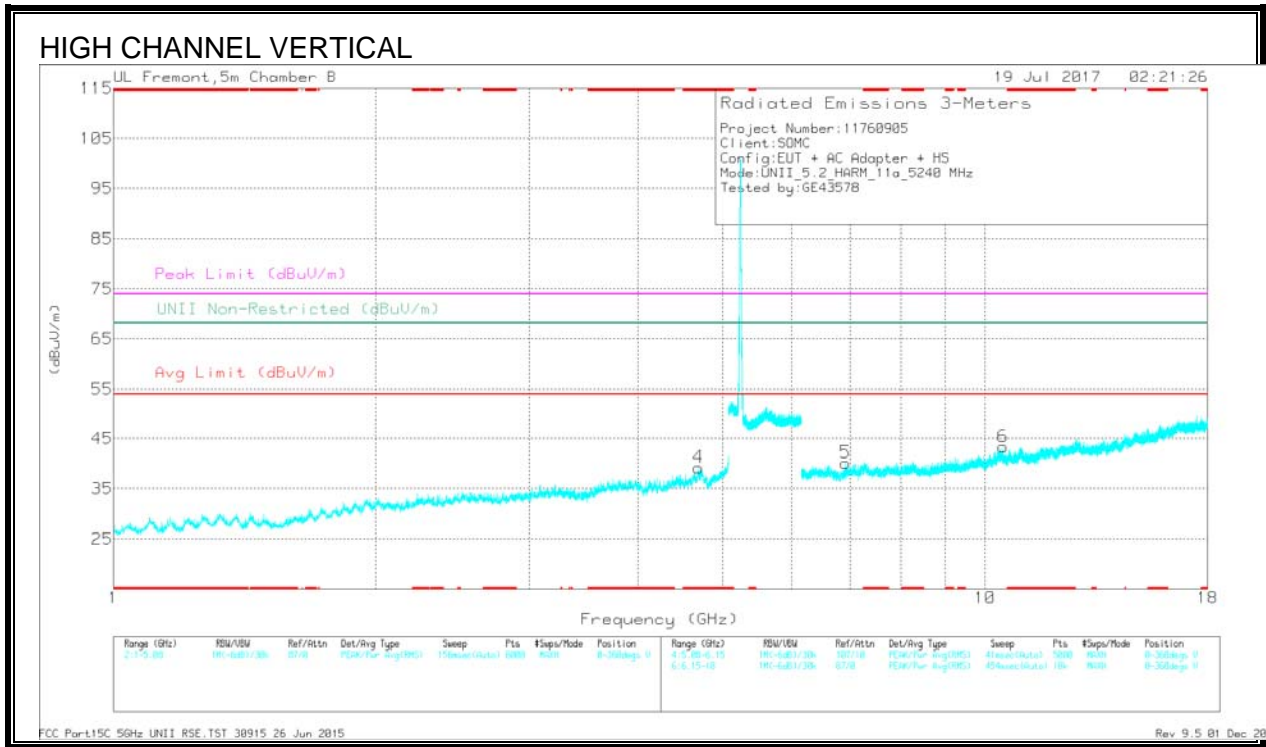
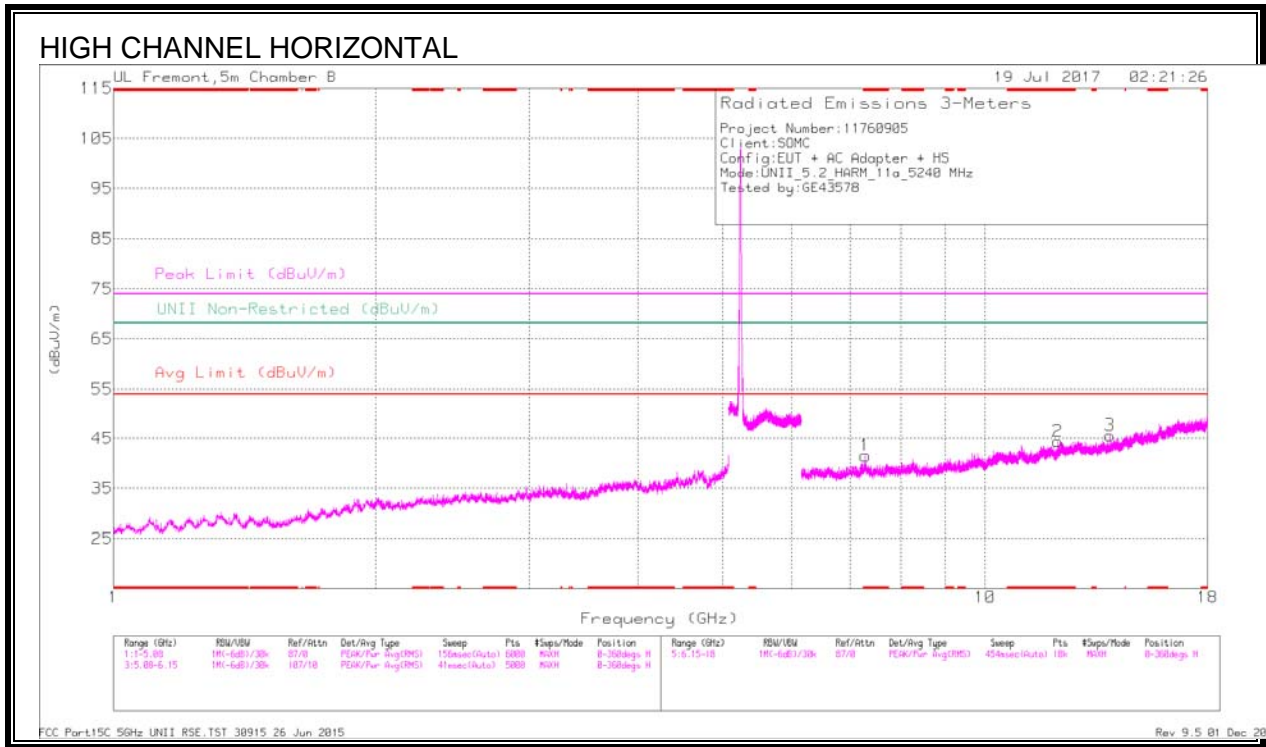

Trace Markers

Marker	Frequency (GHz)	Meter Reading (dBuV)	Det	AF T863 (dB/m)	Amp/Cb/Ftr/Psd (dB)	DC Corr (dB)	Corrected Reading (dBuV/m)	Aug Limit (dBuV/m)	Margin (dB)	Peak Limit (dBuV/m)	PK Margin (dB)	UNII Non-Restricted (dBuV/m)	PK Margin (dB)	Azimuth (Degs)	Height (cm)	Polarity
4	* 4.687	34.17	Pk	34.2	-29.1	0	39.27	-	-	74	-34.73	-	-	0-360	102	V
1	* 7.29	31.72	Pk	35.8	-26	0	41.52	-	-	74	-32.48	-	-	0-360	102	H
2	* 12.121	28.33	Pk	39	-22.9	0	44.43	-	-	74	-29.57	-	-	0-360	199	H
5	6.921	32.58	Pk	35.8	-28.2	0	40.18	-	-	-	-	68.2	-28.02	0-360	102	V
6	10.479	28.51	Pk	37.5	-22.7	0	43.31	-	-	-	-	68.2	-24.89	0-360	102	V
3	13.9	28.02	Pk	39.1	-21.6	0	45.52	-	-	-	-	68.2	-22.68	0-360	102	H

* - indicates frequency in CFR47 Pt 15 / IC RSS-Restricted Band
 Pk - Peak detector

Radiated Emissions

Frequency (GHz)	Meter Reading (dBuV)	Det	AF T863 (dB/m)	Amp/Cb/Ftr/Psd (dB)	DC Corr (dB)	Corrected Reading (dBuV/m)	Aug Limit (dBuV/m)	Margin (dB)	Peak Limit (dBuV/m)	PK Margin (dB)	UNII Non-Restricted (dBuV/m)	PK Margin (dB)	Azimuth (Degs)	Height (cm)	Polarity
* 4.686	41.08	PK-U	34.2	-29.1	0	46.18	-	-	74	-27.82	-	-	265	101	V
* 4.688	28.26	ADR	34.2	-29.1	.24	33.6	54	-20.4	-	-	-	-	265	101	V
* 7.291	37.33	PK-U	35.8	-26	0	47.13	-	-	74	-26.87	-	-	164	101	H
* 7.291	24.98	ADR	35.8	-26	.24	35.02	54	-18.98	-	-	-	-	164	101	H
* 12.121	33.99	PK-U	39	-22.9	0	50.09	-	-	74	-23.91	-	-	202	199	H
* 12.12	22.1	ADR	39	-22.9	.24	38.44	54	-15.56	-	-	-	-	202	199	H
6.921	37.64	PK-U	35.8	-28.2	0	45.24	-	-	-	-	68.2	-22.96	40	104	V
10.48	35.32	PK-U	37.5	-22.7	0	50.12	-	-	-	-	68.2	-18.08	104	104	V
13.902	33.06	PK-U	39.1	-21.8	0	50.36	-	-	-	-	68.2	-17.84	105	104	H

* - indicates frequency in CFR47 Pt 15 / IC RSS-Restricted Band
 PK-U - U-NII: Maximum Peak
 ADR - U-NII AD primary method, RMS average

11.1.2. 11n HT20 2TX CDD MIMO MODE IN THE 5.2GHZ BAND

RESTRICTED BANDEDGE (LOW CHANNEL)

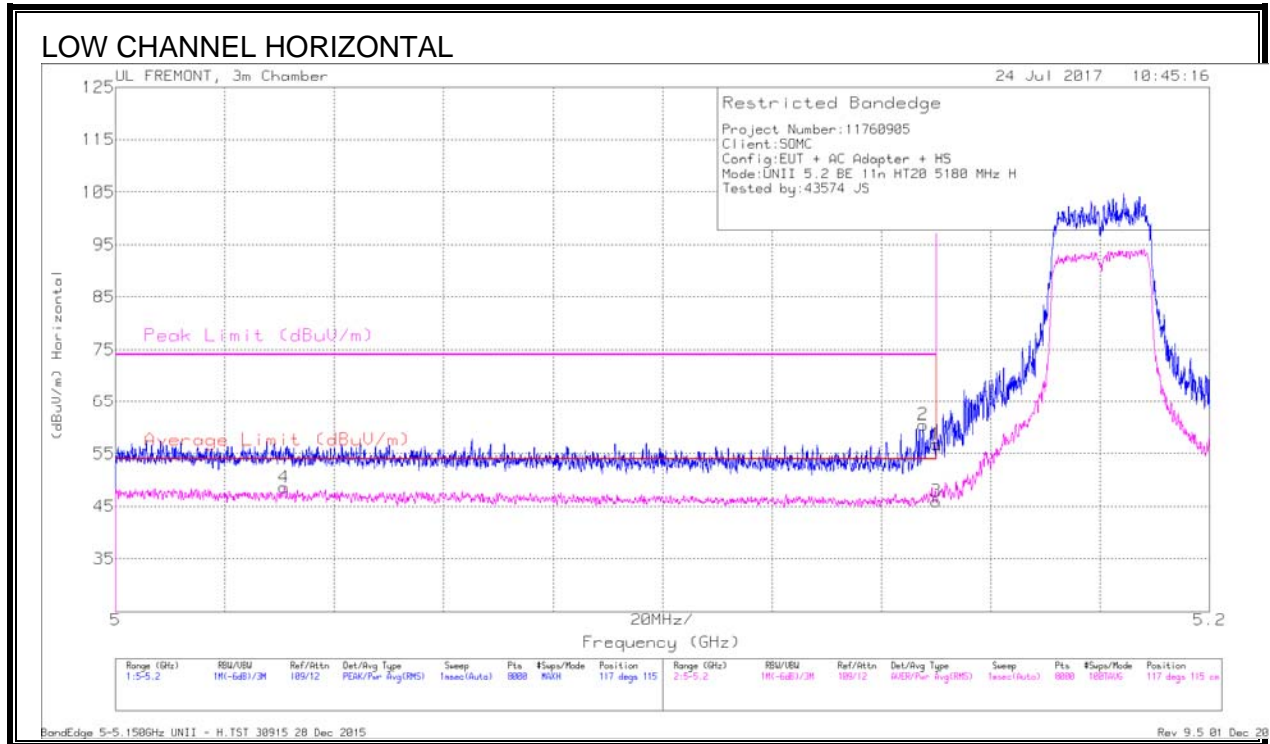

Trace Markers

Marker	Frequency (GHz)	Meter Reading (dBuV)	Det	AF T712 (dB/m)	Amp/Chl/Filt/Pad (dB)	DC Corr (dB)	Corrected Reading (dBuV/m)	Average Limit (dBuV/m)	Margin (dB)	Peak Limit (dBuV/m)	PK Margin (dB)	Azimuth (Degs)	Height (cm)	Polarity
4	5.031	32.51	RMS	34.1	-18.2	-19	48.6	54	-5.4	-	-	117	115	H
2	5.148	44.69	Pk	34.2	-18.4	0	60.49	-	-	74	-13.51	117	115	H
1	5.15	41.04	Pk	34.2	-18.5	0	56.74	-	-	74	-17.26	117	115	H
3	5.15	30.01	RMS	34.2	-18.5	-19	45.9	54	-8.1	-	-	117	115	H

Pk - Peak detector
 RMS - RMS detection

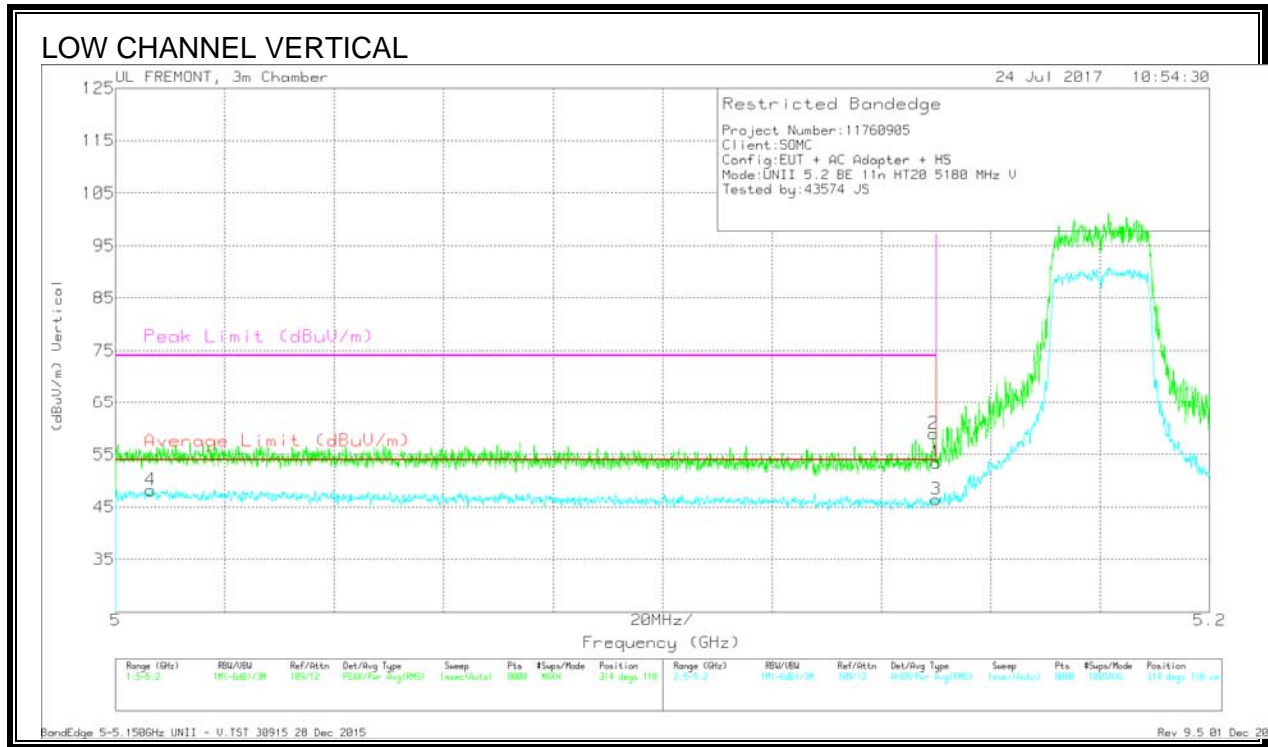

Trace Markers

Marker	Frequency (GHz)	Meter Reading (dBuV)	Det	AF T712 (dB/m)	Amp/Cbl/Ftr/Pad (dB)	DC Corr (dB)	Corrected Reading (dBuV/m)	Average Limit (dBuV/m)	Margin (dB)	Peak Limit (dBuV/m)	PK Margin (dB)	Azimuth (Degs)	Height (cm)	Polarity
4	5.006	32.05	RMS	34.1	-18.1	19	48.24	54	-5.76	-	-	314	118	V
1	5.15	37.76	Pk	34.2	-18.5	0	53.46	-	-	74	-20.54	314	118	V
2	5.15	43.24	Pk	34.2	-18.5	0	58.94	-	-	74	-15.06	314	118	V
3	5.15	30.58	RMS	34.2	-18.5	19	46.47	54	-7.53	-	-	314	118	V

Pk - Peak detector
 RMS - RMS detection

HARMONICS AND SPURIOUS EMISSIONS

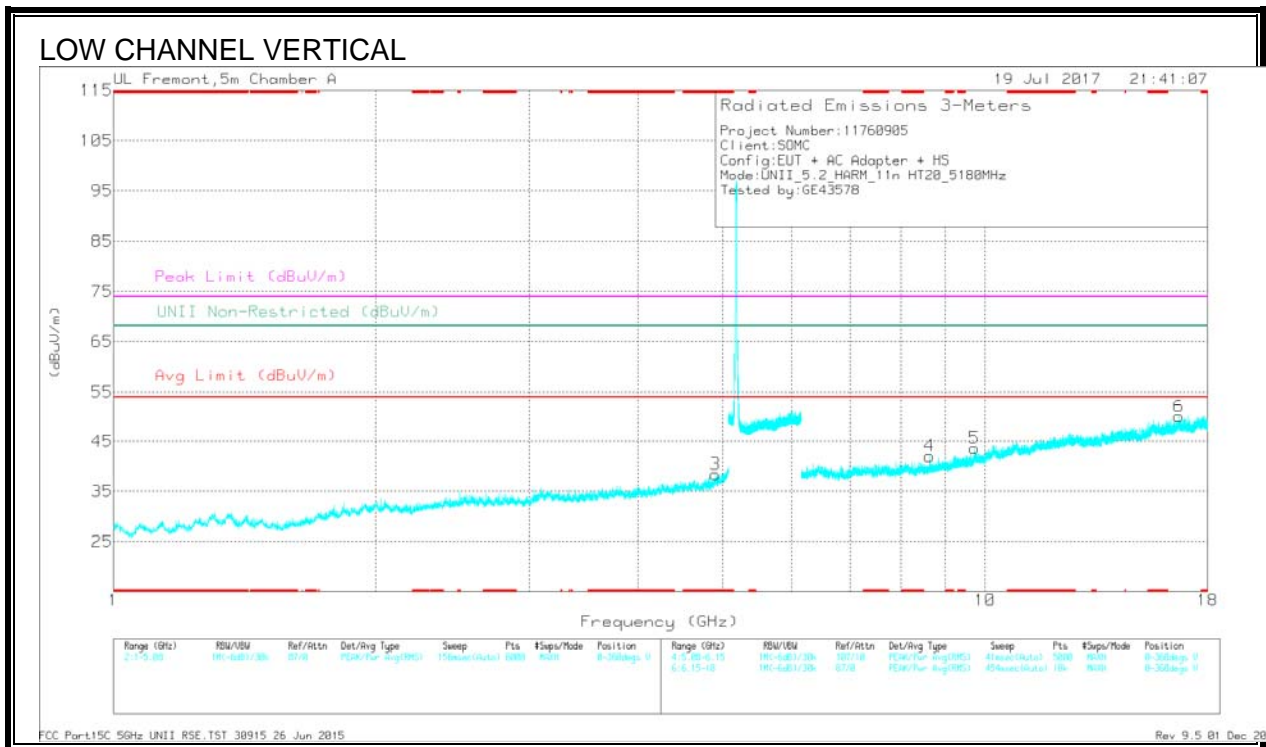
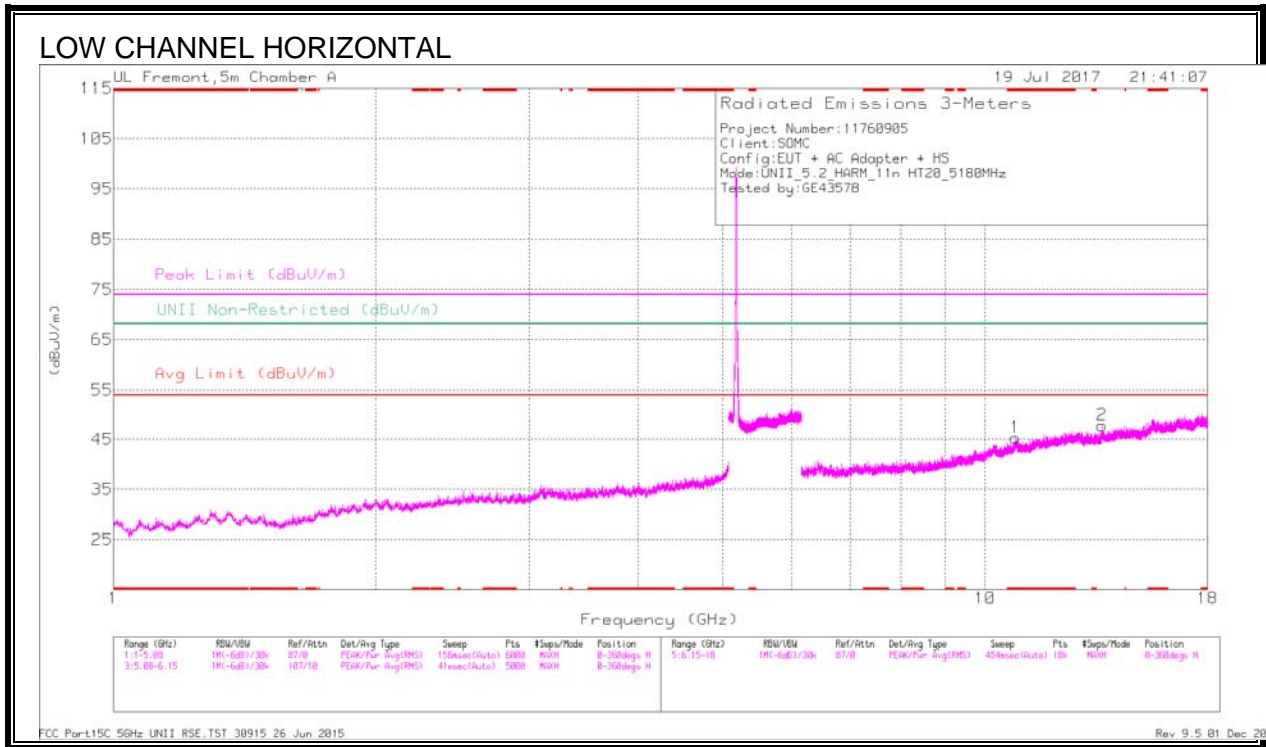

Trace Markers

Marker	Frequency (GHz)	Meter Reading (dBuV)	Det	AF T862 (dB/m)	Amp/Cb/FHz/Pad (dB)	DC Corr (dB)	Corrected Reading (dBuV/m)	Aug Limit (dBuV/m)	Margin (dB)	Peak Limit (dBuV/m)	PK Margin (dB)	U-NII Non-Restricted (dBuV/m)	PK Margin (dB)	Azimuth (Degs)	Height (cm)	Polarity
1	* 10.845	26.3	Pk	37.9	-18.9	0	45.3	-	-	74	-28.7	-	-	0-360	101	H
3	* 4.909	31.16	Pk	34.1	-26.8	0	38.46	-	-	74	-35.54	-	-	0-360	101	V
2	13.631	28.11	Pk	39.3	-19.6	0	47.81	-	-	-	-	68.2	-20.39	0-360	199	H
6	16.683	27.29	Pk	41.6	-18.9	0	49.99	-	-	-	-	68.2	-18.21	0-360	200	V
4	8.632	28.53	Pk	35.9	-22.4	0	42.03	-	-	-	-	68.2	-26.17	0-360	200	V
5	9.726	27.79	Pk	36.9	-21.1	0	43.59	-	-	-	-	68.2	-24.61	0-360	101	V

* - indicates frequency in CFR47 Pt 15 / IC RSS-Restricted Band
 Pk - Peak detector

Radiated Emissions

Frequency (GHz)	Meter Reading (dBuV)	Det	AF T862 (dB/m)	Amp/Cb/FHz/Pad (dB)	DC Corr (dB)	Corrected Reading (dBuV/m)	Aug Limit (dBuV/m)	Margin (dB)	Peak Limit (dBuV/m)	PK Margin (dB)	U-NII Non-Restricted (dBuV/m)	PK Margin (dB)	Azimuth (Degs)	Height (cm)	Polarity
* 4.909	36.94	PK-U	34.1	-26.8	0	44.24	-	-	74	-29.76	-	-	230	100	V
* 4.91	24.94	ADR	34.1	-26.8	.19	32.43	54	-21.57	-	-	-	-	230	100	V
* 10.844	32.61	PK-U	37.9	-18.9	0	51.61	-	-	74	-22.39	-	-	38	100	H
* 10.844	20.36	ADR	37.9	-18.9	.19	39.55	54	-14.45	-	-	-	-	38	100	H
8.631	33.46	PK-U	35.9	-22.5	0	46.86	-	-	-	-	68.2	-21.34	143	199	V
9.724	32.94	PK-U	36.9	-21.1	0	48.74	-	-	-	-	68.2	-19.46	37	102	V
13.63	33.9	PK-U	39.3	-19.6	0	53.6	-	-	-	-	68.2	-14.6	15	199	H
16.683	32.8	PK-U	41.6	-18.9	0	55.5	-	-	-	-	68.2	-12.7	299	199	V

* - indicates frequency in CFR47 Pt 15 / IC RSS-Restricted Band
 PK-U - U-NII: Maximum Peak
 ADR - U-NII AD primary method, RMS average

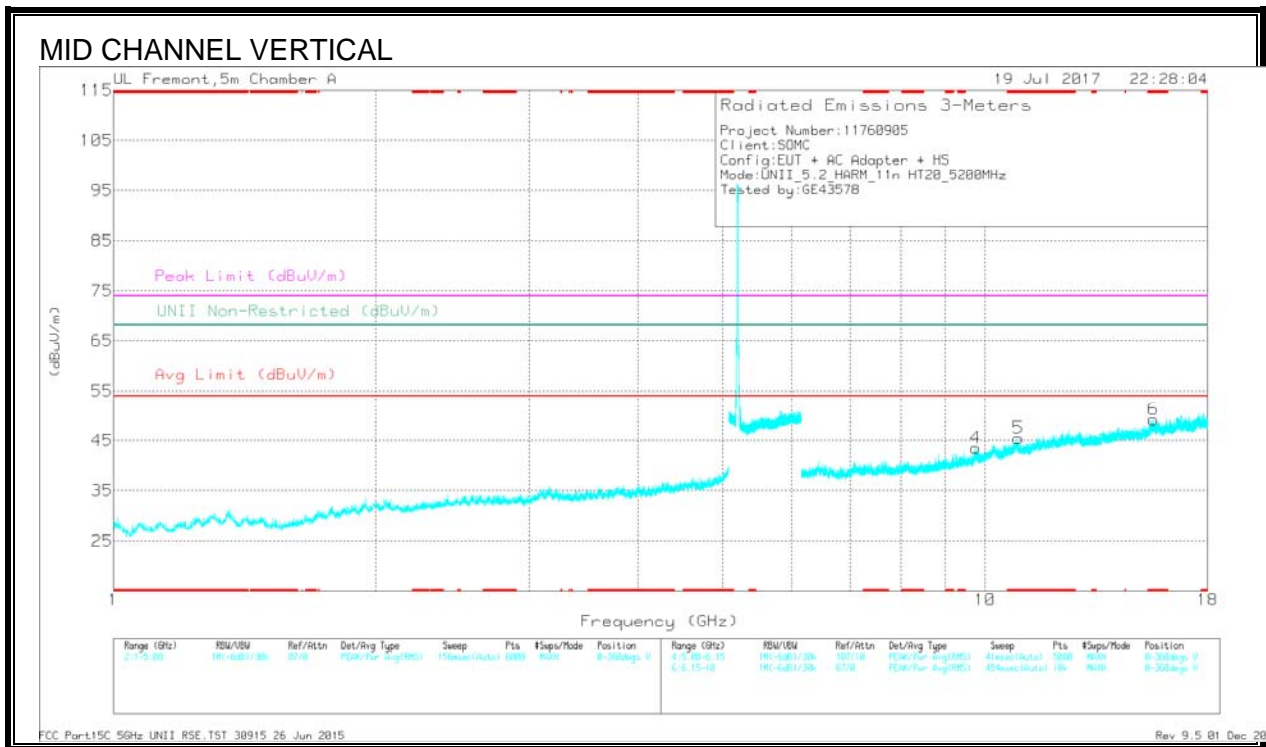
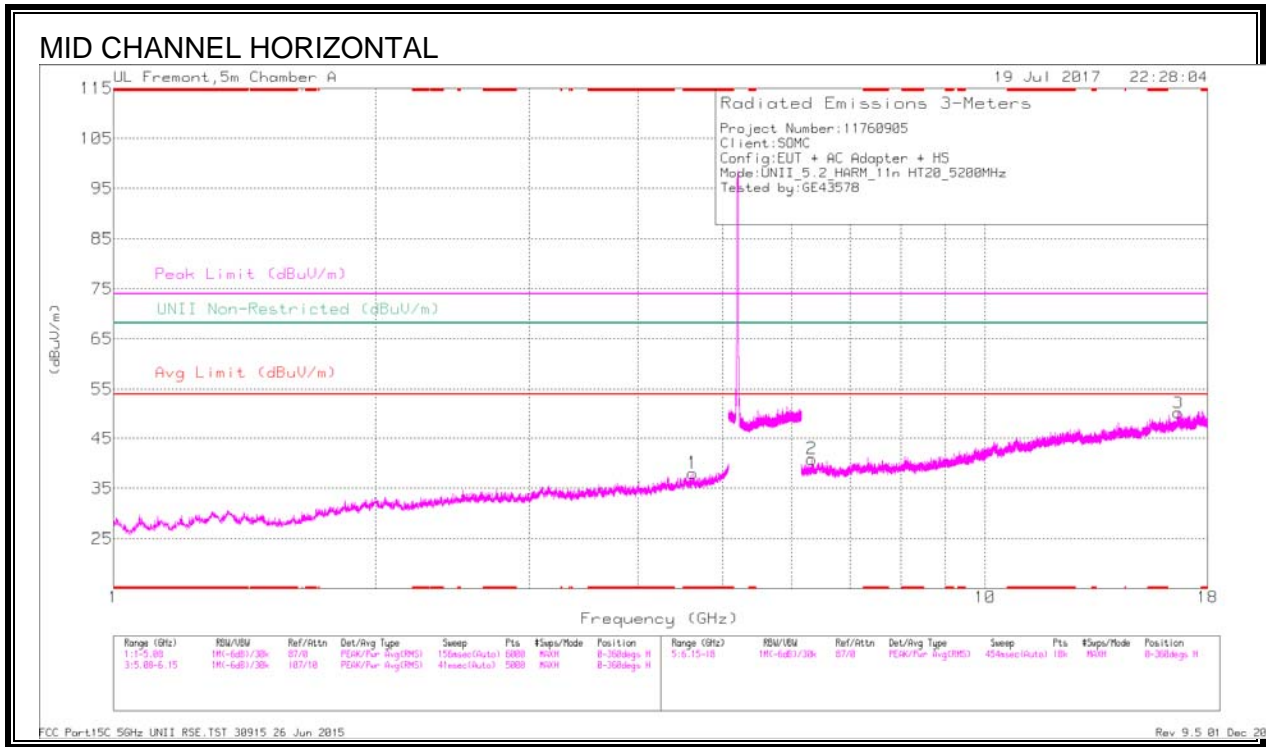

Trace Markers

Marker	Frequency (GHz)	Meter Reading (dBuV)	Det	AF TMR2 (dB/m)	Amp/Ch/FHz/Pad (dB)	DC Corr (dB)	Corrected Reading (dBuV/m)	Aug Limit (dBuV/m)	Margin (dB)	Peak Limit (dBuV/m)	PK Margin (dB)	U/NII Non-Restricted (dBuV/m)	PK Margin (dB)	Azimuth (Degs)	Height (cm)	Polarity
1	* 4.616	31.46	Pk	34.1	-27.5	0	38.06	-	-	74	-35.94	-	-	0-360	102	H
5	* 10.92	26.96	Pk	37.9	-19.4	0	45.46	-	-	74	-28.54	-	-	0-360	200	V
6	* 15.594	26.79	Pk	40	-17.6	0	49.19	-	-	74	-24.81	-	-	0-360	101	V
2	6.33	30	Pk	35.7	-24.8	0	40.9	-	-	-	-	68.2	-27.3	0-360	199	H
4	9.756	27.71	Pk	36.9	-21.1	0	43.51	-	-	-	-	68.2	-24.69	0-360	200	V
3	16.644	27.3	Pk	41.5	-18.7	0	50.1	-	-	-	-	68.2	-18.1	0-360	101	H

* - indicates frequency in CFR47 Pt 15 / IC RSS-Restricted Band
 Pk - Peak detector

Radiated Emissions

Frequency (GHz)	Meter Reading (dBuV)	Det	AF TMR2 (dB/m)	Amp/Ch/FHz/Pad (dB)	DC Corr (dB)	Corrected Reading (dBuV/m)	Aug Limit (dBuV/m)	Margin (dB)	Peak Limit (dBuV/m)	PK Margin (dB)	U/NII Non-Restricted (dBuV/m)	PK Margin (dB)	Azimuth (Degs)	Height (cm)	Polarity
* 4.616	37.81	PK-U	34.1	-27.5	0	44.41	-	-	74	-29.59	-	-	210	100	H
* 4.617	25.16	ADR	34.1	-27.5	.19	31.95	54	-22.05	-	-	-	-	210	100	H
* 10.921	32.48	PK-U	37.9	-19.4	0	50.98	-	-	74	-23.02	-	-	270	200	V
* 10.92	20.34	ADR	37.9	-19.4	.19	39.03	54	-14.97	-	-	-	-	270	200	V
* 15.595	32.71	PK-U	40	-17.6	0	55.11	-	-	74	-18.89	-	-	100	102	V
* 15.594	20.76	ADR	40	-17.6	.19	43.35	54	-10.65	-	-	-	-	100	102	V
6.33	35.33	PK-U	35.7	-24.8	0	46.23	-	-	-	-	68.2	-21.97	226	199	H
9.758	33.15	PK-U	36.9	-21.1	0	48.95	-	-	-	-	68.2	-19.25	191	200	V
16.646	32.14	PK-U	41.5	-18.7	0	54.94	-	-	-	-	68.2	-13.26	278	102	H

* - indicates frequency in CFR47 Pt 15 / IC RSS-Restricted Band
 PK-U - U-NII: Maximum Peak
 ADR - U-NII AD primary method, RMS average

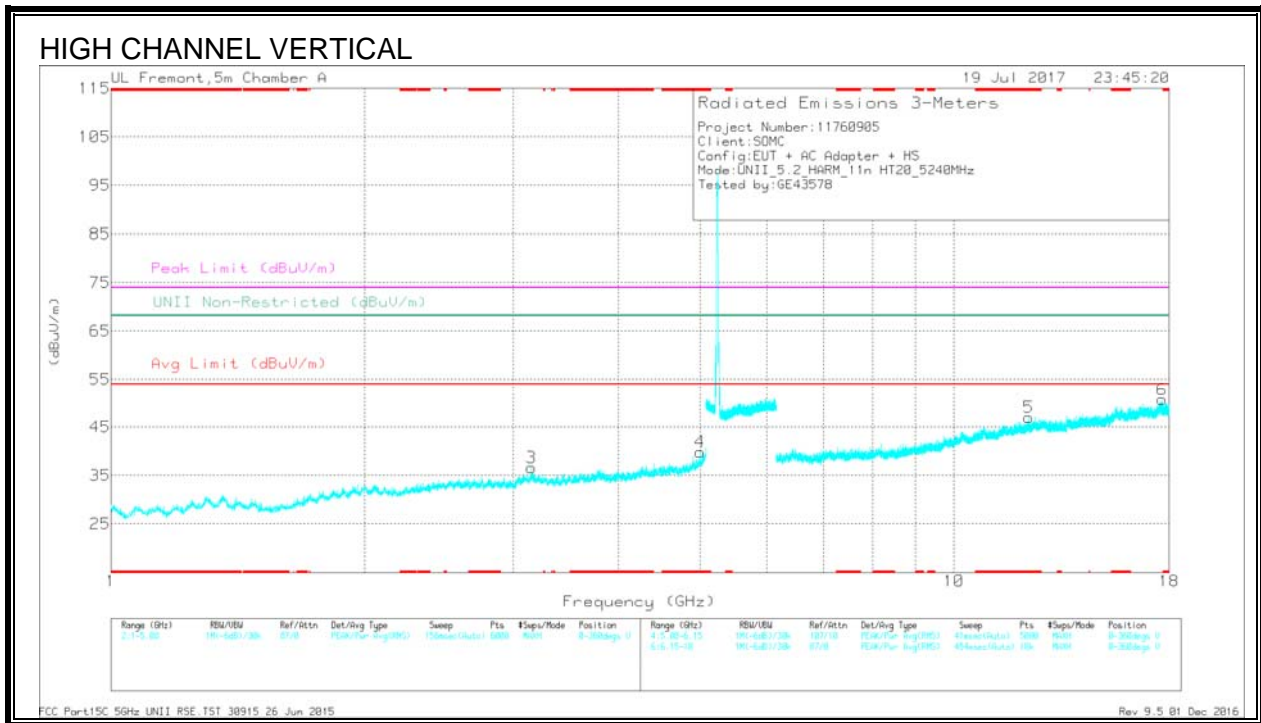
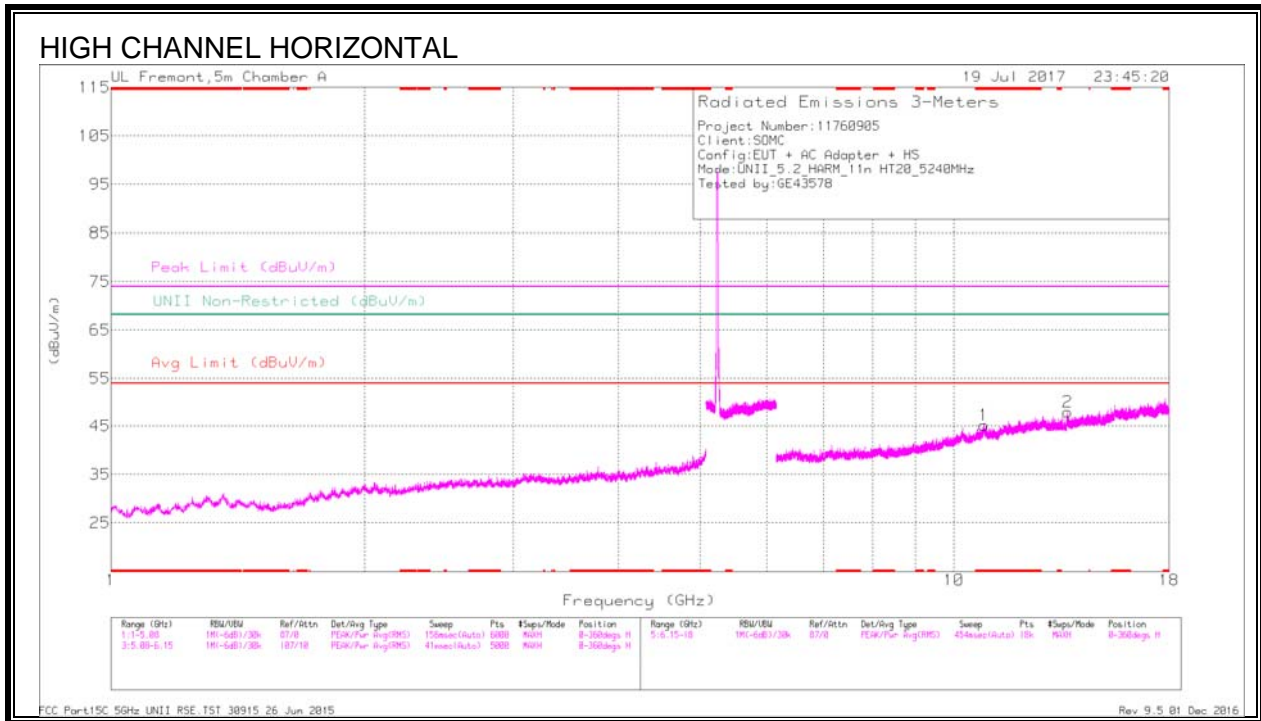

Trace Markers

Marker	Frequency (GHz)	Meter Reading (dBuV)	Det	AF T862 (dB/m)	Amp/Cou/Ftr/Pad (dB)	DC Corr (dB)	Corrected Reading (dBuV/m)	Ag Limit (dBuV/m)	Margin (dB)	Peak Limit (dBuV/m)	PK Margin (dB)	UNII Non-Restricted (dBuV/m)	PK Margin (dB)	Altitude (Deps)	Height (cm)	Polarity
4	* 4.998	32.07	Pk	34.3	-26.5	0	39.87	-	-	74	-34.13	-	-	0-360	200	V
1	* 10.853	26.02	Pk	37.9	-18.7	0	45.22	-	-	74	-28.78	-	-	0-360	101	H
5	* 12.273	26.91	Pk	39	-18.9	0	47.01	-	-	74	-26.99	-	-	0-360	200	V
3	3.151	33.4	Pk	32.8	-29.6	0	36.6	-	-	-	-	68.2	-31.6	0-360	200	V
2	13.653	28.42	Pk	39.3	-19.8	0	47.92	-	-	-	-	68.2	-20.28	0-360	101	H
6	17.646	28.18	Pk	41.3	-18.7	0	50.78	-	-	-	-	68.2	-17.42	0-360	200	V

* - indicates frequency in CFR47 Pt 15 / IC RSS-Restricted Band
 Pk - Peak detector

Radiated Emissions

Frequency (GHz)	Meter Reading (dBuV)	Det	AF T862 (dB/m)	Amp/Cou/Ftr/Pad (dB)	DC Corr (dB)	Corrected Reading (dBuV/m)	Ag Limit (dBuV/m)	Margin (dB)	Peak Limit (dBuV/m)	PK Margin (dB)	UNII Non-Restricted (dBuV/m)	PK Margin (dB)	Altitude (Deps)	Height (cm)	Polarity
* 4.998	37.43	PK-U	34.3	-26.5	0	45.23	-	-	74	-28.77	-	-	112	200	V
* 4.999	25.99	ADR	34.3	-26.5	-19	33.98	54	-20.02	-	-	-	-	112	200	V
* 10.853	32.77	PK-U	37.9	-18.7	0	51.97	-	-	74	-22.03	-	-	-	102	H
* 10.854	20.95	ADR	37.9	-18.7	-19	40.34	54	-13.66	-	-	-	-	-	102	H
* 12.273	33.03	PK-U	39	-18.9	0	53.13	-	-	74	-20.87	-	-	12	200	V
* 12.273	21.09	ADR	39	-18.9	-19	41.38	54	-12.62	-	-	-	-	12	200	V
3.153	38.64	PK-U	32.8	-29.6	0	41.84	-	-	-	-	68.2	-26.36	35	200	V
13.655	32.61	PK-U	39.3	-19.8	0	52.11	-	-	-	-	68.2	-16.09	210	102	H
17.646	33.14	PK-U	41.3	-18.7	0	55.74	-	-	-	-	68.2	-12.46	51	200	V

* - indicates frequency in CFR47 Pt 15 / IC RSS-Restricted Band
 PK-U - U-NII: Maximum Peak
 ADR - U-NII AD primary method, RMS average

11.1.3. 11n HT40 2TX CDD MIMO MODE IN THE 5.2GHZ BAND

RESTRICTED BANDEDGE (LOW CHANNEL)

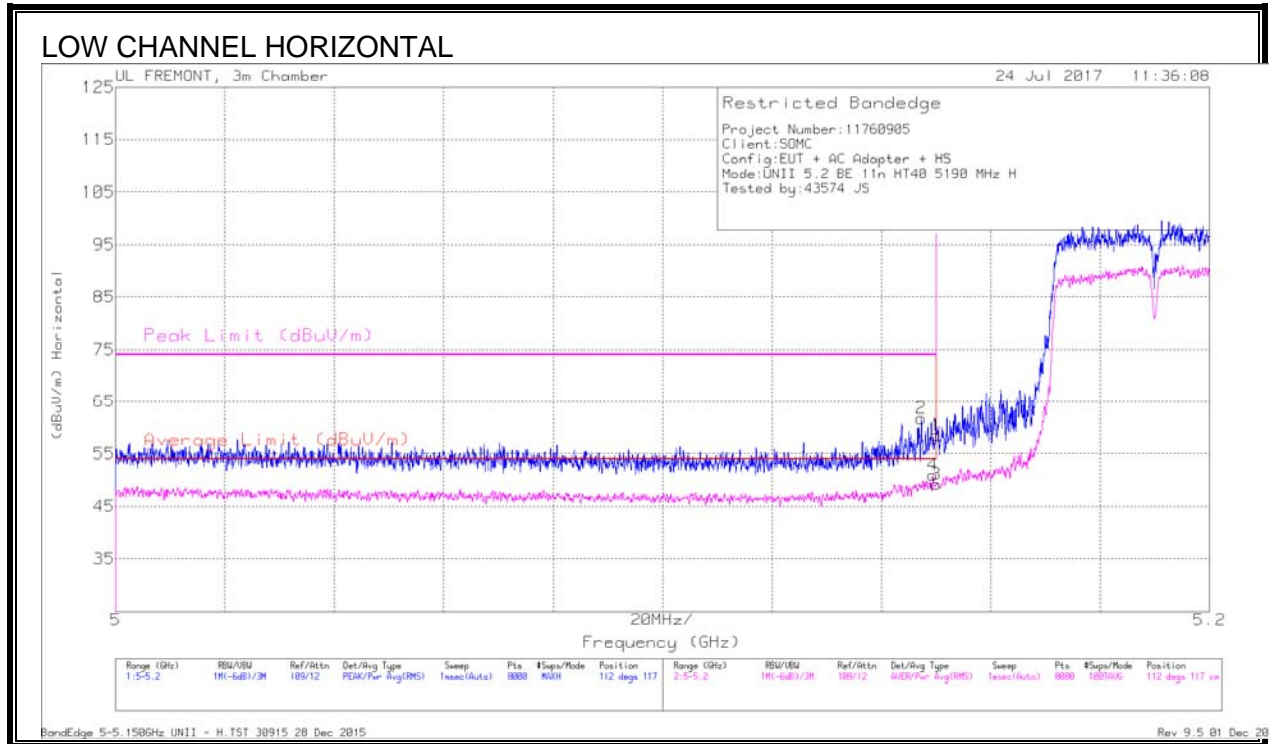

Trace Markers

Marker	Frequency (GHz)	Meter Reading (dBuV)	Det	AF T112 (dB/m)	Amp/Chl/Filt/Pad (dB)	DC Corr (dB)	Corrected Reading (dBuV/m)	Average Limit (dBuV/m)	Margin (dB)	Peak Limit (dBuV/m)	PK Margin (dB)	Azimuth (Degs)	Height (cm)	Polarity
2	5.147	46.02	Pk	34.2	-18.5	0	61.72	-	-	74	-12.28	112	117	H
4	5.149	34.85	RMS	34.2	-18.5	-39	50.94	54	-3.06	-	-	112	117	H
1	5.15	42.81	Pk	34.2	-18.5	0	58.51	-	-	74	-15.49	112	117	H
3	5.15	33.11	RMS	34.2	-18.5	-39	49.2	54	-4.8	-	-	112	117	H

Pk - Peak detector
 RMS - RMS detection

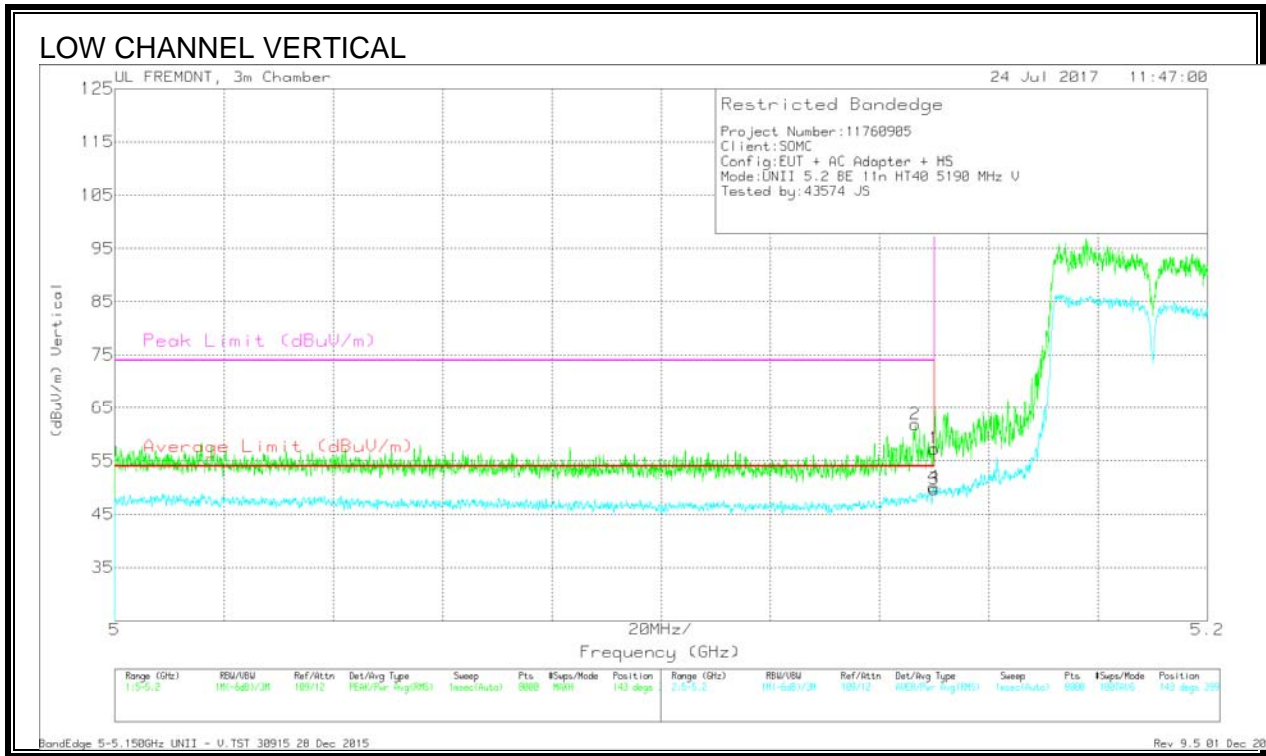

Trace Markers

Marker	Frequency (GHz)	Meter Reading (dBuV)	Det	AFT12 (dB/m)	Amp/Cbl/Fltr/Pad (dB)	DC Corr (dB)	Corrected Reading (dBuV/m)	Average Limit (dBuV/m)	Margin (dB)	Peak Limit (dBuV/m)	PK Margin (dB)	Azimuth (Degs)	Height (cm)	Polarity
2	5.147	46.12	Pk	34.2	-18.5	0	61.82	-	-	74	-12.18	143	399	V
1	5.15	41.55	Pk	34.2	-18.5	0	57.25	-	-	74	-16.75	143	399	V
3	5.15	33.59	RMS	34.2	-18.5	.39	49.68	54	-4.32	-	-	143	399	V
4	5.15	34	RMS	34.2	-18.5	.39	50.09	54	-3.91	-	-	143	399	V

Pk - Peak detector
 RMS - RMS detection

HARMONICS AND SPURIOUS EMISSIONS

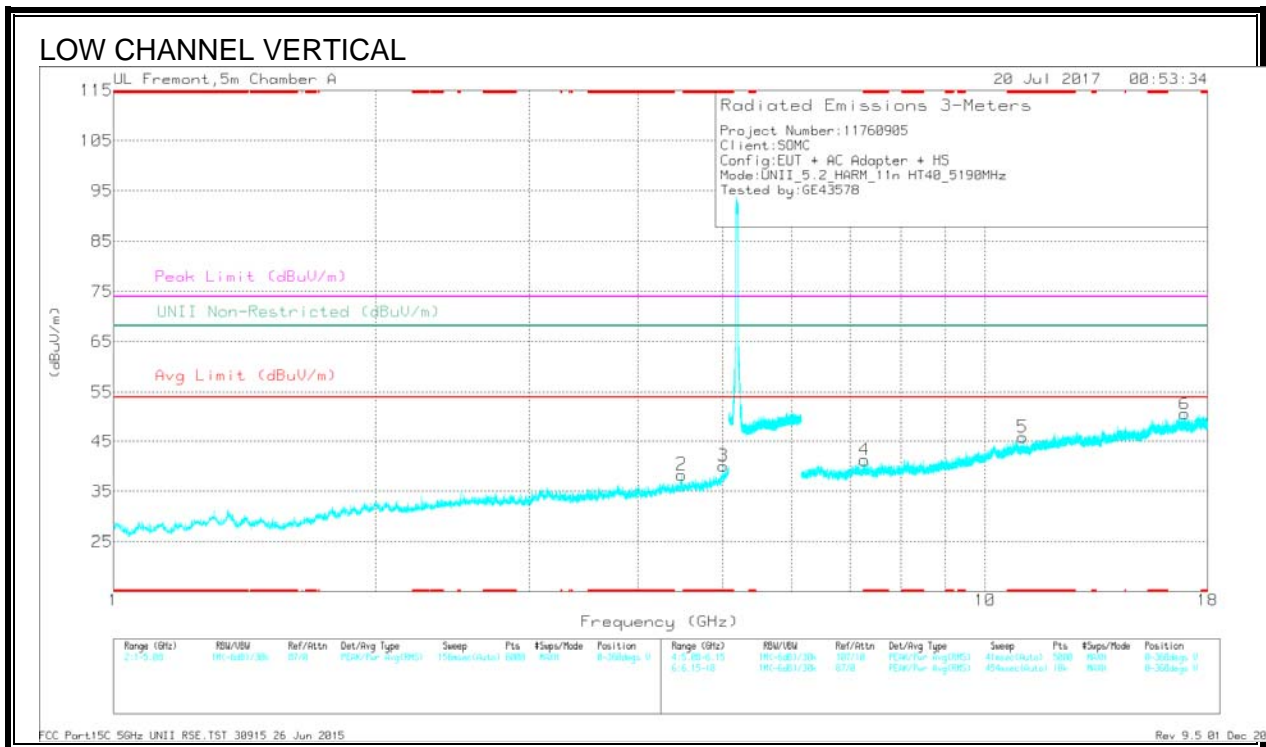
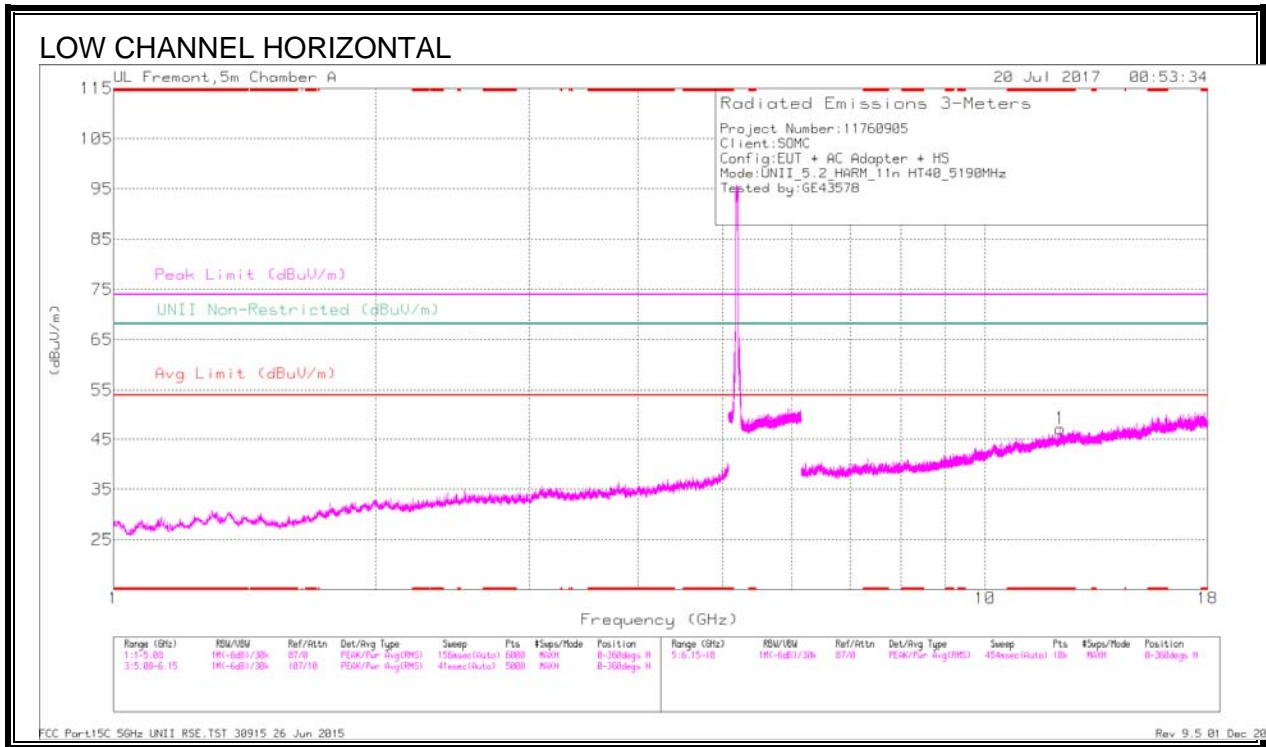

Trace Markers

Marker	Frequency (GHz)	Meter Reading (dBuV)	Det	AF T862 (dB/m)	Amp/Ch/Ftr/Pad (dB)	DC Corr (dB)	Corrected Reading (dBuV/m)	Aug Limit (dBuV/m)	Margin (dB)	Peak Limit (dBuV/m)	PK Margin (dB)	UNI Non-Restricted (dBuV/m)	PK Margin (dB)	Azimuth (Degs)	Height (cm)	Polarity
3	* 5.003	32.45	Pk	34.3	-26.6	0	40.15	-	-	74	-33.85	-	-	0-360	101	V
1	* 12.195	27.56	Pk	39	-19.4	0	47.16	-	-	74	-26.84	-	-	0-360	101	H
4	* 7.273	29.2	Pk	35.7	-23.6	0	41.3	-	-	74	-32.7	-	-	0-360	101	V
5	* 11.037	27.71	Pk	37.9	-19.8	0	45.81	-	-	74	-28.19	-	-	0-360	101	V
2	4.489	32.36	Pk	33.8	-27.8	0	38.36	-	-	-	-	68.2	-29.84	0-360	101	V
6	16.935	28	Pk	41.7	-19.2	0	50.5	-	-	-	-	68.2	-17.7	0-360	101	V

* - indicates frequency in CFR47 Pt 15 / IC RSS-Restricted Band
 Pk - Peak detector

Radiated Emissions

Frequency (GHz)	Meter Reading (dBuV)	Det	AF T862 (dB/m)	Amp/Ch/Ftr/Pad (dB)	DC Corr (dB)	Corrected Reading (dBuV/m)	Aug Limit (dBuV/m)	Margin (dB)	Peak Limit (dBuV/m)	PK Margin (dB)	UNI Non-Restricted (dBuV/m)	PK Margin (dB)	Azimuth (Degs)	Height (cm)	Polarity
* 5.003	37.07	PK-U	34.3	-26.6	0	44.77	-	-	74	-29.23	-	-	302	100	V
* 5.003	25.1	ADR	34.3	-26.6	-.39	33.19	54	-20.81	-	-	-	-	302	100	V
* 12.196	32.83	PK-U	39	-19.4	0	52.43	-	-	74	-21.57	-	-	334	100	H
* 12.195	21.15	ADR	39	-19.4	-.39	41.14	54	-12.86	-	-	-	-	334	100	H
* 7.272	34.82	PK-U	35.7	-23.6	0	46.92	-	-	74	-27.08	-	-	205	100	V
* 7.272	22.55	ADR	35.7	-23.6	-.39	35.04	54	-18.96	-	-	-	-	205	100	V
* 11.038	33.09	PK-U	37.9	-19.8	0	51.19	-	-	74	-22.81	-	-	144	100	V
* 11.036	21.2	ADR	37.9	-19.8	-.39	39.69	54	-14.31	-	-	-	-	144	100	V
4.488	37.76	PK-U	33.8	-27.8	0	43.76	-	-	-	-	68.2	-24.44	60	100	V
16.936	32.51	PK-U	41.7	-19.1	0	55.11	-	-	-	-	68.2	-13.09	22	100	V

* - indicates frequency in CFR47 Pt 15 / IC RSS-Restricted Band
 PK-U - U-NII: Maximum Peak
 ADR - U-NII AD primary method, RMS average

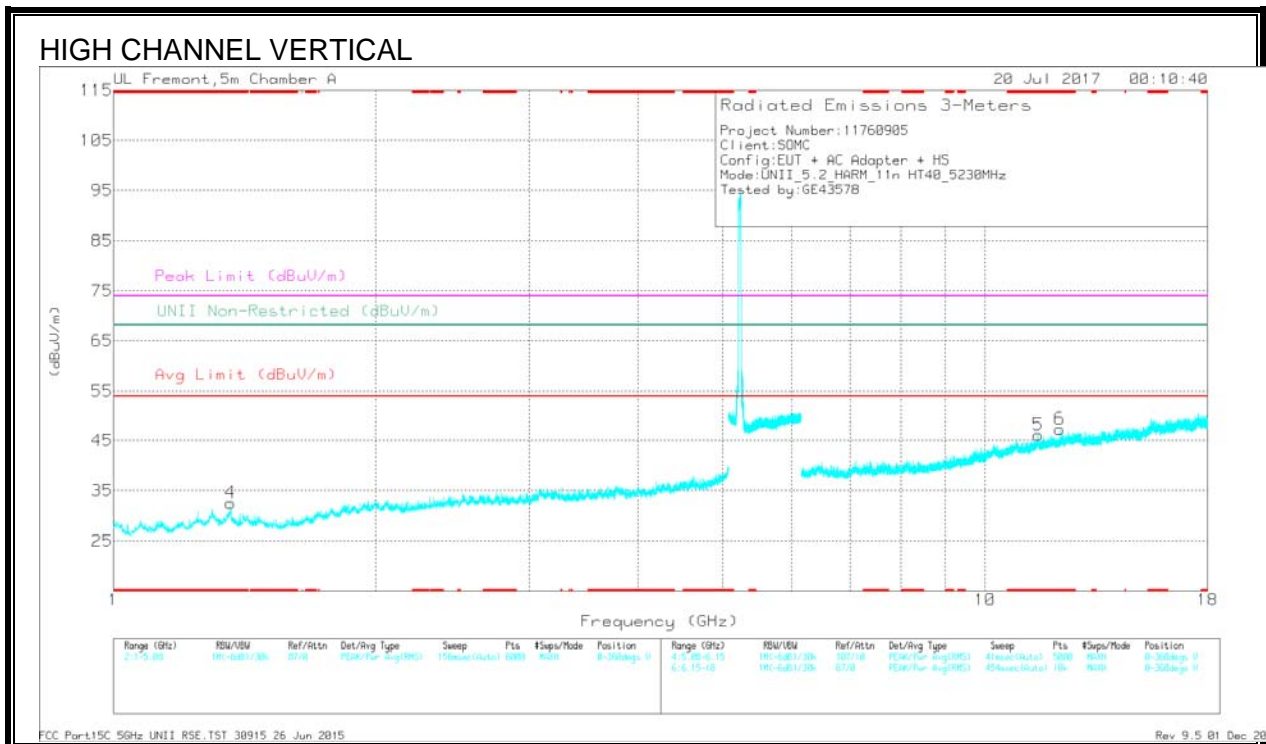
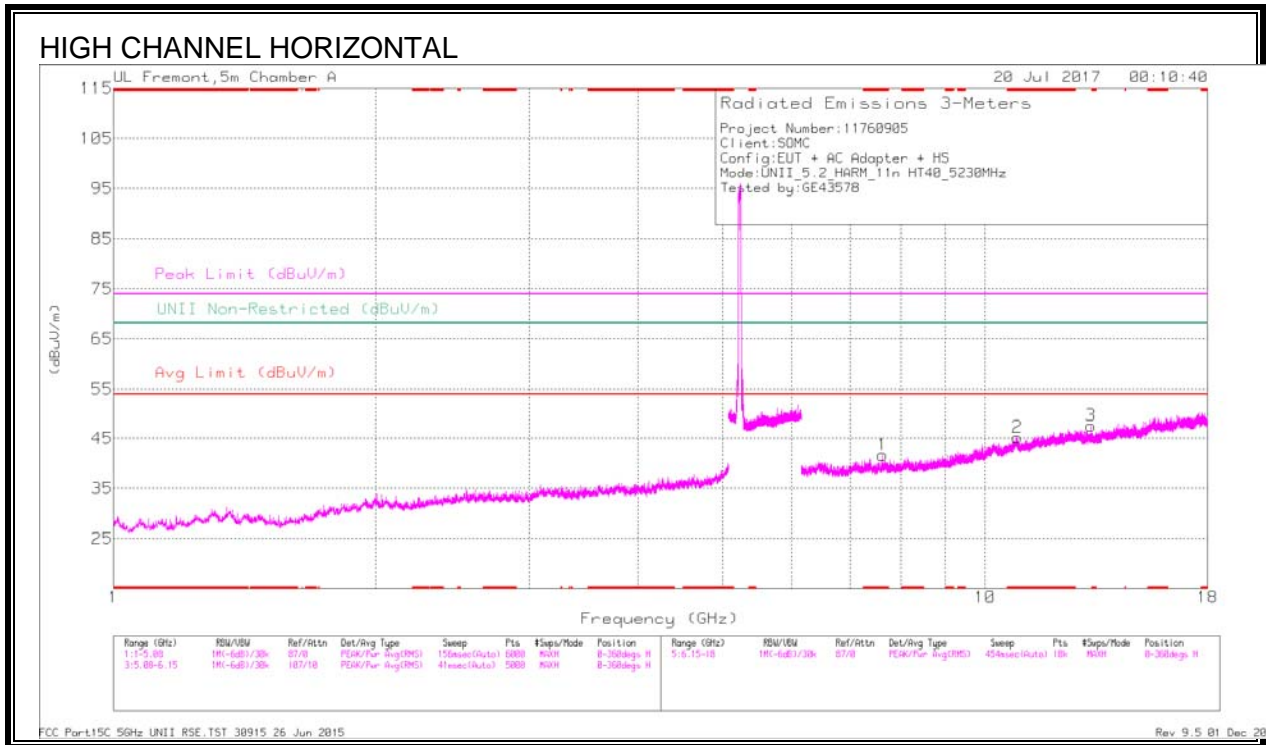

Trace Markers

Marker	Frequency (GHz)	Meter Reading (dBuV)	Det	AF T862 (dB/m)	Amp/Cb/Pk/Pad (dB)	DC Corr (dB)	Corrected Reading (dBuV/m)	Aug Limit (dBuV/m)	Margin (dB)	Peak Limit (dBuV/m)	PK Margin (dB)	U-NII Non-Restricted (dBuV/m)	PK Margin (dB)	Azimuth (Degs)	Height (cm)	Polarity
4	* 1.363	36.05	Pk	29.3	-32.8	0	32.55	-	-	74	-41.45	-	-	0-360	200	V
1	* 7.626	28.73	Pk	35.7	-22.8	0	41.63	-	-	74	-32.37	-	-	0-360	199	H
2	* 10.891	26.8	Pk	37.9	-19.5	0	45.2	-	-	74	-28.8	-	-	0-360	199	H
5	* 11.51	27.24	Pk	38.3	-19.5	0	46.04	-	-	74	-27.96	-	-	0-360	200	V
6	* 12.185	27.66	Pk	39	-19.4	0	47.26	-	-	74	-26.74	-	-	0-360	101	V
3	13.218	28.06	Pk	39.2	-19.8	0	47.46	-	-	-	-	68.2	-20.74	0-360	101	H

* - indicates frequency in CFR47 Pt 15 / IC RSS-Restricted Band
 Pk - Peak detector

Radiated Emissions

Frequency (GHz)	Meter Reading (dBuV)	Det	AF T862 (dB/m)	Amp/Cb/Pk/Pad (dB)	DC Corr (dB)	Corrected Reading (dBuV/m)	Aug Limit (dBuV/m)	Margin (dB)	Peak Limit (dBuV/m)	PK Margin (dB)	U-NII Non-Restricted (dBuV/m)	PK Margin (dB)	Azimuth (Degs)	Height (cm)	Polarity
* 1.363	41	PK-U	29.3	-32.8	0	37.5	-	-	74	-36.5	-	-	94	200	V
* 1.362	28.83	ADR	29.3	-32.8	.39	25.72	54	-28.28	-	-	-	-	94	200	V
* 7.626	33.61	PK-U	35.7	-22.8	0	46.51	-	-	74	-27.49	-	-	132	200	H
* 7.626	21.79	ADR	35.7	-22.8	.39	35.08	54	-18.92	-	-	-	-	132	200	H
* 10.89	33.11	PK-U	37.9	-19.5	0	51.51	-	-	74	-22.49	-	-	102	200	H
* 10.89	20.42	ADR	37.9	-19.5	.39	39.21	54	-14.79	-	-	-	-	102	200	H
* 11.51	32.72	PK-U	38.3	-19.5	0	51.52	-	-	74	-22.48	-	-	201	200	V
* 11.51	20.63	ADR	38.3	-19.5	.39	39.82	54	-14.18	-	-	-	-	201	200	V
* 12.185	32.5	PK-U	39	-19.4	0	52.1	-	-	74	-21.9	-	-	49	102	V
* 12.185	20.55	ADR	39	-19.4	.39	40.54	54	-13.46	-	-	-	-	49	102	V
13.219	32.17	PK-U	39.2	-19.8	0	51.57	-	-	-	-	68.2	-16.63	269	102	H

* - indicates frequency in CFR47 Pt 15 / IC RSS-Restricted Band
 PK-U - U-NII: Maximum Peak
 ADR - U-NII AD primary method, RMS average

11.1.4. 11ac VHT80 2TX CDD MIMO MODE IN THE 5.2GHZ BAND

RESTRICTED BANDEDGE (LOW CHANNEL)

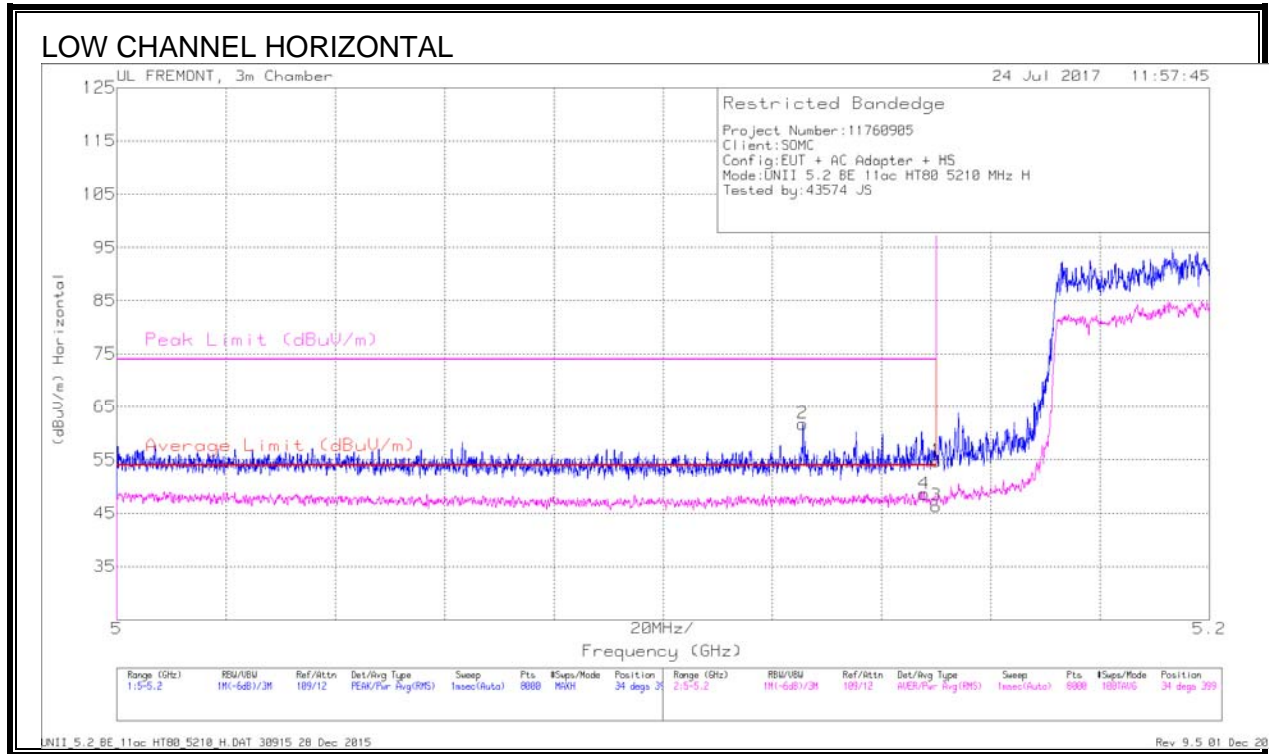

Trace Markers

f	Frequency (GHz)	Meter Reading (dBuV)	Det	AFT712 (dB/m)	Amp/Cbl/Ftr/Pad (dB)	DC Corr (dB)	Corrected Reading (dBuV/m)	Average Limit (dBuV/m)	Margin (dB)	Peak Limit (dBuV/m)	PK Margin (dB)	Azimuth (Degs)	Height (cm)	Polarity
2	5.126	45.95	PK	34.1	-18.3	0	61.75	-	-	74	-12.25	34	399	H
4	5.148	32.62	RMS	34.2	-18.5	.71	49.03	54	-4.97	-	-	34	399	H
1	5.15	39.05	PK	34.2	-18.5	0	54.75	-	-	74	-19.25	34	399	H
3	5.15	30.42	RMS	34.2	-18.5	.71	46.83	54	-7.17	-	-	34	399	H

Pk - Peak detector
 RMS - RMS detection

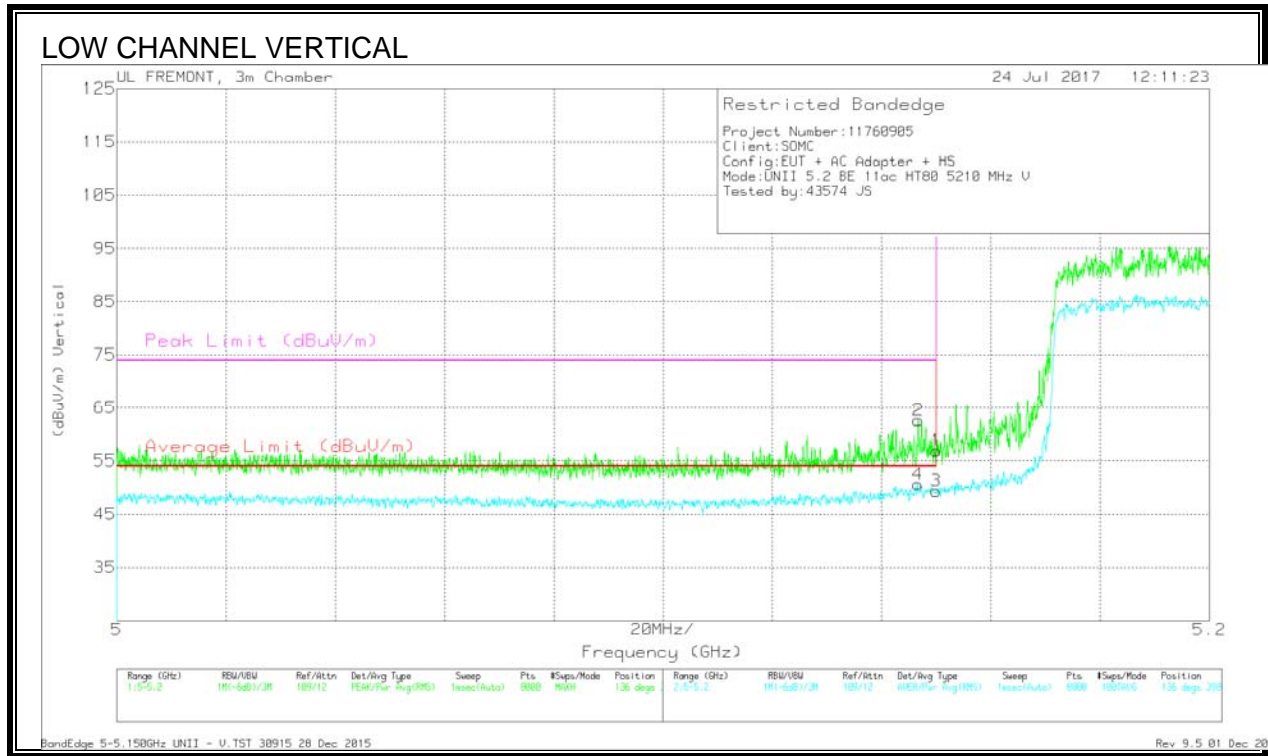

Trace Markers

Marker	Frequency (GHz)	Meter Reading (dBuV)	Det	AFT12 (dB/m)	Amp/Cbl/Fltr/Pad (dB)	DC Corr (dB)	Corrected Reading (dBuV/m)	Average Limit (dBuV/m)	Margin (dB)	Peak Limit (dBuV/m)	PK Margin (dB)	Azimuth (Degs)	Height (cm)	Polarity
2	5.147	46.86	Pk	34.2	-18.5	0	62.56	-	-	74	-11.44	136	398	V
4	5.147	34.13	RMS	34.2	-18.5	.71	50.54	54	-3.46	-	-	136	398	V
1	5.15	41.16	Pk	34.2	-18.5	0	56.86	-	-	74	-17.14	136	398	V
3	5.15	32.9	RMS	34.2	-18.5	.71	49.31	54	-4.69	-	-	136	398	V

Pk - Peak detector
 RMS - RMS detection

HARMONICS AND SPURIOUS EMISSIONS

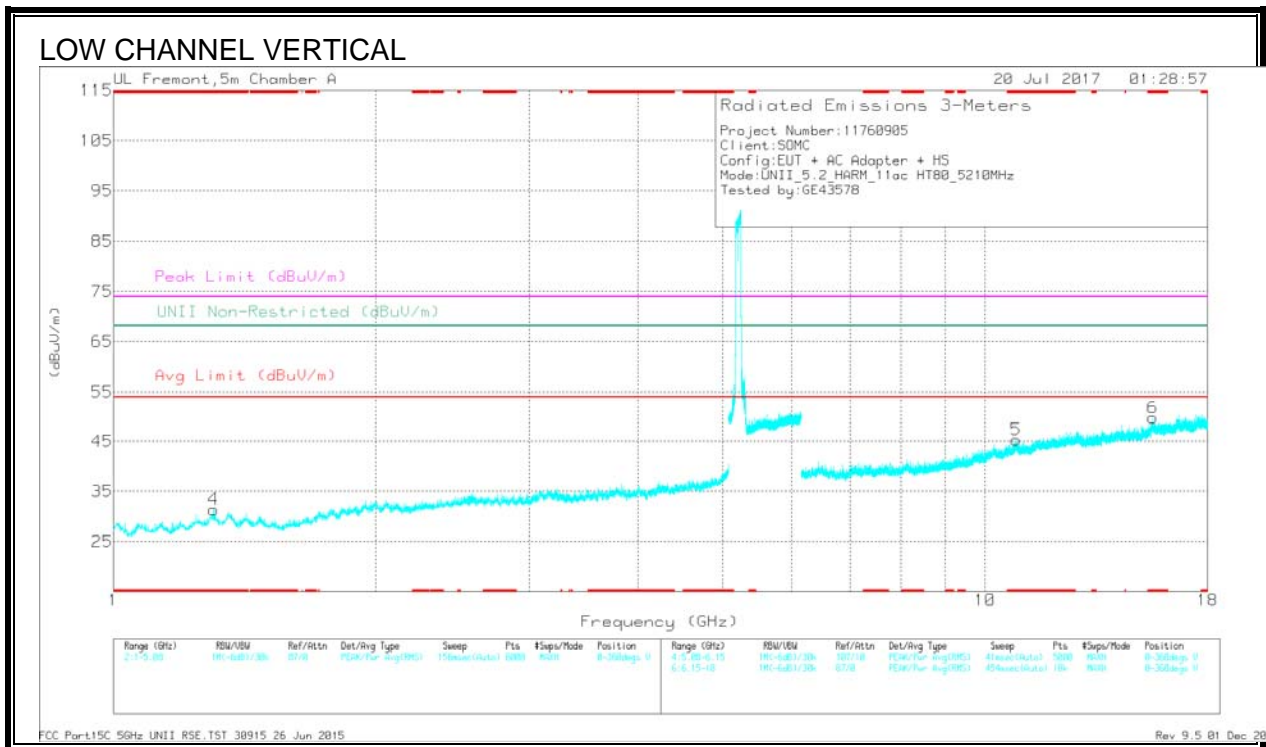
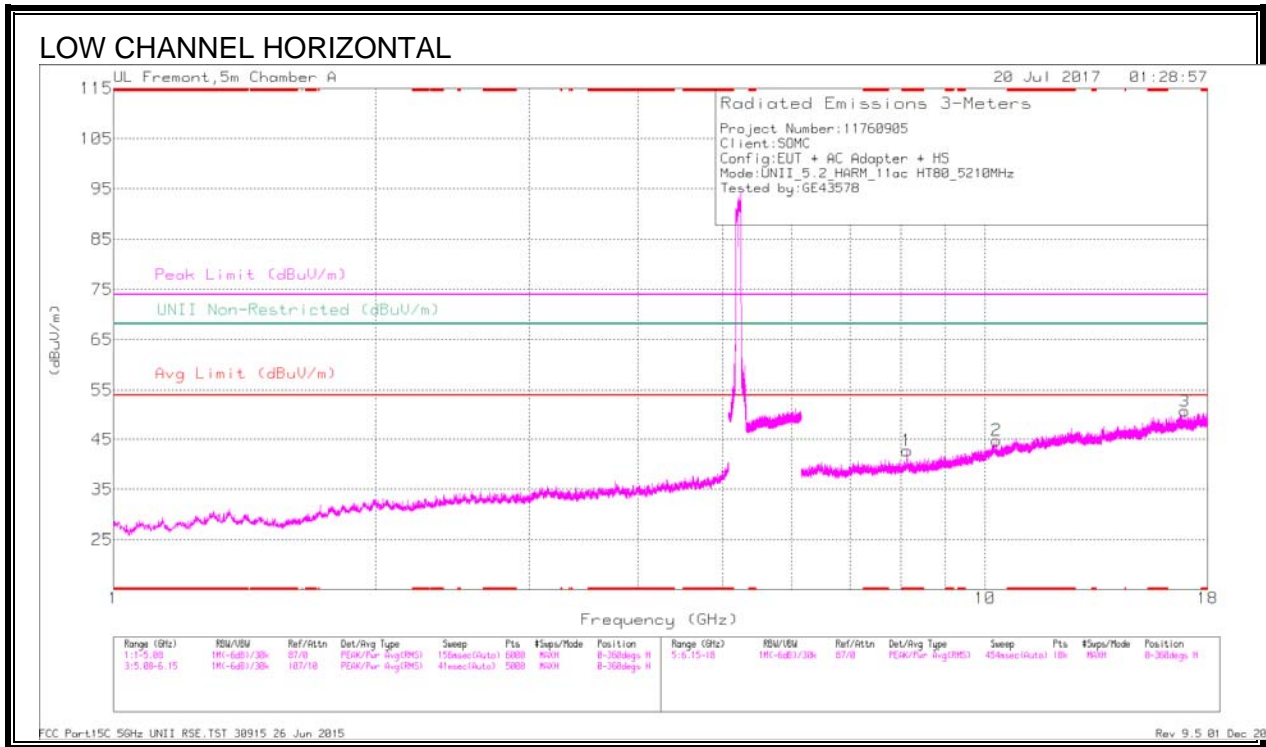

Trace Markers

Marker	Frequency (GHz)	Meter Reading (dBuV)	Det	AF TMR2 (dB/m)	Amp/Ch/Filt/Pad (dB)	DC Corr (dB)	Corrected Reading (dBuV/m)	Avg Limit (dBuV/m)	Margin (dB)	Peak Limit (dBuV/m)	PK Margin (dB)	U-NII Non-Restricted (dBuV/m)	PK Margin (dB)	Altitude (Degs)	Height (cm)	Polarity
4	* 1.302	35.16	Pk	29.4	-33.1	0	31.46	-	-	74	-42.54	-	-	0-360	200	V
1	* 8.138	29.46	Pk	35.8	-22.5	0	42.76	-	-	74	-31.24	-	-	0-360	101	H
5	* 10.854	26.06	Pk	37.9	-18.7	0	45.26	-	-	74	-28.74	-	-	0-360	200	V
6	* 15.585	27.27	Pk	40	-17.5	0	49.77	-	-	74	-24.23	-	-	0-360	101	V
2	10.302	27.4	Pk	37.5	-20.1	0	44.8	-	-	-	-	68.2	-23.4	0-360	199	H
3	16.955	27.81	Pk	41.6	-18.8	0	50.61	-	-	-	-	68.2	-17.59	0-360	199	H

* - indicates frequency in CFR47 Pt 15 / IC RSS-Restricted Band
 Pk - Peak detector

Radiated Emissions

Frequency (GHz)	Meter Reading (dBuV)	Det	AF TMR2 (dB/m)	Amp/Ch/Filt/Pad (dB)	DC Corr (dB)	Corrected Reading (dBuV/m)	Avg Limit (dBuV/m)	Margin (dB)	Peak Limit (dBuV/m)	PK Margin (dB)	U-NII Non-Restricted (dBuV/m)	PK Margin (dB)	Altitude (Degs)	Height (cm)	Polarity
* 1.303	41.03	PK-U	29.4	-33.1	0	37.33	-	-	74	-36.67	-	-	116	200	V
* 1.301	28.87	ADR	29.4	-33.1	.71	25.88	54	-28.12	-	-	-	-	116	200	V
* 8.138	34.18	PK-U	35.8	-22.6	0	47.38	-	-	74	-26.62	-	-	260	102	H
* 8.138	21.89	ADR	35.8	-22.5	.71	35.9	54	-18.1	-	-	-	-	260	102	H
* 10.855	32.25	PK-U	37.9	-18.7	0	51.45	-	-	74	-22.55	-	-	277	199	V
* 10.854	20.96	ADR	37.9	-18.7	.71	40.87	54	-13.13	-	-	-	-	277	199	V
* 15.585	32.64	PK-U	40	-17.5	0	55.14	-	-	74	-18.86	-	-	-	102	V
* 15.584	21.3	ADR	40	-17.5	.71	44.51	54	-9.49	-	-	-	-	-	102	V
10.302	32.2	PK-U	37.5	-20.1	0	49.6	-	-	-	-	68.2	-18.6	0	199	H
16.957	32.32	PK-U	41.6	-18.8	0	55.12	-	-	-	-	68.2	-13.08	321	199	H

* - indicates frequency in CFR47 Pt 15 / IC RSS-Restricted Band
 PK-U - U-NII: Maximum Peak
 ADR - U-NII AD primary method, RMS average