



# **CERTIFICATION TEST REPORT**

**Report Number. :** 11760905-E2V1

**Applicant :** SONY MOBILE COMMUNICATIONS, INC.  
4-12-3 HIGASHI-SHINAGAWA,  
SHINAGAWA -KU, TOKYO, 140-0002, JAPAN

**FCC ID :** PY7-32042D

**EUT Description :** GSM/WCDMA/LTE Phone with BT, DTS/UNII a/b/g/n/ac, GPS & NFC

**Test Standard(s) :** FCC 47 CFR PART 15 SUBPART C

**Date Of Issue:**

July 26, 2017

**Prepared by:**

UL Verification Services Inc.  
47173 Benicia Street  
Fremont, CA 94538, U.S.A.  
TEL: (510) 771-1000  
FAX: (510) 661-0888



NVLAP LAB CODE 200065-0

---

Revision History

<u>Rev.</u>	<u>Issue Date</u>	<u>Revisions</u>	<u>Revised By</u>
V1	07/26/17	Initial Review	D. Corona

## TABLE OF CONTENTS

<b>1. ATTESTATION OF TEST RESULTS</b> .....	<b>5</b>
<b>2. TEST METHODOLOGY</b> .....	<b>6</b>
<b>3. FACILITIES AND ACCREDITATION</b> .....	<b>6</b>
<b>4. CALIBRATION AND UNCERTAINTY</b> .....	<b>7</b>
4.1. <i>MEASURING INSTRUMENT CALIBRATION</i> .....	7
4.2. <i>SAMPLE CALCULATION</i> .....	7
4.3. <i>MEASUREMENT UNCERTAINTY</i> .....	7
<b>5. EQUIPMENT UNDER TEST</b> .....	<b>8</b>
5.1. <i>DESCRIPTION OF EUT</i> .....	8
5.2. <i>MAXIMUM OUTPUT POWER</i> .....	8
5.3. <i>DESCRIPTION OF AVAILABLE ANTENNAS</i> .....	8
5.4. <i>SOFTWARE AND FIRMWARE</i> .....	8
5.5. <i>WORST-CASE CONFIGURATION AND MODE</i> .....	9
5.6. <i>DESCRIPTION OF TEST SETUP</i> .....	10
<b>6. TEST AND MEASUREMENT EQUIPMENT</b> .....	<b>13</b>
<b>7. ANTENNA PORT TEST RESULTS</b> .....	<b>14</b>
7.1. <i>BASIC DATA RATE GFSK MODULATION</i> .....	15
7.1.1. 20 dB AND 99% BANDWIDTH .....	15
7.1.2. HOPPING FREQUENCY SEPARATION .....	18
7.1.3. NUMBER OF HOPPING CHANNELS.....	19
7.1.4. AVERAGE TIME OF OCCUPANCY .....	22
7.1.5. OUTPUT POWER .....	26
7.1.6. AVERAGE POWER .....	27
7.1.7. CONDUCTED BANDEDGE AND SPURIOUS EMISSIONS .....	28
7.2. <i>ENHANCED DATA RATE 8PSK MODULATION</i> .....	32
7.2.1. 20 dB AND 99% BANDWIDTH .....	32
7.2.2. HOPPING FREQUENCY SEPARATION .....	35
7.2.3. NUMBER OF HOPPING CHANNELS.....	36
7.2.4. AVERAGE TIME OF OCCUPANCY .....	39
7.2.5. OUTPUT POWER .....	43
7.2.6. AVERAGE POWER .....	44
7.2.7. CONDUCTED BANDEDGE AND SPURIOUS EMISSIONS .....	45
<b>8. RADIATED TEST RESULTS</b> .....	<b>49</b>
8.1. <i>LIMITS AND PROCEDURE</i> .....	49

---

8.2.	<i>BASIC DATA RATE GFSK MODULATION</i> .....	50
8.2.1.	RESTRICTED BANDEDGE (LOW CHANNEL).....	50
8.2.2.	AUTHORIZED BANDEDGE (HIGH CHANNEL) .....	52
8.2.3.	HARMONICS AND SPURIOUS EMISSIONS .....	54
8.3.	<i>ENHANCED DATA RATE 8PSK MODULATION</i> .....	60
8.3.1.	RESTRICTED BANDEDGE (LOW CHANNEL).....	60
8.3.2.	AUTHORIZED BANDEDGE (HIGH CHANNEL) .....	62
8.3.3.	HARMONICS AND SPURIOUS EMISSIONS .....	64
8.4.	<i>WORST-CASE BELOW 30 MHz</i> .....	70
8.5.	<i>WORST-CASE BELOW 1 GHz</i> .....	71
8.6.	<i>WORST-CASE ABOVE 18 GHz</i> .....	73
<b>9.</b>	<b>AC POWER LINE CONDUCTED EMISSIONS</b> .....	<b>75</b>
<b>10.</b>	<b>SETUP PHOTOS</b> .....	<b>78</b>

# 1. ATTESTATION OF TEST RESULTS

**COMPANY NAME:** SONY MOBILE COMMUNICATIONS, INC.  
4-12-3 HIGASHI-SHINAGAWA,  
SHINAGAWA -KU, TOKYO, 140-0002, JAPAN

**EUT DESCRIPTION:** GSM/WCDMA/LTE Phone with BT, DTS/UNII a/b/g/n/ac, GPS & NFC

**SERIAL NUMBER:** RADIATED: BH9000HG8, BH90009E85  
CONDUCTED: BH9000U97W, BH9000TU7W

**DATE TESTED:** JULY 08 - 21, 2017

APPLICABLE STANDARDS	
STANDARD	TEST RESULTS
CFR 47 Part 15 Subpart C	Pass

UL Verification Services Inc. tested the above equipment in accordance with the requirements set forth in the above standards. All indications of Pass/Fail in this report are opinions expressed by UL Verification Services Inc. based on interpretations and/or observations of test results. Measurement Uncertainties were not taken into account and are published for informational purposes only. The test results show that the equipment tested is capable of demonstrating compliance with the requirements as documented in this report.

**Note:** The results documented in this report apply only to the tested sample, under the conditions and modes of operation as described herein. This document may not be altered or revised in any way unless done so by UL Verification Services Inc. and all revisions are duly noted in the revisions section. Any alteration of this document not carried out by UL Verification Services Inc. will constitute fraud and shall nullify the document. This report must not be used by the client to claim product certification, approval, or endorsement by NVLAP, NIST, any agency of the Federal Government, or any agency of any government.

Approved & Released For  
UL Verification Services Inc. By:



DAN CORONIA  
WISE PROJECT LEAD  
UL VERIFICATION SERVICES INC.

Prepared By:



GLENN ESCANO  
WISE LAB ENGINEER  
UL VERIFICATION SERVICES INC.

## 2. TEST METHODOLOGY

The tests documented in this report were performed in accordance with FCC CFR 47 Part 2, FCC CFR 47 Part 15, ANSI C63.10-2013.

## 3. FACILITIES AND ACCREDITATION

The test sites and measurement facilities used to collect data are located at 47173 and 47266 Benicia Street, Fremont, California, USA. Line conducted emissions are measured only at the 47173 address. The following table identifies which facilities were utilized for radiated emission measurements documented in this report. Specific facilities are also identified in the test results sections.

47173 Benicia Street	47266 Benicia Street
<input type="checkbox"/> Chamber A(IC: 2324B-1)	<input type="checkbox"/> Chamber D(IC: 22541-1)
<input checked="" type="checkbox"/> Chamber B(IC: 2324B-2)	<input type="checkbox"/> Chamber E(IC: 22541-2)
<input checked="" type="checkbox"/> Chamber C(IC: 2324B-3)	<input type="checkbox"/> Chamber F(IC: 22541-3)
	<input type="checkbox"/> Chamber G(IC: 22541-4)
	<input type="checkbox"/> Chamber H(IC: 22541-5)

The above test sites and facilities are covered under FCC Test Firm Registration # 208313. UL Verification Services Inc. is accredited by NVLAP, Laboratory Code 200065-0. Chambers A through C are covered under Industry Canada company address code 2324B with site numbers 2324B -1 through 2324B-3, respectively. Chambers D through H are covered under Industry Canada company address code 22541 with site numbers 22541 -1 through 22541-5, respectively.

## 4. CALIBRATION AND UNCERTAINTY

### 4.1. MEASURING INSTRUMENT CALIBRATION

The measuring equipment utilized to perform the tests documented in this report has been calibrated in accordance with the manufacturer's recommendations, and is traceable to recognized national standards.

### 4.2. SAMPLE CALCULATION

Where relevant, the following sample calculation is provided:

$$\begin{aligned} \text{Field Strength (dBuV/m)} &= \text{Measured Voltage (dBuV)} + \text{Antenna Factor (dB/m)} + \\ &\text{Cable Loss (dB)} - \text{Preamp Gain (dB)} \\ 36.5 \text{ dBuV} + 18.7 \text{ dB/m} + 0.6 \text{ dB} - 26.9 \text{ dB} &= 28.9 \text{ dBuV/m} \end{aligned}$$

### 4.3. MEASUREMENT UNCERTAINTY

Where relevant, the following measurement uncertainty levels have been estimated for tests performed on the apparatus:

Parameter	Uncertainty
Worst Case Conducted Disturbance, 9KHz to 0.15 MHz	3.84 dB
Worst Case Conducted Disturbance, 0.15 to 30 MHz	3.65 dB
Worst Case Radiated Disturbance, 9KHz to 30 MHz	3.15 dB
Worst Case Radiated Disturbance, 30 to 1000 MHz	5.36 dB
Worst Case Radiated Disturbance, 1000 to 18000 MHz	4.32 dB
Worst Case Radiated Disturbance, 18000 to 26000 MHz	4.45 dB
Worst Case Radiated Disturbance, 26000 to 40000 MHz	5.24 dB

Uncertainty figures are valid to a confidence level of 95%.

## 5. EQUIPMENT UNDER TEST

### 5.1. DESCRIPTION OF EUT

The EUT is a GSM/WCDMA/LTE Phone with BT, DTS/UNII a/b/g/n/ac, GPS & NFC.

### 5.2. MAXIMUM OUTPUT POWER

The transmitter has a maximum peak conducted output power as follows:

Frequency Range (MHz)	Mode	Output Power (dBm)	Output Power (mW)
2402 - 2480	Basic GFSK	9.86	9.68
2402 - 2480	Enhanced 8PSK	9.31	8.53

### 5.3. DESCRIPTION OF AVAILABLE ANTENNAS

The radio utilizes integrated antenna, with the maximum gains:

Frequency Band (GHz)	Antenna Gain (dBi)
2402-2480	-3.70

### 5.4. SOFTWARE AND FIRMWARE

The firmware installed in the EUT during testing was SONY, s\_atp\_1\_00139\_B\_10\_5.  
The test utility software used during testing was Tera Term Ver 4.79.



---

## 5.5. WORST-CASE CONFIGURATION AND MODE

Radiated band edge, harmonics, and spurious emissions from 1 GHz to 18GHz were performed with the EUT was set to transmit at the Low/Middle/High channels.

Radiated emission below 30MHz, below 1GHz, above 18GHz, and power line conducted emission were performed with the EUT was set to transmit at the channel with highest output power as worst-case scenario.

The fundamental of the EUT was investigated in three orthogonal orientations X, Y, & Z, and it was determined that Z-Axis orientation was worst-case orientation; therefore, all final radiated testing was performed with the EUT in Z-Axis orientation.

Worst-case data rates were:

GFSK mode: DH5  
8PSK mode: 3-DH5

DQPSK mode has been verified to have the lowest power.

## 5.6. DESCRIPTION OF TEST SETUP

### SUPPORT EQUIPMENT

Support Equipment List				
Description	Manufacturer	Model	Serial Number	FCC ID
Laptop	Lenovo	20B7S0A200	PC015REW	NA
AC Adapter	SONY	UCH 20	3416W45305756	NA
Headphones	SONY	N/A	N/A	N/A

### I/O CABLES (CONDUCTED TEST)

I/O Cable List						
Cable No	Port	# of identical ports	Connector Type	Cable Type	Cable Length (m)	Remarks
1	Antenna	1	RF	Shielded	0.2	To spectrum Analyzer
2	USB	1	USB	Shielded	1	N/A
3	DC	1	DC	Shielded	0.3	N/A

### I/O CABLES (RADIATED AND CONDUCTED EMISSIONS)

I/O Cable List						
Cable No	Port	# of identical ports	Connector Type	Cable Type	Cable Length (m)	Remarks
1	USB	1	USB	Shielded	3	N/A
2	Audio	1	3.5mm	Shielded	1	N/A

**TEST SETUP- CONDUCTED PORT**

The EUT was tested connected to a host Laptop via USB cable adapter and spectrum analyzer to antenna port. Test software exercised the EUT.

**SETUP DIAGRAM**

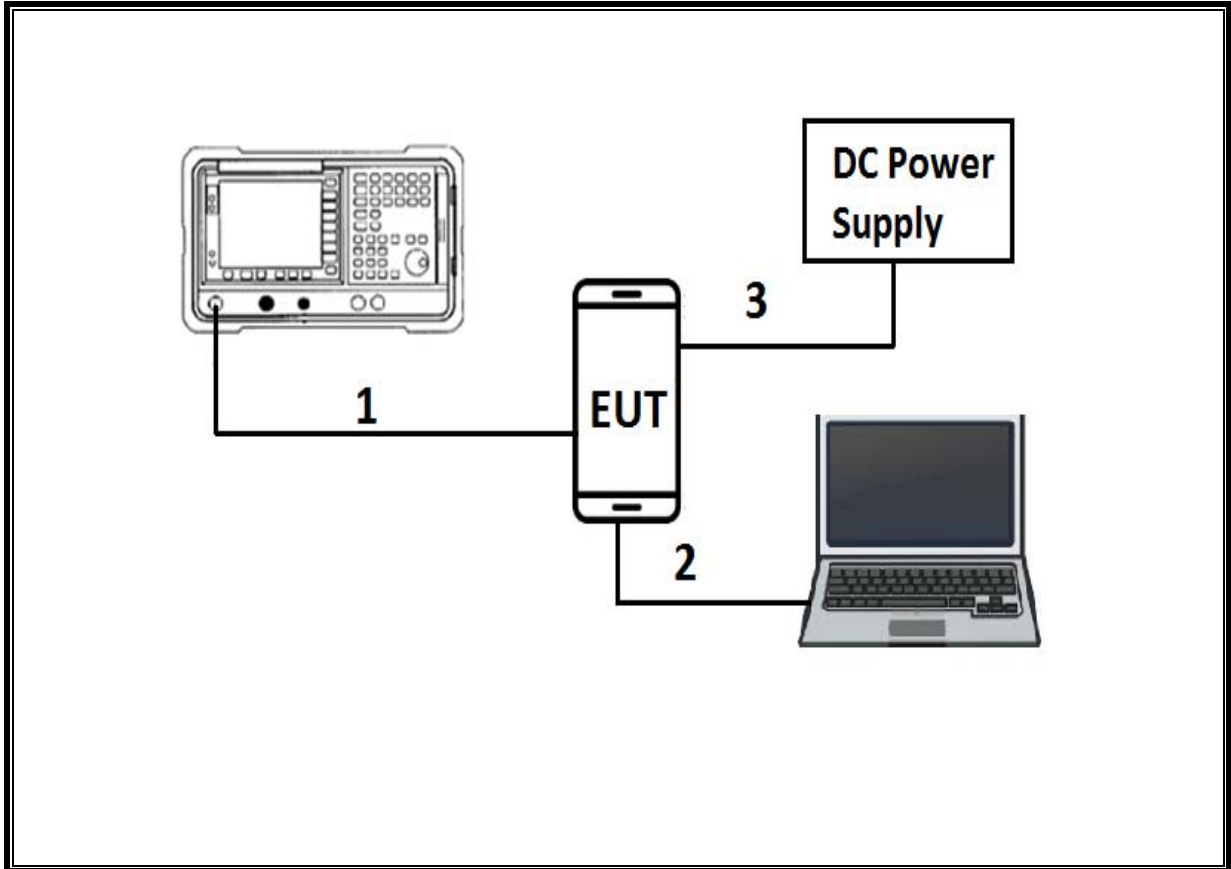

**TEST SETUP- RADIATED-ABOVE 1 GHZ and AC LINE CONDUCTED TESTS**

The EUT was powered by AC Adapter. Test software exercised the EUT.

**SETUP DIAGRAM**

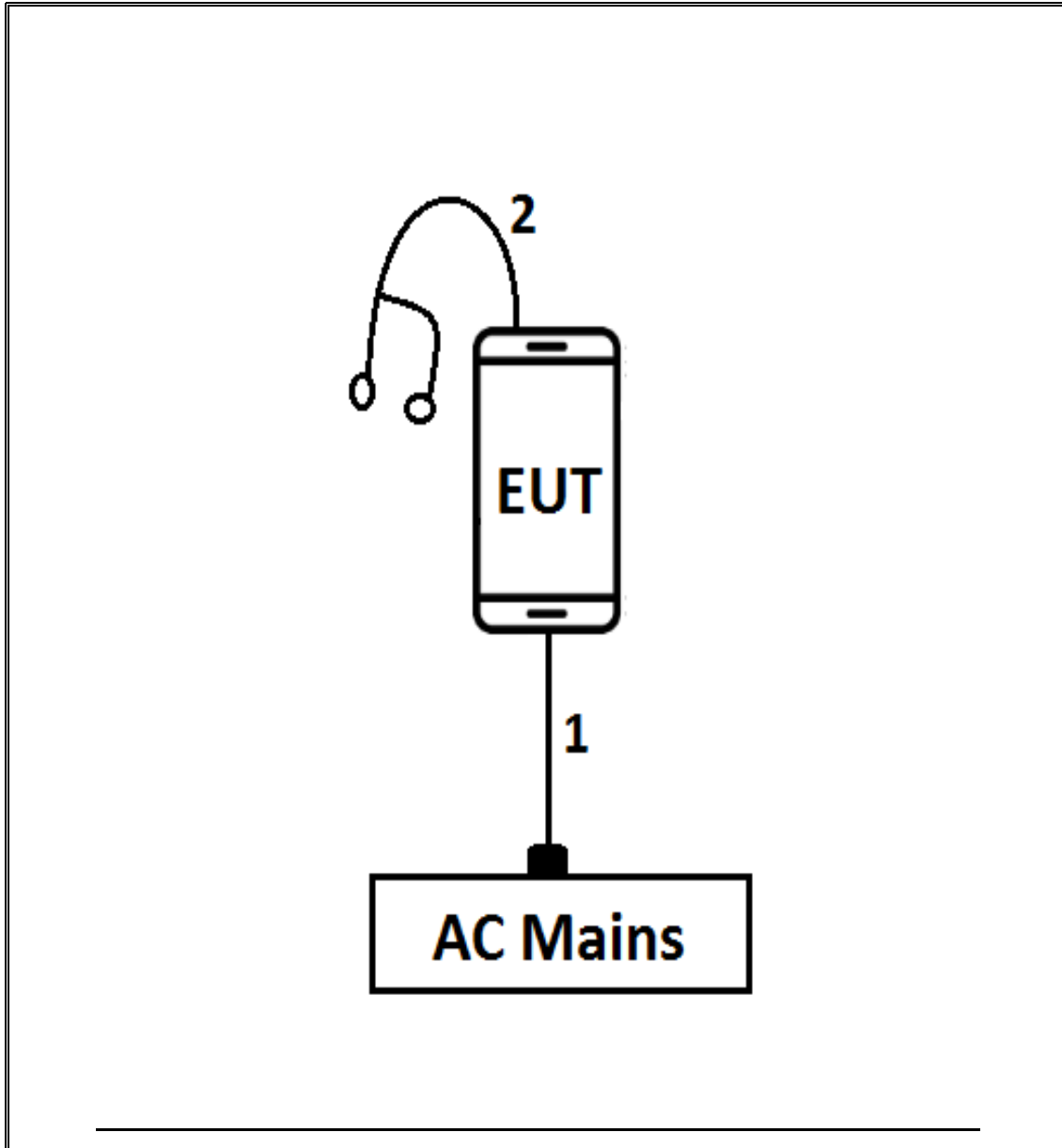

## 6. TEST AND MEASUREMENT EQUIPMENT

TEST EQUIPMENT LIST				
Description	Manufacturer	Model	Asset	Cal Due
Antenna, Broadband Hybrid, 30MHz to 2000MHz w/4dB Pad	Sunol Sciences Corp.	JB3	T477	06/22/2018
Antenna, Active Loop 9kHz-30MHz	ETS-Lindgren	6502	T1683	02/17/2018
Antenna, Horn 1-18GHz	ETS-Lindgren	3117	T345	03/07/2018
Antenna, Horn 18-26.5GHz	ARA	MWH-1826/B	T449	05/26/2018
Power Meter, P-series single channel	Agilent (Keysight) Technologies	N1911A	T1264	07/08/2018
Power Sensor, P – series, 50MHz to 18GHz, Wideband	Agilent (Keysight) Technologies	N1921A	T413	06/20/2018
Amplifier, 1-26.5GHz	Agilent (Keysight) Technologies	8449B	T404	07/05/2018
Amplifier, 10kHz-1GHz	Agilent (Keysight) Technologies	8447D	T15	08/26/2017
RF Amplifier	MITEQ	AFS42-00101800-25-S-42	T493	02/15/2018
Spectrum Analyzer, PSA, 3Hz to 26.5GHz	Agilent (Keysight) Technologies	E4440A	T199	07/22/2017
Spectrum Analyzer, PXA, 3Hz to 44GHz	Agilent (Keysight) Technologies	N9030A	T907	01/23/2018
Spectrum Analyzer, PSA, 3Hz to 26.5GHz	Agilent (Keysight) Technologies	E9030A	T905	01/11/2018
LISN	FISCHER	FCC-LISN-50/250-25-2-01	T1310	01/17/2018

Test Software List			
Description	Manufacturer	Model	Version
Radiated Software	UL	UL EMC	Ver 9.5, Apr 26, 2016
Antenna Port Software	UL	UL RF	Ver 5.1.1, July 15, 2016

## 7. ANTENNA PORT TEST RESULTS

### ON TIME AND DUTY CYCLE

#### LIMITS

None; for reporting purposes only.

#### PROCEDURE

KDB 558074 Zero-Span Spectrum Analyzer Method.

### ON TIME AND DUTY CYCLE RESULTS

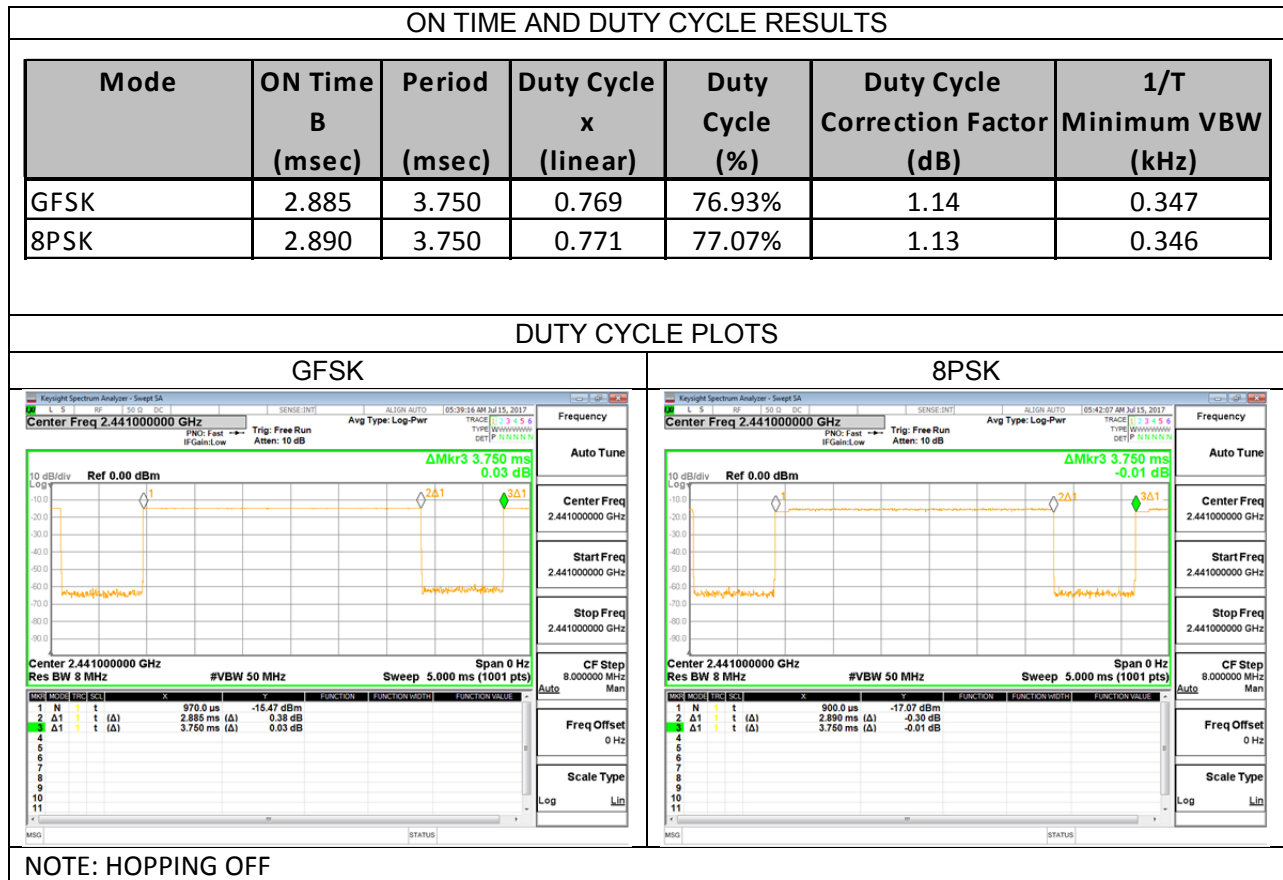

## 7.1. BASIC DATA RATE GFSK MODULATION

### 7.1.1. 20 dB AND 99% BANDWIDTH

#### LIMITS

None; for reporting purposes only.

#### TEST PROCEDURE

The transmitter output is connected to a spectrum analyzer. The RBW is set to  $\geq 1\%$  of the 20 dB bandwidth. The VBW is set to  $\geq$  RBW. The sweep time is coupled.

#### RESULTS

Channel	Frequency (MHz)	20 dB Bandwidth (KHz)	99% Bandwidth (KHz)
Low	2402	837.3	847.67
Middle	2441	751.3	835.99
High	2480	931.7	888.29

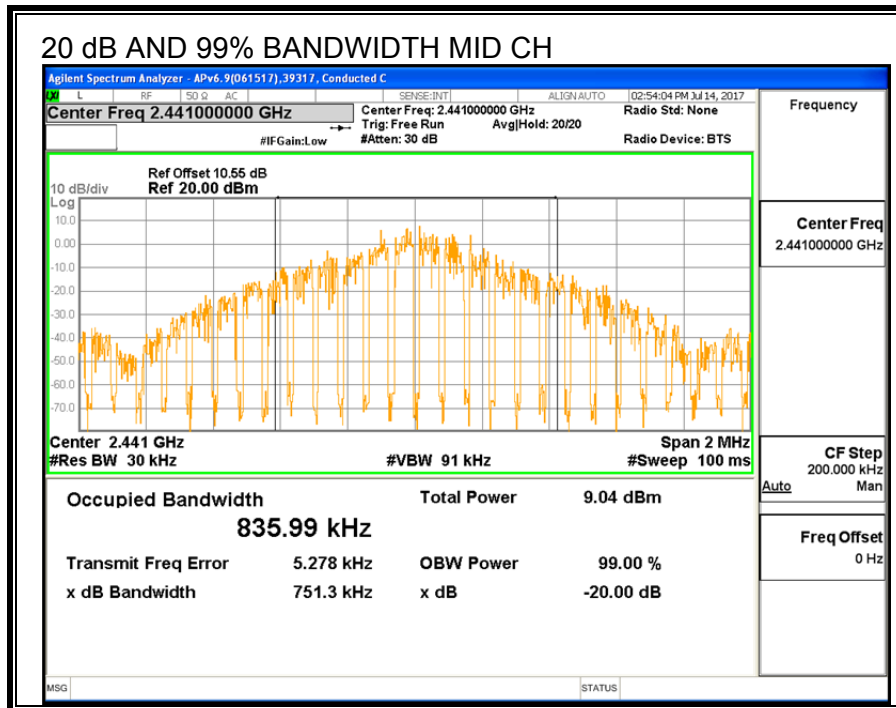
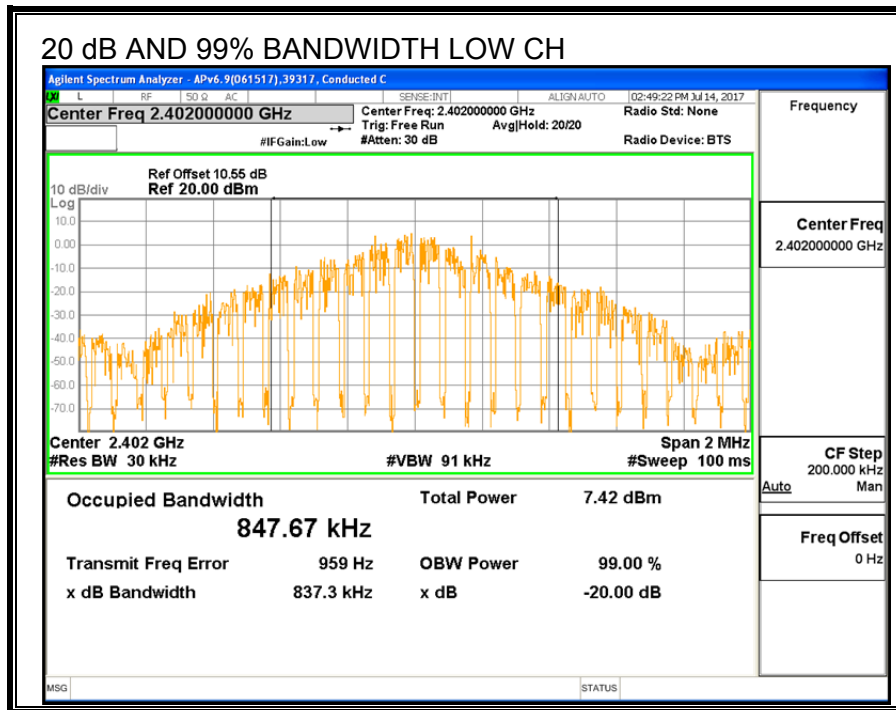



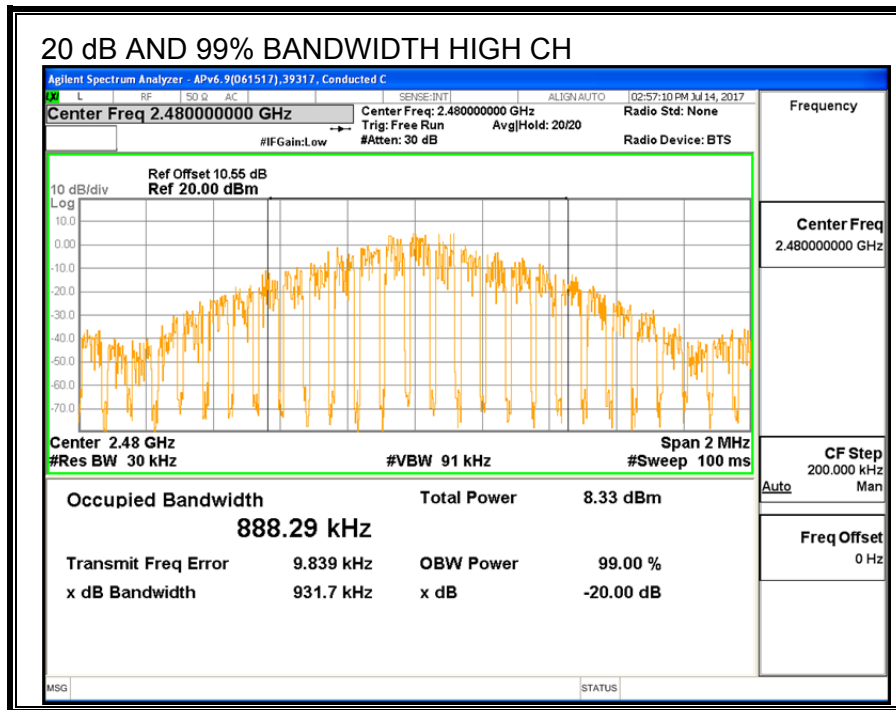

### 7.1.2. HOPPING FREQUENCY SEPARATION

#### LIMITS

FCC §15.247 (a) (1)

Frequency hopping systems shall have hopping channel carrier frequencies separated by a minimum of 25 kHz or the 20 dB bandwidth of the hopping channel, whichever is greater.

Alternatively, frequency hopping systems operating in the 2400-2483.5 MHz band may have hopping channel carrier frequencies that are separated by 25 kHz or two-thirds of the 20 dB bandwidth of the hopping channel, whichever is greater, provided the systems operate with an output power no greater than 125 mW.

#### TEST PROCEDURE

The transmitter output is connected to a spectrum analyzer. The RBW is set to 300 kHz and the VBW is set to 910 kHz. The sweep time is coupled.

#### RESULTS

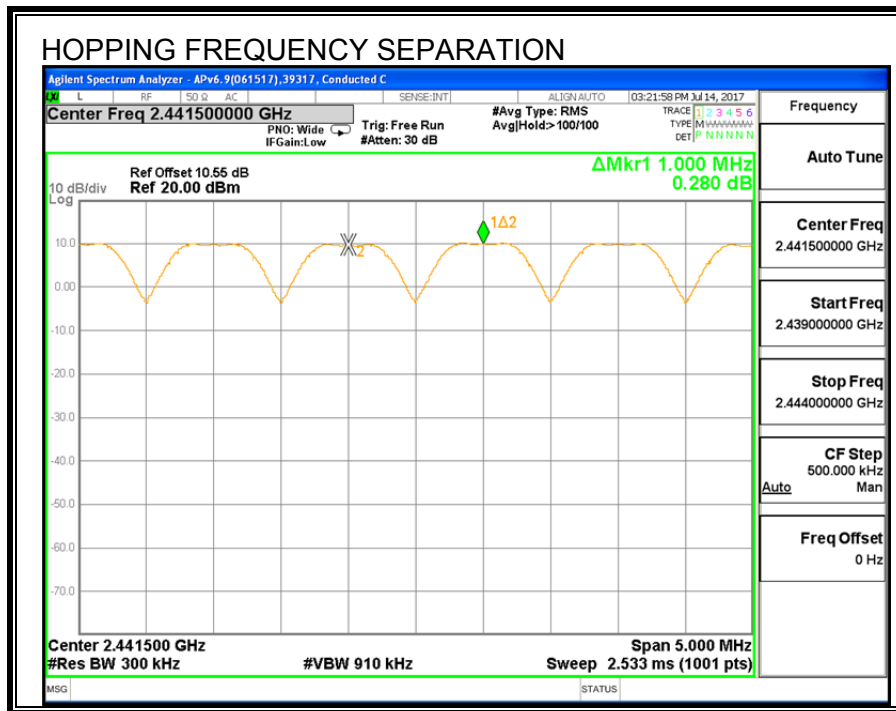

### 7.1.3. NUMBER OF HOPPING CHANNELS

#### LIMITS

FCC §15.247 (a) (1) (iii)

Frequency hopping systems in the 2400 – 2483.5 MHz band shall use at least 15 non-overlapping channels.

#### TEST PROCEDURE

The transmitter output is connected to a spectrum analyzer. The span is set to cover the entire authorized band, in either a single sweep or in multiple contiguous sweeps. The RBW is set to a maximum of 1 % of the span. The analyzer is set to Max Hold.

#### RESULTS

Normal Mode: 79 Channels observed.

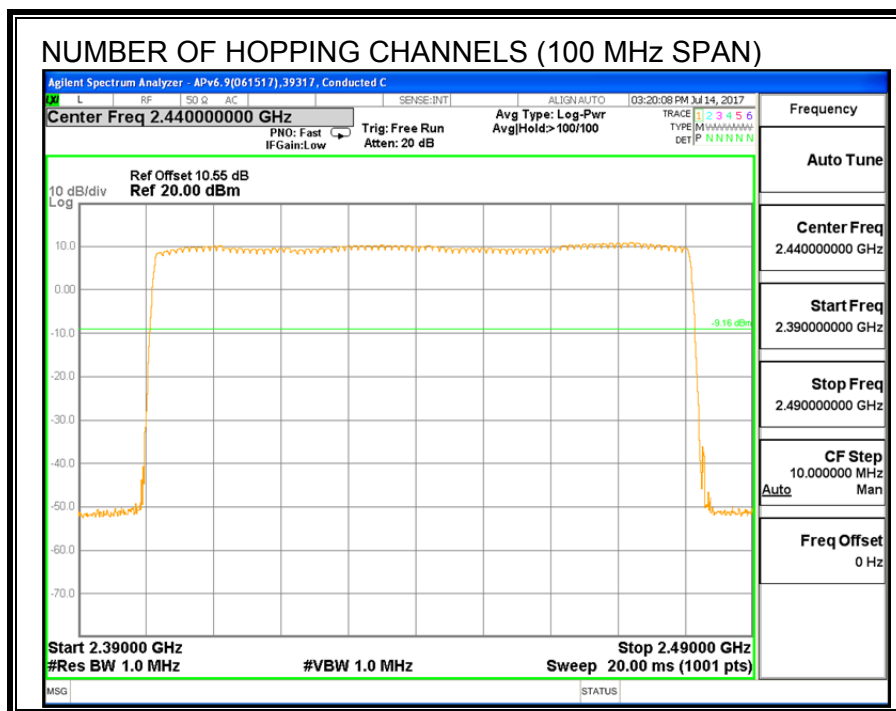

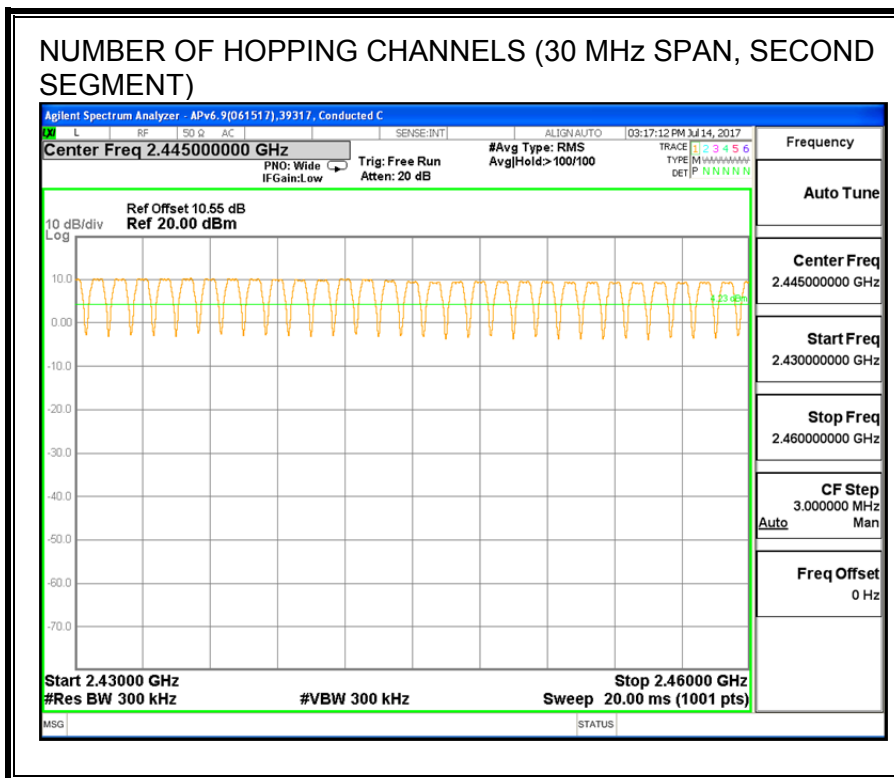
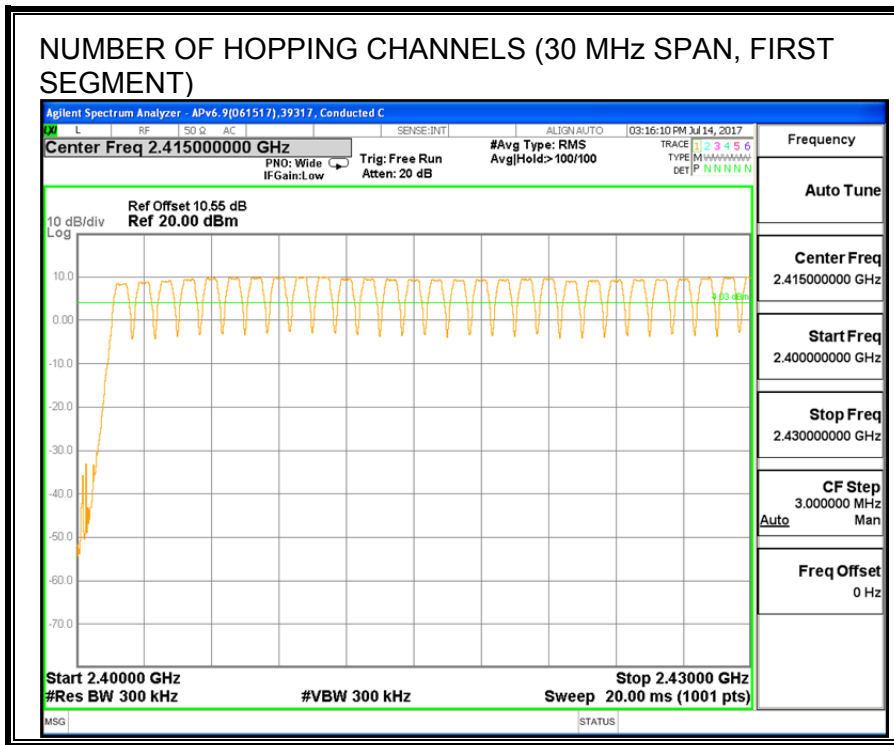

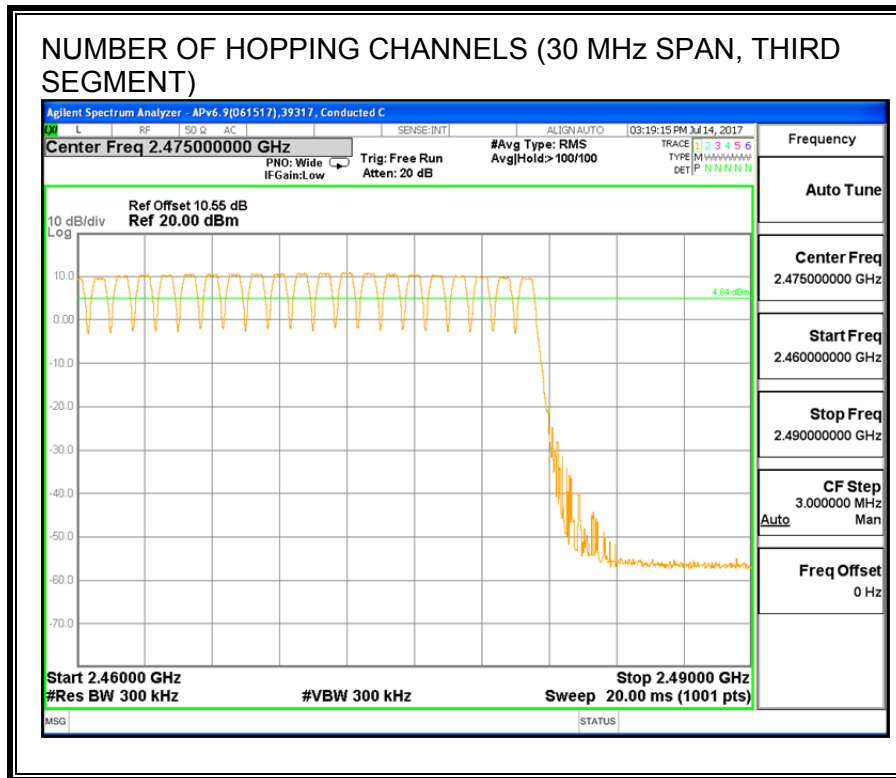

**7.1.4. AVERAGE TIME OF OCCUPANCY**

**LIMITS**

FCC §15.247 (a) (1) (iii)

The average time of occupancy on any channel shall not be greater than 0.4 seconds within a period of 0.4 seconds multiplied by the number of hopping channels employed.

**TEST PROCEDURE**

The transmitter output is connected to a spectrum analyzer. The span is set to 0 Hz, centered on a single, selected hopping channel. The width of a single pulse is measured in a fast scan. The number of pulses is measured in a 3.16 second scan, to enable resolution of each occurrence.

The average time of occupancy in the specified 31.6 second period (79 channels \* 0.4 s) is equal to  $10 * (\# \text{ of pulses in } 3.16 \text{ s}) * \text{ pulse width}$ .

For AFH mode, the average time of occupancy in the specified 8 second period (20 channels \* 0.4 seconds) is equal to  $10 * (\# \text{ of pulses in } 0.8 \text{ s}) * \text{ pulse width}$ .

**RESULTS**

AVERAGE TIME OF OCCUPANCY					
DH Packet	Pulse Width (msec)	Number of Pulses in 3.16 seconds	Average Time of Occupancy (sec)	Limit (sec)	Margin (sec)
GFSK Normal Mode					
DH1	0.407	32	0.1302	0.4	-0.2698
DH3	1.638	15	0.2457	0.4	-0.1543
DH5	2.887	13	0.3753	0.4	-0.0247
DH Packet	Pulse Width (sec)	Number of Pulses in 0.8 seconds	Average Time of Occupancy (sec)	Limit (sec)	Margin (sec)
GFSK AFH Mode					
DH1	0.407	8	0.03254	0.4	-0.3675
DH3	1.638	3.75	0.06143	0.4	-0.3386
DH5	2.887	3.25	0.09383	0.4	-0.3062
NOTE: --					

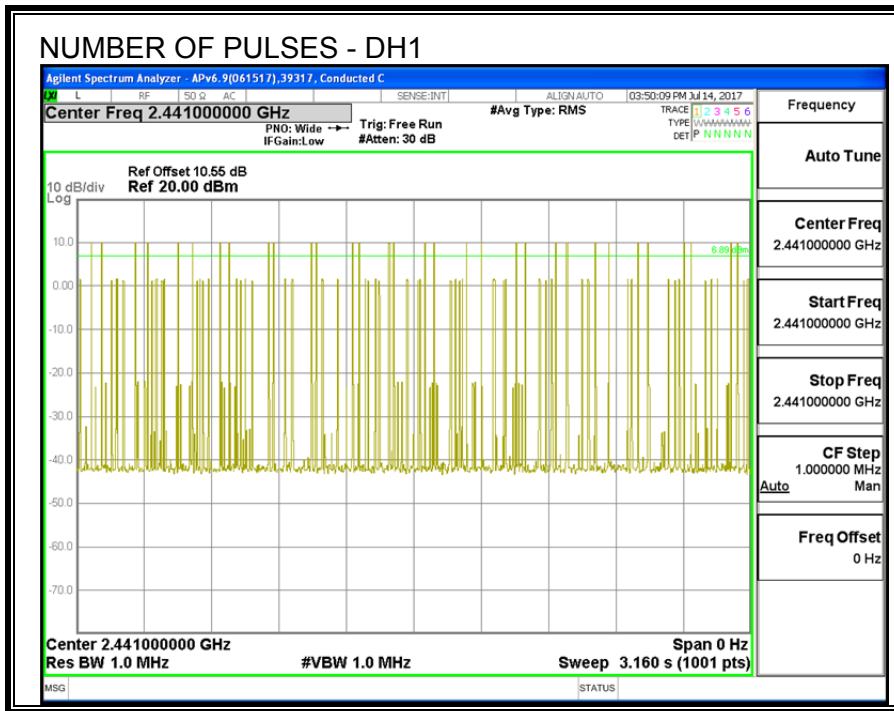
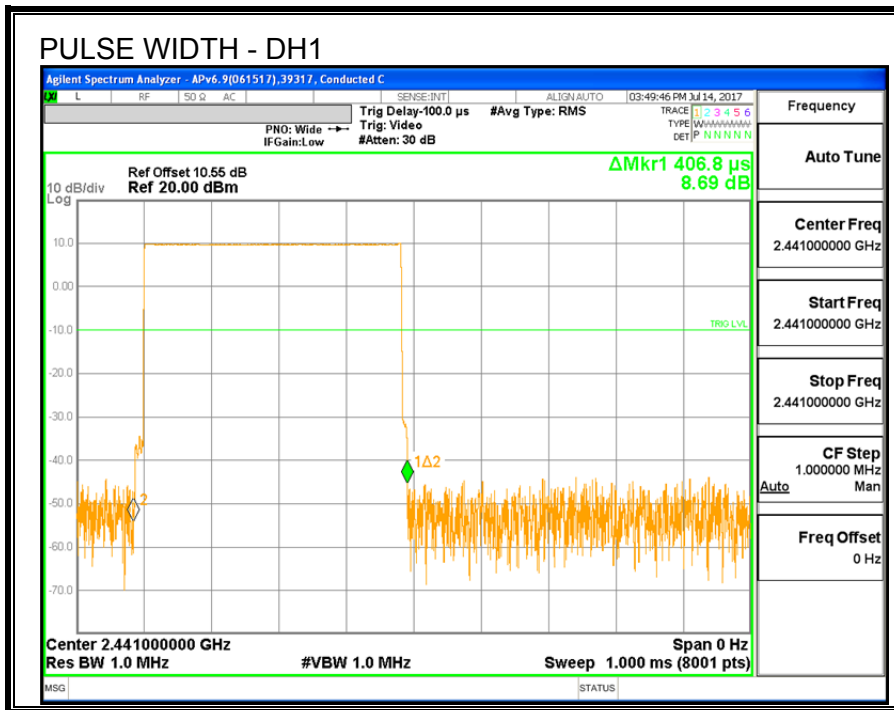

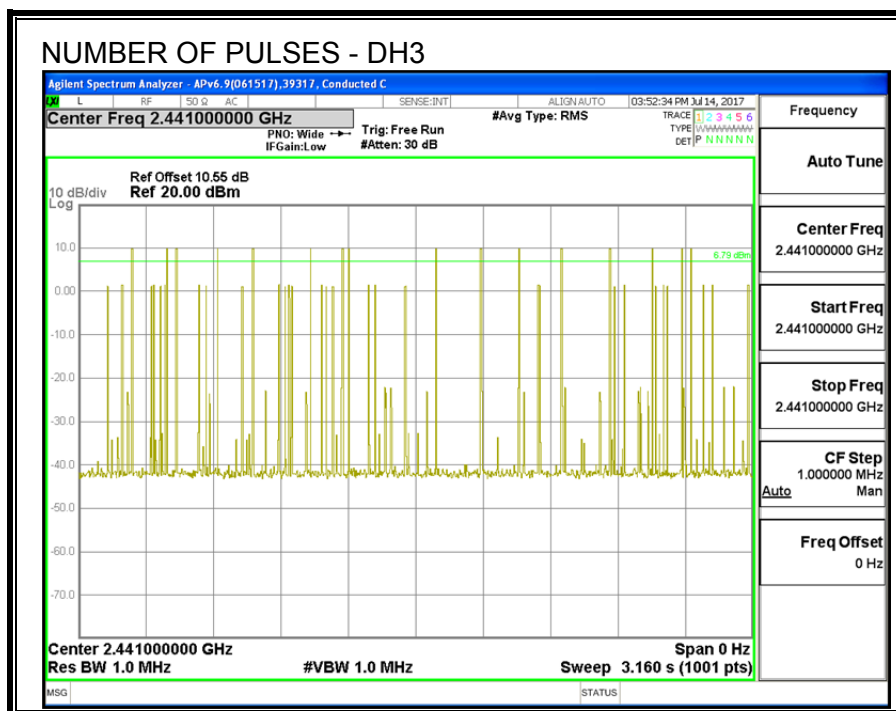
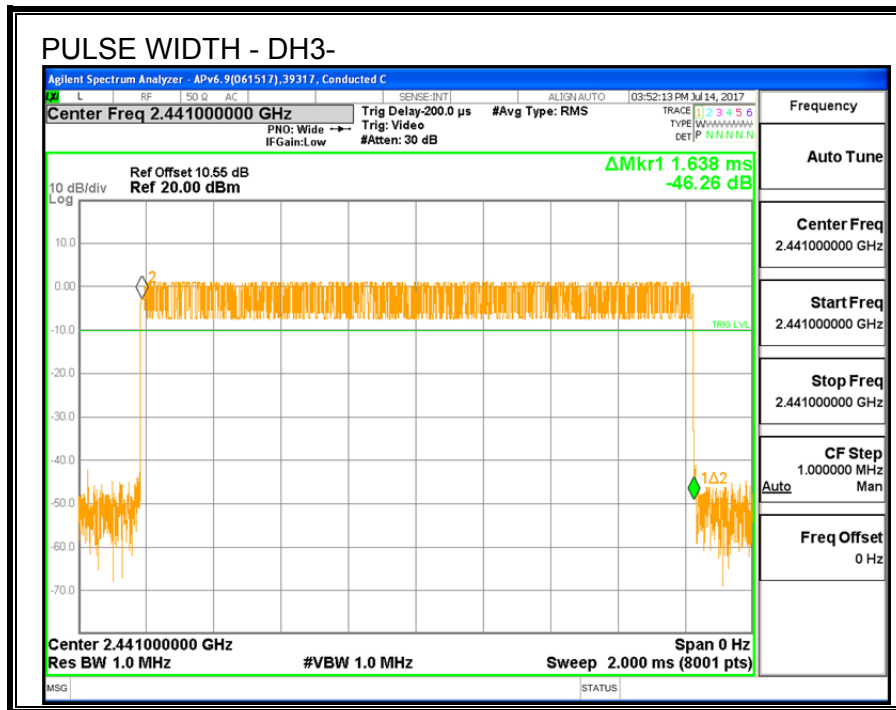



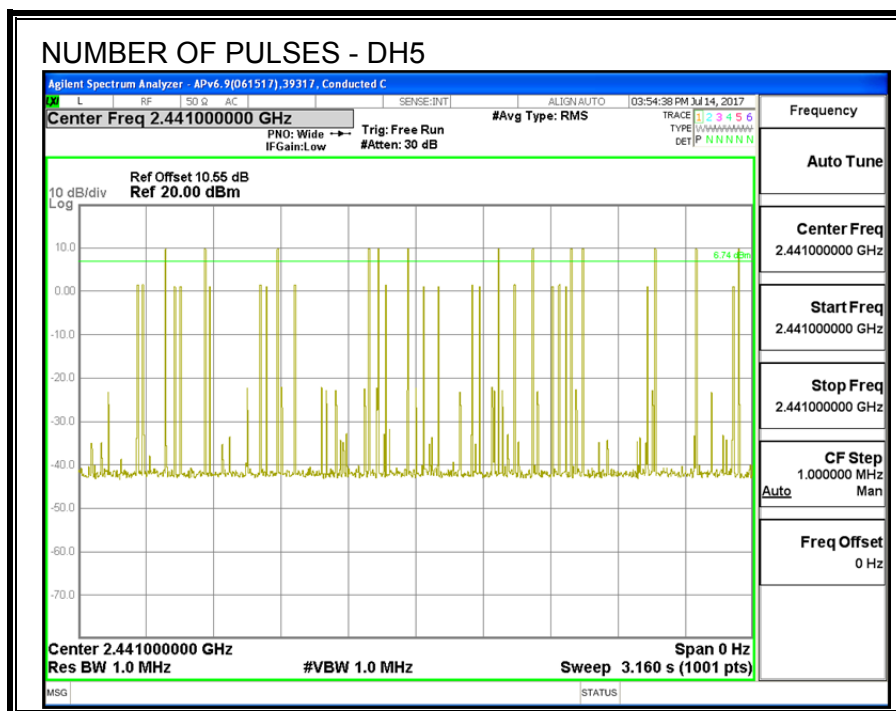
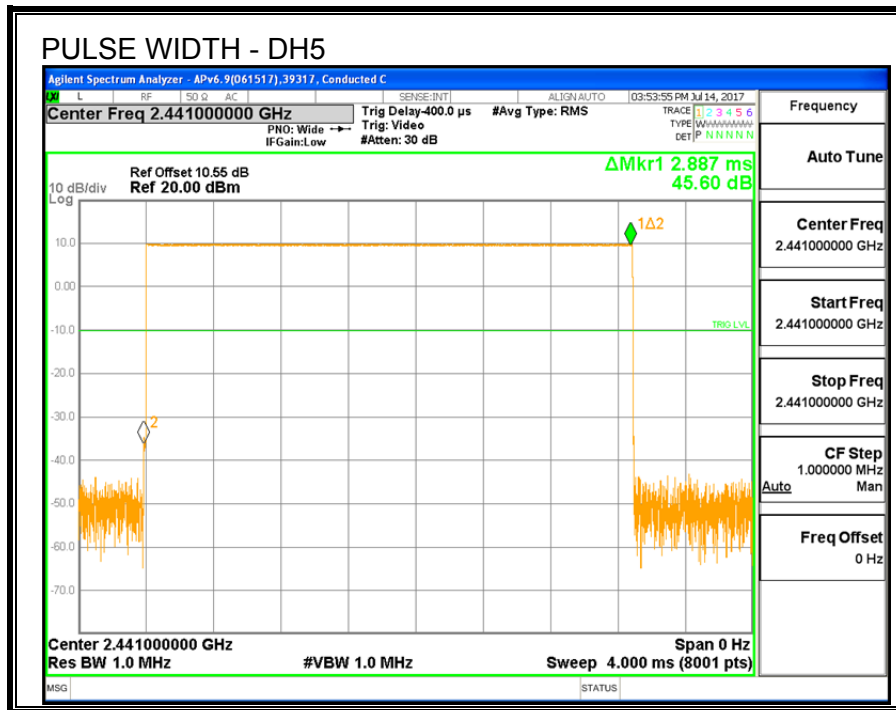

### 7.1.5. OUTPUT POWER

#### LIMITS

§15.247 (b) (1)

The maximum antenna gain is less than 6 dBi, therefore the limit is 30 dBm.

#### TEST PROCEDURE

The transmitter output is connected to a spectrum analyzer.

#### RESULTS

<b>TEST ENGINEER:</b>	39317	<b>Date:</b>	07/14/2017
-----------------------	-------	--------------	------------

Channel	Frequency (MHz)	Output Power (dBm)	Limit (dBm)	Margin (dB)
Low	2402	8.61	30	-21.39
Middle	2441	9.86	30	-20.14
High	2480	9.60	30	-20.40

#### LOW CHANNEL

Agilent Spectrum Analyzer - APx6\_9(D61517)\_39317\_Conducted\_C

Center 2.402000 GHz #Res BW 3.0 MHz #VBW 8.0 MHz Sweep 1.000 ms (1001 pts)

Mkr1 2.402198 GHz 8.61 dBm

#### MID CHANNEL

Agilent Spectrum Analyzer - APx6\_9(D61517)\_39317\_Conducted\_C

Center 2.441000 GHz #Res BW 3.0 MHz #VBW 8.0 MHz Sweep 1.000 ms (1001 pts)

Mkr1 2.441018 GHz 9.86 dBm

#### HIGH CHANNEL

Agilent Spectrum Analyzer - APx6\_9(D61517)\_39317\_Conducted\_C

Center 2.480000 GHz #Res BW 3.0 MHz #VBW 8.0 MHz Sweep 1.000 ms (1001 pts)

Mkr1 2.479874 GHz 9.60 dBm

**NOTE:**

### 7.1.6. AVERAGE POWER

#### LIMITS

None; for reporting purposes only.

#### TEST PROCEDURE

The transmitter output is connected to a power meter.

#### RESULTS

The cable assembly insertion loss of 10.6 dB (including 10 dB pad and 0.6 dB cable) was entered as an offset in the power meter to allow for direct reading of power.

<b>TEST ENGINEER:</b>	45258	<b>Date:</b>	07/14/17
-----------------------	-------	--------------	----------

Channel	Frequency (MHz)	Average Power (dBm)
Low	2402	8.48
Middle	2441	9.73
High	2480	9.46

### 7.1.7. CONDUCTED BANDEDGE AND SPURIOUS EMISSIONS

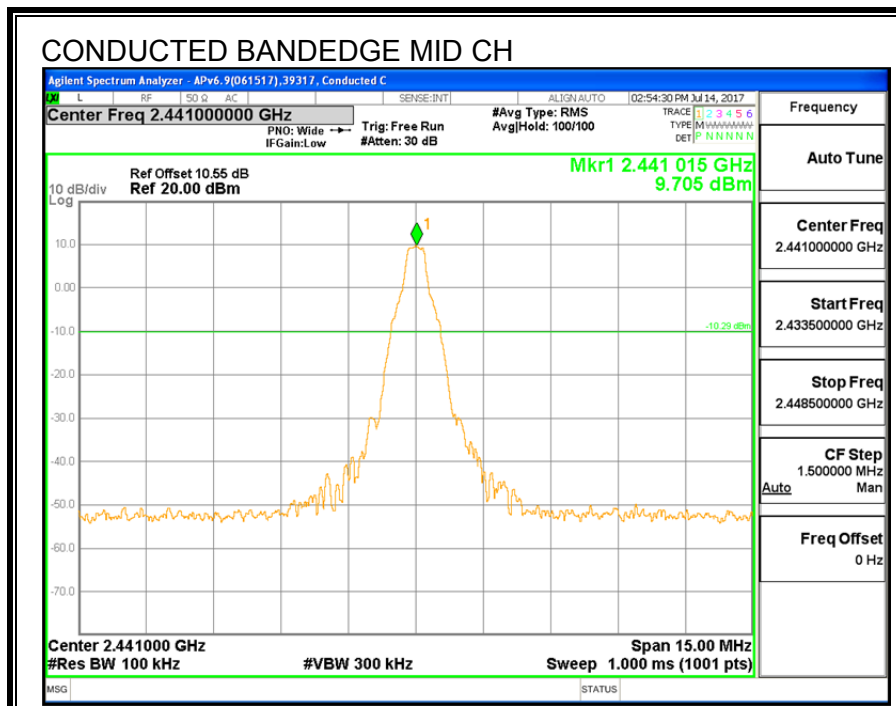
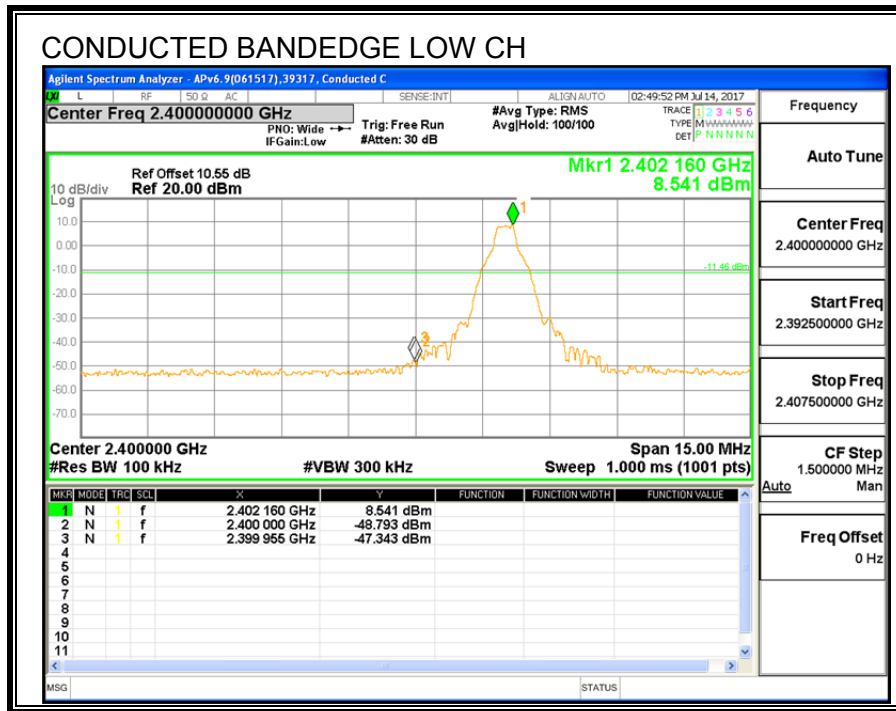

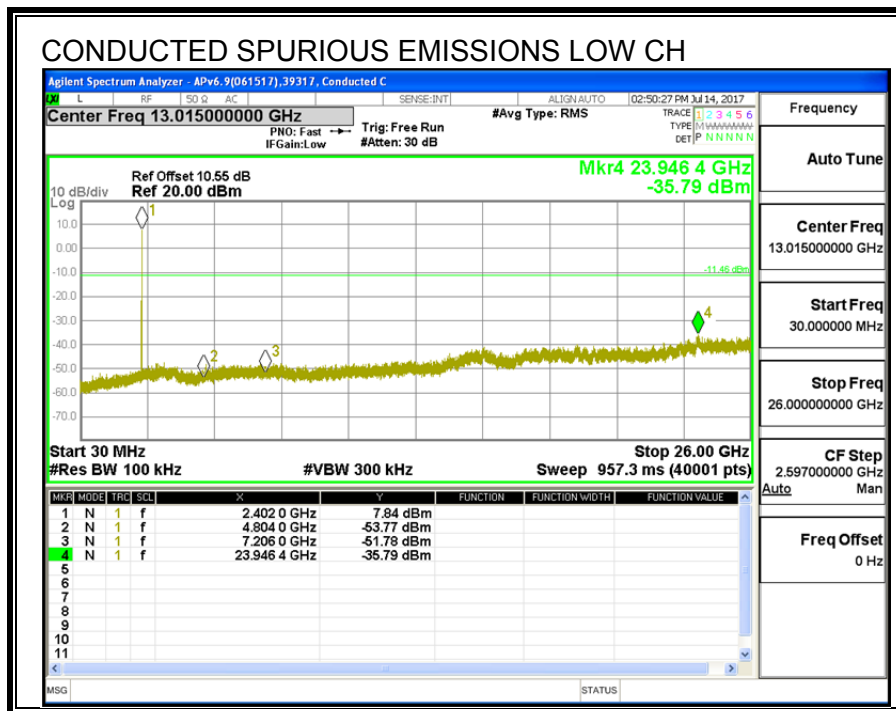
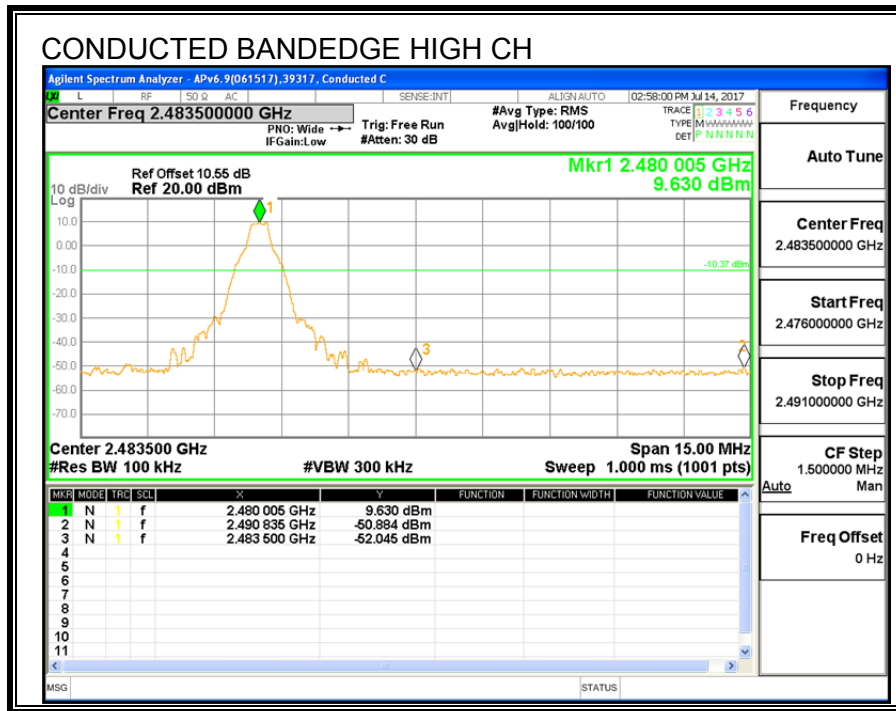

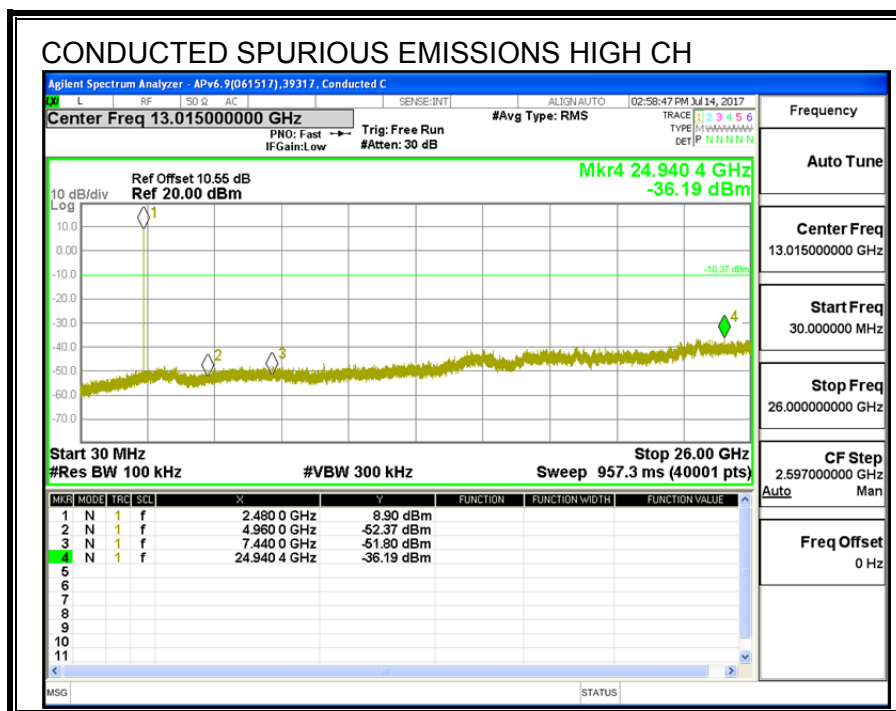
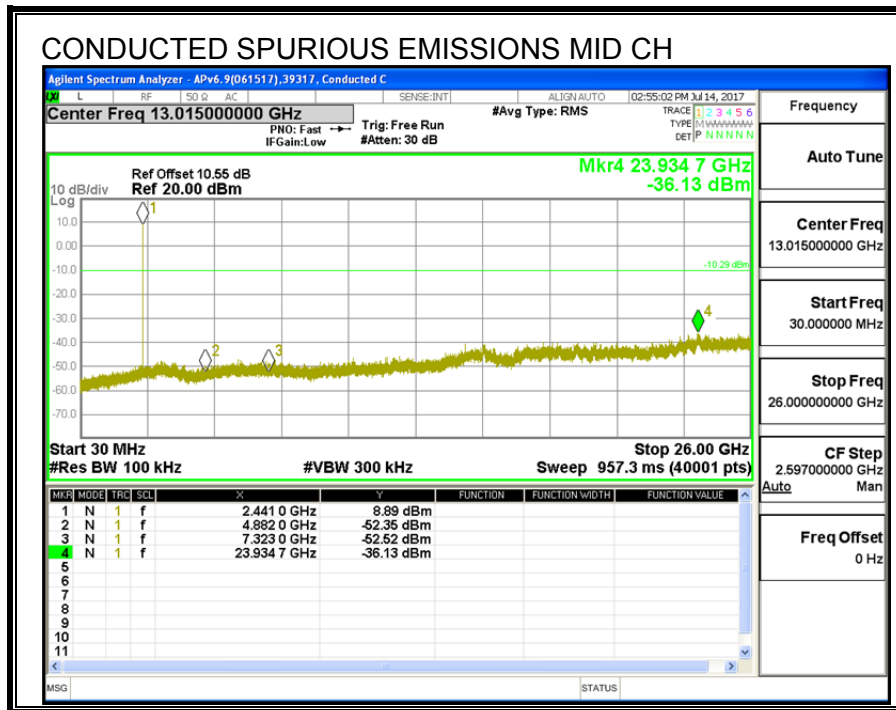

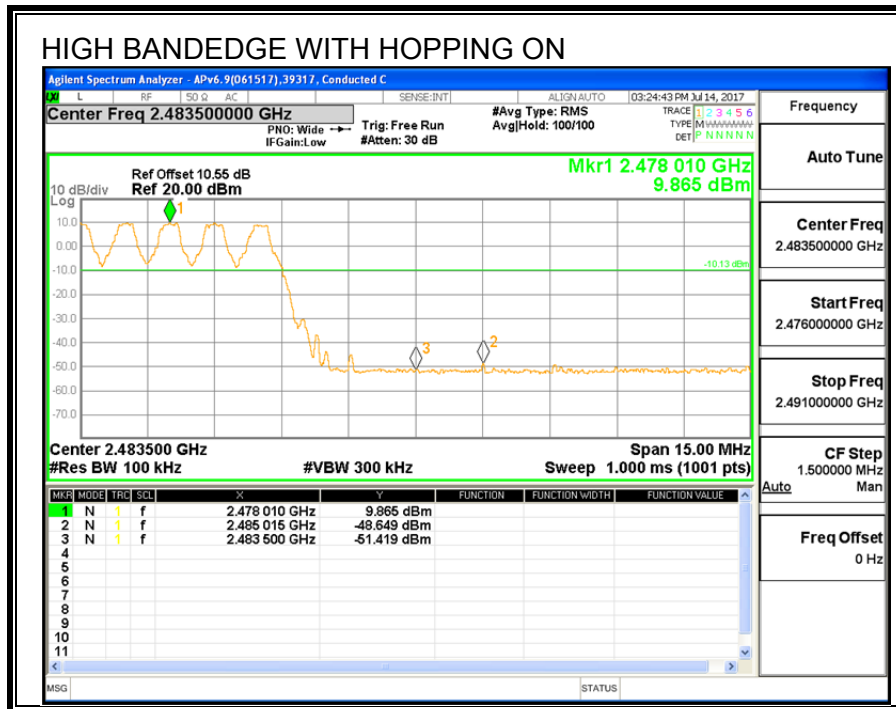
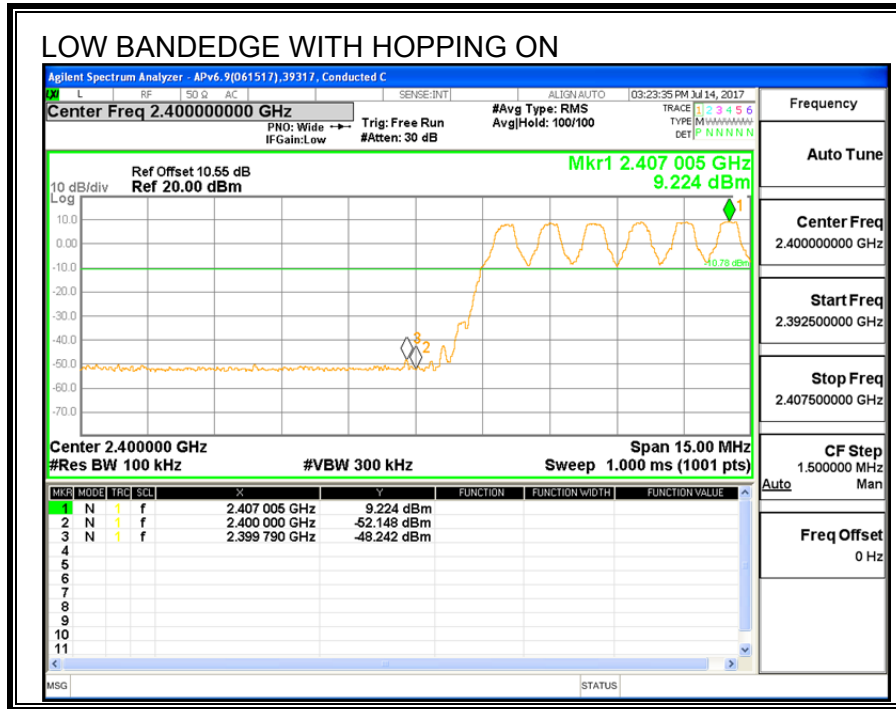

## 7.2. ENHANCED DATA RATE 8PSK MODULATION

### 7.2.1. 20 dB AND 99% BANDWIDTH

#### LIMITS

None; for reporting purposes only.

#### TEST PROCEDURE

The transmitter output is connected to a spectrum analyzer. The RBW is set to  $\geq 1\%$  of the 20 dB bandwidth. The VBW is set to  $\geq$  RBW. The sweep time is coupled.

#### RESULTS

Channel	Frequency (MHz)	20 dB Bandwidth (MHz)	99% Bandwidth (MHz)
Low	2402	1.171	1.1556
Middle	2441	1.150	1.1415
High	2480	1.172	1.1444



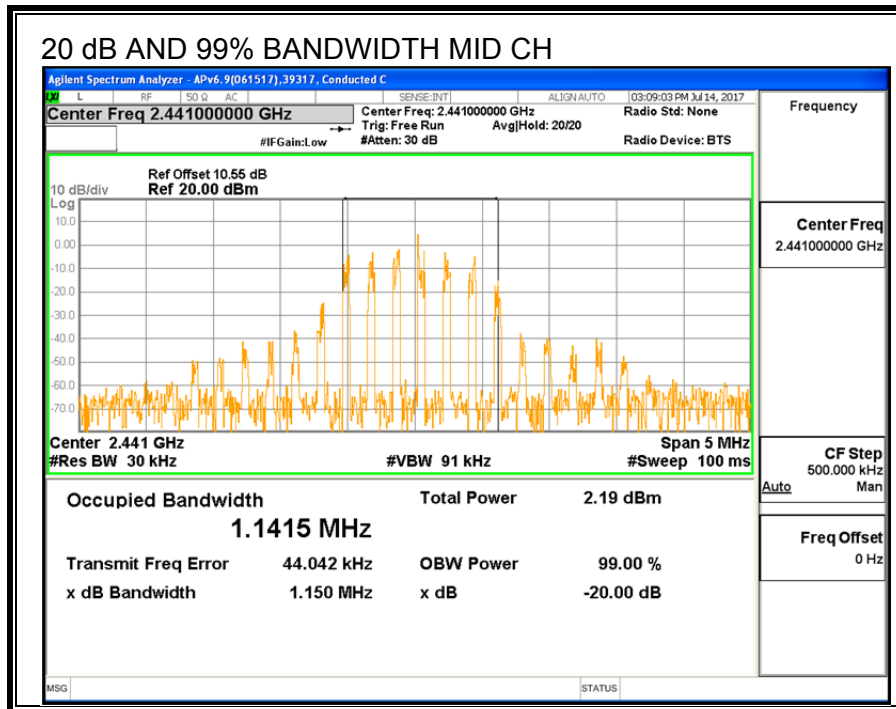
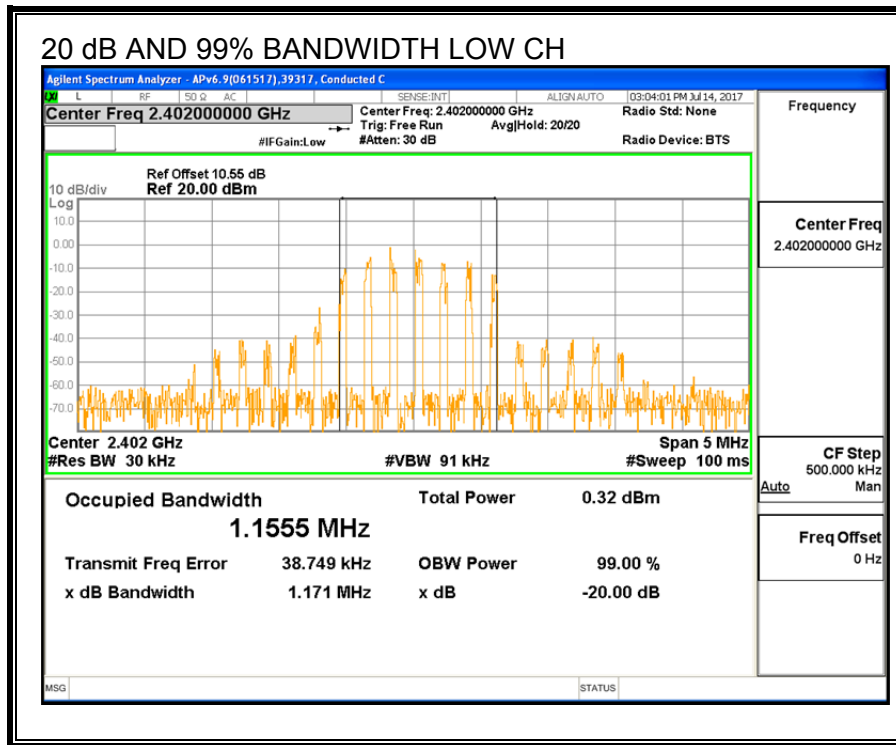

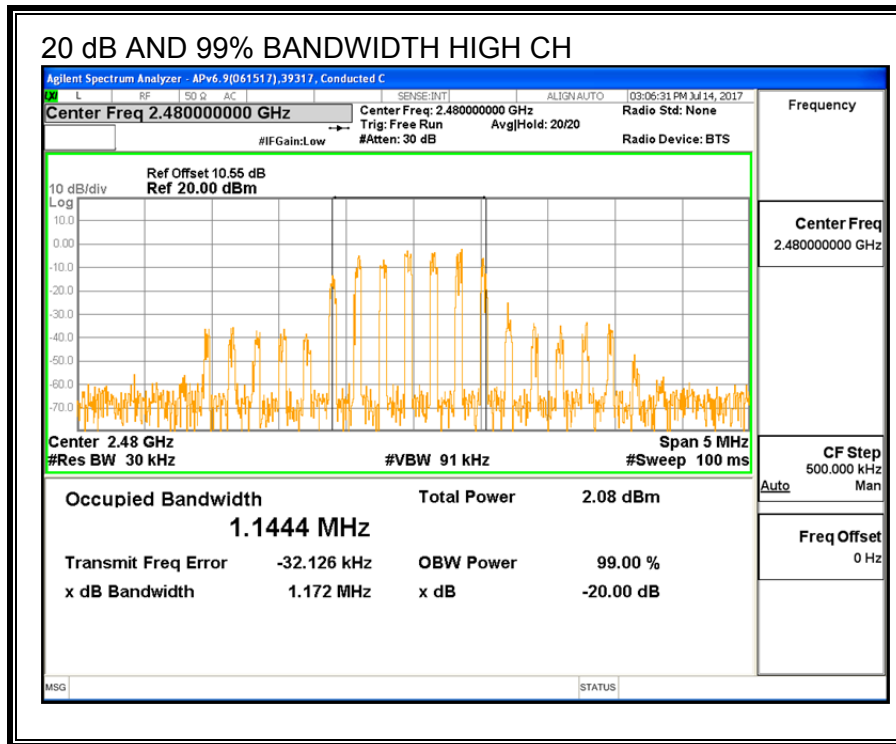

## 7.2.2. HOPPING FREQUENCY SEPARATION

### LIMITS

FCC §15.247 (a) (1)

Frequency hopping systems shall have hopping channel carrier frequencies separated by a minimum of 25 kHz or the 20 dB bandwidth of the hopping channel, whichever is greater.

Alternatively, frequency hopping systems operating in the 2400-2483.5 MHz band may have hopping channel carrier frequencies that are separated by 25 kHz or two-thirds of the 20 dB bandwidth of the hopping channel, whichever is greater, provided the systems operate with an output power no greater than 125 mW.

### TEST PROCEDURE

The transmitter output is connected to a spectrum analyzer. The RBW is set to 300 kHz and the VBW is set to 910 kHz. The sweep time is coupled.

### RESULTS

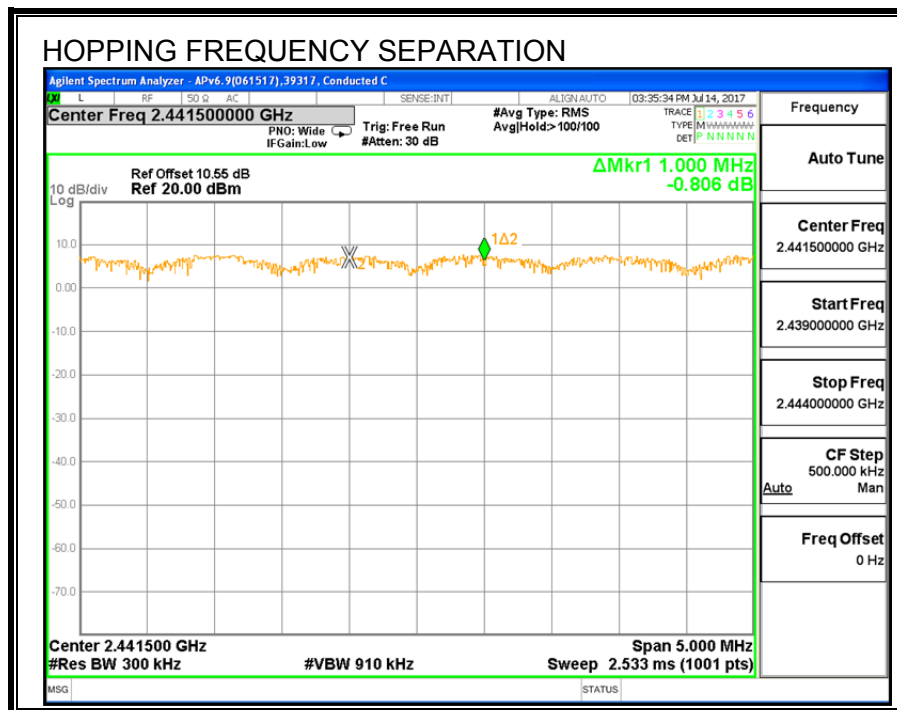

### 7.2.3. NUMBER OF HOPPING CHANNELS

#### LIMITS

FCC §15.247 (a) (1) (iii)

Frequency hopping systems in the 2400 – 2483.5 MHz band shall use at least 15 non-overlapping channels.

#### TEST PROCEDURE

The transmitter output is connected to a spectrum analyzer. The span is set to cover the entire authorized band, in either a single sweep or in multiple contiguous sweeps. The RBW is set to a maximum of 1 % of the span. The analyzer is set to Max Hold.

#### RESULTS

Normal Mode: 79 Channels observed.

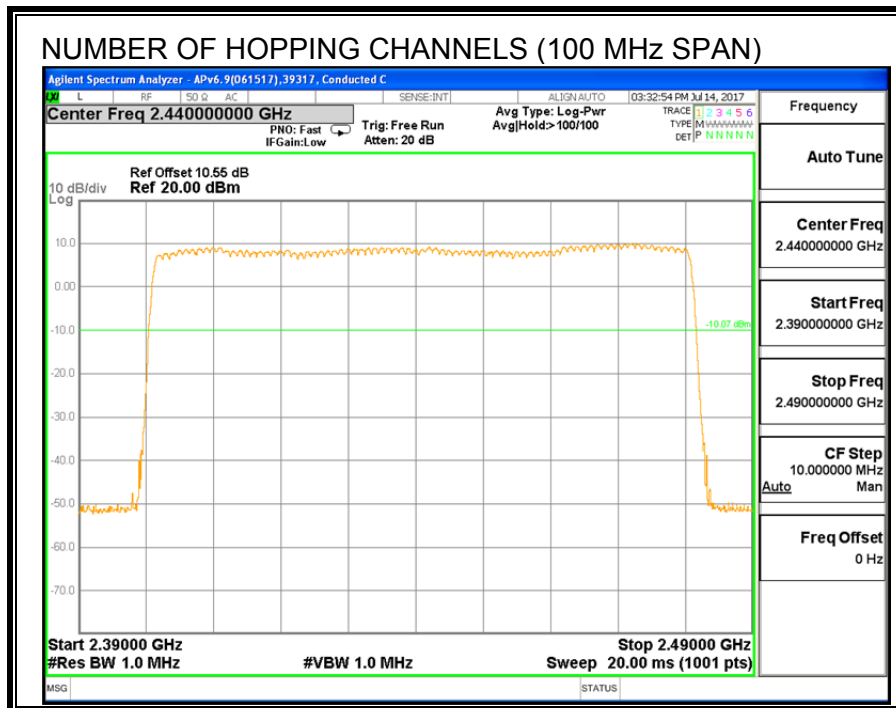

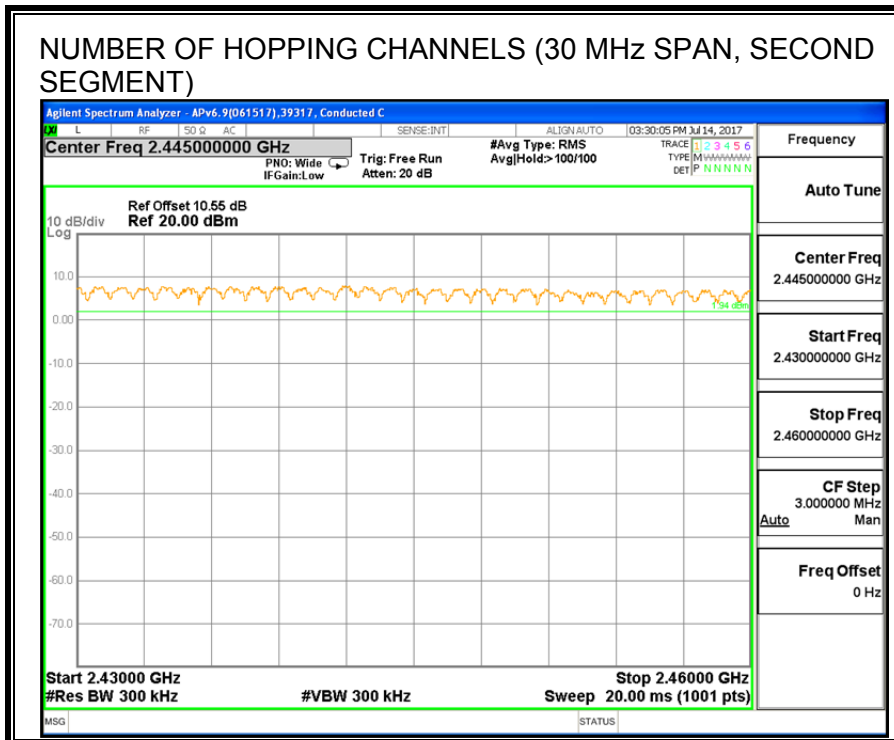
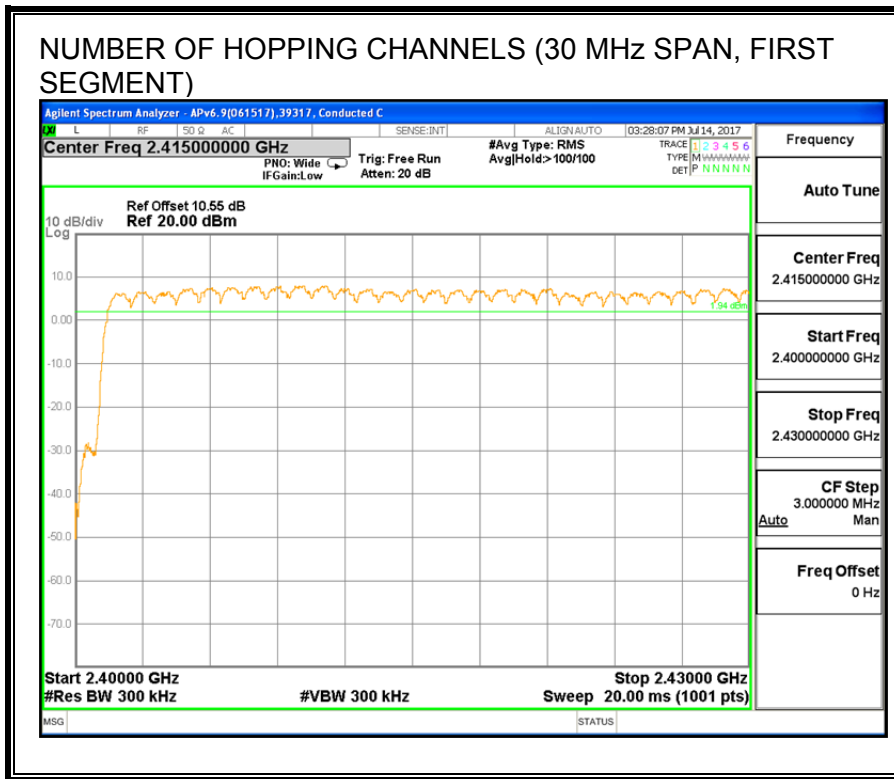

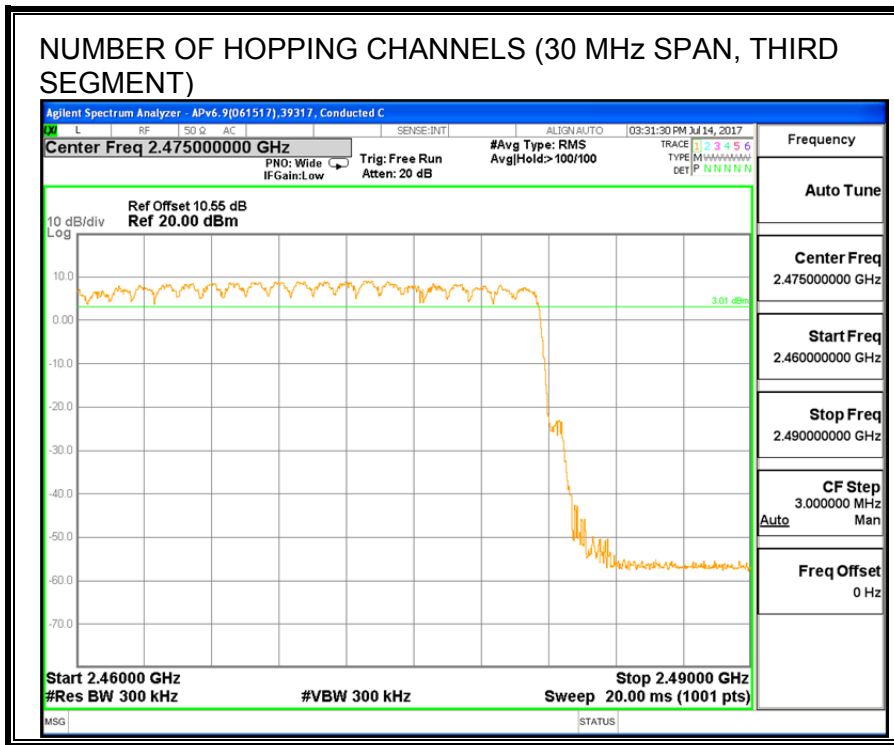

### 7.2.4. AVERAGE TIME OF OCCUPANCY

#### LIMITS

FCC §15.247 (a) (1) (iii)

The average time of occupancy on any channel shall not be greater than 0.4 seconds within a period of 0.4 seconds multiplied by the number of hopping channels employed.

#### TEST PROCEDURE

The transmitter output is connected to a spectrum analyzer. The span is set to 0 Hz, centered on a single, selected hopping channel. The width of a single pulse is measured in a fast scan. The number of pulses is measured in a 3.16 second scan, to enable resolution of each occurrence.

The average time of occupancy in the specified 31.6 second period (79 channels \* 0.4 s) is equal to  $10 * (\# \text{ of pulses in } 3.16 \text{ s}) * \text{ pulse width}$ .

For AFH mode, the average time of occupancy in the specified 8 second period (20 channels \* 0.4 seconds) is equal to  $10 * (\# \text{ of pulses in } 0.8 \text{ s}) * \text{ pulse width}$ .

#### RESULTS

AVERAGE TIME OF OCCUPANCY					
DH Packet	Pulse Width (msec)	Number of Pulses in 3.16 seconds	Average Time of Occupancy (sec)	Limit (sec)	Margin (sec)
8PSK Normal Mode					
3-DH1	0.410	32	0.1311	0.4	-0.2689
3-DH3	1.065	16	0.1704	0.4	-0.2296
3-DH5	2.891	10	0.2891	0.4	-0.1109
DH Packet	Pulse Width (sec)	Number of Pulses in 0.8 seconds	Average Time of Occupancy (sec)	Limit (sec)	Margin (sec)
8PSK AFH Mode					
3-DH1	0.410	8	0.03277	0.4	-0.3672
3-DH3	1.065	4	0.04260	0.4	-0.3574
3-DH5	2.891	2.5	0.07228	0.4	-0.3277
NOTE: --					

