



# FCC RF Test Report

**APPLICANT** : Sony Mobile Communications Inc.  
**EQUIPMENT** : GSM/WCDMA/LTE Phone+Bluetooth, DTS/UNII  
a/b/g/n and NFC  
**BRAND NAME** : Sony  
**FCC ID** : PY7-19719M  
**STANDARD** : FCC Part 15 Subpart E §15.407  
**CLASSIFICATION** : (NII) Unlicensed National Information Infrastructure

The product was received on Nov. 22, 2016 and testing was completed on Jan. 25, 2017. We, SPORTON INTERNATIONAL INC., would like to declare that the tested sample has been evaluated in accordance with the test procedures and has been in compliance with the applicable technical standards.

The test results in this report apply exclusively to the tested model / sample. Without written approval of SPORTON INTERNATIONAL INC., the test report shall not be reproduced except in full.

Reviewed by: Joseph Lin / Supervisor

Approved by: Jones Tsai / Manager



## SPORTON INTERNATIONAL INC.

No. 52, Hwa Ya 1<sup>st</sup> Rd., Hwa Ya Technology Park, Kwei-Shan District, Tao Yuan City, Taiwan, R.O.C.

SPORTON INTERNATIONAL INC.

TEL : 886-3-327-3456

FAX : 886-3-328-4978

FCC ID : PY7-19719M

Page Number : 1 of 35

Report Issued Date : Feb. 21, 2017

Report Version : Rev. 01

Report Template No.: BU5-FR15EWL Version 1.4



# TABLE OF CONTENTS

**SUMMARY OF TEST RESULT ..... 4**

**1 GENERAL DESCRIPTION ..... 5**

1.1 Applicant ..... 5

1.2 Manufacturer ..... 5

1.3 Product Feature of Equipment Under Test ..... 5

1.4 Modification of EUT ..... 6

1.5 Testing Location ..... 7

1.6 Applicable Standards ..... 8

**2 TEST CONFIGURATION OF EQUIPMENT UNDER TEST ..... 9**

2.1 Carrier Frequency Channel ..... 9

2.2 Test Mode ..... 10

2.3 Connection Diagram of Test System ..... 11

2.4 Support Unit used in test configuration and system ..... 12

2.5 EUT Operation Test Setup ..... 12

2.6 Measurement Results Explanation Example ..... 12

**3 TEST RESULT ..... 13**

3.1 26dB & 99% Occupied Bandwidth Measurement ..... 13

3.2 Maximum Conducted Output Power Measurement ..... 15

3.3 Power Spectral Density Measurement ..... 18

3.4 Unwanted Radiated Emission Measurement ..... 21

3.5 AC Conducted Emission Measurement ..... 26

3.6 Frequency Stability Measurement ..... 30

3.7 Automatically Discontinue Transmission ..... 31

3.8 Antenna Requirements ..... 32

**4 LIST OF MEASURING EQUIPMENTS ..... 33**

**5 UNCERTAINTY OF EVALUATION ..... 35**

**APPENDIX A. CONDUCTED TEST RESULTS**

**APPENDIX B. RADIATED SPURIOUS EMISSION**

**APPENDIX C. RADIATED SPURIOUS EMISSION PLOTS**

**APPENDIX D. DUTY CYCLE PLOTS**



### REVISION HISTORY

| REPORT NO.   | VERSION | DESCRIPTION             | ISSUED DATE   |
|--------------|---------|-------------------------|---------------|
| FR6N2202-01E | Rev. 01 | Initial issue of report | Feb. 21, 2017 |
|              |         |                         |               |
|              |         |                         |               |
|              |         |                         |               |
|              |         |                         |               |
|              |         |                         |               |
|              |         |                         |               |
|              |         |                         |               |
|              |         |                         |               |
|              |         |                         |               |
|              |         |                         |               |
|              |         |                         |               |
|              |         |                         |               |
|              |         |                         |               |
|              |         |                         |               |
|              |         |                         |               |
|              |         |                         |               |
|              |         |                         |               |



### SUMMARY OF TEST RESULT

| Report Section | FCC Rule              | Description                            | Limit  | Result | Remark                                    |
|----------------|-----------------------|--|--|--------|---|
| 3.1            | 2.1049<br>15.403(i)   | 26dB & 99% Bandwidth                   | -  | Pass   | -   |
| 3.2            | 15.407(a)             | Maximum Conducted Output Power         | FCC<br>≤ 24 dBm<br>(depend on band)          | Pass   | -   |
| 3.3            | 15.407(a)             | Power Spectral Density                 | FCC<br>≤ 11 dBm<br>(depend on band)          | Pass   | -   |
| 3.4            | 15.407(b)             | Unwanted Emissions                     | ≤ -17, -27 dBm<br>(depend on band)&15.209(a) | Pass   | Under limit<br>3.14 dB at<br>5148.720 MHz |
| 3.5            | 15.207                | AC Conducted Emission                  | 15.207(a)                                    | Pass   | Under limit<br>16.50 dB at<br>0.150 MHz   |
| 3.6            | 15.407(g)             | Frequency Stability                    | Within Operation Band                        | Pass   | -   |
| 3.7            | 15.407(c)             | Automatically Discontinue Transmission | Discontinue Transmission                     | Pass   | -   |
| 3.8            | 15.203 &<br>15.407(a) | Antenna Requirement                    | N/A  | Pass   | -   |



# 1 General Description

## 1.1 Applicant

**Sony Mobile Communications Inc.**

4-12-3 Higashi-Shinagawa, Shinagawa-ku, Tokyo, 140-0002, Japan

## 1.2 Manufacturer

**Sony Mobile Communications Inc.**

4-12-3 Higashi-Shinagawa, Shinagawa-ku, Tokyo, 140-0002, Japan

## 1.3 Product Feature of Equipment Under Test

GSM/WCDMA/LTE, Bluetooth, DTS/UNII, a/b/g/n, GPS, and NFC

| Standards-related Product Specification |                                    |
|---|------------------------------------|
| Antenna Type                            | PIFA Antenna                       |
| Antenna Gain                            | <5150 MHz ~ 5250 MHz><br>-0.70 dBi |
|   | <5250 MHz ~ 5350 MHz><br>-0.20 dBi |
|   | <5470 MHz ~ 5725 MHz><br>-0.30 dBi |
|   |                                    |

| EUT Information List |            |            |                            |
|----------------------|------------|------------|----------------------------|
| HW Version           | SW Version | S/N        | Performed Test Item        |
| A                    | 0.79       | RQ3003BXX4 | RF conducted measurement   |
|                      |            | RQ3003BXJY | Radiated Spurious Emission |
|                      |            | RQ3003BXX6 | Conducted Emission         |



| Accessory List |  |
|----------------|--|
| AC Adapter 1   | Model No. : UCH20  |
|                | S/N :  |
|                | 1215W486600059 (for radiated spurious emission)<br>5816W13300005 (for conducted emission)    |
| Earphone 1     | Model No. : MH410c   |
|                | S/N:   |
|                | 1632A86100002DB (for radiated spurious emission)<br>1632A864000088 (for conducted emission)  |
| USB Cable      | Model No. : UCB20  |
|                | S/N :  |
|                | 1625A91B0003352 (for radiated spurious emission)<br>1625A91900007E2 (for conducted emission) |

**Note:**

1. Above EUT list and accessory list used are electrically identical per declared by manufacturer.
2. Above the accessories list are used to exercise the EUT during test.
3. For other wireless features of this EUT, test report will be issued separately.

### 1.4 Modification of EUT

No modifications are made to the EUT during all test items.



### 1.5 Testing Location

Sporton Lab is accredited to ISO 17025 by Taiwan Accreditation Foundation (TAF code : 1190) and the FCC designation No. TW0007 under the FCC 2.948(e) by Mutual Recognition Agreement (MRA) in FCC Test.

|                           |  |         |
|---------------------------|--|---------|
| <b>Test Site</b>          | SPORTON INTERNATIONAL INC.   |         |
| <b>Test Site Location</b> | No. 52, Hwa Ya 1 <sup>st</sup> Rd., Hwa Ya Technology Park,<br>Kwei-Shan District, Tao Yuan City, Taiwan, R.O.C.<br>TEL: +886-3-327-3456<br>FAX: +886-3-328-4978 |         |
| <b>Test Site No.</b>      | <b>Sporton Site No.</b>  |         |
|                           | TH05-HY  | CO05-HY |

**Note:** The test site complies with ANSI C63.4 2014 requirement.

|                           |  |  |
|---------------------------|--|--|
| <b>Test Site</b>          | SPORTON INTERNATIONAL INC.   |  |
| <b>Test Site Location</b> | No.58, Aly. 75, Ln. 564, Wenhua 3rd Rd. Guishan Dist,<br>Taoyuan City, Taiwan (R.O.C.)<br>TEL: +886-3-327-0868<br>FAX: +886-3-327-0855 |  |
| <b>Test Site No.</b>      | <b>Sporton Site No.</b>  |  |
|                           | 03CH11-HY  |  |

**Note:** The test site complies with ANSI C63.4 2014 requirement.



## 1.6 Applicable Standards

According to the specifications of the manufacturer, the EUT must comply with the requirements of the following standards:

- ♦ FCC Part 15 Subpart E
- ♦ FCC KDB 789033 D02 General UNII Test Procedures New Rules v01r03
- ♦ ANSI C63.10-2013

### **Remark:**

1. All test items were verified and recorded according to the standards and without any deviation during the test.
2. This EUT has also been tested and complied with the requirements of FCC Part 15, Subpart B, recorded in a separate test report.





## 2 Test Configuration of Equipment Under Test

The EUT has been associated with peripherals and configuration operated in a manner tended to maximize its emission characteristics in a typical application. Frequency range investigated: conducted emission (150 kHz to 30 MHz) and radiated emission (9 kHz to the 10th harmonic of the highest fundamental frequency or to 40 GHz, whichever is lower). For radiated measurement, pre-scanned in three orthogonal panels, X, Y, Z. The worst cases (Z plane) were recorded in this report.

### 2.1 Carrier Frequency Channel

| Frequency Band                       | Channel | Freq. (MHz) | Channel | Freq. (MHz) |
|--------------------------------------|---------|-------------|---------|-------------|
| 5150-5250 MHz<br>Band 1<br>(U-NII-1) | 36      | 5180        | 44      | 5220        |
|                                      | 38*     | 5190        | 46*     | 5230        |
|                                      | 40      | 5200        | 48      | 5240        |
|                                      | -       | -           |         |             |

| Frequency Band                        | Channel | Freq. (MHz) | Channel | Freq. (MHz) |
|---------------------------------------|---------|-------------|---------|-------------|
| 5250-5350 MHz<br>Band 2<br>(U-NII-2A) | 52      | 5260        | 60      | 5300        |
|                                       | 54*     | 5270        | 62*     | 5310        |
|                                       | 56      | 5280        | 64      | 5320        |
|                                       | -       | -           |         |             |

| Frequency Band                        | Channel | Freq. (MHz) | Channel | Freq. (MHz) |
|---------------------------------------|---------|-------------|---------|-------------|
| 5470-5725 MHz<br>Band 3<br>(U-NII-2C) | 100     | 5500        | 112     | 5560        |
|                                       | 102*    | 5510        | 116     | 5580        |
|                                       | 104     | 5520        | 132     | 5660        |
|                                       | -       | -           | 134*    | 5670        |
|                                       | 108     | 5540        | 136     | 5680        |
|                                       | 110*    | 5550        | 140     | 5700        |

| Frequency Band   | Channel | Freq. (MHz) | Channel | Freq. (MHz) |
|------------------|---------|-------------|---------|-------------|
| Straddle Channel | -       | -           | 144     | 5720        |
|                  | 142*    | 5710        |         |             |

**Note:** The above Frequency and Channel in "\*" were 802.11n HT40



## 2.2 Test Mode

Final test mode of conducted test items and radiated spurious emissions are considering the modulation and worse data rates as below table.

| Modulation   | Data Rate |
|--------------|-----------|
| 802.11a      | 6 Mbps    |
| 802.11n HT20 | MCS0      |
| 802.11n HT40 | MCS0      |

|                              |   |
|------------------------------|---|
| <b>AC Conducted Emission</b> | Mode 1 : GSM1900 Idle + Bluetooth Link + WLAN (5GHz) Link + Camera (Rear) + Earphone<br>1 + Battery + USB Cable (Charging from Adapter 3) |
|------------------------------|---|

| Ch. #    |        | Band I : 5150-5250 MHz | Band II : 5250-5350 MHz | Band III : 5470-5725MHz |
|----------|--------|------------------------|-------------------------|-------------------------|
|          |        | 802.11a                | 802.11a                 | 802.11a                 |
| L        | Low    | 36                     | 52                      | 100                     |
| M        | Middle | 44                     | 60                      | 116                     |
| H        | High   | 48                     | 64                      | 140                     |
| Straddle |        | -                      | -                       | 144                     |

| Ch. #    |        | Band I : 5150-5250 MHz | Band II : 5250-5350 MHz | Band III : 5470-5725MHz |
|----------|--------|------------------------|-------------------------|-------------------------|
|          |        | 802.11n HT20           | 802.11n HT20            | 802.11n HT20            |
| L        | Low    | 36                     | 52                      | 100                     |
| M        | Middle | 44                     | 60                      | 116                     |
| H        | High   | 48                     | 64                      | 140                     |
| Straddle |        | -                      | -                       | 144                     |

| Ch. #    |        | Band I : 5150-5250 MHz | Band II : 5250-5350 MHz | Band III : 5470-5725MHz |
|----------|--------|------------------------|-------------------------|-------------------------|
|          |        | 802.11n HT40           | 802.11n HT40            | 802.11n HT40            |
| L        | Low    | 38                     | 54                      | 102                     |
| M        | Middle | -                      | -                       | 110                     |
| H        | High   | 46                     | 62                      | 134                     |
| Straddle |        | -                      | -                       | 142                     |

## 2.3 Connection Diagram of Test System

<WLAN Tx Mode>

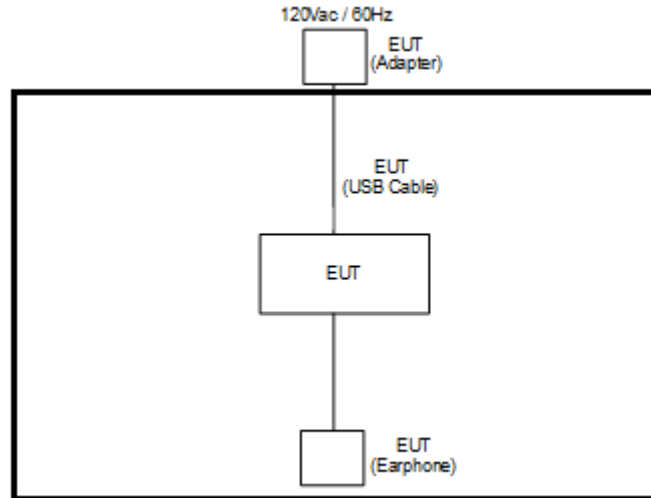

<AC Conducted Emission Mode>

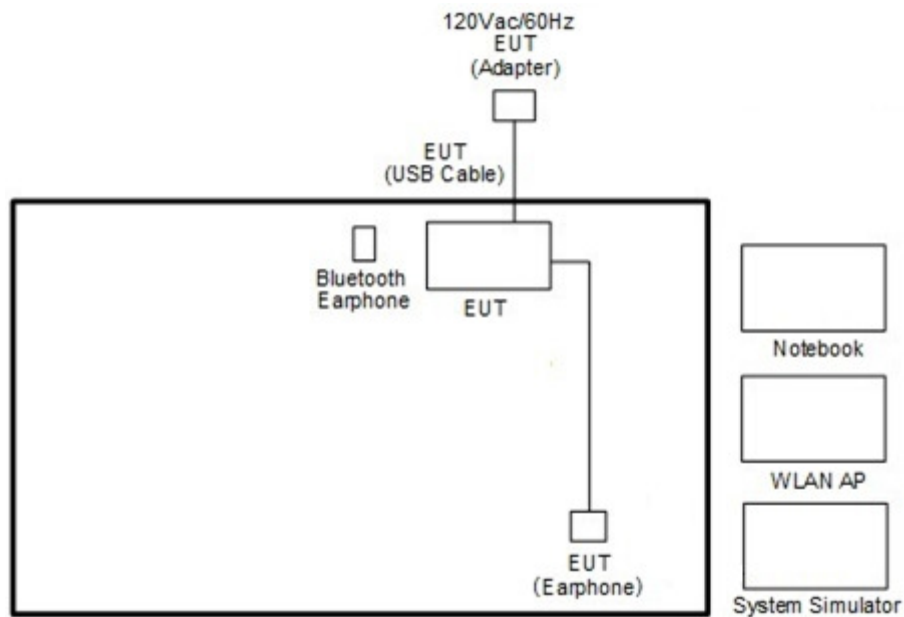



## 2.4 Support Unit used in test configuration and system

| Item | Equipment          | Trade Name | Model Name     | FCC ID                                       | Data Cable | Power Cord   |
|------|--------------------|------------|----------------|--|------------|--|
| 1.   | System Simulator   | Anritsu    | MT8820C        | N/A  | N/A        | Unshielded, 1.8 m  |
| 2.   | WLAN AP            | D-Link     | DIR-865L       | KA2IR865LA1                                  | N/A        | Unshielded, 1.8m   |
| 3.   | Notebook           | DELL       | Latitude E6320 | FCC DoC/<br>Contains FCC ID:<br>QDS-BRCM1054 | N/A        | AC I/P:<br>Unshielded, 1.2 m<br>DC O/P:<br>Shielded, 1.8 m |
| 4.   | Bluetooth Earphone | Sony       | SBH20          | PY7-RD0010                                   | N/A        | N/A  |
| 5.   | SD Card            | SanDisk    | MicroSD HC     | FCC DoC                                      | N/A        | N/A  |

## 2.5 EUT Operation Test Setup

For RF test items, an engineering test program was provided and enabled to make EUT transmitting signals.

## 2.6 Measurement Results Explanation Example

**For all conducted test items:**

The offset level is set in the spectrum analyzer to compensate the RF cable loss and attenuator factor between EUT conducted output port and spectrum analyzer. With the offset compensation, the spectrum analyzer reading level is exactly the EUT RF output level.

Example :

The spectrum analyzer offset is derived from RF cable loss and attenuator factor.

*Offset = RF cable loss + attenuator factor.*

Following shows an offset computation example with cable loss 4.2 dB and 10dB attenuator.

$$\begin{aligned}
 \text{Offset(dB)} &= \text{RF cable loss(dB)} + \text{attenuator factor(dB)}. \\
 &= 4.2 + 10 = 14.2 \text{ (dB)}
 \end{aligned}$$

### 3 Test Result

#### 3.1 26dB & 99% Occupied Bandwidth Measurement

##### 3.1.1 Description of 26dB & 99% Occupied Bandwidth

This section is for reporting purpose only.

There is no restriction limits for bandwidth.

For Straddle Channel, U-NII procedures and limits were applied for operations in the frequency band in accordance with FCC KDB 644545 D03.

##### 3.1.2 Measuring Instruments

The measuring equipment is listed in the section 4 of this test report.

##### 3.1.3 Test Procedures

1. The testing follows FCC KDB 789033 D02 General UNII Test Procedures New Rules v01r03. Section C) Emission bandwidth
2. Set RBW = approximately 1% of the emission bandwidth.
3. Set the VBW > RBW.
4. Detector = Peak.
5. Trace mode = max hold
6. Measure the maximum width of the emission that is 26 dB down from the peak of the emission. Compare this with the RBW setting of the analyzer. Readjust RBW and repeat measurement as needed until the RBW/EBW ratio is approximately 1%.
7. For 99% Bandwidth Measurement, the spectrum analyzer's resolution bandwidth (RBW) is set 1MHz and set the Video bandwidth (VBW)  $\geq 3 * RBW$ .
8. Measure and record the results in the test report.

##### 3.1.4 Test Setup

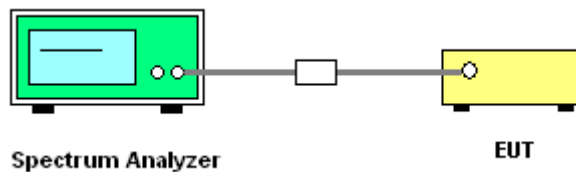



### 3.1.5 Test Result of 26dB & 99% Occupied Bandwidth Plots

Please refer to Appendix A.

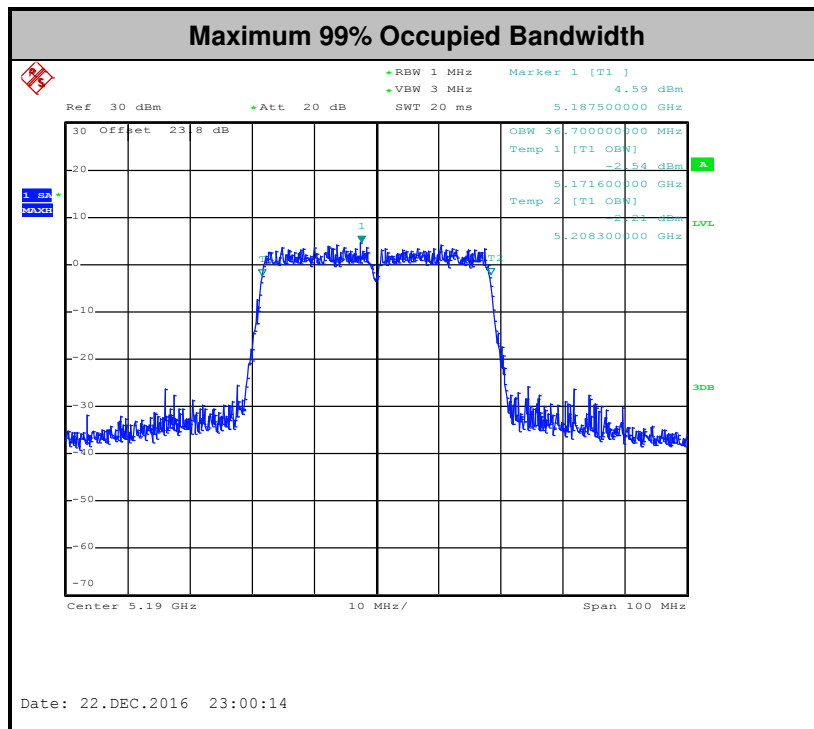
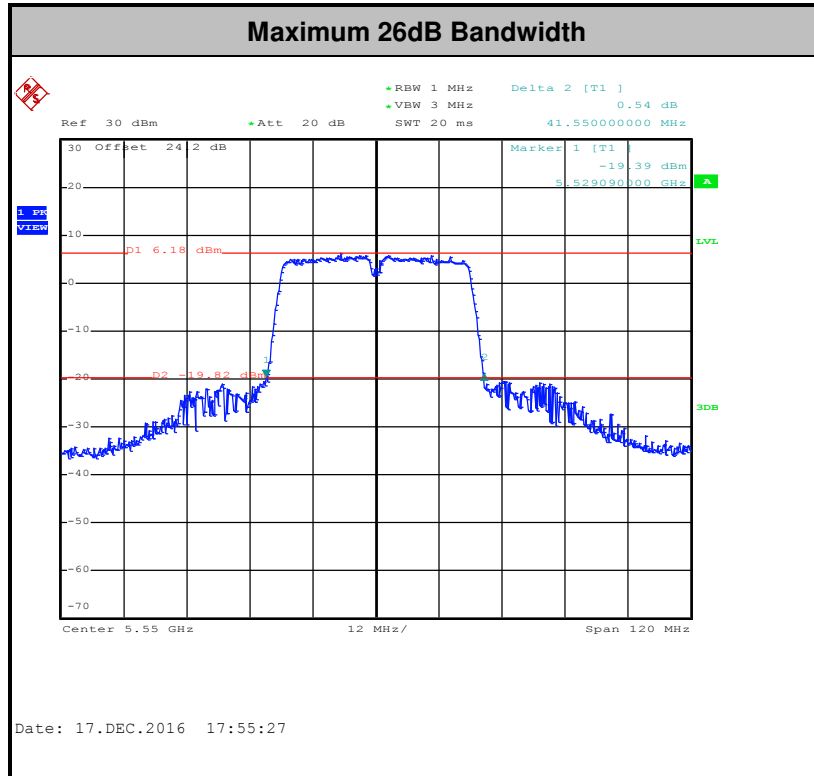



## 3.2 Maximum Conducted Output Power Measurement

### 3.2.1 Limit of Maximum Conducted Output Power

<FCC 14-30 CFR 15.407>

For mobile and portable client devices in the 5.15–5.25 GHz band, the maximum conducted output power over the frequency band of operation shall not exceed 250 mW.

For the 5.25–5.725 GHz bands, the maximum conducted output power over the frequency bands of operation shall not exceed the lesser of 250 mW or  $11 \text{ dBm} + 10 \log B$ , where B is the 26 dB emission bandwidth in megahertz.

For Straddle Channel, U-NII procedures and limits were applied for operations in the frequency band in accordance with FCC KDB 644545 D03.

If transmitting antennas of directional gain greater than 6 dBi are used, the peak output power shall be reduced by the amount in dB that the directional gain of the antenna exceeds 6 dBi.

Note that U-NII-2 band, devices with a maximum e.i.r.p. greater than 500 mW shall implement TPC in order to have the capability to operate at least 6 dB below the maximum permitted e.i.r.p. of 1 W.

### 3.2.2 Measuring Instruments

The measuring equipment is listed in the section 4 of this test report.

### 3.2.3 Test Procedures

The testing follows Method PM of FCC KDB 789033 D02 General UNII Test Procedures New Rules v01r03.

Method PM (Measurement using an RF average power meter):

1. Measurement is performed using a wideband RF power meter.
2. The EUT is configured to transmit continuously with a consistent duty cycle at its maximum power control level.
3. Measure the average power of the transmitter, and the average power is corrected with duty factor,  $10 \log(1/x)$ , where  $x$  is the duty cycle.

For straddle channel, the testing follows Method SA-3 (RMS detection with max hold) of FCC KDB 789033 D02 General UNII Test Procedures New Rules v01r03.

Compute power by integrating the spectrum across the 99% occupied bandwidth of the signal using the instrument's band power measurement function.

### 3.2.4 Test Setup

For normal channel:

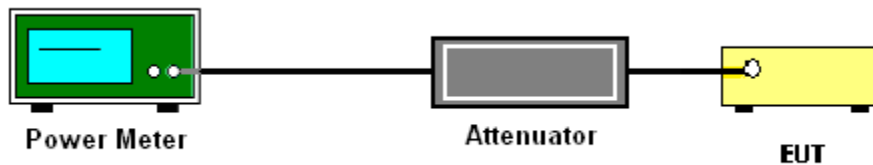

For straddle channel:

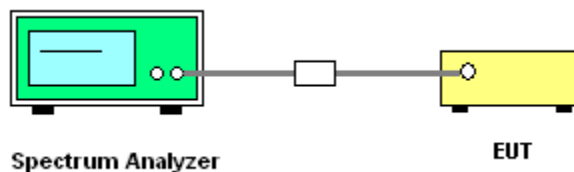





### 3.2.5 Test Result of Maximum Conducted Output Power

Please refer to Appendix A.

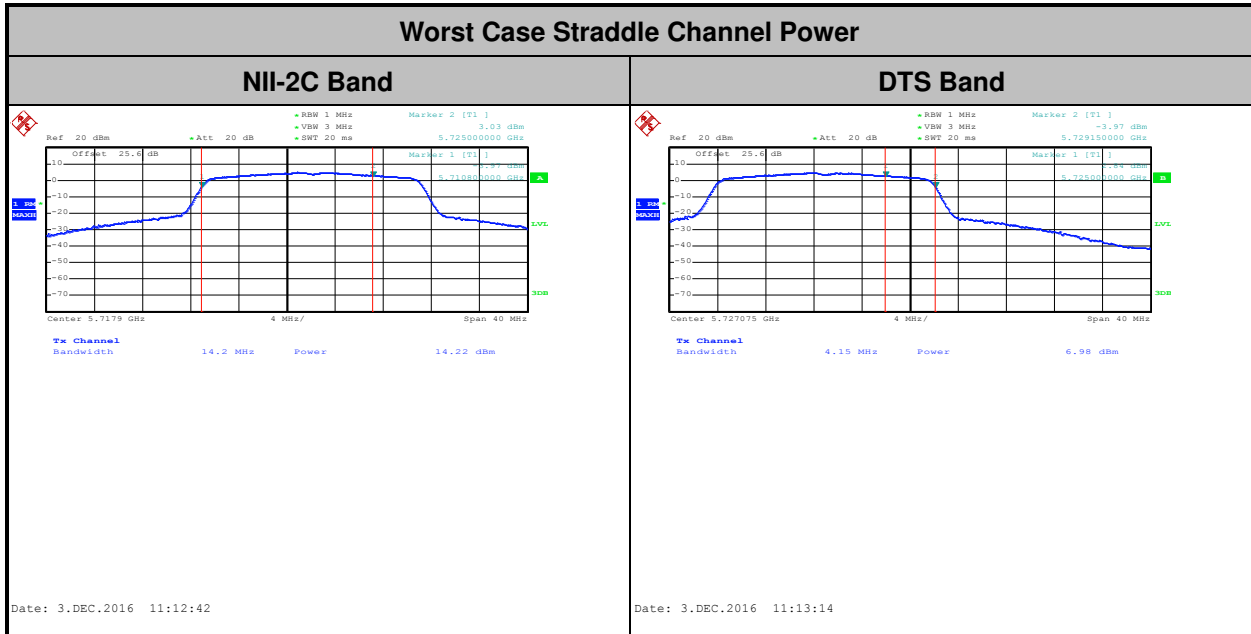



### **3.3 Power Spectral Density Measurement**

#### **3.3.1 Limit of Power Spectral Density**

**<FCC 14-30 CFR 15.407>**

For mobile and portable client devices in the 5.15–5.25 GHz band, the maximum power spectral density shall not exceed 11dBm in any 1 megahertz band.

For the 5.25–5.725 GHz bands, the maximum power spectral density shall not exceed 11 dBm in any 1 megahertz band.

For Straddle Channel, U-NII procedures and limits were applied for operations in the frequency band in accordance with FCC KDB 644545 D03.

If transmitting antennas of directional gain greater than 6 dBi are used, the peak output power shall be reduced by the amount in dB that the directional gain of the antenna exceeds 6 dBi.

#### **3.3.2 Measuring Instruments**

The measuring equipment is listed in the section 4 of this test report.

### 3.3.3 Test Procedures

The testing follows FCC KDB 789033 D02 General UNII Test Procedures New Rules v01r03.  
Section F) Maximum power spectral density.

#### # Method SA-2 #

(trace averaging across on and off times of the EUT transmissions, followed by duty cycle correction).

1. The testing follows Method SA-2 of FCC KDB 789033 D02 General UNII Test Procedures New Rules v01r03.
  - Measure the duty cycle.
  - Set span to encompass the entire emission bandwidth (EBW) of the signal.
  - Set RBW = 1 MHz.
  - Set VBW  $\geq$  3 MHz.
  - Number of points in sweep  $\geq$  2 Span / RBW.
  - Sweep time = auto.
  - Detector = RMS
  - Trace average at least 100 traces in power averaging mode.
  - Add  $10 \log(1/x)$ , where x is the duty cycle, to the measured power in order to compute the average power during the actual transmission times. For example, add  $10 \log(1/0.25) = 6$  dB if the duty cycle is 25 percent.
2. The RF output of EUT was connected to the spectrum analyzer by a low loss cable.
3. Each plot has already offset with cable loss, and attenuator loss. Measure the PPSD and record it.

### 3.3.4 Test Setup

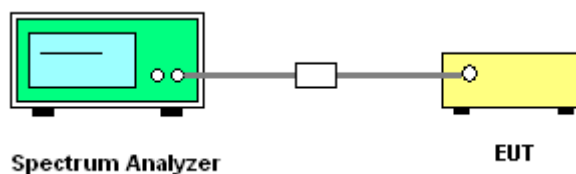



### 3.3.5 Test Result of Power Spectral Density

Please refer to Appendix A.

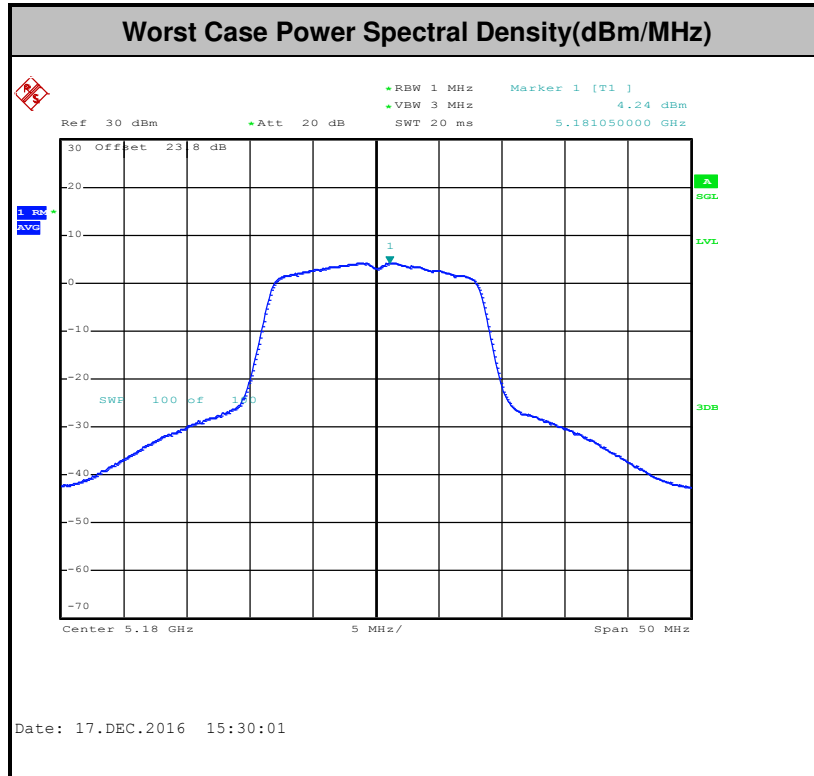

**Note:** Average Power Density (dB) = Measured value+ Duty Factor



### 3.4 Unwanted Radiated Emission Measurement

This section as specified in FCC Part 15.407(b) is to measure unwanted emissions through radiated measurement for band edge spurious emissions and out of band emissions measurement. The unwanted emissions shall comply with 15.407(b)(1) to (6), and restricted bands per FCC Part15.205.

#### 3.4.1 Limit of Unwanted Emissions

- (1) For transmitters operating in the 5150-5250 MHz band: all emissions outside of the 5150-5350 MHz band shall not exceed an EIRP of -27dBm/MHz.

For transmitters operating in the 5250-5350 MHz band: all emissions outside of the 5150-5350 MHz band shall not exceed an EIRP of -27 dBm/MHz. Devices operating in the 5250-5350 MHz band that generate emissions in the 5150-5250 MHz band must meet all applicable technical requirements for operation in the 5150-5250 MHz band (including indoor use) or alternatively meet an out-of-band emission EIRP limit of -27 dBm/MHz in the 5150-5250 MHz band.

For transmitters operating in the 5470-5725MHz band: all emissions outside of the 5470-5725MHz band shall not exceed an EIRP of -27 dBm/MHz.

- (2) Unwanted spurious emissions fallen in restricted bands per FCC Part15.205 shall comply with the general field strength limits set forth in § 15.209 as below table,

| Frequency (MHz) | Field Strength (microvolts/meter) | Measurement Distance (meters) |
|-----------------|-----------------------------------|-------------------------------|
| 0.009 – 0.490   | 2400/F(kHz)                       | 300                           |
| 0.490 – 1.705   | 24000/F(kHz)                      | 30                            |
| 1.705 – 30.0    | 30                                | 30                            |
| 30 – 88         | 100                               | 3                             |
| 88 – 216        | 150                               | 3                             |
| 216 - 960       | 200                               | 3                             |
| Above 960       | 500                               | 3                             |

**Note:** The following formula is used to convert the EIRP to field strength.

$$E = \frac{1000000\sqrt{30P}}{3} \mu V/m, \text{ where } P \text{ is the eirp (Watts)}$$



| EIRP (dBm) | Field Strength at 3m (dBμV/m) |
|------------|-------------------------------|
| -17        | 78.3                          |
| - 27       | 68.3                          |

(3) KDB789033 D01 v01r03 G)2)c) As specified in 15.407(b), emissions above 1000 MHz that are outside of the restricted bands are subject to a peak emission limit of -27 dBm/MHz (or -17 dBm/MHz as specified in 15.407(b)(4)). However, an out-of-band emission that complies with both the average and peak limits of 15.209 is not required to satisfy the -27 dBm/MHz or -17 dBm/MHz peak emission limit.

### 3.4.2 Measuring Instruments

The measuring equipment is listed in the section 4 of this test report.

### 3.4.3 Test Procedures

1. The testing follows FCC KDB 789033 D02 General UNII Test Procedures New Rules v01r03. Section G) Unwanted emissions measurement.

(1) Procedure for Unwanted Emissions Measurements Below 1000MHz

- RBW = 120 kHz
- VBW = 300 kHz
- Detector = Peak
- Trace mode = max hold

(2) Procedure for Peak Unwanted Emissions Measurements Above 1000 MHz

- RBW = 1 MHz
- VBW ≥ 3 MHz
- Detector = Peak
- Sweep time = auto
- Trace mode = max hold

(3) Procedures for Average Unwanted Emissions Measurements Above 1000MHz

- RBW = 1 MHz
- VBW = 10 Hz, when duty cycle is no less than 98 percent.
- VBW ≥ 1/T, when duty cycle is less than 98 percent where T is the minimum transmission duration over which the transmitter is on and is transmitting at its maximum power control level for the tested mode of operation.

2. The EUT was placed on a turntable with 0.8 meter for frequency below 1GHz and 1.5 meter for frequency above 1GHz respectively above ground.
3. The EUT was set 3 meters from the interference receiving antenna which was mounted on the top of a variable height antenna tower.
4. The antenna is a broadband antenna and its height is adjusted between one meter and four meters above ground to find the maximum value of the field strength for both horizontal polarization and vertical polarization of the antenna.
5. For each suspected emission, the EUT was arranged to its worst case and then adjust the antenna tower (from 1 m to 4 m) and turntable (from 0 degree to 360 degrees) to find the maximum reading.
6. For testing below 1GHz, if the emission level of the EUT in peak mode was 3 dB lower than the limit specified, then peak values of EUT will be reported, otherwise, the emissions will be repeated one by one using the CISPR quasi-peak method and reported.
7. For testing above 1GHz, the emission level of the EUT in peak mode was 20dB lower than average limit (that means the emission level in average mode also complies with the limit in average mode), then peak values of EUT will be reported, otherwise, the emissions will be measured in average mode again and reported.

### 3.4.4 Test Setup

For radiated emissions below 30MHz

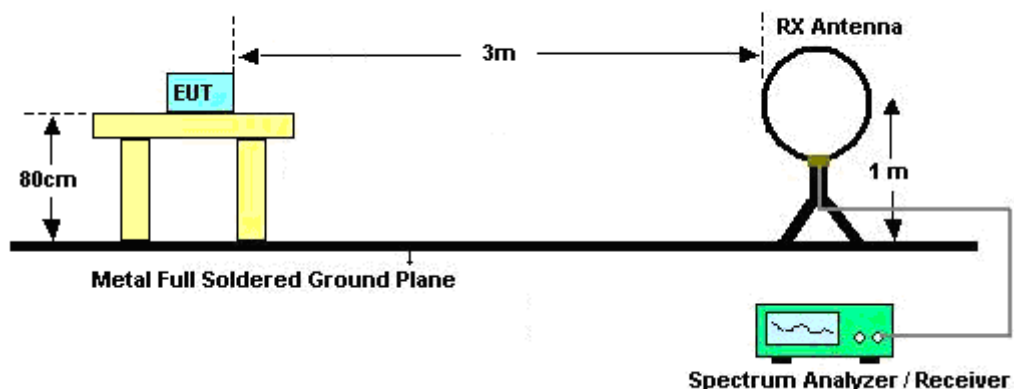

For radiated emissions from 30MHz to 1GHz

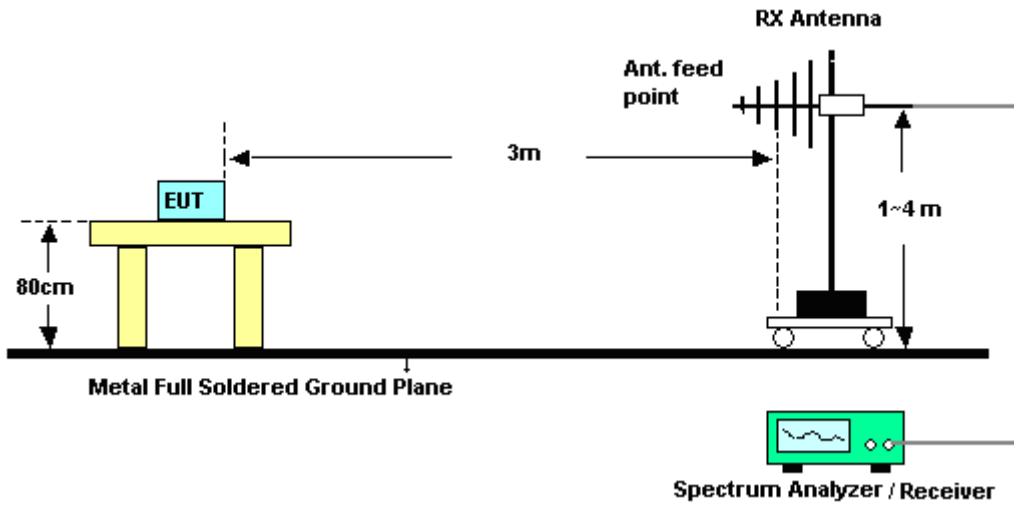

For radiated emissions above 1GHz

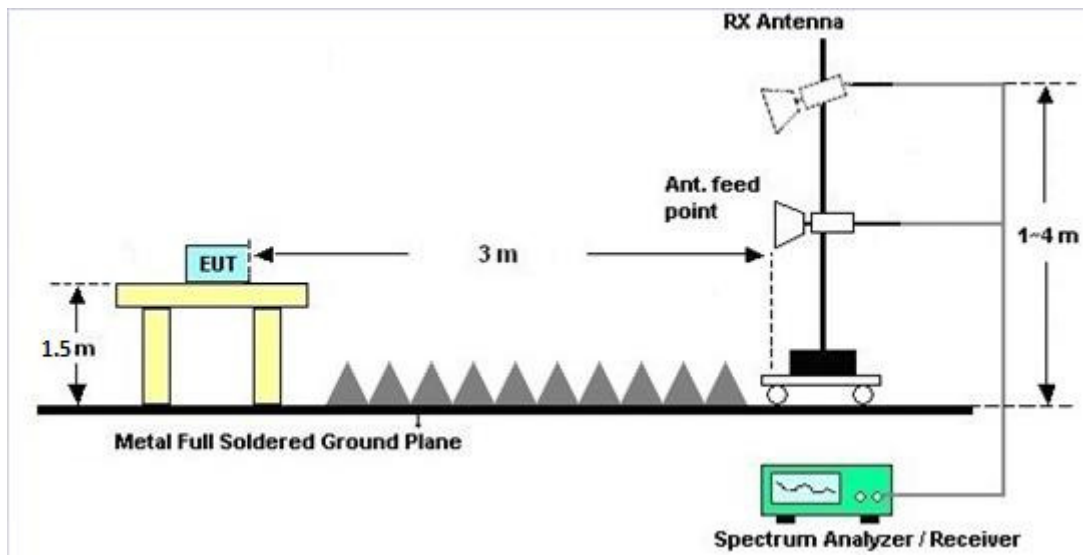





### **3.4.5 Test Results of Radiated Spurious Emissions (9 kHz ~ 30 MHz)**

The low frequency, which started from 9 kHz to 30MHz, was pre-scanned and the result which was 20dB lower than the limit line per 15.31(o) was not reported.

### **3.4.6 Test Result of Radiated Spurious at Band Edges**

Please refer to Appendix B and C.

### **3.4.7 Duty Cycle**

Please refer to Appendix D.

### **3.4.8 Test Result of Radiated Spurious Emissions (30MHz ~ 10th Harmonic)**

Please refer to Appendix B and C.



### 3.5 AC Conducted Emission Measurement

#### 3.5.1 Limit of AC Conducted Emission

For equipment that is designed to be connected to the public utility (AC) power line, the radio frequency voltage that is conducted back onto the AC power line on any frequency or frequencies within the band 150 kHz to 30 MHz shall not exceed the limits in the following table.

| Frequency of emission (MHz) | Conducted limit (dB $\mu$ V) |           |
|-----------------------------|------------------------------|-----------|
|                             | Quasi-peak                   | Average   |
| 0.15-0.5                    | 66 to 56*                    | 56 to 46* |
| 0.5-5                       | 56                           | 46        |
| 5-30                        | 60                           | 50        |

\*Decreases with the logarithm of the frequency.

#### 3.5.2 Measuring Instruments

The measuring equipment is listed in the section 4 of this test report.

#### 3.5.3 Test Procedures

1. The EUT was placed 0.4 meter from the conducting wall of the shielding room was kept at least 80 centimeters from any other grounded conducting surface.
2. Connect EUT to the power mains through a line impedance stabilization network (LISN).
3. All the support units are connecting to the other LISN.
4. The LISN provides 50 ohm coupling impedance for the measuring instrument.
5. The FCC states that a 50 ohm, 50 microhenry LISN should be used.
6. Both sides of AC line were checked for maximum conducted interference.
7. The frequency range from 150 kHz to 30 MHz was searched.
8. Set the test-receiver system to Peak Detect Function and specified bandwidth with Maximum Hold Mode.

### 3.5.4 Test Setup

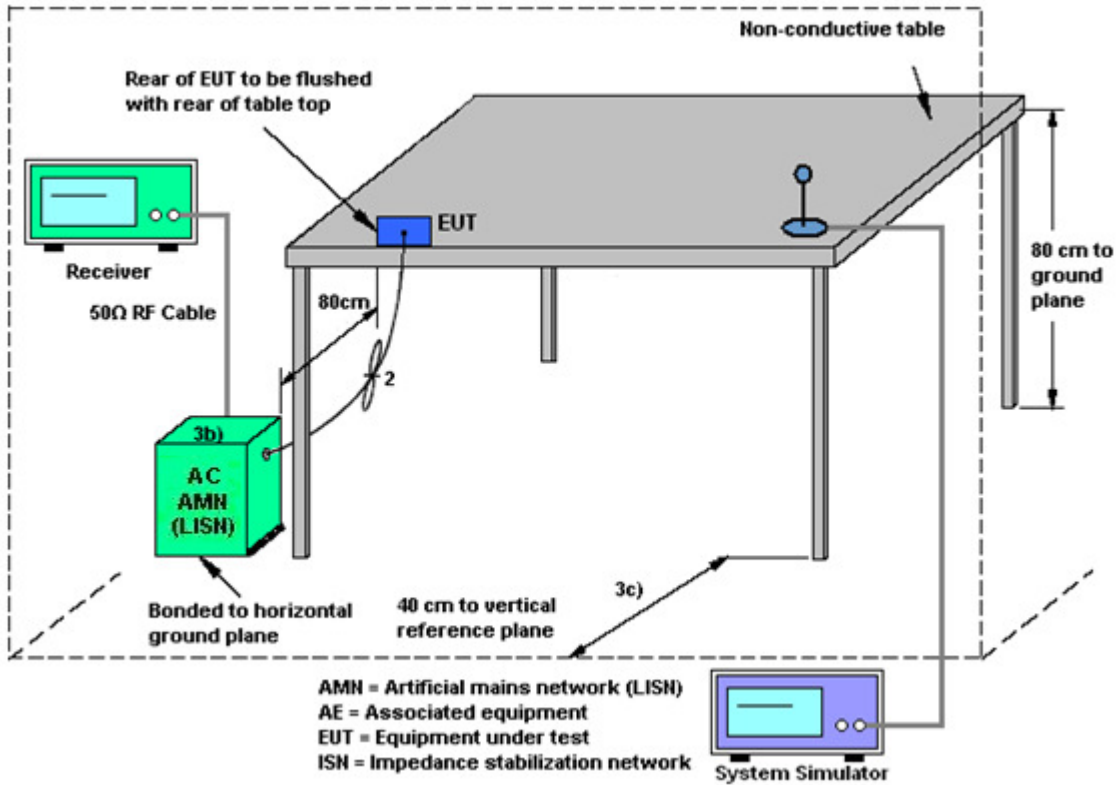



### 3.5.5 Test Result of AC Conducted Emission

|                 |   |                     |         |
|-----------------|---|---------------------|---------|
| Test Mode :     | Mode 1  | Temperature :       | 21~23°C |
| Test Engineer : | Arthur Hsieh  | Relative Humidity : | 50~52%  |
| Test Voltage :  | 120Vac / 60Hz   | Phase :             | Line    |
| Function Type : | GSM1900 Idle + Bluetooth Link + WLAN (5GHz) Link + Camera (Rear) + Earphone 1 + Battery + USB Cable (Charging from Adapter 3) |                     |         |

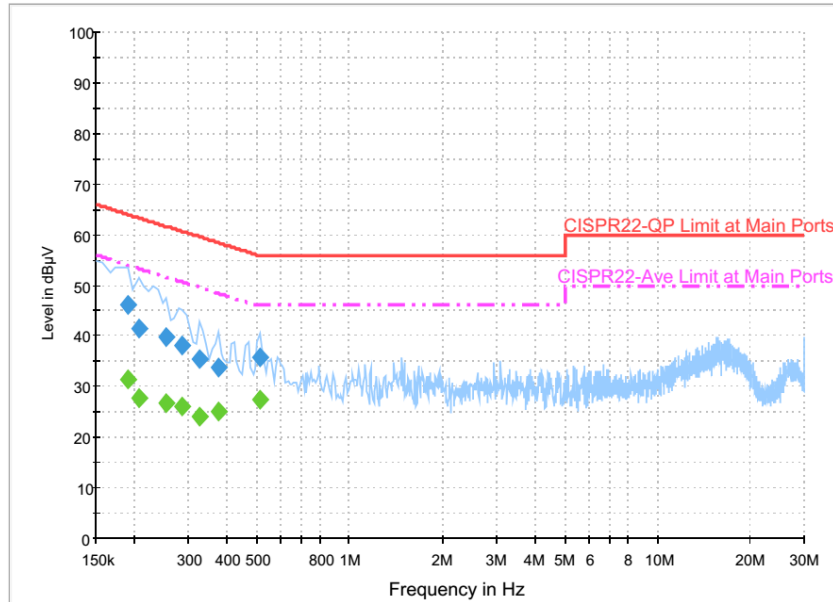

#### Final Result : QuasiPeak

| Frequency (MHz) | QuasiPeak (dBµV) | Filter | Line | Corr. (dB) | Margin (dB) | Limit (dBµV) |
|-----------------|------------------|--------|------|------------|-------------|--------------|
| 0.190000        | 46.3             | Off    | L1   | 19.6       | 17.7        | 64.0         |
| 0.206000        | 41.4             | Off    | L1   | 19.6       | 22.0        | 63.4         |
| 0.254000        | 39.9             | Off    | L1   | 19.6       | 21.7        | 61.6         |
| 0.286000        | 38.2             | Off    | L1   | 19.6       | 22.4        | 60.6         |
| 0.326000        | 35.4             | Off    | L1   | 19.6       | 24.2        | 59.6         |
| 0.374000        | 33.7             | Off    | L1   | 19.6       | 24.7        | 58.4         |
| 0.510000        | 35.7             | Off    | L1   | 19.6       | 20.3        | 56.0         |

#### Final Result : Average

| Frequency (MHz) | Average (dBµV) | Filter | Line | Corr. (dB) | Margin (dB) | Limit (dBµV) |
|-----------------|----------------|--------|------|------------|-------------|--------------|
| 0.190000        | 31.5           | Off    | L1   | 19.6       | 22.5        | 54.0         |
| 0.206000        | 27.6           | Off    | L1   | 19.6       | 25.8        | 53.4         |
| 0.254000        | 26.6           | Off    | L1   | 19.6       | 25.0        | 51.6         |
| 0.286000        | 25.9           | Off    | L1   | 19.6       | 24.7        | 50.6         |
| 0.326000        | 24.0           | Off    | L1   | 19.6       | 25.6        | 49.6         |
| 0.374000        | 25.2           | Off    | L1   | 19.6       | 23.2        | 48.4         |
| 0.510000        | 27.4           | Off    | L1   | 19.6       | 18.6        | 46.0         |



|                        |   |                            |         |
|------------------------|---|----------------------------|---------|
| <b>Test Mode :</b>     | Mode 1  | <b>Temperature :</b>       | 21~23°C |
| <b>Test Engineer :</b> | Arthur Hsieh  | <b>Relative Humidity :</b> | 50~52%  |
| <b>Test Voltage :</b>  | 120Vac / 60Hz   | <b>Phase :</b>             | Neutral |
| <b>Function Type :</b> | GSM1900 Idle + Bluetooth Link + WLAN (5GHz) Link + Camera (Rear) + Earphone 1 + Battery + USB Cable (Charging from Adapter 3) |                            |         |

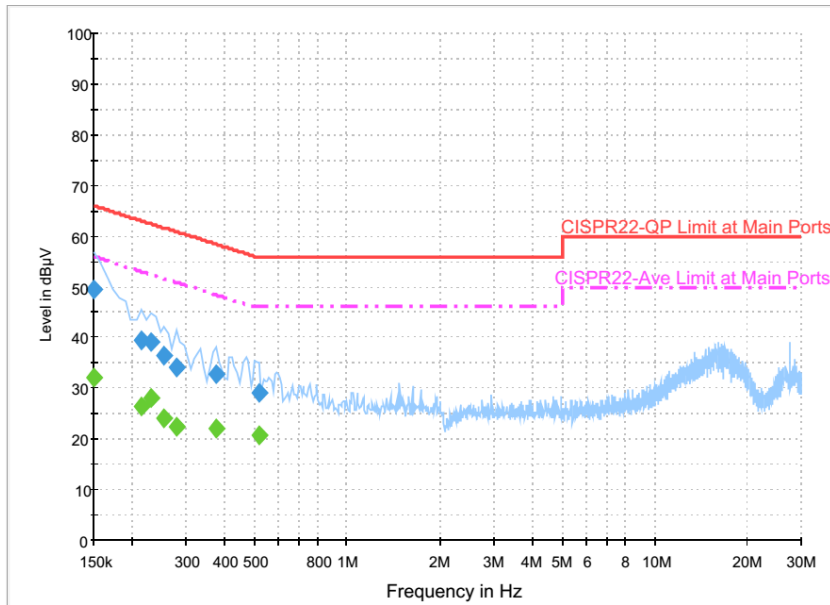

**Final Result : QuasiPeak**

| Frequency (MHz) | QuasiPeak (dBµV) | Filter | Line | Corr. (dB) | Margin (dB) | Limit (dBµV) |
|-----------------|------------------|--------|------|------------|-------------|--------------|
| 0.150000        | 49.5             | Off    | N    | 19.6       | 16.5        | 66.0         |
| 0.214000        | 39.6             | Off    | N    | 19.6       | 23.4        | 63.0         |
| 0.230000        | 39.1             | Off    | N    | 19.6       | 23.3        | 62.4         |
| 0.254000        | 36.4             | Off    | N    | 19.6       | 25.2        | 61.6         |
| 0.278000        | 34.0             | Off    | N    | 19.6       | 26.9        | 60.9         |
| 0.374000        | 32.9             | Off    | N    | 19.6       | 25.5        | 58.4         |
| 0.518000        | 28.9             | Off    | N    | 19.6       | 27.1        | 56.0         |

**Final Result : Average**

| Frequency (MHz) | Average (dBµV) | Filter | Line | Corr. (dB) | Margin (dB) | Limit (dBµV) |
|-----------------|----------------|--------|------|------------|-------------|--------------|
| 0.150000        | 32.0           | Off    | N    | 19.6       | 24.0        | 56.0         |
| 0.214000        | 26.5           | Off    | N    | 19.6       | 26.5        | 53.0         |
| 0.230000        | 28.2           | Off    | N    | 19.6       | 24.2        | 52.4         |
| 0.254000        | 24.0           | Off    | N    | 19.6       | 27.6        | 51.6         |
| 0.278000        | 22.4           | Off    | N    | 19.6       | 28.5        | 50.9         |
| 0.374000        | 22.2           | Off    | N    | 19.6       | 26.2        | 48.4         |
| 0.518000        | 20.7           | Off    | N    | 19.6       | 25.3        | 46.0         |

## 3.6 Frequency Stability Measurement

### 3.6.1 Limit of Frequency Stability

Manufacturers of U-NII devices are responsible for ensuring frequency stability such that an emission is maintained within the band of operation under all conditions of normal operation as specified in the user's manual.

### 3.6.2 Measuring Instruments

The measuring equipment is listed in the section 4 of this test report.

### 3.6.3 Test Procedures

1. To ensure emission at the band edge is maintained within the authorized band, those values shall be measured by radiation emissions at upper and lower frequency points, and finally compensated by frequency deviation as procedures below.
2. The EUT was operated at the maximum output power, and connected to the spectrum analyzer, which is set to maximum hold function and peak detector. The peak value of the power envelope was measured and noted. The upper and lower frequency points were respectively measured relatively 10dB lower than the measured peak value.
3. The frequency deviation was calculated by adding the upper frequency point and the lower frequency point divided by two. Those detailed values of frequency deviation are provided in table below.

### 3.6.4 Test Setup

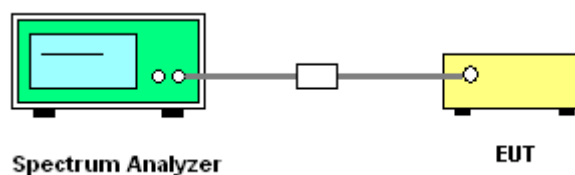

### 3.6.5 Test Result of Frequency Stability

Please refer to Appendix A.



## **3.7 Automatically Discontinue Transmission**

### **3.7.1 Limit of Automatically Discontinue Transmission**

The device shall automatically discontinue transmission in case of either absence of information to transmit or operational failure. These provisions are not intended to preclude the transmission of control or signaling information or the use of repetitive codes used by certain digital technologies to complete frame or burst intervals. Applicants shall include in their application for equipment authorization to describe how this requirement is met.

### **3.7.2 Measuring Instruments**

The measuring equipment is listed in the section 4 of this test report.

### **3.7.3 Test Result of Automatically Discontinue Transmission**

While the EUT is not transmitting any information, the EUT can automatically discontinue transmission and become standby mode for power saving. The EUT can detect the controlling signal of ACK message transmitting from remote device and verify whether it shall resend or discontinue transmission.



## **3.8 Antenna Requirements**

### **3.8.1 Standard Applicable**

According to FCC 47 CFR Section 15.407(a)(1)(2) ,if transmitting antenna directional gain is greater than 6 dBi, both the peak transmit power and the peak power spectral density shall be reduced by the amount in dB that the directional gain of the antenna exceeds 6 dBi.

### **3.8.2 Antenna Anti-Replacement Construction**

An embedded-in antenna design is used.

### **3.8.3 Antenna Gain**

The antenna gain is less than 6 dBi. Therefore, it is not necessary to reduce maximum peak output power limit.





## 4 List of Measuring Equipments

| Instrument           | Manufacturer    | Model No.    | Serial No.  | Characteristics | Calibration Date | Test Date                     | Due Date      | Remark                |
|----------------------|-----------------|--------------|-------------|-----------------|------------------|-------------------------------|---------------|-----------------------|
| Spectrum Analyzer    | Rohde & Schwarz | FSP40        | 100055      | 9kHz-40GHz      | Jul. 17, 2016    | Dec. 02, 2016 ~ Dec. 27, 2016 | Jul. 16, 2017 | Conducted (TH05-HY)   |
| Power Meter          | Anritsu         | ML2495A      | 0932001     | 300MHz~40GHz    | Sep. 29, 2016    | Dec. 02, 2016 ~ Dec. 27, 2016 | Sep. 28, 2017 | Conducted (TH05-HY)   |
| Power Sensor         | Anritsu         | MA2411B      | 0846202     | 300MHz~40GHz    | Sep. 29, 2016    | Dec. 02, 2016 ~ Dec. 27, 2016 | Sep. 28, 2017 | Conducted (TH05-HY)   |
| Hygrometer           | Testo           | 608-H2       | 41410069    | N/A             | Aug. 28, 2016    | Dec. 02, 2016 ~ Dec. 27, 2016 | Aug. 27, 2017 | Conducted (TH05-HY)   |
| RF Cable             | HUBER + SUHNER  | SUCOFLEX 104 | MY84209521  | 1GHz~26GHz      | Dec. 02, 2016    | Dec. 02, 2016 ~ Dec. 27, 2016 | Dec. 01, 2017 | Conducted (TH05-HY)   |
| Temperature Chamber  | ESPEC           | SH-641       | 92013720    | -40℃ ~90℃       | Sep. 01, 2016    | Dec. 02, 2016 ~ Dec. 27, 2016 | Aug. 31, 2017 | Conducted (TH05-HY)   |
| AC Power Source      | ChainTek        | APC-1000W    | N/A         | N/A             | N/A              | Dec. 06, 2016                 | N/A           | Conduction (CO05-HY)  |
| EMI Test Receiver    | Rohde & Schwarz | ESCI 7       | 100724      | 9kHz~7GHz       | Aug. 30, 2016    | Dec. 06, 2016                 | Aug. 29, 2017 | Conduction (CO05-HY)  |
| Hygrometer           | Testo           | 608-H1       | 34913912    | N/A             | Apr. 19, 2016    | Dec. 06, 2016                 | Apr. 18, 2017 | Conduction (CO05-HY)  |
| LISN                 | Rohde & Schwarz | ENV216       | 100080      | 9kHz~30MHz      | Nov. 28, 2016    | Dec. 06, 2016                 | Nov. 27, 2017 | Conduction (CO05-HY)  |
| LF Cable             | HUBER + SUHNER  | RG-214/U     | LF01        | N/A             | Jan. 06, 2016    | Dec. 06, 2016                 | Jan. 05, 2017 | Conduction (CO05-HY)  |
| Test Software        | N/A             | EMC32        | 8.40.0      | N/A             | N/A              | Dec. 06, 2016                 | N/A           | Conduction (CO05-HY)  |
| Loop Antenna         | Rohde & Schwarz | HFH2-Z2      | 100315      | 9 kHz~30 MHz    | Sep. 02, 2015    | Dec. 13, 2016 ~ Jan. 25, 2017 | Sep. 01, 2017 | Radiation (03CH11-HY) |
| Bilog Antenna        | TESEQ           | CBL 6111D    | 35414       | 30MHz~1GHz      | Oct. 15, 2016    | Dec. 13, 2016 ~ Jan. 25, 2017 | Oct. 14, 2017 | Radiation (03CH11-HY) |
| Horn Antenna         | SCHWARZBECK     | BBHA 9120 D  | 9120D-1522  | 1GHz ~ 18GHz    | Mar. 30, 2016    | Dec. 13, 2016 ~ Jan. 25, 2017 | Mar. 31, 2017 | Radiation (03CH11-HY) |
| SHF-EHF Horn Antenna | SCHWARZBECK     | BBHA 9170    | BBHA9170584 | 18GHz- 40GHz    | Nov. 08, 2016    | Dec. 13, 2016 ~ Jan. 25, 2017 | Nov. 07, 2017 | Radiation (03CH11-HY) |
| Spectrum Analyzer    | Keysight        | N9010A       | MY52350276  | 10Hz ~ 44GHZ    | Mar. 21, 2016    | Dec. 13, 2016 ~ Jan. 25, 2017 | Mar. 20, 2017 | Radiation (03CH11-HY) |
| Amplifier            | SONOMA          | 310N         | 187312      | 9kHz~1GHz       | Nov. 10, 2016    | Dec. 13, 2016 ~ Jan. 25, 2017 | Nov. 09, 2017 | Radiation (03CH11-HY) |
| Preamplifier         | Keysight        | 83017A       | MY53270080  | 1GHz~26.5GHz    | Nov. 10, 2016    | Dec. 13, 2016 ~ Jan. 25, 2017 | Nov. 09, 2017 | Radiation (03CH11-HY) |
| Preamplifier         | MITEQ           | TTA0204      | 1872107     | 2GHz~40GHz      | Feb. 15, 2016    | Dec. 13, 2016 ~ Jan. 25, 2017 | Feb. 14, 2017 | Radiation (03CH11-HY) |



| Instrument    | Manufacturer      | Model No.                           | Serial No.                         | Characteristics                  | Calibration Date | Test Date                        | Due Date      | Remark                   |
|---------------|-------------------|-------------------------------------|------------------------------------|----------------------------------|------------------|----------------------------------|---------------|--------------------------|
| Hygrometer    | TECPEL            | DTN-303B                            | TP140325                           | N/A                              | Nov. 11, 2016    | Dec. 13, 2016 ~<br>Jan. 25, 2017 | Nov. 13, 2017 | Radiation<br>(03CH11-HY) |
| RF Cable      | HUBER +<br>SUHNER | SUCOFLEX<br>104                     | MY9837/4<br>MY28419/4M<br>Y28654/4 | 9KHz~40GHz                       | Sep. 12, 2016    | Dec. 13, 2016 ~<br>Jan. 25, 2017 | Sep. 11, 2017 | Radiation<br>(03CH11-HY) |
| Controller    | EMEC              | EM 1000                             | N/A                                | Control Turn<br>table & Ant Mast | N/A              | Dec. 13, 2016 ~<br>Jan. 25, 2017 | N/A           | Radiation<br>(03CH11-HY) |
| Antenna Mast  | EMEC              | AM-BS-4500-B                        | N/A                                | 1~4m                             | N/A              | Dec. 13, 2016 ~<br>Jan. 25, 2017 | N/A           | Radiation<br>(03CH11-HY) |
| Turn Table    | EMEC              | TT 2000                             | N/A                                | 0~360 Degree                     | N/A              | Dec. 13, 2016 ~<br>Jan. 25, 2017 | N/A           | Radiation<br>(03CH11-HY) |
| Test Software | Audix             | E3                                  | 6.2009-8-24                        | N/A                              | N/A              | Dec. 13, 2016 ~<br>Jan. 25, 2017 | N/A           | Radiation<br>(03CH11-HY) |
| Filter        | Wainwright        | WLKX12-2700<br>-3000-18000-6<br>0SS | SN3                                | 2.7G High Pass                   | Sep. 19, 2016    | Dec. 13, 2016 ~<br>Jan. 25, 2017 | Sep. 18, 2017 | Radiation<br>(03CH11-HY) |
| Filter        | Wainwright        | WLK10-4630-5<br>093-11000-40<br>SS  | SN1                                | 4.5G High Pass                   | Sep. 19, 2016    | Dec. 13, 2016 ~<br>Jan. 25, 2017 | Sep. 18, 2017 | Radiation<br>(03CH11-HY) |



## 5 Uncertainty of Evaluation

### Uncertainty of Conducted Emission Measurement (150kHz ~ 30MHz)

|   |      |
|---|------|
| Measuring Uncertainty for a Level of Confidence of 95% ( $U = 2Uc(y)$ ) | 2.70 |
|---|------|

### Uncertainty of Radiated Emission Measurement (30 MHz ~ 1000 MHz)

|   |      |
|---|------|
| Measuring Uncertainty for a Level of Confidence of 95% ( $U = 2Uc(y)$ ) | 5.20 |
|---|------|

### Uncertainty of Radiated Emission Measurement (1000 MHz ~ 18000 MHz)

|   |      |
|---|------|
| Measuring Uncertainty for a Level of Confidence of 95% ( $U = 2Uc(y)$ ) | 5.50 |
|---|------|

### Uncertainty of Radiated Emission Measurement (18000 MHz ~ 40000 MHz)

|   |      |
|---|------|
| Measuring Uncertainty for a Level of Confidence of 95% ( $U = 2Uc(y)$ ) | 5.20 |
|---|------|

**Appendix A. Conducted Test Results**

|                |                        |                    |       |    |
|----------------|------------------------|--------------------|-------|----|
| Test Engineer: | Kai Liao / Derek Hsu   | Temperature:       | 21~25 | °C |
| Test Date:     | 2016/12/2 ~ 2016/12/22 | Relative Humidity: | 51~54 | %  |

**TEST RESULTS DATA**  
**26dB and 99% OBW**

| Band I |           |     |     |             |                     |                       |                                    |                                   |  |  |
|--------|-----------|-----|-----|-------------|---------------------|-----------------------|------------------------------------|-----------------------------------|--|--|
| Mod.   | Data Rate | NTX | CH. | Freq. (MHz) | 99% Bandwidth (MHz) | 26 dB Bandwidth (MHz) | IC 99% Bandwidth Power Limit (dBm) | IC 99% Bandwidth EIRP Limit (dBm) |  |  |
| 11a    | 6Mbps     | 1   | 36  | 5180        | 17.40               | 27.51                 | -                                  | 22.41                             |  |  |
| 11a    | 6Mbps     | 1   | 44  | 5220        | 17.40               | 27.51                 | -                                  | 22.41                             |  |  |
| 11a    | 6Mbps     | 1   | 48  | 5240        | 17.80               | 27.82                 | -                                  | 22.50                             |  |  |
| HT20   | MCS0      | 1   | 36  | 5180        | 18.35               | 32.24                 | -                                  | 22.64                             |  |  |
| HT20   | MCS0      | 1   | 44  | 5220        | 18.35               | 30.81                 | -                                  | 22.64                             |  |  |
| HT20   | MCS0      | 1   | 48  | 5240        | 18.25               | 31.34                 | -                                  | 22.61                             |  |  |
| HT40   | MCS0      | 1   | 38  | 5190        | 36.70               | 41.34                 | -                                  | 23.01                             |  |  |
| HT40   | MCS0      | 1   | 46  | 5230        | 36.60               | 41.04                 | -                                  | 23.01                             |  |  |

**TEST RESULTS DATA**  
**Average Power Table**

| FCC Band I |           |     |     |             |                  |                               |                                 |          |  |           |
|------------|-----------|-----|-----|-------------|------------------|-------------------------------|---------------------------------|----------|--|-----------|
| Mod.       | Data Rate | NTX | CH. | Freq. (MHz) | Duty Factor (dB) | Average Conducted Power (dBm) | FCC Conducted Power Limit (dBm) | DG (dBi) |  | Pass/Fail |
| 11a        | 6Mbps     | 1   | 36  | 5180        | 0.10             | 14.98                         | 24.00                           | -0.70    |  | Pass      |
| 11a        | 6Mbps     | 1   | 44  | 5220        | 0.10             | 14.70                         | 24.00                           | -0.70    |  | Pass      |
| 11a        | 6Mbps     | 1   | 48  | 5240        | 0.10             | 14.63                         | 24.00                           | -0.70    |  | Pass      |
| HT20       | MCS0      | 1   | 36  | 5180        | 0.13             | 14.90                         | 24.00                           | -0.70    |  | Pass      |
| HT20       | MCS0      | 1   | 44  | 5220        | 0.13             | 14.81                         | 24.00                           | -0.70    |  | Pass      |
| HT20       | MCS0      | 1   | 48  | 5240        | 0.13             | 14.74                         | 24.00                           | -0.70    |  | Pass      |
| HT40       | MCS0      | 1   | 38  | 5190        | 0.25             | 10.69                         | 24.00                           | -0.70    |  | Pass      |
| HT40       | MCS0      | 1   | 46  | 5230        | 0.25             | 10.53                         | 24.00                           | -0.70    |  | Pass      |

**TEST RESULTS DATA**  
**Power Spectral Density**

| FCC Band I |           |     |     |             |                  |                                 |                             |          |   |           |
|------------|-----------|-----|-----|-------------|------------------|---------------------------------|-----------------------------|----------|---|-----------|
| Mod.       | Data Rate | NTX | CH. | Freq. (MHz) | Duty Factor (dB) | Average Power Density (dBm/MHz) | Average PSD Limit (dBm/MHz) | DG (dBi) | - | Pass/Fail |
| 11a        | 6Mbps     | 1   | 36  | 5180        | 0.10             | 4.34                            | 11.00                       | -0.70    |   | Pass      |
| 11a        | 6Mbps     | 1   | 44  | 5220        | 0.10             | 3.48                            | 11.00                       | -0.70    |   | Pass      |
| 11a        | 6Mbps     | 1   | 48  | 5240        | 0.10             | 3.49                            | 11.00                       | -0.70    |   | Pass      |
| HT20       | MCS0      | 1   | 36  | 5180        | 0.13             | 3.88                            | 11.00                       | -0.70    |   | Pass      |
| HT20       | MCS0      | 1   | 44  | 5220        | 0.13             | 3.54                            | 11.00                       | -0.70    |   | Pass      |
| HT20       | MCS0      | 1   | 48  | 5240        | 0.13             | 3.56                            | 11.00                       | -0.70    |   | Pass      |
| HT40       | MCS0      | 1   | 38  | 5190        | 0.25             | -3.90                           | 11.00                       | -0.70    |   | Pass      |
| HT40       | MCS0      | 1   | 46  | 5230        | 0.25             | -2.96                           | 11.00                       | -0.70    |   | Pass      |

**TEST RESULTS DATA**  
**26dB and 99% OBW**

| Band II |           |     |     |             |                     |                       |                                    |                                   |                                      |      |
|---------|-----------|-----|-----|-------------|---------------------|-----------------------|------------------------------------|-----------------------------------|--------------------------------------|------|
| Mod.    | Data Rate | NTX | CH. | Freq. (MHz) | 99% Bandwidth (MHz) | 26 dB Bandwidth (MHz) | IC 99% Bandwidth Power Limit (dBm) | IC 99% Bandwidth EIRP Limit (dBm) | FCC 26dB Bandwidth Power Limit (dBm) | Note |
| 11a     | 6M bps    | 1   | 52  | 5260        | 17.30               | 27.66                 | 23.38                              | 29.38                             | 23.98                                |      |
| 11a     | 6M bps    | 1   | 60  | 5300        | 17.35               | 27.83                 | 23.39                              | 29.39                             | 23.98                                |      |
| 11a     | 6M bps    | 1   | 64  | 5320        | 17.50               | 25.42                 | 23.43                              | 29.43                             | 23.98                                |      |
| HT20    | MCS 0     | 1   | 52  | 5260        | 18.25               | 28.32                 | 23.61                              | 29.61                             | 23.98                                |      |
| HT20    | MCS 0     | 1   | 60  | 5300        | 18.15               | 30.03                 | 23.59                              | 29.59                             | 23.98                                |      |
| HT20    | MCS 0     | 1   | 64  | 5320        | 18.25               | 31.25                 | 23.61                              | 29.61                             | 23.98                                |      |
| HT40    | MCS 0     | 1   | 54  | 5270        | 36.60               | 41.13                 | 23.98                              | 30.00                             | 23.98                                |      |
| HT40    | MCS 0     | 1   | 62  | 5310        | 36.60               | 41.28                 | 23.98                              | 30.00                             | 23.98                                |      |



**TEST RESULTS DATA**  
**Average Power Table**

| FCC Band II |           |     |     |             |                  |                               |                                 |          |                        |           |
|-------------|-----------|-----|-----|-------------|------------------|-------------------------------|---------------------------------|----------|------------------------|-----------|
| Mod.        | Data Rate | NTX | CH. | Freq. (MHz) | Duty Factor (dB) | Average Conducted Power (dBm) | FCC Conducted Power Limit (dBm) | DG (dBi) | EIRP Power Limit (dBm) | Pass/Fail |
| 11a         | 6M bps    | 1   | 52  | 5260        | 0.10             | 14.96                         | 23.98                           | -0.20    | 26.99                  | Pass      |
| 11a         | 6M bps    | 1   | 60  | 5300        | 0.10             | 14.94                         | 23.98                           | -0.20    | 26.99                  | Pass      |
| 11a         | 6M bps    | 1   | 64  | 5320        | 0.10             | 14.90                         | 23.98                           | -0.20    | 26.99                  | Pass      |
| HT20        | MCS 0     | 1   | 52  | 5260        | 0.13             | 14.83                         | 23.98                           | -0.20    | 26.99                  | Pass      |
| HT20        | MCS 0     | 1   | 60  | 5300        | 0.13             | 14.81                         | 23.98                           | -0.20    | 26.99                  | Pass      |
| HT20        | MCS 0     | 1   | 64  | 5320        | 0.13             | 14.86                         | 23.98                           | -0.20    | 26.99                  | Pass      |
| HT40        | MCS 0     | 1   | 54  | 5270        | 0.25             | 10.56                         | 23.98                           | -0.20    | 26.99                  | Pass      |
| HT40        | MCS 0     | 1   | 62  | 5310        | 0.25             | 10.80                         | 23.98                           | -0.20    | 26.99                  | Pass      |

**TEST RESULTS DATA**  
**Power Spectral Density**

| Band II |           |     |     |             |                  |                                 |                             |          |  |           |
|---------|-----------|-----|-----|-------------|------------------|---------------------------------|-----------------------------|----------|--|-----------|
| Mod.    | Data Rate | NTX | CH. | Freq. (MHz) | Duty Factor (dB) | Average Power Density (dBm/MHz) | Average PSD Limit (dBm/MHz) | DG (dBi) |  | Pass/Fail |
| 11a     | 6M bps    | 1   | 52  | 5260        | 0.10             | 2.94                            | 11.00                       | -0.20    |  | Pass      |
| 11a     | 6M bps    | 1   | 60  | 5300        | 0.10             | 3.06                            | 11.00                       | -0.20    |  | Pass      |
| 11a     | 6M bps    | 1   | 64  | 5320        | 0.10             | 2.96                            | 11.00                       | -0.20    |  | Pass      |
| HT20    | MCS 0     | 1   | 52  | 5260        | 0.13             | 3.15                            | 11.00                       | -0.20    |  | Pass      |
| HT20    | MCS 0     | 1   | 60  | 5300        | 0.13             | 3.00                            | 11.00                       | -0.20    |  | Pass      |
| HT20    | MCS 0     | 1   | 64  | 5320        | 0.13             | 2.90                            | 11.00                       | -0.20    |  | Pass      |
| HT40    | MCS 0     | 1   | 54  | 5270        | 0.25             | -3.78                           | 11.00                       | -0.20    |  | Pass      |
| HT40    | MCS 0     | 1   | 62  | 5310        | 0.25             | -4.59                           | 11.00                       | -0.20    |  | Pass      |

**TEST RESULTS DATA**  
**26dB and 99% OBW**

| Band III |           |     |     |             |                     |                       |                                    |                                   |                                      |      |
|----------|-----------|-----|-----|-------------|---------------------|-----------------------|------------------------------------|-----------------------------------|--------------------------------------|------|
| Mod.     | Data Rate | NTX | CH. | Freq. (MHz) | 99% Bandwidth (MHz) | 26 dB Bandwidth (MHz) | IC 99% Bandwidth Power Limit (dBm) | IC 99% Bandwidth EIRP Limit (dBm) | FCC 26dB Bandwidth Power Limit (dBm) | Note |
| 11a      | 6M bps    | 1   | 100 | 5500        | 17.40               | 30.23                 | 23.41                              | 29.41                             | 23.98                                |      |
| 11a      | 6M bps    | 1   | 116 | 5580        | 17.45               | 29.64                 | 23.42                              | 29.42                             | 23.98                                |      |
| 11a      | 6M bps    | 1   | 140 | 5700        | 17.50               | 28.11                 | 23.43                              | 29.43                             | 23.98                                |      |
| HT20     | MCS 0     | 1   | 100 | 5500        | 18.30               | 31.47                 | 23.62                              | 29.62                             | 23.98                                |      |
| HT20     | MCS 0     | 1   | 116 | 5580        | 18.30               | 30.05                 | 23.62                              | 29.62                             | 23.98                                |      |
| HT20     | MCS 0     | 1   | 140 | 5700        | 18.25               | 30.33                 | 23.61                              | 29.61                             | 23.98                                |      |
| HT40     | MCS 0     | 1   | 102 | 5510        | 36.60               | 41.40                 | 23.98                              | 30.00                             | 23.98                                |      |
| HT40     | MCS 0     | 1   | 110 | 5550        | 36.50               | 41.55                 | 23.98                              | 30.00                             | 23.98                                |      |
| HT40     | MCS 0     | 1   | 134 | 5670        | 36.60               | 41.19                 | 23.98                              | 30.00                             | 23.98                                |      |

**TEST RESULTS DATA**  
**Average Power Table**

| FCC Band III |           |     |     |             |                  |                               |                                 |          |                        |           |
|--------------|-----------|-----|-----|-------------|------------------|-------------------------------|---------------------------------|----------|------------------------|-----------|
| Mod.         | Data Rate | NTX | CH. | Freq. (MHz) | Duty Factor (dB) | Average Conducted Power (dBm) | FCC Conducted Power Limit (dBm) | DG (dBi) | EIRP Power Limit (dBm) | Pass/Fail |
| 11a          | 6M bps    | 1   | 100 | 5500        | 0.10             | 14.90                         | 23.98                           | -0.30    | 26.99                  | Pass      |
| 11a          | 6M bps    | 1   | 116 | 5580        | 0.10             | 14.76                         | 23.98                           | -0.30    | 26.99                  | Pass      |
| 11a          | 6M bps    | 1   | 140 | 5700        | 0.10             | 14.81                         | 23.98                           | -0.30    | 26.99                  | Pass      |
| HT20         | MCS 0     | 1   | 100 | 5500        | 0.13             | 14.98                         | 23.98                           | -0.30    | 26.99                  | Pass      |
| HT20         | MCS 0     | 1   | 116 | 5580        | 0.13             | 14.65                         | 23.98                           | -0.30    | 26.99                  | Pass      |
| HT20         | MCS 0     | 1   | 140 | 5700        | 0.13             | 14.85                         | 23.98                           | -0.30    | 26.99                  | Pass      |
| HT40         | MCS 0     | 1   | 102 | 5510        | 0.25             | 10.66                         | 23.98                           | -0.30    | 26.99                  | Pass      |
| HT40         | MCS 0     | 1   | 110 | 5550        | 0.25             | 10.65                         | 23.98                           | -0.30    | 26.99                  | Pass      |
| HT40         | MCS 0     | 1   | 134 | 5670        | 0.25             | 10.51                         | 23.98                           | -0.30    | 26.99                  | Pass      |

**TEST RESULTS DATA**  
**Power Spectral Density**

| Band III |           |     |     |             |                  |                                 |                             |          |  |           |
|----------|-----------|-----|-----|-------------|------------------|---------------------------------|-----------------------------|----------|--|-----------|
| Mod.     | Data Rate | NTX | CH. | Freq. (MHz) | Duty Factor (dB) | Average Power Density (dBm/MHz) | Average PSD Limit (dBm/MHz) | DG (dBi) |  | Pass/Fail |
| 11a      | 6M bps    | 1   | 100 | 5500        | 0.10             | 3.58                            | 11.00                       | -0.30    |  | Pass      |
| 11a      | 6M bps    | 1   | 116 | 5580        | 0.10             | 4.23                            | 11.00                       | -0.30    |  | Pass      |
| 11a      | 6M bps    | 1   | 140 | 5700        | 0.10             | 2.83                            | 11.00                       | -0.30    |  | Pass      |
| HT20     | MCS 0     | 1   | 100 | 5500        | 0.13             | 3.49                            | 11.00                       | -0.30    |  | Pass      |
| HT20     | MCS 0     | 1   | 116 | 5580        | 0.13             | 3.72                            | 11.00                       | -0.30    |  | Pass      |
| HT20     | MCS 0     | 1   | 140 | 5700        | 0.13             | 2.62                            | 11.00                       | -0.30    |  | Pass      |
| HT40     | MCS 0     | 1   | 102 | 5510        | 0.25             | -3.06                           | 11.00                       | -0.30    |  | Pass      |
| HT40     | MCS 0     | 1   | 110 | 5550        | 0.25             | -2.64                           | 11.00                       | -0.30    |  | Pass      |
| HT40     | MCS 0     | 1   | 134 | 5670        | 0.25             | -3.47                           | 11.00                       | -0.30    |  | Pass      |

**TEST RESULTS DATA**  
**26dB and 99% OBW**

| Straddle Channel |           |     |     |             |                     |                               |                                    |                                   |                                      |                              |
|------------------|-----------|-----|-----|-------------|---------------------|-------------------------------|------------------------------------|-----------------------------------|--------------------------------------|------------------------------|
| Mod.             | Data Rate | NTX | CH. | Freq. (MHz) | 99% Bandwidth (MHz) | 26dB Emission Bandwidth (MHz) | IC 99% Bandwidth Power Limit (dBm) | IC 99% Bandwidth EIRP Limit (dBm) | FCC 26dB Bandwidth Power Limit (dBm) | 6dB Emission Bandwidth (MHz) |
| 11a              | 6Mbps     | 1   | 144 | 5720        | 17.35               | 32.01                         | -                                  | -                                 | -                                    | 15.42                        |
|                  |           |     |     | NII-2C      | 13.7                | 21.305                        | 22.37                              | 28.37                             | 23.98                                | 12.86                        |
|                  |           |     |     | NII-3       | 3.65                | 10.7                          | 30.00                              | 36.02                             | -                                    | 2.56                         |
| HT20             | MCS0      | 1   | 144 | 5720        | 18.35               | 34.78                         | -                                  | -                                 | -                                    | 15.06                        |
|                  |           |     |     | NII-2C      | 14.2                | 23.405                        | 22.52                              | 28.52                             | 23.98                                | 12.54                        |
|                  |           |     |     | NII-3       | 4.15                | 11.38                         | 30.00                              | 36.02                             | -                                    | 2.52                         |
| HT40             | MCS0      | 1   | 142 | 5710        | 36.20               | 41.19                         | -                                  | -                                 | -                                    | 36.04                        |
|                  |           |     |     | NII-2C      | 33.2                | 35.58                         | 23.98                              | 30.00                             | 23.98                                | 33.12                        |
|                  |           |     |     | NII-3       | 3                   | 5.61                          | 30.00                              | 36.02                             | -                                    | 2.92                         |

**TEST RESULTS DATA**  
**Average Power Table**

| FCC Straddle Channel |           |     |     |             |                  |                               |                                 |          |      |           |
|----------------------|-----------|-----|-----|-------------|------------------|-------------------------------|---------------------------------|----------|------|-----------|
| Mod.                 | Data Rate | NTX | CH. | Freq. (MHz) | Duty Factor (dB) | Average Conducted Power (dBm) | FCC Conducted Power Limit (dBm) | DG (dBi) |      | Pass/Fail |
| 11a                  | 6Mbps     | 1   | 144 | 5720        | 0.10             | 14.95                         | -                               | -0.30    |      | Pass      |
|                      |           |     |     | NII-2C      | 0.10             | 14.27                         | 23.98                           | -0.30    | Pass |           |
|                      |           |     |     | NII-3       | 0.10             | 6.58                          | 30.00                           | -0.30    | Pass |           |
| HT20                 | MCS0      | 1   | 144 | 5720        | 0.13             | 14.97                         | -                               | -0.30    |      | Pass      |
|                      |           |     |     | NII-2C      | 0.13             | 14.22                         | 23.98                           | -0.30    | Pass |           |
|                      |           |     |     | NII-3       | 0.13             | 6.98                          | 30.00                           | -0.30    | Pass |           |
| HT40                 | MCS0      | 1   | 142 | 5710        | 0.25             | 10.51                         | -                               | -0.30    |      | Pass      |
|                      |           |     |     | NII-2C      | 0.25             | 10.19                         | 23.98                           | -0.30    | Pass |           |
|                      |           |     |     | NII-3       | 0.25             | -1.03                         | 30.00                           | -0.30    | Pass |           |

**TEST RESULTS DATA**  
**Power Spectral Density**

| Straddle Channel |           |     |     |             |                  |                                 |                             |          |  |           |
|------------------|-----------|-----|-----|-------------|------------------|---------------------------------|-----------------------------|----------|--|-----------|
| Mod.             | Data Rate | NTX | CH. | Freq. (MHz) | Duty Factor (dB) | Average Power Density (dBm/MHz) | Average PSD Limit (dBm/MHz) | DG (dBi) |  | Pass/Fail |
| 11a              | 6Mbps     | 1   | 144 | NII-2C      | 0.10             | 3.81                            | 11.00                       | -0.30    |  | Pass      |
|                  |           |     |     | NII-3       | 0.10             | 3.81                            | 30.00                       | -0.30    |  | Pass      |
| HT20             | MCS0      | 1   | 144 | NII-2C      | 0.13             | 3.80                            | 11.00                       | -0.30    |  | Pass      |
|                  |           |     |     | NII-3       | 0.13             | 3.80                            | 30.00                       | -0.30    |  | Pass      |
| HT40             | MCS0      | 1   | 142 | NII-2C      | 0.25             | -3.38                           | 11.00                       | -0.30    |  | Pass      |
|                  |           |     |     | NII-3       | 0.25             | -3.38                           | 30.00                       | -0.30    |  | Pass      |



**TEST RESULTS DATA**  
**Frequency Stability**

| Band I |           |     |     |             |                        |                           |                           |                  |             |      |
|--------|-----------|-----|-----|-------------|------------------------|---------------------------|---------------------------|------------------|-------------|------|
| Mod.   | Data Rate | NTX | CH. | Freq. (MHz) | Center Frequency (MHz) | Frequency Deviation (MHz) | Frequency Stability (ppm) | Temperature (°C) | Voltage (V) | Note |
| 11a    | 6Mbps     | 1   | 36  | 5180        | 5180.000               | 0.000                     | 0.00                      | 50               | 3.8         |      |
| 11a    | 6Mbps     | 1   | 36  | 5180        | 5179.950               | -0.050                    | -9.65                     | -30              | 3.8         |      |
| 11a    | 6Mbps     | 1   | 36  | 5180        | 5180.025               | 0.025                     | 4.83                      | 20               | 4.35        |      |
| 11a    | 6Mbps     | 1   | 36  | 5180        | 5180.025               | 0.025                     | 4.83                      | 20               | 3.4         |      |
| 11a    | 6Mbps     | 1   | 36  | 5180        | 5180.000               | 0.000                     | 0.00                      | 20               | 3.8         |      |

| Band II |           |     |     |             |                        |                           |                           |                  |             |      |
|---------|-----------|-----|-----|-------------|------------------------|---------------------------|---------------------------|------------------|-------------|------|
| Mod.    | Data Rate | NTX | CH. | Freq. (MHz) | Center Frequency (MHz) | Frequency Deviation (MHz) | Frequency Stability (ppm) | Temperature (°C) | Voltage (V) | Note |
| 11a     | 6Mbps     | 1   | 64  | 5320        | 5320.000               | 0.000                     | 0.00                      | 50               | 3.8         |      |
| 11a     | 6Mbps     | 1   | 64  | 5320        | 5320.000               | 0.000                     | 0.00                      | -30              | 3.8         |      |
| 11a     | 6Mbps     | 1   | 64  | 5320        | 5320.000               | 0.000                     | 0.00                      | 20               | 4.35        |      |
| 11a     | 6Mbps     | 1   | 64  | 5320        | 5320.000               | 0.000                     | 0.00                      | 20               | 3.4         |      |
| 11a     | 6Mbps     | 1   | 64  | 5320        | 5320.050               | 0.050                     | 9.40                      | 20               | 3.8         |      |

| Band III |           |     |     |             |                        |                           |                           |                  |             |      |
|----------|-----------|-----|-----|-------------|------------------------|---------------------------|---------------------------|------------------|-------------|------|
| Mod.     | Data Rate | NTX | CH. | Freq. (MHz) | Center Frequency (MHz) | Frequency Deviation (MHz) | Frequency Stability (ppm) | Temperature (°C) | Voltage (V) | Note |
| 11a      | 6Mbps     | 1   | 100 | 5500        | 5500.000               | 0.000                     | 0.00                      | 50               | 3.8         |      |
| 11a      | 6Mbps     | 1   | 100 | 5500        | 5500.000               | 0.000                     | 0.00                      | -30              | 3.8         |      |
| 11a      | 6Mbps     | 1   | 100 | 5500        | 5500.000               | 0.000                     | 0.00                      | 20               | 4.35        |      |
| 11a      | 6Mbps     | 1   | 100 | 5500        | 5500.000               | 0.000                     | 0.00                      | 20               | 3.4         |      |
| 11a      | 6Mbps     | 1   | 100 | 5500        | 5500.000               | 0.000                     | 0.00                      | 20               | 3.8         |      |



## Appendix B. Radiated Spurious Emission

|                 |                                 |                     |         |
|-----------------|---------------------------------|---------------------|---------|
| Test Engineer : | J.C. Liang, Nick Yu, and Ken Wu | Temperature :       | 20~23°C |
|                 |                                 | Relative Humidity : | 58~63%  |

### Band 1 - 5150~5250MHz

#### WIFI 802.11a (Band Edge @ 3m)

| WIFI Ant. 1                 | Note | Frequency ( MHz ) | Level ( dBμV/m ) | Over Limit ( dB ) | Limit Line ( dBμV/m ) | Read Level (dBμV) | Antenna Factor ( dB/m ) | Cable Loss ( dB ) | Preamp Factor ( dB ) | Ant Pos ( cm ) | Table Pos ( deg ) | Peak Avg. (P/A) | Pol. (H/V) |   |
|-----------------------------|------|-------------------|------------------|-------------------|-----------------------|-------------------|-------------------------|-------------------|----------------------|----------------|-------------------|-----------------|------------|---|
| 802.11a<br>CH 36<br>5180MHz |      | 5117              | 51.34            | -22.66            | 74                    | 41.03             | 32.16                   | 11.19             | 33.04                | 239            | 63                | P               | H          |   |
|                             |      | 5147.42           | 43.6             | -10.4             | 54                    | 33.24             | 32.21                   | 11.18             | 33.03                | 239            | 63                | A               | H          |   |
|                             | *    | 5180              | 102.36           | -                 | -                     | 91.95             | 32.26                   | 11.18             | 33.03                | 239            | 63                | P               | H          |   |
|                             | *    | 5180              | 94.32            | -                 | -                     | 83.91             | 32.26                   | 11.18             | 33.03                | 239            | 63                | A               | H          |   |
|                             |      |                   |                  |                   |                       |                   |                         |                   |                      |                |                   |                 | H          |   |
|                             |      |                   |                  |                   |                       |                   |                         |                   |                      |                |                   |                 | H          |   |
|                             |      |                   | 5150             | 53.5              | -20.5                 | 74                | 43.14                   | 32.21             | 11.18                | 33.03          | 100               | 301             | P          | V |
|                             |      |                   | 5147.42          | 46.5              | -7.5                  | 54                | 36.14                   | 32.21             | 11.18                | 33.03          | 100               | 301             | A          | V |
|                             | *    |                   | 5180             | 106.52            | -                     | -                 | 96.11                   | 32.26             | 11.18                | 33.03          | 100               | 301             | P          | V |
|                             | *    |                   | 5180             | 98.52             | -                     | -                 | 88.11                   | 32.26             | 11.18                | 33.03          | 100               | 301             | A          | V |
|                             |      |                   |                  |                   |                       |                   |                         |                   |                      |                |                   |                 | V          |   |
|                             |      |                   |                  |                   |                       |                   |                         |                   |                      |                |                   |                 | V          |   |
| 802.11a<br>CH 44<br>5220MHz |      | 5089.18           | 51.44            | -22.56            | 74                    | 41.13             | 32.14                   | 11.21             | 33.04                | 235            | 62                | P               | H          |   |
|                             |      | 5147.42           | 42.62            | -11.38            | 54                    | 32.26             | 32.21                   | 11.18             | 33.03                | 235            | 62                | A               | H          |   |
|                             | *    | 5220              | 100.39           | -                 | -                     | 89.95             | 32.3                    | 11.17             | 33.03                | 235            | 62                | P               | H          |   |
|                             | *    | 5220              | 93.29            | -                 | -                     | 82.85             | 32.3                    | 11.17             | 33.03                | 235            | 62                | A               | H          |   |
|                             |      |                   | 5389.92          | 50.46             | -23.54                | 74                | 39.63                   | 32.54             | 11.31                | 33.02          | 235               | 62              | P          | H |
|                             |      |                   | 5454.24          | 41.73             | -12.27                | 54                | 30.78                   | 32.63             | 11.34                | 33.02          | 235               | 62              | A          | H |
|                             |      |                   | 5136.76          | 52                | -22                   | 74                | 41.65                   | 32.19             | 11.19                | 33.03          | 100               | 298             | P          | V |
|                             |      |                   | 5140.14          | 44.79             | -9.21                 | 54                | 34.43                   | 32.21             | 11.18                | 33.03          | 100               | 298             | A          | V |
|                             | *    |                   | 5220             | 105.58            | -                     | -                 | 95.14                   | 32.3              | 11.17                | 33.03          | 100               | 298             | P          | V |
|                             | *    |                   | 5220             | 97.45             | -                     | -                 | 87.01                   | 32.3              | 11.17                | 33.03          | 100               | 298             | A          | V |
|                             |      |                   | 5375.76          | 50.03             | -23.97                | 74                | 39.26                   | 32.51             | 11.28                | 33.02          | 100               | 298             | P          | V |
|                             |      |                   | 5372.88          | 41.73             | -12.27                | 54                | 30.97                   | 32.51             | 11.28                | 33.03          | 100               | 298             | A          | V |



|                                      |   |         |        |        |    |       |       |       |       |     |     |   |   |
|--------------------------------------|---|---------|--------|--------|----|-------|-------|-------|-------|-----|-----|---|---|
| <b>802.11a<br/>CH 48<br/>5240MHz</b> |   | 5014.04 | 50.74  | -23.26 | 74 | 40.52 | 32.02 | 11.24 | 33.04 | 239 | 68  | P | H |
|                                      |   | 5082.94 | 42.7   | -11.3  | 54 | 32.41 | 32.12 | 11.21 | 33.04 | 239 | 68  | A | H |
|                                      | *   | 5240    | 101.36 | -      | -  | 90.87 | 32.33 | 11.19 | 33.03 | 239 | 68  | P | H |
|                                      | *   | 5240    | 93.49  | -      | -  | 83    | 32.33 | 11.19 | 33.03 | 239 | 68  | A | H |
|                                      |   | 5366.16 | 50.9   | -23.1  | 74 | 40.14 | 32.51 | 11.28 | 33.03 | 239 | 68  | P | H |
|                                      |   | 5454.24 | 41.85  | -12.15 | 54 | 30.9  | 32.63 | 11.34 | 33.02 | 239 | 68  | A | H |
|                                      |   | 5127.92 | 52.19  | -21.81 | 74 | 41.84 | 32.19 | 11.19 | 33.03 | 100 | 301 | P | V |
|                                      |   | 5142.22 | 43.81  | -10.19 | 54 | 33.45 | 32.21 | 11.18 | 33.03 | 100 | 301 | A | V |
|                                      | *   | 5240    | 105.26 | -      | -  | 94.77 | 32.33 | 11.19 | 33.03 | 100 | 301 | P | V |
|                                      | *   | 5240    | 97.89  | -      | -  | 87.4  | 32.33 | 11.19 | 33.03 | 100 | 301 | A | V |
|                                      |   | 5450.4  | 50.3   | -23.7  | 74 | 39.35 | 32.63 | 11.34 | 33.02 | 100 | 301 | P | V |
|                                      |   | 5361.6  | 41.9   | -12.1  | 54 | 31.14 | 32.51 | 11.28 | 33.03 | 100 | 301 | A | V |
| Remark                               | 1. No other spurious found.<br>2. All results are PASS against Peak and Average limit line. |         |        |        |    |       |       |       |       |     |     |   |   |



Band 1 5150~5250MHz

WIFI 802.11a (Harmonic @ 3m)

| WIFI Ant. 1                 | Note  | Frequency ( MHz ) | Level ( dBμV/m ) | Over Limit ( dB ) | Limit Line ( dBμV/m ) | Read Level (dBμV) | Antenna Factor ( dB/m ) | Cable Loss ( dB ) | Preamp Factor ( dB ) | Ant Pos ( cm ) | Table Pos ( deg ) | Peak Avg. (P/A) | Pol. (H/V) |   |
|-----------------------------|---|-------------------|------------------|-------------------|-----------------------|-------------------|-------------------------|-------------------|----------------------|----------------|-------------------|-----------------|------------|---|
| 802.11a<br>CH 36<br>5180MHz |   | 10360             | 41.91            | -32.09            | 74                    | 38.13             | 39.84                   | 15.02             | 51.08                | 100            | 0                 | P               | H          |   |
|                             |   | 15540             | 41.24            | -32.76            | 74                    | 36.67             | 38.21                   | 18.16             | 51.8                 | 100            | 0                 | P               | H          |   |
|                             |   |                   |                  |                   |                       |                   |                         |                   |                      |                |                   |                 | H          |   |
|                             |   |                   |                  |                   |                       |                   |                         |                   |                      |                |                   |                 | H          |   |
|                             |   |                   | 10360            | 42.01             | -31.99                | 74                | 38.23                   | 39.84             | 15.02                | 51.08          | 100               | 0               | P          | V |
|                             |   |                   | 15540            | 44.75             | -29.25                | 74                | 40.18                   | 38.21             | 18.16                | 51.8           | 100               | 0               | P          | V |
|                             |   |                   |                  |                   |                       |                   |                         |                   |                      |                |                   |                 |            | V |
|                             |   |                   |                  |                   |                       |                   |                         |                   |                      |                |                   |                 |            | V |
| 802.11a<br>CH 44<br>5220MHz |   | 10440             | 40.63            | -33.37            | 74                    | 36.79             | 39.92                   | 15.08             | 51.16                | 100            | 0                 | P               | H          |   |
|                             |   | 15660             | 45.82            | -28.18            | 74                    | 41.16             | 38.23                   | 18.23             | 51.8                 | 100            | 0                 | P               | H          |   |
|                             |   |                   |                  |                   |                       |                   |                         |                   |                      |                |                   |                 | H          |   |
|                             |   |                   |                  |                   |                       |                   |                         |                   |                      |                |                   |                 | H          |   |
|                             |   |                   | 10440            | 40.93             | -33.07                | 74                | 37.09                   | 39.92             | 15.08                | 51.16          | 100               | 0               | P          | V |
|                             |   |                   | 15660            | 48.33             | -25.67                | 74                | 43.67                   | 38.23             | 18.23                | 51.8           | 100               | 0               | P          | V |
|                             |   |                   |                  |                   |                       |                   |                         |                   |                      |                |                   |                 |            | V |
|                             |   |                   |                  |                   |                       |                   |                         |                   |                      |                |                   |                 |            | V |
| 802.11a<br>CH 48<br>5240MHz |   | 10480             | 40.62            | -33.38            | 74                    | 36.73             | 39.98                   | 15.11             | 51.2                 | 100            | 0                 | P               | H          |   |
|                             |   | 15720             | 46.61            | -27.39            | 74                    | 41.89             | 38.24                   | 18.28             | 51.8                 | 100            | 0                 | P               | H          |   |
|                             |   |                   |                  |                   |                       |                   |                         |                   |                      |                |                   |                 | H          |   |
|                             |   |                   |                  |                   |                       |                   |                         |                   |                      |                |                   |                 | H          |   |
|                             |   |                   | 10480            | 41.89             | -32.11                | 74                | 38                      | 39.98             | 15.11                | 51.2           | 100               | 0               | P          | V |
|                             |   |                   | 15720            | 48.3              | -25.7                 | 74                | 43.58                   | 38.24             | 18.28                | 51.8           | 100               | 0               | P          | V |
|                             |   |                   |                  |                   |                       |                   |                         |                   |                      |                |                   |                 |            | V |
|                             |   |                   |                  |                   |                       |                   |                         |                   |                      |                |                   |                 |            | V |
| Remark                      | 1. No other spurious found.<br>2. All results are PASS against Peak and Average limit line. |                   |                  |                   |                       |                   |                         |                   |                      |                |                   |                 |            |   |



**Band 1 5150~5250MHz**  
**WIFI 802.11n HT20 (Band Edge @ 3m)**

| WIFI Ant. 1                | Note | Frequency ( MHz ) | Level ( dBμV/m ) | Over Limit ( dB ) | Limit Line ( dBμV/m ) | Read Level ( dBμV ) | Antenna Factor ( dB/m ) | Cable Loss ( dB ) | Preamp Factor ( dB ) | Ant Pos ( cm ) | Table Pos ( deg ) | Peak Avg. (P/A) | Pol. (H/V) |   |
|----------------------------|------|-------------------|------------------|-------------------|-----------------------|---------------------|-------------------------|-------------------|----------------------|----------------|-------------------|-----------------|------------|---|
| 802.11n HT20 CH 36 5180MHz |      | 5148.72           | 51.75            | -22.25            | 74                    | 41.39               | 32.21                   | 11.18             | 33.03                | 239            | 65                | P               | H          |   |
|                            |      | 5150              | 44.28            | -9.72             | 54                    | 33.92               | 32.21                   | 11.18             | 33.03                | 239            | 65                | A               | H          |   |
|                            | *    | 5180              | 103.1            | -                 | -                     | 92.69               | 32.26                   | 11.18             | 33.03                | 239            | 65                | P               | H          |   |
|                            | *    | 5180              | 95.84            | -                 | -                     | 85.43               | 32.26                   | 11.18             | 33.03                | 239            | 65                | A               | H          |   |
|                            |      |                   |                  |                   |                       |                     |                         |                   |                      |                |                   |                 | H          |   |
|                            |      |                   |                  |                   |                       |                     |                         |                   |                      |                |                   |                 |            | H |
|                            |      |                   | 5118.3           | 52.37             | -21.63                | 74                  | 42.05                   | 32.16             | 11.19                | 33.03          | 105               | 239             | P          | V |
|                            |      |                   | 5150             | 45.46             | -8.54                 | 54                  | 35.1                    | 32.21             | 11.18                | 33.03          | 105               | 239             | A          | V |
|                            |      | *                 | 5180             | 104.97            | -                     | -                   | 94.56                   | 32.26             | 11.18                | 33.03          | 105               | 239             | P          | V |
|                            |      | *                 | 5180             | 97.63             | -                     | -                   | 87.22                   | 32.26             | 11.18                | 33.03          | 105               | 239             | A          | V |
|                            |      |                   |                  |                   |                       |                     |                         |                   |                      |                |                   |                 | V          |   |
|                            |      |                   |                  |                   |                       |                     |                         |                   |                      |                |                   |                 | V          |   |
| 802.11n HT20 CH 44 5220MHz |      | 5128.96           | 51.53            | -22.47            | 74                    | 41.18               | 32.19                   | 11.19             | 33.03                | 236            | 64                | P               | H          |   |
|                            |      | 5139.88           | 43.39            | -10.61            | 54                    | 33.02               | 32.21                   | 11.19             | 33.03                | 236            | 64                | A               | H          |   |
|                            | *    | 5220              | 103.28           | -                 | -                     | 92.84               | 32.3                    | 11.17             | 33.03                | 236            | 64                | P               | H          |   |
|                            | *    | 5220              | 96.17            | -                 | -                     | 85.73               | 32.3                    | 11.17             | 33.03                | 236            | 64                | A               | H          |   |
|                            |      |                   | 5362.8           | 50.96             | -23.04                | 74                  | 40.2                    | 32.51             | 11.28                | 33.03          | 236               | 64              | P          | H |
|                            |      |                   | 5459.52          | 42                | -12                   | 54                  | 31.05                   | 32.63             | 11.34                | 33.02          | 236               | 64              | A          | H |
|                            |      |                   | 5105.56          | 52.12             | -21.88                | 74                  | 41.81                   | 32.16             | 11.19                | 33.04          | 120               | 242             | P          | V |
|                            |      |                   | 5139.88          | 44.65             | -9.35                 | 54                  | 34.28                   | 32.21             | 11.19                | 33.03          | 120               | 242             | A          | V |
|                            |      | *                 | 5220             | 105.4             | -                     | -                   | 94.96                   | 32.3              | 11.17                | 33.03          | 120               | 242             | P          | V |
|                            |      | *                 | 5220             | 98.26             | -                     | -                   | 87.82                   | 32.3              | 11.17                | 33.03          | 120               | 242             | A          | V |
|                            |      | 5398.32           | 50.39            | -23.61            | 74                    | 39.54               | 32.56                   | 11.31             | 33.02                | 120            | 242               | P               | V          |   |
|                            |      | 5395.2            | 41.93            | -12.07            | 54                    | 31.08               | 32.56                   | 11.31             | 33.02                | 120            | 242               | A               | V          |   |



|   |   |         |        |        |    |       |       |       |       |     |     |   |   |
|---|---|---------|--------|--------|----|-------|-------|-------|-------|-----|-----|---|---|
| <b>802.11n</b><br><b>HT20</b><br><b>CH 48</b><br><b>5240MHz</b> |   | 5105.56 | 52.57  | -21.43 | 74 | 42.26 | 32.16 | 11.19 | 33.04 | 251 | 62  | P | H |
|   |   | 5098.8  | 42.77  | -11.23 | 54 | 32.46 | 32.14 | 11.21 | 33.04 | 251 | 62  | A | H |
|   | *   | 5240    | 103.03 | -      | -  | 92.54 | 32.33 | 11.19 | 33.03 | 251 | 62  | P | H |
|   | *   | 5240    | 95.65  | -      | -  | 85.16 | 32.33 | 11.19 | 33.03 | 251 | 62  | A | H |
|   |   | 5394.72 | 50.79  | -23.21 | 74 | 39.94 | 32.56 | 11.31 | 33.02 | 251 | 62  | P | H |
|   |   | 5438.64 | 41.89  | -12.11 | 54 | 30.96 | 32.61 | 11.34 | 33.02 | 251 | 62  | A | H |
|   |   | 5048.88 | 51.55  | -22.45 | 74 | 41.3  | 32.07 | 11.22 | 33.04 | 107 | 302 | P | V |
|   |   | 5085.8  | 43.22  | -10.78 | 54 | 32.93 | 32.12 | 11.21 | 33.04 | 107 | 302 | A | V |
|   | *   | 5240    | 106.03 | -      | -  | 95.54 | 32.33 | 11.19 | 33.03 | 107 | 302 | P | V |
|   | *   | 5240    | 98.05  | -      | -  | 87.56 | 32.33 | 11.19 | 33.03 | 107 | 302 | A | V |
|   |   | 5353.92 | 50.63  | -23.37 | 74 | 39.89 | 32.49 | 11.28 | 33.03 | 107 | 302 | P | V |
|   |   | 5452.8  | 41.93  | -12.07 | 54 | 30.98 | 32.63 | 11.34 | 33.02 | 107 | 302 | A | V |
| <b>Remark</b>   | 1. No other spurious found.<br>2. All results are PASS against Peak and Average limit line. |         |        |        |    |       |       |       |       |     |     |   |   |



Band 1 5150~5250MHz

WIFI 802.11n HT20 (Harmonic @ 3m)

| WIFI Ant. 1                   | Note  | Frequency ( MHz ) | Level ( dBμV/m ) | Over Limit ( dB ) | Limit Line ( dBμV/m ) | Read Level (dBμV) | Antenna Factor ( dB/m ) | Cable Loss ( dB ) | Preamp Factor ( dB ) | Ant Pos ( cm ) | Table Pos ( deg ) | Peak Avg. (P/A) | Pol. (H/V) |   |
|-------------------------------|---|-------------------|------------------|-------------------|-----------------------|-------------------|-------------------------|-------------------|----------------------|----------------|-------------------|-----------------|------------|---|
| 802.11n HT20 CH 36<br>5180MHz |   | 10360             | 41.57            | -32.43            | 74                    | 37.79             | 39.84                   | 15.02             | 51.08                | 100            | 0                 | P               | H          |   |
|                               |   | 15540             | 40.95            | -33.05            | 74                    | 36.38             | 38.21                   | 18.16             | 51.8                 | 100            | 0                 | P               | H          |   |
|                               |   |                   |                  |                   |                       |                   |                         |                   |                      |                |                   |                 | H          |   |
|                               |   |                   |                  |                   |                       |                   |                         |                   |                      |                |                   |                 | H          |   |
|                               |   |                   | 10360            | 40.74             | -33.26                | 74                | 36.96                   | 39.84             | 15.02                | 51.08          | 100               | 0               | P          | V |
|                               |   |                   | 15540            | 44.6              | -29.4                 | 74                | 40.03                   | 38.21             | 18.16                | 51.8           | 100               | 0               | P          | V |
|                               |   |                   |                  |                   |                       |                   |                         |                   |                      |                |                   |                 |            | V |
| 802.11n HT20 CH 44<br>5220MHz |   | 10440             | 40.64            | -33.36            | 74                    | 36.8              | 39.92                   | 15.08             | 51.16                | 100            | 0                 | P               | H          |   |
|                               |   | 15660             | 44.03            | -29.97            | 74                    | 39.37             | 38.23                   | 18.23             | 51.8                 | 100            | 0                 | P               | H          |   |
|                               |   |                   |                  |                   |                       |                   |                         |                   |                      |                |                   |                 | H          |   |
|                               |   |                   |                  |                   |                       |                   |                         |                   |                      |                |                   |                 | H          |   |
|                               |   |                   | 10440            | 42.08             | -31.92                | 74                | 38.24                   | 39.92             | 15.08                | 51.16          | 100               | 0               | P          | V |
|                               |   |                   | 15660            | 46.52             | -27.48                | 74                | 41.86                   | 38.23             | 18.23                | 51.8           | 100               | 0               | P          | V |
|                               |   |                   |                  |                   |                       |                   |                         |                   |                      |                |                   |                 |            | V |
| 802.11n HT20 CH 48<br>5240MHz |   | 10480             | 40.13            | -33.87            | 74                    | 36.24             | 39.98                   | 15.11             | 51.2                 | 100            | 0                 | P               | H          |   |
|                               |   | 15720             | 45.08            | -28.92            | 74                    | 40.36             | 38.24                   | 18.28             | 51.8                 | 100            | 0                 | P               | H          |   |
|                               |   |                   |                  |                   |                       |                   |                         |                   |                      |                |                   |                 | H          |   |
|                               |   |                   |                  |                   |                       |                   |                         |                   |                      |                |                   |                 | H          |   |
|                               |   |                   | 10480            | 41.72             | -32.28                | 74                | 37.83                   | 39.98             | 15.11                | 51.2           | 100               | 0               | P          | V |
|                               |   |                   | 15720            | 47.72             | -26.28                | 74                | 43                      | 38.24             | 18.28                | 51.8           | 100               | 0               | P          | V |
|                               |   |                   |                  |                   |                       |                   |                         |                   |                      |                |                   |                 |            | V |
| Remark                        | 1. No other spurious found.<br>2. All results are PASS against Peak and Average limit line. |                   |                  |                   |                       |                   |                         |                   |                      |                |                   |                 |            |   |



Band 1 5150~5250MHz

WIFI 802.11n HT40 (Band Edge @ 3m)

| WIFI Ant. 1                | Note  | Frequency ( MHz ) | Level ( dBμV/m ) | Over Limit ( dB ) | Limit Line ( dBμV/m ) | Read Level ( dBμV ) | Antenna Factor ( dB/m ) | Cable Loss ( dB ) | Preamp Factor ( dB ) | Ant Pos ( cm ) | Table Pos ( deg ) | Peak Avg. ( P/A ) | Pol. ( H/V ) |   |
|----------------------------|---|-------------------|------------------|-------------------|-----------------------|---------------------|-------------------------|-------------------|----------------------|----------------|-------------------|-------------------|--------------|---|
| 802.11n HT40 CH 38 5190MHz |   | 5145.08           | 55.97            | -18.03            | 74                    | 45.61               | 32.21                   | 11.18             | 33.03                | 238            | 65                | P                 | H            |   |
|                            |   | 5149.76           | 49.54            | -4.46             | 54                    | 39.18               | 32.21                   | 11.18             | 33.03                | 238            | 65                | A                 | H            |   |
|                            | *   | 5190              | 97.33            | -                 | -                     | 86.93               | 32.26                   | 11.17             | 33.03                | 238            | 65                | P                 | H            |   |
|                            | *   | 5190              | 90.2             | -                 | -                     | 79.8                | 32.26                   | 11.17             | 33.03                | 238            | 65                | A                 | H            |   |
|                            |   | 5356.32           | 49.77            | -24.23            | 74                    | 39.03               | 32.49                   | 11.28             | 33.03                | 238            | 65                | P                 | H            |   |
|                            |   | 5458.8            | 42.36            | -11.64            | 54                    | 31.41               | 32.63                   | 11.34             | 33.02                | 238            | 65                | A                 | H            |   |
|                            |   | 5146.12           | 57.39            | -16.61            | 74                    | 47.03               | 32.21                   | 11.18             | 33.03                | 132            | 253               | P                 | V            |   |
|                            |   | 5148.72           | 50.86            | -3.14             | 54                    | 40.5                | 32.21                   | 11.18             | 33.03                | 132            | 253               | A                 | V            |   |
|                            | *   | 5190              | 98.78            | -                 | -                     | 88.38               | 32.26                   | 11.17             | 33.03                | 132            | 253               | P                 | V            |   |
|                            | *   | 5190              | 92.14            | -                 | -                     | 81.74               | 32.26                   | 11.17             | 33.03                | 132            | 253               | A                 | V            |   |
|                            |   | 5384.88           | 50.32            | -23.68            | 74                    | 39.49               | 32.54                   | 11.31             | 33.02                | 132            | 253               | P                 | V            |   |
|                            |   | 5457.6            | 42.71            | -11.29            | 54                    | 31.76               | 32.63                   | 11.34             | 33.02                | 132            | 253               | A                 | V            |   |
|                            | 802.11n HT40 CH 46 5230MHz  |                   | 5089.18          | 50.91             | -23.09                | 74                  | 40.6                    | 32.14             | 11.21                | 33.04          | 100               | 75                | P            | H |
|                            |   |                   | 5062.4           | 43.06             | -10.94                | 54                  | 32.8                    | 32.09             | 11.21                | 33.04          | 100               | 75                | A            | H |
| *                          |   | 5230              | 93.65            | -                 | -                     | 83.16               | 32.33                   | 11.19             | 33.03                | 100            | 75                | P                 | H            |   |
| *                          |   | 5230              | 85.43            | -                 | -                     | 74.94               | 32.33                   | 11.19             | 33.03                | 100            | 75                | A                 | H            |   |
|                            |   | 5383.2            | 50.46            | -23.54            | 74                    | 39.63               | 32.54                   | 11.31             | 33.02                | 100            | 75                | P                 | H            |   |
|                            |   | 5445.12           | 42.01            | -11.99            | 54                    | 31.08               | 32.61                   | 11.34             | 33.02                | 100            | 75                | A                 | H            |   |
|                            |   | 5025.74           | 50.53            | -23.47            | 74                    | 40.3                | 32.05                   | 11.22             | 33.04                | 100            | 135               | P                 | V            |   |
|                            |   | 5078.78           | 43.51            | -10.49            | 54                    | 33.22               | 32.12                   | 11.21             | 33.04                | 100            | 135               | A                 | V            |   |
| *                          |   | 5230              | 97.11            | -                 | -                     | 86.62               | 32.33                   | 11.19             | 33.03                | 100            | 135               | P                 | V            |   |
| *                          |   | 5230              | 88.66            | -                 | -                     | 78.17               | 32.33                   | 11.19             | 33.03                | 100            | 135               | A                 | V            |   |
|                            | 5422.56   | 50.43             | -23.57           | 74                | 39.53                 | 32.58               | 11.34                   | 33.02             | 100                  | 135            | P                 | V                 |              |   |
|                            | 5459.76   | 42.32             | -11.68           | 54                | 31.37                 | 32.63               | 11.34                   | 33.02             | 100                  | 135            | A                 | V                 |              |   |
| Remark                     | 1. No other spurious found.<br>2. All results are PASS against Peak and Average limit line. |                   |                  |                   |                       |                     |                         |                   |                      |                |                   |                   |              |   |





Band 1 5150~5250MHz

WIFI 802.11n HT40 (Harmonic @ 3m)

| WIFI Ant. 1                   | Note  | Frequency ( MHz ) | Level ( dBμV/m ) | Over Limit ( dB ) | Limit Line ( dBμV/m ) | Read Level (dBμV) | Antenna Factor ( dB/m ) | Cable Loss ( dB ) | Preamp Factor ( dB ) | Ant Pos ( cm ) | Table Pos ( deg ) | Peak Avg. (P/A) | Pol. (H/V) |
|-------------------------------|---|-------------------|------------------|-------------------|-----------------------|-------------------|-------------------------|-------------------|----------------------|----------------|-------------------|-----------------|------------|
| 802.11n HT40 CH 38<br>5190MHz |   | 10380             | 41.55            | -32.45            | 74                    | 37.79             | 39.86                   | 15.02             | 51.12                | 100            | 0                 | P               | H          |
|                               |   | 15570             | 40.95            | -33.05            | 74                    | 36.35             | 38.21                   | 18.19             | 51.8                 | 100            | 0                 | P               | H          |
|                               |   |                   |                  |                   |                       |                   |                         |                   |                      |                |                   |                 | H          |
|                               |   |                   |                  |                   |                       |                   |                         |                   |                      |                |                   |                 | H          |
|                               |   | 10380             | 41.55            | -32.45            | 74                    | 37.79             | 39.86                   | 15.02             | 51.12                | 100            | 0                 | P               | V          |
|                               |   | 15570             | 41.86            | -32.14            | 74                    | 37.26             | 38.21                   | 18.19             | 51.8                 | 100            | 0                 | P               | V          |
|                               |   |                   |                  |                   |                       |                   |                         |                   |                      |                |                   |                 | V          |
|                               |   |                   |                  |                   |                       |                   |                         |                   |                      |                |                   |                 | V          |
| 802.11n HT40 CH 46<br>5230MHz |   | 10460             | 39.17            | -34.83            | 74                    | 35.35             | 39.94                   | 15.08             | 51.2                 | 100            | 0                 | P               | H          |
|                               |   | 15690             | 40.74            | -33.26            | 74                    | 36.04             | 38.24                   | 18.26             | 51.8                 | 100            | 0                 | P               | H          |
|                               |   |                   |                  |                   |                       |                   |                         |                   |                      |                |                   |                 | H          |
|                               |   |                   |                  |                   |                       |                   |                         |                   |                      |                |                   |                 | H          |
|                               |   | 10460             | 40.39            | -33.61            | 74                    | 36.57             | 39.94                   | 15.08             | 51.2                 | 100            | 0                 | P               | V          |
|                               |   | 15690             | 39.24            | -34.76            | 74                    | 34.54             | 38.24                   | 18.26             | 51.8                 | 100            | 0                 | P               | V          |
|                               |   |                   |                  |                   |                       |                   |                         |                   |                      |                |                   |                 | V          |
|                               |   |                   |                  |                   |                       |                   |                         |                   |                      |                |                   |                 | V          |
| Remark                        | 1. No other spurious found.<br>2. All results are PASS against Peak and Average limit line. |                   |                  |                   |                       |                   |                         |                   |                      |                |                   |                 |            |



Band 2 - 5250~5350MHz

WIFI 802.11a (Band Edge @ 3m)

| WIFI                        | Note | Frequency | Level      | Over   | Limit      | Read   | Antenna  | Cable  | Preamp | Ant    | Table   | Peak  | Pol.  |
|-----------------------------|------|-----------|------------|--------|------------|--------|----------|--------|--------|--------|---------|-------|-------|
| Ant.                        |      |           |            | Limit  | Line       | Level  | Factor   | Loss   | Factor | Pos    | Pos     | Avg.  |       |
| 1                           |      | ( MHz )   | ( dBμV/m ) | ( dB ) | ( dBμV/m ) | (dBμV) | ( dB/m ) | ( dB ) | ( dB ) | ( cm ) | ( deg ) | (P/A) | (H/V) |
| 802.11a<br>CH 52<br>5260MHz |      | 5104.52   | 50.95      | -23.05 | 74         | 40.66  | 32.14    | 11.19  | 33.04  | 227    | 64      | P     | H     |
|                             |      | 5067.86   | 42.72      | -11.28 | 54         | 32.46  | 32.09    | 11.21  | 33.04  | 227    | 64      | A     | H     |
|                             | *    | 5260      | 103.07     | -      | -          | 92.54  | 32.37    | 11.19  | 33.03  | 227    | 64      | P     | H     |
|                             | *    | 5260      | 95.48      | -      | -          | 84.95  | 32.37    | 11.19  | 33.03  | 227    | 64      | A     | H     |
|                             |      | 5420.64   | 51.67      | -22.33 | 74         | 40.77  | 32.58    | 11.34  | 33.02  | 227    | 64      | P     | H     |
|                             |      | 5412.48   | 42.1       | -11.9  | 54         | 31.23  | 32.58    | 11.31  | 33.02  | 227    | 64      | A     | H     |
|                             |      | 5001.82   | 51.47      | -22.53 | 74         | 41.27  | 32       | 11.24  | 33.04  | 100    | 300     | P     | V     |
|                             |      | 5106.86   | 43.05      | -10.95 | 54         | 32.74  | 32.16    | 11.19  | 33.04  | 100    | 300     | A     | V     |
|                             | *    | 5260      | 104.18     | -      | -          | 93.65  | 32.37    | 11.19  | 33.03  | 100    | 300     | P     | V     |
|                             | *    | 5260      | 97.05      | -      | -          | 86.52  | 32.37    | 11.19  | 33.03  | 100    | 300     | A     | V     |
|                             |      | 5376      | 50.34      | -23.66 | 74         | 39.57  | 32.51    | 11.28  | 33.02  | 100    | 300     | P     | V     |
|                             |      | 5352.24   | 42.31      | -11.69 | 54         | 31.57  | 32.49    | 11.28  | 33.03  | 100    | 300     | A     | V     |
| 802.11a<br>CH 60<br>5300MHz |      | 5043.42   | 51.47      | -22.53 | 74         | 41.22  | 32.07    | 11.22  | 33.04  | 225    | 65      | P     | H     |
|                             |      | 5080.08   | 42.6       | -11.4  | 54         | 32.31  | 32.12    | 11.21  | 33.04  | 225    | 65      | A     | H     |
|                             | *    | 5300      | 104.8      | -      | -          | 94.19  | 32.42    | 11.22  | 33.03  | 225    | 65      | P     | H     |
|                             | *    | 5300      | 96.43      | -      | -          | 85.82  | 32.42    | 11.22  | 33.03  | 225    | 65      | A     | H     |
|                             |      | 5355.36   | 51.43      | -22.57 | 74         | 40.69  | 32.49    | 11.28  | 33.03  | 225    | 65      | P     | H     |
|                             |      | 5379.84   | 43.08      | -10.92 | 54         | 32.28  | 32.54    | 11.28  | 33.02  | 225    | 65      | A     | H     |
|                             |      | 5119.34   | 51.12      | -22.88 | 74         | 40.8   | 32.16    | 11.19  | 33.03  | 100    | 299     | P     | V     |
|                             |      | 5099.32   | 42.49      | -11.51 | 54         | 32.18  | 32.14    | 11.21  | 33.04  | 100    | 299     | A     | V     |
|                             | *    | 5300      | 104.55     | -      | -          | 93.94  | 32.42    | 11.22  | 33.03  | 100    | 299     | P     | V     |
|                             | *    | 5300      | 97.73      | -      | -          | 87.12  | 32.42    | 11.22  | 33.03  | 100    | 299     | A     | V     |
|                             |      | 5387.04   | 51.97      | -22.03 | 74         | 41.14  | 32.54    | 11.31  | 33.02  | 100    | 299     | P     | V     |
|                             |      | 5354.08   | 43.42      | -10.58 | 54         | 32.68  | 32.49    | 11.28  | 33.03  | 100    | 299     | A     | V     |



|  |   |         |        |        |    |       |       |       |       |     |     |   |   |
|--|---|---------|--------|--------|----|-------|-------|-------|-------|-----|-----|---|---|
| <b>802.11a</b><br><b>CH 64</b><br><b>5320MHz</b> | *   | 5320    | 104.31 | -      | -  | 93.65 | 32.44 | 11.25 | 33.03 | 317 | 70  | P | H |
|  | *   | 5320    | 97.27  | -      | -  | 86.61 | 32.44 | 11.25 | 33.03 | 317 | 70  | A | H |
|  |   | 5350.08 | 53.81  | -20.19 | 74 | 43.07 | 32.49 | 11.28 | 33.03 | 317 | 70  | P | H |
|  |   | 5350.88 | 44.64  | -9.36  | 54 | 33.9  | 32.49 | 11.28 | 33.03 | 317 | 70  | A | H |
|  |   |         |        |        |    |       |       |       |       |     |     |   | H |
|  |   |         |        |        |    |       |       |       |       |     |     |   | H |
|  | *   | 5320    | 105.46 | -      | -  | 94.8  | 32.44 | 11.25 | 33.03 | 100 | 282 | P | V |
|  | *   | 5320    | 98.5   | -      | -  | 87.84 | 32.44 | 11.25 | 33.03 | 100 | 282 | A | V |
|  |   | 5353.6  | 52.61  | -21.39 | 74 | 41.87 | 32.49 | 11.28 | 33.03 | 100 | 282 | P | V |
|  |   | 5350.56 | 45.32  | -8.68  | 54 | 34.58 | 32.49 | 11.28 | 33.03 | 100 | 282 | A | V |
|  |   |         |        |        |    |       |       |       |       |     |     |   | V |
|  |   |         |        |        |    |       |       |       |       |     |     |   | V |
| <b>Remark</b>                                    | 1. No other spurious found.<br>2. All results are PASS against Peak and Average limit line. |         |        |        |    |       |       |       |       |     |     |   |   |



Band 2 5250~5350MHz

WIFI 802.11a (Harmonic @ 3m)

| WIFI Ant. 1                 | Note  | Frequency ( MHz ) | Level ( dBμV/m ) | Over Limit ( dB ) | Limit Line ( dBμV/m ) | Read Level (dBμV) | Antenna Factor ( dB/m ) | Cable Loss ( dB ) | Preamp Factor ( dB ) | Ant Pos ( cm ) | Table Pos ( deg ) | Peak Avg. (P/A) | Pol. (H/V) |
|-----------------------------|---|-------------------|------------------|-------------------|-----------------------|-------------------|-------------------------|-------------------|----------------------|----------------|-------------------|-----------------|------------|
| 802.11a<br>CH 52<br>5260MHz |   | 10520             | 39.69            | -34.31            | 74                    | 35.81             | 39.99                   | 15.13             | 51.24                | 100            | 0                 | P               | H          |
|                             |   | 15780             | 51.02            | -22.98            | 74                    | 46.26             | 38.26                   | 18.3              | 51.8                 | 213            | 172               | P               | H          |
|                             |   | 15780             | 41.14            | -12.86            | 54                    | 36.38             | 38.26                   | 18.3              | 51.8                 | 213            | 172               | A               | H          |
|                             |   |                   |                  |                   |                       |                   |                         |                   |                      |                |                   |                 | H          |
|                             |   | 10520             | 39.86            | -34.14            | 74                    | 35.98             | 39.99                   | 15.13             | 51.24                | 100            | 0                 | P               | V          |
|                             |   | 15780             | 52.48            | -21.52            | 74                    | 47.72             | 38.26                   | 18.3              | 51.8                 | 200            | 339               | P               | V          |
|                             |   | 15780             | 42.54            | -11.46            | 54                    | 37.78             | 38.26                   | 18.3              | 51.8                 | 200            | 339               | A               | V          |
|                             |   |                   |                  |                   |                       |                   |                         |                   |                      |                |                   |                 |            |
| 802.11a<br>CH 60<br>5300MHz |   | 10600             | 39.03            | -34.97            | 74                    | 35.13             | 39.92                   | 15.19             | 51.21                | 100            | 0                 | P               | H          |
|                             |   | 15900             | 54.14            | -19.86            | 74                    | 49.29             | 38.28                   | 18.37             | 51.8                 | 208            | 193               | P               | H          |
|                             |   | 15900             | 42.83            | -11.17            | 54                    | 37.98             | 38.28                   | 18.37             | 51.8                 | 208            | 193               | A               | H          |
|                             |   |                   |                  |                   |                       |                   |                         |                   |                      |                |                   |                 | H          |
|                             |   | 10600             | 39.83            | -34.17            | 74                    | 35.93             | 39.92                   | 15.19             | 51.21                | 100            | 0                 | P               | V          |
|                             |   | 15900             | 55.53            | -18.47            | 74                    | 50.68             | 38.28                   | 18.37             | 51.8                 | 200            | 341               | P               | V          |
|                             |   | 15900             | 44.7             | -9.3              | 54                    | 39.85             | 38.28                   | 18.37             | 51.8                 | 200            | 341               | A               | V          |
|                             |   |                   |                  |                   |                       |                   |                         |                   |                      |                |                   |                 |            |
| 802.11a<br>CH 64<br>5320MHz |   | 10640             | 42.05            | -31.95            | 74                    | 38.13             | 39.89                   | 15.22             | 51.19                | 100            | 0                 | P               | H          |
|                             |   | 15960             | 55.88            | -18.12            | 74                    | 50.97             | 38.29                   | 18.42             | 51.8                 | 197            | 171               | P               | H          |
|                             |   | 15960             | 45.8             | -8.2              | 54                    | 40.89             | 38.29                   | 18.42             | 51.8                 | 197            | 171               | A               | H          |
|                             |   |                   |                  |                   |                       |                   |                         |                   |                      |                |                   |                 | H          |
|                             |   | 10640             | 45.21            | -28.79            | 74                    | 41.29             | 39.89                   | 15.22             | 51.19                | 100            | 0                 | P               | V          |
|                             |   | 15960             | 55.59            | -18.41            | 74                    | 50.68             | 38.29                   | 18.42             | 51.8                 | 200            | 340               | P               | V          |
|                             |   | 15960             | 45.36            | -8.64             | 54                    | 40.45             | 38.29                   | 18.42             | 51.8                 | 200            | 340               | A               | V          |
|                             |   |                   |                  |                   |                       |                   |                         |                   |                      |                |                   |                 |            |
| Remark                      | 1. No other spurious found.<br>2. All results are PASS against Peak and Average limit line. |                   |                  |                   |                       |                   |                         |                   |                      |                |                   |                 |            |



Band 2 5250~5350MHz

WIFI 802.11n HT20 (Band Edge @ 3m)

| WIFI Ant. 1                | Note    | Frequency ( MHz ) | Level ( dBμV/m ) | Over Limit ( dB ) | Limit Line ( dBμV/m ) | Read Level ( dBμV ) | Antenna Factor ( dB/m ) | Cable Loss ( dB ) | Preamp Factor ( dB ) | Ant Pos ( cm ) | Table Pos ( deg ) | Peak Avg. (P/A) | Pol. (H/V) |
|----------------------------|---------|-------------------|------------------|-------------------|-----------------------|---------------------|-------------------------|-------------------|----------------------|----------------|-------------------|-----------------|------------|
| 802.11n HT20 CH 52 5260MHz |         | 5083.46           | 51.51            | -22.49            | 74                    | 41.22               | 32.12                   | 11.21             | 33.04                | 228            | 66                | P               | H          |
|                            |         | 5099.06           | 42.69            | -11.31            | 54                    | 32.38               | 32.14                   | 11.21             | 33.04                | 228            | 66                | A               | H          |
|                            | *       | 5260              | 105.65           | -                 | -                     | 95.12               | 32.37                   | 11.19             | 33.03                | 228            | 66                | P               | H          |
|                            | *       | 5260              | 97.92            | -                 | -                     | 87.39               | 32.37                   | 11.19             | 33.03                | 228            | 66                | A               | H          |
|                            |         | 5387.76           | 50.09            | -23.91            | 74                    | 39.26               | 32.54                   | 11.31             | 33.02                | 228            | 66                | P               | H          |
|                            |         | 5355.6            | 42.32            | -11.68            | 54                    | 31.58               | 32.49                   | 11.28             | 33.03                | 228            | 66                | A               | H          |
|                            |         | 5119.08           | 51.16            | -22.84            | 74                    | 40.84               | 32.16                   | 11.19             | 33.03                | 100            | 298               | P               | V          |
|                            |         | 5106.86           | 43.18            | -10.82            | 54                    | 32.87               | 32.16                   | 11.19             | 33.04                | 100            | 298               | A               | V          |
|                            | *       | 5260              | 106.37           | -                 | -                     | 95.84               | 32.37                   | 11.19             | 33.03                | 100            | 298               | P               | V          |
|                            | *       | 5260              | 99.41            | -                 | -                     | 88.88               | 32.37                   | 11.19             | 33.03                | 100            | 298               | A               | V          |
|                            |         | 5445.6            | 50.18            | -23.82            | 74                    | 39.23               | 32.63                   | 11.34             | 33.02                | 100            | 298               | P               | V          |
|                            |         | 5351.04           | 42.52            | -11.48            | 54                    | 31.78               | 32.49                   | 11.28             | 33.03                | 100            | 298               | A               | V          |
| 802.11n HT20 CH 60 5300MHz |         | 5033.54           | 50.94            | -23.06            | 74                    | 40.71               | 32.05                   | 11.22             | 33.04                | 227            | 64                | P               | H          |
|                            |         | 5081.12           | 42.62            | -11.38            | 54                    | 32.33               | 32.12                   | 11.21             | 33.04                | 227            | 64                | A               | H          |
|                            | *       | 5300              | 105.22           | -                 | -                     | 94.61               | 32.42                   | 11.22             | 33.03                | 227            | 64                | P               | H          |
|                            | *       | 5300              | 98.1             | -                 | -                     | 87.49               | 32.42                   | 11.22             | 33.03                | 227            | 64                | A               | H          |
|                            |         | 5357.04           | 51.14            | -22.86            | 74                    | 40.4                | 32.49                   | 11.28             | 33.03                | 227            | 64                | P               | H          |
|                            |         | 5351.76           | 43.56            | -10.44            | 54                    | 32.82               | 32.49                   | 11.28             | 33.03                | 227            | 64                | A               | H          |
|                            |         | 5007.02           | 51.17            | -22.83            | 74                    | 40.95               | 32.02                   | 11.24             | 33.04                | 100            | 300               | P               | V          |
|                            |         | 5148.46           | 43.05            | -10.95            | 54                    | 32.69               | 32.21                   | 11.18             | 33.03                | 100            | 300               | A               | V          |
|                            | *       | 5300              | 106.36           | -                 | -                     | 95.75               | 32.42                   | 11.22             | 33.03                | 100            | 300               | P               | V          |
|                            | *       | 5300              | 99.52            | -                 | -                     | 88.91               | 32.42                   | 11.22             | 33.03                | 100            | 300               | A               | V          |
|                            | 5361.84 | 51.37             | -22.63           | 74                | 40.61                 | 32.51               | 11.28                   | 33.03             | 100                  | 300            | P                 | V               |            |
|                            | 5350.08 | 44.27             | -9.73            | 54                | 33.53                 | 32.49               | 11.28                   | 33.03             | 100                  | 300            | A                 | V               |            |



|   |   |         |        |        |    |       |       |       |       |     |     |   |   |
|---|---|---------|--------|--------|----|-------|-------|-------|-------|-----|-----|---|---|
| <b>802.11n</b><br><b>HT20</b><br><b>CH 64</b><br><b>5320MHz</b> | *   | 5320    | 105.52 | -      | -  | 94.86 | 32.44 | 11.25 | 33.03 | 239 | 64  | P | H |
|   | *   | 5320    | 98.19  | -      | -  | 87.53 | 32.44 | 11.25 | 33.03 | 239 | 64  | A | H |
|   |   | 5350.24 | 54.01  | -19.99 | 74 | 43.27 | 32.49 | 11.28 | 33.03 | 239 | 64  | P | H |
|   |   | 5350.08 | 45.76  | -8.24  | 54 | 35.02 | 32.49 | 11.28 | 33.03 | 239 | 64  | A | H |
|   |   |         |        |        |    |       |       |       |       |     |     |   | H |
|   |   |         |        |        |    |       |       |       |       |     |     |   | H |
|   | *   | 5320    | 106.03 | -      | -  | 95.37 | 32.44 | 11.25 | 33.03 | 100 | 301 | P | V |
|   | *   | 5320    | 98.95  | -      | -  | 88.29 | 32.44 | 11.25 | 33.03 | 100 | 301 | A | V |
|   |   | 5350.24 | 54.72  | -19.28 | 74 | 43.98 | 32.49 | 11.28 | 33.03 | 100 | 301 | P | V |
|   |   | 5350.08 | 46.35  | -7.65  | 54 | 35.61 | 32.49 | 11.28 | 33.03 | 100 | 301 | A | V |
|   |   |         |        |        |    |       |       |       |       |     |     |   | V |
|   |   |         |        |        |    |       |       |       |       |     |     |   | V |
| <b>Remark</b>   | 1. No other spurious found.<br>2. All results are PASS against Peak and Average limit line. |         |        |        |    |       |       |       |       |     |     |   |   |



Band 2 5250~5350MHz

WIFI 802.11n HT20 (Harmonic @ 3m)

| WIFI Ant. 1                   | Note  | Frequency ( MHz ) | Level ( dBμV/m ) | Over Limit ( dB ) | Limit Line ( dBμV/m ) | Read Level (dBμV) | Antenna Factor ( dB/m ) | Cable Loss ( dB ) | Preamp Factor ( dB ) | Ant Pos ( cm ) | Table Pos ( deg ) | Peak Avg. (P/A) | Pol. (H/V) |   |
|-------------------------------|---|-------------------|------------------|-------------------|-----------------------|-------------------|-------------------------|-------------------|----------------------|----------------|-------------------|-----------------|------------|---|
| 802.11n HT20 CH 52<br>5260MHz |   | 10520             | 40.69            | -33.31            | 74                    | 36.81             | 39.99                   | 15.13             | 51.24                | 100            | 0                 | P               | H          |   |
|                               |   | 15780             | 49.27            | -24.73            | 74                    | 44.51             | 38.26                   | 18.3              | 51.8                 | 100            | 0                 | P               | H          |   |
|                               |   |                   |                  |                   |                       |                   |                         |                   |                      |                |                   |                 | H          |   |
|                               |   |                   |                  |                   |                       |                   |                         |                   |                      |                |                   |                 | H          |   |
|                               |   |                   | 10520            | 40.66             | -33.34                | 74                | 36.78                   | 39.99             | 15.13                | 51.24          | 100               | 0               | P          | V |
|                               |   |                   | 15780            | 54.06             | -19.94                | 74                | 49.3                    | 38.26             | 18.3                 | 51.8           | 200               | 339             | P          | V |
|                               |   |                   | 15780            | 43.67             | -10.33                | 54                | 38.91                   | 38.26             | 18.3                 | 51.8           | 200               | 339             | A          | V |
|                               |   |                   |                  |                   |                       |                   |                         |                   |                      |                |                   |                 | V          |   |
| 802.11n HT20 CH 60<br>5300MHz |   | 10600             | 41.61            | -32.39            | 74                    | 37.71             | 39.92                   | 15.19             | 51.21                | 100            | 0                 | P               | H          |   |
|                               |   | 15900             | 50.68            | -23.32            | 74                    | 45.83             | 38.28                   | 18.37             | 51.8                 | 100            | 0                 | P               | H          |   |
|                               |   |                   |                  |                   |                       |                   |                         |                   |                      |                |                   |                 | H          |   |
|                               |   |                   |                  |                   |                       |                   |                         |                   |                      |                |                   |                 | H          |   |
|                               |   |                   | 10600            | 40.32             | -33.68                | 74                | 36.42                   | 39.92             | 15.19                | 51.21          | 100               | 0               | P          | V |
|                               |   |                   | 15900            | 55.77             | -18.23                | 74                | 50.92                   | 38.28             | 18.37                | 51.8           | 200               | 340             | P          | V |
|                               |   |                   | 15900            | 45.36             | -8.64                 | 54                | 40.51                   | 38.28             | 18.37                | 51.8           | 200               | 340             | A          | V |
|                               |   |                   |                  |                   |                       |                   |                         |                   |                      |                |                   |                 | V          |   |
| 802.11n HT20 CH 64<br>5320MHz |   | 10640             | 39.75            | -34.25            | 74                    | 35.83             | 39.89                   | 15.22             | 51.19                | 100            | 0                 | P               | H          |   |
|                               |   | 15960             | 50.79            | -23.21            | 74                    | 45.88             | 38.29                   | 18.42             | 51.8                 | 100            | 0                 | P               | H          |   |
|                               |   |                   |                  |                   |                       |                   |                         |                   |                      |                |                   |                 | H          |   |
|                               |   |                   |                  |                   |                       |                   |                         |                   |                      |                |                   |                 | H          |   |
|                               |   |                   | 10640            | 40.9              | -33.1                 | 74                | 36.98                   | 39.89             | 15.22                | 51.19          | 100               | 0               | P          | V |
|                               |   |                   | 15960            | 56.48             | -17.52                | 74                | 51.57                   | 38.29             | 18.42                | 51.8           | 201               | 339             | P          | V |
|                               |   |                   | 15960            | 44.56             | -9.44                 | 54                | 39.65                   | 38.29             | 18.42                | 51.8           | 201               | 339             | A          | V |
|                               |   |                   |                  |                   |                       |                   |                         |                   |                      |                |                   |                 | V          |   |
| Remark                        | 1. No other spurious found.<br>2. All results are PASS against Peak and Average limit line. |                   |                  |                   |                       |                   |                         |                   |                      |                |                   |                 |            |   |



**Band 2 5250~5350MHz**  
**WIFI 802.11n HT40 (Band Edge @ 3m)**

| WIFI Ant. 1                | Note  | Frequency ( MHz ) | Level ( dBμV/m ) | Over Limit ( dB ) | Limit Line ( dBμV/m ) | Read Level ( dBμV ) | Antenna Factor ( dB/m ) | Cable Loss ( dB ) | Preamp Factor ( dB ) | Ant Pos ( cm ) | Table Pos ( deg ) | Peak Avg. (P/A) | Pol. (H/V) |
|----------------------------|---|-------------------|------------------|-------------------|-----------------------|---------------------|-------------------------|-------------------|----------------------|----------------|-------------------|-----------------|------------|
| 802.11n HT40 CH 54 5270MHz |   | 5073.84           | 51.17            | -22.83            | 74                    | 40.88               | 32.12                   | 11.21             | 33.04                | 230            | 64                | P               | H          |
|                            |   | 5095.94           | 43.36            | -10.64            | 54                    | 33.05               | 32.14                   | 11.21             | 33.04                | 230            | 64                | A               | H          |
|                            | *   | 5270              | 95.08            | -                 | -                     | 84.52               | 32.37                   | 11.22             | 33.03                | 230            | 64                | P               | H          |
|                            | *   | 5270              | 87.13            | -                 | -                     | 76.57               | 32.37                   | 11.22             | 33.03                | 230            | 64                | A               | H          |
|                            |   | 5386.8            | 50.62            | -23.38            | 74                    | 39.79               | 32.54                   | 11.31             | 33.02                | 230            | 64                | P               | H          |
|                            |   | 5447.04           | 42.24            | -11.76            | 54                    | 31.29               | 32.63                   | 11.34             | 33.02                | 230            | 64                | A               | H          |
|                            |   | 5036.66           | 50.64            | -23.36            | 74                    | 40.41               | 32.05                   | 11.22             | 33.04                | 100            | 307               | P               | V          |
|                            |   | 5028.86           | 43.13            | -10.87            | 54                    | 32.9                | 32.05                   | 11.22             | 33.04                | 100            | 307               | A               | V          |
|                            | *   | 5270              | 96.96            | -                 | -                     | 86.4                | 32.37                   | 11.22             | 33.03                | 100            | 307               | P               | V          |
|                            | *   | 5270              | 88.67            | -                 | -                     | 78.11               | 32.37                   | 11.22             | 33.03                | 100            | 307               | A               | V          |
|                            |   | 5393.04           | 50.2             | -23.8             | 74                    | 39.37               | 32.54                   | 11.31             | 33.02                | 100            | 307               | P               | V          |
|                            |   | 5441.28           | 42.18            | -11.82            | 54                    | 31.25               | 32.61                   | 11.34             | 33.02                | 100            | 307               | A               | V          |
| 802.11n HT40 CH 62 5310MHz |   | 5015.6            | 51.13            | -22.87            | 74                    | 40.91               | 32.02                   | 11.24             | 33.04                | 239            | 64                | P               | H          |
|                            |   | 5104.52           | 43.35            | -10.65            | 54                    | 33.06               | 32.14                   | 11.19             | 33.04                | 239            | 64                | A               | H          |
|                            | *   | 5310              | 97.69            | -                 | -                     | 87.03               | 32.44                   | 11.25             | 33.03                | 239            | 64                | P               | H          |
|                            | *   | 5310              | 90.35            | -                 | -                     | 79.69               | 32.44                   | 11.25             | 33.03                | 239            | 64                | A               | H          |
|                            |   | 5350.08           | 58.48            | -15.52            | 74                    | 47.74               | 32.49                   | 11.28             | 33.03                | 239            | 64                | P               | H          |
|                            |   | 5350.08           | 49.15            | -4.85             | 54                    | 38.41               | 32.49                   | 11.28             | 33.03                | 239            | 64                | A               | H          |
|                            |   | 5095.42           | 50.62            | -23.38            | 74                    | 40.31               | 32.14                   | 11.21             | 33.04                | 108            | 245               | P               | V          |
|                            |   | 5089.18           | 43.38            | -10.62            | 54                    | 33.07               | 32.14                   | 11.21             | 33.04                | 108            | 245               | A               | V          |
|                            | *   | 5310              | 98.87            | -                 | -                     | 88.21               | 32.44                   | 11.25             | 33.03                | 108            | 245               | P               | V          |
|                            | *   | 5310              | 91.73            | -                 | -                     | 81.07               | 32.44                   | 11.25             | 33.03                | 108            | 245               | A               | V          |
|                            | 5350.8  | 56.18             | -17.82           | 74                | 45.44                 | 32.49               | 11.28                   | 33.03             | 108                  | 245            | P                 | V               |            |
|                            | 5350.8  | 50.26             | -3.74            | 54                | 39.52                 | 32.49               | 11.28                   | 33.03             | 108                  | 245            | P                 | V               |            |
| Remark                     | 1. No other spurious found.<br>2. All results are PASS against Peak and Average limit line. |                   |                  |                   |                       |                     |                         |                   |                      |                |                   |                 |            |





Band 2 5250~5350MHz

WIFI 802.11n HT40 (Harmonic @ 3m)

| WIFI Ant. 1                         | Note   | Frequency ( MHz ) | Level ( dBμV/m ) | Over Limit ( dB ) | Limit Line ( dBμV/m ) | Read Level (dBμV) | Antenna Factor ( dB/m ) | Cable Loss ( dB ) | Preamp Factor ( dB ) | Ant Pos ( cm ) | Table Pos ( deg ) | Peak Avg. (P/A) | Pol. (H/V) |   |
|-------------------------------------|--|-------------------|------------------|-------------------|-----------------------|-------------------|-------------------------|-------------------|----------------------|----------------|-------------------|-----------------|------------|---|
| 802.11n<br>HT40<br>CH 54<br>5270MHz |  | 10540             | 39.53            | -34.47            | 74                    | 35.65             | 39.97                   | 15.13             | 51.22                | 100            | 0                 | P               | H          |   |
|                                     |  | 15810             | 40.78            | -33.22            | 74                    | 35.99             | 38.26                   | 18.33             | 51.8                 | 100            | 0                 | P               | H          |   |
|                                     |  |                   |                  |                   |                       |                   |                         |                   |                      |                |                   |                 | H          |   |
|                                     |  |                   |                  |                   |                       |                   |                         |                   |                      |                |                   |                 | H          |   |
|                                     |  |                   | 10540            | 39.11             | -34.89                | 74                | 35.23                   | 39.97             | 15.13                | 51.22          | 100               | 0               | P          | V |
|                                     |  |                   | 15810            | 39.99             | -34.01                | 74                | 35.2                    | 38.26             | 18.33                | 51.8           | 100               | 0               | P          | V |
|                                     |  |                   |                  |                   |                       |                   |                         |                   |                      |                |                   |                 |            | V |
| 802.11n<br>HT40<br>CH 62<br>5310MHz |  | 10620             | 40.58            | -33.42            | 74                    | 36.68             | 39.9                    | 15.19             | 51.19                | 100            | 0                 | P               | H          |   |
|                                     |  | 15930             | 45.48            | -28.52            | 74                    | 40.59             | 38.29                   | 18.4              | 51.8                 | 100            | 0                 | P               | H          |   |
|                                     |  |                   |                  |                   |                       |                   |                         |                   |                      |                |                   |                 | H          |   |
|                                     |  |                   |                  |                   |                       |                   |                         |                   |                      |                |                   |                 | H          |   |
|                                     |  |                   | 10620            | 39.59             | -34.41                | 74                | 35.69                   | 39.9              | 15.19                | 51.19          | 100               | 0               | P          | V |
|                                     |  |                   | 15930            | 45.99             | -28.01                | 74                | 41.1                    | 38.29             | 18.4                 | 51.8           | 100               | 0               | P          | V |
|                                     |  |                   |                  |                   |                       |                   |                         |                   |                      |                |                   |                 |            | V |
| Remark                              | 1. No other spurious found.                                  |                   |                  |                   |                       |                   |                         |                   |                      |                |                   |                 |            |   |
|                                     | 2. All results are PASS against Peak and Average limit line. |                   |                  |                   |                       |                   |                         |                   |                      |                |                   |                 |            |   |



Band 3 - 5470~5725MHz

WIFI 802.11a (Band Edge @ 3m)

| WIFI                         | Note | Frequency | Level      | Over   | Limit      | Read   | Antenna  | Cable  | Preamp | Ant    | Table   | Peak  | Pol.  |   |
|------------------------------|------|-----------|------------|--------|------------|--------|----------|--------|--------|--------|---------|-------|-------|---|
| Ant.                         |      |           |            | Limit  | Line       | Level  | Factor   | Loss   | Factor | Pos    | Pos     | Avg.  |       |   |
| 1                            |      | ( MHz )   | ( dBμV/m ) | ( dB ) | ( dBμV/m ) | (dBμV) | ( dB/m ) | ( dB ) | ( dB ) | ( cm ) | ( deg ) | (P/A) | (H/V) |   |
| 802.11a<br>CH 100<br>5500MHz |      | 5461.2    | 54.12      | -19.88 | 74         | 43.13  | 32.63    | 11.38  | 33.02  | 227    | 68      | P     | H     |   |
|                              |      | 5469.52   | 46.68      | -7.32  | 54         | 35.67  | 32.65    | 11.38  | 33.02  | 227    | 68      | A     | H     |   |
|                              | *    | 5500      | 105.34     | -      | -          | 94.28  | 32.7     | 11.38  | 33.02  | 227    | 68      | P     | H     |   |
|                              | *    | 5500      | 98.17      | -      | -          | 87.11  | 32.7     | 11.38  | 33.02  | 227    | 68      | A     | H     |   |
|                              |      |           |            |        |            |        |          |        |        |        |         |       | H     |   |
|                              |      |           |            |        |            |        |          |        |        |        |         |       |       | H |
|                              |      |           | 5451.44    | 53.57  | -20.43     | 74     | 42.62    | 32.63  | 11.34  | 33.02  | 100     | 243   | P     | V |
|                              |      |           | 5469.2     | 45.42  | -8.58      | 54     | 34.41    | 32.65  | 11.38  | 33.02  | 100     | 243   | A     | V |
|                              | *    |           | 5500       | 105.26 | -          | -      | 94.2     | 32.7   | 11.38  | 33.02  | 100     | 243   | P     | V |
|                              | *    |           | 5500       | 97.24  | -          | -      | 86.18    | 32.7   | 11.38  | 33.02  | 100     | 243   | A     | V |
|                              |      |           |            |        |            |        |          |        |        |        |         |       |       | V |
|                              |      |           |            |        |            |        |          |        |        |        |         |       |       | V |
| 802.11a<br>CH 116<br>5580MHz |      | 5350      | 51         | -23    | 74         | 40.26  | 32.49    | 11.28  | 33.03  | 221    | 69      | P     | H     |   |
|                              |      | 5464.96   | 42.59      | -11.41 | 54         | 31.58  | 32.65    | 11.38  | 33.02  | 221    | 69      | A     | H     |   |
|                              | *    | 5580      | 104.96     | -      | -          | 93.79  | 32.8     | 11.44  | 33.07  | 221    | 69      | P     | H     |   |
|                              | *    | 5580      | 96.53      | -      | -          | 85.36  | 32.8     | 11.44  | 33.07  | 221    | 69      | A     | H     |   |
|                              |      |           | 5736.125   | 50.97  | -23.03     | 74     | 39.62    | 33.04  | 11.46  | 33.15  | 221     | 69    | P     | H |
|                              |      |           | 5733.325   | 42.8   | -11.2      | 54     | 31.48    | 33.01  | 11.46  | 33.15  | 221     | 69    | A     | H |
|                              |      |           | 5425.6     | 50.59  | -23.41     | 74     | 39.69    | 32.58  | 11.34  | 33.02  | 100     | 247   | P     | V |
|                              |      |           | 5467.6     | 42.48  | -11.52     | 54     | 31.47    | 32.65  | 11.38  | 33.02  | 100     | 247   | A     | V |
|                              | *    |           | 5580       | 104.88 | -          | -      | 93.71    | 32.8   | 11.44  | 33.07  | 100     | 247   | P     | V |
|                              | *    |           | 5580       | 97.1   | -          | -      | 85.93    | 32.8   | 11.44  | 33.07  | 100     | 247   | A     | V |
|                              |      |           | 5738.05    | 50.87  | -23.13     | 74     | 39.52    | 33.04  | 11.46  | 33.15  | 100     | 247   | P     | V |
|                              |      |           | 5732.275   | 42.78  | -11.22     | 54     | 31.46    | 33.01  | 11.46  | 33.15  | 100     | 247   | A     | V |



|   |   |         |        |        |    |       |       |       |       |     |     |   |   |
|---|---|---------|--------|--------|----|-------|-------|-------|-------|-----|-----|---|---|
| <b>802.11a</b><br><b>CH 140</b><br><b>5700MHz</b> | *   | 5700    | 106.06 | -      | -  | 94.74 | 32.97 | 11.47 | 33.12 | 268 | 189 | P | H |
|   | *   | 5700    | 98.25  | -      | -  | 86.93 | 32.97 | 11.47 | 33.12 | 268 | 189 | A | H |
|   |   | 5725.88 | 56.12  | -17.88 | 74 | 44.78 | 33.01 | 11.46 | 33.13 | 268 | 189 | P | H |
|   |   | 5725    | 46.72  | -7.28  | 54 | 35.38 | 33.01 | 11.46 | 33.13 | 268 | 189 | A | H |
|   |   |         |        |        |    |       |       |       |       |     |     |   | H |
|   |   |         |        |        |    |       |       |       |       |     |     |   | H |
|   | *   | 5700    | 103.78 | -      | -  | 92.46 | 32.97 | 11.47 | 33.12 | 117 | 201 | P | V |
|   | *   | 5700    | 96.47  | -      | -  | 85.15 | 32.97 | 11.47 | 33.12 | 117 | 201 | A | V |
|   |   | 5757.24 | 54.3   | -19.7  | 74 | 42.94 | 33.06 | 11.46 | 33.16 | 117 | 201 | P | V |
|   |   | 5725.08 | 45.41  | -8.59  | 54 | 34.07 | 33.01 | 11.46 | 33.13 | 117 | 201 | A | V |
|   |   |         |        |        |    |       |       |       |       |     |     |   | V |
|   |   |         |        |        |    |       |       |       |       |     |     |   | V |
| <b>Remark</b>                                     | 1. No other spurious found.<br>2. All results are PASS against Peak and Average limit line. |         |        |        |    |       |       |       |       |     |     |   |   |



**Band 3 - 5470~5725MHz**  
**WIFI 802.11a (Harmonic @ 3m)**

| WIFI Ant. 1                  | Note  | Frequency ( MHz ) | Level ( dBμV/m ) | Over Limit ( dB ) | Limit Line ( dBμV/m ) | Read Level (dBμV) | Antenna Factor ( dB/m ) | Cable Loss ( dB ) | Preamp Factor ( dB ) | Ant Pos ( cm ) | Table Pos ( deg ) | Peak Avg. (P/A) | Pol. (H/V) |   |
|------------------------------|---|-------------------|------------------|-------------------|-----------------------|-------------------|-------------------------|-------------------|----------------------|----------------|-------------------|-----------------|------------|---|
| 802.11a<br>CH 100<br>5500MHz |   | 11000             | 43.82            | -30.18            | 74                    | 39.76             | 39.6                    | 15.49             | 51.03                | 100            | 0                 | P               | H          |   |
|                              |   | 16500             | 60.32            | -13.68            | 74                    | 53.72             | 39.2                    | 19.27             | 51.87                | 200            | 172               | P               | H          |   |
|                              |   | 16500             | 50.45            | -3.55             | 54                    | 43.85             | 39.2                    | 19.27             | 51.87                | 200            | 172               | A               | H          |   |
|                              |   |                   |                  |                   |                       |                   |                         |                   |                      |                |                   |                 | H          |   |
|                              |   |                   | 11000            | 44                | -30                   | 74                | 39.94                   | 39.6              | 15.49                | 51.03          | 100               | 0               | P          | V |
|                              |   |                   | 16500            | 56.81             | -17.19                | 74                | 50.21                   | 39.2              | 19.27                | 51.87          | 209               | 358             | P          | V |
|                              |   |                   | 16500            | 46.52             | -7.48                 | 54                | 39.92                   | 39.2              | 19.27                | 51.87          | 209               | 358             | A          | V |
|                              |   |                   |                  |                   |                       |                   |                         |                   |                      |                |                   |                 | V          |   |
| 802.11a<br>CH 116<br>5580MHz |   | 11160             | 45.64            | -28.36            | 74                    | 41.69             | 39.43                   | 15.61             | 51.09                | 100            | 0                 | P               | H          |   |
|                              |   | 16740             | 59.63            | -14.37            | 74                    | 51.31             | 40.55                   | 19.68             | 51.91                | 199            | 175               | P               | H          |   |
|                              |   | 16740             | 49.39            | -4.61             | 54                    | 41.07             | 40.55                   | 19.68             | 51.91                | 199            | 175               | A               | H          |   |
|                              |   |                   |                  |                   |                       |                   |                         |                   |                      |                |                   |                 | H          |   |
|                              |   |                   | 11160            | 47.28             | -26.72                | 74                | 43.33                   | 39.43             | 15.61                | 51.09          | 100               | 0               | P          | V |
|                              |   |                   | 16740            | 54.22             | -19.78                | 74                | 45.9                    | 40.55             | 19.68                | 51.91          | 203               | 358             | P          | V |
|                              |   |                   | 16740            | 43.39             | -10.61                | 54                | 35.07                   | 40.55             | 19.68                | 51.91          | 203               | 358             | A          | V |
|                              |   |                   |                  |                   |                       |                   |                         |                   |                      |                |                   |                 | V          |   |
| 802.11a<br>CH 140<br>5700MHz |   | 11400             | 46.1             | -27.9             | 74                    | 42.3              | 39.2                    | 15.79             | 51.19                | 100            | 0                 | P               | H          |   |
|                              |   | 17100             | 60.03            | -13.97            | 74                    | 49.34             | 42.36                   | 20.3              | 51.97                | 200            | 179               | P               | H          |   |
|                              |   | 17100             | 49.57            | -4.43             | 54                    | 38.88             | 42.36                   | 20.3              | 51.97                | 200            | 179               | A               | H          |   |
|                              |   |                   |                  |                   |                       |                   |                         |                   |                      |                |                   |                 | H          |   |
|                              |   |                   | 11400            | 47.78             | -26.22                | 74                | 43.98                   | 39.2              | 15.79                | 51.19          | 100               | 0               | P          | V |
|                              |   |                   | 17100            | 57.37             | -16.63                | 74                | 46.68                   | 42.36             | 20.3                 | 51.97          | 184               | 349             | P          | V |
|                              |   |                   | 17100            | 46.28             | -7.72                 | 54                | 35.59                   | 42.36             | 20.3                 | 51.97          | 184               | 349             | A          | V |
|                              |   |                   |                  |                   |                       |                   |                         |                   |                      |                |                   |                 | V          |   |
| Remark                       | 1. No other spurious found.<br>2. All results are PASS against Peak and Average limit line. |                   |                  |                   |                       |                   |                         |                   |                      |                |                   |                 |            |   |



**Band 3 - 5470~5725MHz**  
**WIFI 802.11n HT20 (Band Edge @ 3m)**

| WIFI Ant. 1                 | Note | Frequency ( MHz ) | Level ( dBμV/m ) | Over Limit ( dB ) | Limit Line ( dBμV/m ) | Read Level ( dBμV ) | Antenna Factor ( dB/m ) | Cable Loss ( dB ) | Preamp Factor ( dB ) | Ant Pos ( cm ) | Table Pos ( deg ) | Peak Avg. (P/A) | Pol. (H/V) |   |
|-----------------------------|------|-------------------|------------------|-------------------|-----------------------|---------------------|-------------------------|-------------------|----------------------|----------------|-------------------|-----------------|------------|---|
| 802.11n HT20 CH 100 5500MHz |      | 5468.56           | 54.13            | -19.87            | 74                    | 43.12               | 32.65                   | 11.38             | 33.02                | 228            | 68                | P               | H          |   |
|                             |      | 5469.84           | 46.49            | -7.51             | 54                    | 35.48               | 32.65                   | 11.38             | 33.02                | 228            | 68                | A               | H          |   |
|                             | *    | 5500              | 104.89           | -                 | -                     | 93.83               | 32.7                    | 11.38             | 33.02                | 228            | 68                | P               | H          |   |
|                             | *    | 5500              | 97.78            | -                 | -                     | 86.72               | 32.7                    | 11.38             | 33.02                | 228            | 68                | A               | H          |   |
|                             |      |                   |                  |                   |                       |                     |                         |                   |                      |                |                   |                 | H          |   |
|                             |      |                   |                  |                   |                       |                     |                         |                   |                      |                |                   |                 |            | H |
|                             |      |                   | 5459.6           | 55.26             | -18.74                | 74                  | 44.31                   | 32.63             | 11.34                | 33.02          | 100               | 244             | P          | V |
|                             |      |                   | 5470             | 45.79             | -8.21                 | 54                  | 34.78                   | 32.65             | 11.38                | 33.02          | 100               | 244             | A          | V |
|                             |      | *                 | 5500             | 105.31            | -                     | -                   | 94.25                   | 32.7              | 11.38                | 33.02          | 100               | 244             | P          | V |
|                             |      | *                 | 5500             | 97.69             | -                     | -                   | 86.63                   | 32.7              | 11.38                | 33.02          | 100               | 244             | A          | V |
|                             |      |                   |                  |                   |                       |                     |                         |                   |                      |                |                   |                 | V          |   |
|                             |      |                   |                  |                   |                       |                     |                         |                   |                      |                |                   |                 | V          |   |
| 802.11n HT20 CH 116 5580MHz |      | 5439.52           | 51.31            | -22.69            | 74                    | 40.38               | 32.61                   | 11.34             | 33.02                | 219            | 70                | P               | H          |   |
|                             |      | 5467.84           | 42.47            | -11.53            | 54                    | 31.46               | 32.65                   | 11.38             | 33.02                | 219            | 70                | A               | H          |   |
|                             |      | * 5580            | 105.22           | -                 | -                     | 94.05               | 32.8                    | 11.44             | 33.07                | 219            | 70                | P               | H          |   |
|                             |      | * 5580            | 98.18            | -                 | -                     | 87.01               | 32.8                    | 11.44             | 33.07                | 219            | 70                | A               | H          |   |
|                             |      |                   | 5748.2           | 50.31             | -23.69                | 74                  | 38.96                   | 33.04             | 11.46                | 33.15          | 219               | 70              | P          | H |
|                             |      |                   | 5731.925         | 42.79             | -11.21                | 54                  | 31.47                   | 33.01             | 11.46                | 33.15          | 219               | 70              | A          | H |
|                             |      |                   | 5401.36          | 50.4              | -23.6                 | 74                  | 39.55                   | 32.56             | 11.31                | 33.02          | 100               | 251             | P          | V |
|                             |      |                   | 5468.56          | 42.61             | -11.39                | 54                  | 31.6                    | 32.65             | 11.38                | 33.02          | 100               | 251             | A          | V |
|                             |      | *                 | 5580             | 106.05            | -                     | -                   | 94.88                   | 32.8              | 11.44                | 33.07          | 100               | 251             | P          | V |
|                             |      | *                 | 5580             | 98.92             | -                     | -                   | 87.75                   | 32.8              | 11.44                | 33.07          | 100               | 251             | A          | V |
|                             |      | 5728.25           | 50.76            | -23.24            | 74                    | 39.42               | 33.01                   | 11.46             | 33.13                | 100            | 251               | P               | V          |   |
|                             |      | 5734.2            | 42.62            | -11.38            | 54                    | 31.3                | 33.01                   | 11.46             | 33.15                | 100            | 251               | A               | V          |   |



|  |   |         |        |        |    |       |       |       |       |     |     |   |   |
|--|---|---------|--------|--------|----|-------|-------|-------|-------|-----|-----|---|---|
| <b>802.11n<br/>HT20<br/>CH 140<br/>5700MHz</b> | *   | 5700    | 105.74 | -      | -  | 94.42 | 32.97 | 11.47 | 33.12 | 221 | 68  | P | H |
|  | *   | 5700    | 98.39  | -      | -  | 87.07 | 32.97 | 11.47 | 33.12 | 221 | 68  | A | H |
|  |   | 5725.32 | 57.53  | -16.47 | 74 | 46.19 | 33.01 | 11.46 | 33.13 | 221 | 68  | P | H |
|  |   | 5725    | 47.67  | -6.33  | 54 | 36.33 | 33.01 | 11.46 | 33.13 | 221 | 68  | A | H |
|  |   |         |        |        |    |       |       |       |       |     |     |   | H |
|  |   |         |        |        |    |       |       |       |       |     |     |   | H |
|  | *   | 5700    | 105.73 | -      | -  | 94.41 | 32.97 | 11.47 | 33.12 | 100 | 247 | P | V |
|  | *   | 5700    | 97.92  | -      | -  | 86.6  | 32.97 | 11.47 | 33.12 | 100 | 247 | A | V |
|  |   | 5725.72 | 57.53  | -16.47 | 74 | 46.19 | 33.01 | 11.46 | 33.13 | 100 | 247 | P | V |
|  |   | 5725.56 | 47.19  | -6.81  | 54 | 35.85 | 33.01 | 11.46 | 33.13 | 100 | 247 | A | V |
|  |   |         |        |        |    |       |       |       |       |     |     | V |   |
|  |   |         |        |        |    |       |       |       |       |     |     | V |   |
| <b>Remark</b>                                  | 1. No other spurious found.<br>2. All results are PASS against Peak and Average limit line. |         |        |        |    |       |       |       |       |     |     |   |   |



**Band 3 - 5470~5725MHz**  
**WIFI 802.11n HT20 (Harmonic @ 3m)**

| WIFI Ant. 1                    | Note  | Frequency ( MHz ) | Level ( dBμV/m ) | Over Limit ( dB ) | Limit Line ( dBμV/m ) | Read Level (dBμV) | Antenna Factor ( dB/m ) | Cable Loss ( dB ) | Preamp Factor ( dB ) | Ant Pos ( cm ) | Table Pos ( deg ) | Peak Avg. (P/A) | Pol. (H/V) |   |
|--------------------------------|---|-------------------|------------------|-------------------|-----------------------|-------------------|-------------------------|-------------------|----------------------|----------------|-------------------|-----------------|------------|---|
| 802.11n HT20 CH 100<br>5500MHz |   | 11000             | 45.17            | -28.83            | 74                    | 41.11             | 39.6                    | 15.49             | 51.03                | 100            | 0                 | P               | H          |   |
|                                |   | 16500             | 59.8             | -14.2             | 74                    | 53.2              | 39.2                    | 19.27             | 51.87                | 200            | 213               | P               | H          |   |
|                                |   | 16500             | 49.71            | -4.29             | 54                    | 43.11             | 39.2                    | 19.27             | 51.87                | 200            | 213               | A               | H          |   |
|                                |   |                   |                  |                   |                       |                   |                         |                   |                      |                |                   |                 | H          |   |
|                                |   |                   | 11000            | 44.48             | -29.52                | 74                | 40.42                   | 39.6              | 15.49                | 51.03          | 100               | 0               | P          | V |
|                                |   |                   | 16500            | 55.63             | -18.37                | 74                | 49.03                   | 39.2              | 19.27                | 51.87          | 200               | 317             | P          | V |
|                                |   |                   | 16500            | 45.17             | -8.83                 | 54                | 38.57                   | 39.2              | 19.27                | 51.87          | 200               | 317             | A          | V |
|                                |   |                   |                  |                   |                       |                   |                         |                   |                      |                |                   |                 | V          |   |
| 802.11n HT20 CH 116<br>5580MHz |   | 11160             | 46.23            | -27.77            | 74                    | 42.28             | 39.43                   | 15.61             | 51.09                | 100            | 0                 | P               | H          |   |
|                                |   | 16740             | 59.7             | -14.3             | 74                    | 51.38             | 40.55                   | 19.68             | 51.91                | 200            | 173               | P               | H          |   |
|                                |   | 16740             | 48.36            | -5.64             | 54                    | 40.04             | 40.55                   | 19.68             | 51.91                | 200            | 173               | A               | H          |   |
|                                |   |                   |                  |                   |                       |                   |                         |                   |                      |                |                   |                 | H          |   |
|                                |   |                   | 11160            | 47.5              | -26.5                 | 74                | 43.55                   | 39.43             | 15.61                | 51.09          | 100               | 0               | P          | V |
|                                |   |                   | 16740            | 59.7              | -14.3                 | 74                | 51.38                   | 40.55             | 19.68                | 51.91          | 200               | 319             | P          | V |
|                                |   |                   | 16740            | 48.72             | -5.28                 | 54                | 40.4                    | 40.55             | 19.68                | 51.91          | 200               | 319             | A          | V |
|                                |   |                   |                  |                   |                       |                   |                         |                   |                      |                |                   |                 | V          |   |
| 802.11n HT20 CH 140<br>5700MHz |   | 11400             | 46.37            | -27.63            | 74                    | 42.57             | 39.2                    | 15.79             | 51.19                | 100            | 0                 | P               | H          |   |
|                                |   | 17100             | 58.02            | -15.98            | 74                    | 47.33             | 42.36                   | 20.3              | 51.97                | 201            | 173               | P               | H          |   |
|                                |   | 17100             | 47.95            | -6.05             | 54                    | 37.26             | 42.36                   | 20.3              | 51.97                | 201            | 173               | A               | H          |   |
|                                |   |                   |                  |                   |                       |                   |                         |                   |                      |                |                   |                 | H          |   |
|                                |   |                   | 11400            | 49.37             | -24.63                | 74                | 45.57                   | 39.2              | 15.79                | 51.19          | 100               | 0               | P          | V |
|                                |   |                   | 17100            | 55.8              | -18.2                 | 74                | 45.11                   | 42.36             | 20.3                 | 51.97          | 197               | 314             | P          | V |
|                                |   |                   | 17100            | 45.26             | -8.74                 | 54                | 34.57                   | 42.36             | 20.3                 | 51.97          | 197               | 314             | A          | V |
|                                |   |                   |                  |                   |                       |                   |                         |                   |                      |                |                   |                 | V          |   |
| Remark                         | 1. No other spurious found.<br>2. All results are PASS against Peak and Average limit line. |                   |                  |                   |                       |                   |                         |                   |                      |                |                   |                 |            |   |



**Band 3 - 5470~5725MHz**  
**WIFI 802.11n HT40 (Band Edge @ 3m)**

| WIFI Ant. 1                 | Note     | Frequency ( MHz ) | Level ( dBμV/m ) | Over Limit ( dB ) | Limit Line ( dBμV/m ) | Read Level ( dBμV ) | Antenna Factor ( dB/m ) | Cable Loss ( dB ) | Preamp Factor ( dB ) | Ant Pos ( cm ) | Table Pos ( deg ) | Peak Avg. ( P/A ) | Pol. ( H/V ) |
|-----------------------------|----------|-------------------|------------------|-------------------|-----------------------|---------------------|-------------------------|-------------------|----------------------|----------------|-------------------|-------------------|--------------|
| 802.11n HT40 CH 102 5510MHz |          | 5469.04           | 58.7             | -15.3             | 74                    | 47.69               | 32.65                   | 11.38             | 33.02                | 227            | 66                | P                 | H            |
|                             |          | 5469.52           | 50.35            | -3.65             | 54                    | 39.34               | 32.65                   | 11.38             | 33.02                | 227            | 66                | A                 | H            |
|                             | *        | 5510              | 96.13            | -                 | -                     | 85.05               | 32.7                    | 11.41             | 33.03                | 227            | 66                | P                 | H            |
|                             | *        | 5510              | 88.11            | -                 | -                     | 77.03               | 32.7                    | 11.41             | 33.03                | 227            | 66                | A                 | H            |
|                             |          | 5734.025          | 51.74            | -22.26            | 74                    | 40.42               | 33.01                   | 11.46             | 33.15                | 227            | 66                | P                 | H            |
|                             |          | 5739.625          | 42.87            | -11.13            | 54                    | 31.52               | 33.04                   | 11.46             | 33.15                | 227            | 66                | A                 | H            |
|                             |          | 5468.56           | 56.39            | -17.61            | 74                    | 45.38               | 32.65                   | 11.38             | 33.02                | 100            | 299               | P                 | V            |
|                             |          | 5470              | 49.53            | -4.47             | 54                    | 38.52               | 32.65                   | 11.38             | 33.02                | 100            | 299               | A                 | V            |
|                             | *        | 5510              | 95.08            | -                 | -                     | 84                  | 32.7                    | 11.41             | 33.03                | 100            | 299               | P                 | V            |
|                             | *        | 5510              | 87.32            | -                 | -                     | 76.24               | 32.7                    | 11.41             | 33.03                | 100            | 299               | A                 | V            |
|                             |          | 5755.55           | 50.8             | -23.2             | 74                    | 39.43               | 33.06                   | 11.46             | 33.15                | 100            | 299               | P                 | V            |
|                             |          | 5734.2            | 42.82            | -11.18            | 54                    | 31.5                | 33.01                   | 11.46             | 33.15                | 100            | 299               | A                 | V            |
| 802.11n HT40 CH 110 5550MHz |          | 5378.56           | 50.5             | -23.5             | 74                    | 39.7                | 32.54                   | 11.28             | 33.02                | 221            | 66                | P                 | H            |
|                             |          | 5464.72           | 42.89            | -11.11            | 54                    | 31.88               | 32.65                   | 11.38             | 33.02                | 221            | 66                | A                 | H            |
|                             | *        | 5550              | 96.74            | -                 | -                     | 85.58               | 32.77                   | 11.44             | 33.05                | 221            | 66                | P                 | H            |
|                             | *        | 5550              | 88.45            | -                 | -                     | 77.29               | 32.77                   | 11.44             | 33.05                | 221            | 66                | A                 | H            |
|                             |          | 5760.275          | 51.11            | -22.89            | 74                    | 39.75               | 33.06                   | 11.46             | 33.16                | 221            | 66                | P                 | H            |
|                             |          | 5747.675          | 42.94            | -11.06            | 54                    | 31.59               | 33.04                   | 11.46             | 33.15                | 221            | 66                | A                 | H            |
|                             |          | 5447.44           | 51.17            | -22.83            | 74                    | 40.22               | 32.63                   | 11.34             | 33.02                | 100            | 235               | P                 | V            |
|                             |          | 5467.36           | 43.3             | -10.7             | 54                    | 32.29               | 32.65                   | 11.38             | 33.02                | 100            | 235               | A                 | V            |
|                             | *        | 5550              | 95.89            | -                 | -                     | 84.73               | 32.77                   | 11.44             | 33.05                | 100            | 235               | P                 | V            |
|                             | *        | 5550              | 87.51            | -                 | -                     | 76.35               | 32.77                   | 11.44             | 33.05                | 100            | 235               | A                 | V            |
|                             | 5729.65  | 49.99             | -24.01           | 74                | 38.65                 | 33.01               | 11.46                   | 33.13             | 100                  | 235            | P                 | V                 |              |
|                             | 5753.625 | 42.9              | -11.1            | 54                | 31.53                 | 33.06               | 11.46                   | 33.15             | 100                  | 235            | A                 | V                 |              |





|  |   |          |       |        |    |       |       |       |       |     |     |   |   |
|--|---|----------|-------|--------|----|-------|-------|-------|-------|-----|-----|---|---|
| <b>802.11n</b><br><b>HT40</b><br><b>CH 134</b><br><b>5670MHz</b> |   | 5462.56  | 49.95 | -24.05 | 74 | 38.94 | 32.65 | 11.38 | 33.02 | 226 | 68  | P | H |
|  |   | 5468.32  | 42.37 | -11.63 | 54 | 31.36 | 32.65 | 11.38 | 33.02 | 226 | 68  | A | H |
|  | *   | 5670     | 96.21 | -      | -  | 84.91 | 32.94 | 11.47 | 33.11 | 226 | 68  | P | H |
|  | *   | 5670     | 88.42 | -      | -  | 77.12 | 32.94 | 11.47 | 33.11 | 226 | 68  | A | H |
|  |   | 5742.6   | 51.04 | -22.96 | 74 | 39.69 | 33.04 | 11.46 | 33.15 | 226 | 68  | P | H |
|  |   | 5738.925 | 43.41 | -10.59 | 54 | 32.06 | 33.04 | 11.46 | 33.15 | 226 | 68  | A | H |
|  |   | 5469.52  | 50.57 | -23.43 | 74 | 39.56 | 32.65 | 11.38 | 33.02 | 100 | 235 | P | V |
|  |   | 5464.48  | 42.32 | -11.68 | 54 | 31.31 | 32.65 | 11.38 | 33.02 | 100 | 235 | A | V |
|  | *   | 5670     | 96.07 | -      | -  | 84.77 | 32.94 | 11.47 | 33.11 | 100 | 235 | P | V |
|  | *   | 5670     | 88.07 | -      | -  | 76.77 | 32.94 | 11.47 | 33.11 | 100 | 235 | A | V |
|  |   | 5732.8   | 50.66 | -23.34 | 74 | 39.34 | 33.01 | 11.46 | 33.15 | 100 | 235 | P | V |
|  |   | 5734.375 | 43.28 | -10.72 | 54 | 31.96 | 33.01 | 11.46 | 33.15 | 100 | 235 | A | V |
| <b>Remark</b>  | 1. No other spurious found.<br>2. All results are PASS against Peak and Average limit line. |          |       |        |    |       |       |       |       |     |     |   |   |



Band 3 - 5470~5725MHz

WIFI 802.11n HT40 (Harmonic @ 3m)

| WIFI Ant. 1                    | Note   | Frequency ( MHz ) | Level ( dBμV/m ) | Over Limit ( dB ) | Limit Line ( dBμV/m ) | Read Level ( dBμV ) | Antenna Factor ( dB/m ) | Cable Loss ( dB ) | Preamp Factor ( dB ) | Ant Pos ( cm ) | Table Pos ( deg ) | Peak Avg. ( P/A ) | Pol. ( H/V ) |   |
|--------------------------------|--|-------------------|------------------|-------------------|-----------------------|---------------------|-------------------------|-------------------|----------------------|----------------|-------------------|-------------------|--------------|---|
| 802.11n HT40 CH 102<br>5510MHz |  | 11020             | 39.7             | -34.3             | 74                    | 35.66               | 39.58                   | 15.49             | 51.03                | 100            | 0                 | P                 | H            |   |
|                                |  | 16530             | 41.43            | -32.57            | 74                    | 34.57               | 39.39                   | 19.34             | 51.87                | 100            | 0                 | P                 | H            |   |
|                                |  |                   |                  |                   |                       |                     |                         |                   |                      |                |                   |                   | H            |   |
|                                |  |                   |                  |                   |                       |                     |                         |                   |                      |                |                   |                   | H            |   |
|                                |  |                   | 11020            | 39.57             | -34.43                | 74                  | 35.53                   | 39.58             | 15.49                | 51.03          | 100               | 0                 | P            | V |
|                                |  |                   | 16530            | 40.66             | -33.34                | 74                  | 33.8                    | 39.39             | 19.34                | 51.87          | 100               | 0                 | P            | V |
|                                |  |                   |                  |                   |                       |                     |                         |                   |                      |                |                   |                   |              | V |
| 802.11n HT40 CH 110<br>5550MHz |  | 11100             | 39.57            | -34.43            | 74                    | 35.58               | 39.5                    | 15.55             | 51.06                | 100            | 0                 | P                 | H            |   |
|                                |  | 16650             | 43.02            | -30.98            | 74                    | 35.31               | 40.07                   | 19.54             | 51.9                 | 100            | 0                 | P                 | H            |   |
|                                |  |                   |                  |                   |                       |                     |                         |                   |                      |                |                   |                   | H            |   |
|                                |  |                   |                  |                   |                       |                     |                         |                   |                      |                |                   |                   | H            |   |
|                                |  |                   | 11100            | 40.12             | -33.88                | 74                  | 36.13                   | 39.5              | 15.55                | 51.06          | 100               | 0                 | P            | V |
|                                |  |                   | 16650            | 46.22             | -27.78                | 74                  | 38.51                   | 40.07             | 19.54                | 51.9           | 100               | 0                 | P            | V |
|                                |  |                   |                  |                   |                       |                     |                         |                   |                      |                |                   |                   |              | V |
| 802.11n HT40 CH 134<br>5670MHz |  | 11340             | 41.41            | -32.59            | 74                    | 37.59               | 39.27                   | 15.73             | 51.18                | 100            | 0                 | P                 | H            |   |
|                                |  | 17010             | 45.19            | -28.81            | 74                    | 34.93               | 42.06                   | 20.16             | 51.96                | 100            | 0                 | P                 | H            |   |
|                                |  |                   |                  |                   |                       |                     |                         |                   |                      |                |                   |                   | H            |   |
|                                |  |                   |                  |                   |                       |                     |                         |                   |                      |                |                   |                   | H            |   |
|                                |  |                   | 11340            | 40.07             | -33.93                | 74                  | 36.25                   | 39.27             | 15.73                | 51.18          | 100               | 0                 | P            | V |
|                                |  |                   | 17010            | 45.28             | -28.72                | 74                  | 35.02                   | 42.06             | 20.16                | 51.96          | 100               | 0                 | P            | V |
|                                |  |                   |                  |                   |                       |                     |                         |                   |                      |                |                   |                   |              | V |
| Remark                         | 1. No other spurious found.                                  |                   |                  |                   |                       |                     |                         |                   |                      |                |                   |                   |              |   |
|                                | 2. All results are PASS against Peak and Average limit line. |                   |                  |                   |                       |                     |                         |                   |                      |                |                   |                   |              |   |



Emission below 1GHz

WIFI 802.11a (LF @ 3m)

| WIFI Ant.  | Note   | Frequency ( MHz ) | Level ( dBμV/m ) | Over Limit ( dB ) | Limit Line ( dBμV/m ) | Read Level ( dBμV ) | Antenna Factor ( dB/m ) | Cable Loss ( dB ) | Preamp Factor ( dB ) | Ant Pos ( cm ) | Table Pos ( deg ) | Peak Avg. ( P/A ) | Pol. ( H/V ) |   |
|------------|--|-------------------|------------------|-------------------|-----------------------|---------------------|-------------------------|-------------------|----------------------|----------------|-------------------|-------------------|--------------|---|
| 802.11a LF |  | 30                | 23.19            | -16.81            | 40                    | 28.7                | 25.7                    | 1.29              | 32.5                 | -              | -                 | P                 | H            |   |
|            |  | 169.05            | 24.49            | -19.01            | 43.5                  | 39.25               | 16                      | 2                 | 32.76                | -              | -                 | P                 | H            |   |
|            |  | 231.42            | 25.67            | -20.33            | 46                    | 39                  | 17.06                   | 2.34              | 32.73                | -              | -                 | P                 | H            |   |
|            |  | 467.3             | 23.73            | -22.27            | 46                    | 29.23               | 23.58                   | 3.28              | 32.36                | -              | -                 | P                 | H            |   |
|            |  | 748.7             | 29.05            | -16.95            | 46                    | 29.61               | 27.68                   | 4.09              | 32.33                | -              | -                 | P                 | H            |   |
|            |  | 951               | 33.34            | -12.66            | 46                    | 29.24               | 30.6                    | 4.69              | 31.19                | 100            | 0                 | P                 | H            |   |
|            |  |                   |                  |                   |                       |                     |                         |                   |                      |                |                   |                   |              | H |
|            |  |                   |                  |                   |                       |                     |                         |                   |                      |                |                   |                   |              | H |
|            |  |                   |                  |                   |                       |                     |                         |                   |                      |                |                   |                   |              | H |
|            |  |                   |                  |                   |                       |                     |                         |                   |                      |                |                   |                   |              | H |
|            |  |                   |                  |                   |                       |                     |                         |                   |                      |                |                   |                   |              | H |
|            |  |                   |                  |                   |                       |                     |                         |                   |                      |                |                   |                   |              | H |
|            |  |                   | 31.62            | 33.56             | -6.44                 | 40                  | 40.1                    | 24.66             | 1.29                 | 32.49          | 200               | 234               | P            | V |
|            |  |                   | 36.75            | 30.54             | -9.46                 | 40                  | 39.76                   | 21.98             | 1.29                 | 32.49          | -                 | -                 | P            | V |
|            |  |                   | 62.67            | 22.82             | -17.18                | 40                  | 41.75                   | 12.05             | 1.51                 | 32.49          | -                 | -                 | P            | V |
|            |  |                   | 527.5            | 24.93             | -21.07                | 46                  | 29.47                   | 24.48             | 3.38                 | 32.4           | -                 | -                 | P            | V |
|            |  |                   | 763.4            | 29.24             | -16.76                | 46                  | 29.58                   | 27.86             | 4.09                 | 32.29          | -                 | -                 | P            | V |
|            |  |                   | 950.3            | 32.8              | -13.2                 | 46                  | 28.71                   | 30.6              | 4.69                 | 31.2           | -                 | -                 | P            | V |
|            |  |                   |                  |                   |                       |                     |                         |                   |                      |                |                   |                   |              | V |
|            |  |                   |                  |                   |                       |                     |                         |                   |                      |                |                   |                   |              | V |
|            |  |                   |                  |                   |                       |                     |                         |                   |                      |                |                   |                   | V            |   |
|            |  |                   |                  |                   |                       |                     |                         |                   |                      |                |                   |                   | V            |   |
|            |  |                   |                  |                   |                       |                     |                         |                   |                      |                |                   |                   | V            |   |
|            |  |                   |                  |                   |                       |                     |                         |                   |                      |                |                   |                   | V            |   |
| Remark     | 1. No other spurious found.<br>2. All results are PASS against limit line. |                   |                  |                   |                       |                     |                         |                   |                      |                |                   |                   |              |   |



Emission below 1GHz

WIFI 802.11n HT20 (LF @ 3m)

| WIFI                  | Note   | Frequency | Level      | Over   | Limit      | Read     | Antenna  | Cable  | Preamp | Ant    | Table   | Peak    | Pol.    |   |
|-----------------------|--|-----------|------------|--------|------------|----------|----------|--------|--------|--------|---------|---------|---------|---|
| Ant.                  |  | ( MHz )   | ( dBμV/m ) | ( dB ) | ( dBμV/m ) | ( dBμV ) | ( dB/m ) | ( dB ) | ( dB ) | ( cm ) | ( deg ) | ( P/A ) | ( H/V ) |   |
| 1                     |  |           |            |        |            |          |          |        |        |        |         |         |         |   |
| 802.11n<br>HT20<br>LF |  | 30.27     | 25.18      | -14.82 | 40         | 30.69    | 25.7     | 1.29   | 32.5   | -      | -       | P       | H       |   |
|                       |  | 169.05    | 26.38      | -17.12 | 43.5       | 41.14    | 16       | 2      | 32.76  | -      | -       | P       | H       |   |
|                       |  | 291.09    | 28.27      | -17.73 | 46         | 38.59    | 19.52    | 2.58   | 32.42  | -      | -       | P       | H       |   |
|                       |  | 519.1     | 25.47      | -20.53 | 46         | 30.13    | 24.36    | 3.38   | 32.4   | -      | -       | P       | H       |   |
|                       |  | 837.6     | 30.88      | -15.12 | 46         | 29.71    | 28.76    | 4.39   | 31.98  | -      | -       | P       | H       |   |
|                       |  | 952.4     | 33.51      | -12.49 | 46         | 29.41    | 30.59    | 4.69   | 31.18  | 100    | 0       | P       | H       |   |
|                       |  |           |            |        |            |          |          |        |        |        |         |         | H       |   |
|                       |  |           |            |        |            |          |          |        |        |        |         |         | H       |   |
|                       |  |           |            |        |            |          |          |        |        |        |         |         | H       |   |
|                       |  |           |            |        |            |          |          |        |        |        |         |         | H       |   |
|                       |  |           |            |        |            |          |          |        |        |        |         |         | H       |   |
|                       |  |           |            |        |            |          |          |        |        |        |         |         | H       |   |
|                       |  |           | 31.62      | 33.56  | -6.44      | 40       | 40.1     | 24.66  | 1.29   | 32.49  | 200     | 263     | P       | V |
|                       |  |           | 36.75      | 29.7   | -10.3      | 40       | 38.92    | 21.98  | 1.29   | 32.49  | -       | -       | P       | V |
|                       |  |           | 63.48      | 24.25  | -15.75     | 40       | 43.13    | 12.1   | 1.51   | 32.49  | -       | -       | P       | V |
|                       |  |           | 446.3      | 24.41  | -21.59     | 46       | 30.42    | 23.23  | 3.11   | 32.35  | -       | -       | P       | V |
|                       |  |           | 783.7      | 29.61  | -16.39     | 46       | 29.48    | 28.1   | 4.26   | 32.23  | -       | -       | P       | V |
|                       |  |           | 941.9      | 33.36  | -12.64     | 46       | 29.56    | 30.38  | 4.69   | 31.27  | -       | -       | P       | V |
|                       |  |           |            |        |            |          |          |        |        |        |         | V       |         |   |
|                       |  |           |            |        |            |          |          |        |        |        |         | V       |         |   |
|                       |  |           |            |        |            |          |          |        |        |        |         | V       |         |   |
|                       |  |           |            |        |            |          |          |        |        |        |         | V       |         |   |
|                       |  |           |            |        |            |          |          |        |        |        |         | V       |         |   |
|                       |  |           |            |        |            |          |          |        |        |        |         | V       |         |   |
|                       |  |           |            |        |            |          |          |        |        |        |         | V       |         |   |
| Remark                | 1. No other spurious found.<br>2. All results are PASS against limit line. |           |            |        |            |          |          |        |        |        |         |         |         |   |



Emission below 1GHz

WIFI 802.11n HT40 (LF @ 3m)

| WIFI                  | Note   | Frequency | Level      | Over   | Limit      | Read     | Antenna  | Cable  | Preamp | Ant    | Table   | Peak    | Pol.    |   |
|-----------------------|--|-----------|------------|--------|------------|----------|----------|--------|--------|--------|---------|---------|---------|---|
| Ant.                  |  |           |            | Limit  | Line       | Level    | Factor   | Loss   | Factor | Pos    | Pos     | Avg.    |         |   |
| 1                     |  | ( MHz )   | ( dBμV/m ) | ( dB ) | ( dBμV/m ) | ( dBμV ) | ( dB/m ) | ( dB ) | ( dB ) | ( cm ) | ( deg ) | ( P/A ) | ( H/V ) |   |
| 802.11n<br>HT40<br>LF |  | 30.27     | 28.71      | -11.29 | 40         | 34.22    | 25.7     | 1.29   | 32.5   | 100    | 0       | P       | H       |   |
|                       |  | 170.13    | 29.52      | -13.98 | 43.5       | 44.39    | 15.9     | 2      | 32.77  | -      | -       | P       | H       |   |
|                       |  | 230.07    | 30.56      | -15.44 | 46         | 44.05    | 16.9     | 2.34   | 32.73  | -      | -       | P       | H       |   |
|                       |  | 512.1     | 24.23      | -21.77 | 46         | 28.98    | 24.26    | 3.38   | 32.39  | -      | -       | P       | H       |   |
|                       |  | 763.4     | 30.43      | -15.57 | 46         | 30.77    | 27.86    | 4.09   | 32.29  | -      | -       | P       | H       |   |
|                       |  | 930.7     | 32.81      | -13.19 | 46         | 29.47    | 30.08    | 4.63   | 31.37  | -      | -       | P       | H       |   |
|                       |  |           |            |        |            |          |          |        |        |        |         |         |         | H |
|                       |  |           |            |        |            |          |          |        |        |        |         |         |         | H |
|                       |  |           |            |        |            |          |          |        |        |        |         |         |         | H |
|                       |  |           |            |        |            |          |          |        |        |        |         |         |         | H |
|                       |  |           |            |        |            |          |          |        |        |        |         |         |         | H |
|                       |  |           |            |        |            |          |          |        |        |        |         |         |         | H |
|                       |  |           |            |        |            |          |          |        |        |        |         |         |         | H |
|                       |  |           | 30.27      | 33.16  | -6.84      | 40       | 38.67    | 25.7   | 1.29   | 32.5   | 200     | 175     | P       | V |
|                       |  |           | 37.02      | 31.17  | -8.83      | 40       | 40.39    | 21.98  | 1.29   | 32.49  | -       | -       | P       | V |
|                       |  |           | 63.21      | 25.46  | -14.54     | 40       | 44.39    | 12.05  | 1.51   | 32.49  | -       | -       | P       | V |
|                       |  |           | 546.4      | 25.26  | -20.74     | 46       | 29.46    | 24.75  | 3.47   | 32.42  | -       | -       | P       | V |
|                       |  |           | 788.6      | 29.93  | -16.07     | 46       | 29.72    | 28.16  | 4.26   | 32.21  | -       | -       | P       | V |
|                       |  |           | 911.8      | 33.87  | -12.13     | 46       | 31.26    | 29.53  | 4.63   | 31.55  | -       | -       | P       | V |
|                       |  |           |            |        |            |          |          |        |        |        |         |         |         | V |
|                       |  |           |            |        |            |          |          |        |        |        |         |         | V       |   |
|                       |  |           |            |        |            |          |          |        |        |        |         |         | V       |   |
|                       |  |           |            |        |            |          |          |        |        |        |         |         | V       |   |
|                       |  |           |            |        |            |          |          |        |        |        |         |         | V       |   |
|                       |  |           |            |        |            |          |          |        |        |        |         |         | V       |   |
| Remark                | 1. No other spurious found.<br>2. All results are PASS against limit line. |           |            |        |            |          |          |        |        |        |         |         |         |   |



**Note symbol**

|     |  |
|-----|--|
| *   | <b>Fundamental Frequency</b> which can be ignored. However, the level of any unwanted emissions shall not exceed the level of the fundamental frequency. |
| !   | Test result is <b>over limit</b> line.   |
| P/A | <b>Peak</b> or <b>Average</b>  |
| H/V | <b>Horizontal</b> or <b>Vertical</b>   |



A calculation example for radiated spurious emission is shown as below:

| WIFI    | Note | Frequency | Level      | Over   | Limit      | Read     | Antenna  | Cable  | Preamp | Ant    | Table   | Peak  | Pol.  |
|---------|------|-----------|------------|--------|------------|----------|----------|--------|--------|--------|---------|-------|-------|
| Ant.    |      |           |            | Limit  | Line       | Level    | Factor   | Loss   | Factor | Pos    | Pos     | Avg.  |       |
| 1       |      | ( MHz )   | ( dBμV/m ) | ( dB ) | ( dBμV/m ) | ( dBμV ) | ( dB/m ) | ( dB ) | ( dB ) | ( cm ) | ( deg ) | (P/A) | (H/V) |
| 802.11b |      | 2390      | 55.45      | -18.55 | 74         | 54.51    | 32.22    | 4.58   | 35.86  | 103    | 308     | P     | H     |
| CH 01   |      |           |            |        |            |          |          |        |        |        |         |       |       |
| 2412MHz |      | 2390      | 43.54      | -10.46 | 54         | 42.6     | 32.22    | 4.58   | 35.86  | 103    | 308     | A     | H     |

- Level(dBμV/m) =  
Antenna Factor(dB/m) + Cable Loss(dB) + Read Level(dBμV) - Preamp Factor(dB)
- Over Limit(dB) = Level(dBμV/m) – Limit Line(dBμV/m)

**For Peak Limit @ 2390MHz:**

- Level(dBμV/m)  
= Antenna Factor(dB/m) + Cable Loss(dB) + Read Level(dBμV) - Preamp Factor(dB)  
= 32.22(dB/m) + 4.58(dB) + 54.51(dBμV) – 35.86 (dB)  
= 55.45 (dBμV/m)
- Over Limit(dB)  
= Level(dBμV/m) – Limit Line(dBμV/m)  
= 55.45(dBμV/m) – 74(dBμV/m)  
= -18.55(dB)

**For Average Limit @ 2390MHz:**

- Level(dBμV/m)  
= Antenna Factor(dB/m) + Cable Loss(dB) + Read Level(dBμV) - Preamp Factor(dB)  
= 32.22(dB/m) + 4.58(dB) + 42.6(dBμV) – 35.86 (dB)  
= 43.54 (dBμV/m)
- Over Limit(dB)  
= Level(dBμV/m) – Limit Line(dBμV/m)  
= 43.54(dBμV/m) – 54(dBμV/m)  
= -10.46(dB)

Both peak and average measured complies with the limit line, so test result is “PASS”.



## Appendix C. Radiated Spurious Emission

|                 |                                 |                     |         |
|-----------------|---------------------------------|---------------------|---------|
| Test Engineer : | J.C. Liang, Nick Yu, and Ken Wu | Temperature :       | 20~23°C |
|                 |                                 | Relative Humidity : | 58~63%  |

### Note symbol

|    |                       |
|----|-----------------------|
| -L | Low channel location  |
| -R | High channel location |





**Band 1 - 5150~5250MHz**  
**WIFI 802.11a (Band Edge @ 3m)**

| WIFI        | Band 1 5150~5250MHz Band Edge @ 3m  |  |
|-------------|---|--|
| ANT         | 802.11a CH36 5180MHz  |  |
| 1           | Horizontal  | Fundamental  |
| <b>Peak</b> | <p>Site : 03CH11-HY<br/>           Condition : PEAK_BE_74 3m HORN 91200-HF HORIZONTAL</p> | <p>Site : 03CH11-HY<br/>           Condition : PEAK_74 3m HORN 91200-HF HORIZONTAL</p> |
| <b>Avg.</b> | <p>Site : 03CH11-HY<br/>           Condition : AVG_BE_54 3m HORN 91200-HF HORIZONTAL</p>  | Left blank   |

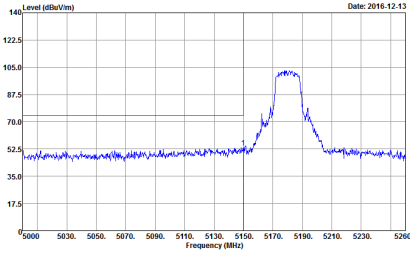
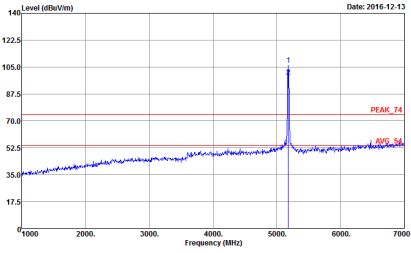
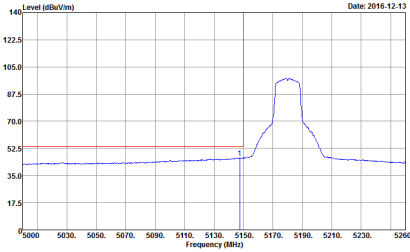

| WIFI | Band 1 5150~5250MHz Band Edge @ 3m  |  |
|------|---|--|
| ANT  | 802.11a CH36 5180MHz  |  |
| 1    | Vertical  | Vertical   |
| Peak |  <p>Site : 03CH11-HY<br/>Condition : PEAK_BE_74 3m HORN 91200-HF VERTICAL</p>  |  <p>Site : 03CH11-HY<br/>Condition : PEAK_74 3m HORN 91200-HF VERTICAL</p> |
| Avg. |  <p>Site : 03CH11-HY<br/>Condition : AVG_BE_54 3m HORN 91200-HF VERTICAL</p> | Left blank   |

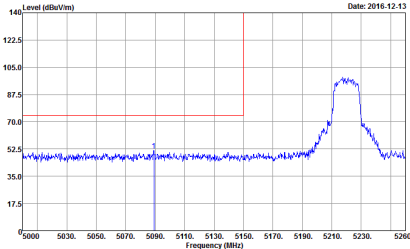
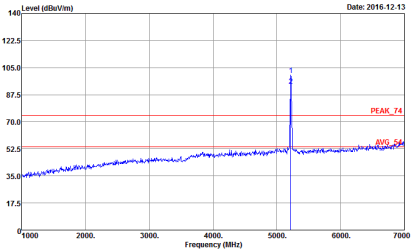
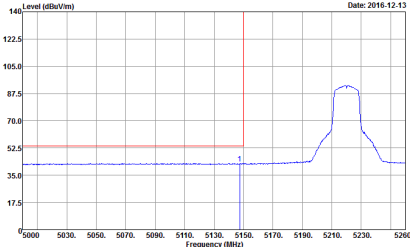

| WIFI | Band 1 5150~5250MHz Band Edge @ 3m  |  |
|------|---|--|
| ANT  | 802.11a CH44 5220MHz - L  |  |
| 1    | Horizontal  | Fundamental  |
| Peak |  <p>Site : 03CH11-HY<br/>Condition : PEAK_BE_74 3m HORN 91200-HF HORIZONTAL</p>  |  <p>Site : 03CH11-HY<br/>Condition : PEAK_74 3m HORN 91200-HF HORIZONTAL</p> |
| Avg. |  <p>Site : 03CH11-HY<br/>Condition : AVG_BE_54 3m HORN 91200-HF HORIZONTAL</p> | Left blank   |



| WIFI | Band 1 5150~5250MHz Band Edge @ 3m   |             |
|------|--|-------------|
| ANT  | 802.11a CH44 5220MHz - R   |             |
| 1    | Horizontal   | Fundamental |
| Peak | <p>Site : 03CHI1-HY<br/>Condition : PEAK_BE_74 3m HORN 9120D-HF HORIZONTAL</p> | Left blank  |
| Avg. | <p>Site : 03CHI1-HY<br/>Condition : AVG_BE_54 3m HORN 9120D-HF HORIZONTAL</p>  | Left blank  |



| WIFI | Band 1 5150~5250MHz Band Edge @ 3m   |   |
|------|--|---|
| ANT  | 802.11a CH44 5220MHz - L   |   |
| 1    | Vertical   | Fundamental   |
| Peak | <p>Site : 03CH11-HY<br/>Condition : PEAK_BE_74 3m HORN 91200-HF VERTICAL</p> | <p>Site : 03CH11-HY<br/>Condition : PEAK_74 3m HORN 91200-HF VERTICAL</p> |
| Avg. | <p>Site : 03CH11-HY<br/>Condition : AVG_BE_54 3m HORN 91200-HF VERTICAL</p>  | Left blank  |



| WIFI | Band 1 5150~5250MHz Band Edge @ 3m   |             |
|------|--|-------------|
| ANT  | 802.11a CH44 5220MHz - R   |             |
| 1    | Vertical   | Fundamental |
| Peak | <p>Site : 03CH11-HY<br/>Condition : PEAK_BE_74 3m HORN 9120D-HF VERTICAL</p> | Left blank  |
| Avg. | <p>Site : 03CH11-HY<br/>Condition : AVG_BE_54 3m HORN 9120D-HF VERTICAL</p>  | Left blank  |

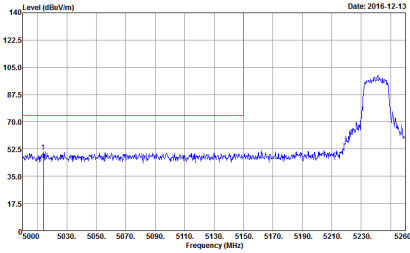
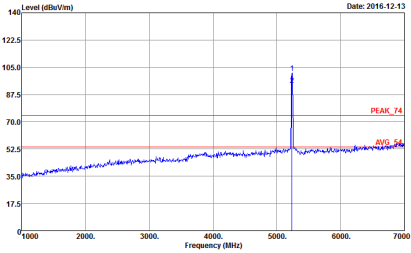
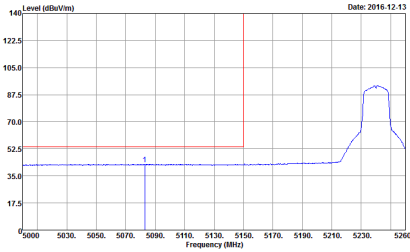

| WIFI | Band 1 5150~5250MHz Band Edge @ 3m  |  |
|------|---|--|
| ANT  | 802.11a CH48 5240MHz - L  |  |
| 1    | Horizontal  | Fundamental  |
| Peak |  <p>Site : 03CH11-HY<br/>Condition : PEAK_BE_74 3m HORN 9120D-HF HORIZONTAL</p>  |  <p>Site : 03CH11-HY<br/>Condition : PEAK_74 3m HORN 9120D-HF HORIZONTAL</p> |
| Avg. |  <p>Site : 03CH11-HY<br/>Condition : AVG_BE_54 3m HORN 9120D-HF HORIZONTAL</p> | Left blank   |

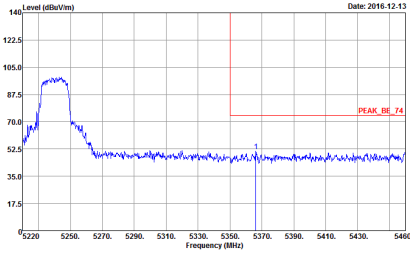
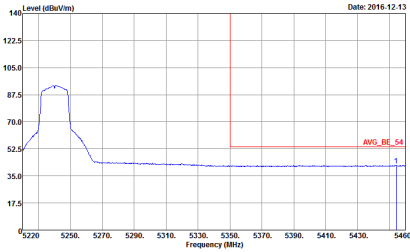

| WIFI | Band 1 5150~5250MHz Band Edge @ 3m  |             |
|------|---|-------------|
| ANT  | 802.11a CH48 5240MHz - R  |             |
| 1    | Horizontal  | Fundamental |
| Peak |  <p>Date: 2016-12-13</p> <p>Site : 03CH11-HY<br/>Condition : PEAK_BE_74 3m HORN 9120D-HF HORIZONTAL</p>  | Left blank  |
| Avg. |  <p>Date: 2016-12-13</p> <p>Site : 03CH11-HY<br/>Condition : AVG_BE_54 3m HORN 9120D-HF HORIZONTAL</p> | Left blank  |





| WIFI | Band 1 5150~5250MHz Band Edge @ 3m   |   |
|------|--|---|
| ANT  | 802.11a CH48 5240MHz - L   |   |
| 1    | Vertical   | Fundamental   |
| Peak | <p>Site : 03CH11-HY<br/>Condition : PEAK_BE_74 3m HORN 91200-HF VERTICAL</p> | <p>Site : 03CH11-HY<br/>Condition : PEAK_74 3m HORN 91200-HF VERTICAL</p> |
| Avg. | <p>Site : 03CH11-HY<br/>Condition : AVG_BE_54 3m HORN 91200-HF VERTICAL</p>  | Left blank  |



| WIFI | Band 1 5150~5250MHz Band Edge @ 3m |             |
|------|------------------------------------|-------------|
| ANT  | 802.11a CH48 5240MHz - R           |             |
| 1    | Vertical                           | Fundamental |
| Peak |                                    | Left blank  |
| Avg. |                                    | Left blank  |



Band 1 5150~5250MHz  
WIFI 802.11n HT20 (Band Edge @ 3m)

| WIFI | Band 1 5150~5250MHz Band Edge @ 3m   |   |
|------|--|---|
| ANT  | 802.11n HT20 CH36 5180MHz  |   |
| 1    | Horizontal   | Fundamental   |
| Peak | <p>Site : 03CH11-HY<br/>Condition : PEAK_BE_74 3m HORN 9120D-HF HORIZONTAL</p> | <p>Site : 03CH11-HY<br/>Condition : PEAK_74 3m HORN 9120D-HF HORIZONTAL</p> |
| Avg. | <p>Site : 03CH11-HY<br/>Condition : AVG_BE_54 3m HORN 9120D-HF HORIZONTAL</p>  | Left blank  |

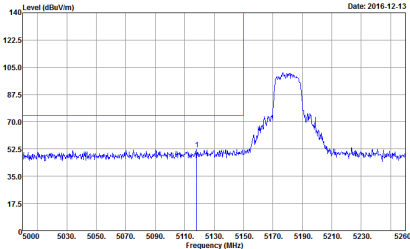
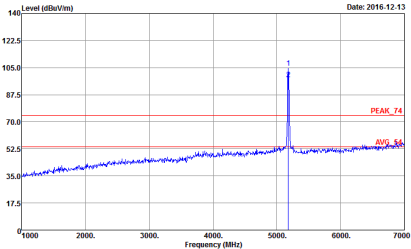
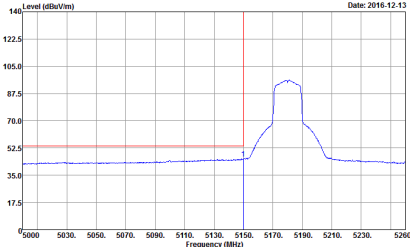

| WIFI | Band 1 5150~5250MHz Band Edge @ 3m  |  |
|------|---|--|
| ANT  | 802.11n HT20 CH36 5180MHz   |  |
| 1    | Vertical  | Fundamental  |
| Peak |  <p>Site : 03CH11-HY<br/>Condition : PEAK_BE_74 3m HORN 91200-HF VERTICAL</p>  |  <p>Site : 03CH11-HY<br/>Condition : PEAK_74 3m HORN 91200-HF VERTICAL</p> |
| Avg. |  <p>Site : 03CH11-HY<br/>Condition : AVG_BE_54 3m HORN 91200-HF VERTICAL</p> | Left blank   |



| WIFI | Band 1 5150~5250MHz Band Edge @ 3m   |   |
|------|--|---|
| ANT  | 802.11n HT20 CH44 5220MHz - L  |   |
| 1    | Horizontal   | Fundamental   |
| Peak | <p>Site : 03CH11-HY<br/>Condition : PEAK_BE_74 3m HORN 91200-HF HORIZONTAL</p> | <p>Site : 03CH11-HY<br/>Condition : PEAK_74 3m HORN 91200-HF HORIZONTAL</p> |
| Avg. | <p>Site : 03CH11-HY<br/>Condition : AVG_BE_54 3m HORN 91200-HF HORIZONTAL</p>  | Left blank  |



| WIFI | Band 1 5150~5250MHz Band Edge @ 3m   |             |
|------|--|-------------|
| ANT  | 802.11n HT20 CH44 5220MHz - R  |             |
| 1    | Horizontal   | Fundamental |
| Peak | <p>Site : 03CH11-HY<br/>Condition : PEAK_BE_74 3m HORN 9120D-HF HORIZONTAL</p> | Left blank  |
| Avg. | <p>Site : 03CH11-HY<br/>Condition : AVG_BE_54 3m HORN 9120D-HF HORIZONTAL</p>  | Left blank  |

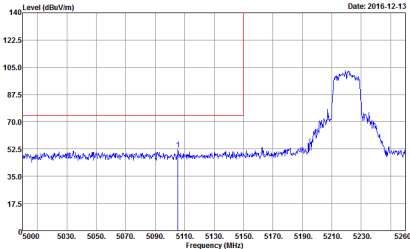
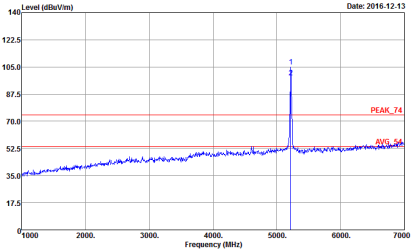
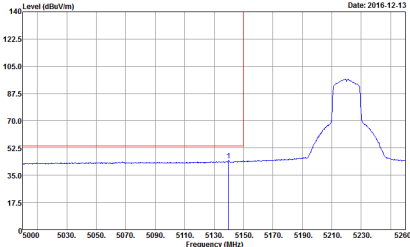

| WIFI | Band 1 5150~5250MHz Band Edge @ 3m  |  |
|------|---|--|
| ANT  | 802.11n HT20 CH44 5220MHz - L   |  |
| 1    | Vertical  | Fundamental  |
| Peak |  <p>Date: 2016-12-13</p> <p>Site : 03CH11-HY<br/>Condition : PEAK_BE_74 3m HORN 91200-HF VERTICAL</p>  |  <p>Date: 2016-12-13</p> <p>Site : 03CH11-HY<br/>Condition : PEAK_74 3m HORN 91200-HF VERTICAL</p> |
| Avg. |  <p>Date: 2016-12-13</p> <p>Site : 03CH11-HY<br/>Condition : AVG_BE_54 3m HORN 91200-HF VERTICAL</p> | Left blank   |

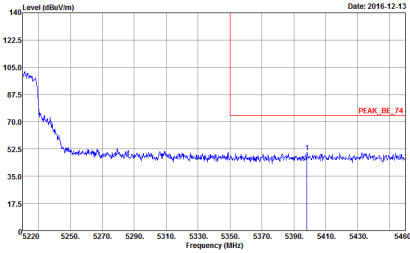
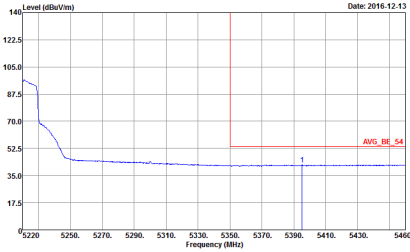

| WIFI | Band 1 5150~5250MHz Band Edge @ 3m  |             |
|------|---|-------------|
| ANT  | 802.11n HT20 CH44 5220MHz - R   |             |
| 1    | Vertical  | Fundamental |
| Peak |  <p>Date: 2016-12-13</p> <p>Site : 03CH11-HY<br/>Condition : PEAK_BE_74 3m HORN 9120D-HF VERTICAL</p>  | Left blank  |
| Avg. |  <p>Date: 2016-12-13</p> <p>Site : 03CH11-HY<br/>Condition : AVG_BE_54 3m HORN 9120D-HF VERTICAL</p> | Left blank  |





| WIFI | Band 1 5150~5250MHz Band Edge @ 3m   |   |
|------|--|---|
| ANT  | 802.11n HT20 CH48 5240MHz - L  |   |
| 1    | Horizontal   | Fundamental   |
| Peak | <p>Site : 03CH11-HY<br/>Condition : PEAK_BE_74 3m HORN 91200-HF HORIZONTAL</p> | <p>Site : 03CH11-HY<br/>Condition : PEAK_74 3m HORN 91200-HF HORIZONTAL</p> |
| Avg. | <p>Site : 03CH11-HY<br/>Condition : AVG_BE_54 3m HORN 91200-HF HORIZONTAL</p>  | Left blank  |



| WIFI | Band 1 5150~5250MHz Band Edge @ 3m   |             |
|------|--|-------------|
| ANT  | 802.11n HT20 CH48 5240MHz - R  |             |
| 1    | Horizontal   | Fundamental |
| Peak | <p>Site : 03CHI1-HY<br/>Condition : PEAK_BE_74 3m HORN 9120D-HF HORIZONTAL</p> | Left blank  |
| Avg. | <p>Site : 03CHI1-HY<br/>Condition : AVG_BE_54 3m HORN 9120D-HF HORIZONTAL</p>  | Left blank  |



| WIFI | Band 1 5150~5250MHz Band Edge @ 3m   |   |
|------|--|---|
| ANT  | 802.11n HT20 CH48 5240MHz - L  |   |
| 1    | Vertical   | Fundamental   |
| Peak | <p>Site : 03CH11-HY<br/>Condition : PEAK_BE_74 3m HORN 91200-HF VERTICAL</p> | <p>Site : 03CH11-HY<br/>Condition : PEAK_74 3m HORN 91200-HF VERTICAL</p> |
| Avg. | <p>Site : 03CH11-HY<br/>Condition : AVG_BE_54 3m HORN 91200-HF VERTICAL</p>  | Left blank  |



| WIFI | Band 1 5150~5250MHz Band Edge @ 3m   |             |
|------|--|-------------|
| ANT  | 802.11n HT20 CH48 5240MHz - R  |             |
| 1    | Vertical   | Fundamental |
| Peak | <p>Site : 03CH11-HY<br/>Condition : PEAK_BE_74 3m HORN 9120D-HF VERTICAL</p> | Left blank  |
| Avg. | <p>Site : 03CH11-HY<br/>Condition : AVG_BE_54 3m HORN 9120D-HF VERTICAL</p>  | Left blank  |



**Band 1 5150~5250MHz  
WIFI 802.11n HT40 (Band Edge @ 3m)**

| WIFI               | Band 1 5150~5250MHz Band Edge @ 3m   |   |
|--------------------|--|---|
| ANT                | 802.11n HT40 CH38 5190MHz - L  |   |
| 1                  | Horizontal   | Fundamental   |
| <p><b>Peak</b></p> | <p>Site : 03CH11-HY<br/>Condition : PEAK_BE_74 3m HORN 9120D-HF HORIZONTAL</p> | <p>Site : 03CH11-HY<br/>Condition : PEAK_74 3m HORN 9120D-HF HORIZONTAL</p> |
| <p><b>Avg.</b></p> | <p>Site : 03CH11-HY<br/>Condition : AVG_BE_54 3m HORN 9120D-HF HORIZONTAL</p>  | <p>Left blank</p>   |

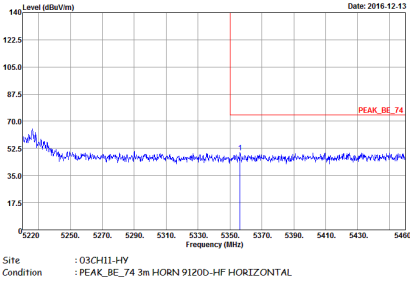
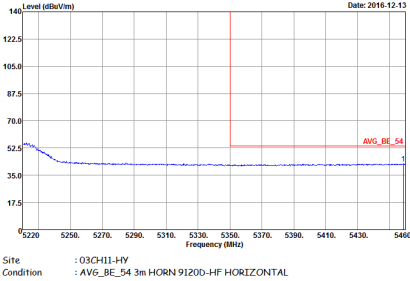

| WIFI | Band 1 5150~5250MHz Band Edge @ 3m  |             |
|------|---|-------------|
| ANT  | 802.11n HT40 CH38 5190MHz - R   |             |
| 1    | Horizontal  | Fundamental |
| Peak |  <p>Left blank</p>   |             |
| Avg. |  <p>Left blank</p> |             |



| WIFI | Band 1 5150~5250MHz Band Edge @ 3m   |   |
|------|--|---|
| ANT  | 802.11n HT40 CH38 5190MHz - L  |   |
| 1    | Vertical   | Fundamental   |
| Peak | <p>Site : 03CHI1-HY<br/>Condition : PEAK_BE_74 3m HORN 9120D-HF VERTICAL</p> | <p>Site : 03CHI1-HY<br/>Condition : PEAK_74 3m HORN 9120D-HF VERTICAL</p> |
| Avg. | <p>Site : 03CHI1-HY<br/>Condition : AVG_BE_54 3m HORN 9120D-HF VERTICAL</p>  | Left blank  |



| WIFI | Band 1 5150~5250MHz Band Edge @ 3m   |             |
|------|--|-------------|
| ANT  | 802.11n HT40 CH38 5190MHz - R  |             |
| 1    | Vertical   | Fundamental |
| Peak | <p>Site : 03CHI1-HY<br/>Condition : PEAK_BE_74 3m HORN 9120D-HF VERTICAL</p> | Left blank  |
| Avg. | <p>Site : 03CHI1-HY<br/>Condition : AVG_BE_54 3m HORN 9120D-HF VERTICAL</p>  | Left blank  |





| WIFI | Band 1 5150~5250MHz Band Edge @ 3m   |   |
|------|--|---|
| ANT  | 802.11n HT40 CH46 5230MHz - L  |   |
| 1    | Horizontal   | Fundamental   |
| Peak | <p>Site : 03CH11-HY<br/>Condition : PEAK_BE_74 3m HORN 9120D-HF HORIZONTAL</p> | <p>Site : 03CH11-HY<br/>Condition : PEAK_74 3m HORN 9120D-HF HORIZONTAL</p> |
| Avg. | <p>Site : 03CH11-HY<br/>Condition : AVG_BE_54 3m HORN 9120D-HF HORIZONTAL</p>  | Left blank  |



| WIFI | Band 1 5150~5250MHz Band Edge @ 3m   |             |
|------|--|-------------|
| ANT  | 802.11n HT40 CH46 5230MHz - R  |             |
| 1    | Horizontal   | Fundamental |
| Peak | <p>Site : 03CH11-HY<br/>Condition : PEAK_BE_74 3m HORN 9120D-HF HORIZONTAL</p> | Left blank  |
| Avg. | <p>Site : 03CH11-HY<br/>Condition : AVG_BE_54 3m HORN 9120D-HF HORIZONTAL</p>  | Left blank  |

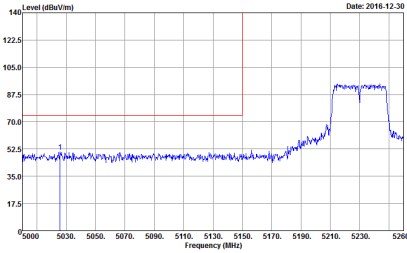
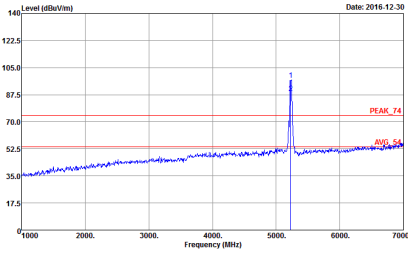
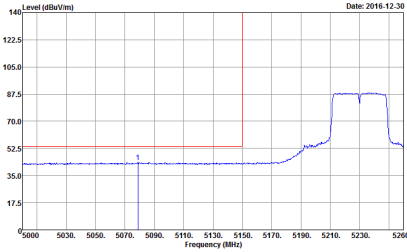

| WIFI | Band 1 5150~5250MHz Band Edge @ 3m  |  |
|------|---|--|
| ANT  | 802.11n HT40 CH46 5230MHz - L   |  |
| 1    | Vertical  | Fundamental  |
| Peak |  <p>Date: 2016-12-30</p> <p>Site : 03CH11-HY<br/>Condition : PEAK_BE_74 3m HORN 91200-HF VERTICAL</p>  |  <p>Date: 2016-12-30</p> <p>Site : 03CH11-HY<br/>Condition : PEAK_74 3m HORN 91200-HF VERTICAL</p> |
| Avg. |  <p>Date: 2016-12-30</p> <p>Site : 03CH11-HY<br/>Condition : AVG_BE_54 3m HORN 91200-HF VERTICAL</p> | Left blank   |

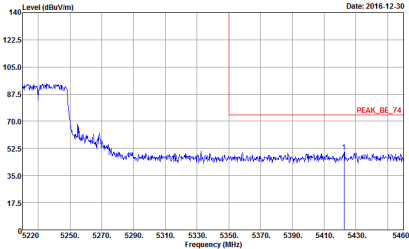
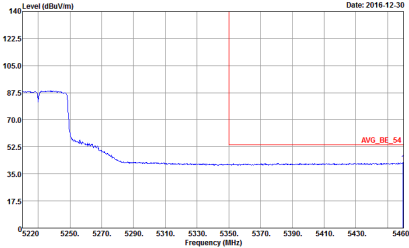

| WIFI | Band 1 5150~5250MHz Band Edge @ 3m  |             |
|------|---|-------------|
| ANT  | 802.11n HT40 CH46 5230MHz - R   |             |
| 1    | Vertical  | Fundamental |
| Peak |  <p>Date: 2016-12-30</p> <p>Site : 03CHI1-HY<br/>Condition : PEAK_BE_74 3m HORN 9120D-HF VERTICAL</p>  | Left blank  |
| Avg. |  <p>Date: 2016-12-30</p> <p>Site : 03CHI1-HY<br/>Condition : AVG_BE_54 3m HORN 9120D-HF VERTICAL</p> | Left blank  |



Band 1 - 5150~5250MHz

WIFI 802.11a (Harmonic @ 3m)

|           |  |  |
|-----------|--|--|
| WIFI      | Band 1 5150~5250MHz Harmonic @ 3m  |  |
| ANT       | 802.11a CH36 5180MHz   |  |
| 1         | Horizontal   | Vertical   |
| Peak Avg. | <p>Site : 03CH11-HY<br/>Condition : PEAK_T4 3m 9170 SHF HORM_150809 HORIZONTAL</p> | <p>Site : 03CH11-HY<br/>Condition : PEAK_T4 3m 9170 SHF HORM_150809 VERTICAL</p> |



| WIFI      | Band 1 5150~5250MHz Harmonic @ 3m  |  |
|-----------|--|--|
| ANT       | 802.11a CH44 5220MHz   |  |
| 1         | Horizontal   | Vertical   |
| Peak Avg. | <p>Site : 03CH11-HY<br/>Condition : PEAK_74 3m 9170 SHF HORM_150809 HORIZONTAL</p> | <p>Site : 03CH11-HY<br/>Condition : PEAK_74 3m 9170 SHF HORM_150809 VERTICAL</p> |

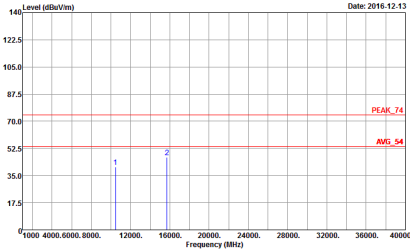
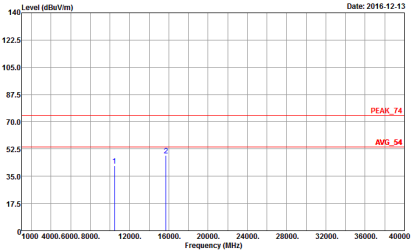

|           |  |   |
|-----------|--|---|
| WIFI      | Band 1 5150~5250MHz Harmonic @ 3m  |   |
| ANT       | 802.11a CH48 5240MHz   |   |
| 1         | Horizontal   | Vertical  |
| Peak Avg. |  <p>Site : 03CH11-HY<br/>Condition : PEAK_74 3m 9170 SHF HORM_150809 HORIZONTAL</p> |  <p>Site : 03CH11-HY<br/>Condition : PEAK_74 3m 9170 SHF HORM_150809 VERTICAL</p> |



**Band 1 5150~5250MHz**  
**WIFI 802.11n HT20 (Harmonic @ 3m)**

| WIFI                               | Band 1 5150~5250MHz Harmonic @ 3m   |   |
|------------------------------------|---|---|
| ANT                                | 802.11n HT20 CH36 5180MHz   |   |
| 1                                  | Horizontal  | Vertical  |
| <p><b>Peak</b><br/><b>Avg.</b></p> | <p>Site : 03CH11-HY<br/>           Condition : PEAK_74 3m 9170 SHF HORM_150809 HORIZONTAL</p> | <p>Site : 03CH11-HY<br/>           Condition : PEAK_74 3m 9170 SHF HORM_150809 VERTICAL</p> |





| WIFI      | Band 1 5150~5250MHz Harmonic @ 3m  |  |
|-----------|--|--|
| ANT       | 802.11n HT20 CH44 5220MHz  |  |
| 1         | Horizontal   | Vertical   |
| Peak Avg. | <p>Site : 03CH11-HY<br/>Condition : PEAK_74 3m 9170 SHF HORM_150809 HORIZONTAL</p> | <p>Site : 03CH11-HY<br/>Condition : PEAK_74 3m 9170 SHF HORM_150809 VERTICAL</p> |

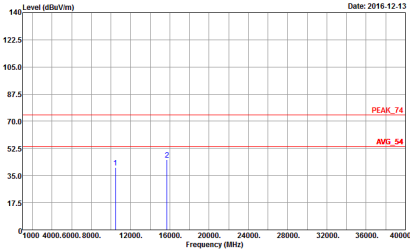
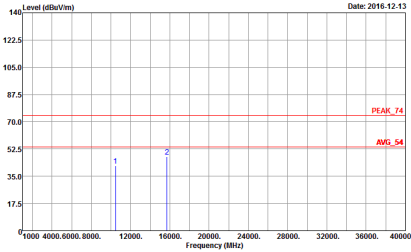

|           |  |   |
|-----------|--|---|
| WIFI      | Band 1 5150~5250MHz Harmonic @ 3m  |   |
| ANT       | 802.11n HT20 CH48 5240MHz  |   |
| 1         | Horizontal   | Vertical  |
| Peak Avg. |  <p>Site : 03CH11-HY<br/>Condition : PEAK_74 3m 9170 SHF HORM_150809 HORIZONTAL</p> |  <p>Site : 03CH11-HY<br/>Condition : PEAK_74 3m 9170 SHF HORM_150809 VERTICAL</p> |



Band 1 5150~5250MHz  
WIFI 802.11n HT40 (Harmonic @ 3m)

| WIFI         | Band 1 5150~5250MHz Harmonic @ 3m  |  |
|--------------|--|--|
| ANT          | 802.11n HT40 CH38 5190MHz  |  |
| 1            | Horizontal   | Vertical   |
| Peak<br>Avg. | <p>Site : 03CH11-HY<br/>Condition : PEAK_74 3m 9170 SHF HORM_150809 HORIZONTAL</p> | <p>Site : 03CH11-HY<br/>Condition : PEAK_74 3m 9170 SHF HORM_150809 VERTICAL</p> |



| WIFI      | Band 1 5150~5250MHz Harmonic @ 3m  |  |
|-----------|--|--|
| ANT       | 802.11n HT40 CH46 5230MHz  |  |
| 1         | Horizontal   | Vertical   |
| Peak Avg. | <p>Site : 03CH11-HY<br/>Condition : PEAK_74 3m 9170 SHF HORM_150809 HORIZONTAL</p> | <p>Site : 03CH11-HY<br/>Condition : PEAK_74 3m 9170 SHF HORM_150809 VERTICAL</p> |



**Band 2 - 5250~5350MHz**

**WIFI 802.11a (Band Edge @ 3m)**

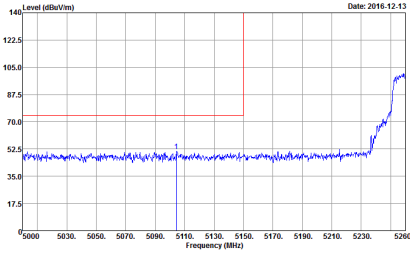
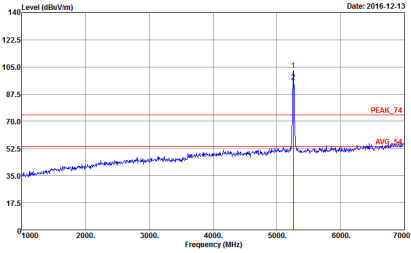
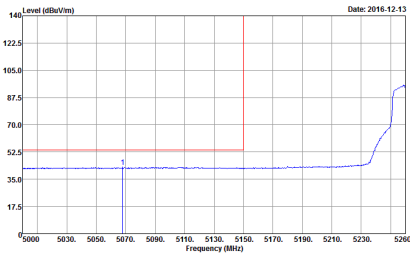
| WIFI | Band 2 5250~5350MHz Band Edge @ 3m  |  |
|------|---|--|
| ANT  | 802.11a CH52 5260MHz - L  |  |
| 1    | Horizontal  | Fundamental  |
| Peak |  <p>Site : 03CH11-HY<br/>Condition : PEAK_BE_74 3m HORN 9120D-HF HORIZONTAL</p>  |  <p>Site : 03CH11-HY<br/>Condition : PEAK_74 3m HORN 9120D-HF HORIZONTAL</p> |
| Avg. |  <p>Site : 03CH11-HY<br/>Condition : AV6_BE_54 3m HORN 9120D-HF HORIZONTAL</p> | Left blank   |



| WIFI | Band 2 5250~5350MHz Band Edge @ 3m   |             |
|------|--|-------------|
| ANT  | 802.11a CH52 5260MHz - R   |             |
| 1    | Horizontal   | Fundamental |
| Peak | <p>Site : 03CH11-HY<br/>Condition : PEAK_BE_74 3m HORN 9120D-HF HORIZONTAL</p> | Left blank  |
| Avg. | <p>Site : 03CH11-HY<br/>Condition : AVG_BE_54 3m HORN 9120D-HF HORIZONTAL</p>  | Left blank  |



| WIFI | Band 2 5250~5350MHz Band Edge @ 3m   |   |
|------|--|---|
| ANT  | 802.11a CH52 5260MHz - L   |   |
| 1    | Vertical   | Fundamental   |
| Peak | <p>Site : 03CH11-HY<br/>Condition : PEAK_BE_74 3m HORN 91200-HF VERTICAL</p> | <p>Site : 03CH11-HY<br/>Condition : PEAK_74 3m HORN 91200-HF VERTICAL</p> |
| Avg. | <p>Site : 03CH11-HY<br/>Condition : AVG_BE_54 3m HORN 91200-HF VERTICAL</p>  | Left blank  |



| WIFI | Band 2 5250~5350MHz Band Edge @ 3m   |             |
|------|--|-------------|
| ANT  | 802.11a CH52 5260MHz - R   |             |
| 1    | Vertical   | Fundamental |
| Peak | <p>Site : 03CH11-HY<br/>Condition : PEAK_BE_74 3m HORN 9120D-HF VERTICAL</p> | Left blank  |
| Avg. | <p>Site : 03CH11-HY<br/>Condition : AVG_BE_54 3m HORN 9120D-HF VERTICAL</p>  | Left blank  |



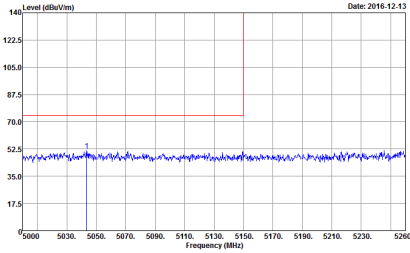
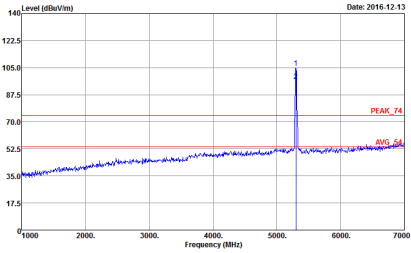
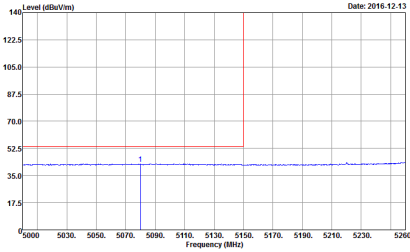

| WIFI | Band 2 5250~5350MHz Band Edge @ 3m  |  |
|------|---|--|
| ANT  | 802.11a CH60 5300MHz - L  |  |
| 1    | Horizontal  | Fundamental  |
| Peak |  <p>Date: 2016-12-13</p> <p>Site : 03CH11-HY<br/>Condition : PEAK_BE_74 3m HORN 91200-HF HORIZONTAL</p>  |  <p>Date: 2016-12-13</p> <p>Site : 03CH11-HY<br/>Condition : PEAK_74 3m HORN 91200-HF HORIZONTAL</p> |
| Avg. |  <p>Date: 2016-12-13</p> <p>Site : 03CH11-HY<br/>Condition : AVG_BE_54 3m HORN 91200-HF HORIZONTAL</p> | Left blank   |

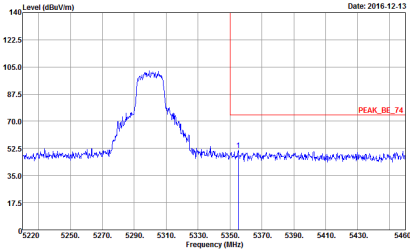
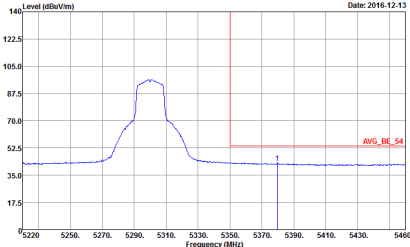

| WIFI | Band 2 5250~5350MHz Band Edge @ 3m  |             |
|------|---|-------------|
| ANT  | 802.11a CH60 5300MHz - R  |             |
| 1    | Horizontal  | Fundamental |
| Peak |  <p>Date: 2016-12-13</p> <p>Site : 03CH11-HY<br/>Condition : PEAK_BE_74 3m HORN 9120D-HF HORIZONTAL</p>  | Left blank  |
| Avg. |  <p>Date: 2016-12-13</p> <p>Site : 03CH11-HY<br/>Condition : AVG_BE_54 3m HORN 9120D-HF HORIZONTAL</p> | Left blank  |

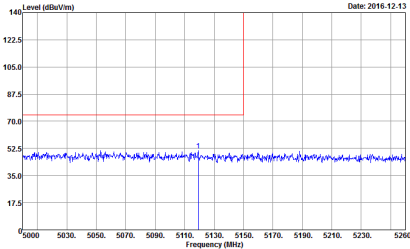
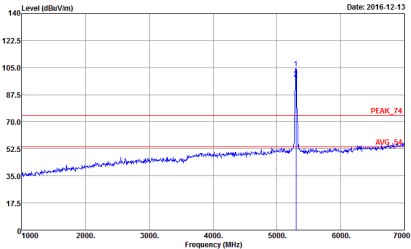
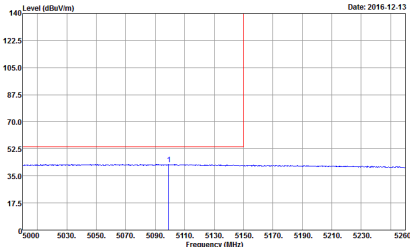

| WIFI | Band 2 5250~5350MHz Band Edge @ 3m  |  |
|------|---|--|
| ANT  | 802.11a CH60 5300MHz - L  |  |
| 1    | Vertical  | Fundamental  |
| Peak |  <p>Site : 03CHI1-HY<br/>Condition : PEAK_BE_74 3m HORN 91200-HF VERTICAL</p>  |  <p>Site : 03CHI1-HY<br/>Condition : PEAK_74 3m HORN 91200-HF VERTICAL</p> |
| Avg. |  <p>Site : 03CHI1-HY<br/>Condition : AVG_BE_54 3m HORN 91200-HF VERTICAL</p> | Left blank   |

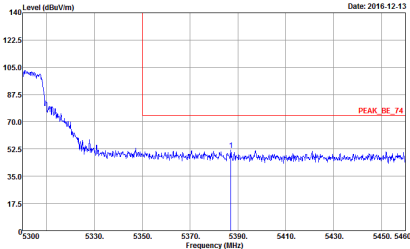
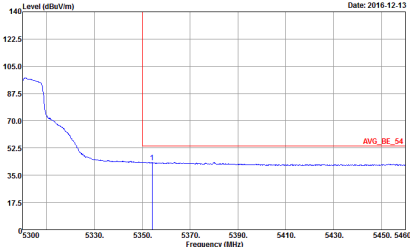

| WIFI | Band 2 5250~5350MHz Band Edge @ 3m  |             |
|------|---|-------------|
| ANT  | 802.11a CH60 5300MHz - R  |             |
| 1    | Vertical  | Fundamental |
| Peak |  <p>Date: 2016-12-13</p> <p>Site : 03CH11-HY<br/>Condition : PEAK_BE_74 3m HORN 9120D-HF VERTICAL</p>  | Left blank  |
| Avg. |  <p>Date: 2016-12-13</p> <p>Site : 03CH11-HY<br/>Condition : AVG_BE_54 3m HORN 9120D-HF VERTICAL</p> | Left blank  |

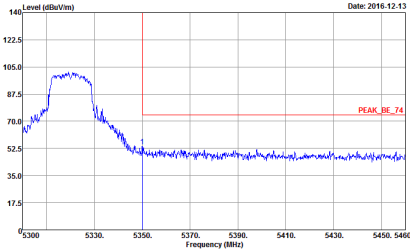
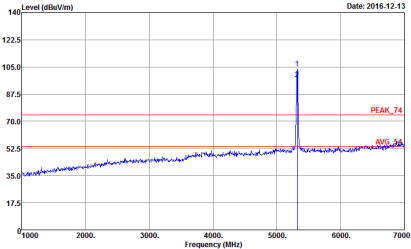
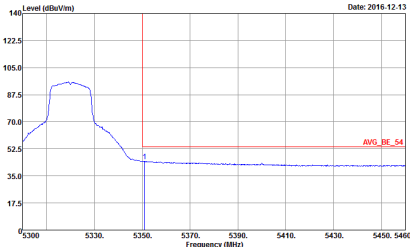

| WIFI | Band 2 5250~5350MHz Band Edge @ 3m  |  |
|------|---|--|
| ANT  | 802.11a CH64 5320MHz  |  |
| 1    | Horizontal  | Fundamental  |
| Peak |  <p>Date: 2016-12-13</p> <p>Site : 03CHI1-HY<br/>Condition : PEAK_BE_74 3m HORN 9120D-HF HORIZONTAL</p>  |  <p>Date: 2016-12-13</p> <p>Site : 03CHI1-HY<br/>Condition : PEAK_74 3m HORN 9120D-HF HORIZONTAL</p> |
| Avg. |  <p>Date: 2016-12-13</p> <p>Site : 03CHI1-HY<br/>Condition : AVG_BE_54 3m HORN 9120D-HF HORIZONTAL</p> | Left blank   |



| WIFI | Band 2 5250~5350MHz Band Edge @ 3m   |   |
|------|--|---|
| ANT  | 802.11a CH64 5320MHz   |   |
| 1    | Vertical   | Fundamental   |
| Peak | <p>Site : 03CH11-HY<br/>Condition : PEAK_BE_74 3m HORN 9120D-HF VERTICAL</p> | <p>Site : 03CH11-HY<br/>Condition : PEAK_74 3m HORN 9120D-HF VERTICAL</p> |
| Avg. | <p>Site : 03CH11-HY<br/>Condition : AVG_BE_54 3m HORN 9120D-HF VERTICAL</p>  | Left blank  |



Band 2 5250~5350MHz
WIFI 802.11n HT20 (Band Edge @ 3m)

Table with 3 columns: WIFI, ANT, and test results. Row 1: Peak analysis for Horizontal and Fundamental. Row 2: Avg. analysis for Horizontal and Fundamental. Includes spectral plots and site conditions.

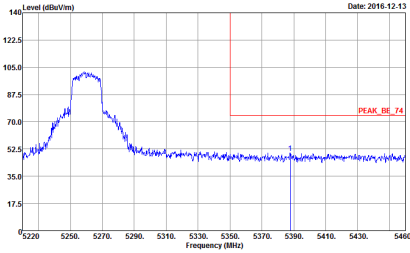
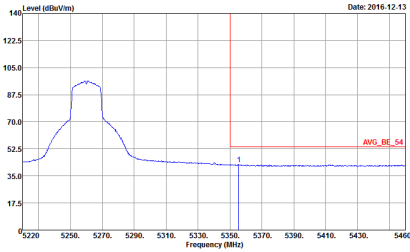

| WIFI | Band 2 5250~5350MHz Band Edge @ 3m  |             |
|------|---|-------------|
| ANT  | 802.11n HT20 CH52 5260MHz - R   |             |
| 1    | Horizontal  | Fundamental |
| Peak |  <p>Date: 2016-12-13</p> <p>Site : 03CH11-HY<br/>Condition : PEAK_BE_74 3m HORN 9120D-HF HORIZONTAL</p>  | Left blank  |
| Avg. |  <p>Date: 2016-12-13</p> <p>Site : 03CH11-HY<br/>Condition : AVG_BE_54 3m HORN 9120D-HF HORIZONTAL</p> | Left blank  |



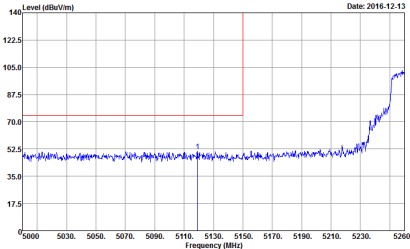
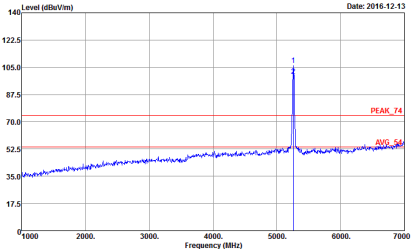
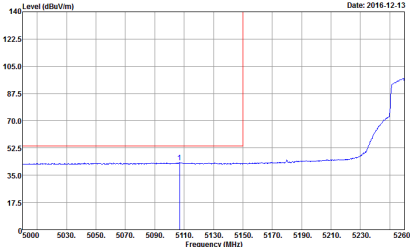

| WIFI | Band 2 5250~5350MHz Band Edge @ 3m  |  |
|------|---|--|
| ANT  | 802.11n HT20 CH52 5260MHz - L   |  |
| 1    | Vertical  | Fundamental  |
| Peak |  <p>Date: 2016-12-13</p> <p>Site : 03CH11-HY<br/>Condition : PEAK_BE_74 3m HORN 91200-HF VERTICAL</p>  |  <p>Date: 2016-12-13</p> <p>Site : 03CH11-HY<br/>Condition : PEAK_74 3m HORN 91200-HF VERTICAL</p> |
| Avg. |  <p>Date: 2016-12-13</p> <p>Site : 03CH11-HY<br/>Condition : AVG_BE_54 3m HORN 91200-HF VERTICAL</p> | Left blank   |

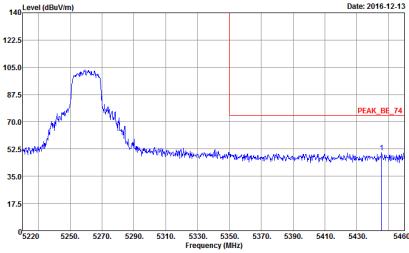
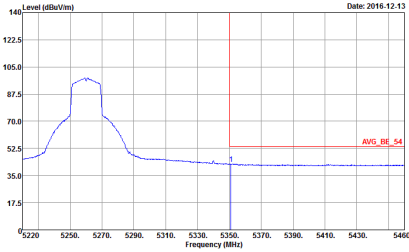

| WIFI | Band 2 5250~5350MHz Band Edge @ 3m  |             |
|------|---|-------------|
| ANT  | 802.11n HT20 CH52 5260MHz - R   |             |
| 1    | Vertical  | Fundamental |
| Peak |  <p>Date: 2016-12-13</p> <p>Site : 03CH11-HY<br/>Condition : PEAK_BE_74 3m HORN 9120D-HF VERTICAL</p>  | Left blank  |
| Avg. |  <p>Date: 2016-12-13</p> <p>Site : 03CH11-HY<br/>Condition : AVG_BE_54 3m HORN 9120D-HF VERTICAL</p> | Left blank  |

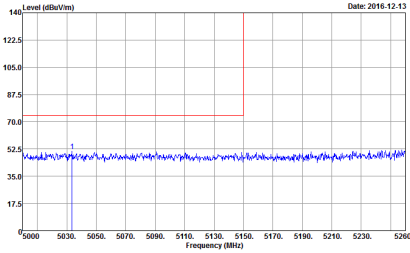
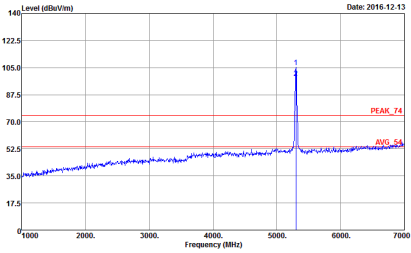
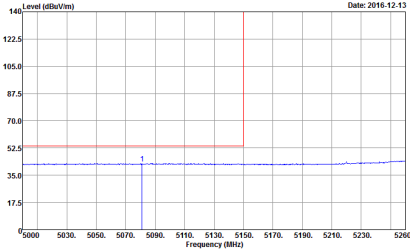

| WIFI | Band 2 5250~5350MHz Band Edge @ 3m  |  |
|------|---|--|
| ANT  | 802.11n HT20 CH60 5300MHz - L   |  |
| 1    | Horizontal  | Fundamental  |
| Peak |  <p>Date: 2016-12-13</p> <p>Site : 03CH11-HY<br/>Condition : PEAK_BE_74 3m HORN 91200-HF HORIZONTAL</p>  |  <p>Date: 2016-12-13</p> <p>Site : 03CH11-HY<br/>Condition : PEAK_74 3m HORN 91200-HF HORIZONTAL</p> |
| Avg. |  <p>Date: 2016-12-13</p> <p>Site : 03CH11-HY<br/>Condition : AVG_BE_54 3m HORN 91200-HF HORIZONTAL</p> | Left blank   |



| WIFI | Band 2 5250~5350MHz Band Edge @ 3m   |            |
|------|--|------------|
| ANT  | 802.11n HT20 CH60 5300MHz - R  |            |
| 1    | Horizontal   | Vertical   |
| Peak | <p>Site : 03CH11-HY<br/>Condition : PEAK_BE_74 3m HORN 9120D-HF HORIZONTAL</p> | Left blank |
| Avg. | <p>Site : 03CH11-HY<br/>Condition : AVG_BE_54 3m HORN 9120D-HF HORIZONTAL</p>  | Left blank |



| WIFI | Band 2 5250~5350MHz Band Edge @ 3m   |   |
|------|--|---|
| ANT  | 802.11n HT20 CH60 5300MHz - L  |   |
| 1    | Vertical   | Fundamental   |
| Peak | <p>Site : 03CH11-HY<br/>Condition : PEAK_BE_74 3m HORN 91200-HF VERTICAL</p> | <p>Site : 03CH11-HY<br/>Condition : PEAK_74 3m HORN 91200-HF VERTICAL</p> |
| Avg. | <p>Site : 03CH11-HY<br/>Condition : AVG_BE_54 3m HORN 91200-HF VERTICAL</p>  | Left blank  |



| WIFI | Band 2 5250~5350MHz Band Edge @ 3m   |             |
|------|--|-------------|
| ANT  | 802.11n HT20 CH60 5300MHz - R  |             |
| 1    | Vertical   | Fundamental |
| Peak | <p>Site : 03CHI1-HY<br/>Condition : PEAK_BE_74 3m HORN 9120D-HF VERTICAL</p> | Left blank  |
| Avg. | <p>Site : 03CHI1-HY<br/>Condition : AVG_BE_54 3m HORN 9120D-HF VERTICAL</p>  | Left blank  |

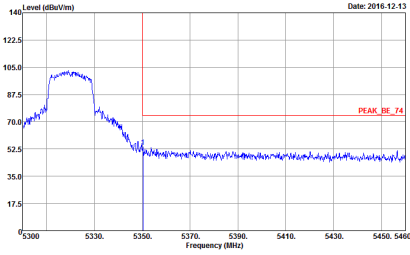
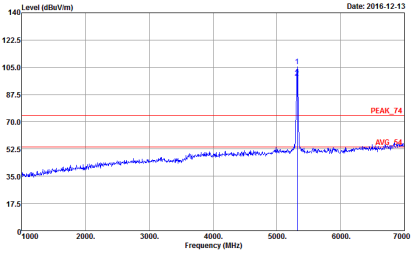
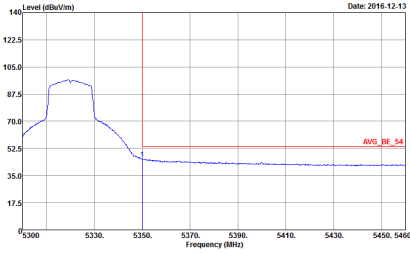

| WIFI | Band 2 5250~5350MHz Band Edge @ 3m  |  |
|------|---|--|
| ANT  | 802.11n HT20 CH64 5320MHz   |  |
| 1    | Horizontal  | Fundamental  |
| Peak |  <p>Date: 2016-12-13</p> <p>Site : 03CHI1-HY<br/>Condition : PEAK_BE_74 3m HORN 9120D-HF HORIZONTAL</p>  |  <p>Date: 2016-12-13</p> <p>Site : 03CHI1-HY<br/>Condition : PEAK_74 3m HORN 9120D-HF HORIZONTAL</p> |
| Avg. |  <p>Date: 2016-12-13</p> <p>Site : 03CHI1-HY<br/>Condition : AVG_BE_54 3m HORN 9120D-HF HORIZONTAL</p> | Left blank   |

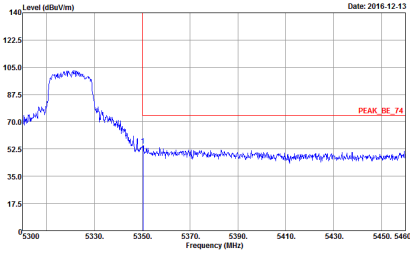
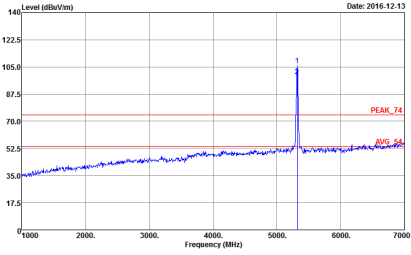
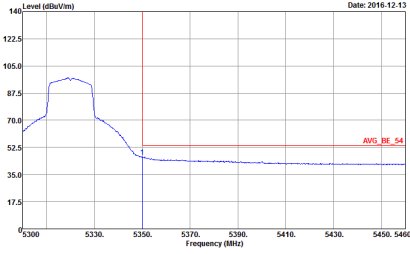

| WIFI | Band 2 5250~5350MHz Band Edge @ 3m  |  |
|------|---|--|
| ANT  | 802.11n HT20 CH64 5320MHz   |  |
| 1    | Vertical  | Fundamental  |
| Peak |  <p>Date: 2016-12-13</p> <p>Site : 03CHI1-HY<br/>Condition : PEAK_BE_74 3m HORN 9120D-HF VERTICAL</p>  |  <p>Date: 2016-12-13</p> <p>Site : 03CHI1-HY<br/>Condition : PEAK_74 3m HORN 9120D-HF VERTICAL</p> |
| Avg. |  <p>Date: 2016-12-13</p> <p>Site : 03CHI1-HY<br/>Condition : AVG_BE_54 3m HORN 9120D-HF VERTICAL</p> | Left blank   |





Band 2 5250~5350MHz
WIFI 802.11n HT40 (Band Edge @ 3m)

Table with 3 columns: WIFI, ANT, and test results. Row 1: Peak results for Horizontal and Fundamental. Row 2: Avg. results for Horizontal and Fundamental. Includes frequency plots and site conditions.

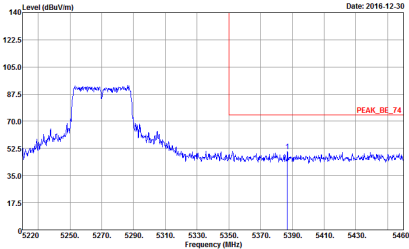
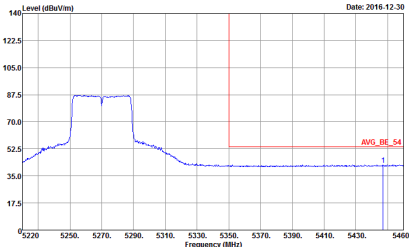

| WIFI | Band 2 5250~5350MHz Band Edge @ 3m  |             |
|------|---|-------------|
| ANT  | 802.11n HT40 CH54 5270 MHz - R  |             |
| 1    | Horizontal  | Fundamental |
| Peak |  <p>Date: 2016-12-30</p> <p>Site : 03CH11-HY<br/>Condition : PEAK_BE_74 3m HORN 9120D-HF HORIZONTAL</p>  | Left blank  |
| Avg. |  <p>Date: 2016-12-30</p> <p>Site : 03CH11-HY<br/>Condition : AVG_BE_54 3m HORN 9120D-HF HORIZONTAL</p> | Left blank  |



| WIFI | Band 2 5250~5350MHz Band Edge @ 3m   |   |
|------|--|---|
| ANT  | 802.11n HT40 CH54 5270 MHz - L   |   |
| 1    | Vertical   | Vertical  |
| Peak | <p>Site : 03CH11-HY<br/>Condition : PEAK_BE_74 3m HORN 9120D-HF VERTICAL</p> | <p>Site : 03CH11-HY<br/>Condition : PEAK_74 3m HORN 9120D-HF VERTICAL</p> |
| Avg. | <p>Site : 03CH11-HY<br/>Condition : AVG_BE_54 3m HORN 9120D-HF VERTICAL</p>  | Left blank  |

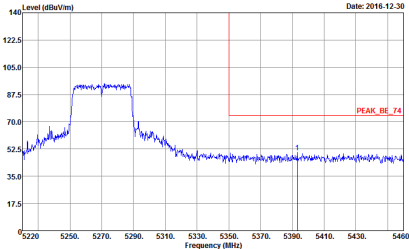
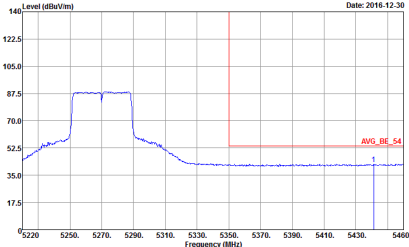

| WIFI | Band 2 5250~5350MHz Band Edge @ 3m  |            |
|------|---|------------|
| ANT  | 802.11n HT40 CH54 5270 MHz - R  |            |
| 1    | Vertical  | Vertical   |
| Peak |  <p>Date: 2016-12-30</p> <p>Site : 03CH11-HY<br/>Condition : PEAK_BE_74 3m HORN 9120D-HF VERTICAL</p>  | Left blank |
| Avg. |  <p>Date: 2016-12-30</p> <p>Site : 03CH11-HY<br/>Condition : AVG_BE_54 3m HORN 9120D-HF VERTICAL</p> | Left blank |



| WIFI | Band 2 5250~5350MHz Band Edge @ 3m  |   |
|------|---|---|
| ANT  | 802.11n HT40 CH62 5310 MHz - L  |   |
| 1    | Horizontal  | Fundamental   |
| Peak | <p>Horizontal Peak graph showing Level (dBuV/m) vs Frequency (MHz). The y-axis ranges from 0 to 140 dBuV/m, and the x-axis ranges from 5000 to 5260 MHz. A red horizontal line is drawn at approximately 75 dBuV/m. A blue peak is visible at 5310 MHz. The date is 2016-12-14. Site: 03CH11-HY, Condition: PEAK_BE_74 3m HORN 91200-HF HORIZONTAL.</p> | <p>Fundamental Peak graph showing Level (dBuV/m) vs Frequency (MHz). The y-axis ranges from 0 to 140 dBuV/m, and the x-axis ranges from 1000 to 7000 MHz. A red horizontal line is drawn at approximately 75 dBuV/m. A blue peak is visible at 5310 MHz. The date is 2016-12-14. Site: 03CH11-HY, Condition: PEAK_74 3m HORN 91200-HF HORIZONTAL.</p> |
| Avg. | <p>Horizontal Avg. graph showing Level (dBuV/m) vs Frequency (MHz). The y-axis ranges from 0 to 140 dBuV/m, and the x-axis ranges from 5000 to 5260 MHz. A red horizontal line is drawn at approximately 75 dBuV/m. A blue peak is visible at 5310 MHz. The date is 2016-12-14. Site: 03CH11-HY, Condition: AVG_BE_54 3m HORN 91200-HF HORIZONTAL.</p>  | Left blank  |



| WIFI | Band 2 5250~5350MHz Band Edge @ 3m   |             |
|------|--|-------------|
| ANT  | 802.11n HT40 CH62 5310 MHz - R   |             |
| 1    | Horizontal   | Fundamental |
| Peak | <p>Date: 2016-12-14</p> <p>Site : 03CHI1-HY<br/>Condition : PEAK_BE_74 3m HORN 9120D-HF HORIZONTAL</p> | Left blank  |
| Avg. | <p>Date: 2016-12-14</p> <p>Site : 03CHI1-HY<br/>Condition : AVG_BE_54 3m HORN 9120D-HF HORIZONTAL</p>  | Left blank  |



| WIFI        | Band 2 5250~5350MHz Band Edge @ 3m   |   |
|-------------|--|---|
| ANT         | 802.11n HT40 CH62 5310 MHz - L   |   |
| 1           | Vertical   | Fundamental   |
| <b>Peak</b> | <p>Site : 03CHI1-HY<br/>Condition : PEAK_BE_74 3m HORN 91200-HF VERTICAL</p> | <p>Site : 03CHI1-HY<br/>Condition : PEAK_74 3m HORN 91200-HF VERTICAL</p> |
| <b>Avg.</b> | <p>Site : 03CHI1-HY<br/>Condition : AVG_BE_54 3m HORN 91200-HF VERTICAL</p>  | Left blank  |

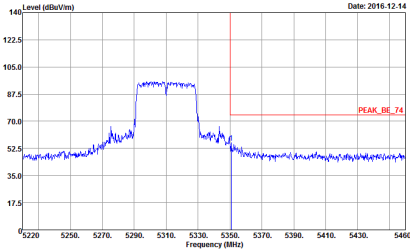
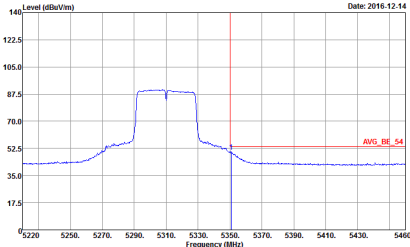

| WIFI | Band 2 5250~5350MHz Band Edge @ 3m  |             |
|------|---|-------------|
| ANT  | 802.11n HT40 CH62 5310 MHz - R  |             |
| 1    | Vertical  | Fundamental |
| Peak |  <p>Date: 2016-12-14</p> <p>Site : 03CHI1-HY<br/>Condition : PEAK_BE_74 3m HORN 9120D-HF VERTICAL</p>  | Left blank  |
| Avg. |  <p>Date: 2016-12-14</p> <p>Site : 03CHI1-HY<br/>Condition : AVG_BE_54 3m HORN 9120D-HF VERTICAL</p> | Left blank  |





Band 2 - 5250~5350MHz

WIFI 802.11a (Harmonic @ 3m)

| WIFI                    | Band 2 5250~5350MHz Harmonic @ 3m  |  |
|-------------------------|--|--|
| ANT                     | 802.11a CH52 5260MHz   |  |
| 1                       | Horizontal   | Vertical   |
| <p><b>Peak Avg.</b></p> | <p>Site : 03CH11-HY<br/>Condition : PEAK_74 3m 9170 SHF HORM_150809 HORIZONTAL</p> | <p>Site : 03CH11-HY<br/>Condition : PEAK_74 3m 9170 SHF HORM_150809 VERTICAL</p> |

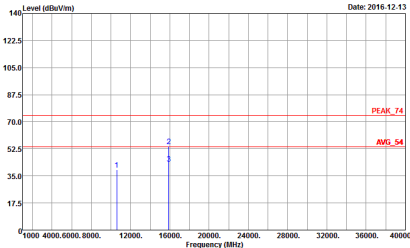
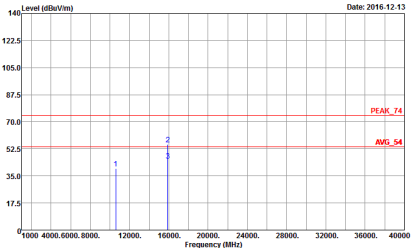

| WIFI                    | Band 2 5250~5350MHz Harmonic @ 3m  |   |
|-------------------------|--|---|
| ANT                     | 802.11a CH60 5300MHz   |   |
| 1                       | Horizontal   | Vertical  |
| <p><b>Peak Avg.</b></p> |  <p>Site : 03CH11-HY<br/>Condition : PEAK_74 3m 9170 SHF HORM_150809 HORIZONTAL</p> |  <p>Site : 03CH11-HY<br/>Condition : PEAK_74 3m 9170 SHF HORM_150809 VERTICAL</p> |

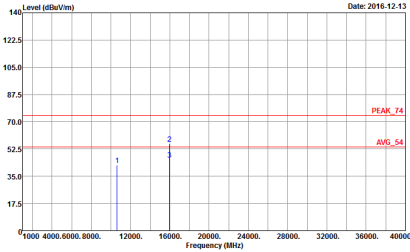
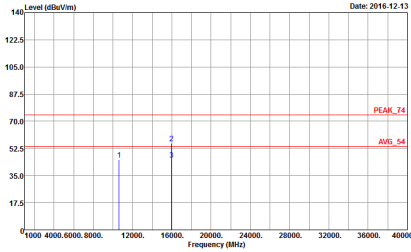

| WIFI                               | Band 2 5250~5350MHz Harmonic @ 3m  |   |
|------------------------------------|--|---|
| ANT                                | 802.11a CH64 5320MHz   |   |
| 1                                  | Horizontal   | Vertical  |
| <p><b>Peak</b><br/><b>Avg.</b></p> |  <p>Date: 2016.12.13</p> <p>Site : 03CH11-HY<br/>Condition : PEAK_74 3m 9170 SHF HORM_150809 HORIZONTAL</p> |  <p>Date: 2016.12.13</p> <p>Site : 03CH11-HY<br/>Condition : PEAK_74 3m 9170 SHF HORM_150809 VERTICAL</p> |



Band 2 5250~5350MHz  
WIFI 802.11n HT20 (Harmonic @ 3m)

| WIFI         | Band 2 5250~5350MHz Harmonic @ 3m  |  |
|--------------|--|--|
| ANT          | 802.11n HT20 CH52 5260MHz  |  |
| 1            | Horizontal   | Vertical   |
| Peak<br>Avg. | <p>Site : 03CH11-HY<br/>Condition : PEAK_74 3m 9170 SHF HORM_150809 HORIZONTAL</p> | <p>Site : 03CH11-HY<br/>Condition : PEAK_74 3m 9170 SHF HORM_150809 VERTICAL</p> |



| WIFI      | Band 2 5250~5350MHz Harmonic @ 3m  |  |
|-----------|--|--|
| ANT       | 802.11n HT20 CH60 5300MHz  |  |
| 1         | Horizontal   | Vertical   |
| Peak Avg. | <p>Site : 03CH11-HY<br/>Condition : PEAK_74 3m 9170 SHF HORM_150809 HORIZONTAL</p> | <p>Site : 03CH11-HY<br/>Condition : PEAK_74 3m 9170 SHF HORM_150809 VERTICAL</p> |



| WIFI      | Band 2 5250~5350MHz Harmonic @ 3m  |  |
|-----------|--|--|
| ANT       | 802.11n HT20 CH64 5320MHz  |  |
| 1         | Horizontal   | Vertical   |
| Peak Avg. | <p>Site : 03CH11-HY<br/>Condition : PEAK_74 3m 9170 SHF HORM_150809 HORIZONTAL</p> | <p>Site : 03CH11-HY<br/>Condition : PEAK_74 3m 9170 SHF HORM_150809 VERTICAL</p> |



Band 2 5250~5350MHz  
WIFI 802.11n HT40 (Harmonic @ 3m)

| WIFI         | Band 2 5250~5350MHz Harmonic @ 3m  |  |
|--------------|--|--|
| ANT          | 802.11n HT40 CH54 5270 MHz   |  |
| 1            | Horizontal   | Vertical   |
| Peak<br>Avg. | <p>Site : 03CH11-HY<br/>Condition : PEAK_74 3m 9170 SHF HORM_150809 HORIZONTAL</p> | <p>Site : 03CH11-HY<br/>Condition : PEAK_74 3m 9170 SHF HORM_150809 VERTICAL</p> |



| WIFI      | Band 2 5250~5350MHz Harmonic @ 3m  |  |
|-----------|--|--|
| ANT       | 802.11n HT40 CH62 5310 MHz   |  |
| 1         | Horizontal   | Vertical   |
| Peak Avg. | <p>Site : 03CH11-HY<br/>Condition : PEAK_74 3m 9170 SHF HORM_150809 HORIZONTAL</p> | <p>Site : 03CH11-HY<br/>Condition : PEAK_74 3m 9170 SHF HORM_150809 VERTICAL</p> |





**Band 3 - 5470~5725MHz**

**WIFI 802.11a (Band Edge @ 3m)**

| WIFI        | Band 3 5470~5725MHz Band Edge @ 3m   |   |
|-------------|--|---|
| ANT         | 802.11a CH100 5500MHz  |   |
| 1           | Horizontal   | Fundamental   |
| <b>Peak</b> | <p>Site : 03CH11-HY<br/>Condition : PEAK_BE_74 3m HORN 9120D-HF HORIZONTAL</p> | <p>Site : 03CH11-HY<br/>Condition : PEAK_74 3m HORN 9120D-HF HORIZONTAL</p> |
| <b>Avg.</b> | <p>Site : 03CH11-HY<br/>Condition : AV6_BE_54 3m HORN 9120D-HF HORIZONTAL</p>  | Left blank  |

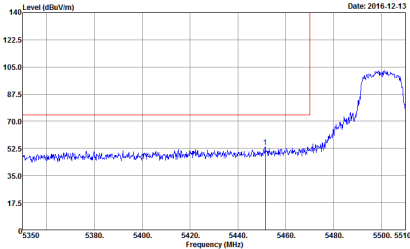
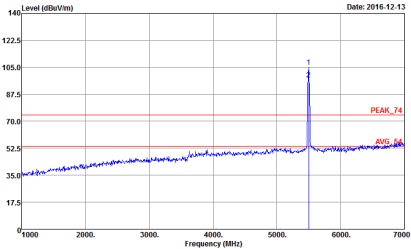
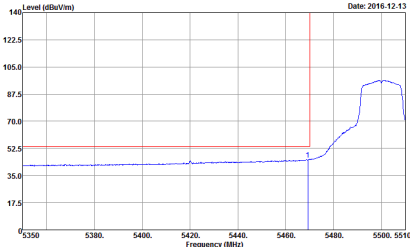

| WIFI | Band 3 5470~5725MHz Band Edge @ 3m  |  |
|------|---|--|
| ANT  | 802.11a CH100 5500MHz   |  |
| 1    | Vertical  | Fundamental  |
| Peak |  <p>Date: 2016-12-13</p> <p>Site : 03CH11-HY<br/>Condition : PEAK_BE_74 3m HORN 9120D-HF VERTICAL</p>  |  <p>Date: 2016-12-13</p> <p>Site : 03CH11-HY<br/>Condition : PEAK_74 3m HORN 9120D-HF VERTICAL</p> |
| Avg. |  <p>Date: 2016-12-13</p> <p>Site : 03CH11-HY<br/>Condition : AVG_BE_54 3m HORN 9120D-HF VERTICAL</p> | Left blank   |



| WIFI | Band 3 5470~5725MHz Band Edge @ 3m   |   |
|------|--|---|
| ANT  | 802.11a CH116 5580MHz - L  |   |
| 1    | Horizontal   | Fundamental   |
| Peak | <p>Site : 03CH11-HY<br/>Condition : PEAK_BE_74 3m HORN 91200-HF HORIZONTAL</p> | <p>Site : 03CH11-HY<br/>Condition : PEAK_74 3m HORN 91200-HF HORIZONTAL</p> |
| Avg. | <p>Site : 03CH11-HY<br/>Condition : AVG_BE_54 3m HORN 91200-HF HORIZONTAL</p>  | Left blank  |

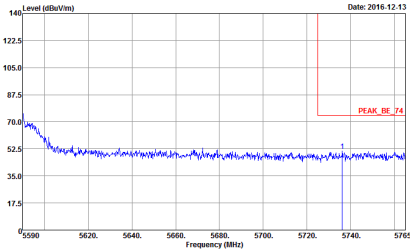
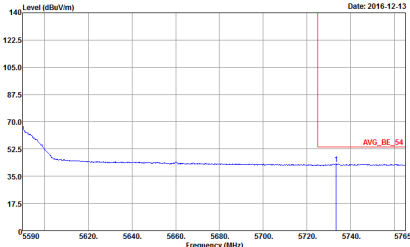

| WIFI | Band 3 5470~5725MHz Band Edge @ 3m  |             |
|------|---|-------------|
| ANT  | 802.11a CH116 5580MHz - R   |             |
| 1    | Horizontal  | Fundamental |
| Peak |  <p>Date: 2016-12-13</p> <p>Site : 03CH11-HY<br/>Condition : PEAK_BE_74 3m HORN 9120D-HF HORIZONTAL</p>  | Left blank  |
| Avg. |  <p>Date: 2016-12-13</p> <p>Site : 03CH11-HY<br/>Condition : AVG_BE_54 3m HORN 9120D-HF HORIZONTAL</p> | Left blank  |



| WIFI | Band 3 5470~5725MHz Band Edge @ 3m   |   |
|------|--|---|
| ANT  | 802.11a CH116 5580MHz - L  |   |
| 1    | Vertical   | Fundamental   |
| Peak | <p>Site : 03CH11-HY<br/>Condition : PEAK_BE_74 3m HORN 9120D-HF VERTICAL</p> | <p>Site : 03CH11-HY<br/>Condition : PEAK_74 3m HORN 9120D-HF VERTICAL</p> |
| Avg. | <p>Site : 03CH11-HY<br/>Condition : AVG_BE_54 3m HORN 9120D-HF VERTICAL</p>  | Left blank  |



| WIFI | Band 3 5470~5725MHz Band Edge @ 3m   |             |
|------|--|-------------|
| ANT  | 802.11a CH116 5580MHz - R  |             |
| 1    | Vertical   | Fundamental |
| Peak | <p>Site : 03CH11-HY<br/>Condition : PEAK_BE_74 3m HORN 9120D-HF VERTICAL</p> | Left blank  |
| Avg. | <p>Site : 03CH11-HY<br/>Condition : AVG_BE_54 3m HORN 9120D-HF VERTICAL</p>  | Left blank  |



| WIFI | Band 3 5470~5725MHz Band Edge @ 3m   |   |
|------|--|---|
| ANT  | 802.11a CH140 5700MHz  |   |
| 1    | Horizontal   | Fundamental   |
| Peak | <p>Site : 03CH11-HY<br/>Condition : PEAK_BE_74 3m HORN 9120D-HF HORIZONTAL</p> | <p>Site : 03CH11-HY<br/>Condition : PEAK_74 3m HORN 9120D-HF HORIZONTAL</p> |
| Avg. | <p>Site : 03CH11-HY<br/>Condition : AVG_BE_54 3m HORN 9120D-HF HORIZONTAL</p>  | Left blank  |



| WIFI | Band 3 5470~5725MHz Band Edge @ 3m   |   |
|------|--|---|
| ANT  | 802.11a CH140 5700MHz  |   |
| 1    | Vertical   | Fundamental   |
| Peak | <p>Site : 03CHI1-HY<br/>Condition : PEAK_BE_74 3m HORN 9120D-HF VERTICAL</p> | <p>Site : 03CHI1-HY<br/>Condition : PEAK_74 3m HORN 9120D-HF VERTICAL</p> |
| Avg. | <p>Site : 03CHI1-HY<br/>Condition : AVG_BE_54 3m HORN 9120D-HF VERTICAL</p>  | Left blank  |



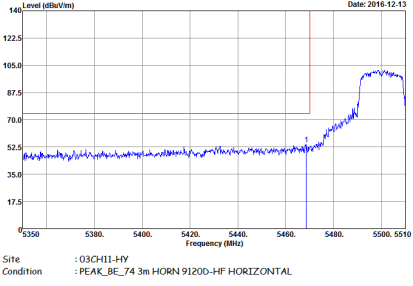
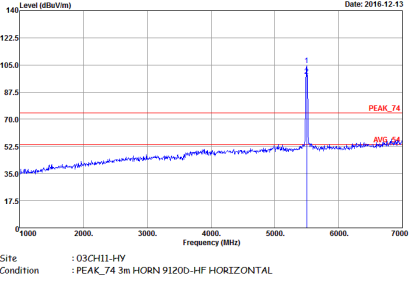
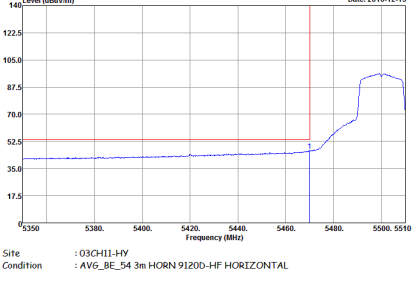

**Band 3 5470~5725MHz  
WIFI 802.11n HT20 (Band Edge @ 3m)**

| WIFI        | Band 3 5470~5725MHz Band Edge @ 3m  |  |
|-------------|---|--|
| ANT         | 802.11n HT20 CH100 5500MHz  |  |
| 1           | Horizontal  | Fundamental  |
| <b>Peak</b> |  <p>Site : 03CH11-HY<br/>Condition : PEAK_BE_74 3m HORN 9120D-HF HORIZONTAL</p>  |  <p>Site : 03CH11-HY<br/>Condition : PEAK_74 3m HORN 9120D-HF HORIZONTAL</p> |
| <b>Avg.</b> |  <p>Site : 03CH11-HY<br/>Condition : AVG_BE_54 3m HORN 9120D-HF HORIZONTAL</p> | Left blank   |



| WIFI | Band 3 5470~5725MHz Band Edge @ 3m   |   |
|------|--|---|
| ANT  | 802.11n HT20 CH100 5500MHz   |   |
| 1    | Vertical   | Fundamental   |
| Peak | <p>Site : 03CH11-HY<br/>Condition : PEAK_BE_74 3m HORN 9120D-HF VERTICAL</p> | <p>Site : 03CH11-HY<br/>Condition : PEAK_74 3m HORN 9120D-HF VERTICAL</p> |
| Avg. | <p>Site : 03CH11-HY<br/>Condition : AVG_BE_54 3m HORN 9120D-HF VERTICAL</p>  | Left blank  |



| WIFI | Band 3 5470~5725MHz Band Edge @ 3m   |   |
|------|--|---|
| ANT  | 802.11n HT20 CH116 5580MHz - L   |   |
| 1    | Horizontal   | Fundamental   |
| Peak | <p>Site : 03CH11-HY<br/>Condition : PEAK_BE_74 3m HORN 91200-HF HORIZONTAL</p> | <p>Site : 03CH11-HY<br/>Condition : PEAK_74 3m HORN 91200-HF HORIZONTAL</p> |
| Avg. | <p>Site : 03CH11-HY<br/>Condition : AVG_BE_54 3m HORN 91200-HF HORIZONTAL</p>  | Left blank  |



| WIFI | Band 3 5470~5725MHz Band Edge @ 3m   |             |
|------|--|-------------|
| ANT  | 802.11n HT20 CH116 5580MHz - R   |             |
| 1    | Horizontal   | Fundamental |
| Peak | <p>Site : 03CH11-HY<br/>Condition : PEAK_BE_74 3m HORN 9120D-HF HORIZONTAL</p> | Left blank  |
| Avg. | <p>Site : 03CH11-HY<br/>Condition : AVG_BE_54 3m HORN 9120D-HF HORIZONTAL</p>  | Left blank  |



| WIFI | Band 3 5470~5725MHz Band Edge @ 3m   |   |
|------|--|---|
| ANT  | 802.11n HT20 CH116 5580MHz - L   |   |
| 1    | Vertical   | Fundamental   |
| Peak | <p>Date: 2016-12-13</p> <p>Site : 03CH11-HY<br/>Condition : PEAK_BE_74 3m HORN 91200-HF VERTICAL</p> | <p>Date: 2016-12-13</p> <p>Site : 03CH11-HY<br/>Condition : PEAK_74 3m HORN 91200-HF VERTICAL</p> |
| Avg. | <p>Date: 2016-12-13</p> <p>Site : 03CH11-HY<br/>Condition : AV6_BE_54 3m HORN 91200-HF VERTICAL</p>  | Left blank  |

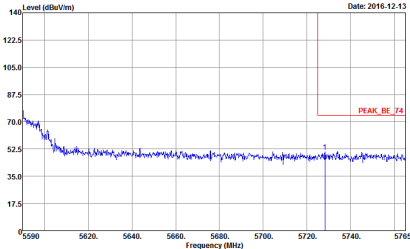
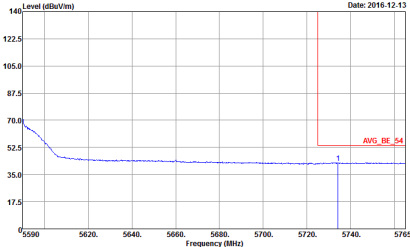

| WIFI | Band 3 5470~5725MHz Band Edge @ 3m  |             |
|------|---|-------------|
| ANT  | 802.11n HT20 CH116 5580MHz - R  |             |
| 1    | Vertical  | Fundamental |
| Peak |  <p>Date: 2016-12-13</p> <p>Site : 03CH11-HY<br/>Condition : PEAK_BE_74 3m HORN 9120D-HF VERTICAL</p>  | Left blank  |
| Avg. |  <p>Date: 2016-12-13</p> <p>Site : 03CH11-HY<br/>Condition : AVG_BE_54 3m HORN 9120D-HF VERTICAL</p> | Left blank  |



| WIFI | Band 3 5470~5725MHz Band Edge @ 3m   |   |
|------|--|---|
| ANT  | 802.11n HT20 CH140 5700MHz   |   |
| 1    | Horizontal   | Fundamental   |
| Peak | <p>Site : 03CH11-HY<br/>Condition : PEAK_BE_74 3m HORN 91200-HF HORIZONTAL</p> | <p>Site : 03CH11-HY<br/>Condition : PEAK_74 3m HORN 91200-HF HORIZONTAL</p> |
| Avg. | <p>Site : 03CH11-HY<br/>Condition : AVG_BE_54 3m HORN 91200-HF HORIZONTAL</p>  | Left blank  |

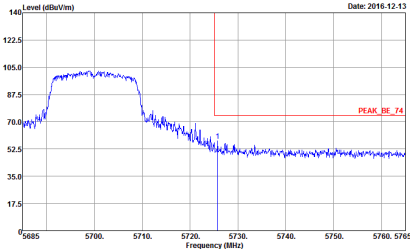
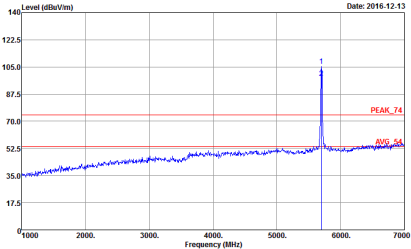
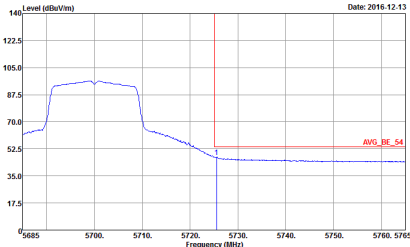

| WIFI  | Band 3 5470~5725MHz Band Edge @ 3m  |  |
|-------|---|--|
| ANT   | 802.11n HT20 CH140 5700MHz  |  |
| 1     | Vertical  | Fundamental  |
| Peak. |  <p>Date: 2016-12-13</p> <p>Site : 03CH11-HY<br/>Condition : PEAK_BE_74 3m HORN 91200-HF VERTICAL</p>  |  <p>Date: 2016-12-13</p> <p>Site : 03CH11-HY<br/>Condition : PEAK_74 3m HORN 91200-HF VERTICAL</p> |
| Avg.  |  <p>Date: 2016-12-13</p> <p>Site : 03CH11-HY<br/>Condition : AVG_BE_54 3m HORN 91200-HF VERTICAL</p> | Left blank   |





**Band 3 5470~5725MHz  
WIFI 802.11n HT40 (Band Edge @ 3m)**

| WIFI               | Band 3 5470~5725MHz Band Edge @ 3m   |   |
|--------------------|--|---|
| ANT                | 802.11n HT40 CH102 5510MHz - L   |   |
| 1                  | Horizontal   | Fundamental   |
| <p><b>Peak</b></p> | <p>Site : 03CH11-HY<br/>Condition : PEAK_BE_74 3m HORN 91200-HF HORIZONTAL</p> | <p>Site : 03CH11-HY<br/>Condition : PEAK_74 3m HORN 91200-HF HORIZONTAL</p> |
| <p><b>Avg.</b></p> | <p>Site : 03CH11-HY<br/>Condition : AVG_BE_54 3m HORN 91200-HF HORIZONTAL</p>  | <p>Left blank</p>   |



| WIFI | Band 3 5470~5725MHz Band Edge @ 3m   |             |
|------|--|-------------|
| ANT  | 802.11n HT40 CH102 5510MHz - R   |             |
| 1    | Horizontal   | Fundamental |
| Peak | <p>Site : 03CH11-HY<br/>Condition : PEAK_BE_74 3m HORN 9120D-HF HORIZONTAL</p> | Left blank  |
| Avg. | <p>Site : 03CH11-HY<br/>Condition : AVG_BE_54 3m HORN 9120D-HF HORIZONTAL</p>  | Left blank  |

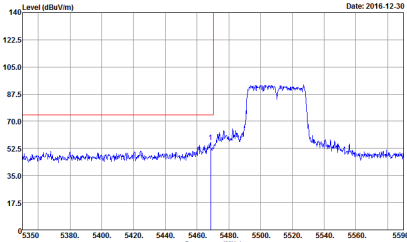
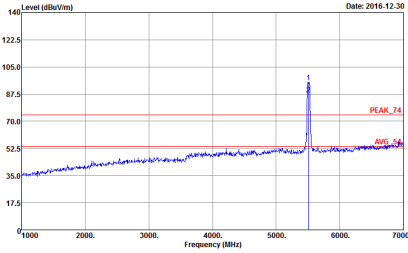
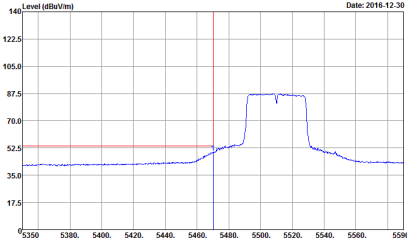

| WIFI | Band 3 5470~5725MHz Band Edge @ 3m  |  |
|------|---|--|
| ANT  | 802.11n HT40 CH102 5510MHz - L  |  |
| 1    | Vertical  | Fundamental  |
| Peak |  <p>Date: 2016-12-30</p> <p>Site : 03CH11-HY<br/>Condition : PEAK_BE_74 3m HORN 91200-HF VERTICAL</p>  |  <p>Date: 2016-12-30</p> <p>Site : 03CH11-HY<br/>Condition : PEAK_74 3m HORN 91200-HF VERTICAL</p> |
| Avg. |  <p>Date: 2016-12-30</p> <p>Site : 03CH11-HY<br/>Condition : AVG_BE_54 3m HORN 91200-HF VERTICAL</p> | Left blank   |



| WIFI | Band 3 5470~5725MHz Band Edge @ 3m   |             |
|------|--|-------------|
| ANT  | 802.11n HT40 CH102 5510MHz - R   |             |
| 1    | Vertical   | Fundamental |
| Peak | <p>Site : 03CH11-HY<br/>Condition : PEAK_BE_74 3m HORN 9120D-HF VERTICAL</p> | Left blank  |
| Avg. | <p>Site : 03CH11-HY<br/>Condition : AVG_BE_54 3m HORN 9120D-HF VERTICAL</p>  | Left blank  |

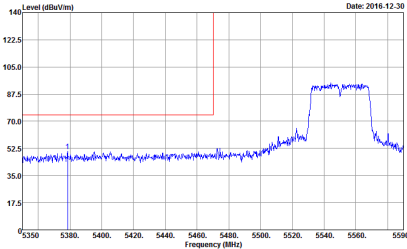
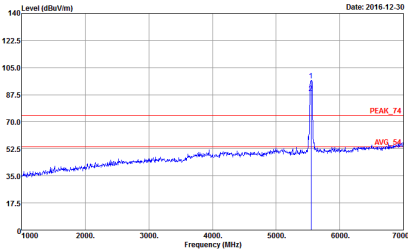
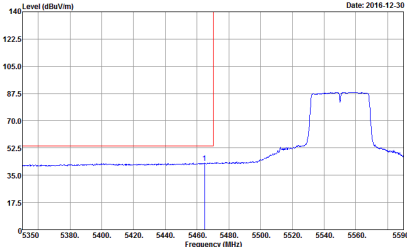

| WIFI | Band 3 5470~5725MHz Band Edge @ 3m  |  |
|------|---|--|
| ANT  | 802.11n HT40 CH110 5550MHz - L  |  |
| 1    | Horizontal  | Fundamental  |
| Peak |  <p>Date: 2016-12-30</p> <p>Site : 03CH11-HY<br/>Condition : PEAK_BE_74 3m HORN 91200-HF HORIZONTAL</p>  |  <p>Date: 2016-12-30</p> <p>Site : 03CH11-HY<br/>Condition : PEAK_74 3m HORN 91200-HF HORIZONTAL</p> |
| Avg. |  <p>Date: 2016-12-30</p> <p>Site : 03CH11-HY<br/>Condition : AVG_BE_54 3m HORN 91200-HF HORIZONTAL</p> | Left blank   |



| WIFI | Band 3 5470~5725MHz Band Edge @ 3m   |             |
|------|--|-------------|
| ANT  | 802.11n HT40 CH110 5550MHz - R   |             |
| 1    | Horizontal   | Fundamental |
| Peak | <p>Site : 03CH11-HY<br/>Condition : PEAK_BE_74 3m HORN 9120D-HF HORIZONTAL</p> | Left blank  |
| Avg. | <p>Site : 03CH11-HY<br/>Condition : AVG_BE_54 3m HORN 9120D-HF HORIZONTAL</p>  | Left blank  |



| WIFI | Band 3 5470~5725MHz Band Edge @ 3m   |   |
|------|--|---|
| ANT  | 802.11n HT40 CH110 5550MHz - L   |   |
| 1    | Vertical   | Fundamental   |
| Peak | <p>Date: 2016-12-30</p> <p>Site : 03CH11-HY<br/>Condition : PEAK_BE_74 3m HORN 9120D-HF VERTICAL</p> | <p>Date: 2016-12-30</p> <p>Site : 03CH11-HY<br/>Condition : PEAK_74 3m HORN 9120D-HF VERTICAL</p> |
| Avg. | <p>Date: 2016-12-30</p> <p>Site : 03CH11-HY<br/>Condition : AVG_BE_54 3m HORN 9120D-HF VERTICAL</p>  | Left blank  |



| WIFI | Band 3 5470~5725MHz Band Edge @ 3m   |             |
|------|--|-------------|
| ANT  | 802.11n HT40 CH110 5550MHz - R   |             |
| 1    | Vertical   | Fundamental |
| Peak | <p>Site : 03CH11-HY<br/>Condition : PEAK_BE_74 3m HORN 9120D-HF VERTICAL</p> | Left blank  |
| Avg. | <p>Site : 03CH11-HY<br/>Condition : AVG_BE_54 3m HORN 9120D-HF VERTICAL</p>  | Left blank  |





| WIFI | Band 3 5470~5725MHz Band Edge @ 3m   |   |
|------|--|---|
| ANT  | 802.11n HT40 CH134 5670MHz - L   |   |
| 1    | Horizontal   | Fundamental   |
| Peak | <p>Site : 03CH11-HY<br/>Condition : PEAK_BE_74 3m HORN 91200-HF HORIZONTAL</p> | <p>Site : 03CH11-HY<br/>Condition : PEAK_74 3m HORN 91200-HF HORIZONTAL</p> |
| Avg. | <p>Site : 03CH11-HY<br/>Condition : AVG_BE_54 3m HORN 91200-HF HORIZONTAL</p>  | Left blank  |



| WIFI | Band 3 5470~5725MHz Band Edge @ 3m   |             |
|------|--|-------------|
| ANT  | 802.11n HT40 CH134 5670MHz - R   |             |
| 1    | Horizontal   | Fundamental |
| Peak | <p>Site : 03CH11-HY<br/>Condition : PEAK_BE_74 3m HORN 9120D-HF HORIZONTAL</p> | Left blank  |
| Avg. | <p>Site : 03CH11-HY<br/>Condition : AVG_BE_54 3m HORN 9120D-HF HORIZONTAL</p>  | Left blank  |



| WIFI | Band 3 5470~5725MHz Band Edge @ 3m   |   |
|------|--|---|
| ANT  | 802.11n HT40 CH134 5670MHz - L   |   |
| 1    | Vertical   | Fundamental   |
| Peak | <p>Site : 03CH11-HY<br/>Condition : PEAK_BE_74 3m HORN 91200-HF VERTICAL</p> | <p>Site : 03CH11-HY<br/>Condition : PEAK_74 3m HORN 91200-HF VERTICAL</p> |
| Avg. | <p>Site : 03CH11-HY<br/>Condition : AVG_BE_54 3m HORN 91200-HF VERTICAL</p>  | Left blank  |



| WIFI | Band 3 5470~5725MHz Band Edge @ 3m   |             |
|------|--|-------------|
| ANT  | 802.11n HT40 CH134 5670MHz - R   |             |
| 1    | Vertical   | Fundamental |
| Peak | <p>Site : 03CH11-HY<br/>Condition : PEAK_BE_74 3m HORN 9120D-HF VERTICAL</p> | Left blank  |
| Avg. | <p>Site : 03CH11-HY<br/>Condition : AVG_BE_54 3m HORN 9120D-HF VERTICAL</p>  | Left blank  |



Band 3 - 5470~5725MHz

WIFI 802.11a (Harmonic @ 3m)

| WIFI      | Band 3 5470~5725MHz Harmonic @ 3m  |  |
|-----------|--|--|
| ANT       | 802.11a CH100 5500MHz  |  |
| 1         | Horizontal   | Vertical   |
| Peak Avg. | <p>Site : 03CH11-HY<br/>Condition : PEAK_74 3m 9170 SHF HORM_150809 HORIZONTAL</p> | <p>Site : 03CH11-HY<br/>Condition : PEAK_74 3m 9170 SHF HORM_150809 VERTICAL</p> |



| WIFI      | Band 3 5470~5725MHz Harmonic @ 3m  |  |
|-----------|--|--|
| ANT       | 802.11a CH116 5580MHz  |  |
| 1         | Horizontal   | Vertical   |
| Peak Avg. | <p>Site : 03CH11-HY<br/>Condition : PEAK_74 3m 9170 SHF HORM_150809 HORIZONTAL</p> | <p>Site : 03CH11-HY<br/>Condition : PEAK_74 3m 9170 SHF HORM_150809 VERTICAL</p> |



| WIFI      | Band 3 5470~5725MHz Harmonic @ 3m  |  |
|-----------|--|--|
| ANT       | 802.11a CH140 5700MHz  |  |
| 1         | Horizontal   | Vertical   |
| Peak Avg. | <p>Site : 03CH11-HY<br/>Condition : PEAK_74 3m 9170 SHF HORM_150809 HORIZONTAL</p> | <p>Site : 03CH11-HY<br/>Condition : PEAK_74 3m 9170 SHF HORM_150809 VERTICAL</p> |



**Band 3 5470~5725MHz  
WIFI 802.11n HT20 (Harmonic @ 3m)**

| WIFI                        | Band 3 5470~5725MHz Harmonic @ 3m  |  |
|-----------------------------|--|--|
| ANT                         | 802.11n HT20 CH100 5500MHz   |  |
| 1                           | Horizontal   | Vertical   |
| <p><b>Peak<br/>Avg.</b></p> | <p>Site : 03CH11-HY<br/>Condition : PEAK_74 3m 9170 SHF HORM_150809 HORIZONTAL</p> | <p>Site : 03CH11-HY<br/>Condition : PEAK_74 3m 9170 SHF HORM_150809 VERTICAL</p> |





| WIFI      | Band 3 5470~5725MHz Harmonic @ 3m  |  |
|-----------|--|--|
| ANT       | 802.11n HT20 CH116 5580MHz   |  |
| 1         | Horizontal   | Vertical   |
| Peak Avg. | <p>Site : 03CH11-HY<br/>Condition : PEAK_74 3m 9170 SHF HORM_150809 HORIZONTAL</p> | <p>Site : 03CH11-HY<br/>Condition : PEAK_74 3m 9170 SHF HORM_150809 VERTICAL</p> |

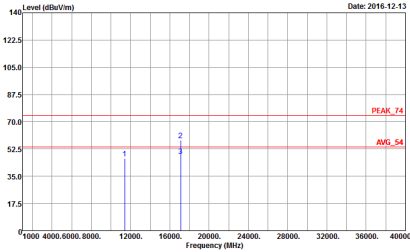
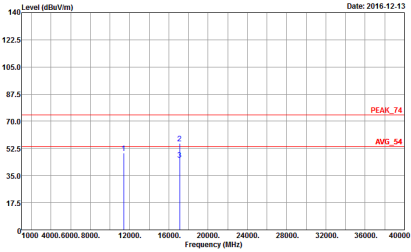

|           |  |   |
|-----------|--|---|
| WIFI      | Band 3 5470~5725MHz Harmonic @ 3m  |   |
| ANT       | 802.11n HT20 CH140 5700MHz   |   |
| 1         | Horizontal   | Vertical  |
| Peak Avg. |  <p>Site : 03CH11-HY<br/>Condition : PEAK_74 3m 9170 SHF HORM_150809 HORIZONTAL</p> |  <p>Site : 03CH11-HY<br/>Condition : PEAK_74 3m 9170 SHF HORM_150809 VERTICAL</p> |



Band 3 5470~5725MHz  
WIFI 802.11n HT40 (Harmonic @ 3m)

| WIFI         | Band 3 5470~5725MHz Harmonic @ 3m  |  |
|--------------|--|--|
| ANT          | 802.11n HT40 CH102 5510MHz   |  |
| 1            | Horizontal   | Vertical   |
| Peak<br>Avg. | <p>Site : 03CH11-HY<br/>Condition : PEAK_74 3m 9170 SHF HORM_150809 HORIZONTAL</p> | <p>Site : 03CH11-HY<br/>Condition : PEAK_74 3m 9170 SHF HORM_150809 VERTICAL</p> |

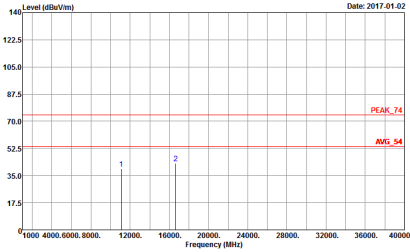
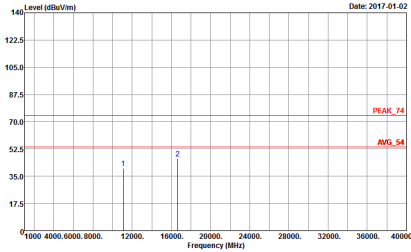

|           |  |   |
|-----------|--|---|
| WIFI      | Band 3 5470~5725MHz Harmonic @ 3m  |   |
| ANT       | 802.11n HT40 CH110 5550MHz   |   |
| 1         | Horizontal   | Vertical  |
| Peak Avg. |  <p>Site : 03CH11-HY<br/>Condition : PEAK_74 3m 9170 SHF HORM_150809 HORIZONTAL</p> |  <p>Site : 03CH11-HY<br/>Condition : PEAK_74 3m 9170 SHF HORM_150809 VERTICAL</p> |



| WIFI      | Band 3 5470~5725MHz Harmonic @ 3m  |  |
|-----------|--|--|
| ANT       | 802.11n HT40 CH134 5670MHz   |  |
| 1         | Horizontal   | Vertical   |
| Peak Avg. | <p>Site : 03CH11-HY<br/>Condition : PEAK_74 3m 9170 SHF HORM_150809 HORIZONTAL</p> | <p>Site : 03CH11-HY<br/>Condition : PEAK_74 3m 9170 SHF HORM_150809 VERTICAL</p> |



Emission below 1GHz

5GHz WIFI 802.11a (LF)

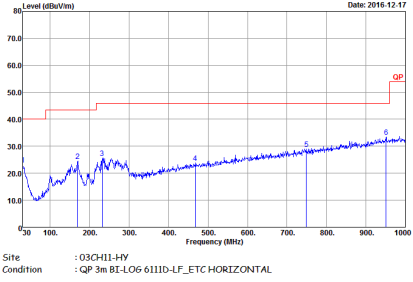
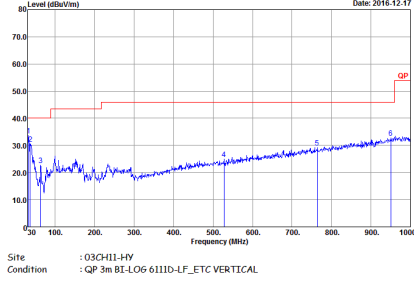
| WIFI         | 5GHz WIFI  |   |
|--------------|--|---|
| ANT          | 802.11a LF   |   |
| 1            | Horizontal   | Vertical  |
| QP /<br>Peak |  <p>Site : 03CH11-HY<br/>Condition : QP 3m BI-LOG 6111D-LF_ETC HORIZONTAL</p> |  <p>Site : 03CH11-HY<br/>Condition : QP 3m BI-LOG 6111D-LF_ETC VERTICAL</p> |



Emission below 1GHz  
5GHz WIFI 802.11n HT20 (LF)

| WIFI         | 5GHz WIFI  |  |
|--------------|--|--|
| ANT          | 802.11n HT20 LF  |  |
| 1            | Horizontal   | Vertical   |
| QP /<br>Peak | <p>Site : 03CH11-HY<br/>Condition : QP 3m BI-LOG 6111D-LF_ETC HORIZONTAL</p> | <p>Site : 03CH11-HY<br/>Condition : QP 3m BI-LOG 6111D-LF_ETC VERTICAL</p> |



Emission below 1GHz  
5GHz WIFI 802.11n HT40 (LF)

| WIFI         | 5GHz WIFI  |  |
|--------------|--|--|
| ANT          | 802.11n HT40 LF  |  |
| 1            | Horizontal   | Vertical   |
| QP /<br>Peak | <p>Horizontal plot showing Level (dBuV/m) vs Frequency (MHz) from 30 to 1000 MHz. A red line indicates a limit, and a blue line shows the measured signal. A 'QP' label is at the end of the red line. Site: 03CH11-HY, Condition: QP 3m BI-LOG 6111D-LF_ETC HORIZONTAL.</p> | <p>Vertical plot showing Level (dBuV/m) vs Frequency (MHz) from 30 to 1000 MHz. A red line indicates a limit, and a blue line shows the measured signal. A 'QP' label is at the end of the red line. Site: 03CH11-HY, Condition: QP 3m BI-LOG 6111D-LF_ETC VERTICAL.</p> |



## Appendix D Duty Cycle Plots

| Band              | Duty Cycle(%) | T(us) | 1/T(kHz) | VBW Setting |
|-------------------|---------------|-------|----------|-------------|
| 802.11a           | 97.77         | 1434  | 0.70     | 1kHz        |
| 5GHz 802.11n HT20 | 97.02         | 1364  | 0.73     | 1kHz        |
| 5GHz 802.11n HT40 | 94.37         | 682   | 1.47     | 3kHz        |

### 802.11a

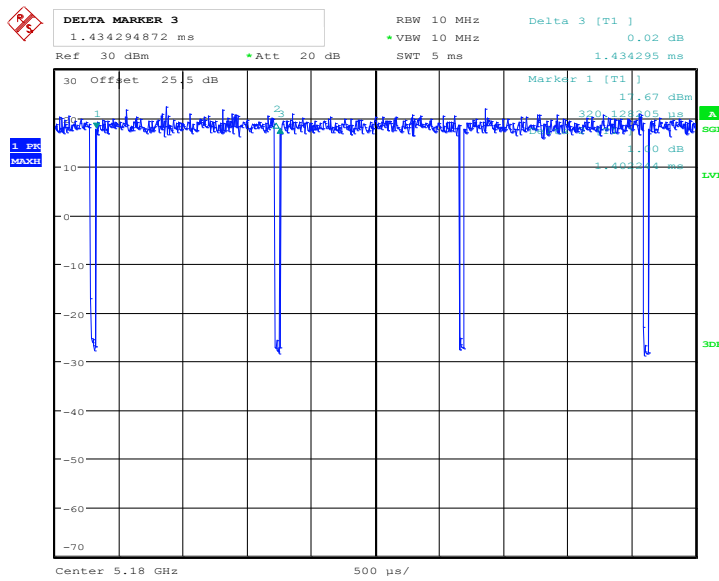

Date: 3.DEC.2016 01:08:41



5GHz 802.11n HT20

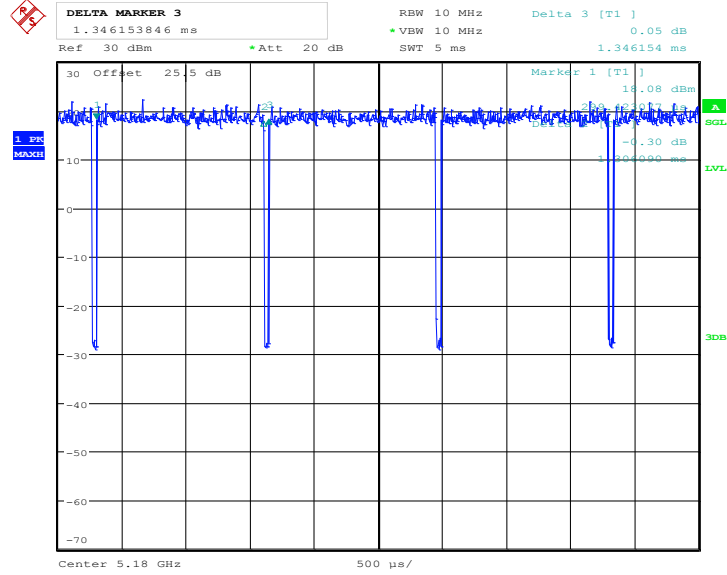

Date: 3.DEC.2016 01:10:00

5GHz 802.11n HT40

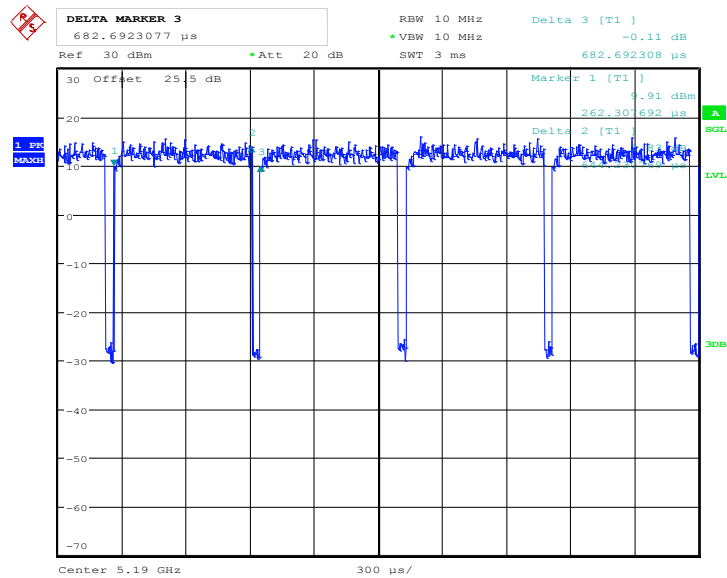

Date: 3.DEC.2016 01:12:25