



# FCC RF Test Report

**APPLICANT** : Sony Mobile Communications Inc.  
**EQUIPMENT** : GSM/WCDMA/LTE Phone+Bluetooth, DTS/UNII  
a/b/g/n and NFC  
**BRAND NAME** : Sony  
**FCC ID** : PY7-10710W  
**STANDARD** : FCC 47 CFR Part 2, 22(H), 24(E)  
**CLASSIFICATION** : PCS Licensed Transmitter Held to Ear (PCE)

The product was received on Nov. 22, 2016 and testing was completed on Dec. 19, 2016. We, SPORTON INTERNATIONAL INC., would like to declare that the tested sample has been evaluated in accordance with the test procedures given in ANSI / TIA / EIA-603-D-2010 and has been in compliance with the applicable technical standards.

The test results in this report apply exclusively to the tested model / sample. Without written approval of SPORTON INTERNATIONAL INC., the test report shall not be reproduced except in full.

Reviewed by: Joseph Lin / Supervisor

Approved by: Jones Tsai / Manager



## **SPORTON INTERNATIONAL INC.**

**No. 52, Hwa Ya 1<sup>st</sup> Rd., Hwa Ya Technology Park, Kwei-Shan District, Tao Yuan City, Taiwan, R.O.C.**

**SPORTON INTERNATIONAL INC.**

TEL : 886-3-327-3456

FAX : 886-3-328-4978

FCC ID : PY7-10710W

Page Number : 1 of 23

Report Issued Date : Feb. 21, 2017

Report Version : Rev. 01

Report Template No.: BU5-FG22/24/27 Version 1.2



# TABLE OF CONTENTS

**REVISION HISTORY ..... 3**

**SUMMARY OF TEST RESULT ..... 4**

**1 GENERAL DESCRIPTION ..... 5**

    1.1 Applicant..... 5

    1.2 Manufacturer ..... 5

    1.3 Product Feature of Equipment Under Test ..... 5

    1.4 Modification of EUT ..... 5

    1.5 Maximum ERP/EIRP Power, Frequency Tolerance, and Emission Designator ..... 6

    1.6 Testing Location ..... 7

    1.7 Applicable Standards ..... 8

**2 TEST CONFIGURATION OF EQUIPMENT UNDER TEST ..... 9**

    2.1 Test Mode..... 9

    2.2 Connection Diagram of Test System ..... 10

    2.3 Support Unit used in test configuration ..... 10

    2.4 Measurement Results Explanation Example ..... 10

    2.5 Frequency List of Low/Middle/High Channels ..... 11

**3 CONDUCTED TEST RESULT ..... 12**

    3.1 Measuring Instruments..... 12

    3.2 Test Setup ..... 12

    3.3 Test Result of Conducted Test..... 12

    3.4 Conducted Output Power and ERP/EIRP ..... 13

    3.5 Peak-to-Average Ratio ..... 14

    3.6 99% Occupied Bandwidth and 26dB Bandwidth Measurement..... 15

    3.7 Conducted Band Edge ..... 16

    3.8 Conducted Spurious Emission ..... 17

    3.9 Frequency Stability ..... 18

**4 RADIATED TEST ITEMS ..... 19**

    4.1 Measuring Instruments..... 19

    4.2 Test Setup ..... 19

    4.3 Test Result of Radiated Test..... 19

    4.4 Field Strength of Spurious Radiation Measurement ..... 20

**5 LIST OF MEASURING EQUIPMENT ..... 21**

**6 UNCERTAINTY OF EVALUATION ..... 23**

**APPENDIX A. TEST RESULTS OF CONDUCTED TEST**

**APPENDIX B. TEST RESULTS OF ERP/EIRP AND RADIATED TEST**



### REVISION HISTORY

REPORT NO.	VERSION	DESCRIPTION	ISSUED DATE
FG6N2204-01A	Rev. 01	Initial issue of report	Feb. 21, 2017



### SUMMARY OF TEST RESULT

Report Section	FCC Rule	Description	Limit	Result	Remark
3.4	§2.1046	Conducted Output Power	Reporting Only	PASS	-
	§22.913(a)(2)	Effective Radiated Power	< 7 Watts		
	§24.232(c)	Equivalent Isotropic Radiated Power	< 2 Watts		
3.5	§24.232(d)	Peak-to-Average Ratio	< 13 dB	PASS	-
3.6	§2.1049 §22.917(b) §24.238(b)	Occupied Bandwidth	Reporting Only	PASS	-
3.7	§2.1051 §22.917(a) §24.238(a)	Band Edge Measurement	< 43+10log10(P[Watts])	PASS	-
3.8	§2.1051 §22.917(a) §24.238(a)	Conducted Emission	< 43+10log10(P[Watts])	PASS	-
3.9	§2.1055 §22.355	Frequency Stability for Temperature & Voltage	< 2.5 ppm for Part 22	PASS	-
	§2.1055 §24.235		Within Authorized Band		
4.4	§2.1053 §22.917(a) §24.238(a)	Field Strength of Spurious Radiation	< 43+10log10(P[Watts])	PASS	Under limit 20.49 dB at 4120.000 MHz



# 1 General Description

## 1.1 Applicant

Sony Mobile Communications Inc.

4-12-3 Higashi-Shinagawa, Shinagawa-ku, Tokyo, 140-0002, Japan

## 1.2 Manufacturer

Sony Mobile Communications Inc.

4-12-3 Higashi-Shinagawa, Shinagawa-ku, Tokyo, 140-0002, Japan

## 1.3 Product Feature of Equipment Under Test

GSM/WCDMA/LTE, Bluetooth, DTS/UNII, a/b/g/n, GPS and NFC

Product Specification subjective to this standard	
Antenna Type	Coupling type (LDS) Antenna

EUT Information List			
HW Version	SW Version	S/N	Performed Test Item
A	0.79	RQ3003DTGD	Conducted Measurement ERP/EIRP Test
		RQ3003DQ82	Radiated Spurious Emission

Accessory List	
AC Adapter 1	Model No. : UCH20
	S/N : 1215W48600062
Earphone 1	Model No. : MH410c
	S/N :1632A866000019E
USB Cable	Model No. : UCB20
	S/N : 1625A9150003A0C

**Note:**

1. Above EUT list and accessory list used are electrically identical per declared by manufacturer.
2. Above the accessories list are used to exercise the EUT during test.
3. For other wireless features of this EUT, test report will be issued separately.

## 1.4 Modification of EUT

No modifications are made to the EUT during all test items.



### 1.5 Maximum ERP/EIRP Power, Frequency Tolerance, and Emission Designator

FCC Rule	Frequency Range (MHz)	System	Type of Modulation	Maximum ERP/EIRP (W)	Frequency Tolerance (ppm)	Emission Designator
Part 22	824.2 ~848.8	GSM850 GPRS class 8	GMSK	0.5636	0.0287 ppm	248KGXW
Part 22	824.2 ~848.8	GSM850 EDGE class 8	8PSK	0.1466	0.0454 ppm	249KG7W
Part 22	826.4 ~846.6	WCDMA Band V RMC 12.2Kbps	BPSK	0.0818	0.0154 ppm	4M20F9W
Part 24	1850.2 ~1909.8	GSM1900 GPRS class 8	GMSK	1.2764	0.0271 ppm	251KGXW
Part 24	1850.2 ~1909.8	GSM1900 EDGE class 8	8PSK	0.4732	0.0048 ppm	249KG7W
Part 24	1852.4 ~ 1907.6	WCDMA Band II RMC 12.2Kbps	BPSK	0.2366	0.0060 ppm	4M17F9W



## 1.6 Testing Location

Sporton Lab is accredited to ISO 17025 by Taiwan Accreditation Foundation (TAF code : 1190) and the FCC designation No. TW0007 under the FCC 2.948(e) by Mutual Recognition Agreement (MRA) in FCC Test.

<b>Test Site</b>	SPORTON INTERNATIONAL INC.
<b>Test Site Location</b>	No. 52, Hwa Ya 1 <sup>st</sup> Rd., Hwa Ya Technology Park, Kwei-Shan District, Tao Yuan City, Taiwan, R.O.C. TEL: +886-3-327-3456 FAX: +886-3-328-4978
<b>Test Site No.</b>	<b>Sporton Site No.</b>
	TH03-HY

<b>Test Site</b>	SPORTON INTERNATIONAL INC.
<b>Test Site Location</b>	No.58, Aly. 75, Ln. 564, Wenhua 3rd Rd. Guishan Dist, Taoyuan City, Taiwan (R.O.C.) TEL: +886-3-327-0868 FAX: +886-3-327-0855
<b>Test Site No.</b>	<b>Sporton Site No.</b>
	03CH10-HY



## 1.7 Applicable Standards

According to the specifications of the manufacturer, the EUT must comply with the requirements of the following standards:

- ♦ 47 CFR Part 2, 22(H), 24(E)
- ♦ ANSI / TIA / EIA-603-D-2010
- ♦ FCC KDB 971168 D01 Power Meas. License Digital Systems v02r02
- ♦ FCC KDB 412172 D01 Determining ERP and EIRP v01r01

### **Remark:**

1. All test items were verified and recorded according to the standards and without any deviation during the test.
2. This EUT has also been tested and complied with the requirements of FCC Part 15, Subpart B, recorded in a separate test report.





## 2 Test Configuration of Equipment Under Test

### 2.1 Test Mode

Antenna port conducted and radiated test items were performed according to KDB 971168 D01 Power Meas. License Digital Systems v02r02 with maximum output power.

Radiated measurements were performed with rotating EUT in different three orthogonal test planes to find the maximum emission.

Radiated emissions were investigated as following frequency range:

1. 30 MHz to 9000 MHz for GSM850 and WCDMA Band V.
2. 30 MHz to 19100 MHz for GSM1900 and WCDMA Band II.

All modes and data rates and positions were investigated.

Test modes are chosen to be reported as the worst case configuration below:

Test Modes		
Band	Radiated TCs	Conducted TCs
GSM 850	<ul style="list-style-type: none"> <li>■ GPRS class 8 Link</li> <li>■ EDGE class 8 Link</li> </ul>	<ul style="list-style-type: none"> <li>■ GPRS class 8 Link</li> <li>■ EDGE class 8 Link</li> </ul>
GSM 1900	<ul style="list-style-type: none"> <li>■ GPRS class 8 Link</li> <li>■ EDGE class 8 Link</li> </ul>	<ul style="list-style-type: none"> <li>■ GPRS class 8 Link</li> <li>■ EDGE class 8 Link</li> </ul>
WCDMA Band V	<ul style="list-style-type: none"> <li>■ RMC 12.2Kbps Link</li> </ul>	<ul style="list-style-type: none"> <li>■ RMC 12.2Kbps Link</li> </ul>
WCDMA Band II	<ul style="list-style-type: none"> <li>■ RMC 12.2Kbps Link</li> </ul>	<ul style="list-style-type: none"> <li>■ RMC 12.2Kbps Link</li> </ul>

## 2.2 Connection Diagram of Test System

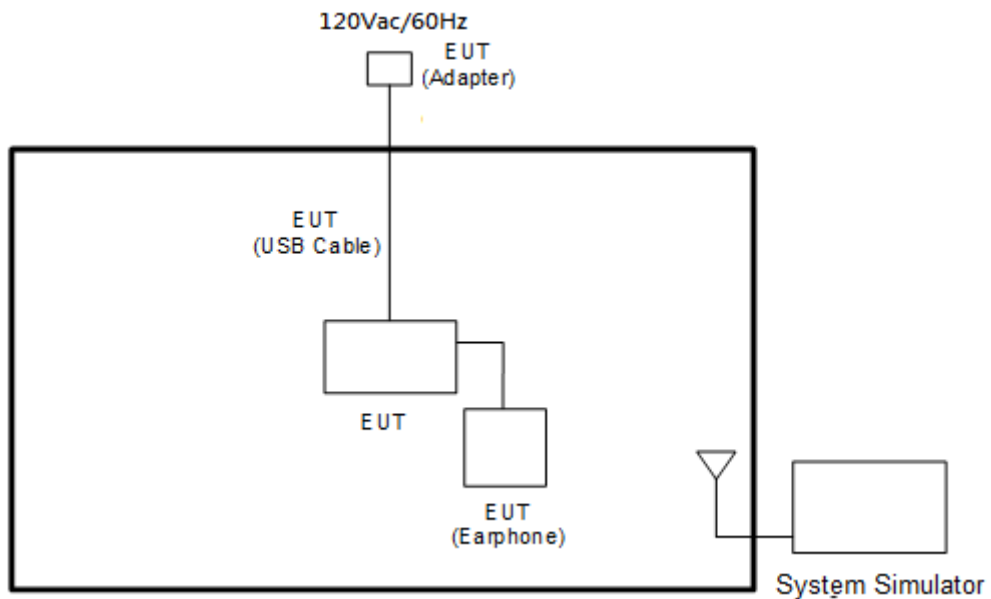

## 2.3 Support Unit used in test configuration

Item	Equipment	Trade Name	Model No.	FCC ID	Data Cable	Power Cord
1.	System Simulator	R&S	CMU 200	N/A	N/A	Unshielded, 1.8 m

## 2.4 Measurement Results Explanation Example

### For all conducted test items:

The offset level is set in the spectrum analyzer to compensate the RF cable loss and attenuator factor between RF conducted output port and spectrum analyzer. With the offset compensation, the spectrum analyzer reading level will be exactly the RF output level.

The spectrum analyzer offset is derived from RF cable loss and attenuator factor.

*Offset = RF cable loss + attenuator factor.*

The following shows an offset computation example with RF cable loss 4.2 dB and a 10dB attenuator.

Example :

*Offset(dB) = RF cable loss(dB) + attenuator factor(dB).*

$$= 4.2 + 10 = 14.2 \text{ (dB)}$$



## 2.5 Frequency List of Low/Middle/High Channels

Frequency List				
Band	Channel/Frequency(MHz)	Lowest	Middle	Highest
GSM850	Channel	128	189	251
	Frequency	824.2	836.4	848.8
WCDMA Band V	Channel	4132	4182	4233
	Frequency	826.4	836.4	846.6
GSM1900	Channel	512	661	810
	Frequency	1850.2	1880.0	1909.8
WCDMA Band II	Channel	9262	9400	9538
	Frequency	1852.4	1880.0	1907.6
WCDMA Band IV	Channel	1312	1413	1513
	Frequency	1712.4	1732.6	1752.6

### 3 Conducted Test Result

#### 3.1 Measuring Instruments

See list of measuring instruments of this test report.

#### 3.2 Test Setup

##### 3.2.1 Conducted Output Power

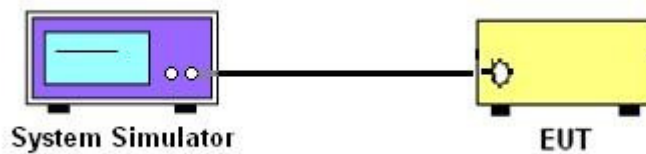

##### 3.2.2 Peak-to-Average Ratio, Occupied Bandwidth, Conducted Band-Edge and Conducted Spurious Emission

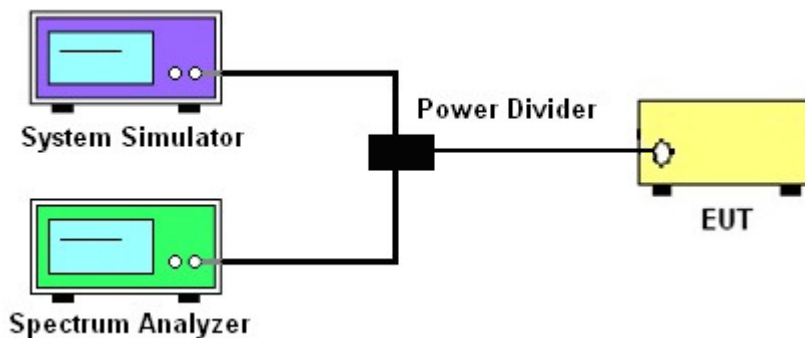

##### 3.2.3 Frequency Stability

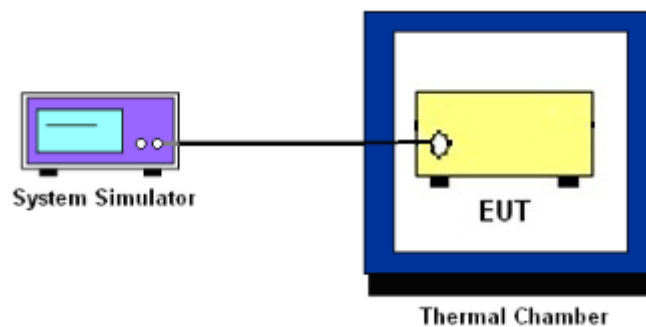

### 3.3 Test Result of Conducted Test

Please refer to Appendix A.



### 3.4 Conducted Output Power and ERP/EIRP

#### 3.4.1 Description of the Conducted Output Power and ERP/EIRP

A system simulator was used to establish communication with the EUT. Its parameters were set to enforce EUT transmitting at the maximum power. The measured power in the radio frequency on the transmitter output terminals shall be reported.

The ERP of mobile transmitters must not exceed 7 Watts for GSM850 and WCDMA Band V.

The EIRP of mobile transmitters must not exceed 2 Watts for GSM1900 and WCDMA Band II.

According to KDB 412172 D01 Power Approach,

$EIRP = P_T + G_T - L_C$ ,  $ERP = EIRP - 2.15$ , where

$P_T$  = transmitter output power in dBm

$G_T$  = gain of the transmitting antenna in dBi

$L_C$  = signal attenuation in the connecting cable between the transmitter and antenna in dB

#### 3.4.2 Test Procedures

1. The transmitter output port was connected to the system simulator.
2. Set EUT at maximum power through system simulator.
3. Select lowest, middle, and highest channels for each band and different modulation.
4. Measure the maximum burst average power for GSM and maximum average power for other modulation signal.



## **3.5 Peak-to-Average Ratio**

### **3.5.1 Description of the PAR Measurement**

The peak-to-average ratio (PAR) of the transmission may not exceed 13 dB.

### **3.5.2 Test Procedures**

1. The testing follows FCC KDB 971168 D01 v02r02 Section 5.7.1.
2. The EUT was connected to spectrum analyzer and system simulator via a power divider.
3. Set EUT to transmit at maximum output power.
4. When the duty cycle is less than 98%, then signal gating will be implemented on the spectrum analyzer by triggering from the system simulator.
5. Set the CCDF (Complementary Cumulative Distribution Function) option of the spectrum analyzer.  
Record the maximum PAPR level associated with a probability of 0.1%.



### 3.6 99% Occupied Bandwidth and 26dB Bandwidth Measurement

#### 3.6.1 Description of 99% Occupied Bandwidth and 26dB Bandwidth Measurement

The occupied bandwidth is the width of a frequency band such that, below the lower and above the upper frequency limits, the mean powers emitted are each equal to a specified percentage 0.5% of the total mean transmitted power.

The 26 dB emission bandwidth is defined as the frequency range between two points, one above and one below the carrier frequency, at which the spectral density of the emission is attenuated 26 dB below the maximum in-band spectral density of the modulated signal. Spectral density (power per unit bandwidth) is to be measured with a detector of resolution bandwidth equal to approximately 1.0% of the emission bandwidth.

#### 3.6.2 Test Procedures

1. The testing follows FCC KDB 971168 v02r02 Section 4.2.
2. The EUT was connected to spectrum analyzer and system simulator via a power divider.
3. The spectrum analyzer center frequency is set to the nominal EUT channel center frequency. The span range for the spectrum analyzer shall be between two and five times the anticipated OBW.
4. The nominal resolution bandwidth (RBW) shall be in the range of 1 to 5 % of the anticipated OBW, and the VBW shall be at least 3 times the RBW.
5. Set the detection mode to peak, and the trace mode to max hold.
6. Determine the reference value: Set the EUT to transmit a modulated signal. Allow the trace to stabilize. Set the spectrum analyzer marker to the highest level of the displayed trace.  
(this is the reference value)
7. Determine the “-26 dB down amplitude” as equal to (Reference Value – X).
8. Place two markers, one at the lowest and the other at the highest frequency of the envelope of the spectral display such that each marker is at or slightly below the “-X dB down amplitude” determined in step 6. If a marker is below this “-X dB down amplitude” value it shall be placed as close as possible to this value. The OBW is the positive frequency difference between the two markers.
9. Use the 99 % power bandwidth function of the spectrum analyzer and report the measured bandwidth.



## **3.7 Conducted Band Edge**

### **3.7.1 Description of Conducted Band Edge Measurement**

The power of any emission outside of the authorized operating frequency ranges must be lower than the transmitter power (P) by a factor of at least  $43 + 10 \log (P)$  dB.

### **3.7.2 Test Procedures**

1. The testing follows FCC KDB 971168 D01 v02r02 Section 6.0.
2. The EUT was connected to the spectrum analyzer and system simulator via a power divider.
3. The RF output of EUT was connected to the spectrum analyzer by an RF cable and attenuator. The path loss was compensated to the results for each measurement.
4. The band edges of low and high channels for the highest RF powers were measured.
5. The RF fundamental frequency should be excluded against the limit line in the operating frequency band.
6. The limit line is derived from  $43 + 10\log(P)$  dB below the transmitter power P(Watts)





## **3.8 Conducted Spurious Emission**

### **3.8.1 Description of Conducted Spurious Emission Measurement**

The power of any emission outside of the authorized operating frequency ranges must be lower than the transmitter power (P) by a factor of at least  $43 + 10 \log (P)$  dB.

It is measured by means of a calibrated spectrum analyzer and scanned from 30 MHz up to a frequency including its 10<sup>th</sup> harmonic.

### **3.8.2 Test Procedures**

1. The testing follows FCC KDB 971168 D01 v02r02 Section 6.0.
2. The EUT was connected to the spectrum analyzer and system simulator via a power divider.
3. The RF output of EUT was connected to the spectrum analyzer by an RF cable and attenuator. The path loss was compensated to the results for each measurement.
4. The middle channel for the highest RF power within the transmitting frequency was measured.
5. The conducted spurious emission for the whole frequency range was taken.
6. The RF fundamental frequency should be excluded against the limit line in the operating frequency band.
7. The limit line is derived from  $43 + 10\log(P)$  dB below the transmitter power P(Watts)



### 3.9 Frequency Stability

#### 3.9.1 Description of Frequency Stability Measurement

The frequency stability shall be measured by variation of ambient temperature and variation of primary supply voltage to ensure that the fundamental emission stays within the authorized frequency block. The frequency stability of the transmitter shall be maintained within  $\pm 0.00025\%$  ( $\pm 2.5\text{ppm}$ ) of the center frequency.

#### 3.9.2 Test Procedures for Temperature Variation

1. The testing follows FCC KDB 971168 D01 v02r02 Section 9.0.
2. The EUT was set up in the thermal chamber and connected with the system simulator.
3. With power OFF, the temperature was decreased to  $-30^{\circ}\text{C}$  and the EUT was stabilized before testing. Power was applied and the maximum change in frequency was recorded within one minute.
4. With power OFF, the temperature was raised in  $10^{\circ}\text{C}$  steps up to  $50^{\circ}\text{C}$ . The EUT was stabilized at each step for at least half an hour. Power was applied and the maximum frequency change was recorded within one minute.

#### 3.9.3 Test Procedures for Voltage Variation

1. The testing follows FCC KDB 971168 D01 v02r02 Section 9.0.
2. The EUT was placed in a temperature chamber at  $20\pm 5^{\circ}\text{C}$  and connected with the system simulator.
3. The power supply voltage to the EUT was varied from 85% to 115% of the nominal value measured at the input to the EUT.
4. The variation in frequency was measured for the worst case.

## 4 Radiated Test Items

### 4.1 Measuring Instruments

See list of measuring instruments of this test report.

### 4.2 Test Setup

#### 4.2.1 For radiated test from 30MHz to 1GHz

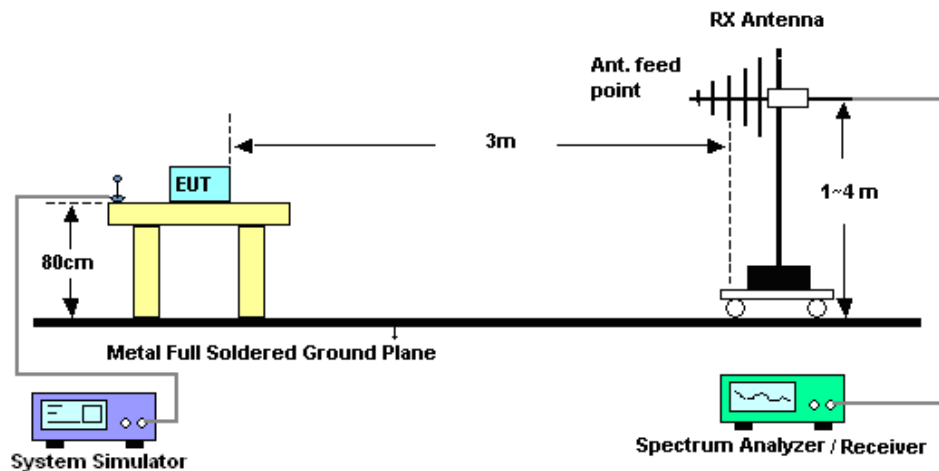

#### 4.2.2 For radiated test above 1GHz

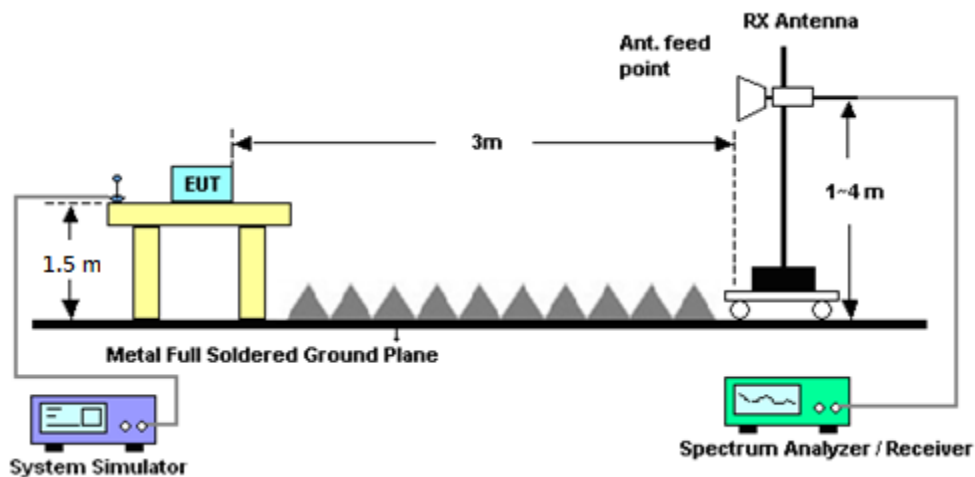

### 4.3 Test Result of Radiated Test

Please refer to Appendix B.



## 4.4 Field Strength of Spurious Radiation Measurement

### 4.4.1 Description of Field Strength of Spurious Radiated Measurement

The power of any emission outside of the authorized operating frequency ranges must be attenuated below the transmitter power (P) by a factor of at least  $43 + 10 \log (P)$  dB. The spectrum is scanned from 30 MHz up to a frequency including its 10th harmonic.

### 4.4.2 Test Procedures

1. The testing follows FCC KDB 971168 D01 v02r02 Section 5.8 and ANSI / TIA-603-D-2010 Section 2.2.12.
2. The EUT was placed on a rotatable wooden table 0.8 meters for frequency below 1GHz and 1.5 meter for frequency above 1GHz above the ground.
3. The EUT was set 3 meters from the receiving antenna, which was mounted on the antenna tower.
4. The table was rotated 360 degrees to determine the position of the highest spurious emission.
5. The height of the receiving antenna is varied between one meter and four meters to search for the maximum spurious emission for both horizontal and vertical polarizations.
6. Make the measurement with the spectrum analyzer's RBW = 1MHz, VBW = 3MHz, taking record of maximum spurious emission.
7. A horn antenna was substituted in place of the EUT and was driven by a signal generator.
8. Tune the output power of signal generator to the same emission level with EUT maximum spurious emission.
9. Taking the record of output power at antenna port.
10. Repeat step 7 to step 8 for another polarization.
11.  $EIRP \text{ (dBm)} = S.G. \text{ Power} - Tx \text{ Cable Loss} + Tx \text{ Antenna Gain}$
12.  $ERP \text{ (dBm)} = EIRP - 2.15$
13. The RF fundamental frequency should be excluded against the limit line in the operating frequency band.
14. The limit line is derived from  $43 + 10\log(P)$  dB below the transmitter power P(Watts)



## 5 List of Measuring Equipment

Instrument	Manufacturer	Model No.	Serial No.	Characteristics	Calibration Date	Test Date	Due Date	Remark
Hygrometer	Testo	608-H1	34893241	N/A	May 03, 2016	Dec. 15, 2016	May 02, 2017	Conducted (TH03-HY)
Spectrum Analyzer	Rohde & Schwarz	FSP30	101329	9kHz~30GHz	Jun. 27, 2016	Dec. 15, 2016	Jun. 26, 2017	Conducted (TH03-HY)
Temperature Chamber	ESPEC	SU-641	92013721	-30℃ ~70℃	Nov. 16, 2016	Dec. 15, 2016	Nov. 15, 2017	Conducted (TH03-HY)
Programmable Power Supply	GW Instek	PSS-2005	EL890001	Voltage:0~20V;Current:0~5A	Oct. 03, 2016	Dec. 15, 2016	Oct. 02, 2017	Conducted (TH03-HY)
Base Station (Measure)	Rohde & Schwarz	CMU200	117995	GSM / GPRS / WCDMA / CDMA	Aug. 03, 2016	Dec. 15, 2016	Aug. 04, 2017	Conducted (TH03-HY)
RF Cable	HUBER + SUHNER	SUCOFLEX 104	MY84209521	1GHz~26GHz	Dec. 02, 2016	Dec. 15, 2016	Dec. 01, 2017	Conducted (TH03-HY)
Bilog Antenna	TESEQ	CBL 6111D&00800N	35413&02	30MHz~1GHz	Jan. 13, 2016	Dec. 08, 2016 ~ Dec. 19, 2016	Jan. 12, 2017	Radiation (03CH10-HY)
Horn Antenna	SCHWARZBECK	BBHA 9120 D	9120D-1325	1GHz ~ 18GHz	Sep. 30, 2016	Dec. 08, 2016 ~ Dec. 19, 2016	Sep. 29, 2017	Radiation (03CH10-HY)
Horn Antenna	SCHWARZBECK	BBHA 9120D	9120D-1328	1GHz ~ 18GHz	Oct. 25, 2016	Dec. 08, 2016 ~ Dec. 19, 2016	Oct. 24, 2017	Radiation (03CH10-HY)
SHF-EHF Horn Antenna	SCHWARZBECK	BBHA 9170	BBHA9170576	18GHz ~ 40GHz	Apr. 15, 2016	Dec. 08, 2016 ~ Dec. 19, 2016	Apr. 14, 2017	Radiation (03CH10-HY)
SHF-EHF Horn Antenna	SCHWARZBECK	BBHA 9170	BBHA9170584	18GHz- 40GHz	Nov. 08, 2016	Dec. 08, 2016 ~ Dec. 19, 2016	Nov. 07, 2017	Radiation (03CH10-HY)
Amplifier	SONOMA	310N	187311	9kHz~1GHz	Oct. 26, 2016	Dec. 08, 2016 ~ Dec. 19, 2016	Oct. 25, 2017	Radiation (03CH10-HY)
Preamplifier	Keysight	83017A	MY53270078	1GHz~26.5GHz	Oct. 26, 2016	Dec. 08, 2016 ~ Dec. 19, 2016	Oct. 25, 2017	Radiation (03CH10-HY)
Preamplifier	MITEQ	JS44-18004000-33-8P	1840917	18GHz ~ 40GHz	Jun. 14, 2016	Dec. 08, 2016 ~ Dec. 19, 2016	Jun. 13, 2017	Radiation (03CH10-HY)
Spectrum Analyzer	Keysight	N9010A	MY54200485	10Hz ~ 44GHz	Oct. 17, 2016	Dec. 08, 2016 ~ Dec. 19, 2016	Oct. 16, 2017	Radiation (03CH10-HY)



Instrument	Manufacturer	Model No.	Serial No.	Characteristics	Calibration Date	Test Date	Due Date	Remark
Controller	EMEC	EM 1000	N/A	Control Turn table & Ant Mast	N/A	Dec. 08, 2016 ~ Dec. 19, 2016	N/A	Radiation (03CH10-HY)
Antenna Mast	EMEC	AM-BS-4500-B	N/A	1~4m	N/A	Dec. 08, 2016 ~ Dec. 19, 2016	N/A	Radiation (03CH10-HY)
Turn Table	EMEC	TT 2200	N/A	0~360 Degree	N/A	Dec. 08, 2016 ~ Dec. 19, 2016	N/A	Radiation (03CH10-HY)
Hygrometer	TECPEL	DTM-303B	TP140320	N/A	Nov. 14, 2016	Dec. 08, 2016 ~ Dec. 19, 2016	Nov. 13, 2017	Radiation (03CH10-HY)
Signal Generator	Rohde & Schwarz	SMF100A	101107	100kHz~40GHz	May 19, 2016	Dec. 08, 2016 ~ Dec. 19, 2016	May 18, 2017	Radiation (03CH10-HY)
RF Cable	HUBER + SUHNER	SUCOFLEX 104	MY249564 MY249524	25GHz~40GHz	Sep. 30, 2016	Dec. 08, 2016 ~ Dec. 19, 2016	Sep. 29, 2017	Radiation (03CH10-HY)
RF Cable	HUBER + SUHNER	SUCOFLEX 104	MY249564 MY249524	30MHz~1GHz	Sep. 30, 2016	Dec. 08, 2016 ~ Dec. 19, 2016	Sep. 29, 2017	Radiation (03CH10-HY)
RF Cable	HUBER + SUHNER	SUCOFLEX 104	MY249564 MY249524	1GHz~25GHz	Sep. 30, 2016	Dec. 08, 2016 ~ Dec. 19, 2016	Sep. 29, 2017	Radiation (03CH10-HY)
Filter	Wainwright	WHKX12-1080-1200-1500-60S	SN2	1.2G High Pass	Sep. 19, 2016	Dec. 08, 2016 ~ Dec. 19, 2016	Sep. 18, 2017	Radiation (03CH10-HY)
Filter	Wainwright	WLKS1200-12SS	SN2	1.2G Low Pass	Sep. 19, 2016	Dec. 08, 2016 ~ Dec. 19, 2016	Sep. 18, 2017	Radiation (03CH10-HY)
Filter	Wainwright	WHKX12-2700-3000-18000-60	SN2	3.0 G High Pass	Sep. 20, 2016	Dec. 08, 2016 ~ Dec. 19, 2016	Sep. 19, 2017	Radiation (03CH10-HY)
Notch Filter	Wainwright	WTRCT10-1850-1910-20-40-4	SN1	N/A	May 24, 2016	Dec. 08, 2016 ~ Dec. 19, 2016	May 23, 2017	Radiation (03CH10-HY)
Notch Filter	Wainwright	WTRCT10-2500-2570-20-40-4	SN1	N/A	May 24, 2016	Dec. 08, 2016 ~ Dec. 19, 2016	May 23, 2017	Radiation (03CH10-HY)
Notch Filter	Wainwright	WRCT5-835.6-836.3-836.5-83	SN1	N/A	May 24, 2016	Dec. 08, 2016 ~ Dec. 19, 2016	May 23, 2017	Radiation (03CH10-HY)
Test Software	N/A	E3	6.2009-8-24	N/A	N/A	Dec. 08, 2016 ~ Dec. 19, 2016	N/A	Radiation (03CH10-HY)



## 6 Uncertainty of Evaluation

### Uncertainty of Radiated Emission Measurement (30 MHz ~ 1000 MHz)

Measuring Uncertainty for a Level of Confidence of 95% ( $U = 2Uc(y)$ )	5.6
---	-----

### Uncertainty of Radiated Emission Measurement (1 GHz ~ 18 GHz)

Measuring Uncertainty for a Level of Confidence of 95% ( $U = 2Uc(y)$ )	5.9
---	-----

### Uncertainty of Radiated Emission Measurement (18 GHz ~ 40 GHz)

Measuring Uncertainty for a Level of Confidence of 95% ( $U = 2Uc(y)$ )	5.2
---	-----



## Appendix A. Test Results of Conducted Test

### Conducted Output Power(Average power)

Conducted Power (*Unit: dBm)						
Band	GSM850			GSM1900		
Channel	128	189	251	512	661	810
Frequency	824.2	836.4	848.8	1850.2	1880	1909.8
GSM	32.80	32.76	32.69	30.25	30.06	30.13
GPRS class 8	33.05	<b>33.06</b>	32.97	<b>30.26</b>	30.08	30.15
GPRS class 10	30.44	30.42	30.38	27.28	27.05	27.19
GPRS class 11	28.66	28.64	28.52	25.52	25.32	25.43
GPRS class 12	27.40	27.37	27.26	24.20	24.01	24.14
EGPRS class 8	27.16	<b>27.21</b>	27.11	25.74	25.71	<b>25.95</b>
EGPRS class 10	26.96	27.02	26.99	25.62	25.50	25.76
EGPRS class 11	26.78	26.83	26.82	25.20	25.07	25.33
EGPRS class 12	26.63	26.64	26.61	24.82	24.71	24.93

Conducted Power (*Unit: dBm)						
Band	WCDMA Band V			WCDMA Band II		
Channel	4132	4182	4233	9262	9400	9538
Frequency	826.4	836.4	846.6	1852.4	1880	1907.6
RMC 12.2K	24.53	24.6	<b>24.68</b>	<b>22.94</b>	22.78	22.73
HSDPA Subtest-1	23.61	23.58	23.66	21.89	21.78	21.72
HSDPA Subtest-2	23.55	23.58	23.67	21.88	21.76	21.74
HSDPA Subtest-3	23.09	23.13	23.17	21.40	21.35	21.27
HSDPA Subtest-4	23.09	23.09	23.19	21.38	21.28	21.29
HSUPA Subtest-1	21.79	21.72	21.88	19.91	19.77	19.69
HSUPA Subtest-2	21.61	21.60	21.68	19.83	19.80	19.73
HSUPA Subtest-3	22.56	22.58	22.66	20.86	20.76	20.72
HSUPA Subtest-4	21.21	21.24	21.29	19.50	19.33	19.31
HSUPA Subtest-5	22.59	22.54	22.65	20.91	20.85	20.82





## A2. GSM

### Peak-to-Average Ratio

Mode	GSM850		Limit: 13dB
Mod.	GPRS class 8	EDGE class 8	Result
Lowest CH	0.16	3.32	PASS
Middle CH	0.12	3.52	
Highest CH	0.12	3.52	

Mode	GSM1900		Limit: 13dB
Mod.	GPRS class 8	EDGE class 8	Result
Lowest CH	0.16	3.60	PASS
Middle CH	0.16	3.44	
Highest CH	0.08	3.48	



GSM850 (GPRS class 8)	GSM850 (EDGE class 8)
<p align="center"><b>Lowest Channel</b></p> <p>Date: 15.DEC.2016 14:39:42</p>	<p align="center"><b>Lowest Channel</b></p> <p>Date: 15.DEC.2016 16:27:05</p>
<p align="center"><b>Middle Channel</b></p> <p>Date: 15.DEC.2016 14:40:32</p>	<p align="center"><b>Middle Channel</b></p> <p>Date: 15.DEC.2016 16:27:56</p>
<p align="center"><b>Highest Channel</b></p> <p>Date: 15.DEC.2016 14:41:17</p>	<p align="center"><b>Highest Channel</b></p> <p>Date: 15.DEC.2016 16:28:57</p>

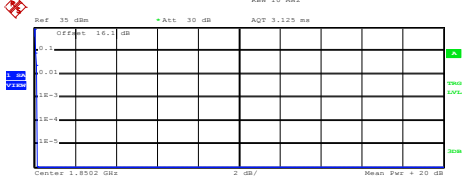
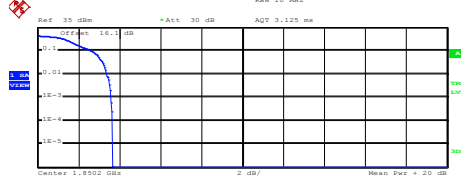
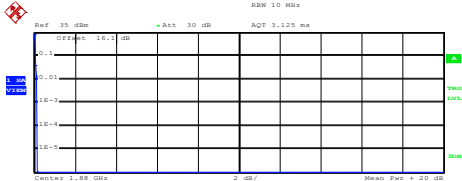
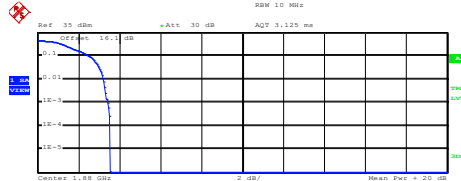
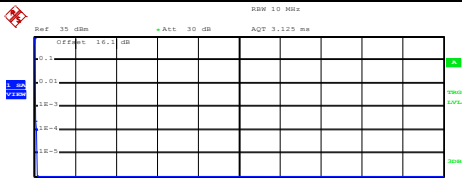
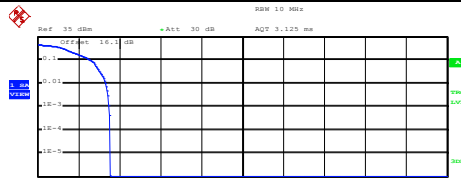

GSM1900 (GPRS class 8)	GSM1900 (EDGE class 8)																
<p style="text-align: center;"><b>Lowest Channel</b></p>  <p>Center 1.8502 GHz    2 dB/    Mean Pwr + 20 dB</p> <p>Complementary Cumulative Distribution Function (100000 samples) Trace 1 Mean 29.26 dBm Peak 29.40 dBm Crest 0.14 dB</p> <table border="1"> <tr><td>10 %</td><td>0.08 dB</td></tr> <tr><td>1 %</td><td>0.16 dB</td></tr> <tr><td>.1 %</td><td>0.16 dB</td></tr> <tr><td>.01 %</td><td>0.16 dB</td></tr> </table> <p>Date: 15.DEC.2016 16:46:52</p>	10 %	0.08 dB	1 %	0.16 dB	.1 %	0.16 dB	.01 %	0.16 dB	<p style="text-align: center;"><b>Lowest Channel</b></p>  <p>Center 1.8502 GHz    2 dB/    Mean Pwr + 20 dB</p> <p>Complementary Cumulative Distribution Function (100000 samples) Trace 1 Mean 24.53 dBm Peak 28.20 dBm Crest 3.67 dB</p> <table border="1"> <tr><td>10 %</td><td>2.64 dB</td></tr> <tr><td>1 %</td><td>3.36 dB</td></tr> <tr><td>.1 %</td><td>3.60 dB</td></tr> <tr><td>.01 %</td><td>3.68 dB</td></tr> </table> <p>Date: 15.DEC.2016 16:59:12</p>	10 %	2.64 dB	1 %	3.36 dB	.1 %	3.60 dB	.01 %	3.68 dB
10 %	0.08 dB																
1 %	0.16 dB																
.1 %	0.16 dB																
.01 %	0.16 dB																
10 %	2.64 dB																
1 %	3.36 dB																
.1 %	3.60 dB																
.01 %	3.68 dB																
<p style="text-align: center;"><b>Middle Channel</b></p>  <p>Center 1.88 GHz    2 dB/    Mean Pwr + 20 dB</p> <p>Complementary Cumulative Distribution Function (100000 samples) Trace 1 Mean 29.04 dBm Peak 29.18 dBm Crest 0.14 dB</p> <table border="1"> <tr><td>10 %</td><td>0.08 dB</td></tr> <tr><td>1 %</td><td>0.12 dB</td></tr> <tr><td>.1 %</td><td>0.16 dB</td></tr> <tr><td>.01 %</td><td>0.16 dB</td></tr> </table> <p>Date: 15.DEC.2016 16:47:26</p>	10 %	0.08 dB	1 %	0.12 dB	.1 %	0.16 dB	.01 %	0.16 dB	<p style="text-align: center;"><b>Middle Channel</b></p>  <p>Center 1.88 GHz    2 dB/    Mean Pwr + 20 dB</p> <p>Complementary Cumulative Distribution Function (100000 samples) Trace 1 Mean 24.58 dBm Peak 28.13 dBm Crest 3.55 dB</p> <table border="1"> <tr><td>10 %</td><td>2.52 dB</td></tr> <tr><td>1 %</td><td>3.20 dB</td></tr> <tr><td>.1 %</td><td>3.44 dB</td></tr> <tr><td>.01 %</td><td>3.56 dB</td></tr> </table> <p>Date: 15.DEC.2016 16:59:58</p>	10 %	2.52 dB	1 %	3.20 dB	.1 %	3.44 dB	.01 %	3.56 dB
10 %	0.08 dB																
1 %	0.12 dB																
.1 %	0.16 dB																
.01 %	0.16 dB																
10 %	2.52 dB																
1 %	3.20 dB																
.1 %	3.44 dB																
.01 %	3.56 dB																
<p style="text-align: center;"><b>Highest Channel</b></p>  <p>Center 1.9098 GHz    2 dB/    Mean Pwr + 20 dB</p> <p>Complementary Cumulative Distribution Function (100000 samples) Trace 1 Mean 29.04 dBm Peak 29.18 dBm Crest 0.15 dB</p> <table border="1"> <tr><td>10 %</td><td>0.08 dB</td></tr> <tr><td>1 %</td><td>0.08 dB</td></tr> <tr><td>.1 %</td><td>0.08 dB</td></tr> <tr><td>.01 %</td><td>0.12 dB</td></tr> </table> <p>Date: 15.DEC.2016 16:48:04</p>	10 %	0.08 dB	1 %	0.08 dB	.1 %	0.08 dB	.01 %	0.12 dB	<p style="text-align: center;"><b>Highest Channel</b></p>  <p>Center 1.9098 GHz    2 dB/    Mean Pwr + 20 dB</p> <p>Complementary Cumulative Distribution Function (100000 samples) Trace 1 Mean 24.57 dBm Peak 28.13 dBm Crest 3.55 dB</p> <table border="1"> <tr><td>10 %</td><td>2.60 dB</td></tr> <tr><td>1 %</td><td>3.32 dB</td></tr> <tr><td>.1 %</td><td>3.48 dB</td></tr> <tr><td>.01 %</td><td>3.56 dB</td></tr> </table> <p>Date: 15.DEC.2016 17:00:40</p>	10 %	2.60 dB	1 %	3.32 dB	.1 %	3.48 dB	.01 %	3.56 dB
10 %	0.08 dB																
1 %	0.08 dB																
.1 %	0.08 dB																
.01 %	0.12 dB																
10 %	2.60 dB																
1 %	3.32 dB																
.1 %	3.48 dB																
.01 %	3.56 dB																



**26dB Bandwidth**

Mode	GSM850 : 26dB BW(MHz)	
Mod.	GPRS class 8	EDGE class 8
Lowest CH	0.302	0.311
Middle CH	0.300	0.310
Highest CH	0.300	0.307

Mode	GSM1900 : 26dB BW(MHz)	
Mod.	GPRS class 8	EDGE class 8
Lowest CH	0.310	0.288
Middle CH	0.298	0.300
Highest CH	0.301	0.294

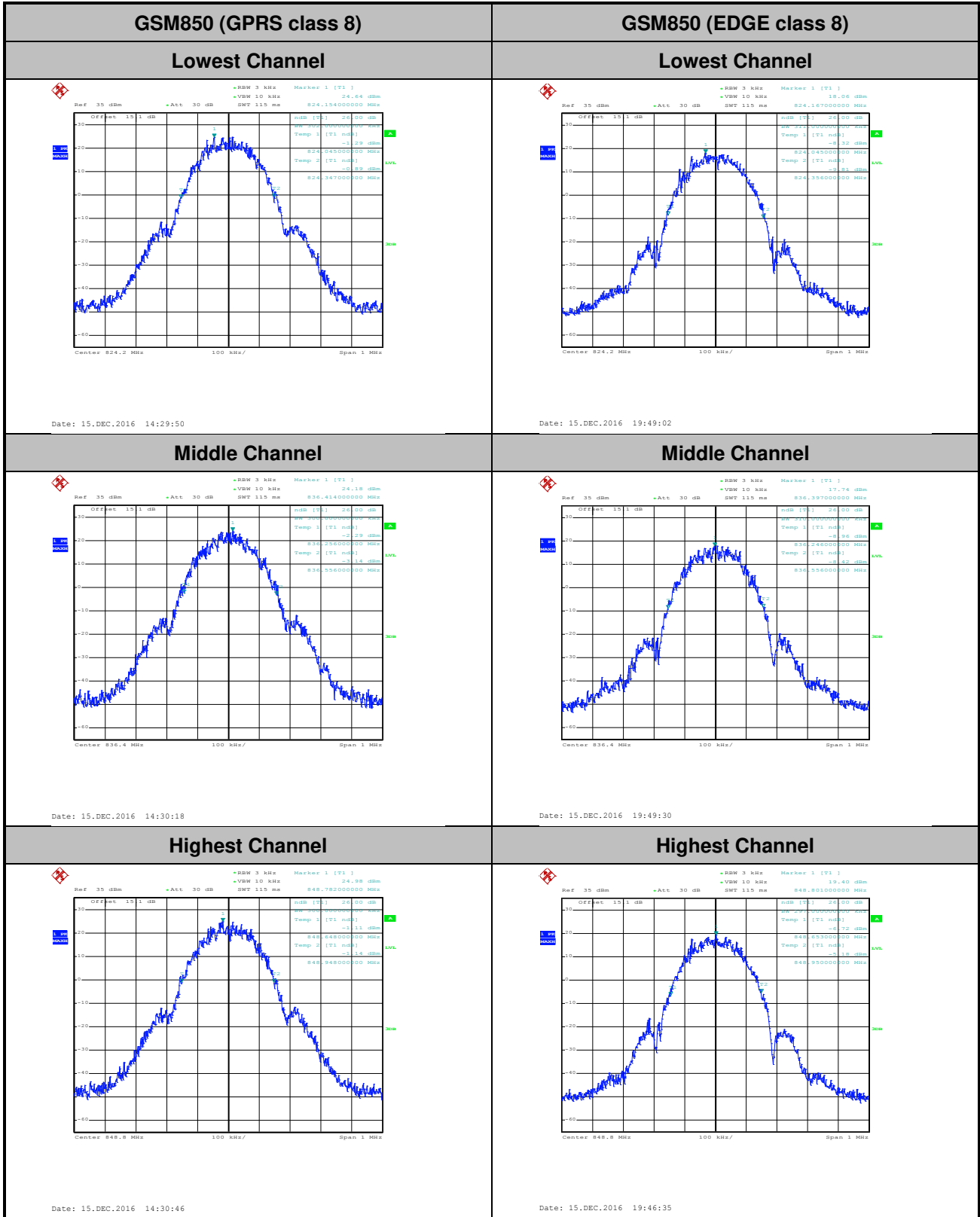

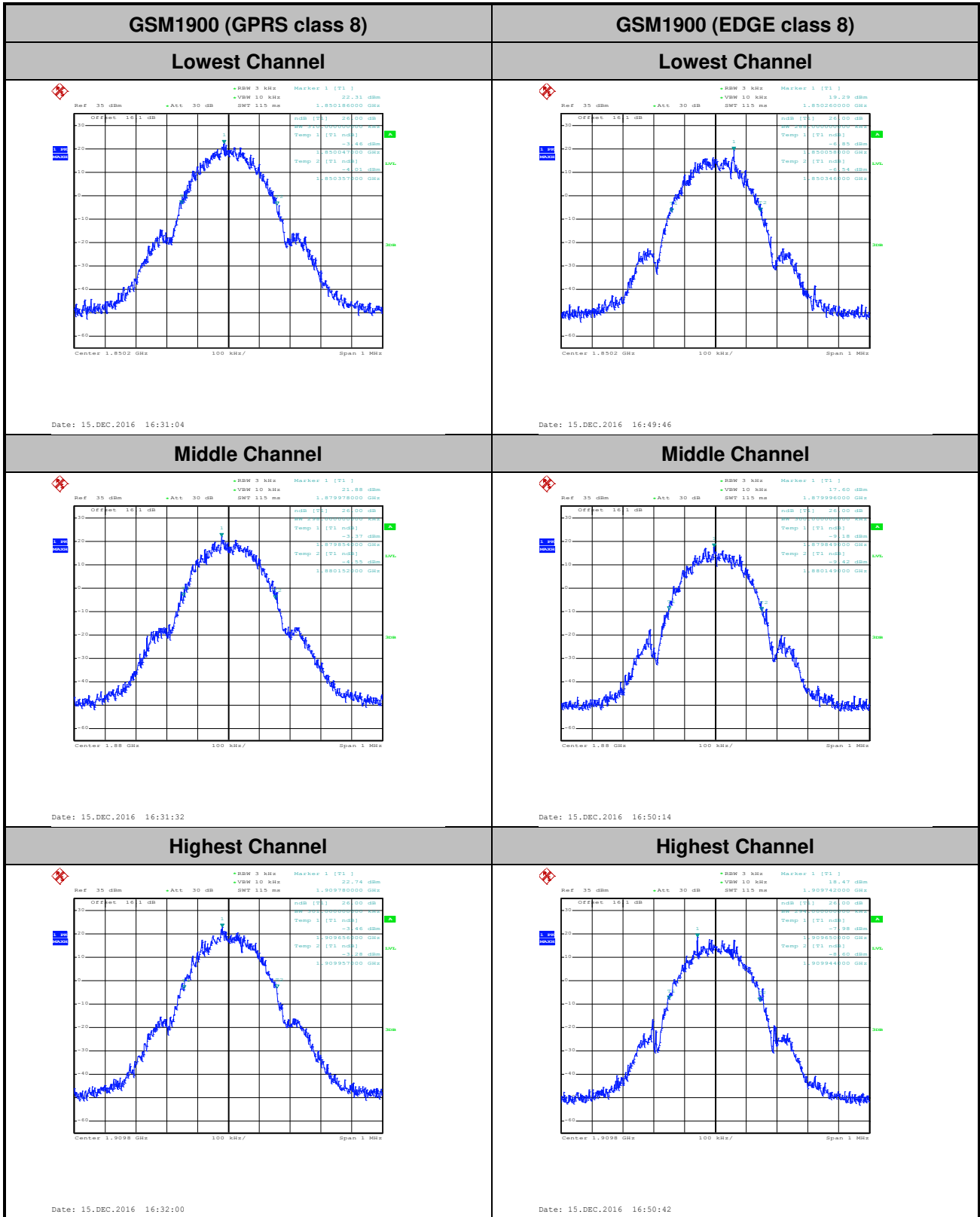



### Occupied Bandwidth

Mode	GSM850 : 99%OBW(MHz)	
Mod.	GPRS class 8	EDGE class 8
Lowest CH	0.241	0.249
Middle CH	0.248	0.242
Highest CH	0.248	0.243

Mode	GSM1900 : 99%OBW(MHz)	
Mod.	GPRS class 8	EDGE class 8
Lowest CH	0.244	0.249
Middle CH	0.251	0.246
Highest CH	0.245	0.240

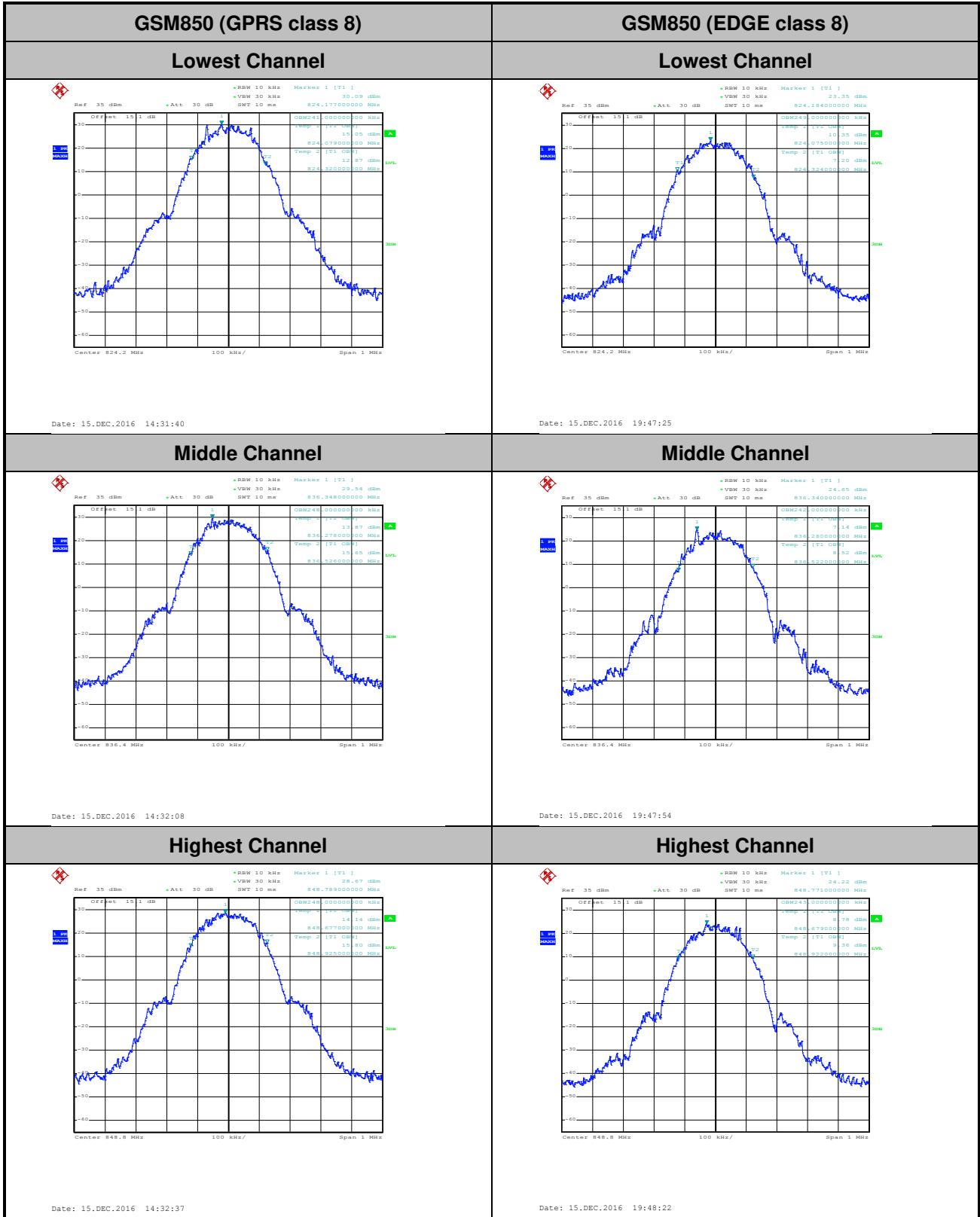



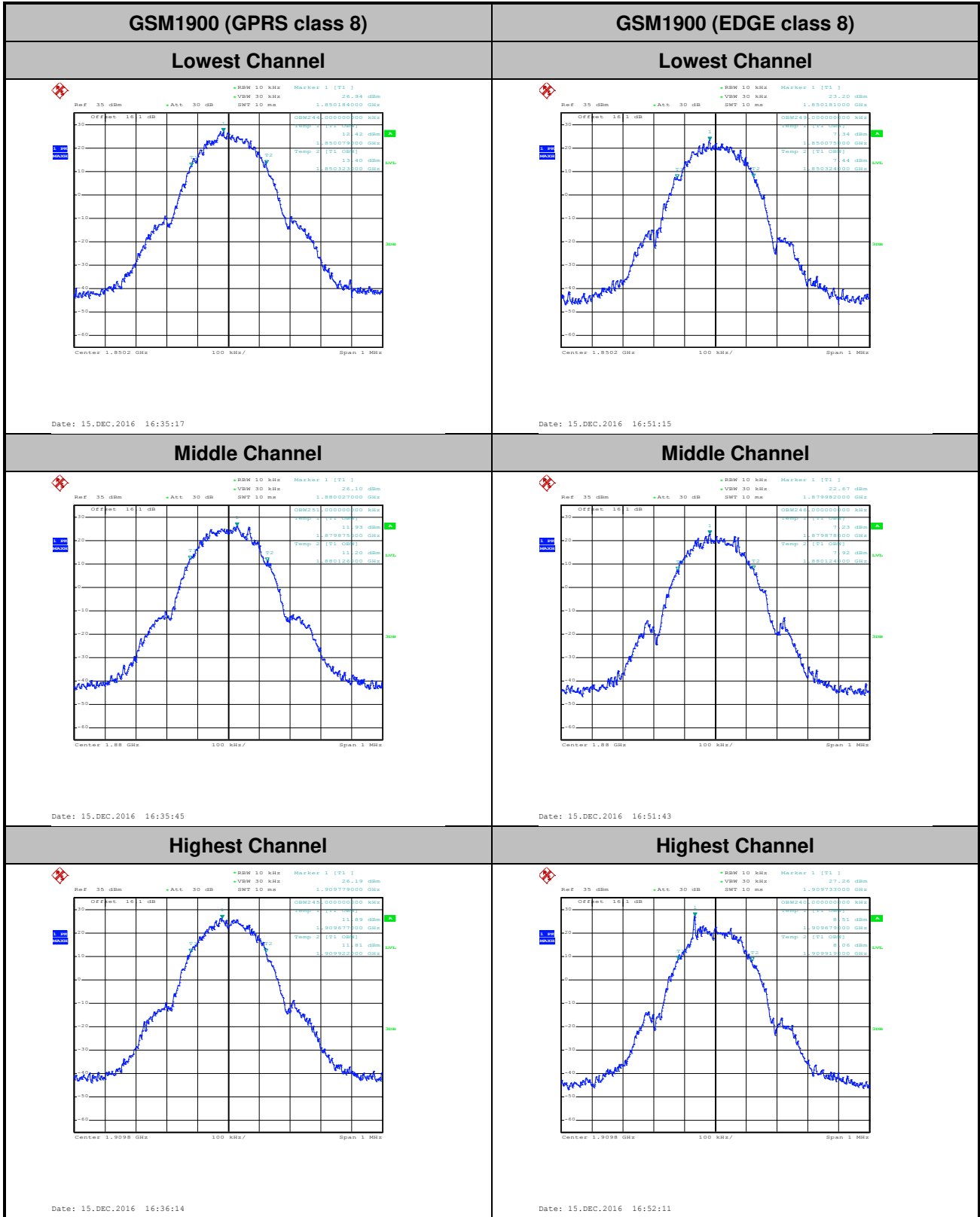



# Conducted Band Edge

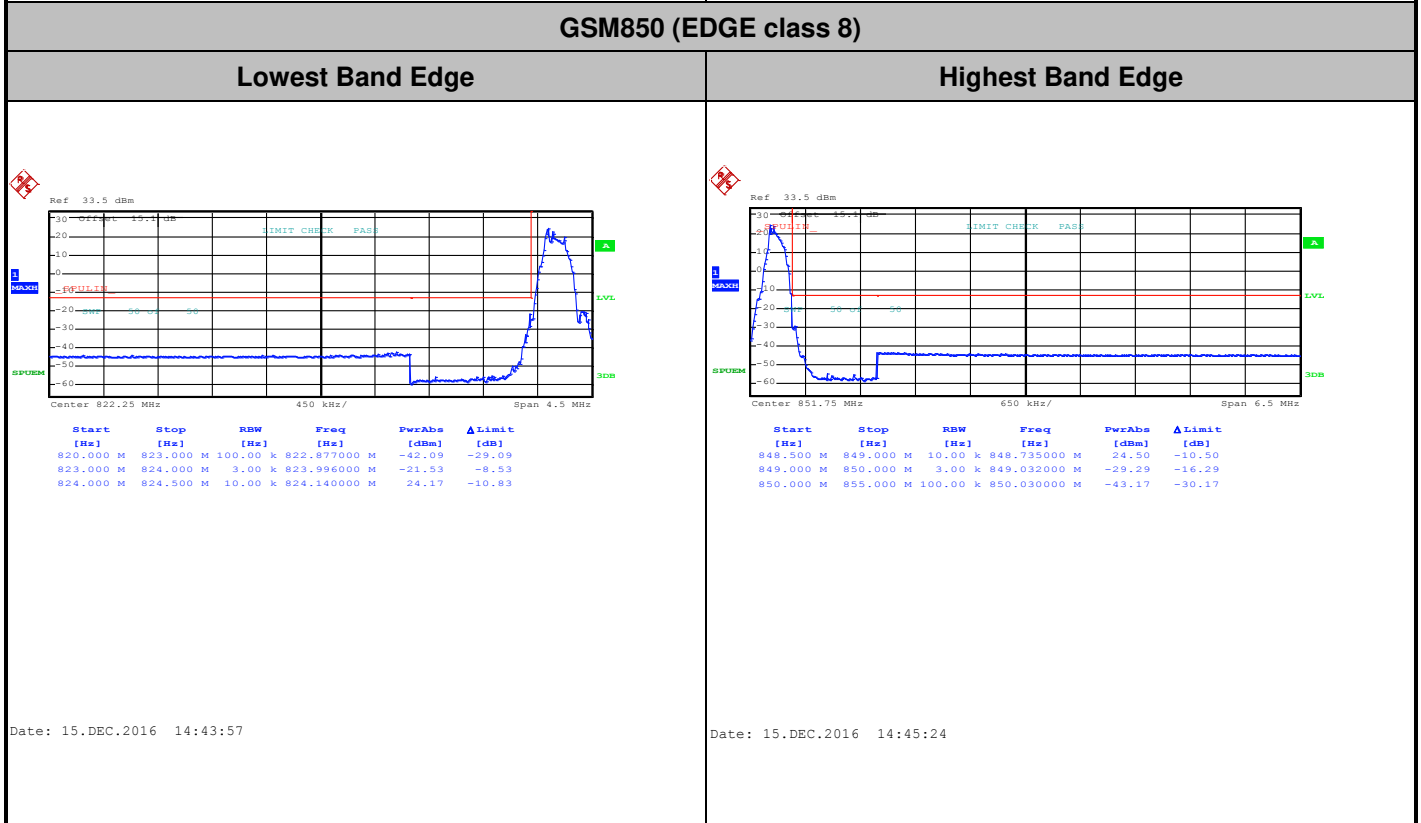
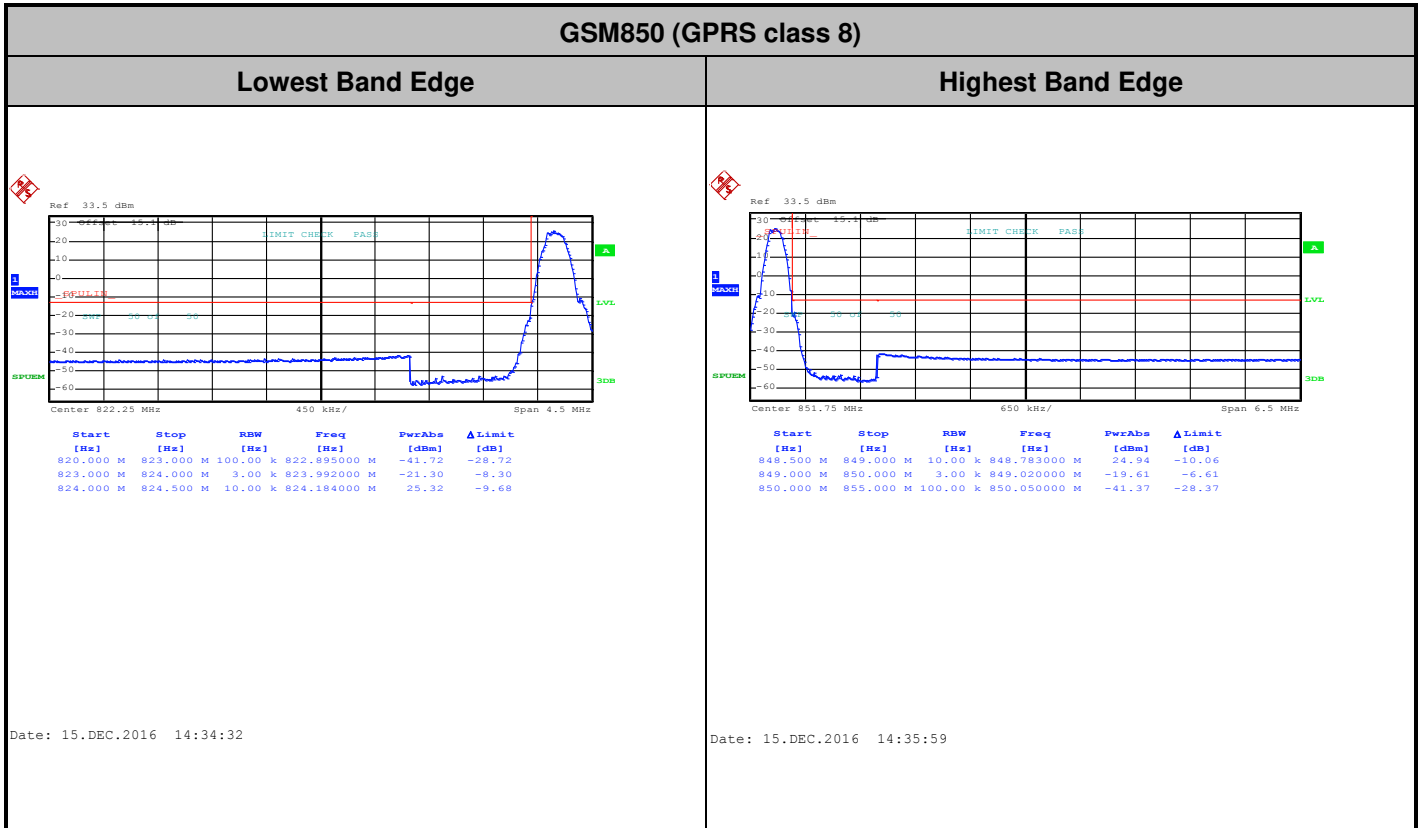



GSM1900 (GPRS class 8)

Lowest Band Edge

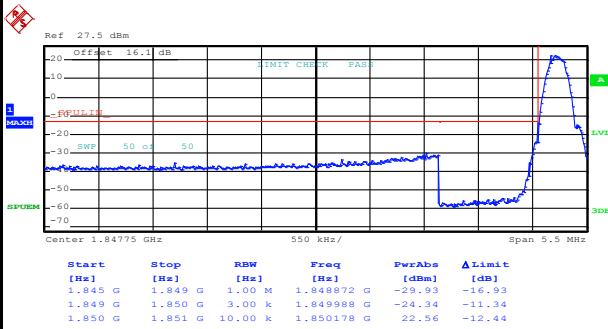

Date: 15.DEC.2016 16:37:53

Highest Band Edge

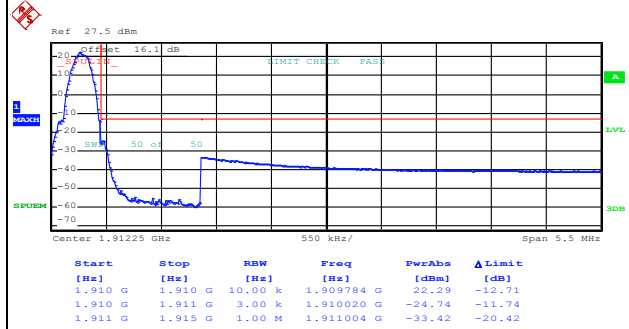

Date: 15.DEC.2016 16:39:20

GSM1900 (EDGE class 8)

Lowest Band Edge

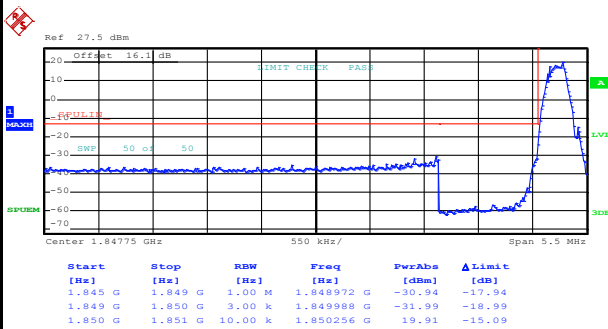

Date: 15.DEC.2016 16:53:46

Highest Band Edge

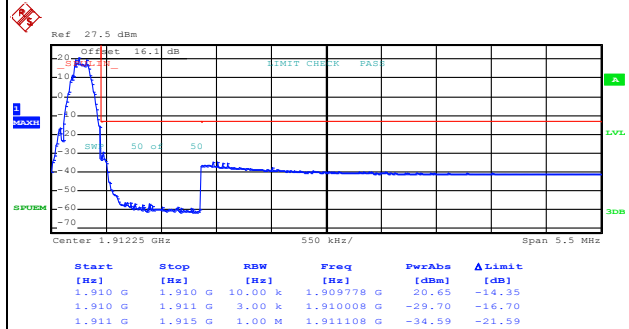

Date: 15.DEC.2016 16:55:13



# Spurious Emission

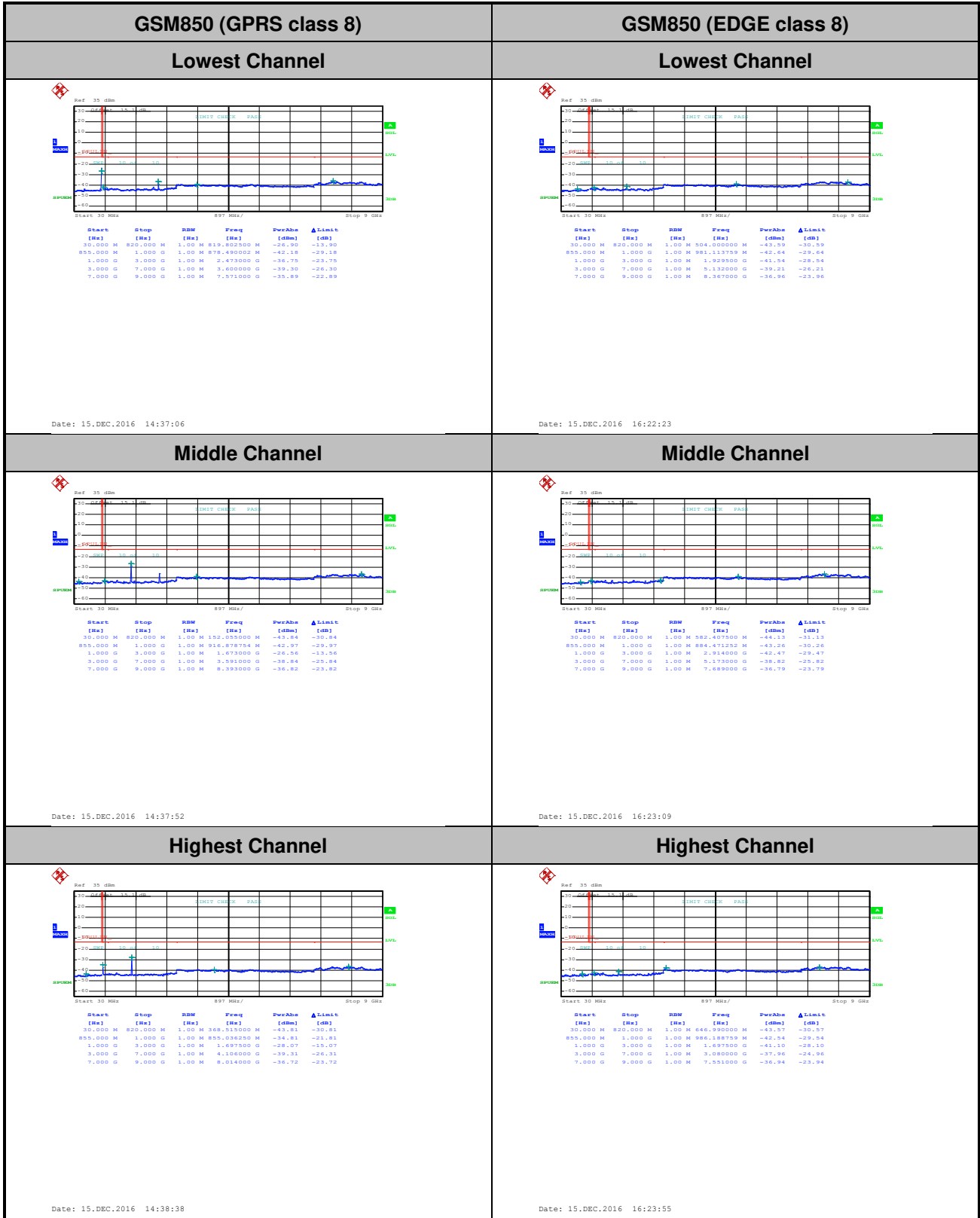

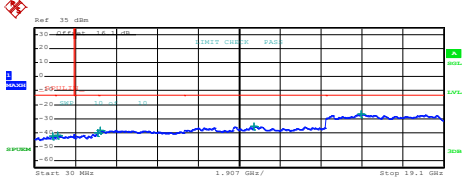
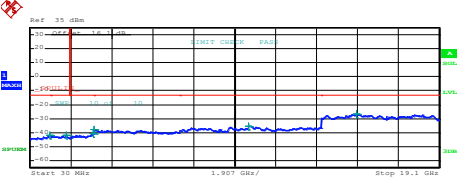
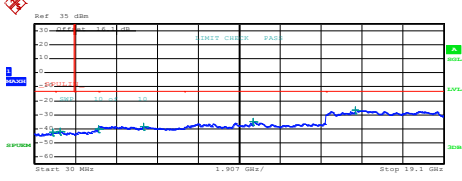
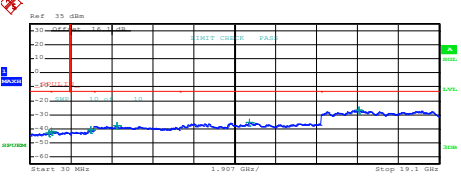
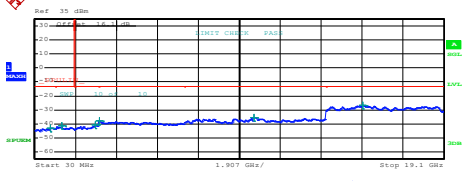
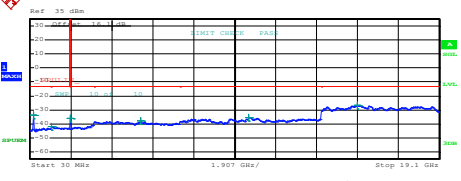

GSM1900 (GPRS class 8)	GSM1900 (EDGE class 8)																																																																																				
Lowest Channel	Lowest Channel																																																																																				
 <table border="1" data-bbox="239 577 638 672"> <thead> <tr> <th>Start [MHz]</th> <th>Stop [MHz]</th> <th>RBW [Hz]</th> <th>Freq [MHz]</th> <th>PwrAve [dBm]</th> <th>ΔLimit [dB]</th> </tr> </thead> <tbody> <tr><td>30.0000</td><td>1.0000</td><td>1.00</td><td>850.955000</td><td>-42.75</td><td>-29.75</td></tr> <tr><td>1.0000</td><td>1.8450</td><td>1.00</td><td>1.081331</td><td>-42.11</td><td>-29.11</td></tr> <tr><td>1.8450</td><td>3.0000</td><td>1.00</td><td>2.983396</td><td>-39.96</td><td>-26.96</td></tr> <tr><td>3.0000</td><td>7.0000</td><td>1.00</td><td>3.088000</td><td>-38.26</td><td>-25.26</td></tr> <tr><td>7.0000</td><td>13.6000</td><td>1.00</td><td>10.248025</td><td>-35.59</td><td>-22.59</td></tr> <tr><td>13.6000</td><td>19.1000</td><td>1.00</td><td>15.248875</td><td>-26.80</td><td>-13.80</td></tr> </tbody> </table> <p data-bbox="207 833 383 846">Date: 15.DEC.2016 16:40:48</p>	Start [MHz]	Stop [MHz]	RBW [Hz]	Freq [MHz]	PwrAve [dBm]	ΔLimit [dB]	30.0000	1.0000	1.00	850.955000	-42.75	-29.75	1.0000	1.8450	1.00	1.081331	-42.11	-29.11	1.8450	3.0000	1.00	2.983396	-39.96	-26.96	3.0000	7.0000	1.00	3.088000	-38.26	-25.26	7.0000	13.6000	1.00	10.248025	-35.59	-22.59	13.6000	19.1000	1.00	15.248875	-26.80	-13.80	 <table border="1" data-bbox="893 577 1292 672"> <thead> <tr> <th>Start [MHz]</th> <th>Stop [MHz]</th> <th>RBW [Hz]</th> <th>Freq [MHz]</th> <th>PwrAve [dBm]</th> <th>ΔLimit [dB]</th> </tr> </thead> <tbody> <tr><td>30.0000</td><td>1.0000</td><td>1.00</td><td>842.750000</td><td>-42.55</td><td>-29.55</td></tr> <tr><td>1.0000</td><td>1.8450</td><td>1.00</td><td>1.692478</td><td>-41.74</td><td>-28.74</td></tr> <tr><td>1.8450</td><td>3.0000</td><td>1.00</td><td>2.983325</td><td>-40.89</td><td>-27.89</td></tr> <tr><td>3.0000</td><td>7.0000</td><td>1.00</td><td>3.013000</td><td>-37.77</td><td>-24.77</td></tr> <tr><td>7.0000</td><td>13.6000</td><td>1.00</td><td>10.216675</td><td>-35.19</td><td>-22.19</td></tr> <tr><td>13.6000</td><td>19.1000</td><td>1.00</td><td>15.233500</td><td>-26.97</td><td>-13.97</td></tr> </tbody> </table> <p data-bbox="861 833 1037 846">Date: 15.DEC.2016 16:56:11</p>	Start [MHz]	Stop [MHz]	RBW [Hz]	Freq [MHz]	PwrAve [dBm]	ΔLimit [dB]	30.0000	1.0000	1.00	842.750000	-42.55	-29.55	1.0000	1.8450	1.00	1.692478	-41.74	-28.74	1.8450	3.0000	1.00	2.983325	-40.89	-27.89	3.0000	7.0000	1.00	3.013000	-37.77	-24.77	7.0000	13.6000	1.00	10.216675	-35.19	-22.19	13.6000	19.1000	1.00	15.233500	-26.97	-13.97
Start [MHz]	Stop [MHz]	RBW [Hz]	Freq [MHz]	PwrAve [dBm]	ΔLimit [dB]																																																																																
30.0000	1.0000	1.00	850.955000	-42.75	-29.75																																																																																
1.0000	1.8450	1.00	1.081331	-42.11	-29.11																																																																																
1.8450	3.0000	1.00	2.983396	-39.96	-26.96																																																																																
3.0000	7.0000	1.00	3.088000	-38.26	-25.26																																																																																
7.0000	13.6000	1.00	10.248025	-35.59	-22.59																																																																																
13.6000	19.1000	1.00	15.248875	-26.80	-13.80																																																																																
Start [MHz]	Stop [MHz]	RBW [Hz]	Freq [MHz]	PwrAve [dBm]	ΔLimit [dB]																																																																																
30.0000	1.0000	1.00	842.750000	-42.55	-29.55																																																																																
1.0000	1.8450	1.00	1.692478	-41.74	-28.74																																																																																
1.8450	3.0000	1.00	2.983325	-40.89	-27.89																																																																																
3.0000	7.0000	1.00	3.013000	-37.77	-24.77																																																																																
7.0000	13.6000	1.00	10.216675	-35.19	-22.19																																																																																
13.6000	19.1000	1.00	15.233500	-26.97	-13.97																																																																																
Middle Channel	Middle Channel																																																																																				
 <table border="1" data-bbox="239 1102 638 1196"> <thead> <tr> <th>Start [MHz]</th> <th>Stop [MHz]</th> <th>RBW [Hz]</th> <th>Freq [MHz]</th> <th>PwrAve [dBm]</th> <th>ΔLimit [dB]</th> </tr> </thead> <tbody> <tr><td>30.0000</td><td>1.0000</td><td>1.00</td><td>868.265000</td><td>-42.23</td><td>-29.23</td></tr> <tr><td>1.0000</td><td>1.8450</td><td>1.00</td><td>1.213776</td><td>-42.00</td><td>-29.00</td></tr> <tr><td>1.8450</td><td>3.0000</td><td>1.00</td><td>2.980235</td><td>-40.23</td><td>-27.23</td></tr> <tr><td>3.0000</td><td>7.0000</td><td>1.00</td><td>5.114000</td><td>-38.28</td><td>-25.28</td></tr> <tr><td>7.0000</td><td>13.6000</td><td>1.00</td><td>10.212350</td><td>-36.99</td><td>-23.99</td></tr> <tr><td>13.6000</td><td>19.1000</td><td>1.00</td><td>14.989750</td><td>-26.70</td><td>-13.70</td></tr> </tbody> </table> <p data-bbox="207 1357 383 1370">Date: 15.DEC.2016 16:41:34</p>	Start [MHz]	Stop [MHz]	RBW [Hz]	Freq [MHz]	PwrAve [dBm]	ΔLimit [dB]	30.0000	1.0000	1.00	868.265000	-42.23	-29.23	1.0000	1.8450	1.00	1.213776	-42.00	-29.00	1.8450	3.0000	1.00	2.980235	-40.23	-27.23	3.0000	7.0000	1.00	5.114000	-38.28	-25.28	7.0000	13.6000	1.00	10.212350	-36.99	-23.99	13.6000	19.1000	1.00	14.989750	-26.70	-13.70	 <table border="1" data-bbox="893 1102 1292 1196"> <thead> <tr> <th>Start [MHz]</th> <th>Stop [MHz]</th> <th>RBW [Hz]</th> <th>Freq [MHz]</th> <th>PwrAve [dBm]</th> <th>ΔLimit [dB]</th> </tr> </thead> <tbody> <tr><td>30.0000</td><td>1.0000</td><td>1.00</td><td>910.760000</td><td>-43.09</td><td>-30.09</td></tr> <tr><td>1.0000</td><td>1.8450</td><td>1.00</td><td>1.030293</td><td>-41.63</td><td>-28.63</td></tr> <tr><td>1.8450</td><td>3.0000</td><td>1.00</td><td>2.857594</td><td>-40.96</td><td>-27.96</td></tr> <tr><td>3.0000</td><td>7.0000</td><td>1.00</td><td>4.076000</td><td>-37.94</td><td>-24.94</td></tr> <tr><td>7.0000</td><td>13.6000</td><td>1.00</td><td>10.239775</td><td>-35.35</td><td>-22.35</td></tr> <tr><td>13.6000</td><td>19.1000</td><td>1.00</td><td>15.352438</td><td>-26.72</td><td>-13.72</td></tr> </tbody> </table> <p data-bbox="861 1357 1037 1370">Date: 15.DEC.2016 16:56:56</p>	Start [MHz]	Stop [MHz]	RBW [Hz]	Freq [MHz]	PwrAve [dBm]	ΔLimit [dB]	30.0000	1.0000	1.00	910.760000	-43.09	-30.09	1.0000	1.8450	1.00	1.030293	-41.63	-28.63	1.8450	3.0000	1.00	2.857594	-40.96	-27.96	3.0000	7.0000	1.00	4.076000	-37.94	-24.94	7.0000	13.6000	1.00	10.239775	-35.35	-22.35	13.6000	19.1000	1.00	15.352438	-26.72	-13.72
Start [MHz]	Stop [MHz]	RBW [Hz]	Freq [MHz]	PwrAve [dBm]	ΔLimit [dB]																																																																																
30.0000	1.0000	1.00	868.265000	-42.23	-29.23																																																																																
1.0000	1.8450	1.00	1.213776	-42.00	-29.00																																																																																
1.8450	3.0000	1.00	2.980235	-40.23	-27.23																																																																																
3.0000	7.0000	1.00	5.114000	-38.28	-25.28																																																																																
7.0000	13.6000	1.00	10.212350	-36.99	-23.99																																																																																
13.6000	19.1000	1.00	14.989750	-26.70	-13.70																																																																																
Start [MHz]	Stop [MHz]	RBW [Hz]	Freq [MHz]	PwrAve [dBm]	ΔLimit [dB]																																																																																
30.0000	1.0000	1.00	910.760000	-43.09	-30.09																																																																																
1.0000	1.8450	1.00	1.030293	-41.63	-28.63																																																																																
1.8450	3.0000	1.00	2.857594	-40.96	-27.96																																																																																
3.0000	7.0000	1.00	4.076000	-37.94	-24.94																																																																																
7.0000	13.6000	1.00	10.239775	-35.35	-22.35																																																																																
13.6000	19.1000	1.00	15.352438	-26.72	-13.72																																																																																
Highest Channel	Highest Channel																																																																																				
 <table border="1" data-bbox="239 1626 638 1720"> <thead> <tr> <th>Start [MHz]</th> <th>Stop [MHz]</th> <th>RBW [Hz]</th> <th>Freq [MHz]</th> <th>PwrAve [dBm]</th> <th>ΔLimit [dB]</th> </tr> </thead> <tbody> <tr><td>30.0000</td><td>1.0000</td><td>1.00</td><td>737.130000</td><td>-43.07</td><td>-30.07</td></tr> <tr><td>1.0000</td><td>1.8450</td><td>1.00</td><td>1.273780</td><td>-41.50</td><td>-28.50</td></tr> <tr><td>1.8450</td><td>3.0000</td><td>1.00</td><td>2.943218</td><td>-40.92</td><td>-27.92</td></tr> <tr><td>3.0000</td><td>7.0000</td><td>1.00</td><td>3.060000</td><td>-37.99</td><td>-24.99</td></tr> <tr><td>7.0000</td><td>13.6000</td><td>1.00</td><td>10.255450</td><td>-35.33</td><td>-22.33</td></tr> <tr><td>13.6000</td><td>19.1000</td><td>1.00</td><td>15.342813</td><td>-26.81</td><td>-13.81</td></tr> </tbody> </table> <p data-bbox="207 1877 383 1890">Date: 15.DEC.2016 16:42:20</p>	Start [MHz]	Stop [MHz]	RBW [Hz]	Freq [MHz]	PwrAve [dBm]	ΔLimit [dB]	30.0000	1.0000	1.00	737.130000	-43.07	-30.07	1.0000	1.8450	1.00	1.273780	-41.50	-28.50	1.8450	3.0000	1.00	2.943218	-40.92	-27.92	3.0000	7.0000	1.00	3.060000	-37.99	-24.99	7.0000	13.6000	1.00	10.255450	-35.33	-22.33	13.6000	19.1000	1.00	15.342813	-26.81	-13.81	 <table border="1" data-bbox="893 1626 1292 1720"> <thead> <tr> <th>Start [MHz]</th> <th>Stop [MHz]</th> <th>RBW [Hz]</th> <th>Freq [MHz]</th> <th>PwrAve [dBm]</th> <th>ΔLimit [dB]</th> </tr> </thead> <tbody> <tr><td>30.0000</td><td>1.0000</td><td>1.00</td><td>171.375000</td><td>-35.28</td><td>-22.28</td></tr> <tr><td>1.0000</td><td>1.8450</td><td>1.00</td><td>1.035490</td><td>-42.13</td><td>-29.13</td></tr> <tr><td>1.8450</td><td>3.0000</td><td>1.00</td><td>1.935542</td><td>-36.31</td><td>-23.31</td></tr> <tr><td>3.0000</td><td>7.0000</td><td>1.00</td><td>5.196000</td><td>-38.03</td><td>-25.03</td></tr> <tr><td>7.0000</td><td>13.6000</td><td>1.00</td><td>10.212550</td><td>-35.36</td><td>-22.36</td></tr> <tr><td>13.6000</td><td>19.1000</td><td>1.00</td><td>15.296750</td><td>-26.86</td><td>-13.86</td></tr> </tbody> </table> <p data-bbox="861 1877 1037 1890">Date: 15.DEC.2016 16:57:42</p>	Start [MHz]	Stop [MHz]	RBW [Hz]	Freq [MHz]	PwrAve [dBm]	ΔLimit [dB]	30.0000	1.0000	1.00	171.375000	-35.28	-22.28	1.0000	1.8450	1.00	1.035490	-42.13	-29.13	1.8450	3.0000	1.00	1.935542	-36.31	-23.31	3.0000	7.0000	1.00	5.196000	-38.03	-25.03	7.0000	13.6000	1.00	10.212550	-35.36	-22.36	13.6000	19.1000	1.00	15.296750	-26.86	-13.86
Start [MHz]	Stop [MHz]	RBW [Hz]	Freq [MHz]	PwrAve [dBm]	ΔLimit [dB]																																																																																
30.0000	1.0000	1.00	737.130000	-43.07	-30.07																																																																																
1.0000	1.8450	1.00	1.273780	-41.50	-28.50																																																																																
1.8450	3.0000	1.00	2.943218	-40.92	-27.92																																																																																
3.0000	7.0000	1.00	3.060000	-37.99	-24.99																																																																																
7.0000	13.6000	1.00	10.255450	-35.33	-22.33																																																																																
13.6000	19.1000	1.00	15.342813	-26.81	-13.81																																																																																
Start [MHz]	Stop [MHz]	RBW [Hz]	Freq [MHz]	PwrAve [dBm]	ΔLimit [dB]																																																																																
30.0000	1.0000	1.00	171.375000	-35.28	-22.28																																																																																
1.0000	1.8450	1.00	1.035490	-42.13	-29.13																																																																																
1.8450	3.0000	1.00	1.935542	-36.31	-23.31																																																																																
3.0000	7.0000	1.00	5.196000	-38.03	-25.03																																																																																
7.0000	13.6000	1.00	10.212550	-35.36	-22.36																																																																																
13.6000	19.1000	1.00	15.296750	-26.86	-13.86																																																																																



**Frequency Stability**

Test Conditions	Middle Channel	GSM850 (GPRS class 8)	GSM850 (EDGE class 8)	Limit 2.5ppm
Temperature (°C)	Voltage (Volt)	Deviation (ppm)		Result
50	Normal Voltage	0.0024	0.0024	PASS
40	Normal Voltage	0.0024	0.0048	
30	Normal Voltage	0.0048	0.0012	
20(Ref.)	Normal Voltage	0.0000	0.0000	
10	Normal Voltage	0.0000	0.0454	
0	Normal Voltage	0.0227	0.0418	
-10	Normal Voltage	0.0287	0.0407	
-20	Normal Voltage	0.0263	0.0418	
-30	Normal Voltage	0.0275	0.0395	
20	Maximum Voltage	0.0036	0.0012	
20	Normal Voltage	0.0000	0.0000	
20	Battery End Point	0.0024	0.0048	

Test Conditions	Middle Channel	GSM1900 (GPRS class 8)	GSM1900 (EDGE class 8)	Limit Note 2.
Temperature (°C)	Voltage (Volt)	Deviation (ppm)		Result
50	Normal Voltage	0.0005	0.0021	PASS
40	Normal Voltage	0.0016	0.0011	
30	Normal Voltage	0.0005	0.0011	
20(Ref.)	Normal Voltage	0.0000	0.0000	
10	Normal Voltage	0.0037	0.0032	
0	Normal Voltage	0.0239	0.0016	
-10	Normal Voltage	0.0271	0.0032	
-20	Normal Voltage	0.0261	0.0048	
-30	Normal Voltage	0.0250	0.0043	
20	Maximum Voltage	0.0016	0.0021	
20	Normal Voltage	0.0000	0.0000	
20	Battery End Point	0.0005	0.0000	

**Note:**

1. Normal Voltage = 3.85V. ; Battery End Point (BEP) = 3.4 V. ; Maximum Voltage =4.35 V
2. The frequency fundamental emissions stay within the authorized frequency block.



### A3. WCDMA

#### Peak-to-Average Ratio

Mode	WCDMA Band V	WCDMA Band II	Limit: 13dB
Mod.	RMC 12.2Kbps	RMC 12.2Kbps	Result
Lowest CH	2.56	2.68	PASS
Middle CH	2.28	2.96	
Highest CH	2.00	2.84	

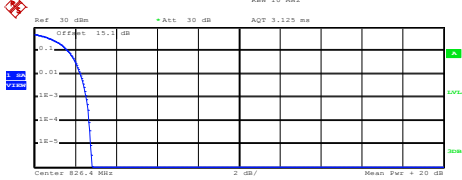
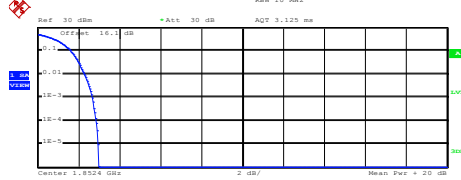
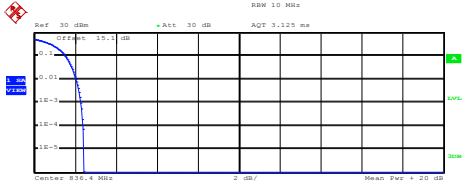
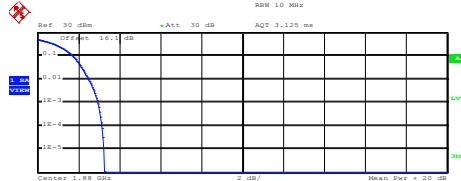
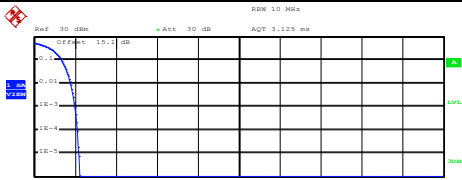
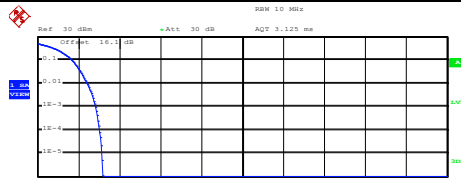

WCDMA Band V (RMC 12.2Kbps)	WCDMA Band II (RMC 12.2Kbps)																
<p align="center"><b>Lowest Channel</b></p>  <p>Center 826.4 MHz      2 dB/      Mean Pwr + 20 dB</p> <p>Complementary Cumulative Distribution Function (100000 samples) Trace 1 Mean 23.91 dBm Peak 26.72 dBm Crest 2.82 dB</p> <table border="1"> <tr><td>10 %</td><td>1.64 dB</td></tr> <tr><td>1 %</td><td>2.24 dB</td></tr> <tr><td>.1 %</td><td>2.56 dB</td></tr> <tr><td>.01 %</td><td>2.68 dB</td></tr> </table> <p>Date: 15.DEC.2016 14:25:46</p>	10 %	1.64 dB	1 %	2.24 dB	.1 %	2.56 dB	.01 %	2.68 dB	<p align="center"><b>Lowest Channel</b></p>  <p>Center 1.8524 GHz      2 dB/      Mean Pwr + 20 dB</p> <p>Complementary Cumulative Distribution Function (100000 samples) Trace 1 Mean 22.20 dBm Peak 25.17 dBm Crest 2.97 dB</p> <table border="1"> <tr><td>10 %</td><td>1.64 dB</td></tr> <tr><td>1 %</td><td>2.28 dB</td></tr> <tr><td>.1 %</td><td>2.68 dB</td></tr> <tr><td>.01 %</td><td>2.88 dB</td></tr> </table> <p>Date: 15.DEC.2016 14:13:26</p>	10 %	1.64 dB	1 %	2.28 dB	.1 %	2.68 dB	.01 %	2.88 dB
10 %	1.64 dB																
1 %	2.24 dB																
.1 %	2.56 dB																
.01 %	2.68 dB																
10 %	1.64 dB																
1 %	2.28 dB																
.1 %	2.68 dB																
.01 %	2.88 dB																
<p align="center"><b>Middle Channel</b></p>  <p>Center 836.4 MHz      2 dB/      Mean Pwr + 20 dB</p> <p>Complementary Cumulative Distribution Function (100000 samples) Trace 1 Mean 23.87 dBm Peak 26.30 dBm Crest 2.43 dB</p> <table border="1"> <tr><td>10 %</td><td>1.52 dB</td></tr> <tr><td>1 %</td><td>2.04 dB</td></tr> <tr><td>.1 %</td><td>2.28 dB</td></tr> <tr><td>.01 %</td><td>2.40 dB</td></tr> </table> <p>Date: 15.DEC.2016 14:25:56</p>	10 %	1.52 dB	1 %	2.04 dB	.1 %	2.28 dB	.01 %	2.40 dB	<p align="center"><b>Middle Channel</b></p>  <p>Center 1.88 GHz      2 dB/      Mean Pwr + 20 dB</p> <p>Complementary Cumulative Distribution Function (100000 samples) Trace 1 Mean 21.99 dBm Peak 25.24 dBm Crest 3.26 dB</p> <table border="1"> <tr><td>10 %</td><td>1.72 dB</td></tr> <tr><td>1 %</td><td>2.48 dB</td></tr> <tr><td>.1 %</td><td>2.96 dB</td></tr> <tr><td>.01 %</td><td>3.16 dB</td></tr> </table> <p>Date: 15.DEC.2016 14:13:48</p>	10 %	1.72 dB	1 %	2.48 dB	.1 %	2.96 dB	.01 %	3.16 dB
10 %	1.52 dB																
1 %	2.04 dB																
.1 %	2.28 dB																
.01 %	2.40 dB																
10 %	1.72 dB																
1 %	2.48 dB																
.1 %	2.96 dB																
.01 %	3.16 dB																
<p align="center"><b>Highest Channel</b></p>  <p>Center 846.6 MHz      2 dB/      Mean Pwr + 20 dB</p> <p>Complementary Cumulative Distribution Function (100000 samples) Trace 1 Mean 24.01 dBm Peak 26.23 dBm Crest 2.22 dB</p> <table border="1"> <tr><td>10 %</td><td>1.32 dB</td></tr> <tr><td>1 %</td><td>1.80 dB</td></tr> <tr><td>.1 %</td><td>2.00 dB</td></tr> <tr><td>.01 %</td><td>2.12 dB</td></tr> </table> <p>Date: 15.DEC.2016 14:26:19</p>	10 %	1.32 dB	1 %	1.80 dB	.1 %	2.00 dB	.01 %	2.12 dB	<p align="center"><b>Highest Channel</b></p>  <p>Center 1.9076 GHz      2 dB/      Mean Pwr + 20 dB</p> <p>Complementary Cumulative Distribution Function (100000 samples) Trace 1 Mean 21.79 dBm Peak 24.96 dBm Crest 3.17 dB</p> <table border="1"> <tr><td>10 %</td><td>1.68 dB</td></tr> <tr><td>1 %</td><td>2.44 dB</td></tr> <tr><td>.1 %</td><td>2.84 dB</td></tr> <tr><td>.01 %</td><td>3.04 dB</td></tr> </table> <p>Date: 15.DEC.2016 14:14:09</p>	10 %	1.68 dB	1 %	2.44 dB	.1 %	2.84 dB	.01 %	3.04 dB
10 %	1.32 dB																
1 %	1.80 dB																
.1 %	2.00 dB																
.01 %	2.12 dB																
10 %	1.68 dB																
1 %	2.44 dB																
.1 %	2.84 dB																
.01 %	3.04 dB																





**26dB Bandwidth**

Mode	WCDMA Band V 26dB BW(MHz)	WCDMA Band II 26dB BW(MHz)
Mod.	RMC 12.2Kbps	RMC 12.2Kbps
Lowest CH	4.70	4.72
Middle CH	4.71	4.68
Highest CH	4.79	4.70



WCDMA Band V (RMC 12.2Kbps)

WCDMA Band II (RMC 12.2Kbps)

Lowest Channel

Lowest Channel

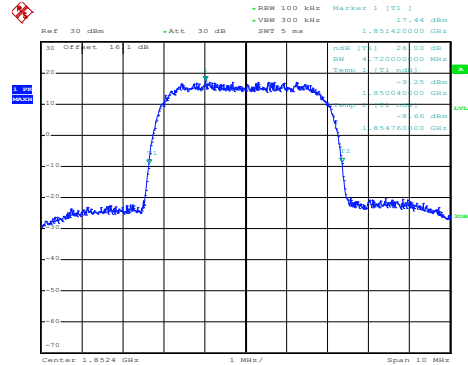
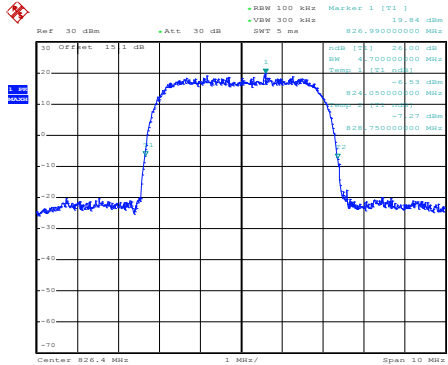

Date: 15.DEC.2016 14:14:55

Date: 15.DEC.2016 14:00:18

Middle Channel

Middle Channel

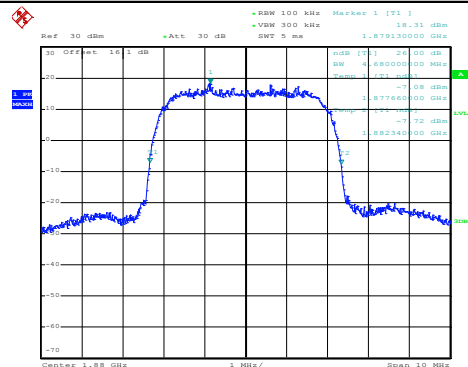
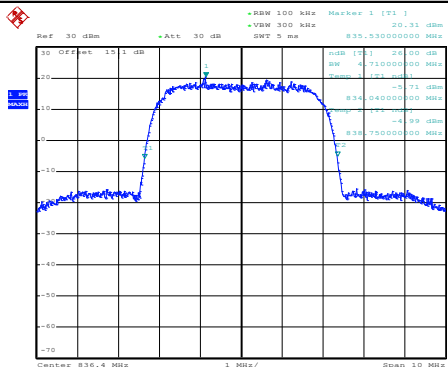

Date: 15.DEC.2016 14:15:23

Date: 15.DEC.2016 14:00:46

Highest Channel

Highest Channel

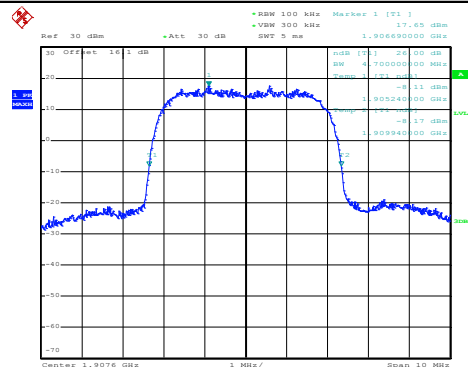
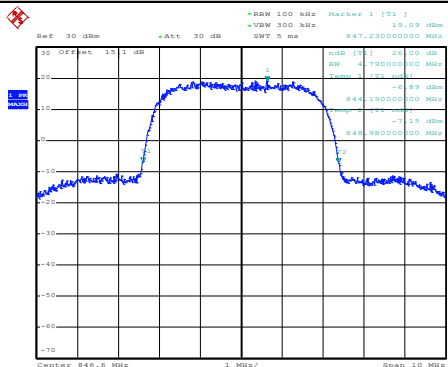

Date: 15.DEC.2016 14:15:51

Date: 15.DEC.2016 14:01:14



### Occupied Bandwidth

Mode	WCDMA Band V 99%OBW(MHz)	WCDMA Band II 99%OBW(MHz)
Mod.	RMC 12.2Kbps	RMC 12.2Kbps
Lowest CH	4.17	4.17
Middle CH	4.18	4.16
Highest CH	4.20	4.17

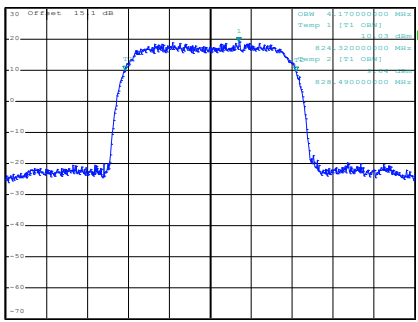
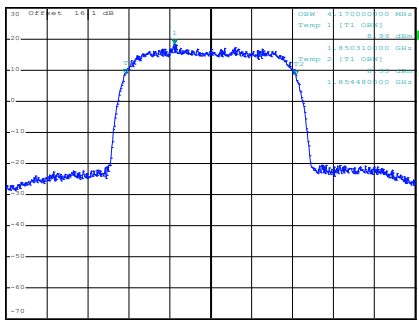
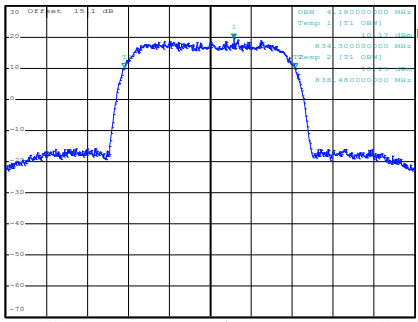
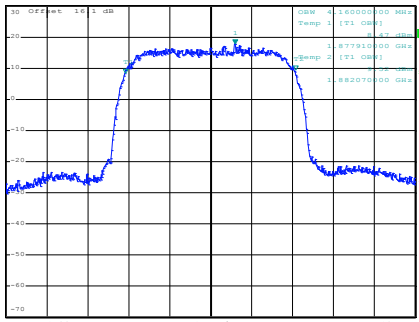
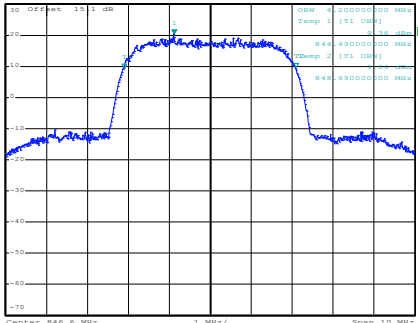
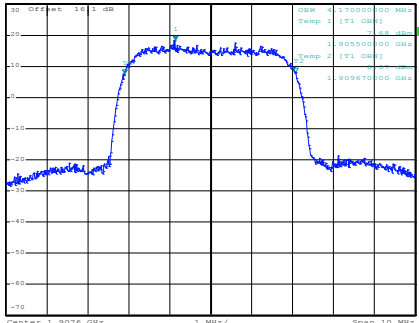

WCDMA Band V (RMC 12.2Kbps)	WCDMA Band II (RMC 12.2Kbps)
<p style="text-align: center;"><b>Lowest Channel</b></p>  <p style="text-align: center;">Date: 15.DEC.2016 14:16:34</p>	<p style="text-align: center;"><b>Lowest Channel</b></p>  <p style="text-align: center;">Date: 15.DEC.2016 14:01:52</p>
<p style="text-align: center;"><b>Middle Channel</b></p>  <p style="text-align: center;">Date: 15.DEC.2016 14:17:02</p>	<p style="text-align: center;"><b>Middle Channel</b></p>  <p style="text-align: center;">Date: 15.DEC.2016 14:02:20</p>
<p style="text-align: center;"><b>Highest Channel</b></p>  <p style="text-align: center;">Date: 15.DEC.2016 14:17:30</p>	<p style="text-align: center;"><b>Highest Channel</b></p>  <p style="text-align: center;">Date: 15.DEC.2016 14:02:48</p>



# Conducted Band Edge

## WCDMA Band V (RMC 12.2Kbps)

### Lowest Band Edge

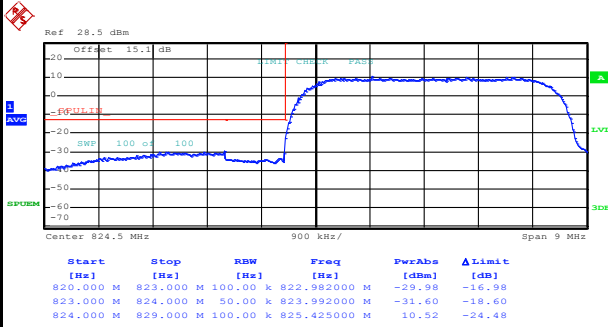

Date: 15.DEC.2016 14:20:17

### Highest Band Edge

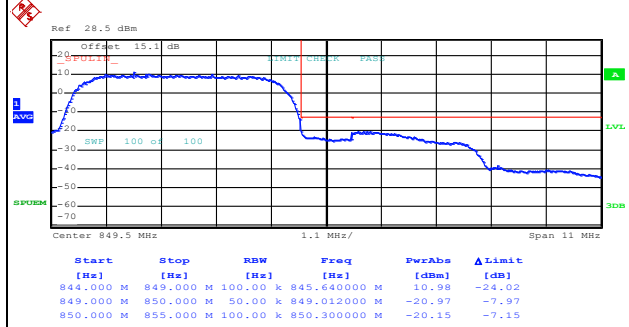

Date: 15.DEC.2016 14:22:59

## WCDMA Band II (RMC 12.2Kbps)

### Lowest Band Edge

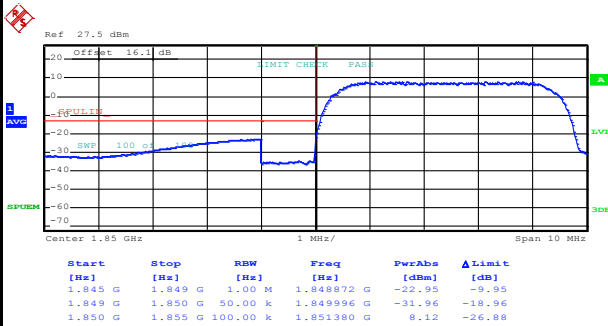

Date: 15.DEC.2016 14:05:43

### Highest Band Edge

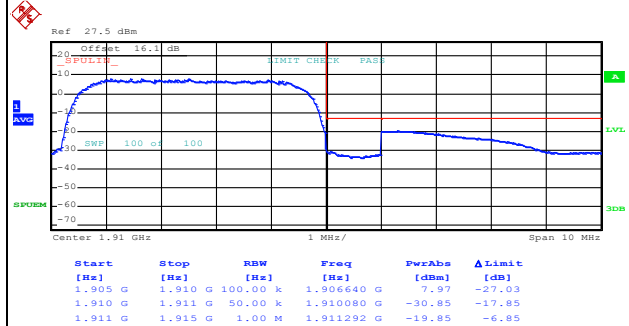

Date: 15.DEC.2016 14:08:25

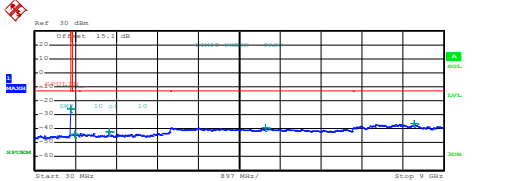
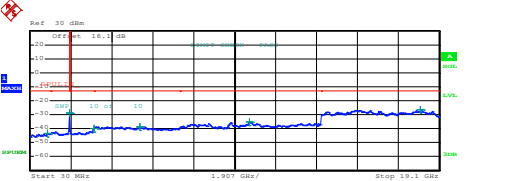
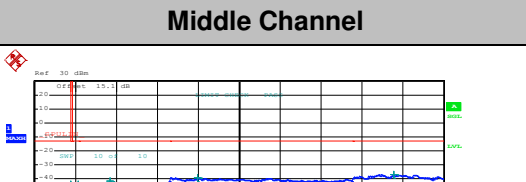
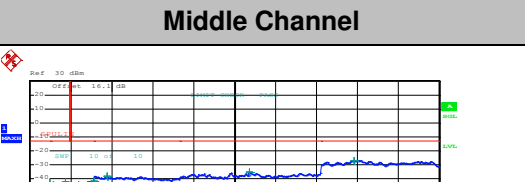
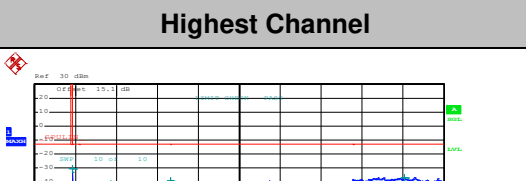
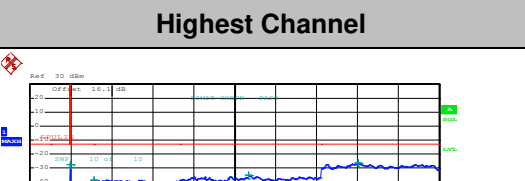

# Conducted Spurious Emission

WCDMA Band V (RMC 12.2Kbps)	WCDMA Band II (RMC 12.2Kbps)																																																																																										
Lowest Channel	Lowest Channel																																																																																										
 <table border="1" data-bbox="239 660 702 739"> <thead> <tr> <th>Start</th> <th>Stop</th> <th>RBW</th> <th>Freq</th> <th>PwrAbs</th> <th>ΔLimit</th> </tr> <tr> <th>[Hz]</th> <th>[Hz]</th> <th>[Hz]</th> <th>[Hz]</th> <th>[dBm]</th> <th>[dB]</th> </tr> </thead> <tbody> <tr> <td>30,000 M</td> <td>820,000 M</td> <td>1,000 M</td> <td>818,010000 M</td> <td>-23.92</td> <td>-22.92</td> </tr> <tr> <td>850,000 M</td> <td>1,000 G</td> <td>1,000 G</td> <td>910,211294 M</td> <td>-44.12</td> <td>-31.12</td> </tr> <tr> <td>1,000 G</td> <td>3,000 G</td> <td>1,000 M</td> <td>1,6045000 G</td> <td>-42.20</td> <td>-29.20</td> </tr> <tr> <td>3,000 G</td> <td>7,000 G</td> <td>1,000 M</td> <td>5,0970000 G</td> <td>-39.53</td> <td>-26.53</td> </tr> <tr> <td>7,000 G</td> <td>9,000 G</td> <td>1,000 M</td> <td>8,3600000 G</td> <td>-36.56</td> <td>-23.56</td> </tr> </tbody> </table> <p>Date: 15.DEC.2016 14:23:53</p>	Start	Stop	RBW	Freq	PwrAbs	ΔLimit	[Hz]	[Hz]	[Hz]	[Hz]	[dBm]	[dB]	30,000 M	820,000 M	1,000 M	818,010000 M	-23.92	-22.92	850,000 M	1,000 G	1,000 G	910,211294 M	-44.12	-31.12	1,000 G	3,000 G	1,000 M	1,6045000 G	-42.20	-29.20	3,000 G	7,000 G	1,000 M	5,0970000 G	-39.53	-26.53	7,000 G	9,000 G	1,000 M	8,3600000 G	-36.56	-23.56	 <table border="1" data-bbox="893 660 1356 739"> <thead> <tr> <th>Start</th> <th>Stop</th> <th>RBW</th> <th>Freq</th> <th>PwrAbs</th> <th>ΔLimit</th> </tr> <tr> <th>[Hz]</th> <th>[Hz]</th> <th>[Hz]</th> <th>[Hz]</th> <th>[dBm]</th> <th>[dB]</th> </tr> </thead> <tbody> <tr> <td>30,000 M</td> <td>1,000 G</td> <td>1,000 M</td> <td>821,320000 M</td> <td>-43.27</td> <td>-30.27</td> </tr> <tr> <td>1,000 G</td> <td>3,000 G</td> <td>1,000 M</td> <td>1,844578 G</td> <td>-29.03</td> <td>-16.03</td> </tr> <tr> <td>3,000 G</td> <td>7,000 G</td> <td>1,000 M</td> <td>2,988979 G</td> <td>-39.81</td> <td>-26.81</td> </tr> <tr> <td>7,000 G</td> <td>13,600 G</td> <td>1,000 M</td> <td>5,1390000 G</td> <td>-38.44</td> <td>-25.44</td> </tr> <tr> <td>13,600 G</td> <td>19,100 G</td> <td>1,000 M</td> <td>10,251325 G</td> <td>-35.32</td> <td>-22.32</td> </tr> <tr> <td>19,100 G</td> <td>19,100 G</td> <td>1,000 M</td> <td>18,241312 G</td> <td>-26.71</td> <td>-13.71</td> </tr> </tbody> </table> <p>Date: 15.DEC.2016 14:09:14</p>	Start	Stop	RBW	Freq	PwrAbs	ΔLimit	[Hz]	[Hz]	[Hz]	[Hz]	[dBm]	[dB]	30,000 M	1,000 G	1,000 M	821,320000 M	-43.27	-30.27	1,000 G	3,000 G	1,000 M	1,844578 G	-29.03	-16.03	3,000 G	7,000 G	1,000 M	2,988979 G	-39.81	-26.81	7,000 G	13,600 G	1,000 M	5,1390000 G	-38.44	-25.44	13,600 G	19,100 G	1,000 M	10,251325 G	-35.32	-22.32	19,100 G	19,100 G	1,000 M	18,241312 G	-26.71	-13.71
Start	Stop	RBW	Freq	PwrAbs	ΔLimit																																																																																						
[Hz]	[Hz]	[Hz]	[Hz]	[dBm]	[dB]																																																																																						
30,000 M	820,000 M	1,000 M	818,010000 M	-23.92	-22.92																																																																																						
850,000 M	1,000 G	1,000 G	910,211294 M	-44.12	-31.12																																																																																						
1,000 G	3,000 G	1,000 M	1,6045000 G	-42.20	-29.20																																																																																						
3,000 G	7,000 G	1,000 M	5,0970000 G	-39.53	-26.53																																																																																						
7,000 G	9,000 G	1,000 M	8,3600000 G	-36.56	-23.56																																																																																						
Start	Stop	RBW	Freq	PwrAbs	ΔLimit																																																																																						
[Hz]	[Hz]	[Hz]	[Hz]	[dBm]	[dB]																																																																																						
30,000 M	1,000 G	1,000 M	821,320000 M	-43.27	-30.27																																																																																						
1,000 G	3,000 G	1,000 M	1,844578 G	-29.03	-16.03																																																																																						
3,000 G	7,000 G	1,000 M	2,988979 G	-39.81	-26.81																																																																																						
7,000 G	13,600 G	1,000 M	5,1390000 G	-38.44	-25.44																																																																																						
13,600 G	19,100 G	1,000 M	10,251325 G	-35.32	-22.32																																																																																						
19,100 G	19,100 G	1,000 M	18,241312 G	-26.71	-13.71																																																																																						
<p>Middle Channel</p>  <table border="1" data-bbox="239 1131 702 1209"> <thead> <tr> <th>Start</th> <th>Stop</th> <th>RBW</th> <th>Freq</th> <th>PwrAbs</th> <th>ΔLimit</th> </tr> <tr> <th>[Hz]</th> <th>[Hz]</th> <th>[Hz]</th> <th>[Hz]</th> <th>[dBm]</th> <th>[dB]</th> </tr> </thead> <tbody> <tr> <td>30,000 M</td> <td>820,000 M</td> <td>1,000 M</td> <td>818,420000 M</td> <td>-44.12</td> <td>-31.12</td> </tr> <tr> <td>850,000 M</td> <td>1,000 G</td> <td>1,000 M</td> <td>981,132799 M</td> <td>-46.12</td> <td>-33.12</td> </tr> <tr> <td>1,000 G</td> <td>3,000 G</td> <td>1,000 M</td> <td>1,6745000 G</td> <td>-41.90</td> <td>-28.90</td> </tr> <tr> <td>3,000 G</td> <td>7,000 G</td> <td>1,000 M</td> <td>3,6050000 G</td> <td>-39.39</td> <td>-26.39</td> </tr> <tr> <td>7,000 G</td> <td>9,000 G</td> <td>1,000 M</td> <td>7,9130000 G</td> <td>-37.98</td> <td>-24.98</td> </tr> </tbody> </table> <p>Date: 15.DEC.2016 14:24:38</p>	Start	Stop	RBW	Freq	PwrAbs	ΔLimit	[Hz]	[Hz]	[Hz]	[Hz]	[dBm]	[dB]	30,000 M	820,000 M	1,000 M	818,420000 M	-44.12	-31.12	850,000 M	1,000 G	1,000 M	981,132799 M	-46.12	-33.12	1,000 G	3,000 G	1,000 M	1,6745000 G	-41.90	-28.90	3,000 G	7,000 G	1,000 M	3,6050000 G	-39.39	-26.39	7,000 G	9,000 G	1,000 M	7,9130000 G	-37.98	-24.98	<p>Middle Channel</p>  <table border="1" data-bbox="893 1131 1356 1209"> <thead> <tr> <th>Start</th> <th>Stop</th> <th>RBW</th> <th>Freq</th> <th>PwrAbs</th> <th>ΔLimit</th> </tr> <tr> <th>[Hz]</th> <th>[Hz]</th> <th>[Hz]</th> <th>[Hz]</th> <th>[dBm]</th> <th>[dB]</th> </tr> </thead> <tbody> <tr> <td>30,000 M</td> <td>1,000 G</td> <td>1,000 M</td> <td>928,220000 M</td> <td>-42.52</td> <td>-29.52</td> </tr> <tr> <td>1,000 G</td> <td>3,000 G</td> <td>1,000 M</td> <td>1,688239 G</td> <td>-41.89</td> <td>-28.89</td> </tr> <tr> <td>3,000 G</td> <td>7,000 G</td> <td>1,000 M</td> <td>2,994394 G</td> <td>-41.40</td> <td>-28.40</td> </tr> <tr> <td>7,000 G</td> <td>13,600 G</td> <td>1,000 M</td> <td>3,6130000 G</td> <td>-38.23</td> <td>-25.23</td> </tr> <tr> <td>13,600 G</td> <td>19,100 G</td> <td>1,000 M</td> <td>10,244725 G</td> <td>-35.44</td> <td>-22.44</td> </tr> <tr> <td>19,100 G</td> <td>19,100 G</td> <td>1,000 M</td> <td>15,152375 G</td> <td>-26.83</td> <td>-13.83</td> </tr> </tbody> </table> <p>Date: 15.DEC.2016 14:09:59</p>	Start	Stop	RBW	Freq	PwrAbs	ΔLimit	[Hz]	[Hz]	[Hz]	[Hz]	[dBm]	[dB]	30,000 M	1,000 G	1,000 M	928,220000 M	-42.52	-29.52	1,000 G	3,000 G	1,000 M	1,688239 G	-41.89	-28.89	3,000 G	7,000 G	1,000 M	2,994394 G	-41.40	-28.40	7,000 G	13,600 G	1,000 M	3,6130000 G	-38.23	-25.23	13,600 G	19,100 G	1,000 M	10,244725 G	-35.44	-22.44	19,100 G	19,100 G	1,000 M	15,152375 G	-26.83	-13.83
Start	Stop	RBW	Freq	PwrAbs	ΔLimit																																																																																						
[Hz]	[Hz]	[Hz]	[Hz]	[dBm]	[dB]																																																																																						
30,000 M	820,000 M	1,000 M	818,420000 M	-44.12	-31.12																																																																																						
850,000 M	1,000 G	1,000 M	981,132799 M	-46.12	-33.12																																																																																						
1,000 G	3,000 G	1,000 M	1,6745000 G	-41.90	-28.90																																																																																						
3,000 G	7,000 G	1,000 M	3,6050000 G	-39.39	-26.39																																																																																						
7,000 G	9,000 G	1,000 M	7,9130000 G	-37.98	-24.98																																																																																						
Start	Stop	RBW	Freq	PwrAbs	ΔLimit																																																																																						
[Hz]	[Hz]	[Hz]	[Hz]	[dBm]	[dB]																																																																																						
30,000 M	1,000 G	1,000 M	928,220000 M	-42.52	-29.52																																																																																						
1,000 G	3,000 G	1,000 M	1,688239 G	-41.89	-28.89																																																																																						
3,000 G	7,000 G	1,000 M	2,994394 G	-41.40	-28.40																																																																																						
7,000 G	13,600 G	1,000 M	3,6130000 G	-38.23	-25.23																																																																																						
13,600 G	19,100 G	1,000 M	10,244725 G	-35.44	-22.44																																																																																						
19,100 G	19,100 G	1,000 M	15,152375 G	-26.83	-13.83																																																																																						
<p>Highest Channel</p>  <table border="1" data-bbox="239 1646 702 1724"> <thead> <tr> <th>Start</th> <th>Stop</th> <th>RBW</th> <th>Freq</th> <th>PwrAbs</th> <th>ΔLimit</th> </tr> <tr> <th>[Hz]</th> <th>[Hz]</th> <th>[Hz]</th> <th>[Hz]</th> <th>[dBm]</th> <th>[dB]</th> </tr> </thead> <tbody> <tr> <td>30,000 M</td> <td>820,000 M</td> <td>1,000 M</td> <td>803,123000 M</td> <td>-40.17</td> <td>-27.17</td> </tr> <tr> <td>850,000 M</td> <td>1,000 G</td> <td>1,000 M</td> <td>850,072000 M</td> <td>-30.59</td> <td>-17.59</td> </tr> <tr> <td>1,000 G</td> <td>3,000 G</td> <td>1,000 M</td> <td>1,6925000 G</td> <td>-42.82</td> <td>-28.82</td> </tr> <tr> <td>3,000 G</td> <td>7,000 G</td> <td>1,000 M</td> <td>3,0170000 G</td> <td>-39.40</td> <td>-26.40</td> </tr> <tr> <td>7,000 G</td> <td>9,000 G</td> <td>1,000 M</td> <td>8,1420000 G</td> <td>-36.97</td> <td>-23.97</td> </tr> </tbody> </table> <p>Date: 15.DEC.2016 14:25:23</p>	Start	Stop	RBW	Freq	PwrAbs	ΔLimit	[Hz]	[Hz]	[Hz]	[Hz]	[dBm]	[dB]	30,000 M	820,000 M	1,000 M	803,123000 M	-40.17	-27.17	850,000 M	1,000 G	1,000 M	850,072000 M	-30.59	-17.59	1,000 G	3,000 G	1,000 M	1,6925000 G	-42.82	-28.82	3,000 G	7,000 G	1,000 M	3,0170000 G	-39.40	-26.40	7,000 G	9,000 G	1,000 M	8,1420000 G	-36.97	-23.97	<p>Highest Channel</p>  <table border="1" data-bbox="893 1646 1356 1724"> <thead> <tr> <th>Start</th> <th>Stop</th> <th>RBW</th> <th>Freq</th> <th>PwrAbs</th> <th>ΔLimit</th> </tr> <tr> <th>[Hz]</th> <th>[Hz]</th> <th>[Hz]</th> <th>[Hz]</th> <th>[dBm]</th> <th>[dB]</th> </tr> </thead> <tbody> <tr> <td>30,000 M</td> <td>1,000 G</td> <td>1,000 M</td> <td>170,405000 M</td> <td>-40.74</td> <td>-27.74</td> </tr> <tr> <td>1,000 G</td> <td>3,000 G</td> <td>1,000 M</td> <td>1,021394 G</td> <td>-42.10</td> <td>-29.10</td> </tr> <tr> <td>3,000 G</td> <td>7,000 G</td> <td>1,000 M</td> <td>1,933042 G</td> <td>-27.60</td> <td>-14.60</td> </tr> <tr> <td>7,000 G</td> <td>13,600 G</td> <td>1,000 M</td> <td>3,0930000 G</td> <td>-38.48</td> <td>-25.48</td> </tr> <tr> <td>13,600 G</td> <td>19,100 G</td> <td>1,000 M</td> <td>10,230700 G</td> <td>-35.33</td> <td>-22.33</td> </tr> <tr> <td>19,100 G</td> <td>19,100 G</td> <td>1,000 M</td> <td>10,305687 G</td> <td>-26.41</td> <td>-13.41</td> </tr> </tbody> </table> <p>Date: 15.DEC.2016 14:10:45</p>	Start	Stop	RBW	Freq	PwrAbs	ΔLimit	[Hz]	[Hz]	[Hz]	[Hz]	[dBm]	[dB]	30,000 M	1,000 G	1,000 M	170,405000 M	-40.74	-27.74	1,000 G	3,000 G	1,000 M	1,021394 G	-42.10	-29.10	3,000 G	7,000 G	1,000 M	1,933042 G	-27.60	-14.60	7,000 G	13,600 G	1,000 M	3,0930000 G	-38.48	-25.48	13,600 G	19,100 G	1,000 M	10,230700 G	-35.33	-22.33	19,100 G	19,100 G	1,000 M	10,305687 G	-26.41	-13.41
Start	Stop	RBW	Freq	PwrAbs	ΔLimit																																																																																						
[Hz]	[Hz]	[Hz]	[Hz]	[dBm]	[dB]																																																																																						
30,000 M	820,000 M	1,000 M	803,123000 M	-40.17	-27.17																																																																																						
850,000 M	1,000 G	1,000 M	850,072000 M	-30.59	-17.59																																																																																						
1,000 G	3,000 G	1,000 M	1,6925000 G	-42.82	-28.82																																																																																						
3,000 G	7,000 G	1,000 M	3,0170000 G	-39.40	-26.40																																																																																						
7,000 G	9,000 G	1,000 M	8,1420000 G	-36.97	-23.97																																																																																						
Start	Stop	RBW	Freq	PwrAbs	ΔLimit																																																																																						
[Hz]	[Hz]	[Hz]	[Hz]	[dBm]	[dB]																																																																																						
30,000 M	1,000 G	1,000 M	170,405000 M	-40.74	-27.74																																																																																						
1,000 G	3,000 G	1,000 M	1,021394 G	-42.10	-29.10																																																																																						
3,000 G	7,000 G	1,000 M	1,933042 G	-27.60	-14.60																																																																																						
7,000 G	13,600 G	1,000 M	3,0930000 G	-38.48	-25.48																																																																																						
13,600 G	19,100 G	1,000 M	10,230700 G	-35.33	-22.33																																																																																						
19,100 G	19,100 G	1,000 M	10,305687 G	-26.41	-13.41																																																																																						



### Frequency Stability

Test Conditions	Middle Channel	WCDMA Band V (RMC 12.2Kbps)	Limit 2.5ppm
Temperature (°C)	Voltage (Volt)	Deviation (ppm)	Result
50	Normal Voltage	0.0005	PASS
40	Normal Voltage	0.0011	
30	Normal Voltage	0.0005	
20(Ref.)	Normal Voltage	0.0000	
10	Normal Voltage	0.0011	
0	Normal Voltage	0.0122	
-10	Normal Voltage	0.0154	
-20	Normal Voltage	0.0149	
-30	Normal Voltage	0.0138	
20	Maximum Voltage	0.0011	
20	Normal Voltage	0.0000	
20	Battery End Point	0.0000	

Test Conditions	Middle Channel	WCDMA Band II (RMC 12.2Kbps)	Limit Note 2.
Temperature (°C)	Voltage (Volt)	Deviation (ppm)	Result
50	Normal Voltage	0.0012	PASS
40	Normal Voltage	0.0024	
30	Normal Voltage	0.0012	
20(Ref.)	Normal Voltage	0.0000	
10	Normal Voltage	0.0012	
0	Normal Voltage	0.0036	
-10	Normal Voltage	0.0060	
-20	Normal Voltage	0.0024	
-30	Normal Voltage	0.0048	
20	Maximum Voltage	0.0012	
20	Normal Voltage	0.0000	
20	Battery End Point	0.0012	

**Note:**

1. Normal Voltage = 3.85V. ; Battery End Point (BEP) = 3.4 V. ; Maximum Voltage =4.35 V
2. The frequency fundamental emissions stay within the authorized frequency block.



## Appendix B. Test Results of ERP/EIRP and Radiated Test

### ERP/EIRP

Channel	Mode	Conducted		ERP	
		Power (dBm)	Power (Watts)	ERP(dBm)	ERP(W)
Lowest	GSM850	33.05	2.0184	27.50	0.5623
Middle	GPRS class 8	33.06	2.0230	27.51	0.5636
Highest	(GT - LC = -3.4 dB)	32.97	1.9815	27.42	0.5521
Lowest	GSM850	27.16	0.5200	21.61	0.1449
Middle	EDGE class 8	27.21	0.5260	21.66	0.1466
Highest	(GT - LC = -3.4 dB)	27.11	0.5140	21.56	0.1432
Lowest	WCDMA Band V	24.53	0.2838	18.98	0.0791
Middle	RMC 12.2Kbps	24.60	0.2884	19.05	0.0804
Highest	(GT - LC = -3.4 dB)	24.68	0.2938	19.13	0.0818
Limit	ERP < 7W	Result		PASS	

Channel	Mode	Conducted		EIRP	
		Power (dBm)	Power (Watts)	EIRP(dBm)	EIRP(W)
Lowest	GSM1900	30.26	1.0617	31.06	1.2764
Middle	GPRS class 8	30.08	1.0186	30.88	1.2246
Highest	(GT - LC = 0.8 dB)	30.15	1.0351	30.95	1.2445
Lowest	GSM1900	25.74	0.3750	26.54	0.4508
Middle	EDGE class 8	25.71	0.3724	26.51	0.4477
Highest	(GT - LC = 0.8 dB)	25.95	0.3936	26.75	0.4732
Lowest	WCDMA Band II	22.94	0.1968	23.74	0.2366
Middle	RMC 12.2Kbps	22.78	0.1897	23.58	0.2280
Highest	(GT - LC = 0.8 dB)	22.73	0.1875	23.53	0.2254
Limit	EIRP < 2W	Result		PASS	





### Radiated Spurious Emission

GSM850 (GPRS class 8)									
Channel	Frequency ( MHz )	ERP ( dBm )	Limit ( dBm )	Over Limit ( dB )	SPA Reading (dBm)	S.G. Power ( dBm )	TX Cable loss ( dB )	TX Antenna Gain (dBi)	Polarization (H/V)
Lowest	1648	-51.52	-13	-38.52	-61.29	-53.28	0.98	4.89	H
	2472	-42.95	-13	-29.95	-56.65	-44.83	1.28	5.32	H
	4120	-33.49	-13	-20.49	-51.59	-38.13	1.83	8.62	H
									H
									H
									H
	1648	-50.57	-13	-37.57	-60.28	-52.33	0.98	4.89	V
	2472	-48.45	-13	-35.45	-62.19	-50.33	1.28	5.32	V
	4120	-39.24	-13	-26.24	-57.28	-43.88	1.83	8.62	V
									V
									V
Middle	1672	-51.72	-13	-38.72	-61.62	-53.4	0.99	4.82	H
	2512	-44.11	-13	-31.11	-57.96	-46.08	1.29	5.41	H
	4184	-41.45	-13	-28.45	-59.69	-46.07	1.87	8.64	H
									H
									H
									H
	1672	-51.12	-13	-38.12	-60.96	-52.8	0.99	4.82	V
	2512	-46.98	-13	-33.98	-60.85	-48.95	1.29	5.41	V
	4184	-45.97	-13	-32.97	-64.12	-50.59	1.87	8.64	V
									V
									V
Highest	1696	-47.48	-13	-34.48	-57.47	-49.08	1.00	4.75	H
	2544	-39.90	-13	-26.90	-53.87	-41.88	1.30	5.44	H
	4240	-46.39	-13	-33.39	-64.81	-50.99	1.90	8.65	H
									H
									H
									H
	1696	-49.44	-13	-36.44	-59.37	-51.04	1.00	4.75	V
	2544	-44.70	-13	-31.70	-58.66	-46.68	1.30	5.44	V
	4240	-49.10	-13	-36.10	-67.4	-53.7	1.90	8.65	V
									V
									V

Remark: Spurious emissions within 30-1000MHz were found more than 20dB below limit line.



GSM850 (EDGE class 8)									
Channel	Frequency ( MHz )	ERP ( dBm )	Limit ( dBm )	Over Limit ( dB )	SPA Reading (dBm)	S.G. Power ( dBm )	TX Cable loss ( dB )	TX Antenna Gain (dBi)	Polarization (H/V)
Lowest	1648	-55.45	-13	-42.45	-65.22	-57.21	0.98	4.89	H
	2472	-53.94	-13	-40.94	-67.64	-55.82	1.28	5.32	H
	3296	-53.86	-13	-40.86	-69.82	-57.27	1.54	7.10	H
									H
									H
									H
	1648	-57.12	-13	-44.12	-66.83	-58.88	0.98	4.89	V
	2472	-55.32	-13	-42.32	-69.06	-57.2	1.28	5.32	V
	3296	-53.22	-13	-40.22	-69.12	-56.63	1.54	7.10	V
									V
									V
									V
Middle	1672	-58.46	-13	-45.46	-68.36	-60.14	0.99	4.82	H
	2512	-55.32	-13	-42.32	-69.17	-57.29	1.29	5.41	H
	3344	-53.86	-13	-40.86	-69.89	-57.47	1.56	7.31	H
									H
									H
									H
	1672	-56.78	-13	-43.78	-66.62	-58.46	0.99	4.82	V
	2512	-54.75	-13	-41.75	-68.62	-56.72	1.29	5.41	V
	3344	-54.30	-13	-41.30	-70.34	-57.91	1.56	7.31	V
									V
									V
									V
Highest	1696	-55.59	-13	-42.59	-65.58	-57.19	1.00	4.75	H
	2544	-52.97	-13	-39.97	-66.94	-54.95	1.30	5.44	H
	3392	-53.52	-13	-40.52	-69.6	-57.32	1.57	7.52	H
									H
									H
									H
	1696	-55.44	-13	-42.44	-65.37	-57.04	1.00	4.75	V
	2544	-56.07	-13	-43.07	-70.03	-58.05	1.30	5.44	V
	3392	-54.04	-13	-41.04	-70.22	-57.84	1.57	7.52	V
									V
									V
									V

Remark: Spurious emissions within 30-1000MHz were found more than 20dB below limit line.



GSM1900 (GPRS class 8)									
Channel	Frequency ( MHz )	EIRP ( dBm )	Limit ( dBm )	Over Limit ( dB )	SPA Reading (dBm)	S.G. Power ( dBm )	TX Cable loss ( dB )	TX Antenna Gain (dBi)	Polarization (H/V)
Lowest	3702	-48.09	-13	-35.09	-64.93	-54.66	1.67	8.24	H
	5550	-45.87	-13	-32.87	-68.53	-52.94	2.65	9.72	H
	7398	-50.11	-13	-37.11	-77.15	-59.24	2.46	11.60	H
									H
									H
									H
	3702	-46.72	-13	-33.72	-63.72	-53.29	1.67	8.24	V
	5550	-42.09	-13	-29.09	-64.58	-49.16	2.65	9.72	V
	7398	-50.21	-13	-37.21	-77.28	-59.34	2.46	11.60	V
									V
									V
									V
Middle	3762	-43.05	-13	-30.05	-60.05	-49.68	1.69	8.31	H
	5640	-42.89	-13	-29.89	-65.69	-49.94	2.71	9.76	H
	7518	-49.82	-13	-36.82	-77.09	-59.21	2.42	11.81	H
									H
									H
									H
	3762	-43.90	-13	-30.90	-61.03	-50.53	1.69	8.31	V
	5640	-41.60	-13	-28.60	-64.24	-48.65	2.71	9.76	V
	7518	-48.07	-13	-35.07	-75.46	-57.46	2.42	11.81	V
									V
									V
									V
Highest	3822	-38.85	-13	-25.85	-56.06	-45.53	1.71	8.39	H
	5730	-48.36	-13	-35.36	-71.3	-55.39	2.76	9.79	H
	7638	-48.04	-13	-35.04	-75.44	-57.54	2.38	11.88	H
									H
									H
									H
	3822	-40.92	-13	-27.92	-58.22	-47.6	1.71	8.39	V
	5730	-42.39	-13	-29.39	-65.19	-49.42	2.76	9.79	V
	7638	-48.77	-13	-35.77	-76.25	-58.27	2.38	11.88	V
									V
									V
									V

Remark: Spurious emissions within 30-1000MHz were found more than 20dB below limit line.



GSM1900 (EDGE class 8)									
Channel	Frequency ( MHz )	EIRP ( dBm )	Limit ( dBm )	Over Limit ( dB )	SPA Reading (dBm)	S.G. Power ( dBm )	TX Cable loss ( dB )	TX Antenna Gain (dBi)	Polarization (H/V)
Lowest	3702	-55.32	-13	-42.32	-72.16	-61.89	1.67	8.24	H
	5550	-55.08	-13	-42.08	-77.74	-62.15	2.65	9.72	H
	7398	-50.60	-13	-37.60	-77.64	-59.73	2.46	11.60	H
									H
									H
									H
	3702	-55.53	-13	-42.53	-72.53	-62.1	1.67	8.24	V
	5550	-53.82	-13	-40.82	-76.31	-60.89	2.65	9.72	V
	7398	-50.59	-13	-37.59	-77.66	-59.72	2.46	11.60	V
									V
									V
									V
Middle	3762	-51.84	-13	-38.84	-68.84	-58.47	1.69	8.31	H
	5640	-53.84	-13	-40.84	-76.64	-60.89	2.71	9.76	H
	7518	-50.03	-13	-37.03	-77.3	-59.42	2.42	11.81	H
									H
									H
									H
	3762	-53.22	-13	-40.22	-70.35	-59.85	1.69	8.31	V
	5640	-50.91	-13	-37.91	-73.55	-57.96	2.71	9.76	V
	7518	-48.34	-13	-35.34	-75.73	-57.73	2.42	11.81	V
									V
									V
									V
Highest	3822	-49.12	-13	-36.12	-66.33	-55.8	1.71	8.39	H
	5730	-54.24	-13	-41.24	-77.18	-61.27	2.76	9.79	H
	7638	-49.54	-13	-36.54	-76.94	-59.04	2.38	11.88	H
									H
									H
									H
	3822	-49.29	-13	-36.29	-66.59	-55.97	1.71	8.39	V
	5730	-52.34	-13	-39.34	-75.14	-59.37	2.76	9.79	V
	7638	-49.33	-13	-36.33	-76.81	-58.83	2.38	11.88	V
									V
									V
									V

Remark: Spurious emissions within 30-1000MHz were found more than 20dB below limit line.



WCDMA Band V(RMC 12.2Kbps)									
Channel	Frequency ( MHz )	ERP ( dBm )	Limit ( dBm )	Over Limit ( dB )	SPA Reading (dBm)	S.G. Power ( dBm )	TX Cable loss ( dB )	TX Antenna Gain (dBi)	Polarization (H/V)
Lowest	1652	-58.88	-13	-45.88	-68.68	-60.62	0.98	4.87	H
	2479	-55.30	-13	-42.30	-69	-57.2	1.28	5.34	H
	3305	-53.35	-13	-40.35	-69.33	-56.8	1.54	7.14	H
									H
									H
									H
	1652	-58.99	-13	-45.99	-68.73	-60.73	0.98	4.87	V
	2479	-55.92	-13	-42.92	-69.66	-57.82	1.28	5.34	V
	3305	-52.85	-13	-39.85	-68.79	-56.3	1.54	7.14	V
									V
									V
									V
Middle	1672	-58.41	-13	-45.41	-68.31	-60.09	0.99	4.82	H
	2509	-56.26	-13	-43.26	-70.11	-58.22	1.29	5.41	H
	3345	-53.92	-13	-40.92	-69.95	-57.53	1.56	7.32	H
									H
									H
									H
	1672	-58.08	-13	-45.08	-67.92	-59.76	0.99	4.82	V
	2509	-55.06	-13	-42.06	-68.93	-57.02	1.29	5.41	V
	3345	-53.71	-13	-40.71	-69.75	-57.32	1.56	7.32	V
									V
									V
									V
Highest	1693	-58.19	-13	-45.19	-68.18	-59.8	1.00	4.76	H
	2539	-55.96	-13	-42.96	-69.93	-57.94	1.30	5.43	H
	3386	-53.23	-13	-40.23	-69.3	-57.014	1.57	7.50	H
									H
									H
									H
	1693	-58.19	-13	-45.19	-68.12	-59.8	1.00	4.76	V
	2539	-56.03	-13	-43.03	-69.99	-58.01	1.30	5.43	V
	3386	-53.78	-13	-40.78	-69.92	-57.56	1.57	7.50	V
									V
									V
									V

Remark: Spurious emissions within 30-1000MHz were found more than 20dB below limit line.



WCDMA Band II(RMC 12.2Kbps)									
Channel	Frequency ( MHz )	EIRP ( dBm )	Limit ( dBm )	Over Limit ( dB )	SPA Reading (dBm)	S.G. Power ( dBm )	TX Cable loss ( dB )	TX Antenna Gain (dBi)	Polarization (H/V)
Lowest	3708	-54.75	-13	-41.75	-71.59	-61.33	1.67	8.25	H
	5562	-54.52	-13	-41.52	-77.17	-61.58	2.66	9.72	H
	7416	-50.30	-13	-37.30	-77.36	-59.48	2.46	11.63	H
									H
									H
									H
	3708	-53.31	-13	-40.31	-70.31	-59.89	1.67	8.25	V
	5562	-53.66	-13	-40.66	-76.14	-60.72	2.66	9.72	V
	7416	-50.13	-13	-37.13	-77.24	-59.31	2.46	11.63	V
									V
									V
									V
Middle	3762	-54.85	-13	-41.85	-71.85	-61.48	1.69	8.31	H
	5640	-54.48	-13	-41.48	-77.28	-61.53	2.71	9.76	H
	7518	-50.03	-13	-37.03	-77.3	-59.42	2.42	11.81	H
									H
									H
									H
	3762	-53.73	-13	-40.73	-70.86	-60.36	1.69	8.31	V
	5640	-53.35	-13	-40.35	-75.99	-60.4	2.71	9.76	V
	7518	-49.95	-13	-36.95	-77.34	-59.34	2.42	11.81	V
									V
									V
									V
Highest	3816	-54.51	-13	-41.51	-71.71	-61.19	1.70	8.38	H
	5724	-54.16	-13	-41.16	-77.1	-61.2	2.75	9.79	H
	7632	-49.71	-13	-36.71	-77.11	-59.2	2.39	11.88	H
									H
									H
									H
	3816	-53.11	-13	-40.11	-70.4	-59.79	1.70	8.38	V
	5724	-53.57	-13	-40.57	-76.37	-60.61	2.75	9.79	V
	7632	-50.50	-13	-37.50	-76.98	-59.99	2.39	11.88	V
									V
									V
									V

Remark: Spurious emissions within 30-1000MHz were found more than 20dB below limit line.