



# FCC RF Test Report

**APPLICANT** : Sony Mobile Communications Inc.  
**EQUIPMENT** : GSM/WCDMA/LTE Phone+Bluetooth, DTS/UNII  
a/b/g/n and NFC  
**BRAND NAME** : Sony  
**FCC ID** : PY7-08618V  
**STANDARD** : FCC Part 15 Subpart E §15.407  
**CLASSIFICATION** : (NII) Unlicensed National Information Infrastructure

The product was received on Dec. 29, 2016 and testing was completed on Jan. 16, 2017. We, SPORTON INTERNATIONAL INC., would like to declare that the tested sample has been evaluated in accordance with the test procedures and has been in compliance with the applicable technical standards.

The test results in this report apply exclusively to the tested model / sample. Without written approval of SPORTON INTERNATIONAL INC., the test report shall not be reproduced except in full.

Reviewed by: Joseph Lin / Supervisor

Approved by: Jones Tsai / Manager



## SPORTON INTERNATIONAL INC.

No. 52, Hwa Ya 1<sup>st</sup> Rd., Hwa Ya Technology Park, Kwei-Shan District, Tao Yuan City, Taiwan, R.O.C.

SPORTON INTERNATIONAL INC.

TEL : 886-3-327-3456

FAX : 886-3-328-4978

FCC ID : PY7-08618V

Page Number : 1 of 37

Report Issued Date : Mar. 13, 2017

Report Version : Rev. 02

Report Template No.: BU5-FR15EWLB4 AC MA Version 1.4



# TABLE OF CONTENTS

**REVISION HISTORY ..... 3**

**SUMMARY OF TEST RESULT ..... 4**

**1 GENERAL DESCRIPTION ..... 5**

    1.1 Applicant ..... 5

    1.2 Manufacturer ..... 5

    1.3 Product Feature of Equipment Under Test ..... 5

    1.4 Modification of EUT ..... 6

    1.5 Testing Location ..... 7

    1.6 Applicable Standards ..... 8

**2 TEST CONFIGURATION OF EQUIPMENT UNDER TEST ..... 9**

    2.1 Carrier Frequency and Channel ..... 9

    2.2 Test Mode ..... 10

    2.3 Connection Diagram of Test System ..... 11

    2.4 Support Unit used in test configuration and system ..... 12

    2.5 EUT Operation Test Setup ..... 12

    2.6 Measurement Results Explanation Example ..... 12

**3 TEST RESULT ..... 13**

    3.1 6dB and 26dB and 99% Occupied Bandwidth Measurement ..... 13

    3.2 Maximum Conducted Output Power Measurement ..... 16

    3.3 Power Spectral Density Measurement ..... 17

    3.4 Unwanted Emissions Measurement ..... 20

    3.5 AC Conducted Emission Measurement ..... 26

    3.6 Frequency Stability Measurement ..... 32

    3.7 Automatically Discontinue Transmission ..... 33

    3.8 Antenna Requirements ..... 34

**4 LIST OF MEASURING EQUIPMENT ..... 35**

**5 UNCERTAINTY OF EVALUATION ..... 37**

**APPENDIX A. CONDUCTED TEST RESULTS**

**APPENDIX B. RADIATED SPURIOUS EMISSION**

**APPENDIX C. RADIATED SPURIOUS EMISSION PLOTS**

**APPENDIX D. DUTY CYCLE PLOTS**



### REVISION HISTORY

REPORT NO.	VERSION	DESCRIPTION	ISSUED DATE
FR6D2925F	Rev. 01	Initial issue of report	Mar. 03, 2017
FR6D2925F	Rev. 02	Revising the description of limit of unwanted emissions in report section 3.4.1.	Mar. 13, 2017



### SUMMARY OF TEST RESULT

Report Section	FCC Rule	Description	Limit	Result	Remark
3.1	15.403(i)	6dB, 26dB and 99% Occupied Bandwidth	> 500kHz	Pass	-
3.2	15.407(a)	Maximum Conducted Output Power	≤ 30 dBm	Pass	-
3.3	15.407(a)	Power Spectral Density	≤ 30 dBm/500kHz	Pass	-
3.4	15.407(b)	Unwanted Emissions	15.407(b)(4)(i) & 15.209(a)	Pass	Under limit 5.41 dB at 149.340 MHz
3.5	15.207	AC Conducted Emission	15.207(a)	Pass	Under limit 13.50 dB at 3.998 MHz
0	15.407(g)	Frequency Stability	Within Operation Band	Pass	-
3.7	15.407(c)	Automatically Discontinue Transmission	Discontinue Transmission	Pass	-
3.8	15.203 & 15.407(a)	Antenna Requirement	N/A	Pass	-



# 1 General Description

## 1.1 Applicant

**Sony Mobile Communications Inc.**

4-12-3 Higashi-Shinagawa, Shinagawa-ku, Tokyo, 140-0002, Japan

## 1.2 Manufacturer

**Sony Mobile Communications Inc.**

4-12-3 Higashi-Shinagawa, Shinagawa-ku, Tokyo, 140-0002, Japan

## 1.3 Product Feature of Equipment Under Test

GSM/WCDMA/LTE, Bluetooth, DTS/UNII, a/b/g/n, NFC, and GPS

Standards-related Product Specification	
Antenna Type / Gain	PIFA Antenna with gain -2.10 dBi

EUT Information List			
HW Version	SW Version	S/N	Performed Test Item
A	1.21	0123456789ABCDEF	RF conducted measurement
		WUJ01NNJAG	Radiated Spurious Emission
		WUJ01NNPAN	Conducted Emission



Accessory List	
AC Adapter	Model No. : EP800
	S/N :
	3015W41600900 (for radiated spurious emission) 3015W42100643 (for conducted emission)
Earphone	Model No. : MH410c
	S/N: N/A
USB Cable	Model No. : UCB20
	S/N :
	1635A91C00314D8 (for radiated spurious emission) 1635A9100031498 (for conducted emission)

**Note:**

1. Above EUT list and accessory list used are electrically identical per declared by manufacturer.
2. Above the accessories list are used to exercise the EUT during test.
3. For other wireless features of this EUT, test report will be issued separately.

### 1.4 Modification of EUT

No modifications are made to the EUT during all test items.



### 1.5 Testing Location

Sporton Lab is accredited to ISO 17025 by Taiwan Accreditation Foundation (TAF code : 1190) and the FCC designation No. TW0007 under the FCC 2.948(e) by Mutual Recognition Agreement (MRA) in FCC Test.

<b>Test Site</b>	SPORTON INTERNATIONAL INC.	
<b>Test Site Location</b>	No. 52, Hwa Ya 1 <sup>st</sup> Rd., Hwa Ya Technology Park, Kwei-Shan District, Tao Yuan City, Taiwan, R.O.C. TEL: +886-3-327-3456 FAX: +886-3-328-4978	
<b>Test Site No.</b>	<b>Sporton Site No.</b>	
	TH05-HY	CO05-HY

**Note:** The test site complies with ANSI C63.4 2014 requirement.

<b>Test Site</b>	SPORTON INTERNATIONAL INC.	
<b>Test Site Location</b>	No.58, Aly. 75, Ln. 564, Wenhua 3rd Rd. Guishan Dist, Taoyuan City, Taiwan (R.O.C.) TEL: +886-3-327-0868 FAX: +886-3-327-0855	
<b>Test Site No.</b>	<b>Sporton Site No.</b>	
	03CH12-HY	

**Note:** The test site complies with ANSI C63.4 2014 requirement.



## 1.6 Applicable Standards

According to the specifications of the manufacturer, the EUT must comply with the requirements of the following standards:

- ♦ FCC Part 15 Subpart E
- ♦ FCC KDB 789033 D02 General UNII Test Procedures New Rules v01r03
- ♦ ANSI C63.10-2013

### **Remark:**

1. All test items were verified and recorded according to the standards and without any deviation during the test.
2. This EUT has also been tested and complied with the requirements of FCC Part 15, Subpart B, recorded in a separate test report.





## 2 Test Configuration of Equipment Under Test

The EUT has been associated with peripherals and configuration operated in a manner tended to maximize its emission characteristics in a typical application. Frequency range investigated: conducted emission (150 kHz to 30 MHz) and radiated emission (9 kHz to the 10th harmonic of the highest fundamental frequency or to 40 GHz, whichever is lower). For radiated measurement, pre-scanned in three orthogonal panels, X, Y, Z. The worst cases (X plane) were recorded in this report.

### 2.1 Carrier Frequency and Channel

Frequency Band	Channel	Freq. (MHz)	Channel	Freq. (MHz)
5725-5850 MHz Band 4 (U-NII-3)	149	5745	157	5785
	151*	5755	159*	5795
	153	5765	161	5805
	-	-	165	5825

**Note:** The above Frequency and Channel in "\*" were 802.11n HT40.



## 2.2 Test Mode

Final test mode of conducted test items and radiated spurious emissions are considering the modulation and worse data rates as below table.

Modulation	Data Rate
802.11a	6 Mbps
802.11n HT20	MCS0
802.11n HT40	MCS0

<b>AC Conducted Emission</b>	Mode 1 : GSM1900 Idle + Bluetooth Link + WLAN (5GHz) Link + MP3 + Earphone + Battery + USB Cable (Charging from Adapter)
------------------------------	--

Ch. #		Band IV : 5725-5850 MHz		
		802.11a	802.11n HT20	802.11n HT40
L	Low	149	149	151
M	Middle	157	157	-
H	High	165	165	159

## 2.3 Connection Diagram of Test System

<WLAN Tx Mode>

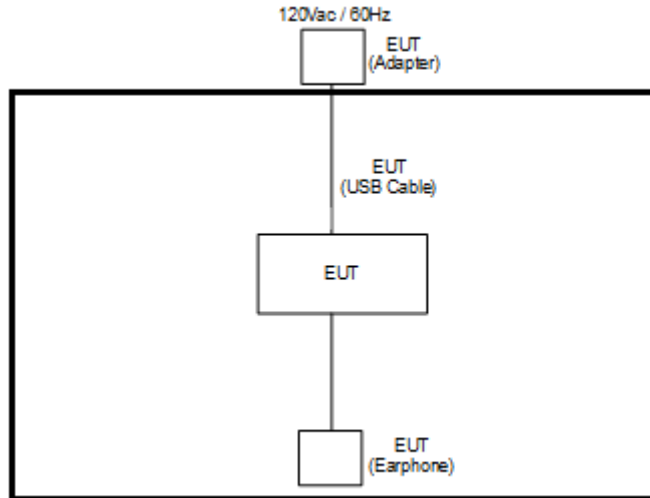

<AC Conducted Emission Mode>

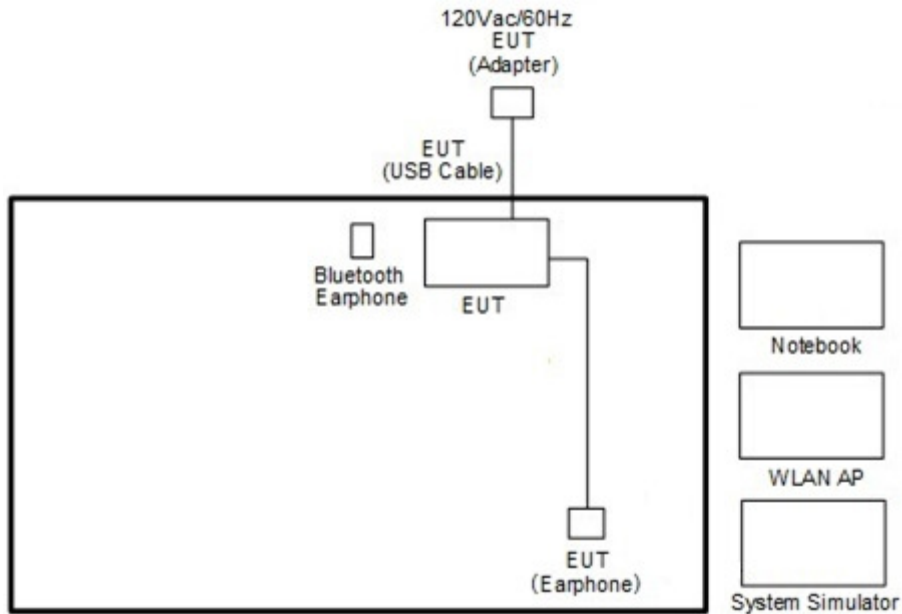



## 2.4 Support Unit used in test configuration and system

Item	Equipment	Trade Name	Model Name	FCC ID	Data Cable	Power Cord
1.	System Simulator	Anritsu	MT8820C	N/A	N/A	Unshielded, 1.8 m
2.	WLAN AP	ASUS	RT-AC66U	MSQ-RTAC66U	N/A	Unshielded, 1.8 m
3.	Notebook	DELL	Latitude E6320	FCC DoC/ Contains FCC ID: QDS-BRCM1054	N/A	AC I/P: Unshielded, 1.2 m DC O/P: Shielded, 1.8 m
4.	Bluetooth Earphone	Sony	SBH20	PY7-RD0010	N/A	N/A
5.	SD Card	SanDisk	MicroSD HC	FCC DoC	N/A	N/A

## 2.5 EUT Operation Test Setup

For RF test items, an engineering test program was provided and enabled to make EUT transmitting signals.

## 2.6 Measurement Results Explanation Example

For all conducted test items:

The offset level is set in the spectrum analyzer to compensate the RF cable loss and attenuator factor between EUT conducted output port and spectrum analyzer. With the offset compensation, the spectrum analyzer reading level is exactly the EUT RF output level.

Example :

The spectrum analyzer offset is derived from RF cable loss and attenuator factor.

*Offset = RF cable loss + attenuator factor.*

Following shows an offset computation example with cable loss 4.2 dB and 10dB attenuator.

$$\begin{aligned} \text{Offset(dB)} &= \text{RF cable loss(dB)} + \text{attenuator factor(dB)}. \\ &= 4.2 + 10 = 14.2 \text{ (dB)} \end{aligned}$$

### 3 Test Result

#### 3.1 6dB and 26dB and 99% Occupied Bandwidth Measurement

##### 3.1.1 Description of 6dB and 26dB and 99% Occupied Bandwidth

The minimum 6 dB bandwidth shall be at least 500 kHz.

26dB and 99% Occupied bandwidth are reporting only.

##### 3.1.2 Measuring Instruments

The measuring equipment is listed in the section 4 of this test report.

##### 3.1.3 Test Procedures

1. The testing follows FCC KDB 789033 D02 General UNII Test Procedures New Rules v01r03.  
Section C) Emission bandwidth for the band 5.725-5.85GHz
2. Set RBW = 100kHz.
3. Set the VBW  $\geq 3 \times$  RBW.
4. Detector = Peak.
5. Trace mode = max hold
6. Measure the maximum width of the emission that is 6 dB down from the peak of the emission.
7. Measure and record the results in the test report.

##### 3.1.4 Test Setup





### 3.1.5 Test Result of 6dB Bandwidth

Please refer to Appendix A.

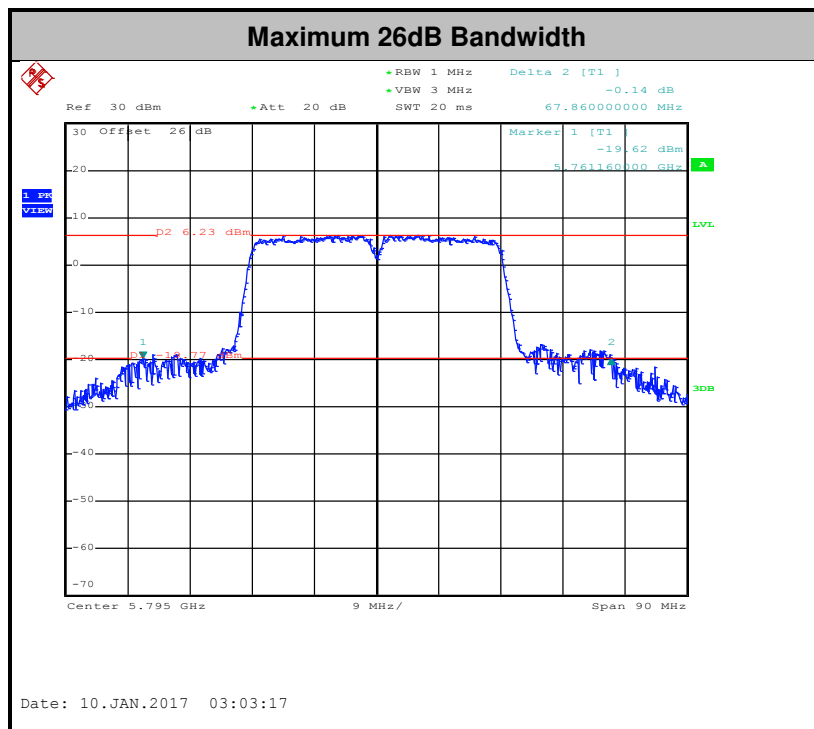
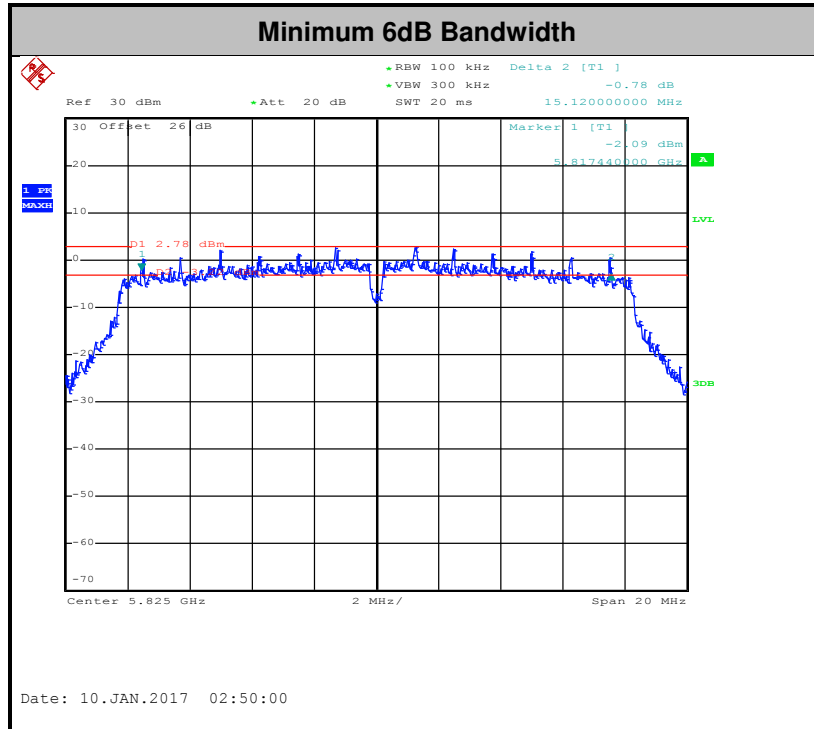

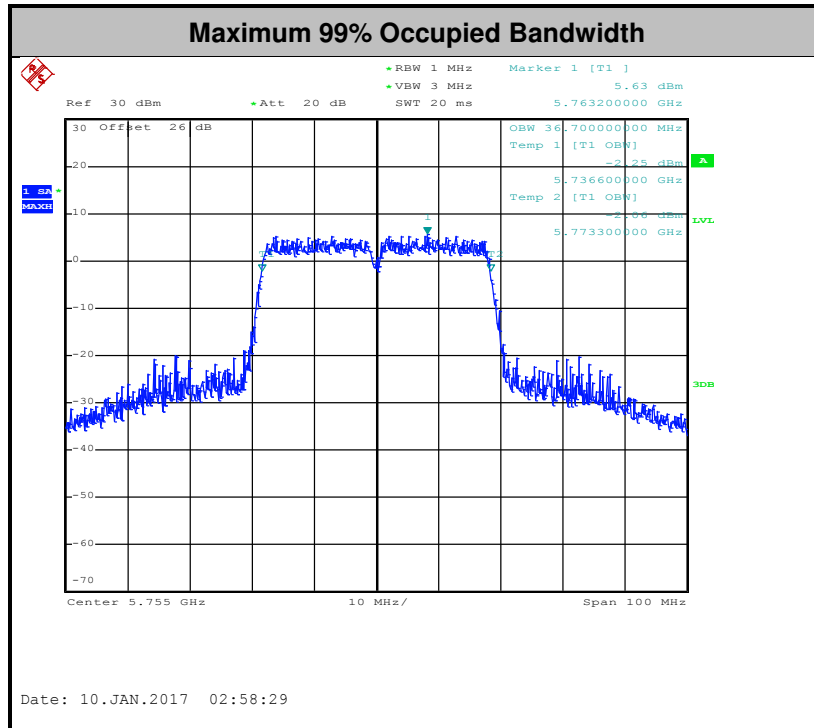

**Note:** The occupied channel bandwidth is maintained within the band of operation for all of the modulations.

## 3.2 Maximum Conducted Output Power Measurement

### 3.2.1 Limit of Maximum Conducted Output Power

For the band 5.725–5.85 GHz, the maximum conducted output power over the frequency band of operation shall not exceed 1 W.

If transmitting antennas of directional gain greater than 6 dBi are used, the peak output power shall be reduced by the amount in dB that the directional gain of the antenna exceeds 6 dBi.

### 3.2.2 Measuring Instruments

The measuring equipment is listed in the section 4 of this test report.

### 3.2.3 Test Procedures

The testing follows Method PM of FCC KDB 789033 D02 General UNII Test Procedures New Rules v01r03.

Method PM (Measurement using an RF average power meter):

1. Measurement is performed using a wideband RF power meter.
2. The EUT is configured to transmit continuously with a consistent duty cycle at its maximum power control level.
3. Measure the average power of the transmitter, and the average power is corrected with duty factor,  $10 \log(1/x)$ , where  $x$  is the duty cycle.

### 3.2.4 Test Setup

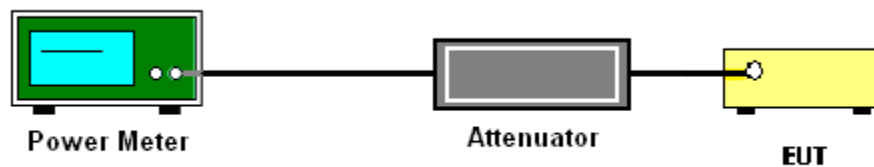

### 3.2.5 Test Result of Maximum Conducted Output Power

Please refer to Appendix A.





### 3.3 Power Spectral Density Measurement

#### 3.3.1 Limit of Power Spectral Density

For the band 5.725–5.85 GHz, the maximum power spectral density shall not exceed 30 dBm in any 500-kHz band.

If transmitting antennas of directional gain greater than 6 dBi are used, the peak output power shall be reduced by the amount in dB that the directional gain of the antenna exceeds 6 dBi.

#### 3.3.2 Measuring Instruments

The measuring equipment is listed in the section 4 of this test report.

#### 3.3.3 Test Procedures

The testing follows FCC KDB 789033 D02 General UNII Test Procedures New Rules v01r03. Section F) Maximum power spectral density.

##### # Method SA-2 #

(trace averaging across on and off times of the EUT transmissions, followed by duty cycle correction).

1. The testing follows Method SA-2 of FCC KDB 789033 D02 General UNII Test Procedures New Rules v01r02.
  - Measure the duty cycle.
  - Set span to encompass the entire emission bandwidth (EBW) of the signal.
  - Set RBW = 300 kHz.
  - Set VBW  $\geq$  1 MHz.
  - Number of points in sweep  $\geq$  2 Span / RBW.
  - Sweep time = auto.
  - Detector = RMS
  - Trace average at least 100 traces in power averaging mode.
  - Add  $10 \log(500\text{kHz}/\text{RBW})$  to the test result.
  - Add  $10 \log(1/x)$ , where  $x$  is the duty cycle, to the measured power in order to compute the average power during the actual transmission times. For example, add  $10 \log(1/0.25) = 6$  dB if the duty cycle is 25 percent.

2. The RF output of EUT was connected to the spectrum analyzer by a low loss cable.
3. Each plot has already offset with cable loss, and attenuator loss. Measure the PPSD and record it.
4. For MIMO mode, calculation method follows FCC KDB 662911 D01 Multiple Transmitter Output v02r01.

Method (c): Measure and add  $10 \log(N_{ANT})$  dB.

With this technique, spectrum measurements are performed at each output of the device, but rather than summing the spectra or the spectral peaks across the outputs, the quantity  $10 \log(N_{ANT})$  dB is added to each spectrum value before comparing to the emission limit. The addition of  $10 \log(N_{ANT})$  dB serves to apportion the emission limit among the  $N_{ANT}$  outputs so that each output is permitted to contribute no more than  $1/N_{ANT}^{th}$  of the PSD limit.

### 3.3.4 Test Setup

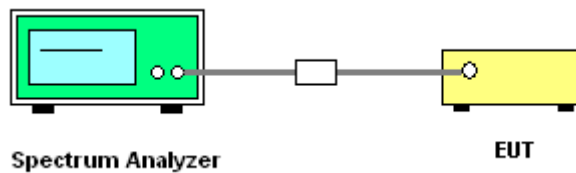



### 3.3.5 Test Result of Power Spectral Density

Please refer to Appendix A.

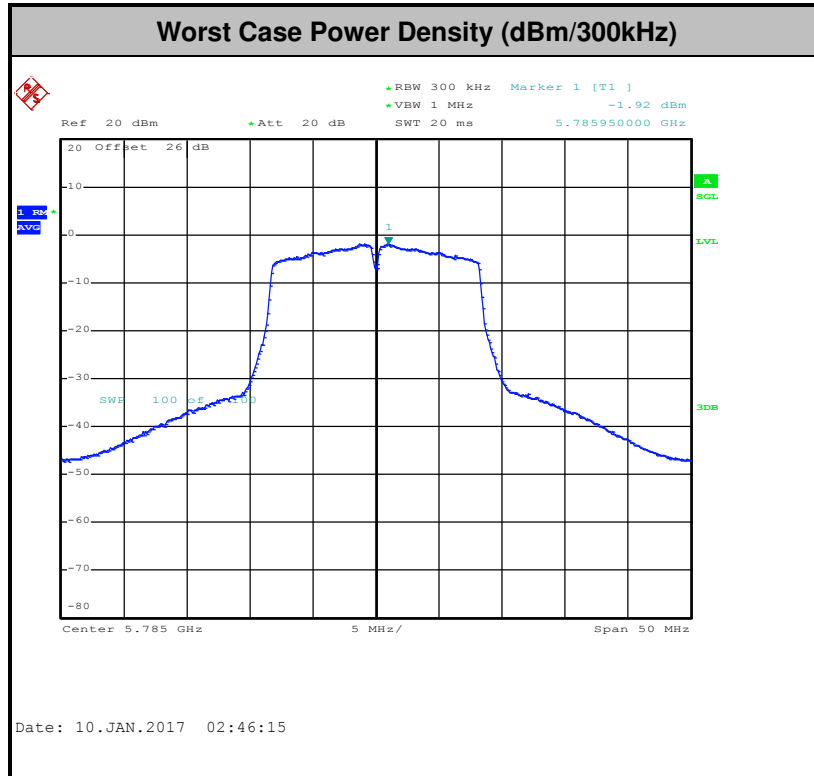



### 3.4 Unwanted Emissions Measurement

This section as specified in FCC Part 15.407(b) is to measure unwanted emissions through radiated measurement for band edge spurious emissions and out of band emissions measurement. The unwanted emissions shall comply with 15.407(b)(1) to (6), and restricted bands per FCC Part15.205.

#### 3.4.1 Limit of Unwanted Emissions

- (1) For transmitters operating in the 5.725-5.85 GHz band:  
15.407(b)(4)(i) All emissions shall be limited to a level of -27 dBm/MHz at 75 MHz or more above or below the band edge increasing linearly to 10 dBm/MHz at 25 MHz above or below the band edge, and from 25 MHz above or below the band edge increasing linearly to a level of 15.6 dBm/MHz at 5 MHz above or below the band edge, and from 5 MHz above or below the band edge increasing linearly to a level of 27 dBm/MHz at the band edge.
- (2) Unwanted spurious emissions fallen in restricted bands per FCC Part15.205 shall comply with the general field strength limits set forth in § 15.209 as below table,

Frequency (MHz)	Field Strength (microvolts/meter)	Measurement Distance (meters)
0.009 – 0.490	2400/F(kHz)	300
0.490 – 1.705	24000/F(kHz)	30
1.705 – 30.0	30	30
30 – 88	100	3
88 – 216	150	3
216 - 960	200	3
Above 960	500	3

**Note:** The following formula is used to convert the EIRP to field strength.

$$E = \frac{1000000\sqrt{30P}}{3} \mu\text{V/m, where P is the eirp (Watts)}$$



EIRP (dBm)	Field Strength at 3m (dBμV/m)
-17	78.3
- 27	68.3

(3) KDB789033 D01 v01r03 G)2)c)

- (i) Section 15.407(b)(1-3) specifies the unwanted emissions limit for the U-NII-1 and 2 bands. As specified, emissions above 1000 MHz that are outside of the restricted bands are subject to a peak emission limit of -27 dBm/MHz. However, an out-of-band emission that complies with both the average and peak limits of Section 15.209 is not required to satisfy the -27 dBm/MHz dBm/MHz peak emission limit.
- (ii) Section 15.407(b)(4) specifies the unwanted emissions limit for the U-NII-3 band. A band emissions mask is specified in Section 15.407(b)(4)(i). An alternative to the band emissions mask is specified in Section 15.407(b)(4)(ii). The alternative limits are based on the highest antenna gain specified in the filing. There are also marketing and importation restrictions for the alternative limit

### 3.4.2 Measuring Instruments

The measuring equipment is listed in the section 4 of this test report.



### 3.4.3 Test Procedures

1. The testing follows FCC KDB 789033 D02 General UNII Test Procedures New Rules v01r03. Section G) Unwanted emissions measurement.

(1) Procedure for Unwanted Emissions Measurements Below 1000MHz

- RBW = 120 kHz
- VBW = 300 kHz
- Detector = Peak
- Trace mode = max hold

(2) Procedure for Peak Unwanted Emissions Measurements Above 1000 MHz

- RBW = 1 MHz
- VBW  $\geq$  3 MHz
- Detector = Peak
- Sweep time = auto
- Trace mode = max hold

(3) Procedures for Average Unwanted Emissions Measurements Above 1000MHz

- RBW = 1 MHz
- VBW = 10 Hz, when duty cycle is no less than 98 percent.
- VBW  $\geq$  1/T, when duty cycle is less than 98 percent where T is the minimum transmission duration over which the transmitter is on and is transmitting at its maximum power control level for the tested mode of operation.

2. The EUT was placed on a turntable with 0.8 meter for frequency below 1GHz and 1.5 meter for frequency above 1GHz respectively above ground.
3. The EUT was set 3 meters from the interference receiving antenna which was mounted on the top of a variable height antenna tower.
4. The antenna is a broadband antenna and its height is adjusted between one meter and four meters above ground to find the maximum value of the field strength for both horizontal polarization and vertical polarization of the antenna.
5. For each suspected emission, the EUT was arranged to its worst case and then adjust the antenna tower (from 1 m to 4 m) and turntable (from 0 degree to 360 degrees) to find the maximum reading.
6. For testing below 1GHz, if the emission level of the EUT in peak mode was 3 dB lower than the limit specified, then peak values of EUT will be reported, otherwise, the emissions will be repeated one by one using the CISPR quasi-peak method and reported.
7. For testing above 1GHz, the emission level of the EUT in peak mode was 20dB lower than average limit (that means the emission level in average mode also complies with the limit in average mode), then peak values of EUT will be reported, otherwise, the emissions will be measured in average mode again and reported.

### 3.4.4 Test Setup

For radiated emissions below 30MHz

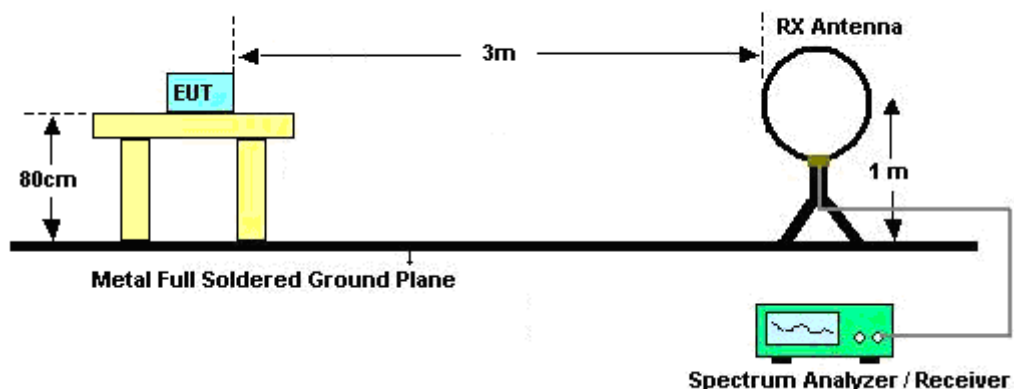

For radiated emissions from 30MHz to 1GHz

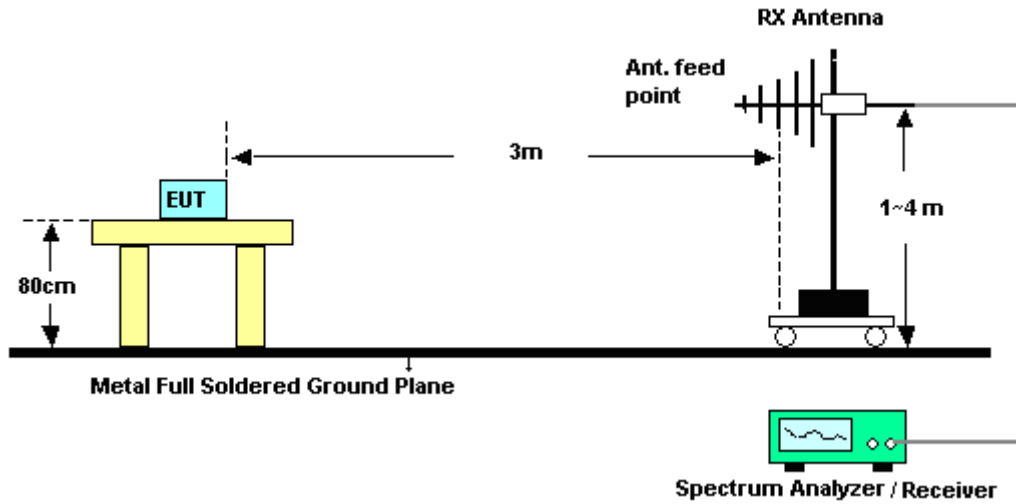

For radiated emissions above 1GHz

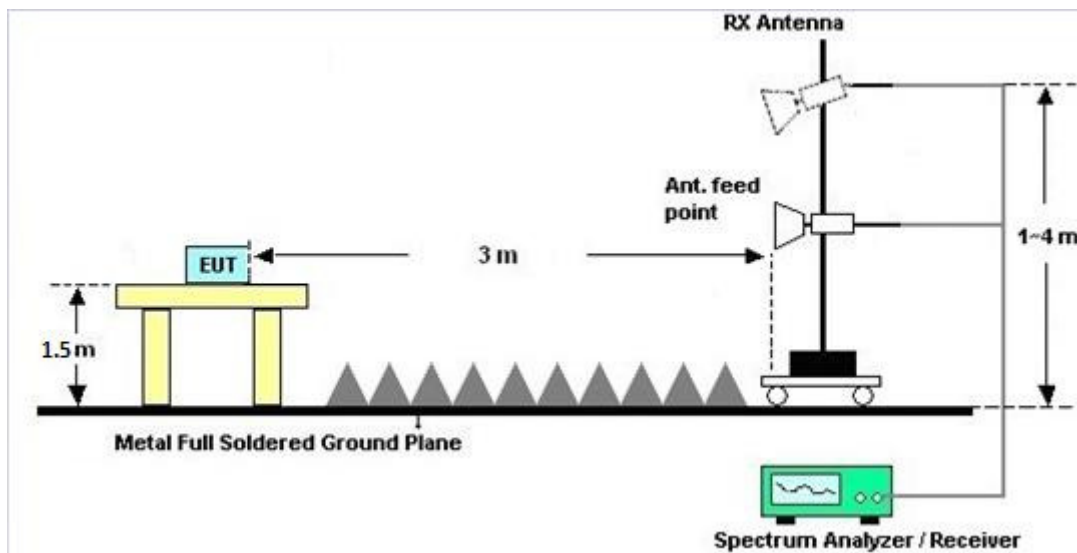





### **3.4.5 Test Results of Radiated Spurious Emissions (9 kHz ~ 30 MHz)**

The low frequency, which started from 9 kHz to 30MHz, was pre-scanned and the result which was 20dB lower than the limit line per 15.31(o) was not reported.

### **3.4.6 Test Result of Radiated Spurious at Band Edges**

Please refer to Appendix B and C.

### **3.4.7 Duty Cycle**

Please refer to Appendix D.

### **3.4.8 Test Result of Radiated Spurious Emissions (30MHz ~ 10th Harmonic)**

Please refer to Appendix B and C.



### 3.5 AC Conducted Emission Measurement

#### 3.5.1 Limit of AC Conducted Emission

For equipment that is designed to be connected to the public utility (AC) power line, the radio frequency voltage that is conducted back onto the AC power line on any frequency or frequencies within the band 150 kHz to 30 MHz shall not exceed the limits in the following table.

Frequency of emission (MHz)	Conducted limit (dBµV)	
	Quasi-peak	Average
0.15-0.5	66 to 56*	56 to 46*
0.5-5	56	46
5-30	60	50

\*Decreases with the logarithm of the frequency.

#### 3.5.2 Measuring Instruments

The measuring equipment is listed in the section 4 of this test report.

#### 3.5.3 Test Procedures

1. The EUT was placed 0.4 meter from the conducting wall of the shielding room was kept at least 80 centimeters from any other grounded conducting surface.
2. Connect EUT to the power mains through a line impedance stabilization network (LISN).
3. All the support units are connecting to the other LISN.
4. The LISN provides 50 ohm coupling impedance for the measuring instrument.
5. The FCC states that a 50 ohm, 50 microhenry LISN should be used.
6. Both sides of AC line were checked for maximum conducted interference.
7. The frequency range from 150 kHz to 30 MHz was searched.
8. Set the test-receiver system to Peak Detect Function and specified bandwidth with Maximum Hold Mode.

### 3.5.4 Test Setup

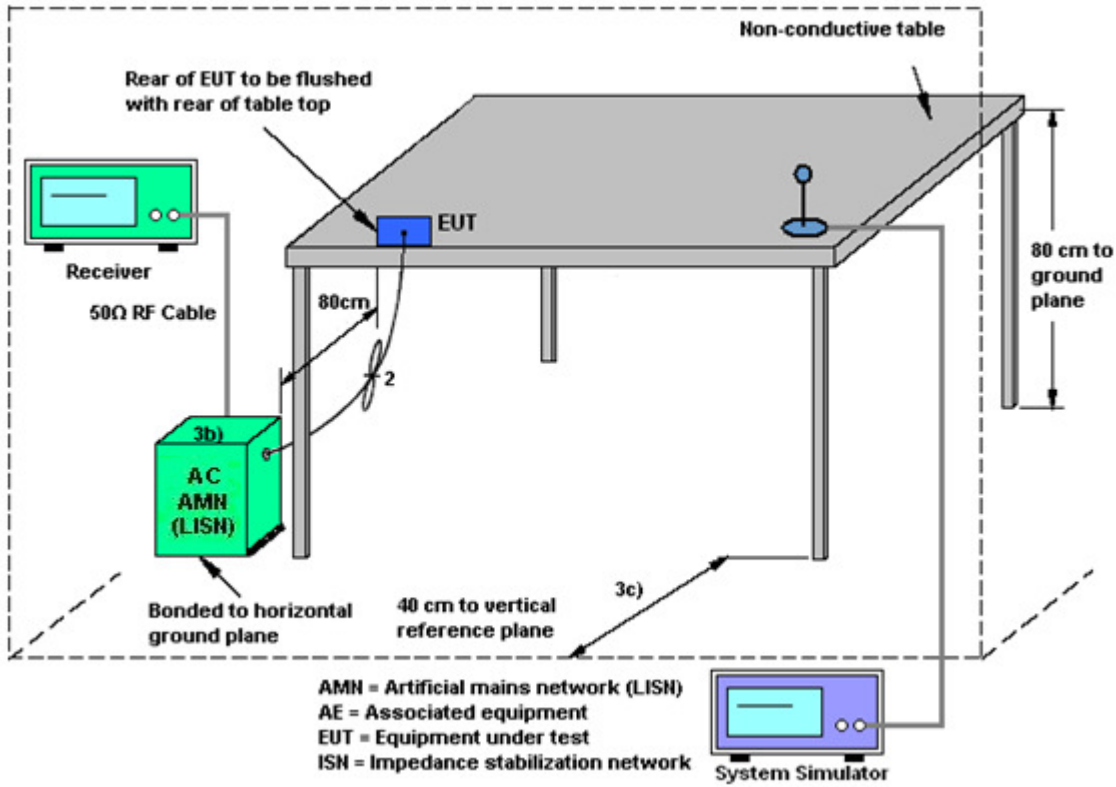



### 3.5.5 Test Result of AC Conducted Emission

Test Mode :	Mode 1	Temperature :	21~24°C
Test Engineer :	Arthur Hsieh	Relative Humidity :	50~53%
Test Voltage :	120Vac / 60Hz	Phase :	Line
Function Type :	GSM1900 Idle + Bluetooth Link + WLAN (5GHz) Link + MP3 + Earphone + Battery + USB Cable (Charging from Adapter)		

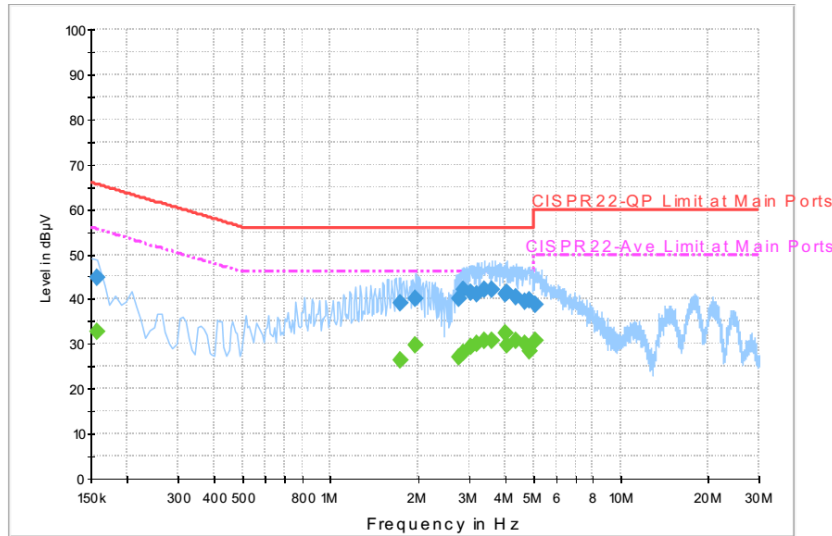

**Final Result : QuasiPeak**

Frequency (MHz)	QuasiPeak (dBµV)	Filter	Line	Corr. (dB)	Margin (dB)	Limit (dBµV)
0.158000	44.7	Off	L1	19.6	20.9	65.6
1.734000	39.1	Off	L1	19.6	16.9	56.0
1.974000	40.2	Off	L1	19.6	15.8	56.0
2.782000	40.2	Off	L1	19.5	15.8	56.0
2.886000	42.3	Off	L1	19.5	13.7	56.0
3.046000	41.6	Off	L1	19.6	14.4	56.0
3.182000	41.2	Off	L1	19.6	14.8	56.0
3.390000	42.3	Off	L1	19.6	13.7	56.0
3.606000	42.1	Off	L1	19.7	13.9	56.0
3.998000	41.0	Off	L1	19.7	15.0	56.0
4.062000	41.5	Off	L1	19.7	14.5	56.0
4.366000	40.6	Off	L1	19.7	15.4	56.0
4.678000	39.6	Off	L1	19.8	16.4	56.0
4.854000	39.7	Off	L1	19.8	16.3	56.0
5.086000	38.9	Off	L1	19.8	21.1	60.0



Test Mode :	Mode 1	Temperature :	21~24°C
Test Engineer :	Arthur Hsieh	Relative Humidity :	50~53%
Test Voltage :	120Vac / 60Hz	Phase :	Line
Function Type :	GSM1900 Idle + Bluetooth Link + WLAN (5GHz) Link + MP3 + Earphone + Battery + USB Cable (Charging from Adapter)		

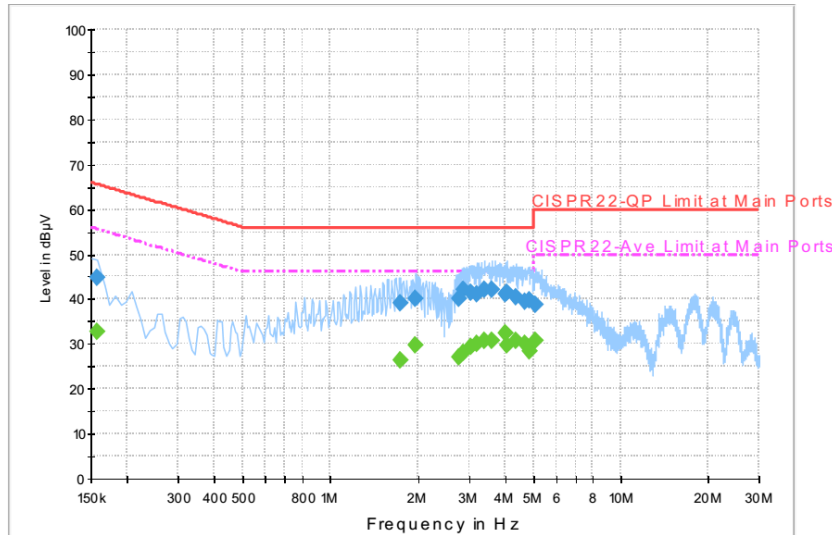

Final Result : Average

Frequency (MHz)	Average (dBµV)	Filter	Line	Corr. (dB)	Margin (dB)	Limit (dBµV)
0.158000	32.9	Off	L1	19.6	22.7	55.6
1.734000	26.6	Off	L1	19.6	19.4	46.0
1.974000	29.7	Off	L1	19.6	16.3	46.0
2.782000	27.1	Off	L1	19.5	18.9	46.0
2.886000	28.1	Off	L1	19.5	17.9	46.0
3.046000	29.4	Off	L1	19.6	16.6	46.0
3.182000	30.3	Off	L1	19.6	15.7	46.0
3.390000	30.6	Off	L1	19.6	15.4	46.0
3.606000	30.7	Off	L1	19.7	15.3	46.0
3.998000	32.5	Off	L1	19.7	13.5	46.0
4.062000	29.7	Off	L1	19.7	16.3	46.0
4.366000	30.8	Off	L1	19.7	15.2	46.0
4.678000	30.1	Off	L1	19.8	15.9	46.0
4.854000	28.4	Off	L1	19.8	17.6	46.0
5.086000	30.8	Off	L1	19.8	19.2	50.0



Test Mode :	Mode 1	Temperature :	21~24°C
Test Engineer :	Arthur Hsieh	Relative Humidity :	50~53%
Test Voltage :	120Vac / 60Hz	Phase :	Neutral
Function Type :	GSM1900 Idle + Bluetooth Link + WLAN (5GHz) Link + MP3 + Earphone + Battery + USB Cable (Charging from Adapter)		

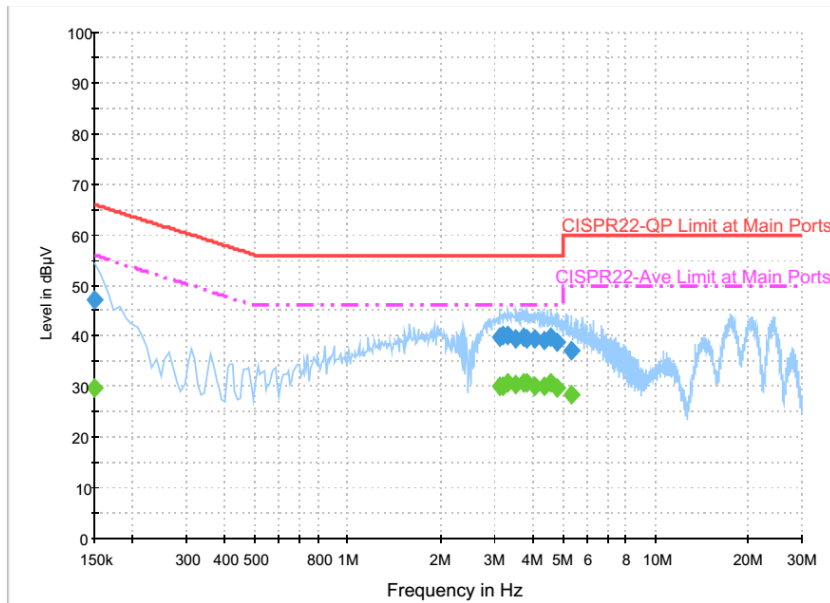

Final Result : QuasiPeak

Frequency (MHz)	QuasiPeak (dBµV)	Filter	Line	Corr. (dB)	Margin (dB)	Limit (dBµV)
0.150000	47.2	Off	N	19.6	18.8	66.0
3.126000	39.8	Off	N	19.6	16.2	56.0
3.190000	40.0	Off	N	19.6	16.0	56.0
3.334000	40.1	Off	N	19.6	15.9	56.0
3.534000	39.5	Off	N	19.6	16.5	56.0
3.742000	39.8	Off	N	19.7	16.2	56.0
3.846000	39.4	Off	N	19.7	16.6	56.0
4.070000	39.5	Off	N	19.7	16.5	56.0
4.342000	39.1	Off	N	19.7	16.9	56.0
4.558000	39.8	Off	N	19.7	16.2	56.0
4.822000	38.8	Off	N	19.7	17.2	56.0
5.350000	37.2	Off	N	19.8	22.8	60.0



Test Mode :	Mode 1	Temperature :	21~24°C
Test Engineer :	Arthur Hsieh	Relative Humidity :	50~53%
Test Voltage :	120Vac / 60Hz	Phase :	Neutral
Function Type :	GSM1900 Idle + Bluetooth Link + WLAN (5GHz) Link + MP3 + Earphone + Battery + USB Cable (Charging from Adapter)		

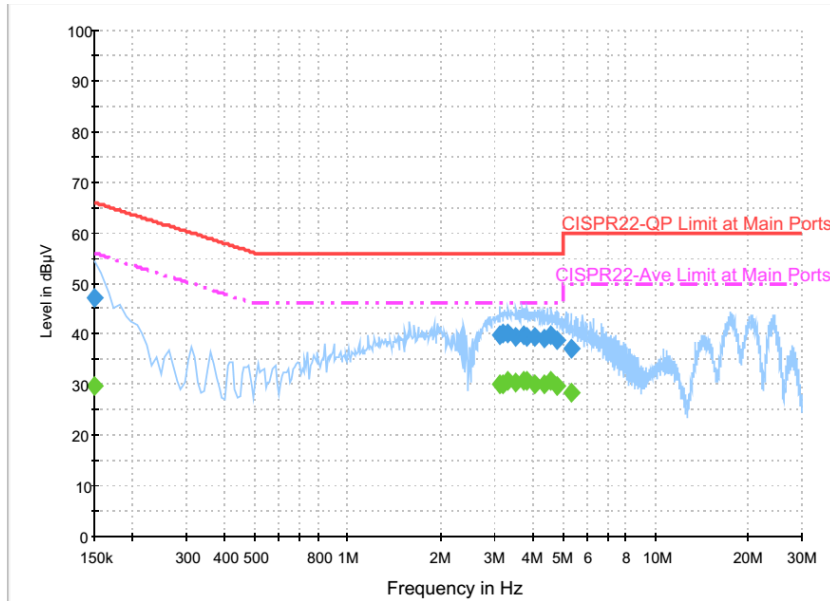

**Final Result : Average**

Frequency (MHz)	Average (dBµV)	Filter	Line	Corr. (dB)	Margin (dB)	Limit (dBµV)
0.150000	29.7	Off	N	19.6	26.3	56.0
3.126000	30.1	Off	N	19.6	15.9	46.0
3.190000	30.0	Off	N	19.6	16.0	46.0
3.334000	30.7	Off	N	19.6	15.3	46.0
3.534000	30.5	Off	N	19.6	15.5	46.0
3.742000	30.7	Off	N	19.7	15.3	46.0
3.846000	30.8	Off	N	19.7	15.2	46.0
4.070000	30.1	Off	N	19.7	15.9	46.0
4.342000	30.1	Off	N	19.7	15.9	46.0
4.558000	30.6	Off	N	19.7	15.4	46.0
4.822000	29.9	Off	N	19.7	16.1	46.0
5.350000	28.4	Off	N	19.8	21.6	50.0

## 3.6 Frequency Stability Measurement

### 3.6.1 Limit of Frequency Stability

Manufacturers of U-NII devices are responsible for ensuring frequency stability such that an emission is maintained within the band of operation under all conditions of normal operation as specified in the user's manual.

### 3.6.2 Measuring Instruments

The measuring equipment is listed in the section 4 of this test report.

### 3.6.3 Test Procedures

1. To ensure emission at the band edge is maintained within the authorized band, those values shall be measured by radiation emissions at upper and lower frequency points, and finally compensated by frequency deviation as procedures below.
2. The EUT was operated at the maximum output power, and connected to the spectrum analyzer, which is set to maximum hold function and peak detector. The peak value of the power envelope was measured and noted. The upper and lower frequency points were respectively measured relatively 10dB lower than the measured peak value.
3. The frequency deviation was calculated by adding the upper frequency point and the lower frequency point divided by two. Those detailed values of frequency deviation are provided in table below.

### 3.6.4 Test Setup

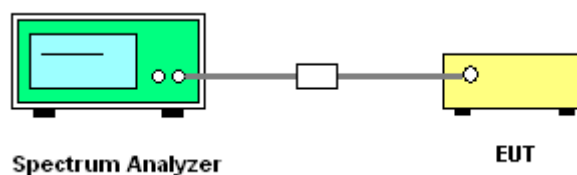

### 3.6.5 Test Result of Frequency Stability

Please refer to Appendix A.





## **3.7 Automatically Discontinue Transmission**

### **3.7.1 Limit of Automatically Discontinue Transmission**

The device shall automatically discontinue transmission in case of either absence of information to transmit or operational failure. These provisions are not intended to preclude the transmission of control or signaling information or the use of repetitive codes used by certain digital technologies to complete frame or burst intervals. Applicants shall include in their application for equipment authorization to describe how this requirement is met.

### **3.7.2 Measuring Instruments**

The measuring equipment is listed in the section 4 of this test report.

### **3.7.3 Test Result of Automatically Discontinue Transmission**

While the EUT is not transmitting any information, the EUT can automatically discontinue transmission and become standby mode for power saving. The EUT can detect the controlling signal of ACK message transmitting from remote device and verify whether it shall resend or discontinue transmission.



## **3.8 Antenna Requirements**

### **3.8.1 Standard Applicable**

According to FCC 47 CFR Section 15.407(a)(1)(2) ,if transmitting antenna directional gain is greater than 6 dBi, both the peak transmit power and the peak power spectral density shall be reduced by the amount in dB that the directional gain of the antenna exceeds 6 dBi.

### **3.8.2 Antenna Anti-Replacement Construction**

An embedded-in antenna design is used.

### **3.8.3 Antenna Gain**

The antenna gain is less than 6 dBi. Therefore, it is not necessary to reduce maximum peak output power limit.



## 4 List of Measuring Equipment

Instrument	Manufacturer	Model No.	Serial No.	Characteristics	Calibration Date	Test Date	Due Date	Remark
Spectrum Analyzer	Rohde & Schwarz	FSP40	100055	9kHz-40GHz	Jul. 17, 2016	Jan. 03, 2017 ~ Jan. 10, 2017	Jul. 16, 2017	Conducted (TH05-HY)
Power Meter	Anritsu	ML2495A	0932001	300MHz~40GHz	Sep. 29, 2016	Jan. 03, 2017 ~ Jan. 10, 2017	Sep. 28, 2017	Conducted (TH05-HY)
Power Sensor	Anritsu	MA2411B	0846202	300MHz~40GHz	Sep. 29, 2016	Jan. 03, 2017 ~ Jan. 10, 2017	Sep. 28, 2017	Conducted (TH05-HY)
Hygrometer	Testo	608-H2	41410069	N/A	Aug. 28, 2016	Jan. 03, 2017 ~ Jan. 10, 2017	Aug. 27, 2017	Conducted (TH05-HY)
RF Cable	HUBER + SUHNER	SUCOFLEX 104	MY84209521	1GHz~26GHz	Dec. 02, 2016	Jan. 03, 2017 ~ Jan. 10, 2017	Dec. 01, 2017	Conducted (TH05-HY)
Temperature Chamber	ESPEC	SH-641	92013720	-40℃ ~90℃	Sep. 01, 2016	Jan. 03, 2017 ~ Jan. 10, 2017	Aug. 31, 2017	Conducted (TH05-HY)
AC Power Source	ChainTek	APC-1000W	N/A	N/A	N/A	Jan. 09, 2017	N/A	Conduction (CO05-HY)
EMI Test Receiver	Rohde & Schwarz	ESCI 7	100724	9kHz~7GHz	Aug. 30, 2016	Jan. 09, 2017	Aug. 29, 2017	Conduction (CO05-HY)
Hygrometer	Testo	608-H1	34913912	N/A	Apr. 19, 2016	Jan. 09, 2017	Apr. 18, 2017	Conduction (CO05-HY)
LISN	Rohde & Schwarz	ENV216	100080	9kHz~30MHz	Nov. 29, 2016	Jan. 09, 2017	Nov. 28, 2017	Conduction (CO05-HY)
LF Cable	HUBER + SUHNER	RG-214/U	LF01	N/A	Jan. 05, 2017	Jan. 09, 2017	Jan. 04, 2018	Conduction (CO05-HY)
Test Software	N/A	EMC32	8.40.0	N/A	N/A	Jan. 09, 2017	N/A	Conduction (CO05-HY)
Loop Antenna	Rohde & Schwarz	HFH2-Z2	100488	9 kHz~30 MHz	Oct. 20, 2016	Jan. 12, 2017 ~ Jan. 16, 2017	Oct. 19, 2018	Radiation (03CH12-HY)
Bilog Antenna	TESEQ	CBL 6111D&00800 N1D01N-06	37059&01	30MHz~1GHz	Oct. 15, 2016	Jan. 12, 2017 ~ Jan. 16, 2017	Oct. 14, 2017	Radiation (03CH12-HY)
Horn Antenna	SCHWARZBECK	BBHA 9120D	9120D-1328	1GHz ~ 18GHz	Oct. 25, 2016	Jan. 12, 2017 ~ Jan. 16, 2017	Oct. 24, 2017	Radiation (03CH12-HY)
SHF-EHF Horn Antenna	SCHWARZBECK	BBHA 9170	BBHA9170576	18GHz ~ 40GHz	Apr. 15, 2016	Jan. 12, 2017 ~ Jan. 16, 2017	Apr. 14, 2017	Radiation (03CH12-HY)
Spectrum Analyzer	Agilent	N9030A	MY52350276	3Hz~44GHz	Mar. 21, 2016	Jan. 12, 2017 ~ Jan. 16, 2017	Mar. 20, 2017	Radiation (03CH12-HY)
Amplifier	SONOMA	310N	187312	9kHz~1GHz	Nov. 10, 2016	Jan. 12, 2017 ~ Jan. 16, 2017	Nov. 09, 2017	Radiation (03CH12-HY)
Preamplifier	MITEQ	TTA0204	1872107	2GHz~40GHz	Feb. 15, 2016	Jan. 12, 2017 ~ Jan. 16, 2017	Feb. 14, 2017	Radiation (03CH12-HY)
Preamplifier	MITEQ	AMF-7D-0010 1800-30-10P	1815698	1GHz~18GHz	Dec. 01, 2016	Jan. 12, 2017 ~ Jan. 16, 2017	Nov. 30, 2017	Radiation (03CH12-HY)
Preamplifier	Keysight	83017A	MY53270195	1GHz~26.5GHz	Aug. 24, 2016	Jan. 12, 2017 ~ Jan. 16, 2017	Aug. 23, 2017	Radiation (03CH12-HY)



Instrument	Manufacturer	Model No.	Serial No.	Characteristics	Calibration Date	Test Date	Due Date	Remark
Hygrometer	TECEP	DTM-303B	TP140349	N/A	Nov. 14, 2016	Jan. 12, 2017 ~ Jan. 16, 2017	Nov. 13, 2017	Radiation (03CH12-HY)
RF Cable	HUBER + SUHNER	SUCOFLEX 104	MY24958/4, MY28653/4, MY9839/4PE	26GHz~40GHz	Jan. 10, 2017	Jan. 12, 2017 ~ Jan. 16, 2017	Jan. 09, 2018	Radiation (03CH12-HY)
RF Cable	HUBER + SUHNER	SUCOFLEX 104	MY24958/4, MY28653/4, MY9839/4PE	1GHz~26GHz	Jan. 10, 2017	Jan. 12, 2017 ~ Jan. 16, 2017	Jan. 09, 2018	Radiation (03CH12-HY)
RF Cable	HUBER + SUHNER	SUCOFLEX 104	MY24958/4, MY28653/4, MY9839/4PE	30MHz~1GHz	Jan. 10, 2017	Jan. 12, 2017 ~ Jan. 16, 2017	Jan. 09, 2018	Radiation (03CH12-HY)
RF Cable	HUBER + SUHNER	SUCOFLEX 104	MY24958/4, MY28653/4, MY9839/4PE	9K~30MHz	Jan. 10, 2017	Jan. 12, 2017 ~ Jan. 16, 2017	Jan. 09, 2018	Radiation (03CH12-HY)
Controller	EMEC	EM1000	N/A	Control Turn table & Ant Mast	N/A	Jan. 12, 2017 ~ Jan. 16, 2017	N/A	Radiation (03CH12-HY)
Antenna Mast	EMEC	AM-BS-4500-B	N/A	1m~4m	N/A	Jan. 12, 2017 ~ Jan. 16, 2017	N/A	Radiation (03CH12-HY)
Turn Table	EMEC	TT2000	N/A	0~360 Degree	N/A	Jan. 12, 2017 ~ Jan. 16, 2017	N/A	Radiation (03CH12-HY)
Test Software	Audix	E3	6.2009-8-24	N/A	N/A	Jan. 12, 2017 ~ Jan. 16, 2017	N/A	Radiation (03CH12-HY)
Filter	Wainwright	WLKS4500-8S S	SN19	4.5G Low Pass	Sep. 19, 2016	Jan. 12, 2017 ~ Jan. 16, 2017	Sep. 18, 2017	Radiation (03CH12-HY)
Filter	Wainwright	WHKX8-5872. 5-6750-18000- 40ST	SN3	6.75 GHz Highpass	Sep. 19, 2016	Jan. 12, 2017 ~ Jan. 16, 2017	Sep. 18, 2017	Radiation (03CH12-HY)



## 5 Uncertainty of Evaluation

### Uncertainty of Conducted Emission Measurement (150kHz ~ 30MHz)

Measuring Uncertainty for a Level of Confidence of 95% ( $U = 2Uc(y)$ )	2.70
---	------

### Uncertainty of Radiated Emission Measurement (30 MHz ~ 1000 MHz)

Measuring Uncertainty for a Level of Confidence of 95% ( $U = 2Uc(y)$ )	5.10
---	------

### Uncertainty of Radiated Emission Measurement (1000 MHz ~ 18000 MHz)

Measuring Uncertainty for a Level of Confidence of 95% ( $U = 2Uc(y)$ )	5.20
---	------

### Uncertainty of Radiated Emission Measurement (18000 MHz ~ 40000 MHz)

Measuring Uncertainty for a Level of Confidence of 95% ( $U = 2Uc(y)$ )	4.70
---	------

**Appendix A. Test Result of Conducted Test Items**

Test Engineer:	Aking Chang	Temperature:	21~25	°C
Test Date:	2017/1/3~2017/01/10	Relative Humidity:	51~54	%

**TEST RESULTS DATA**  
**6dB and 26dB EBW and 99% OBW**

Band IV									
Mod.	Data Rate	NTX	CH.	Freq. (MHz)	99% Bandwidth (MHz)	26 dB Bandwidth (MHz)	6 dB Bandwidth (MHz)	6dB Bandwidth min. Limit (MHz)	Pass/Fail
11a	6M bps	1	149	5745	17.55	28.35	15.44	0.5	Pass
11a	6Mbps	1	157	5785	17.35	27.6	15.28	0.5	Pass
11a	6Mbps	1	165	5825	17.25	33	15.12	0.5	Pass
HT20	MCS 0	1	149	5745	18.5	29.6	17.58	0.5	Pass
HT20	MCS 0	1	157	5785	18.5	32.45	17.56	0.5	Pass
HT20	MCS 0	1	165	5825	18.55	32.4	17.56	0.5	Pass
HT40	MCS 0	1	151	5755	36.7	62.01	36.12	0.5	Pass
HT40	MCS 0	1	159	5795	36.6	67.86	36.04	0.5	Pass

**TEST RESULTS DATA**  
**Average Power Table**

Band IV										
Mod.	Data Rate	NTX	CH.	Freq. (MHz)	Duty Factor (dB)	Average Conducted Power (dBm)	FCC Conducted Power Limit (dBm)	DG (dBi)		Pass/Fail
11a	6M bps	1	149	5745	0.12	13.76	30.00	-2.10		Pass
11a	6Mbps	1	157	5785	0.12	13.74	30.00	-2.10		Pass
11a	6Mbps	1	165	5825	0.12	13.82	30.00	-2.10		Pass
HT20	MCS 0	1	149	5745	0.16	12.84	30.00	-2.10		Pass
HT20	MCS 0	1	157	5785	0.16	12.82	30.00	-2.10		Pass
HT20	MCS 0	1	165	5825	0.16	12.71	30.00	-2.10		Pass
HT40	MCS 0	1	151	5755	0.23	12.97	30.00	-2.10		Pass
HT40	MCS 0	1	159	5795	0.23	12.96	30.00	-2.10		Pass



***TEST RESULTS DATA***  
***Power Spectral Density***

Band IV										
Mod.	Data Rate	NTX	CH.	Freq. (MHz)	Duty Factor (dB)	10log (500kHz /RBW) Factor (dB)	Average Power Density (dBm/500kHz)	Average PSD Limit (dBm/500kHz)	DG (dBi)	Pass/Fail
11a	6M bps	1	149	5745	0.12	2.22	0.16	30.00	-2.10	Pass
11a	6Mbps	1	157	5785	0.12	2.22	0.42	30.00	-2.10	Pass
11a	6Mbps	1	165	5825	0.12	2.22	-0.02	30.00	-2.10	Pass
HT20	MCS 0	1	149	5745	0.16	2.22	-2.13	30.00	-2.10	Pass
HT20	MCS 0	1	157	5785	0.16	2.22	-2.01	30.00	-2.10	Pass
HT20	MCS 0	1	165	5825	0.16	2.22	-2.24	30.00	-2.10	Pass
HT40	MCS 0	1	151	5755	0.23	2.22	-5.11	30.00	-2.10	Pass
HT40	MCS 0	1	159	5795	0.23	2.22	-4.92	30.00	-2.10	Pass

**TEST RESULTS DATA**  
**Frequency Stability**

Band IV										
Mod.	Data Rate	NTX	CH.	Freq. (MHz)	Center Frequency (MHz)	Frequency Deviation (MHz)	Frequency Stability (ppm)	Temperature (°C)	Voltage (V)	Note
11a	6M bps	1	149	5745	5745.050	0.050	8.70	50	3.7	
11a	6M bps	1	149	5745	5745.000	0.000	0.00	-30	3.7	
11a	6M bps	1	149	5745	5745.000	0.000	0.00	20	4.2	
11a	6M bps	1	149	5745	5745.000	0.000	0.00	20	3.2	
11a	6M bps	1	149	5745	5745.000	0.000	0.00	20	3.7	



## Appendix B. Radiated Spurious Emission

Test Engineer :	Nick Yu, Karl Hou, Peter Liao, and Citta Ke.	Temperature :	21~23°C
		Relative Humidity :	53~55%

Band 4 - 5725~5850MHz

WIFI 802.11a (Band Edge @ 3m)

WIFI Ant. 1	Note	Frequency ( MHz )	Level ( dBμV/m )	Over Limit ( dB )	Limit Line ( dBμV/m )	Read Level ( dBμV )	Antenna Factor ( dB/m )	Cable Loss ( dB )	Preamp Factor ( dB )	Ant Pos ( cm )	Table Pos ( deg )	Peak Avg. ( P/A )	Pol. ( H/V )	
802.11a CH 149 5745MHz		5609.6	59.82	-8.38	68.2	46.33	32.71	11.77	30.99	100	191	P	H	
		5694	60.9	-39.88	100.78	47.15	32.94	11.82	31.01	100	191	P	H	
		5717.6	61.01	-49.12	110.13	47.18	33.01	11.84	31.02	100	191	P	H	
		5725	71.11	-51.09	122.2	57.26	33.03	11.84	31.02	100	191	P	H	
	*	5745	106.45	-	-	92.53	33.09	11.86	31.03	100	191	P	H	
	*	5745	96.58	-	-	82.66	33.09	11.86	31.03	100	191	A	H	
														H
														H
			5627.8	60.57	-7.63	68.2	47.01	32.76	11.79	30.99	300	106	P	V
			5676.2	61	-26.63	87.63	47.3	32.89	11.82	31.01	300	106	P	V
			5717.2	60.44	-49.58	110.02	46.61	33.01	11.84	31.02	300	106	P	V
			5723.6	69.22	-49.79	119.01	55.37	33.03	11.84	31.02	300	106	P	V
	*		5745	102.82	-	-	88.9	33.09	11.86	31.03	300	106	P	V
	*		5745	93.8	-	-	79.88	33.09	11.86	31.03	300	106	A	V
														V
													V	



WIFI Ant. 1	Note	Frequency ( MHz )	Level ( dBμV/m )	Over Limit ( dB )	Limit Line ( dBμV/m )	Read Level ( dBμV )	Antenna Factor ( dB/m )	Cable Loss ( dB )	Preamp Factor ( dB )	Ant Pos ( cm )	Table Pos ( deg )	Peak Avg. ( P/A )	Pol. ( H/V )
		5601.2	59.85	-8.35	68.2	46.38	32.68	11.77	30.98	119	189	P	H
		5658.4	61.07	-13.37	74.44	47.45	32.84	11.79	31.01	119	189	P	H
		5717.4	60.13	-49.94	110.07	46.3	33.01	11.84	31.02	119	189	P	H
		5723.2	60.08	-58.02	118.1	46.24	33.02	11.84	31.02	119	189	P	H
	*	5785	107.48	-	-	93.45	33.2	11.88	31.05	119	189	P	H
	*	5785	97.51	-	-	83.48	33.2	11.88	31.05	119	189	A	H
		5852.8	61.64	-54.18	115.82	47.28	33.39	12.03	31.06	119	189	P	H
		5870.2	61.35	-45.19	106.54	46.81	33.44	12.17	31.07	119	189	P	H
		5918.8	62.53	-10.24	72.77	47.74	33.57	12.31	31.09	119	189	P	H
		5936.6	63.12	-5.08	68.2	48.28	33.62	12.31	31.09	119	189	P	H
													H
													H
802.11a													
CH 157													
5785MHz		5610.4	60.78	-7.42	68.2	47.29	32.71	11.77	30.99	259	83	P	V
		5654.4	60.1	-11.37	71.47	46.49	32.83	11.79	31.01	259	83	P	V
		5717.6	61.13	-49	110.13	47.3	33.01	11.84	31.02	259	83	P	V
		5723.8	60.19	-59.27	119.46	46.34	33.03	11.84	31.02	259	83	P	V
	*	5785	102.18	-	-	88.15	33.2	11.88	31.05	259	83	P	V
	*	5785	92.33	-	-	78.3	33.2	11.88	31.05	259	83	A	V
		5853	59.92	-55.44	115.36	45.56	33.39	12.03	31.06	259	83	P	V
		5862.6	60.4	-48.27	108.67	45.88	33.42	12.17	31.07	259	83	P	V
		5901.6	61.54	-23.94	85.48	46.79	33.52	12.31	31.08	259	83	P	V
		5927.2	60.66	-7.54	68.2	45.84	33.6	12.31	31.09	259	83	P	V
													V
													V



WiFi Ant. 1	Note	Frequency ( MHz )	Level ( dBµV/m )	Over Limit ( dB )	Limit Line ( dBµV/m )	Read Level ( dBµV )	Antenna Factor ( dB/m )	Cable Loss ( dB )	Preamp Factor ( dB )	Ant Pos ( cm )	Table Pos ( deg )	Peak Avg. ( P/A )	Pol. ( H/V )	
802.11a CH 165 5825MHz	*	5825	107.6	-	-	93.31	33.31	12.03	31.05	100	187	P	H	
	*	5825	98.02	-	-	83.73	33.31	12.03	31.05	100	187	A	H	
		5854.4	63.28	-48.89	112.17	48.92	33.39	12.03	31.06	100	187	P	H	
		5857.2	62.1	-48.08	110.18	47.73	33.4	12.03	31.06	100	187	P	H	
		5897.2	62.01	-26.72	88.73	47.41	33.51	12.17	31.08	100	187	P	H	
		5942.2	61.08	-7.12	68.2	46.08	33.64	12.45	31.09	100	187	P	H	
														H
														H
	*	5825	102.92	-	-	88.63	33.31	12.03	31.05	281	103	P	V	
	*	5825	93.45	-	-	79.16	33.31	12.03	31.05	281	103	A	V	
		5850.4	60.69	-60.6	121.29	46.34	33.38	12.03	31.06	281	103	P	V	
		5873.4	61.19	-44.46	105.65	46.64	33.45	12.17	31.07	281	103	P	V	
		5909.4	62.23	-17.48	79.71	47.46	33.55	12.31	31.09	281	103	P	V	
		5942.8	61.64	-6.56	68.2	46.64	33.64	12.45	31.09	281	103	P	V	
														V
														V
														V
<b>Remark</b>	1. No other spurious found. 2. All results are PASS against Peak and Average limit line.													



Band 4 5725~5850MHz

WIFI 802.11a (Harmonic @ 3m)

WIFI Ant. 1	Note	Frequency ( MHz )	Level ( dBμV/m )	Over Limit ( dB )	Limit Line ( dBμV/m )	Read Level ( dBμV )	Antenna Factor ( dB/m )	Cable Loss ( dB )	Preamp Factor ( dB )	Ant Pos ( cm )	Table Pos ( deg )	Peak Avg. ( P/A )	Pol. ( H/V )
802.11a CH 149 5745MHz		11490	46.72	-27.28	74	45.9	40.2	18.4	57.78	100	0	P	H
		17235	60.97	-7.23	68.2	53.05	41.92	23.14	57.14	100	0	P	H
													H
													H
		11490	46.09	-27.91	74	45.27	40.2	18.4	57.78	100	0	P	V
		17235	60.5	-7.7	68.2	52.58	41.92	23.14	57.14	100	0	P	V
													V
													V
802.11a CH 157 5785MHz		11570	47.49	-26.51	74	46.74	40.06	18.49	57.8	100	0	P	H
		17355	58.7	-9.5	68.2	50.83	42.18	23.25	57.56	100	0	P	H
													H
													H
		11570	46.67	-27.33	74	45.92	40.06	18.49	57.8	100	0	P	V
		17355	56.53	-11.67	68.2	48.66	42.18	23.25	57.56	100	0	P	V
													V
													V
802.11a CH 165 5825MHz		11650	47.1	-26.9	74	46.42	39.9	18.58	57.8	100	0	P	H
		17475	54.27	-13.93	68.2	46.45	42.44	23.36	57.98	100	0	P	H
													H
													H
		11650	46.84	-27.16	74	46.16	39.9	18.58	57.8	100	0	P	V
		17475	54.45	-13.75	68.2	46.63	42.44	23.36	57.98	100	0	P	V
													V
													V
Remark	1. No other spurious found. 2. All results are PASS against Peak and Average limit line.												



Band 4 5725~5850MHz

WIFI 802.11n HT20 (Band Edge @ 3m)

WIFI Ant. 1	Note	Frequency ( MHz )	Level ( dBμV/m )	Over Limit ( dB )	Limit Line ( dBμV/m )	Read Level ( dBμV )	Antenna Factor ( dB/m )	Cable Loss ( dB )	Preamp Factor ( dB )	Ant Pos ( cm )	Table Pos ( deg )	Peak Avg. ( P/A )	Pol. ( H/V )	
802.11n HT20 CH 149 5745MHz		5624.4	60.72	-7.48	68.2	47.17	32.75	11.79	30.99	100	192	P	H	
		5696	61.47	-40.78	102.25	47.71	32.95	11.82	31.01	100	192	P	H	
		5719.8	61.64	-49.1	110.74	47.8	33.02	11.84	31.02	100	192	P	H	
		5723.8	71.38	-48.08	119.46	57.53	33.03	11.84	31.02	100	192	P	H	
	*	5745	107.94	-	-	94.02	33.09	11.86	31.03	100	192	P	H	
	*	5745	96.49	-	-	82.57	33.09	11.86	31.03	100	192	A	H	
														H
														H
			5603.8	61.61	-6.59	68.2	48.14	32.69	11.77	30.99	317	104	P	V
			5699.6	61.04	-43.87	104.91	47.27	32.96	11.82	31.01	317	104	P	V
			5713	60.99	-47.85	108.84	47.17	33	11.84	31.02	317	104	P	V
			5723.8	68.46	-51	119.46	54.61	33.03	11.84	31.02	317	104	P	V
	*		5745	104.47	-	-	90.55	33.09	11.86	31.03	317	104	P	V
	*		5745	91.88	-	-	77.96	33.09	11.86	31.03	317	104	A	V
														V
													V	



WIFI Ant. 1	Note	Frequency ( MHz )	Level ( dBμV/m )	Over Limit ( dB )	Limit Line ( dBμV/m )	Read Level ( dBμV )	Antenna Factor ( dB/m )	Cable Loss ( dB )	Preamp Factor ( dB )	Ant Pos ( cm )	Table Pos ( deg )	Peak Avg. ( P/A )	Pol. ( H/V )
		5640.6	60.28	-7.92	68.2	46.7	32.79	11.79	31	123	192	P	H
		5690.4	60.47	-37.65	98.12	46.73	32.93	11.82	31.01	123	192	P	H
		5707.6	60.47	-46.86	107.33	46.67	32.98	11.84	31.02	123	192	P	H
		5721	60.23	-52.85	113.08	46.39	33.02	11.84	31.02	123	192	P	H
	*	5785	107.55	-	-	93.52	33.2	11.88	31.05	123	192	P	H
	*	5785	96.19	-	-	82.16	33.2	11.88	31.05	123	192	A	H
		5852.8	60.65	-55.17	115.82	46.29	33.39	12.03	31.06	123	192	P	H
		5866	61.59	-46.13	107.72	47.07	33.42	12.17	31.07	123	192	P	H
		5902.4	62.44	-22.45	84.89	47.68	33.53	12.31	31.08	123	192	P	H
		5934.4	61.15	-7.05	68.2	46.31	33.62	12.31	31.09	123	192	P	H
802.11n													H
HT20													H
CH 157		5631.8	60.02	-8.18	68.2	46.46	32.77	11.79	31	331	103	P	V
5785MHz		5662.6	61.02	-16.53	77.55	47.35	32.86	11.82	31.01	331	103	P	V
		5720	60.57	-50.23	110.8	46.73	33.02	11.84	31.02	331	103	P	V
		5720.4	60.97	-50.74	111.71	47.13	33.02	11.84	31.02	331	103	P	V
	*	5785	103.47	-	-	89.44	33.2	11.88	31.05	331	103	P	V
	*	5785	91.88	-	-	77.85	33.2	11.88	31.05	331	103	A	V
		5850.8	60.49	-59.89	120.38	46.14	33.38	12.03	31.06	331	103	P	V
		5857.6	60.92	-49.15	110.07	46.55	33.4	12.03	31.06	331	103	P	V
		5884.4	61.32	-36.9	98.22	46.75	33.48	12.17	31.08	331	103	P	V
		5938.6	61.65	-6.55	68.2	46.8	33.63	12.31	31.09	331	103	P	V
													V
													V





WiFi Ant. 1	Note	Frequency ( MHz )	Level ( dBμV/m )	Over Limit ( dB )	Limit Line ( dBμV/m )	Read Level ( dBμV )	Antenna Factor ( dB/m )	Cable Loss ( dB )	Preamp Factor ( dB )	Ant Pos ( cm )	Table Pos ( deg )	Peak Avg. ( P/A )	Pol. ( H/V )	
802.11n HT20 CH 165 5825MHz	*	5825	108.7	-	-	94.41	33.31	12.03	31.05	100	193	P	H	
	*	5825	96.87	-	-	82.58	33.31	12.03	31.05	100	193	A	H	
		5850.8	61.55	-58.83	120.38	47.2	33.38	12.03	31.06	100	193	P	H	
		5867.4	61.58	-45.75	107.33	47.05	33.43	12.17	31.07	100	193	P	H	
		5914.2	62	-14.17	76.17	47.22	33.56	12.31	31.09	100	193	P	H	
		5942.2	61.56	-6.64	68.2	46.56	33.64	12.45	31.09	100	193	P	H	
														H
														H
	*	5825	103.76	-	-	89.47	33.31	12.03	31.05	296	104	104	P	V
	*	5825	92.12	-	-	77.83	33.31	12.03	31.05	296	104	104	A	V
		5850	60.21	-61.99	122.2	45.86	33.38	12.03	31.06	296	104	104	P	V
		5859	61.25	-48.43	109.68	46.88	33.41	12.03	31.07	296	104	104	P	V
		5918.8	61.13	-11.64	72.77	46.34	33.57	12.31	31.09	296	104	104	P	V
		5930.6	61.33	-6.87	68.2	46.5	33.61	12.31	31.09	296	104	104	P	V
														V
														V
<b>Remark</b>	1. No other spurious found. 2. All results are PASS against Peak and Average limit line.													



Band 4 5725~5850MHz

WIFI 802.11n HT20 (Harmonic @ 3m)

WIFI Ant. 1	Note	Frequency ( MHz )	Level ( dBμV/m )	Over Limit ( dB )	Limit Line ( dBμV/m )	Read Level ( dBμV )	Antenna Factor ( dB/m )	Cable Loss ( dB )	Preamp Factor ( dB )	Ant Pos ( cm )	Table Pos ( deg )	Peak Avg. ( P/A )	Pol. ( H/V )	
802.11n HT20 CH 149 5745MHz		11490	46.84	-27.16	74	46.02	40.2	18.4	57.78	100	0	P	H	
		17235	57.03	-11.17	68.2	49.11	41.92	23.14	57.14	100	0	P	H	
													H	
													H	
			11490	47.91	-26.09	74	47.09	40.2	18.4	57.78	100	0	P	V
			17235	59.49	-8.71	68.2	51.57	41.92	23.14	57.14	100	0	P	V
														V
802.11n HT20 CH 157 5785MHz		11570	46.26	-27.74	74	45.51	40.06	18.49	57.8	100	0	P	H	
		17355	54.61	-13.59	68.2	46.74	42.18	23.25	57.56	100	0	P	H	
													H	
													H	
			11570	46.58	-27.42	74	45.83	40.06	18.49	57.8	100	0	P	V
			17355	54.92	-13.28	68.2	47.05	42.18	23.25	57.56	100	0	P	V
														V
802.11n HT20 CH 165 5825MHz		11650	47.06	-26.94	74	46.38	39.9	18.58	57.8	100	0	P	H	
		17475	52.45	-15.75	68.2	44.63	42.44	23.36	57.98	100	0	P	H	
													H	
													H	
			11650	46.78	-27.22	74	46.1	39.9	18.58	57.8	100	0	P	V
			17475	51.82	-16.38	68.2	44	42.44	23.36	57.98	100	0	P	V
														V
Remark	1. No other spurious found.													
	2. All results are PASS against Peak and Average limit line.													



Band 4 5725~5850MHz

WIFI 802.11n HT40 (Band Edge @ 3m)

WIFI Ant. 1	Note	Frequency ( MHz )	Level ( dBμV/m )	Over Limit ( dB )	Limit Line ( dBμV/m )	Read Level ( dBμV )	Antenna Factor ( dB/m )	Cable Loss ( dB )	Preamp Factor ( dB )	Ant Pos ( cm )	Table Pos ( deg )	Peak Avg. ( P/A )	Pol. ( H/V )
		5636.6	60.12	-8.08	68.2	46.55	32.78	11.79	31	100	191	P	H
		5665.4	60.65	-18.98	79.63	46.98	32.86	11.82	31.01	100	191	P	H
		5718	67.83	-42.41	110.24	54	33.01	11.84	31.02	100	191	P	H
		5721.6	69.08	-45.37	114.45	55.24	33.02	11.84	31.02	100	191	P	H
	*	5755	102.83	-	-	88.89	33.11	11.86	31.03	100	191	P	H
	*	5755	91.94	-	-	78	33.11	11.86	31.03	100	191	A	H
		5853	59.96	-55.4	115.36	45.6	33.39	12.03	31.06	100	191	P	H
		5855.6	60.66	-49.97	110.63	46.29	33.4	12.03	31.06	100	191	P	H
		5893.4	61.06	-30.49	91.55	46.47	33.5	12.17	31.08	100	191	P	H
		5926.6	61.76	-6.44	68.2	46.95	33.59	12.31	31.09	100	191	P	H
802.11n													H
HT40													H
CH 151		5641.4	60.42	-7.78	68.2	46.83	32.8	11.79	31	300	104	P	V
5755MHz		5671	60.73	-23.05	83.78	47.04	32.88	11.82	31.01	300	104	P	V
		5718.6	63.64	-46.77	110.41	49.81	33.01	11.84	31.02	300	104	P	V
		5721.8	64.46	-50.44	114.9	50.62	33.02	11.84	31.02	300	104	P	V
	*	5755	98.38	-	-	84.44	33.11	11.86	31.03	300	104	P	V
	*	5755	87.19	-	-	73.25	33.11	11.86	31.03	300	104	A	V
		5852.2	59.53	-57.65	117.18	45.17	33.39	12.03	31.06	300	104	P	V
		5859.4	60.11	-49.46	109.57	45.74	33.41	12.03	31.07	300	104	P	V
		5878.8	61.4	-40.98	102.38	46.84	33.46	12.17	31.07	300	104	P	V
		5939.6	61.12	-7.08	68.2	46.27	33.63	12.31	31.09	300	104	P	V
													V
													V



WIFI Ant. 1	Note	Frequency ( MHz )	Level ( dBμV/m )	Over Limit ( dB )	Limit Line ( dBμV/m )	Read Level ( dBμV )	Antenna Factor ( dB/m )	Cable Loss ( dB )	Preamp Factor ( dB )	Ant Pos ( cm )	Table Pos ( deg )	Peak Avg. ( P/A )	Pol. ( H/V )
		5632.6	59.73	-8.47	68.2	46.17	32.77	11.79	31	100	214	P	H
		5672.6	62.08	-22.88	84.96	48.39	32.88	11.82	31.01	100	214	P	H
		5700.4	60.3	-45.01	105.31	46.51	32.96	11.84	31.01	100	214	P	H
		5722.8	60.82	-56.36	117.18	46.98	33.02	11.84	31.02	100	214	P	H
	*	5795	105.62	-	-	91.56	33.23	11.88	31.05	100	214	P	H
	*	5795	94.45	-	-	80.39	33.23	11.88	31.05	100	214	A	H
		5851.2	61.48	-57.98	119.46	47.13	33.38	12.03	31.06	100	214	P	H
		5867	62.11	-45.33	107.44	47.58	33.43	12.17	31.07	100	214	P	H
		5888.4	61.71	-33.54	95.25	47.13	33.49	12.17	31.08	100	214	P	H
		5946	61.98	-6.22	68.2	46.97	33.65	12.45	31.09	100	214	P	H
802.11n													H
HT40													H
CH 159		5623	60.12	-8.08	68.2	46.58	32.74	11.79	30.99	282	104	P	V
5795MHz		5690	60.22	-37.61	97.83	46.48	32.93	11.82	31.01	282	104	P	V
		5719.6	61.75	-48.94	110.69	47.92	33.01	11.84	31.02	282	104	P	V
		5720.2	59.19	-52.07	111.26	45.35	33.02	11.84	31.02	282	104	P	V
	*	5795	101.08	-	-	87.02	33.23	11.88	31.05	282	104	P	V
	*	5795	90.13	-	-	76.07	33.23	11.88	31.05	282	104	A	V
		5851.8	60.32	-57.78	118.1	45.96	33.39	12.03	31.06	282	104	P	V
		5865.6	61.24	-46.59	107.83	46.72	33.42	12.17	31.07	282	104	P	V
		5878.4	62.09	-40.58	102.67	47.53	33.46	12.17	31.07	282	104	P	V
		5940.6	61.05	-7.15	68.2	46.06	33.63	12.45	31.09	282	104	P	V
													V
													V
Remark	1. No other spurious found. 2. All results are PASS against Peak and Average limit line.												



Band 4 5725~5850MHz

WIFI 802.11n HT40 (Harmonic @ 3m)

WIFI Ant. 1	Note	Frequency ( MHz )	Level ( dBμV/m )	Over Limit ( dB )	Limit Line ( dBμV/m )	Read Level ( dBμV )	Antenna Factor ( dB/m )	Cable Loss ( dB )	Preamp Factor ( dB )	Ant Pos ( cm )	Table Pos ( deg )	Peak Avg. ( P/A )	Pol. ( H/V )	
802.11n HT40 CH 151 5755MHz		11510	46.25	-27.75	74	45.42	40.18	18.45	57.8	100	0	P	H	
		17265	52.29	-15.91	68.2	44.4	41.98	23.17	57.26	100	0	P	H	
													H	
													H	
			11510	46.07	-27.93	74	45.24	40.18	18.45	57.8	100	0	P	V
			17265	50.51	-17.69	68.2	42.62	41.98	23.17	57.26	100	0	P	V
														V
802.11n HT40 CH 159 5795MHz		11590	46.7	-27.3	74	45.94	40.02	18.54	57.8	100	0	P	H	
		17385	52.6	-15.6	68.2	44.74	42.25	23.29	57.68	100	0	P	H	
													H	
													H	
			11590	47.04	-26.96	74	46.28	40.02	18.54	57.8	100	0	P	V
			17385	52.22	-15.98	68.2	44.36	42.25	23.29	57.68	100	0	P	V
														V
Remark	1. No other spurious found.													
	2. All results are PASS against Peak and Average limit line.													



Band 4 5725~5850MHz

Emission below 1GHz

5GHz WIFI 802.11a (LF @ 3m)

WIFI Ant.	Note	Frequency	Level	Over Limit	Limit Line	Read Level	Antenna Factor	Cable Loss	Preamp Factor	Ant Pos	Table Pos	Peak Avg.	Pol.	
1		( MHz )	( dBμV/m )	( dB )	( dBμV/m )	( dBμV )	( dB/m )	( dB )	( dB )	( cm )	( deg )	( P/A )	( H/V )	
5GHz 802.11a LF		102.9	26.45	-17.05	43.5	41.12	16.33	1.43	32.43	-	-	P	H	
		149.34	37.98	-5.52	43.5	51.12	17.53	1.75	32.42	100	0	P	H	
		240.87	28.45	-17.55	46	41.28	17.68	1.83	32.34	-	-	P	H	
		343.4	29.78	-16.22	46	38.83	20.8	2.44	32.29	-	-	P	H	
		747.3	34.52	-11.48	46	35.33	27.53	3.97	32.31	-	-	P	H	
		935.6	33.14	-12.86	46	29.87	29.92	4.6	31.25	-	-	P	H	
														H
														H
														H
														H
														H
														H
			43.23	34.15	-5.85	40	47.77	18.06	0.78	32.46	100	0	P	V
			99.39	27.61	-15.89	43.5	42.98	16	1.06	32.43	-	-	P	V
			149.88	27.73	-15.77	43.5	40.9	17.5	1.75	32.42	-	-	P	V
			729.8	30.01	-15.99	46	31.36	27.11	3.89	32.35	-	-	P	V
			857.2	31.83	-14.17	46	30.74	28.65	4.28	31.84	-	-	P	V
			937.7	33.31	-12.69	46	29.98	29.97	4.6	31.24	-	-	P	V
													V	
													V	
													V	
													V	
													V	
													V	
Remark	1. No other spurious found. 2. All results are PASS against limit line.													



Emission below 1GHz

5GHz WIFI 802.11n HT20 (LF @ 3m)

WIFI	Note	Frequency	Level	Over	Limit	Read	Antenna	Cable	Preamp	Ant	Table	Peak	Pol.	
Ant.				Limit	Line	Level	Factor	Loss	Factor	Pos	Pos	Avg.		
1		( MHz )	( dBμV/m )	( dB )	( dBμV/m )	( dBμV )	( dB/m )	( dB )	( dB )	( cm )	( deg )	( P/A )	( H/V )	
5GHz 802.11n HT20 LF		44.04	25.56	-14.44	40	39.18	18.06	0.78	32.46	-	-	P	H	
		149.34	38.09	-5.41	43.5	51.23	17.53	1.75	32.42	100	0	P	H	
		239.79	29.25	-16.75	46	42.16	17.6	1.83	32.34	-	-	P	H	
		344.8	28.41	-17.59	46	37.4	20.86	2.44	32.29	-	-	P	H	
		449.8	27.71	-18.29	46	34.11	23.1	2.89	32.39	-	-	P	H	
		972	32.98	-21.02	54	29.14	30.03	4.75	30.94	-	-	P	H	
														H
														H
														H
														H
														H
														H
														H
														H
			46.2	33.3	-6.7	40	48.35	16.63	0.78	32.46	100	0	P	V
			89.94	28.62	-14.88	43.5	45.2	14.8	1.06	32.44	-	-	P	V
			148.53	25.66	-17.84	43.5	38.78	17.55	1.75	32.42	-	-	P	V
			746.6	29.9	-16.1	46	30.71	27.53	3.97	32.31	-	-	P	V
			902	32.38	-13.62	46	30.38	28.95	4.6	31.55	-	-	P	V
			964.3	33.34	-20.66	54	29.47	30.13	4.75	31.01	-	-	P	V
													V	
													V	
													V	
													V	
													V	
													V	
Remark	1. No other spurious found. 2. All results are PASS against limit line.													



Emission below 1GHz

5GHz WIFI 802.11n HT40 (LF @ 3m)

WIFI	Note	Frequency	Level	Over	Limit	Read	Antenna	Cable	Preamp	Ant	Table	Peak	Pol.	
Ant.				Limit	Line	Level	Factor	Loss	Factor	Pos	Pos	Avg.		
1		( MHz )	( dBμV/m )	( dB )	( dBμV/m )	( dBμV )	( dB/m )	( dB )	( dB )	( cm )	( deg )	( P/A )	( H/V )	
5GHz 802.11n HT40 LF		30	23.5	-16.5	40	29.38	25.8	0.78	32.46	-	-	P	H	
		98.85	23.47	-20.03	43.5	38.96	15.88	1.06	32.43	-	-	P	H	
		152.31	28.91	-14.59	43.5	42.18	17.4	1.75	32.42	-	-	P	H	
		670.3	28.85	-17.15	46	31.28	26.16	3.82	32.41	-	-	P	H	
		829.2	30.86	-15.14	46	30.33	28.27	4.28	32.02	-	-	P	H	
		941.9	33.23	-12.77	46	29.6	30.08	4.75	31.2	100	0	P	H	
														H
														H
														H
														H
														H
														H
			47.01	31.95	-8.05	40	47.43	16.2	0.78	32.46	100	0	P	V
			99.12	22.92	-20.58	43.5	38.41	15.88	1.06	32.43	-	-	P	V
			156.9	21.44	-22.06	43.5	34.96	17.15	1.75	32.42	-	-	P	V
			729.1	30.25	-15.75	46	31.6	27.11	3.89	32.35	-	-	P	V
			746.6	33.23	-12.77	46	34.04	27.53	3.97	32.31	-	-	P	V
		946.1	33.41	-12.59	46	29.64	30.19	4.75	31.17	-	-	P	V	
													V	
													V	
													V	
													V	
													V	
													V	
<b>Remark</b>	1. No other spurious found. 2. All results are PASS against limit line.													





**Note symbol**

*	<b>Fundamental Frequency</b> which can be ignored. However, the level of any unwanted emissions shall not exceed the level of the fundamental frequency.
!	Test result is <b>over limit</b> line.
P/A	<b>Peak</b> or <b>Average</b>
H/V	<b>Horizontal</b> or <b>Vertical</b>



A calculation example for radiated spurious emission is shown as below:

WIFI	Note	Frequency	Level	Over	Limit	Read	Antenna	Cable	Preamp	Ant	Table	Peak	Pol.
Ant.				Limit	Line	Level	Factor	Loss	Factor	Pos	Pos	Avg.	
1		( MHz )	( dBμV/m )	( dB )	( dBμV/m )	( dBμV )	( dB/m )	( dB )	( dB )	( cm )	( deg )	( P/A )	( H/V )
802.11b		2390	55.45	-18.55	74	54.51	32.22	4.58	35.86	103	308	P	H
CH 01													
2412MHz		2390	43.54	-10.46	54	42.6	32.22	4.58	35.86	103	308	A	H

- 1. Level(dBμV/m) =  
Antenna Factor(dB/m) + Cable Loss(dB) + Read Level(dBμV) - Preamp Factor(dB)
- 2. Over Limit(dB) = Level(dBμV/m) – Limit Line(dBμV/m)

**For Peak Limit @ 2390MHz:**

- 1. Level(dBμV/m)  
= Antenna Factor(dB/m) + Cable Loss(dB) + Read Level(dBμV) - Preamp Factor(dB)  
= 32.22(dB/m) + 4.58(dB) + 54.51(dBμV) – 35.86 (dB)  
= 55.45 (dBμV/m)
- 2. Over Limit(dB)  
= Level(dBμV/m) – Limit Line(dBμV/m)  
= 55.45(dBμV/m) – 74(dBμV/m)  
= -18.55(dB)

**For Average Limit @ 2390MHz:**

- 1. Level(dBμV/m)  
= Antenna Factor(dB/m) + Cable Loss(dB) + Read Level(dBμV) - Preamp Factor(dB)  
= 32.22(dB/m) + 4.58(dB) + 42.6(dBμV) – 35.86 (dB)  
= 43.54 (dBμV/m)
- 2. Over Limit(dB)  
= Level(dBμV/m) – Limit Line(dBμV/m)  
= 43.54(dBμV/m) – 54(dBμV/m)  
= -10.46(dB)

**Both peak and average measured complies with the limit line, so test result is “PASS”.**



## Appendix C. Radiated Spurious Emission Plots

Test Engineer :	Nick Yu, Karl Hou, Peter Liao, and Citta Ke.	Temperature :	21~23°C
		Relative Humidity :	53~55%

### Band 4 - 5725~5850MHz

### WIFI 802.11a (Band Edge @ 3m)

WIFI	Band 4 5725~5850MHz Band Edge @ 3m	
ANT	802.11a CH149 5745MHz	
1	Horizontal	Fundamental
Peak	<p>Site Condition : 03CH12-HY : PEAK_SE(B4)_16-24 3m HORN_9120D_132S HORIZONTAL : RBW:1000.000KHz VBW:3000.000KHz SWT:Auto</p>	<p>Site Condition : 03CH12-HY : PEAK(FUND)_3m HORN_9120D_132S HORIZONTAL : RBW:1000.000KHz VBW:3000.000KHz SWT:Auto</p>



WIFI	Band 4 5725~5850MHz Band Edge @ 3m	
ANT	802.11a CH149 5745MHz	
1	<b>Vertical</b>	<b>Fundamental</b>
Peak	<p>Site : 03CH12-HY Condition : PEAK_BE(B4)_16-24 3m HORN 9120D_1328 VERTICAL : RBW:1000.000KHz VBW:3000.000KHz SWT:Auto</p>	<p>Site : 03CH12-HY Condition : PEAK(LNB) 3m HORN 9120D_1328 VERTICAL : RBW:1000.000KHz VBW:3000.000KHz SWT:Auto</p>

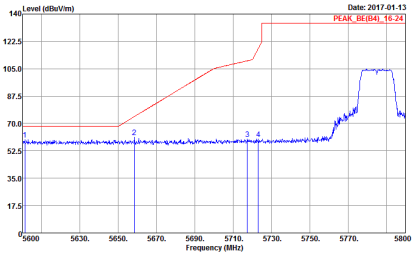
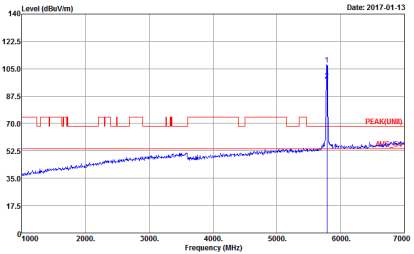
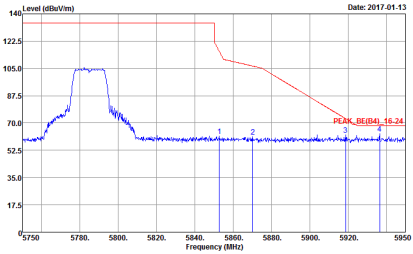

WIFI	Band 4 5725~5850MHz Band Edge @ 3m	
ANT	802.11a CH157 5785MHz	
1	Horizontal	Fundamental
Peak	 <p>Date: 2017-01-13 PEAK_BE(B4)_16-24</p> <p>Site : 03CH12-HY Condition : PEAK_BE(B4)_16-24 3m HORN_9120D_1328 HORIZONTAL : RBW:1000.000KHz VBW:3000.000KHz SWT:Auto</p>	 <p>Date: 2017-01-13 PEAK(LNB)</p> <p>Site : 03CH12-HY Condition : PEAK(LNB) 3m HORN_9120D_1328 HORIZONTAL : RBW:1000.000KHz VBW:3000.000KHz SWT:Auto</p>
Peak	 <p>Date: 2017-01-13 PEAK_BE(B4)_16-24</p> <p>Site : 03CH12-HY Condition : PEAK_BE(B4)_16-24 3m HORN_9120D_1328 HORIZONTAL : RBW:1000.000KHz VBW:3000.000KHz SWT:Auto</p>	Left blank

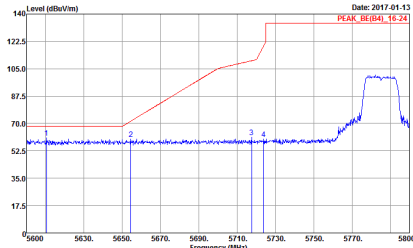
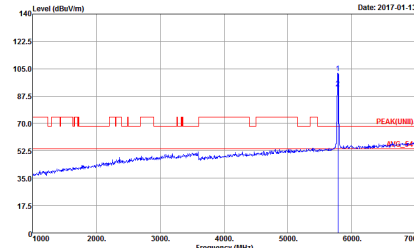
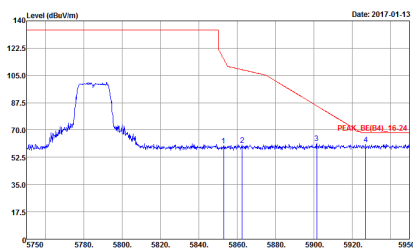

WIFI	Band 4 5725~5850MHz Band Edge @ 3m	
ANT	802.11a CH157 5785MHz	
1	<p style="text-align: center;"><b>Vertical</b></p>  <p>Date: 2017-01-13 PEAK_BE(B4)_16-24</p> <p>Site : 03CH12-HY Condition : PEAK_BE(B4)_16-24 3m HORN_9120D_1328 VERTICAL : RBW:1000.000kHz VBW:3000.000kHz SWT:Auto</p>	<p style="text-align: center;"><b>Fundamental</b></p>  <p>Date: 2017-01-13 PEAK(LNB)</p> <p>Site : 03CH12-HY Condition : PEAK(LNB) 3m HORN_9120D_1328 VERTICAL : RBW:1000.000kHz VBW:3000.000kHz SWT:Auto</p>
Peak	 <p>Date: 2017-01-13 PEAK_BE(B4)_16-24</p> <p>Site : 03CH12-HY Condition : PEAK_BE(B4)_16-24 3m HORN_9120D_1328 VERTICAL : RBW:1000.000kHz VBW:3000.000kHz SWT:Auto</p>	Left blank

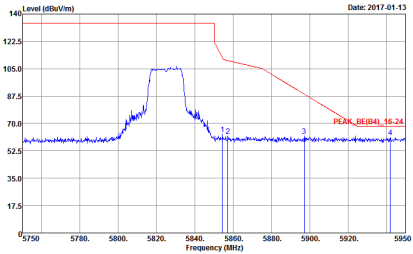
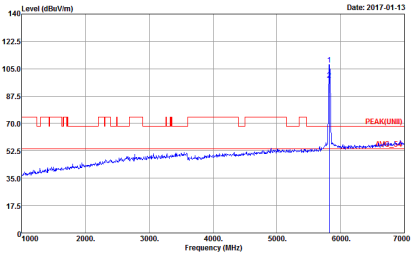

WIFI	Band 4 5725~5850MHz Band Edge @ 3m	
ANT	802.11a CH165 5825MHz	
1	Horizontal	Fundamental
Peak	 <p data-bbox="347 734 762 772">Date: 2017-01-13 Site : 03CH12-HY Condition : PEAK_BE(B4)_16-24 3m HORN 9120D_1326 HORIZONTAL : RBW:1000.000KHz VBW:3000.000KHz SWT:Auto</p>	 <p data-bbox="944 734 1359 772">Date: 2017-01-13 Site : 03CH12-HY Condition : PEAK(UWB) 3m HORN 9120D_1326 HORIZONTAL : RBW:1000.000KHz VBW:3000.000KHz SWT:Auto</p>



WIFI	Band 4 5725~5850MHz Band Edge @ 3m	
ANT	802.11a CH165 5825MHz	
1	Vertical	Fundamental
Peak	<p>Date: 2017-01-13</p> <p>Site : 03CH12-HY Condition : PEAK (BEB4)_16-24 3m HORN 9120D_1320 VERTICAL : RBW:1000.000KHz VBW:3000.000KHz SWT:Auto</p>	<p>Date: 2017-01-13</p> <p>Site : 03CH12-HY Condition : PEAK (UNB) 3m HORN 9120D_1320 VERTICAL : RBW:1000.000KHz VBW:3000.000KHz SWT:Auto</p>





Band 4 5725~5850MHz  
WIFI 802.11n HT20 (Band Edge @ 3m)

WIFI	Band 4 5725~5850MHz Band Edge @ 3m	
ANT	802.11n HT20 CH149 5745MHz	
1	<b>Horizontal</b>	<b>Fundamental</b>
Peak	<p>Site Condition : 03CH12-HY : PEAK_BE(B4)_16-24 3m HORN_9120D_1328 HORIZONTAL : RBW:1000.000KHz VBW:3000.000KHz SWT:Auto</p>	<p>Site Condition : 03CH12-HY : PEAK(UNI) 3m HORN_9120D_1328 HORIZONTAL : RBW:1000.000KHz VBW:3000.000KHz SWT:Auto</p>

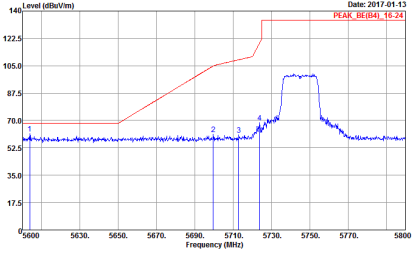
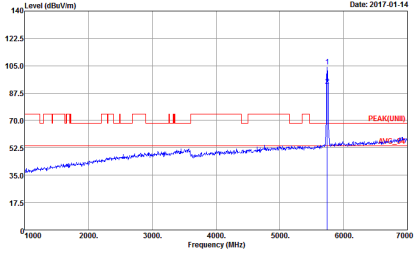

WIFI	Band 4 5725~5850MHz Band Edge @ 3m	
ANT	802.11n HT20 CH149 5745MHz	
1	Vertical	Fundamental
Peak	 <p>Date: 2017-01-13 PEAK: BE(B4)_16-24</p> <p>Site : 03CH12-HY Condition : PEAK: BE(B4)_16-24 3m HORN_9120D_1320 VERTICAL : RBW:1000.000KHz VBW:3000.000KHz SWT:Auto</p>	 <p>Date: 2017-01-14</p> <p>Site : 03CH12-HY Condition : PEAK(UNID) 3m HORN_9120D_1320 VERTICAL : RBW:1000.000KHz VBW:3000.000KHz SWT:Auto</p>

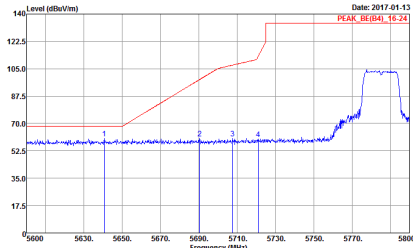
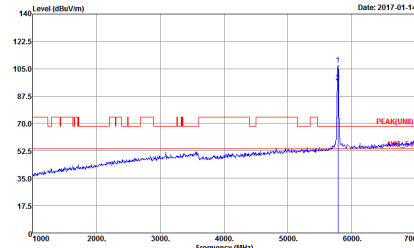
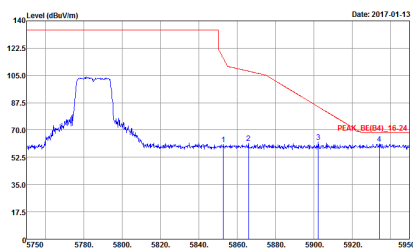

WIFI	Band 4 5725~5850MHz Band Edge @ 3m	
ANT	802.11n HT20 CH157 5785MHz	
1	<p style="text-align: center;"><b>Horizontal</b></p>  <p style="font-size: small;">Date: 2017-01-13 PEAK_BE(B4)_16-24</p> <p style="font-size: x-small;">Site : 03CH12-HY Condition : PEAK_BE(B4)_16-24 3m HORN_9120D_1328 HORIZONTAL : RBW:1000.000KHz VBW:3000.000KHz SWT:Auto</p>	<p style="text-align: center;"><b>Fundamental</b></p>  <p style="font-size: small;">Date: 2017-01-14 PEAK(LNB)</p> <p style="font-size: x-small;">Site : 03CH12-HY Condition : PEAK(LNB) 3m HORN_9120D_1328 HORIZONTAL : RBW:1000.000KHz VBW:3000.000KHz SWT:Auto</p>
Peak	 <p style="font-size: small;">Date: 2017-01-13 PEAK_BE(B4)_16-24</p> <p style="font-size: x-small;">Site : 03CH12-HY Condition : PEAK_BE(B4)_16-24 3m HORN_9120D_1328 HORIZONTAL : RBW:1000.000KHz VBW:3000.000KHz SWT:Auto</p>	Left blank

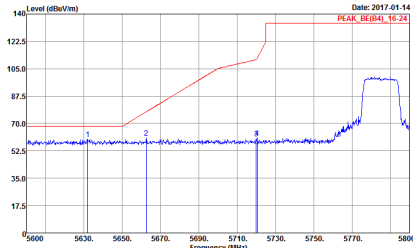
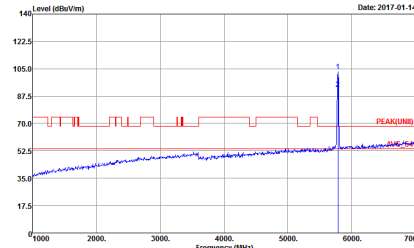
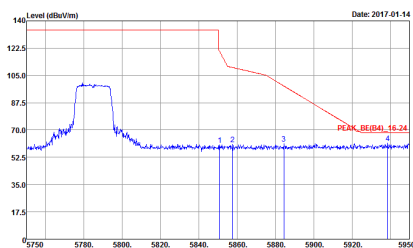

WIFI	Band 4 5725~5850MHz Band Edge @ 3m	
ANT	802.11n HT20 CH157 5785MHz	
1	<p style="text-align: center;"><b>Vertical</b></p>  <p>Date: 2017-01-14 PEAK_BE(B4)_16-24</p> <p>Site : 03CH12-HY Condition : PEAK_BE(B4)_16-24 3m HORN_9120D_1328 VERTICAL : RBW:1000.000KHz VBW:3000.000KHz SWT:Auto</p>	<p style="text-align: center;"><b>Fundamental</b></p>  <p>Date: 2017-01-14 PEAK(LNB)</p> <p>Site : 03CH12-HY Condition : PEAK(LNB) 3m HORN_9120D_1328 VERTICAL : RBW:1000.000KHz VBW:3000.000KHz SWT:Auto</p>
Peak	 <p>Date: 2017-01-14 PEAK_BE(B4)_16-24</p> <p>Site : 03CH12-HY Condition : PEAK_BE(B4)_16-24 3m HORN_9120D_1328 VERTICAL : RBW:1000.000KHz VBW:3000.000KHz SWT:Auto</p>	Left blank

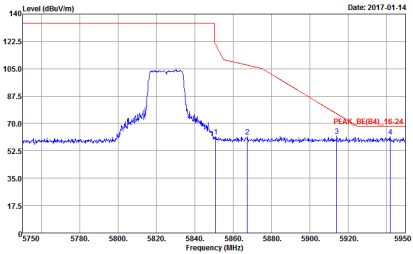
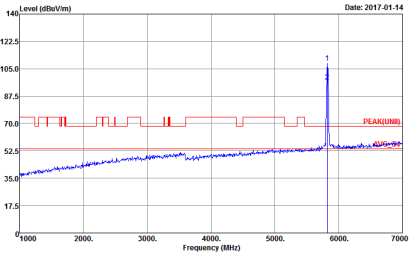

WIFI	Band 4 5725~5850MHz Band Edge @ 3m	
ANT	802.11n HT20 CH165 5825MHz	
1	Horizontal	Fundamental
Peak	 <p>Date: 2017-01-14</p> <p>Site : 03CH12-HY Condition : PEAK_SE(84)_16-24 3m HORN_9120D_132S HORIZONTAL : RBW:1000.000KHz VBW:3000.000KHz SWT:Auto</p>	 <p>Date: 2017-01-14</p> <p>Site : 03CH12-HY Condition : PEAK(UNB) 3m HORN_9120D_132S HORIZONTAL : RBW:1000.000KHz VBW:3000.000KHz SWT:Auto</p>



WIFI	Band 4 5725~5850MHz Band Edge @ 3m	
ANT	802.11n HT20 CH165 5825MHz	
1	Vertical	Fundamental
Peak	<p>Site : 03CH12-HY Condition : PEAK_BEG(B4)_16-24 3m HORN_9120D_1320 VERTICAL : RBW:1000.000KHz VBW:3000.000KHz SWT:Auto</p>	<p>Site : 03CH12-HY Condition : PEAK(UNB) 3m HORN_9120D_1320 VERTICAL : RBW:1000.000KHz VBW:3000.000KHz SWT:Auto</p>



Band 4 5725~5850MHz  
WIFI 802.11n HT40 (Band Edge @ 3m)

WIFI	Band 4 5725~5850MHz Band Edge @ 3m	
ANT	802.11n HT40 CH151 5755MHz	
1	<b>Horizontal</b>	<b>Fundamental</b>
Peak	<p>Site Condition : 03CH12-HY : PEAK_BE(B4)_16-24 3m HORN_9120D_1328 HORIZONTAL : RBW:1000.000KHz VBW:3000.000KHz SWT:Auto</p>	<p>Site Condition : 03CH12-HY : PEAK(UM) 3m HORN_9120D_1328 HORIZONTAL : RBW:1000.000KHz VBW:3000.000KHz SWT:Auto</p>
Peak	<p>Site Condition : 03CH12-HY : PEAK_BE(B4)_16-24 3m HORN_9120D_1328 HORIZONTAL : RBW:1000.000KHz VBW:3000.000KHz SWT:Auto</p>	Left blank



WIFI	Band 4 5725~5850MHz Band Edge @ 3m	
ANT	802.11n HT40 CH151 5755MHz	
1	<p style="text-align: center;"><b>Vertical</b></p> <p style="text-align: right;">Date: 2017-01-14 PEAK_BE(B4)_16-24</p> <p>Site : 03CH12-HY Condition : PEAK_BE(B4)_16-24 3m HORN_9120D_1328 VERTICAL : RBW:1000.000KHz VBW:3000.000KHz SWT:Auto</p>	<p style="text-align: center;"><b>Fundamental</b></p> <p style="text-align: right;">Date: 2017-01-14 PEAK(LNB)</p> <p>Site : 03CH12-HY Condition : PEAK(LNB) 3m HORN_9120D_1328 VERTICAL : RBW:1000.000KHz VBW:3000.000KHz SWT:Auto</p>
Peak	<p style="text-align: right;">Date: 2017-01-14 PEAK_BE(B4)_16-24</p> <p>Site : 03CH12-HY Condition : PEAK_BE(B4)_16-24 3m HORN_9120D_1328 VERTICAL : RBW:1000.000KHz VBW:3000.000KHz SWT:Auto</p>	<p style="text-align: center;">Left blank</p>



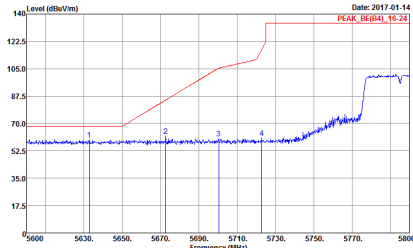
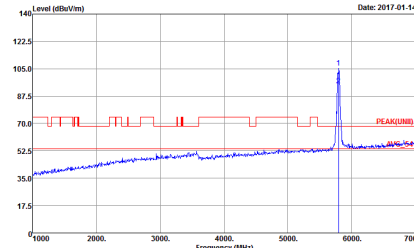
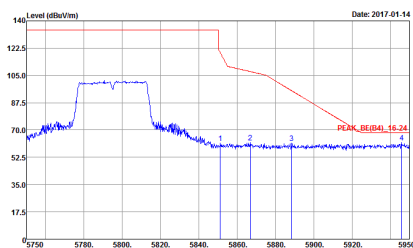

WIFI	Band 4 5725~5850MHz Band Edge @ 3m	
ANT	802.11n HT40 CH159 5795MHz	
1	<p style="text-align: center;"><b>Horizontal</b></p>  <p style="font-size: small;">Date: 2017-01-14 PEAK_BE(B4)_16-24</p> <p style="font-size: x-small;">Site : 03CH12-HY Condition : PEAK_BE(B4)_16-24 3m HORN_9120D_1328 HORIZONTAL : RBW:1000.000KHz VBW:3000.000KHz SWT:Auto</p>	<p style="text-align: center;"><b>Fundamental</b></p>  <p style="font-size: small;">Date: 2017-01-14 PEAK(LNB)</p> <p style="font-size: x-small;">Site : 03CH12-HY Condition : PEAK(LNB) 3m HORN_9120D_1328 HORIZONTAL : RBW:1000.000KHz VBW:3000.000KHz SWT:Auto</p>
Peak	 <p style="font-size: small;">Date: 2017-01-14 PEAK_BE(B4)_16-24</p> <p style="font-size: x-small;">Site : 03CH12-HY Condition : PEAK_BE(B4)_16-24 3m HORN_9120D_1328 HORIZONTAL : RBW:1000.000KHz VBW:3000.000KHz SWT:Auto</p>	Left blank



WIFI	Band 4 5725~5850MHz Band Edge @ 3m	
ANT	802.11n HT40 CH159 5795MHz	
1	<p style="text-align: center;"><b>Vertical</b></p> <p>Site : 03CH12-HY Condition : PEAK_BE(B4)_16-24 3m HORN_9120D_1328 VERTICAL : RBW:1000.000kHz VBW:3000.000kHz SWT:Auto</p>	<p style="text-align: center;"><b>Fundamental</b></p> <p>Site : 03CH12-HY Condition : PEAK(LNB) 3m HORN_9120D_1328 VERTICAL : RBW:1000.000kHz VBW:3000.000kHz SWT:Auto</p>
Peak	<p>Site : 03CH12-HY Condition : PEAK_BE(B4)_16-24 3m HORN_9120D_1328 VERTICAL : RBW:1000.000kHz VBW:3000.000kHz SWT:Auto</p>	Left blank



Band 4 - 5725~5850MHz

WIFI 802.11a (Harmonic @ 3m)

WIFI	Band 4 5725~5850MHz Harmonic @ 3m	
ANT	802.11a CH149 5745MHz	
1	Horizontal	Vertical
Peak Avg.	<p>Site : 03CH12-HY Condition : PEAK(UNI) 3m HORN_9120D_1328 HORIZONTAL Detector : Peak</p>	<p>Site : 03CH12-HY Condition : PEAK(UNI) 3m HORN_9120D_1328 VERTICAL Detector : Peak</p>

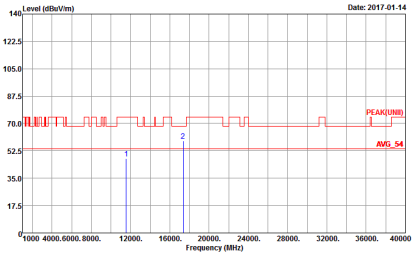
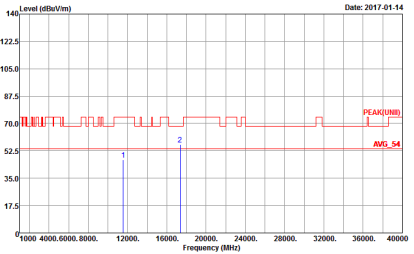

WIFI	Band 4 5725~5850MHz Harmonic @ 3m	
ANT	802.11a CH157 5785MHz	
1	Horizontal	Vertical
Peak Avg.	 <p>Site : 03CH12-HY Condition : PEAK(UNI) 3m HORN_9120D_1328 HORIZONTAL Detector : Peak</p>	 <p>Site : 03CH12-HY Condition : PEAK(UNI) 3m HORN_9120D_1328 VERTICAL Detector : Peak</p>

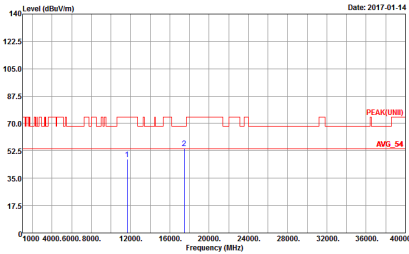
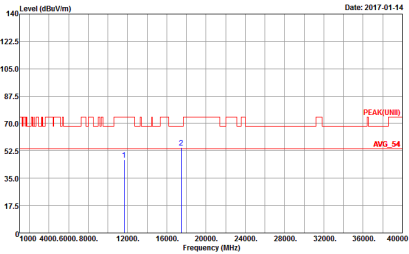

WIFI	Band 4 5725~5850MHz Harmonic @ 3m	
ANT	802.11a CH165 5825MHz	
1	Horizontal	Vertical
Peak Avg.	 <p>Site : 03CH12-HY Condition : PEAK(UNI) 3m HORN_9120D_1328 HORIZONTAL Detector : Peak</p>	 <p>Site : 03CH12-HY Condition : PEAK(UNI) 3m HORN_9120D_1328 VERTICAL Detector : Peak</p>



Band 4 5725~5850MHz  
WIFI 802.11n HT20 (Harmonic @ 3m)

WIFI	Band 4 5725~5850MHz Harmonic @ 3m	
ANT	802.11n HT20 CH149 5745MHz	
1	Horizontal	Vertical
Peak Avg.	<p>Site : 03CH12-HY Condition : PEAK(UNI) 3m HORN_9120D_1328 HORIZONTAL Detector : Peak</p>	<p>Site : 03CH12-HY Condition : PEAK(UNI) 3m HORN_9120D_1328 VERTICAL Detector : Peak</p>

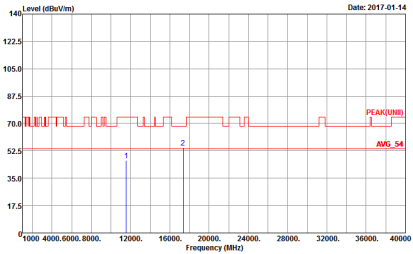
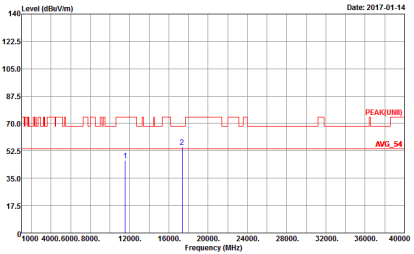

WIFI	Band 4 5725~5850MHz Harmonic @ 3m	
ANT	802.11n HT20 CH157 5785MHz	
1	Horizontal	Vertical
Peak Avg.	 <p>Site : 03CH12-HY Condition : PEAK(UNI) 3m HORN_9120D_1328 HORIZONTAL Detector : Peak</p>	 <p>Site : 03CH12-HY Condition : PEAK(UNI) 3m HORN_9120D_1328 VERTICAL Detector : Peak</p>

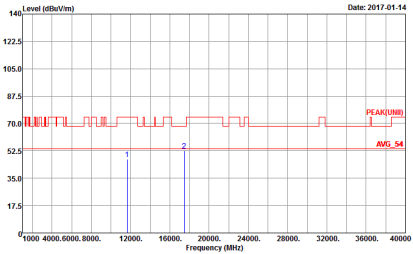
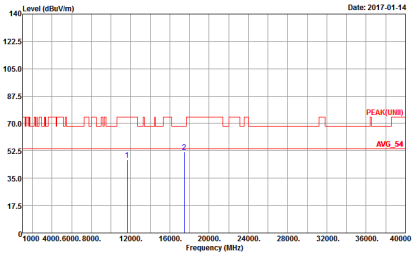

WIFI	Band 4 5725~5850MHz Harmonic @ 3m	
ANT	802.11n HT20 CH165 5825MHz	
1	Horizontal	Vertical
Peak Avg.	 <p>Site : 03CH12-HY Condition : PEAK(UNI) 3m HORN_9120D_1328 HORIZONTAL Detector : Peak</p>	 <p>Site : 03CH12-HY Condition : PEAK(UNI) 3m HORN_9120D_1328 VERTICAL Detector : Peak</p>





Band 4 5725~5850MHz  
WIFI 802.11n HT40 (Harmonic @ 3m)

WIFI	Band 4 5725~5850MHz Harmonic @ 3m	
ANT	802.11n HT40 CH151 5755MHz	
1	Horizontal	Vertical
Peak Avg.	<p>Site : 03CH12-HY Condition : PEAK(UNI) 3m HORN_9120D_1328 HORIZONTAL Detector : Peak</p>	<p>Site : 03CH12-HY Condition : PEAK(UNI) 3m HORN_9120D_1328 VERTICAL Detector : Peak</p>

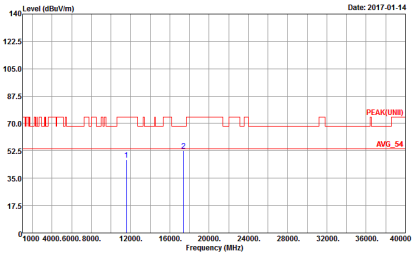
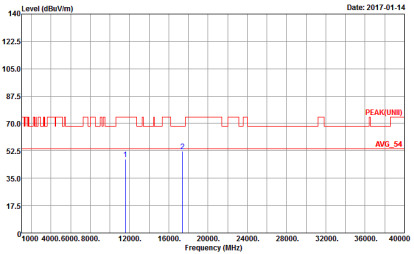

WIFI	Band 4 5725~5850MHz Harmonic @ 3m	
ANT	802.11n HT40 CH159 5795MHz	
1	Horizontal	Vertical
Peak Avg.	 <p>Site : 03CH12-HY Condition : PEAK(UNI) 3m HORN_9120D_1328 HORIZONTAL Detector : Peak</p>	 <p>Site : 03CH12-HY Condition : PEAK(UNI) 3m HORN_9120D_1328 VERTICAL Detector : Peak</p>



Band 4 5725~5850MHz

Emission below 1GHz

5GHz WIFI 802.11a (LF)

WIFI	5GHz 5725~5850MHz	
ANT	802.11a LF	
1	Horizontal	Vertical
QP / Peak	<p>Site : 03CH12-HY Condition : QP 3m BILOG_6111D_37059 HORIZONTAL Detector : Peak</p>	<p>Site : 03CH12-HY Condition : QP 3m BILOG_6111D_37059 VERTICAL Detector : Peak</p>



Emission below 1GHz  
5GHz WIFI 802.11n HT20 (LF)

WIFI	5GHz 5725~5850MHz	
ANT	802.11n HT20 LF	
1	Horizontal	Vertical
QP / Peak	<p>Site : 03CH12-HY Condition : QP 3m BIL06_6111D_37059 HORIZONTAL Detector : Peak</p>	<p>Site : 03CH12-HY Condition : QP 3m BIL06_6111D_37059 VERTICAL Detector : Peak</p>



Emission below 1GHz

5GHz WIFI 802.11n HT40 (LF)

WIFI	5GHz 5725~5850MHz	
ANT	802.11n HT40 LF	
1	<b>Horizontal</b>	<b>Vertical</b>
QP / Peak	<p>Site : 03CH12-HY Condition : QP 3m BIL06_6111D_37059 HORIZONTAL Detector : Peak</p>	<p>Site : 03CH12-HY Condition : QP 3m BIL06_6111D_37059 VERTICAL Detector : Peak</p>



## Appendix D Duty Cycle Plots

Band	Duty Cycle(%)	T(us)	1/T(kHz)	VBW Setting
802.11a	97.20	1390	0.72	1kHz
5GHz 802.11n HT20	96.30	1300	0.77	1kHz
5GHz 802.11n HT40	94.74	648	1.54	3kHz

### 802.11a

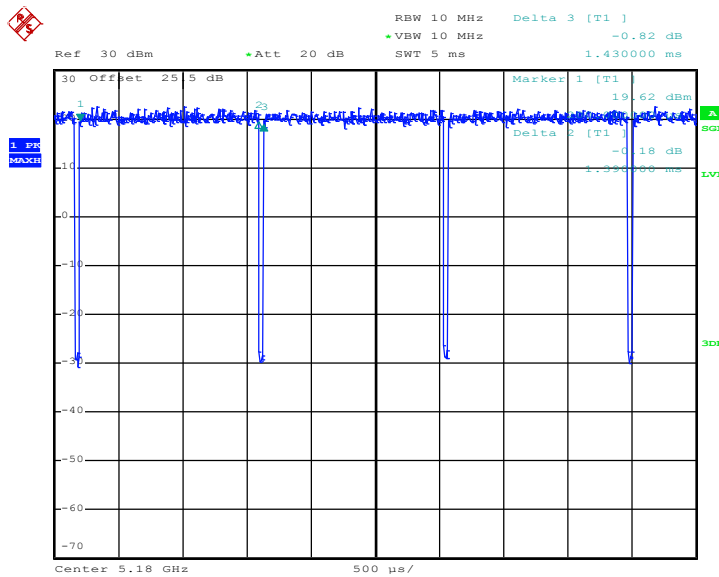

Date: 3.JAN.2017 20:05:11



5GHz 802.11n HT20

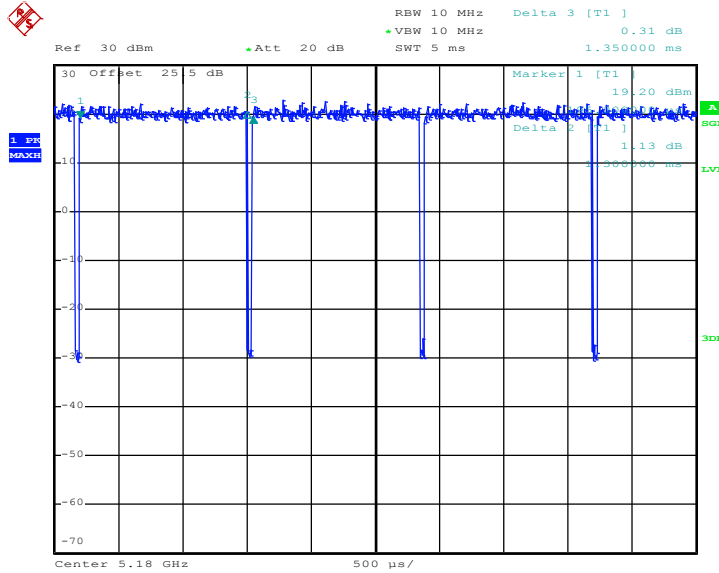

Date: 3.JAN.2017 20:24:43

5GHz 802.11n HT40

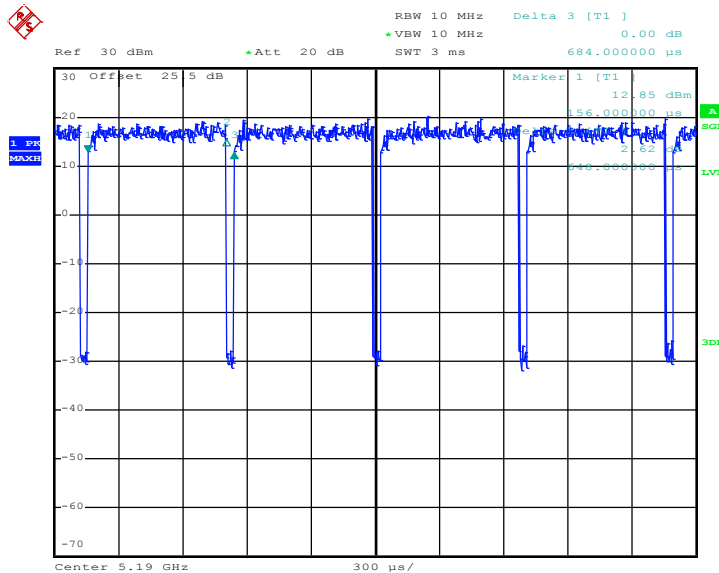

Date: 3.JAN.2017 21:16:59