



FCC RF Test Report

APPLICANT : Sony Mobile Communications Inc.
EQUIPMENT : GSM/WCDMA/LTE Phone+Bluetooth, DTS/UNII
a/b/g/n and NFC
BRAND NAME : Sony
FCC ID : PY7-08618V
STANDARD : FCC Part 15 Subpart E §15.407
CLASSIFICATION : (NII) Unlicensed National Information Infrastructure

The product was received on Dec. 29, 2016 and testing was completed on Mar. 15, 2017. We, SPORTON INTERNATIONAL INC., would like to declare that the tested sample has been evaluated in accordance with the test procedures and has been in compliance with the applicable technical standards.

The test results in this report apply exclusively to the tested model / sample. Without written approval of SPORTON INTERNATIONAL INC., the test report shall not be reproduced except in full.

Reviewed by: Joseph Lin / Supervisor

Approved by: Jones Tsai / Manager



SPORTON INTERNATIONAL INC.

No. 52, Hwa Ya 1st Rd., Hwa Ya Technology Park, Kwei-Shan District, Tao Yuan City, Taiwan, R.O.C.

SPORTON INTERNATIONAL INC.

TEL : 886-3-327-3456

FAX : 886-3-328-4978

FCC ID : PY7-08618V

Page Number : 1 of 39

Report Issued Date : Mar. 16, 2017

Report Version : Rev. 04

Report Template No.: BU5-FR15EWL Version 1.4



TABLE OF CONTENTS

SUMMARY OF TEST RESULT 4

1 GENERAL DESCRIPTION 5

1.1 Applicant 5

1.2 Manufacturer 5

1.3 Product Feature of Equipment Under Test 5

1.4 Modification of EUT 6

1.5 Testing Location 7

1.6 Applicable Standards 8

2 TEST CONFIGURATION OF EQUIPMENT UNDER TEST 9

2.1 Carrier Frequency Channel 9

2.2 Test Mode 10

2.3 Connection Diagram of Test System 11

2.4 Support Unit used in test configuration and system 12

2.5 EUT Operation Test Setup 12

2.6 Measurement Results Explanation Example 12

3 TEST RESULT 13

3.1 26dB & 99% Occupied Bandwidth Measurement 13

3.2 Maximum Conducted Output Power Measurement 15

3.3 Power Spectral Density Measurement 18

3.4 Unwanted Radiated Emission Measurement 22

3.5 AC Conducted Emission Measurement 28

3.6 Frequency Stability Measurement 34

3.7 Automatically Discontinue Transmission 35

3.8 Antenna Requirements 36

4 LIST OF MEASURING EQUIPMENTS 37

5 UNCERTAINTY OF EVALUATION 39

APPENDIX A. CONDUCTED TEST RESULTS

APPENDIX B. RADIATED SPURIOUS EMISSION

APPENDIX C. RADIATED SPURIOUS EMISSION PLOTS

APPENDIX D. DUTY CYCLE PLOTS



SUMMARY OF TEST RESULT

Report Section	FCC Rule	Description	Limit	Result	Remark
3.1	2.1049 15.403(i)	26dB & 99% Bandwidth	-	Pass	-
3.2	15.407(a)	Maximum Conducted Output Power	FCC ≤ 24 dBm (depend on band)	Pass	-
3.3	15.407(a)	Power Spectral Density	FCC ≤ 11 dBm (depend on band)	Pass	-
3.4	15.407(b)	Unwanted Emissions	≤ -17, -27 dBm (depend on band)&15.209(a)	Pass	Under limit 3.41 dB at 5350.080 MHz
3.5	15.207	AC Conducted Emission	15.207(a)	Pass	Under limit 13.50 dB at 3.998 MHz
3.6	15.407(g)	Frequency Stability	Within Operation Band	Pass	-
3.7	15.407(c)	Automatically Discontinue Transmission	Discontinue Transmission	Pass	-
3.8	15.203 & 15.407(a)	Antenna Requirement	N/A	Pass	-



1 General Description

1.1 Applicant

Sony Mobile Communications Inc.

4-12-3 Higashi-Shinagawa, Shinagawa-ku, Tokyo, 140-0002, Japan

1.2 Manufacturer

Sony Mobile Communications Inc.

4-12-3 Higashi-Shinagawa, Shinagawa-ku, Tokyo, 140-0002, Japan

1.3 Product Feature of Equipment Under Test

GSM/WCDMA/LTE, Bluetooth, DTS/UNII a/b/g/n, NFC, and GPS

Standards-related Product Specification	
Antenna Type	PIFA Antenna
Antenna Gain	<5150 MHz ~ 5250 MHz> -2.20 dBi
	<5250 MHz ~ 5350 MHz> -1.60 dBi
	<5470 MHz ~ 5725 MHz> -1.40 dBi

EUT Information List			
HW Version	SW Version	S/N	Performed Test Item
A	1.21	0123456789ABCDEF	RF conducted measurement
		WUJ01NNJAG	Radiated Spurious Emission
		WUJ01NNPAN	Conducted Emission



Accessory List	
AC Adapter	Model No. : EP800
	S/N :
	3015W41600900 (for radiated spurious emission) 3015W42100643 (for conducted emission)
Earphone	Model No. : MH410c
	S/N: N/A
USB Cable	Model No. : UCB20
	S/N :
	1635A91C00314D8 (for radiated spurious emission) 1635A9100031498 (for conducted emission)

Note:

1. Above EUT list and accessory list used are electrically identical per declared by manufacturer.
2. Above the accessories list are used to exercise the EUT during test.
3. For other wireless features of this EUT, test report will be issued separately.

1.4 Modification of EUT

No modifications are made to the EUT during all test items.



1.5 Testing Location

Sporton Lab is accredited to ISO 17025 by Taiwan Accreditation Foundation (TAF code : 1190) and the FCC designation No. TW0007 under the FCC 2.948(e) by Mutual Recognition Agreement (MRA) in FCC Test.

Test Site	SPORTON INTERNATIONAL INC.	
Test Site Location	No. 52, Hwa Ya 1 st Rd., Hwa Ya Technology Park, Kwei-Shan District, Tao Yuan City, Taiwan, R.O.C. TEL: +886-3-327-3456 FAX: +886-3-328-4978	
Test Site No.	Sporton Site No.	
	TH05-HY	CO05-HY

Note: The test site complies with ANSI C63.4 2014 requirement.

Test Site	SPORTON INTERNATIONAL INC.	
Test Site Location	No.58, Aly. 75, Ln. 564, Wenhua 3rd Rd. Guishan Dist, Taoyuan City, Taiwan (R.O.C.) TEL: +886-3-327-0868 FAX: +886-3-327-0855	
Test Site No.	Sporton Site No.	
	03CH12-HY	

Note: The test site complies with ANSI C63.4 2014 requirement.



1.6 Applicable Standards

According to the specifications of the manufacturer, the EUT must comply with the requirements of the following standards:

- ♦ FCC Part 15 Subpart E
- ♦ FCC KDB 789033 D02 General UNII Test Procedures New Rules v01r03
- ♦ ANSI C63.10-2013

Remark:

1. All test items were verified and recorded according to the standards and without any deviation during the test.
2. This EUT has also been tested and complied with the requirements of FCC Part 15, Subpart B, recorded in a separate test report.



2 Test Configuration of Equipment Under Test

The EUT has been associated with peripherals and configuration operated in a manner tended to maximize its emission characteristics in a typical application. Frequency range investigated: conducted emission (150 kHz to 30 MHz) and radiated emission (9 kHz to the 10th harmonic of the highest fundamental frequency or to 40 GHz, whichever is lower). For radiated measurement, pre-scanned in three orthogonal panels, X, Y, Z. The worst cases (X plane) were recorded in this report.

2.1 Carrier Frequency Channel

Frequency Band	Channel	Freq. (MHz)	Channel	Freq. (MHz)
5150-5250 MHz Band 1 (U-NII-1)	36	5180	44	5220
	38*	5190	46*	5230
	40	5200	48	5240
	-	-		

Frequency Band	Channel	Freq. (MHz)	Channel	Freq. (MHz)
5250-5350 MHz Band 2 (U-NII-2A)	52	5260	60	5300
	54*	5270	62*	5310
	56	5280	64	5320
	-	-		

Frequency Band	Channel	Freq. (MHz)	Channel	Freq. (MHz)
5470-5725 MHz Band 3 (U-NII-2C)	100	5500	112	5560
	102*	5510	116	5580
	104	5520	132	5660
	-	-	134*	5670
	108	5540	136	5680
	110*	5550	140	5700

Frequency Band	Channel	Freq. (MHz)	Channel	Freq. (MHz)
Straddle Channel	-	-	144	5720
	142*	5710		

Note: The above Frequency and Channel in "*" were 802.11n HT40



2.2 Test Mode

Final test mode of conducted test items and radiated spurious emissions are considering the modulation and worse data rates as below table.

Modulation	Data Rate
802.11a	6 Mbps
802.11n HT20	MCS0
802.11n HT40	MCS0

AC Conducted Emission	Mode 1 : GSM1900 Idle + Bluetooth Link + WLAN (5GHz) Link + MP3 + Earphone + Battery + USB Cable (Charging from Adapter)
------------------------------	--

Ch. #		Band I : 5150-5250 MHz	Band II : 5250-5350 MHz	Band III : 5470-5725MHz
		802.11a	802.11a	802.11a
L	Low	36	52	100
M	Middle	44	60	116
H	High	48	64	140
Straddle		-	-	144

Ch. #		Band I : 5150-5250 MHz	Band II : 5250-5350 MHz	Band III : 5470-5725MHz
		802.11n HT20	802.11n HT20	802.11n HT20
L	Low	36	52	100
M	Middle	44	60	116
H	High	48	64	140
Straddle		-	-	144

Ch. #		Band I : 5150-5250 MHz	Band II : 5250-5350 MHz	Band III : 5470-5725MHz
		802.11n HT40	802.11n HT40	802.11n HT40
L	Low	38	54	102
M	Middle	-	-	110
H	High	46	62	134
Straddle		-	-	142

2.3 Connection Diagram of Test System

<WLAN Tx Mode>

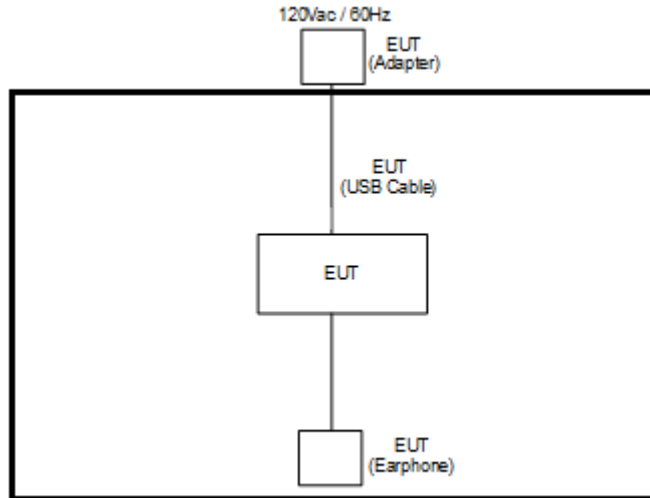

<AC Conducted Emission Mode>

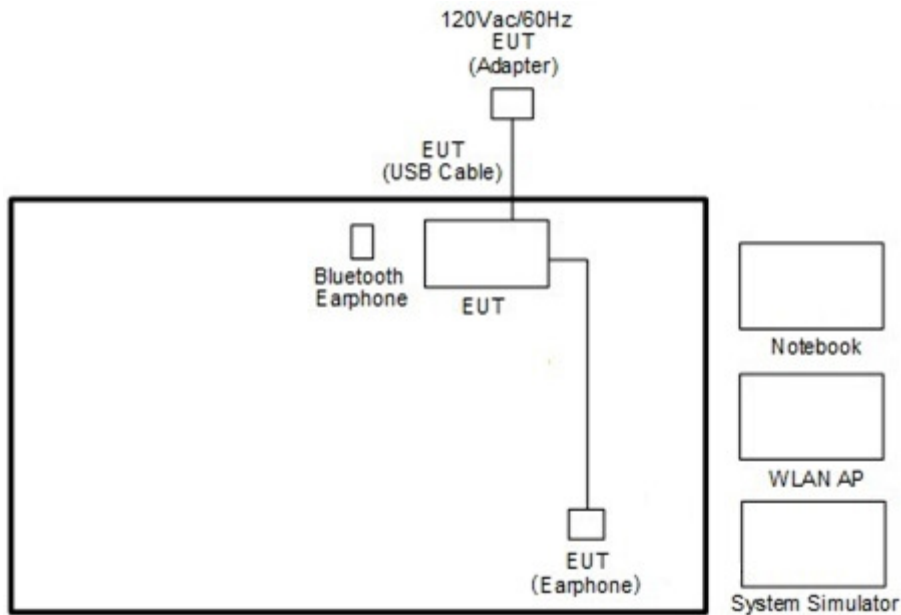



2.4 Support Unit used in test configuration and system

Item	Equipment	Trade Name	Model Name	FCC ID	Data Cable	Power Cord
1.	System Simulator	Anritsu	MT8820C	N/A	N/A	Unshielded, 1.8 m
2.	WLAN AP	ASUS	RT-AC66U	MSQ-RTAC66U	N/A	Unshielded, 1.8 m
3.	Notebook	DELL	Latitude E6320	FCC DoC/ Contains FCC ID: QDS-BRCM1054	N/A	AC I/P: Unshielded, 1.2 m DC O/P: Shielded, 1.8 m
4.	Bluetooth Earphone	Sony	SBH20	PY7-RD0010	N/A	N/A
5.	SD Card	SanDisk	MicroSD HC	FCC DoC	N/A	N/A

2.5 EUT Operation Test Setup

For RF test items, an engineering test program was provided and enabled to make EUT transmitting signals.

2.6 Measurement Results Explanation Example

For all conducted test items:

The offset level is set in the spectrum analyzer to compensate the RF cable loss and attenuator factor between EUT conducted output port and spectrum analyzer. With the offset compensation, the spectrum analyzer reading level is exactly the EUT RF output level.

Example :

The spectrum analyzer offset is derived from RF cable loss and attenuator factor.

Offset = RF cable loss + attenuator factor.

Following shows an offset computation example with cable loss 4.2 dB and 10dB attenuator.

$$\begin{aligned}
 \text{Offset(dB)} &= \text{RF cable loss(dB)} + \text{attenuator factor(dB)}. \\
 &= 4.2 + 10 = 14.2 \text{ (dB)}
 \end{aligned}$$

3 Test Result

3.1 26dB & 99% Occupied Bandwidth Measurement

3.1.1 Description of 26dB & 99% Occupied Bandwidth

This section is for reporting purpose only.

There is no restriction limits for bandwidth.

For Straddle Channel, U-NII procedures and limits were applied for operations in the frequency band in accordance with FCC KDB 644545 D03.

3.1.2 Measuring Instruments

The measuring equipment is listed in the section 4 of this test report.

3.1.3 Test Procedures

1. The testing follows FCC KDB 789033 D02 General UNII Test Procedures New Rules v01r03. Section C) Emission bandwidth
2. Set RBW = approximately 1% of the emission bandwidth.
3. Set the VBW > RBW.
4. Detector = Peak.
5. Trace mode = max hold
6. Measure the maximum width of the emission that is 26 dB down from the peak of the emission. Compare this with the RBW setting of the analyzer. Readjust RBW and repeat measurement as needed until the RBW/EBW ratio is approximately 1%.
7. For 99% Bandwidth Measurement, the spectrum analyzer's resolution bandwidth (RBW) is set 1MHz and set the Video bandwidth (VBW) $\geq 3 * RBW$.
8. Measure and record the results in the test report.

3.1.4 Test Setup

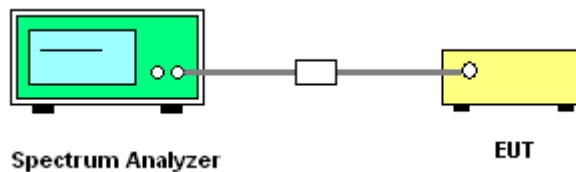



3.1.5 Test Result of 26dB & 99% Occupied Bandwidth Plots

Please refer to Appendix A.

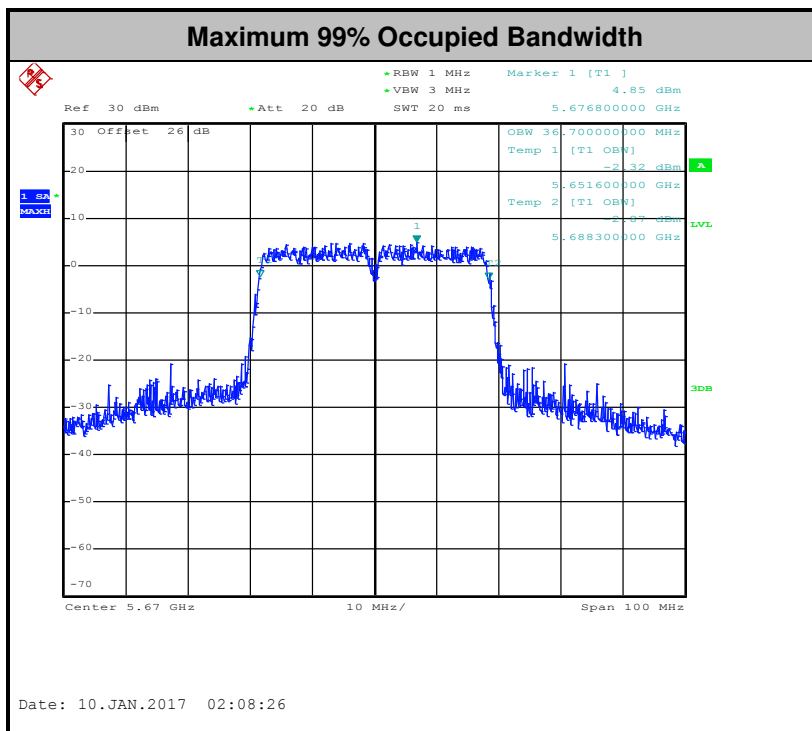
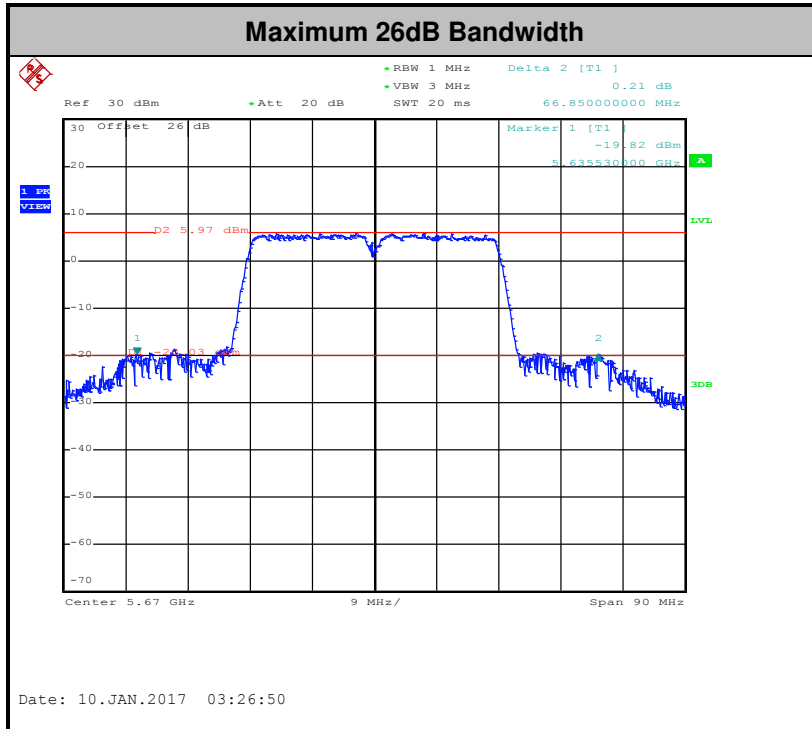



3.2 Maximum Conducted Output Power Measurement

3.2.1 Limit of Maximum Conducted Output Power

<FCC 14-30 CFR 15.407>

For mobile and portable client devices in the 5.15–5.25 GHz band, the maximum conducted output power over the frequency band of operation shall not exceed 250 mW.

For the 5.25–5.725 GHz bands, the maximum conducted output power over the frequency bands of operation shall not exceed the lesser of 250 mW or $11 \text{ dBm} + 10 \log B$, where B is the 26 dB emission bandwidth in megahertz.

For Straddle Channel, U-NII procedures and limits were applied for operations in the frequency band in accordance with FCC KDB 644545 D03.

If transmitting antennas of directional gain greater than 6 dBi are used, the peak output power shall be reduced by the amount in dB that the directional gain of the antenna exceeds 6 dBi.

Note that U-NII-2 band, devices with a maximum e.i.r.p. greater than 500 mW shall implement TPC in order to have the capability to operate at least 6 dB below the maximum permitted e.i.r.p. of 1 W.

3.2.2 Measuring Instruments

The measuring equipment is listed in the section 4 of this test report.

3.2.3 Test Procedures

The testing follows Method PM of FCC KDB 789033 D02 General UNII Test Procedures New Rules v01r03.

Method PM (Measurement using an RF average power meter):

1. Measurement is performed using a wideband RF power meter.
2. The EUT is configured to transmit continuously with a consistent duty cycle at its maximum power control level.
3. Measure the average power of the transmitter, and the average power is corrected with duty factor, $10 \log(1/x)$, where x is the duty cycle.

For straddle channel, the testing follows Method SA-3 (RMS detection with max hold) of FCC KDB 789033 D02 General UNII Test Procedures New Rules v01r03.

Compute power by integrating the spectrum across the 99% occupied bandwidth of the signal using the instrument's band power measurement function.

3.2.4 Test Setup

For normal channel:

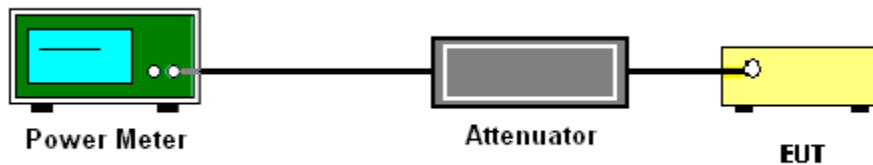

For straddle channel:

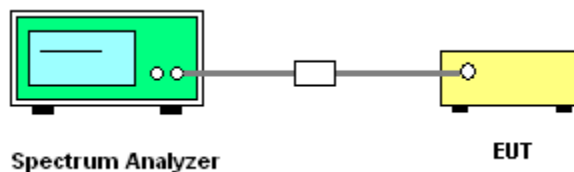



3.2.5 Test Result of Maximum Conducted Output Power

Please refer to Appendix A.

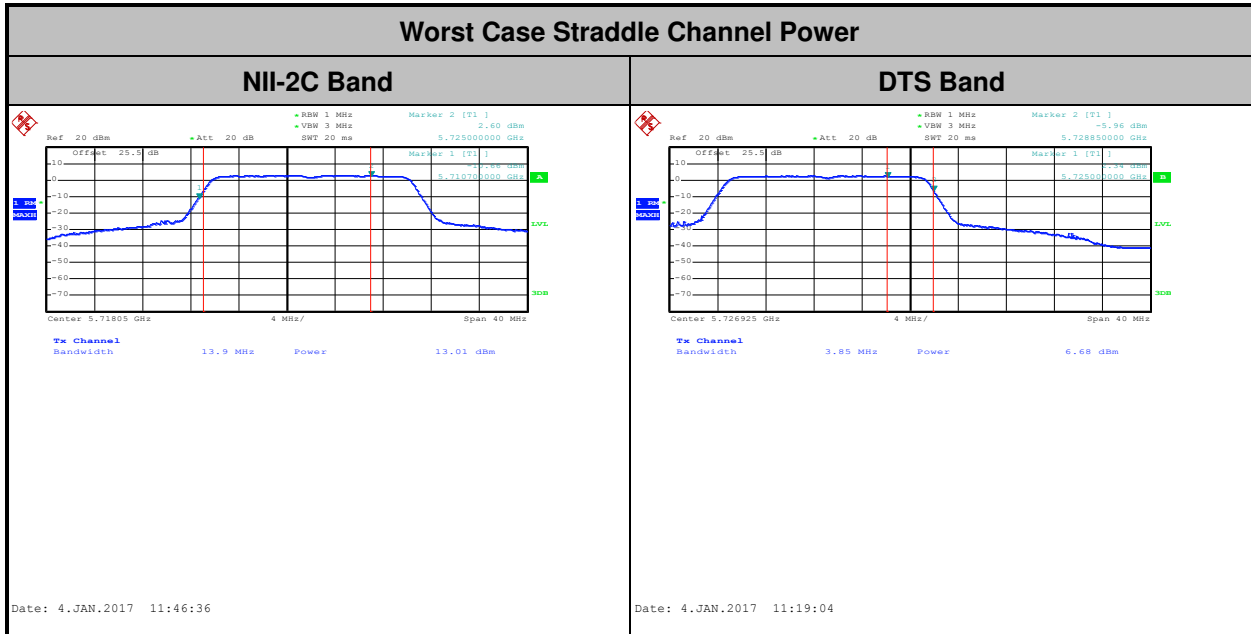



3.3 Power Spectral Density Measurement

3.3.1 Limit of Power Spectral Density

<FCC 14-30 CFR 15.407>

For mobile and portable client devices in the 5.15–5.25 GHz band, the maximum power spectral density shall not exceed 11dBm in any 1 megahertz band.

For the 5.25–5.725 GHz bands, the maximum power spectral density shall not exceed 11 dBm in any 1 megahertz band.

For Straddle Channel, U-NII procedures and limits were applied for operations in the frequency band in accordance with FCC KDB 644545 D03.

If transmitting antennas of directional gain greater than 6 dBi are used, the peak output power shall be reduced by the amount in dB that the directional gain of the antenna exceeds 6 dBi.

3.3.2 Measuring Instruments

The measuring equipment is listed in the section 4 of this test report.

3.3.3 Test Procedures

The testing follows FCC KDB 789033 D02 General UNII Test Procedures New Rules v01r03.
Section F) Maximum power spectral density.

Method SA-2

(trace averaging across on and off times of the EUT transmissions, followed by duty cycle correction).

1. The testing follows Method SA-2 of FCC KDB 789033 D02 General UNII Test Procedures New Rules v01r03.
 - Measure the duty cycle.
 - Set span to encompass the entire emission bandwidth (EBW) of the signal.
 - Set RBW = 1 MHz.
 - Set VBW \geq 3 MHz.
 - Number of points in sweep \geq 2 Span / RBW.
 - Sweep time = auto.
 - Detector = RMS
 - Trace average at least 100 traces in power averaging mode.
 - Add $10 \log(1/x)$, where x is the duty cycle, to the measured power in order to compute the average power during the actual transmission times. For example, add $10 \log(1/0.25) = 6$ dB if the duty cycle is 25 percent.
2. The RF output of EUT was connected to the spectrum analyzer by a low loss cable.
3. Each plot has already offset with cable loss, and attenuator loss. Measure the PPSD and record it.

3.3.4 Test Setup

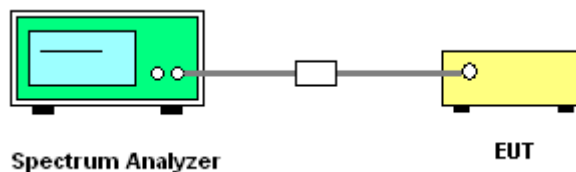

3.3.5 Test Result of Power Spectral Density

Please refer to Appendix A.

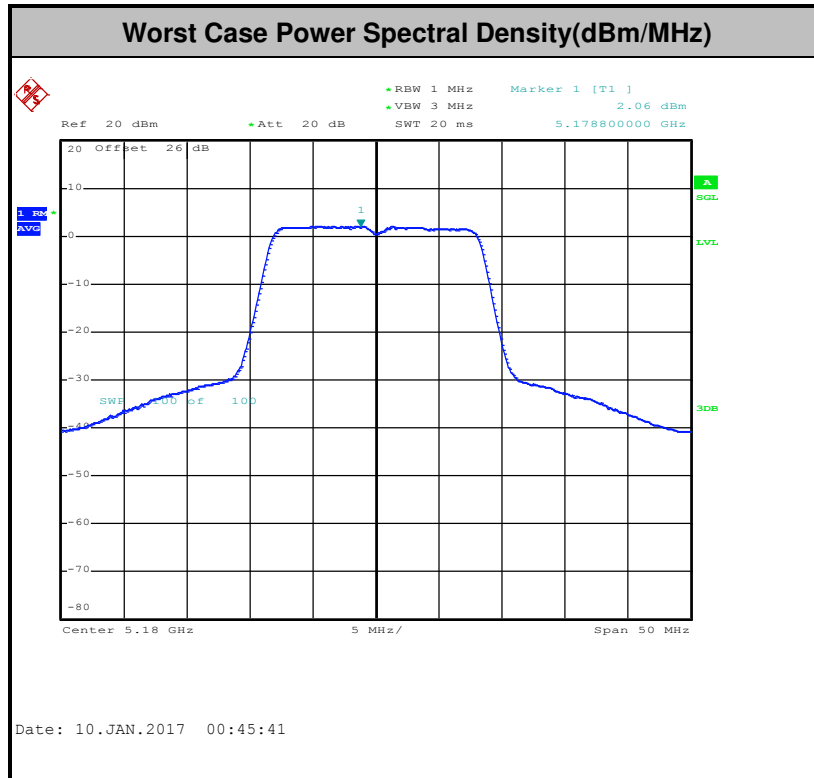

Note: Average Power Density (dB) = Measured value+ Duty Factor

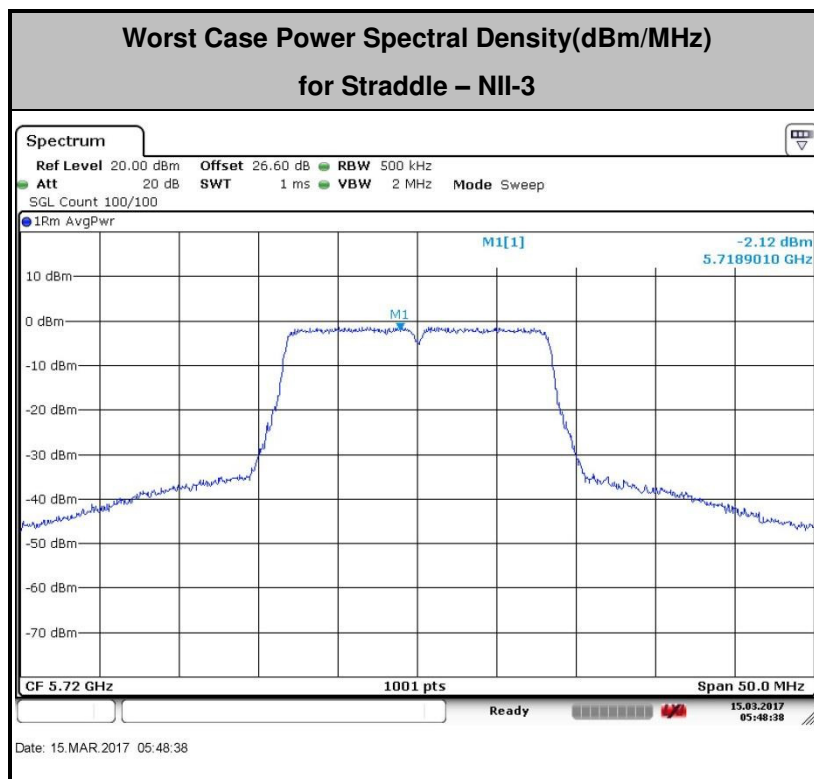
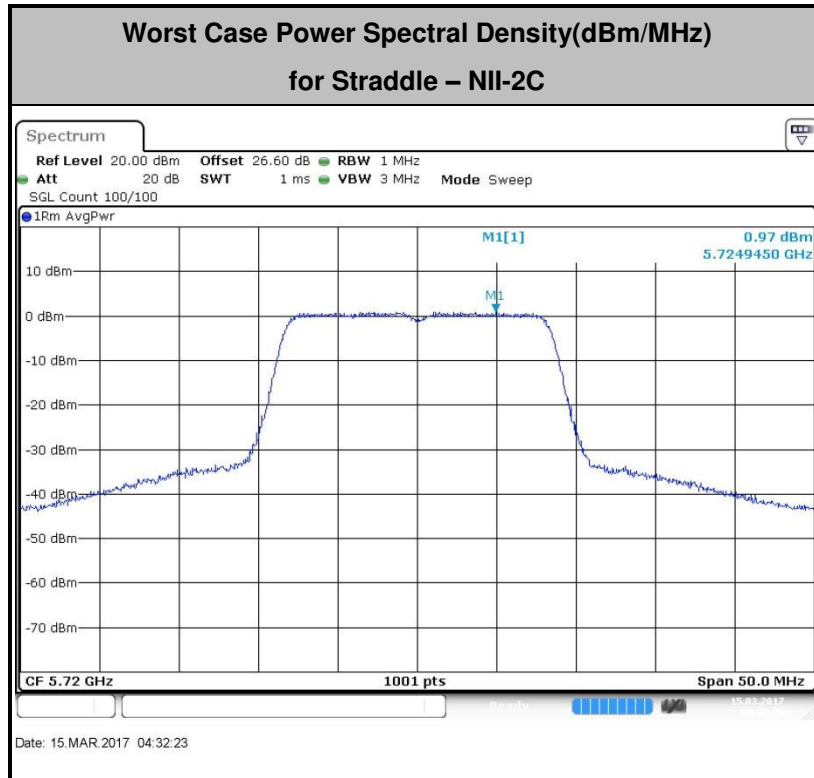



3.4 Unwanted Radiated Emission Measurement

This section as specified in FCC Part 15.407(b) is to measure unwanted emissions through radiated measurement for band edge spurious emissions and out of band emissions measurement. The unwanted emissions shall comply with 15.407(b)(1) to (6), and restricted bands per FCC Part15.205.

3.4.1 Limit of Unwanted Emissions

- (1) For transmitters operating in the 5150-5250 MHz band: all emissions outside of the 5150-5350 MHz band shall not exceed an EIRP of -27dBm/MHz.

For transmitters operating in the 5250-5350 MHz band: all emissions outside of the 5150-5350 MHz band shall not exceed an EIRP of -27 dBm/MHz. Devices operating in the 5250-5350 MHz band that generate emissions in the 5150-5250 MHz band must meet all applicable technical requirements for operation in the 5150-5250 MHz band (including indoor use) or alternatively meet an out-of-band emission EIRP limit of -27 dBm/MHz in the 5150-5250 MHz band.

For transmitters operating in the 5470-5725MHz band: all emissions outside of the 5470-5725MHz band shall not exceed an EIRP of -27 dBm/MHz.

- (2) Unwanted spurious emissions fallen in restricted bands per FCC Part15.205 shall comply with the general field strength limits set forth in § 15.209 as below table,

Frequency (MHz)	Field Strength (microvolts/meter)	Measurement Distance (meters)
0.009 – 0.490	2400/F(kHz)	300
0.490 – 1.705	24000/F(kHz)	30
1.705 – 30.0	30	30
30 – 88	100	3
88 – 216	150	3
216 - 960	200	3
Above 960	500	3

Note: The following formula is used to convert the EIRP to field strength.

$$E = \frac{1000000\sqrt{30P}}{3} \mu V/m, \text{ where } P \text{ is the eirp (Watts)}$$



EIRP (dBm)	Field Strength at 3m (dBμV/m)
-17	78.3
- 27	68.3

(3) KDB789033 D01 v01r03 G)2)c)

- (i) Section 15.407(b)(1-3) specifies the unwanted emissions limit for the U-NII-1 and 2 bands. As specified, emissions above 1000 MHz that are outside of the restricted bands are subject to a peak emission limit of -27 dBm/MHz. However, an out-of-band emission that complies with both the average and peak limits of Section 15.209 is not required to satisfy the -27 dBm/MHz dBm/MHz peak emission limit.
- (ii) Section 15.407(b)(4) specifies the unwanted emissions limit for the U-NII-3 band. A band emissions mask is specified in Section 15.407(b)(4)(i). An alternative to the band emissions mask is specified in Section 15.407(b)(4)(ii). The alternative limits are based on the highest antenna gain specified in the filing. There are also marketing and importation restrictions for the alternative limit

3.4.2 Measuring Instruments

The measuring equipment is listed in the section 4 of this test report.



3.4.3 Test Procedures

1. The testing follows FCC KDB 789033 D02 General UNII Test Procedures New Rules v01r03.
Section G) Unwanted emissions measurement.

(1) Procedure for Unwanted Emissions Measurements Below 1000MHz

- RBW = 120 kHz
- VBW = 300 kHz
- Detector = Peak
- Trace mode = max hold

(2) Procedure for Peak Unwanted Emissions Measurements Above 1000 MHz

- RBW = 1 MHz
- VBW \geq 3 MHz
- Detector = Peak
- Sweep time = auto
- Trace mode = max hold

(3) Procedures for Average Unwanted Emissions Measurements Above 1000MHz

- RBW = 1 MHz
- VBW = 10 Hz, when duty cycle is no less than 98 percent.
- VBW \geq 1/T, when duty cycle is less than 98 percent where T is the minimum transmission duration over which the transmitter is on and is transmitting at its maximum power control level for the tested mode of operation.

2. The EUT was placed on a turntable with 0.8 meter for frequency below 1GHz and 1.5 meter for frequency above 1GHz respectively above ground.
3. The EUT was set 3 meters from the interference receiving antenna which was mounted on the top of a variable height antenna tower.
4. The antenna is a broadband antenna and its height is adjusted between one meter and four meters above ground to find the maximum value of the field strength for both horizontal polarization and vertical polarization of the antenna.
5. For each suspected emission, the EUT was arranged to its worst case and then adjust the antenna tower (from 1 m to 4 m) and turntable (from 0 degree to 360 degrees) to find the maximum reading.
6. For testing below 1GHz, if the emission level of the EUT in peak mode was 3 dB lower than the limit specified, then peak values of EUT will be reported, otherwise, the emissions will be repeated one by one using the CISPR quasi-peak method and reported.
7. For testing above 1GHz, the emission level of the EUT in peak mode was 20dB lower than average limit (that means the emission level in average mode also complies with the limit in average mode), then peak values of EUT will be reported, otherwise, the emissions will be measured in average mode again and reported.

3.4.4 Test Setup

For radiated emissions below 30MHz

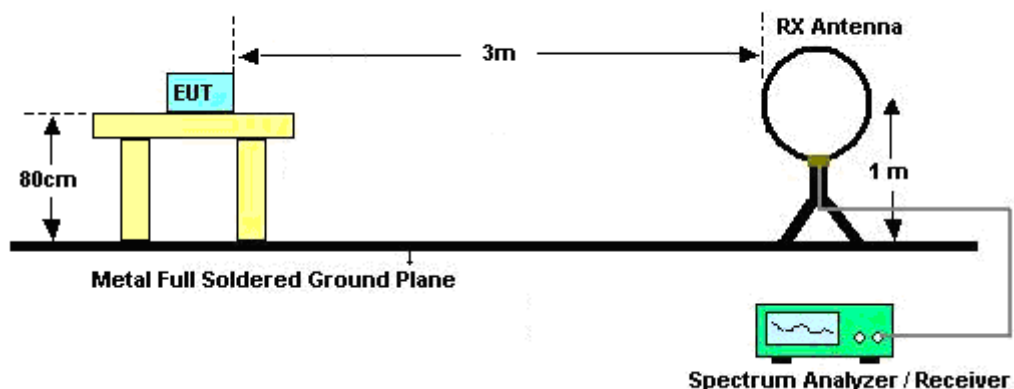

For radiated emissions from 30MHz to 1GHz

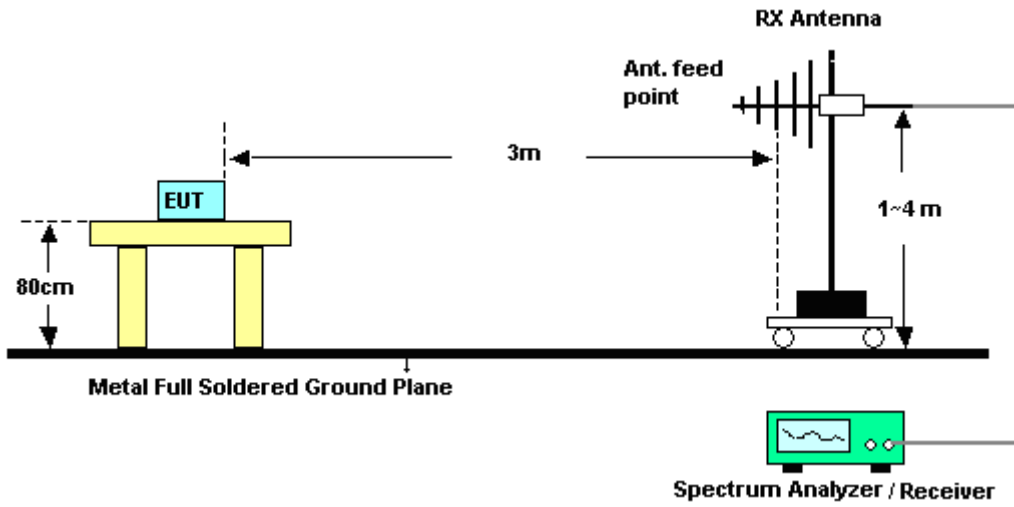

For radiated emissions above 1GHz

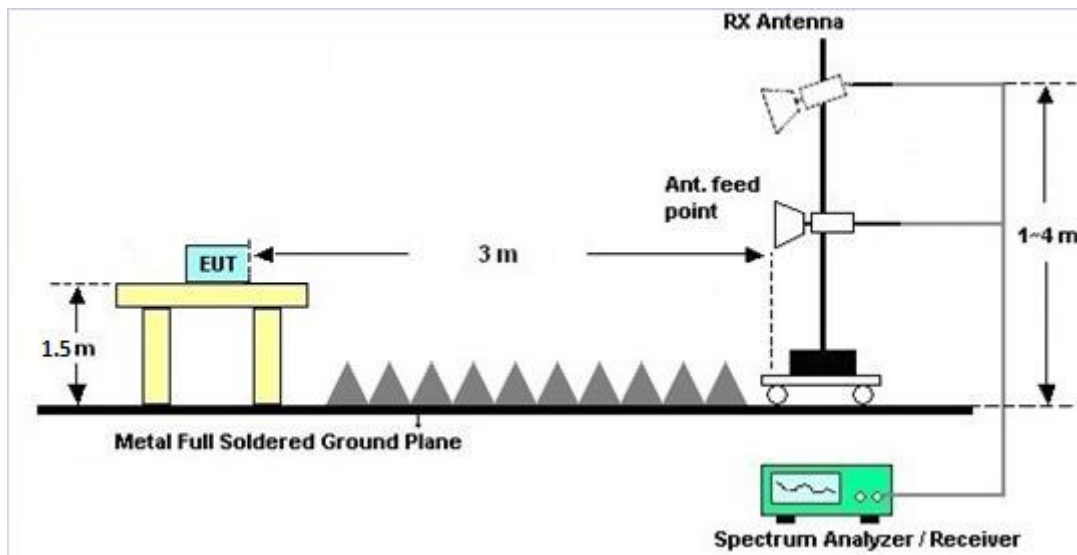



3.4.5 Test Results of Radiated Spurious Emissions (9 kHz ~ 30 MHz)

The low frequency, which started from 9 kHz to 30MHz, was pre-scanned and the result which was 20dB lower than the limit line per 15.31(o) was not reported.

3.4.6 Test Result of Radiated Spurious at Band Edges

Please refer to Appendix B and C.

3.4.7 Duty Cycle

Please refer to Appendix D.

3.4.8 Test Result of Radiated Spurious Emissions (30MHz ~ 10th Harmonic)

Please refer to Appendix B and C.



3.5 AC Conducted Emission Measurement

3.5.1 Limit of AC Conducted Emission

For equipment that is designed to be connected to the public utility (AC) power line, the radio frequency voltage that is conducted back onto the AC power line on any frequency or frequencies within the band 150 kHz to 30 MHz shall not exceed the limits in the following table.

Frequency of emission (MHz)	Conducted limit (dBµV)	
	Quasi-peak	Average
0.15-0.5	66 to 56*	56 to 46*
0.5-5	56	46
5-30	60	50

*Decreases with the logarithm of the frequency.

3.5.2 Measuring Instruments

The measuring equipment is listed in the section 4 of this test report.

3.5.3 Test Procedures

1. The EUT was placed 0.4 meter from the conducting wall of the shielding room was kept at least 80 centimeters from any other grounded conducting surface.
2. Connect EUT to the power mains through a line impedance stabilization network (LISN).
3. All the support units are connecting to the other LISN.
4. The LISN provides 50 ohm coupling impedance for the measuring instrument.
5. The FCC states that a 50 ohm, 50 microhenry LISN should be used.
6. Both sides of AC line were checked for maximum conducted interference.
7. The frequency range from 150 kHz to 30 MHz was searched.
8. Set the test-receiver system to Peak Detect Function and specified bandwidth with Maximum Hold Mode.

3.5.4 Test Setup

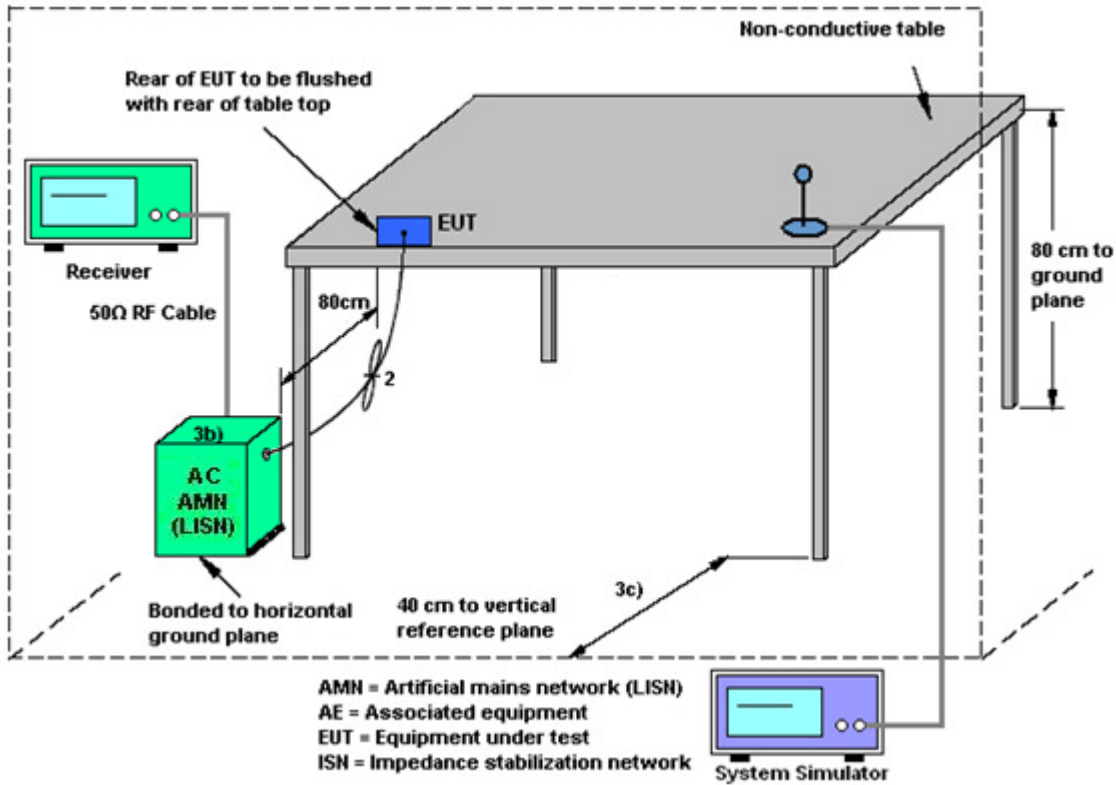



3.5.5 Test Result of AC Conducted Emission

Test Mode :	Mode 1	Temperature :	21~24°C
Test Engineer :	Arthur Hsieh	Relative Humidity :	50~53%
Test Voltage :	120Vac / 60Hz	Phase :	Line
Function Type :	GSM1900 Idle + Bluetooth Link + WLAN (5GHz) Link + MP3 + Earphone + Battery + USB Cable (Charging from Adapter)		

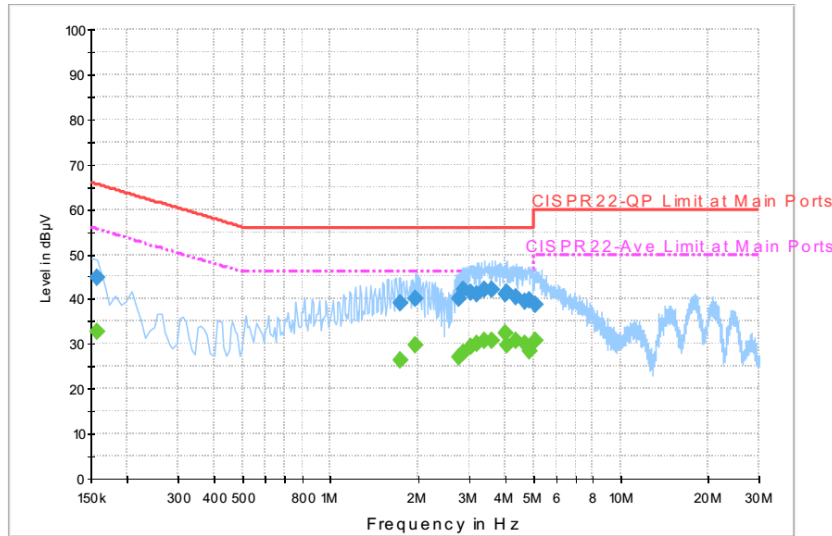

Final Result : QuasiPeak

Frequency (MHz)	QuasiPeak (dBµV)	Filter	Line	Corr. (dB)	Margin (dB)	Limit (dBµV)
0.158000	44.7	Off	L1	19.6	20.9	65.6
1.734000	39.1	Off	L1	19.6	16.9	56.0
1.974000	40.2	Off	L1	19.6	15.8	56.0
2.782000	40.2	Off	L1	19.5	15.8	56.0
2.886000	42.3	Off	L1	19.5	13.7	56.0
3.046000	41.6	Off	L1	19.6	14.4	56.0
3.182000	41.2	Off	L1	19.6	14.8	56.0
3.390000	42.3	Off	L1	19.6	13.7	56.0
3.606000	42.1	Off	L1	19.7	13.9	56.0
3.998000	41.0	Off	L1	19.7	15.0	56.0
4.062000	41.5	Off	L1	19.7	14.5	56.0
4.366000	40.6	Off	L1	19.7	15.4	56.0
4.678000	39.6	Off	L1	19.8	16.4	56.0
4.854000	39.7	Off	L1	19.8	16.3	56.0
5.086000	38.9	Off	L1	19.8	21.1	60.0



Test Mode :	Mode 1	Temperature :	21~24°C
Test Engineer :	Arthur Hsieh	Relative Humidity :	50~53%
Test Voltage :	120Vac / 60Hz	Phase :	Line
Function Type :	GSM1900 Idle + Bluetooth Link + WLAN (5GHz) Link + MP3 + Earphone + Battery + USB Cable (Charging from Adapter)		

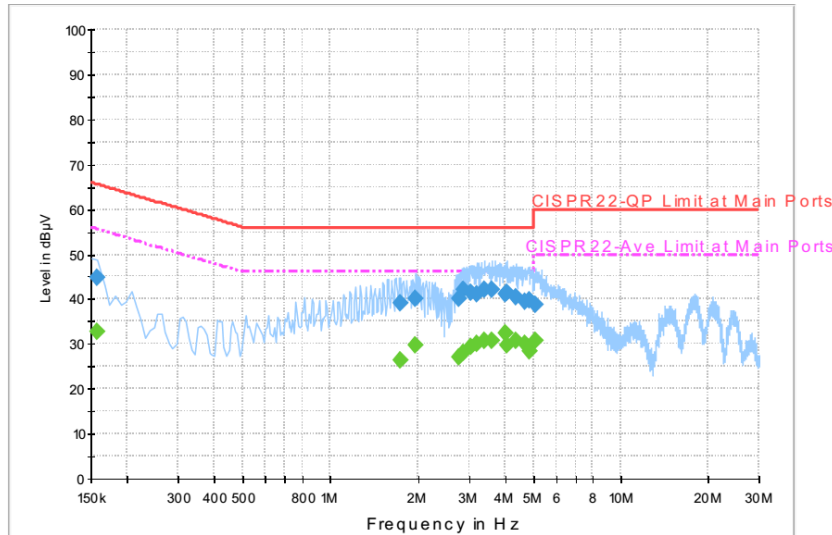

Final Result : Average

Frequency (MHz)	Average (dBµV)	Filter	Line	Corr. (dB)	Margin (dB)	Limit (dBµV)
0.158000	32.9	Off	L1	19.6	22.7	55.6
1.734000	26.6	Off	L1	19.6	19.4	46.0
1.974000	29.7	Off	L1	19.6	16.3	46.0
2.782000	27.1	Off	L1	19.5	18.9	46.0
2.886000	28.1	Off	L1	19.5	17.9	46.0
3.046000	29.4	Off	L1	19.6	16.6	46.0
3.182000	30.3	Off	L1	19.6	15.7	46.0
3.390000	30.6	Off	L1	19.6	15.4	46.0
3.606000	30.7	Off	L1	19.7	15.3	46.0
3.998000	32.5	Off	L1	19.7	13.5	46.0
4.062000	29.7	Off	L1	19.7	16.3	46.0
4.366000	30.8	Off	L1	19.7	15.2	46.0
4.678000	30.1	Off	L1	19.8	15.9	46.0
4.854000	28.4	Off	L1	19.8	17.6	46.0
5.086000	30.8	Off	L1	19.8	19.2	50.0



Test Mode :	Mode 1	Temperature :	21~24°C
Test Engineer :	Arthur Hsieh	Relative Humidity :	50~53%
Test Voltage :	120Vac / 60Hz	Phase :	Neutral
Function Type :	GSM1900 Idle + Bluetooth Link + WLAN (5GHz) Link + MP3 + Earphone + Battery + USB Cable (Charging from Adapter)		

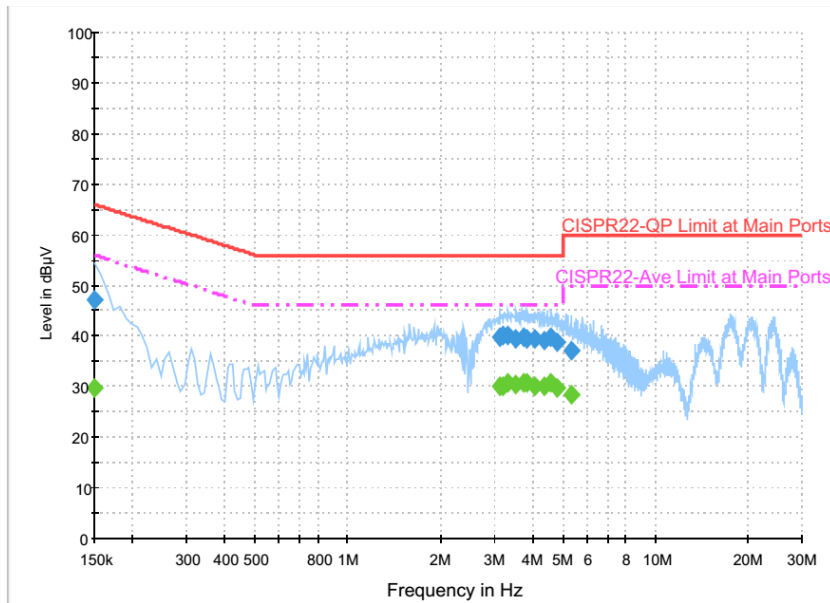

Final Result : QuasiPeak

Frequency (MHz)	QuasiPeak (dBµV)	Filter	Line	Corr. (dB)	Margin (dB)	Limit (dBµV)
0.150000	47.2	Off	N	19.6	18.8	66.0
3.126000	39.8	Off	N	19.6	16.2	56.0
3.190000	40.0	Off	N	19.6	16.0	56.0
3.334000	40.1	Off	N	19.6	15.9	56.0
3.534000	39.5	Off	N	19.6	16.5	56.0
3.742000	39.8	Off	N	19.7	16.2	56.0
3.846000	39.4	Off	N	19.7	16.6	56.0
4.070000	39.5	Off	N	19.7	16.5	56.0
4.342000	39.1	Off	N	19.7	16.9	56.0
4.558000	39.8	Off	N	19.7	16.2	56.0
4.822000	38.8	Off	N	19.7	17.2	56.0
5.350000	37.2	Off	N	19.8	22.8	60.0



Test Mode :	Mode 1	Temperature :	21~24°C
Test Engineer :	Arthur Hsieh	Relative Humidity :	50~53%
Test Voltage :	120Vac / 60Hz	Phase :	Neutral
Function Type :	GSM1900 Idle + Bluetooth Link + WLAN (5GHz) Link + MP3 + Earphone + Battery + USB Cable (Charging from Adapter)		

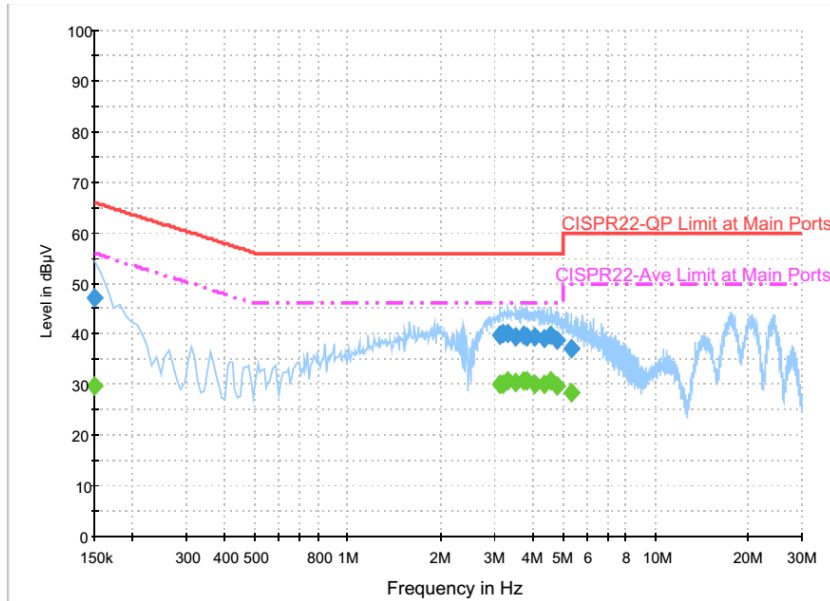

Final Result : Average

Frequency (MHz)	Average (dBµV)	Filter	Line	Corr. (dB)	Margin (dB)	Limit (dBµV)
0.150000	29.7	Off	N	19.6	26.3	56.0
3.126000	30.1	Off	N	19.6	15.9	46.0
3.190000	30.0	Off	N	19.6	16.0	46.0
3.334000	30.7	Off	N	19.6	15.3	46.0
3.534000	30.5	Off	N	19.6	15.5	46.0
3.742000	30.7	Off	N	19.7	15.3	46.0
3.846000	30.8	Off	N	19.7	15.2	46.0
4.070000	30.1	Off	N	19.7	15.9	46.0
4.342000	30.1	Off	N	19.7	15.9	46.0
4.558000	30.6	Off	N	19.7	15.4	46.0
4.822000	29.9	Off	N	19.7	16.1	46.0
5.350000	28.4	Off	N	19.8	21.6	50.0

3.6 Frequency Stability Measurement

3.6.1 Limit of Frequency Stability

Manufacturers of U-NII devices are responsible for ensuring frequency stability such that an emission is maintained within the band of operation under all conditions of normal operation as specified in the user's manual.

3.6.2 Measuring Instruments

The measuring equipment is listed in the section 4 of this test report.

3.6.3 Test Procedures

1. To ensure emission at the band edge is maintained within the authorized band, those values shall be measured by radiation emissions at upper and lower frequency points, and finally compensated by frequency deviation as procedures below.
2. The EUT was operated at the maximum output power, and connected to the spectrum analyzer, which is set to maximum hold function and peak detector. The peak value of the power envelope was measured and noted. The upper and lower frequency points were respectively measured relatively 10dB lower than the measured peak value.
3. The frequency deviation was calculated by adding the upper frequency point and the lower frequency point divided by two. Those detailed values of frequency deviation are provided in table below.

3.6.4 Test Setup

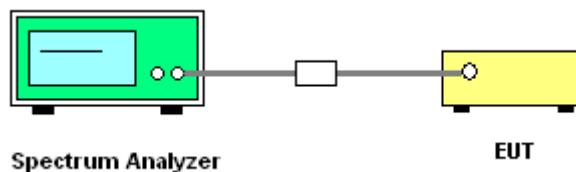

3.6.5 Test Result of Frequency Stability

Please refer to Appendix A.



3.7 Automatically Discontinue Transmission

3.7.1 Limit of Automatically Discontinue Transmission

The device shall automatically discontinue transmission in case of either absence of information to transmit or operational failure. These provisions are not intended to preclude the transmission of control or signaling information or the use of repetitive codes used by certain digital technologies to complete frame or burst intervals. Applicants shall include in their application for equipment authorization to describe how this requirement is met.

3.7.2 Measuring Instruments

The measuring equipment is listed in the section 4 of this test report.

3.7.3 Test Result of Automatically Discontinue Transmission

While the EUT is not transmitting any information, the EUT can automatically discontinue transmission and become standby mode for power saving. The EUT can detect the controlling signal of ACK message transmitting from remote device and verify whether it shall resend or discontinue transmission.



3.8 Antenna Requirements

3.8.1 Standard Applicable

According to FCC 47 CFR Section 15.407(a)(1)(2) ,if transmitting antenna directional gain is greater than 6 dBi, both the peak transmit power and the peak power spectral density shall be reduced by the amount in dB that the directional gain of the antenna exceeds 6 dBi.

3.8.2 Antenna Anti-Replacement Construction

An embedded-in antenna design is used.

3.8.3 Antenna Gain

The antenna gain is less than 6 dBi. Therefore, it is not necessary to reduce maximum peak output power limit.



4 List of Measuring Equipments

Instrument	Manufacturer	Model No.	Serial No.	Characteristics	Calibration Date	Test Date	Due Date	Remark
Spectrum Analyzer	Rohde & Schwarz	FSP40	100055	9kHz-40GHz	Jul. 17, 2016	Jan. 03, 2017 ~ Mar. 15, 2017	Jul. 16, 2017	Conducted (TH05-HY)
Signal Analyzer	Rohde & Schwarz	FSV40	101397	10Hz~40GHz	Nov. 04, 2016	Jan. 03, 2017 ~ Mar. 15, 2017	Nov. 03, 2017	Conducted (TH05-HY)
Power Meter	Anritsu	ML2495A	0932001	300MHz~40GHz	Sep. 29, 2016	Jan. 03, 2017 ~ Mar. 15, 2017	Sep. 28, 2017	Conducted (TH05-HY)
Power Sensor	Anritsu	MA2411B	0846202	300MHz~40GHz	Sep. 29, 2016	Jan. 03, 2017 ~ Mar. 15, 2017	Sep. 28, 2017	Conducted (TH05-HY)
Hygrometer	Testo	608-H2	41410069	N/A	Aug. 28, 2016	Jan. 03, 2017 ~ Mar. 15, 2017	Aug. 27, 2017	Conducted (TH05-HY)
RF Cable	HUBER + SUHNER	SUCOFLEX 104	MY84209521	1GHz~26GHz	Dec. 02, 2016	Jan. 03, 2017 ~ Mar. 15, 2017	Dec. 01, 2017	Conducted (TH05-HY)
Temperature Chamber	ESPEC	SH-641	92013720	-40°C ~90°C	Sep. 01, 2016	Jan. 03, 2017 ~ Mar. 15, 2017	Aug. 31, 2017	Conducted (TH05-HY)
AC Power Source	ChainTek	APC-1000W	N/A	N/A	N/A	Jan. 09, 2017	N/A	Conduction (CO05-HY)
EMI Test Receiver	Rohde & Schwarz	ESCI 7	100724	9kHz~7GHz	Aug. 30, 2016	Jan. 09, 2017	Aug. 29, 2017	Conduction (CO05-HY)
Hygrometer	Testo	608-H1	34913912	N/A	Apr. 19, 2016	Jan. 09, 2017	Apr. 18, 2017	Conduction (CO05-HY)
LISN	Rohde & Schwarz	ENV216	100080	9kHz~30MHz	Nov. 29, 2016	Jan. 09, 2017	Nov. 28, 2017	Conduction (CO05-HY)
LF Cable	HUBER + SUHNER	RG-214/U	LF01	N/A	Jan. 05, 2017	Jan. 09, 2017	Jan. 04, 2018	Conduction (CO05-HY)
Test Software	N/A	EMC32	8.40.0	N/A	N/A	Jan. 09, 2017	N/A	Conduction (CO05-HY)
Loop Antenna	Rohde & Schwarz	HFH2-Z2	100488	9 kHz~30 MHz	Oct. 20, 2016	Jan. 12, 2017 ~ Jan. 16, 2017	Oct. 19, 2018	Radiation (03CH12-HY)
Bilog Antenna	TESEQ	CBL 6111D&00800 N1D01N-06	37059&01	30MHz~1GHz	Oct. 15, 2016	Jan. 12, 2017 ~ Jan. 16, 2017	Oct. 14, 2017	Radiation (03CH12-HY)
Horn Antenna	SCHWARZBECK	BBHA 9120D	9120D-1328	1GHz ~ 18GHz	Oct. 25, 2016	Jan. 12, 2017 ~ Mar. 15, 2017	Oct. 24, 2017	Radiation (03CH12-HY)
SHF-EHF Horn Antenna	SCHWARZBECK	BBHA 9170	BBHA9170576	18GHz ~ 40GHz	Apr. 15, 2016	Jan. 12, 2017 ~ Jan. 16, 2017	Apr. 14, 2017	Radiation (03CH12-HY)
Spectrum Analyzer	Agilent	N9030A	MY52350276	3Hz~44GHz	Mar. 21, 2016	Jan. 12, 2017 ~ Mar. 15, 2017	Mar. 20, 2017	Radiation (03CH12-HY)
Amplifier	SONOMA	310N	187312	9kHz~1GHz	Nov. 10, 2016	Jan. 12, 2017 ~ Jan. 16, 2017	Nov. 09, 2017	Radiation (03CH12-HY)
Preamplifier	MITEQ	TTA0204	1872107	2GHz~40GHz	Feb. 15, 2016	Jan. 12, 2017 ~ Jan. 16, 2017	Feb. 14, 2017	Radiation (03CH12-HY)
Preamplifier	MITEQ	AMF-7D-0010 1800-30-10P	1815698	1GHz~18GHz	Dec. 01, 2016	Jan. 12, 2017 ~ Mar. 15, 2017	Nov. 30, 2017	Radiation (03CH12-HY)
Preamplifier	Keysight	83017A	MY53270195	1GHz~26.5GHz	Aug. 24, 2016	Jan. 12, 2017 ~ Mar. 15, 2017	Aug. 23, 2017	Radiation (03CH12-HY)



Instrument	Manufacturer	Model No.	Serial No.	Characteristics	Calibration Date	Test Date	Due Date	Remark
Hygrometer	TECEP	DTM-303B	TP140349	N/A	Nov. 14, 2016	Jan. 12, 2017 ~ Mar. 15, 2017	Nov. 13, 2017	Radiation (03CH12-HY)
RF Cable	HUBER + SUHNER	SUCOFLEX 104	MY24958/4, MY28653/4, MY9839/4PE	26GHz~40GHz	Jan. 10, 2017	Jan. 12, 2017 ~ Mar. 15, 2017	Jan. 09, 2018	Radiation (03CH12-HY)
RF Cable	HUBER + SUHNER	SUCOFLEX 104	MY24958/4, MY28653/4, MY9839/4PE	1GHz~26GHz	Jan. 10, 2017	Jan. 12, 2017 ~ Mar. 15, 2017	Jan. 09, 2018	Radiation (03CH12-HY)
RF Cable	HUBER + SUHNER	SUCOFLEX 104	MY24958/4, MY28653/4, MY9839/4PE	30MHz~1GHz	Jan. 10, 2017	Jan. 12, 2017 ~ Mar. 15, 2017	Jan. 09, 2018	Radiation (03CH12-HY)
RF Cable	HUBER + SUHNER	SUCOFLEX 104	MY24958/4, MY28653/4, MY9839/4PE	9K~30MHz	Jan. 10, 2017	Jan. 12, 2017 ~ Mar. 15, 2017	Jan. 09, 2018	Radiation (03CH12-HY)
Controller	EMEC	EM1000	N/A	Control Turn table & Ant Mast	N/A	Jan. 12, 2017 ~ Mar. 15, 2017	N/A	Radiation (03CH12-HY)
Antenna Mast	EMEC	AM-BS-4500-B	N/A	1m~4m	N/A	Jan. 12, 2017 ~ Mar. 15, 2017	N/A	Radiation (03CH12-HY)
Turn Table	EMEC	TT2000	N/A	0~360 Degree	N/A	Jan. 12, 2017 ~ Mar. 15, 2017	N/A	Radiation (03CH12-HY)
Test Software	Audix	E3	6.2009-8-24	N/A	N/A	Jan. 12, 2017 ~ Mar. 15, 2017	N/A	Radiation (03CH12-HY)
Filter	Wainwright	WLKS4500-8S S	SN19	4.5G Low Pass	Sep. 19, 2016	Jan. 12, 2017 ~ Mar. 15, 2017	Sep. 18, 2017	Radiation (03CH12-HY)
Filter	Wainwright	WHKX8-5872. 5-6750-18000- 40ST	SN3	6.75 GHz Highpass	Sep. 19, 2016	Jan. 12, 2017 ~ Mar. 15, 2017	Sep. 18, 2017	Radiation (03CH12-HY)



5 Uncertainty of Evaluation

Uncertainty of Conducted Emission Measurement (150kHz ~ 30MHz)

Measuring Uncertainty for a Level of Confidence of 95% ($U = 2Uc(y)$)	2.70
---	------

Uncertainty of Radiated Emission Measurement (30 MHz ~ 1000 MHz)

Measuring Uncertainty for a Level of Confidence of 95% ($U = 2Uc(y)$)	5.10
---	------

Uncertainty of Radiated Emission Measurement (1000 MHz ~ 18000 MHz)

Measuring Uncertainty for a Level of Confidence of 95% ($U = 2Uc(y)$)	5.20
---	------

Uncertainty of Radiated Emission Measurement (18000 MHz ~ 40000 MHz)

Measuring Uncertainty for a Level of Confidence of 95% ($U = 2Uc(y)$)	4.70
---	------

Appendix A. Test Result of Conducted Test Items

Test Engineer:	Aking Chang	Temperature:	21~25	°C
Test Date:	2017/1/3~2017/01/10	Relative Humidity:	51~54	%

TEST RESULTS DATA
26dB and 99% OBW

Band I										
Mod.	Data Rate	NTX	CH.	Freq. (MHz)	99% Bandwidth (MHz)	26 dB Bandwidth (MHz)	IC 99% Bandwidth Power Limit (dBm)	IC 99% Bandwidth EIRP Limit (dBm)		
11a	6Mbps	1	36	5180	18.10	27.35	-	22.58		
11a	6Mbps	1	44	5220	17.65	24.60	-	22.47		
11a	6Mbps	1	48	5240	17.80	30.95	-	22.50		
HT20	MCS0	1	36	5180	18.50	24.30	-	22.67		
HT20	MCS0	1	44	5220	18.50	24.00	-	22.67		
HT20	MCS0	1	48	5240	18.45	24.95	-	22.66		
HT40	MCS0	1	38	5190	36.50	41.22	-	23.01		
HT40	MCS0	1	46	5230	36.60	45.60	-	23.01		

TEST RESULTS DATA
Average Power Table

FCC Band I										
Mod.	Data Rate	NTX	CH.	Freq. (MHz)	Duty Factor (dB)	Average Conducted Power (dBm)	FCC Conducted Power Limit (dBm)	DG (dBi)		Pass/Fail
11a	6Mbps	1	36	5180	0.12	13.92	24.00	-2.20		Pass
11a	6Mbps	1	44	5220	0.12	13.79	24.00	-2.20		Pass
11a	6Mbps	1	48	5240	0.12	13.72	24.00	-2.20		Pass
HT20	MCS0	1	36	5180	0.16	12.88	24.00	-2.20		Pass
HT20	MCS0	1	44	5220	0.16	12.78	24.00	-2.20		Pass
HT20	MCS0	1	48	5240	0.16	12.86	24.00	-2.20		Pass
HT40	MCS0	1	38	5190	0.23	11.03	24.00	-2.20		Pass
HT40	MCS0	1	46	5230	0.23	12.77	24.00	-2.20		Pass

TEST RESULTS DATA
Power Spectral Density

FCC Band I										
Mod.	Data Rate	NTX	CH.	Freq. (MHz)	Duty Factor (dB)	Average Power Density (dBm/MHz)	Average PSD Limit (dBm/MHz)	DG (dBi)	-	Pass/Fail
11a	6Mbps	1	36	5180	0.12	2.18	11.00	-2.20		Pass
11a	6Mbps	1	44	5220	0.12	1.53	11.00	-2.20		Pass
11a	6Mbps	1	48	5240	0.12	1.24	11.00	-2.20		Pass
HT20	MCS0	1	36	5180	0.16	0.74	11.00	-2.20		Pass
HT20	MCS0	1	44	5220	0.16	0.37	11.00	-2.20		Pass
HT20	MCS0	1	48	5240	0.16	0.07	11.00	-2.20		Pass
HT40	MCS0	1	38	5190	0.23	-2.89	11.00	-2.20		Pass
HT40	MCS0	1	46	5230	0.23	-2.46	11.00	-2.20		Pass

TEST RESULTS DATA
26dB and 99% OBW

Band II										
Mod.	Data Rate	NTX	CH.	Freq. (MHz)	99% Bandwidth (MHz)	26 dB Bandwidth (MHz)	IC 99% Bandwidth Power Limit (dBm)	IC 99% Bandwidth EIRP Limit (dBm)	FCC 26dB Bandwidth Power Limit (dBm)	Note
11a	6M bps	1	52	5260	17.70	26.15	23.48	29.48	23.98	
11a	6M bps	1	60	5300	17.80	27.25	23.50	29.50	23.98	
11a	6M bps	1	64	5320	17.60	27.00	23.46	29.46	23.98	
HT20	MCS 0	1	52	5260	18.50	23.75	23.67	29.67	23.98	
HT20	MCS 0	1	60	5300	18.50	29.35	23.67	29.67	23.98	
HT20	MCS 0	1	64	5320	18.55	24.10	23.68	29.68	23.98	
HT40	MCS 0	1	54	5270	36.60	53.88	23.98	30.00	23.98	
HT40	MCS 0	1	62	5310	36.50	41.04	23.98	30.00	23.98	

TEST RESULTS DATA
Average Power Table

FCC Band II										
Mod.	Data Rate	NTX	CH.	Freq. (MHz)	Duty Factor (dB)	Average Conducted Power (dBm)	FCC Conducted Power Limit (dBm)	DG (dBi)	EIRP Power Limit (dBm)	Pass/Fail
11a	6M bps	1	52	5260	0.12	13.86	23.98	-1.60	26.99	Pass
11a	6M bps	1	60	5300	0.12	13.87	23.98	-1.60	26.99	Pass
11a	6M bps	1	64	5320	0.12	13.89	23.98	-1.60	26.99	Pass
HT20	MCS 0	1	52	5260	0.16	12.96	23.98	-1.60	26.99	Pass
HT20	MCS 0	1	60	5300	0.16	12.94	23.98	-1.60	26.99	Pass
HT20	MCS 0	1	64	5320	0.16	12.98	23.98	-1.60	26.99	Pass
HT40	MCS 0	1	54	5270	0.23	12.70	23.98	-1.60	26.99	Pass
HT40	MCS 0	1	62	5310	0.23	9.84	23.98	-1.60	26.99	Pass

TEST RESULTS DATA
Power Spectral Density

Band II										
Mod.	Data Rate	NTX	CH.	Freq. (MHz)	Duty Factor (dB)	Average Power Density (dBm/MHz)	Average PSD Limit (dBm/MHz)	DG (dBi)		Pass/Fail
11a	6M bps	1	52	5260	0.12	1.45	11.00	-1.60		Pass
11a	6M bps	1	60	5300	0.12	1.43	11.00	-1.60		Pass
11a	6M bps	1	64	5320	0.12	1.54	11.00	-1.60		Pass
HT20	MCS 0	1	52	5260	0.16	0.02	11.00	-1.60		Pass
HT20	MCS 0	1	60	5300	0.16	0.87	11.00	-1.60		Pass
HT20	MCS 0	1	64	5320	0.16	0.65	11.00	-1.60		Pass
HT40	MCS 0	1	54	5270	0.23	-3.00	11.00	-1.60		Pass
HT40	MCS 0	1	62	5310	0.23	-4.72	11.00	-1.60		Pass

TEST RESULTS DATA
26dB and 99% OBW

Band III										
Mod.	Data Rate	NTX	CH.	Freq. (MHz)	99% Bandwidth (MHz)	26 dB Bandwidth (MHz)	IC 99% Bandwidth Power Limit (dBm)	IC 99% Bandwidth EIRP Limit (dBm)	FCC 26dB Bandwidth Power Limit (dBm)	Note
11a	6M bps	1	100	5500	17.70	29.60	23.48	29.48	23.98	
11a	6M bps	1	116	5580	17.55	35.95	23.44	29.44	23.98	
11a	6M bps	1	140	5700	17.65	32.60	23.47	29.47	23.98	
HT20	MCS 0	1	100	5500	18.55	24.45	23.68	29.68	23.98	
HT20	MCS 0	1	116	5580	18.55	25.95	23.68	29.68	23.98	
HT20	MCS 0	1	140	5700	18.50	23.80	23.67	29.67	23.98	
HT40	MCS 0	1	102	5510	36.60	41.22	23.98	30.00	23.98	
HT40	MCS 0	1	110	5550	36.60	54.36	23.98	30.00	23.98	
HT40	MCS 0	1	134	5670	36.70	66.85	23.98	30.00	23.98	

TEST RESULTS DATA
Average Power Table

FCC Band III										
Mod.	Data Rate	NTX	CH.	Freq. (MHz)	Duty Factor (dB)	Average Conducted Power (dBm)	FCC Conducted Power Limit (dBm)	DG (dBi)	EIRP Power Limit (dBm)	Pass/Fail
11a	6M bps	1	100	5500	0.12	13.77	23.98	-1.40	26.99	Pass
11a	6M bps	1	116	5580	0.12	13.72	23.98	-1.40	26.99	Pass
11a	6M bps	1	140	5700	0.12	13.69	23.98	-1.40	26.99	Pass
HT20	MCS 0	1	100	5500	0.16	12.74	23.98	-1.40	26.99	Pass
HT20	MCS 0	1	116	5580	0.16	12.61	23.98	-1.40	26.99	Pass
HT20	MCS 0	1	140	5700	0.16	12.62	23.98	-1.40	26.99	Pass
HT40	MCS 0	1	102	5510	0.23	11.91	23.98	-1.40	26.99	Pass
HT40	MCS 0	1	110	5550	0.23	12.84	23.98	-1.40	26.99	Pass
HT40	MCS 0	1	134	5670	0.23	12.83	23.98	-1.40	26.99	Pass

TEST RESULTS DATA
Power Spectral Density

Band III										
Mod.	Data Rate	NTX	CH.	Freq. (MHz)	Duty Factor (dB)	Average Power Density (dBm/MHz)	Average PSD Limit (dBm/MHz)	DG (dBi)		Pass/Fail
11a	6M bps	1	100	5500	0.12	1.83	11.00	-1.40		Pass
11a	6M bps	1	116	5580	0.12	1.86	11.00	-1.40		Pass
11a	6M bps	1	140	5700	0.12	0.82	11.00	-1.40		Pass
HT20	MCS 0	1	100	5500	0.16	0.41	11.00	-1.40		Pass
HT20	MCS 0	1	116	5580	0.16	0.52	11.00	-1.40		Pass
HT20	MCS 0	1	140	5700	0.16	-0.30	11.00	-1.40		Pass
HT40	MCS 0	1	102	5510	0.23	-1.34	11.00	-1.40		Pass
HT40	MCS 0	1	110	5550	0.23	-1.96	11.00	-1.40		Pass
HT40	MCS 0	1	134	5670	0.23	-2.73	11.00	-1.40		Pass

TEST RESULTS DATA
26dB and 99% OBW

Straddle Channel										
Mod.	Data Rate	NTX	CH.	Freq. (MHz)	99% Bandwidth (MHz)	26dB Emission Bandwidth (MHz)	IC 99% Bandwidth Power Limit (dBm)	IC 99% Bandwidth EIRP Limit (dBm)	FCC 26dB Bandwidth Power Limit (dBm)	6dB Emission Bandwidth (MHz)
11a	6Mbps	1	144	5720	17.75	23.85	-	-	-	16.3
				NII-2C	13.9	16.8	22.43	28.43	23.25	13.14
				NII-3	3.85	7.05	30.00	36.02	-	3.16
HT20	MCS0	1	144	5720	18.55	25.65	-	-	-	17.6
				NII-2C	14.3	16.85	22.55	28.55	23.27	13.8
				NII-3	4.25	8.8	30.00	36.02	-	3.8
HT40	MCS0	1	142	5710	36.70	66.24	-	-	-	36.28
				NII-2C	33.3	44.43	23.98	30.00	23.98	33.12
				NII-3	3.4	21.81	30.00	36.02	-	3.16

TEST RESULTS DATA
Average Power Table

FCC Straddle Channel										
Mod.	Data Rate	NTX	CH.	Freq. (MHz)	Duty Factor (dB)	Average Conducted Power (dBm)	FCC Conducted Power Limit (dBm)	DG (dBi)		Pass/Fail
11a	6Mbps	1	144	5720	0.12	13.92	-	-1.40		Pass
				NII-2C	0.12	13.01	23.25	-1.40	Pass	
				NII-3	0.12	6.68	30.00	-1.40	Pass	
HT20	MCS0	1	144	5720	0.16	12.86	-	-1.40		Pass
				NII-2C	0.16	11.87	23.27	-1.40	Pass	
				NII-3	0.16	5.94	30.00	-1.40	Pass	
HT40	MCS0	1	142	5710	0.23	12.89	-	-1.40		Pass
				NII-2C	0.23	12.52	23.98	-1.40	Pass	
				NII-3	0.23	2.06	30.00	-1.40	Pass	

TEST RESULTS DATA
Power Spectral Density

Straddle Channel										
Mod.	Data Rate	NTX	CH.	Freq. (MHz)	Duty Factor (dB)	Average Power Density (dBm/MHz)	Average PSD Limit (dBm/MHz)	DG (dBi)		Pass/Fail
11a	6Mbps	1	144	NII-2C	0.12	1.09	11.00	-1.40		Pass
				NII-3	0.12	-2.00	30.00	-1.40		Pass
HT20	MCS0	1	144	NII-2C	0.16	0.83	11.00	-1.40		Pass
				NII-3	0.16	-2.19	30.00	-1.40		Pass
HT40	MCS0	1	142	NII-2C	0.23	-1.97	11.00	-1.40		Pass
				NII-3	0.23	-5.16	30.00	-1.40		Pass

TEST RESULTS DATA
Frequency Stability

Band I										
Mod.	Data Rate	NTX	CH.	Freq. (MHz)	Center Frequency (MHz)	Frequency Deviation (MHz)	Frequency Stability (ppm)	Temperature (°C)	Voltage (V)	Note
11a	6Mbps	1	36	5180	5180.000	0.000	0.00	50	3.7	
11a	6Mbps	1	36	5180	5180.000	0.000	0.00	-30	3.7	
11a	6Mbps	1	36	5180	5180.000	0.000	0.00	20	4.2	
11a	6Mbps	1	36	5180	5180.000	0.000	0.00	20	3.2	
11a	6Mbps	1	36	5180	5180.000	0.000	0.00	20	3.7	

Band II										
Mod.	Data Rate	NTX	CH.	Freq. (MHz)	Center Frequency (MHz)	Frequency Deviation (MHz)	Frequency Stability (ppm)	Temperature (°C)	Voltage (V)	Note
11a	6Mbps	1	64	5320	5320.000	0.000	0.00	50	3.7	
11a	6Mbps	1	64	5320	5320.000	0.000	0.00	-30	3.7	
11a	6Mbps	1	64	5320	5320.000	0.000	0.00	20	4.2	
11a	6Mbps	1	64	5320	5320.000	0.000	0.00	20	3.2	
11a	6Mbps	1	64	5320	5320.000	0.000	0.00	20	3.7	

Band III										
Mod.	Data Rate	NTX	CH.	Freq. (MHz)	Center Frequency (MHz)	Frequency Deviation (MHz)	Frequency Stability (ppm)	Temperature (°C)	Voltage (V)	Note
11a	6Mbps	1	100	5500	5500.000	0.000	0.00	50	3.7	
11a	6Mbps	1	100	5500	5500.000	0.000	0.00	-30	3.7	
11a	6Mbps	1	100	5500	5500.000	0.000	0.00	20	4.2	
11a	6Mbps	1	100	5500	5500.000	0.000	0.00	20	3.2	
11a	6Mbps	1	100	5500	5500.000	0.000	0.00	20	3.7	



Appendix B. Radiated Spurious Emission

Test Engineer :	Nick Yu, Karl Hou, Peter Liao, and Citta Ke.	Temperature :	21~23°C
		Relative Humidity :	53~55%

Band 1 - 5150~5250MHz

WIFI 802.11a (Band Edge @ 3m)

WIFI Ant. 1	Note	Frequency (MHz)	Level (dBμV/m)	Over Limit (dB)	Limit Line (dBμV/m)	Read Level (dBμV)	Antenna Factor (dB/m)	Cable Loss (dB)	Preamp Factor (dB)	Ant Pos (cm)	Table Pos (deg)	Peak Avg. (P/A)	Pol. (H/V)	
802.11a CH 36 5180MHz		5145.6	60.62	-13.38	74	47.89	32.47	11.21	30.95	100	176	P	H	
		5143.26	49.13	-4.87	54	36.4	32.47	11.21	30.95	100	176	A	H	
	*	5180	106.68	-	-	93.96	32.46	11.21	30.95	100	176	P	H	
	*	5180	95.37	-	-	82.65	32.46	11.21	30.95	100	176	A	H	
													H	
													H	
			5081.12	59.71	-14.29	74	46.91	32.48	11.27	30.95	361	114	P	V
			5137.28	48.47	-5.53	54	35.71	32.47	11.24	30.95	361	114	A	V
	*		5180	104.38	-	-	91.66	32.46	11.21	30.95	361	114	P	V
	*		5180	93.25	-	-	80.53	32.46	11.21	30.95	361	114	A	V
													V	
													V	
802.11a CH 44 5220MHz		5003.9	59.87	-14.13	74	46.98	32.5	11.34	30.95	100	179	P	H	
		5148.72	48.59	-5.41	54	35.86	32.47	11.21	30.95	100	179	A	H	
	*	5220	106.28	-	-	93.59	32.46	11.18	30.95	100	179	P	H	
	*	5220	95.04	-	-	82.35	32.46	11.18	30.95	100	179	A	H	
			5417.04	59.96	-14.04	74	46.89	32.42	11.6	30.95	100	179	P	H
			5436.96	48.57	-5.43	54	35.47	32.41	11.64	30.95	100	179	A	H
			5144.04	59.26	-14.74	74	46.53	32.47	11.21	30.95	357	111	P	V
			5049.66	48.2	-5.8	54	35.35	32.49	11.31	30.95	357	111	A	V
	*		5220	103.48	-	-	90.79	32.46	11.18	30.95	357	111	P	V
	*		5220	92.4	-	-	79.71	32.46	11.18	30.95	357	111	A	V
			5385.36	60.04	-13.96	74	46.97	32.42	11.6	30.95	357	111	P	V
			5438.88	48.68	-5.32	54	35.58	32.41	11.64	30.95	357	111	A	V



802.11a CH 48 5240MHz		5144.82	59.57	-14.43	74	46.84	32.47	11.21	30.95	108	179	P	H
		5148.98	48.41	-5.59	54	35.68	32.47	11.21	30.95	108	179	A	H
	*	5240	107.27	-	-	94.51	32.45	11.26	30.95	108	179	P	H
	*	5240	95.93	-	-	83.17	32.45	11.26	30.95	108	179	A	H
		5442.48	60.2	-13.8	74	47.1	32.41	11.64	30.95	108	179	P	H
		5451.6	48.61	-5.39	54	35.51	32.41	11.64	30.95	108	179	A	H
		5147.42	59.78	-14.22	74	47.05	32.47	11.21	30.95	354	111	P	V
		5014.56	48.29	-5.71	54	35.4	32.5	11.34	30.95	354	111	A	V
	*	5240	103.4	-	-	90.64	32.45	11.26	30.95	354	111	P	V
	*	5240	92.54	-	-	79.78	32.45	11.26	30.95	354	111	A	V
		5376.24	59.58	-14.42	74	46.59	32.42	11.52	30.95	354	111	P	V
		5380.32	48.57	-5.43	54	35.5	32.42	11.6	30.95	354	111	A	V
Remark	1. No other spurious found. 2. All results are PASS against Peak and Average limit line.												



Band 1 5150~5250MHz

WIFI 802.11a (Harmonic @ 3m)

WIFI Ant. 1	Note	Frequency (MHz)	Level (dBμV/m)	Over Limit (dB)	Limit Line (dBμV/m)	Read Level (dBμV)	Antenna Factor (dB/m)	Cable Loss (dB)	Preamp Factor (dB)	Ant Pos (cm)	Table Pos (deg)	Peak Avg. (P/A)	Pol. (H/V)
802.11a CH 36 5180MHz		10360	45.74	-22.46	68.2	46.33	39.75	17.13	57.47	100	0	P	H
		15540	50.19	-23.81	74	47.73	39.38	21.61	58.53	100	0	P	H
													H
													H
		10360	45.7	-22.5	68.2	46.29	39.75	17.13	57.47	100	0	P	V
		15540	59.13	-14.87	74	56.67	39.38	21.61	58.53	123	151	P	V
		15540	42.68	-11.32	54	40.22	39.38	21.61	58.53	123	151	A	V
802.11a CH 44 5220MHz		10440	47.02	-21.18	68.2	47.24	39.89	17.22	57.33	100	0	P	H
		15660	58.56	-15.44	74	56.13	39.02	21.7	58.29	117	139	P	H
		15660	43.19	-10.81	54	40.76	39.02	21.7	58.29	117	139	A	H
													H
		10440	47.51	-20.69	68.2	47.73	39.89	17.22	57.33	100	0	P	V
		15660	61.5	-12.5	74	59.07	39.02	21.7	58.29	120	154	P	V
		15660	45.47	-8.53	54	43.04	39.02	21.7	58.29	120	154	A	V
802.11a CH 48 5240MHz		10480	47.56	-20.64	68.2	47.56	39.96	17.27	57.23	100	0	P	H
		15720	57.89	-16.11	74	55.44	38.84	21.76	58.15	127	139	P	H
		15720	42.67	-11.33	54	40.22	38.84	21.76	58.15	127	139	A	H
													H
		10480	46.83	-21.37	68.2	46.83	39.96	17.27	57.23	100	0	P	V
		15720	60.82	-13.18	74	58.37	38.84	21.76	58.15	112	150	P	V
		15720	45	-9	54	42.55	38.84	21.76	58.15	112	150	A	V
Remark	1. No other spurious found. 2. All results are PASS against Peak and Average limit line.												



Band 1 5150~5250MHz

WIFI 802.11n HT20 (Band Edge @ 3m)

WIFI Ant. 1	Note	Frequency (MHz)	Level (dBμV/m)	Over Limit (dB)	Limit Line (dBμV/m)	Read Level (dBμV)	Antenna Factor (dB/m)	Cable Loss (dB)	Preamp Factor (dB)	Ant Pos (cm)	Table Pos (deg)	Peak Avg. (P/A)	Pol. (H/V)	
802.11n HT20 CH 36 5180MHz		5002.86	59.69	-14.31	74	46.8	32.5	11.34	30.95	100	175	P	H	
		5149.24	48.92	-5.08	54	36.19	32.47	11.21	30.95	100	175	A	H	
	*	5180	106.55	-	-	93.83	32.46	11.21	30.95	100	175	P	H	
	*	5180	94.96	-	-	82.24	32.46	11.21	30.95	100	175	A	H	
													H	
														H
			5046.54	59.99	-14.01	74	47.14	32.49	11.31	30.95	380	107	P	V
			5143	48.33	-5.67	54	35.6	32.47	11.21	30.95	380	107	A	V
		*	5180	103.47	-	-	90.75	32.46	11.21	30.95	380	107	P	V
		*	5180	91.85	-	-	79.13	32.46	11.21	30.95	380	107	A	V
													V	
													V	
802.11n HT20 CH 44 5220MHz		5000.26	59.82	-14.18	74	46.93	32.5	11.34	30.95	100	182	P	H	
		5142.48	48.44	-5.56	54	35.71	32.47	11.21	30.95	100	182	A	H	
		*	5220	105.97	-	-	93.28	32.46	11.18	30.95	100	182	P	H
		*	5220	94.47	-	-	81.78	32.46	11.18	30.95	100	182	A	H
			5368.32	60.07	-13.93	74	47.07	32.43	11.52	30.95	100	182	P	H
			5386.8	48.62	-5.38	54	35.55	32.42	11.6	30.95	100	182	A	H
			5148.46	60.06	-13.94	74	47.33	32.47	11.21	30.95	337	111	P	V
			5005.46	48.42	-5.58	54	35.53	32.5	11.34	30.95	337	111	A	V
		*	5220	103.65	-	-	90.96	32.46	11.18	30.95	337	111	P	V
		*	5220	91.89	-	-	79.2	32.46	11.18	30.95	337	111	A	V
		5412.24	60	-14	74	46.93	32.42	11.6	30.95	337	111	P	V	
		5356.32	48.57	-5.43	54	35.57	32.43	11.52	30.95	337	111	A	V	



802.11n HT20 CH 48 5240MHz		5135.98	59.69	-14.31	74	46.93	32.47	11.24	30.95	105	182	P	H
		5133.38	48.32	-5.68	54	35.56	32.47	11.24	30.95	105	182	A	H
	*	5240	106.44	-	-	93.68	32.45	11.26	30.95	105	182	P	H
	*	5240	94.99	-	-	82.23	32.45	11.26	30.95	105	182	A	H
		5375.04	59.75	-14.25	74	46.76	32.42	11.52	30.95	105	182	P	H
		5448.48	48.57	-5.43	54	35.47	32.41	11.64	30.95	105	182	A	H
		5044.72	59.51	-14.49	74	46.66	32.49	11.31	30.95	373	113	P	V
		5024.7	48.27	-5.73	54	35.41	32.5	11.31	30.95	373	113	A	V
	*	5240	103.02	-	-	90.26	32.45	11.26	30.95	373	113	P	V
	*	5240	91.58	-	-	78.82	32.45	11.26	30.95	373	113	A	V
		5409.12	60.18	-13.82	74	47.11	32.42	11.6	30.95	373	113	P	V
		5435.76	48.61	-5.39	54	35.51	32.41	11.64	30.95	373	113	A	V
Remark	1. No other spurious found. 2. All results are PASS against Peak and Average limit line.												



Band 1 5150~5250MHz

WIFI 802.11n HT20 (Harmonic @ 3m)

WIFI Ant. 1	Note	Frequency (MHz)	Level (dBμV/m)	Over Limit (dB)	Limit Line (dBμV/m)	Read Level (dBμV)	Antenna Factor (dB/m)	Cable Loss (dB)	Preamp Factor (dB)	Ant Pos (cm)	Table Pos (deg)	Peak Avg. (P/A)	Pol. (H/V)	
802.11n HT20 CH 36	5180MHz	10360	45.94	-22.26	68.2	46.53	39.75	17.13	57.47	100	0	P	H	
		15540	49.31	-24.69	74	46.85	39.38	21.61	58.53	100	0	P	H	
														H
														H
802.11n HT20 CH 44	5220MHz	10360	46.46	-21.74	68.2	47.05	39.75	17.13	57.47	100	0	P	V	
		15540	59.21	-14.79	74	56.75	39.38	21.61	58.53	151	19	P	V	
		15540	43.33	-10.67	54	40.87	39.38	21.61	58.53	151	19	A	V	
														V
802.11n HT20 CH 48	5240MHz	10440	47.82	-20.38	68.2	48.04	39.89	17.22	57.33	100	0	P	H	
		15660	56.91	-17.09	74	54.48	39.02	21.7	58.29	400	249	P	H	
		15660	40.86	-13.14	54	38.43	39.02	21.7	58.29	400	249	A	H	
														H
802.11n HT20 CH 48	5240MHz	10440	47.55	-20.65	68.2	47.77	39.89	17.22	57.33	100	0	P	V	
		15660	62.03	-11.97	74	59.6	39.02	21.7	58.29	144	20	P	V	
		15660	45.33	-8.67	54	42.9	39.02	21.7	58.29	144	20	A	V	
														V
802.11n HT20 CH 48	5240MHz	10480	46.72	-21.48	68.2	46.72	39.96	17.27	57.23	100	0	P	H	
		15720	57.7	-16.3	74	55.25	38.84	21.76	58.15	125	139	P	H	
		15720	42.22	-11.78	54	39.77	38.84	21.76	58.15	125	139	A	H	
														H
802.11n HT20 CH 48	5240MHz	10480	46.46	-21.74	68.2	46.46	39.96	17.27	57.23	100	0	P	V	
		15720	60.79	-13.21	74	58.34	38.84	21.76	58.15	133	20	P	V	
		15720	44.99	-9.01	54	42.54	38.84	21.76	58.15	133	20	A	V	
														V
Remark	1. No other spurious found. 2. All results are PASS against Peak and Average limit line.													



Band 1 5150~5250MHz

WIFI 802.11n HT40 (Band Edge @ 3m)

WIFI Ant. 1	Note	Frequency (MHz)	Level (dBμV/m)	Over Limit (dB)	Limit Line (dBμV/m)	Read Level (dBμV)	Antenna Factor (dB/m)	Cable Loss (dB)	Preamp Factor (dB)	Ant Pos (cm)	Table Pos (deg)	Peak Avg. (P/A)	Pol. (H/V)
802.11n HT40 CH 38 5190MHz		5149.76	63.88	-10.12	74	51.15	32.47	11.21	30.95	109	184	P	H
		5148.98	50.33	-3.67	54	37.6	32.47	11.21	30.95	109	184	A	H
	*	5190	102.21	-	-	89.52	32.46	11.18	30.95	109	184	P	H
	*	5190	91.38	-	-	78.69	32.46	11.18	30.95	109	184	A	H
		5361.16	59.99	-14.01	74	46.99	32.43	11.52	30.95	109	184	P	H
		5384.12	49.35	-4.65	54	36.28	32.42	11.6	30.95	109	184	A	H
		5119.34	60.13	-13.87	74	47.36	32.48	11.24	30.95	380	105	P	V
		5144.82	49.35	-4.65	54	36.62	32.47	11.21	30.95	380	105	A	V
	*	5190	99.17	-	-	86.48	32.46	11.18	30.95	380	105	P	V
	*	5190	88	-	-	75.31	32.46	11.18	30.95	380	105	A	V
		5386.36	59.69	-14.31	74	46.62	32.42	11.6	30.95	380	105	P	V
		5430.04	49.47	-4.53	54	36.37	32.41	11.64	30.95	380	105	A	V
	802.11n HT40 CH 46 5230MHz		5128.18	59.82	-14.18	74	47.06	32.47	11.24	30.95	107	183	P
		5057.98	49.08	-4.92	54	36.23	32.49	11.31	30.95	107	183	A	H
*		5230	102.16	-	-	89.4	32.45	11.26	30.95	107	183	P	H
*		5230	92.35	-	-	79.59	32.45	11.26	30.95	107	183	A	H
		5374.32	59.89	-14.11	74	46.89	32.43	11.52	30.95	107	183	P	H
		5374.08	49.51	-4.49	54	36.51	32.43	11.52	30.95	107	183	A	H
		5024.96	59.46	-14.54	74	46.6	32.5	11.31	30.95	400	107	P	V
		5143.78	49.09	-4.91	54	36.36	32.47	11.21	30.95	400	107	A	V
*		5230	98.41	-	-	85.65	32.45	11.26	30.95	400	107	P	V
*		5230	88.36	-	-	75.6	32.45	11.26	30.95	400	107	A	V
	5358.24	60.6	-13.4	74	47.6	32.43	11.52	30.95	400	107	P	V	
	5418.24	49.41	-4.59	54	36.34	32.42	11.6	30.95	400	107	A	V	
Remark	1. No other spurious found. 2. All results are PASS against Peak and Average limit line.												



Band 1 5150~5250MHz

WIFI 802.11n HT40 (Harmonic @ 3m)

WIFI Ant. 1	Note	Frequency (MHz)	Level (dBμV/m)	Over Limit (dB)	Limit Line (dBμV/m)	Read Level (dBμV)	Antenna Factor (dB/m)	Cable Loss (dB)	Preamp Factor (dB)	Ant Pos (cm)	Table Pos (deg)	Peak Avg. (P/A)	Pol. (H/V)
802.11n HT40 CH 38 5190MHz		10380	46.52	-21.68	68.2	47.04	39.78	17.13	57.43	100	0	P	H
		15570	46.4	-27.6	74	43.93	39.29	21.64	58.46	100	0	P	H
													H
													H
		10380	46.36	-21.84	68.2	46.88	39.78	17.13	57.43	100	0	P	V
		15570	46.93	-27.07	74	44.46	39.29	21.64	58.46	100	0	P	V
													V
802.11n HT40 CH 46 5230MHz		10460	46.73	-21.47	68.2	46.88	39.93	17.22	57.3	100	0	P	H
		15696	50.81	-23.19	74	48.39	38.91	21.73	58.22	100	0	P	H
													H
													H
		10460	47.21	-20.99	68.2	47.36	39.93	17.22	57.3	100	0	P	V
		15690	57.95	-16.05	74	55.51	38.93	21.73	58.22	125	20	P	V
		15690	43.62	-10.38	54	41.18	38.93	21.73	58.22	125	20	A	V
												V	
Remark	1. No other spurious found. 2. All results are PASS against Peak and Average limit line.												



Band 2 - 5250~5350MHz

WIFI 802.11a (Band Edge @ 3m)

WIFI	Note	Frequency	Level	Over	Limit	Read	Antenna	Cable	Preamp	Ant	Table	Peak	Pol.
Ant.				Limit	Line	Level	Factor	Loss	Factor	Pos	Pos	Avg.	
1		(MHz)	(dBμV/m)	(dB)	(dBμV/m)	(dBμV)	(dB/m)	(dB)	(dB)	(cm)	(deg)	(P/A)	(H/V)
802.11a CH 52 5260MHz		5042.64	59.37	-14.63	74	46.52	32.49	11.31	30.95	118	177	P	H
		5043.42	48.3	-5.7	54	35.45	32.49	11.31	30.95	118	177	A	H
	*	5260	106.68	-	-	93.92	32.45	11.26	30.95	118	177	P	H
	*	5260	95.68	-	-	82.92	32.45	11.26	30.95	118	177	A	H
		5427.36	61.17	-12.83	74	48.07	32.41	11.64	30.95	118	177	P	H
		5372.64	48.73	-5.27	54	35.73	32.43	11.52	30.95	118	177	A	H
		5139.36	59.82	-14.18	74	47.06	32.47	11.24	30.95	373	104	P	V
		5006.76	48.32	-5.68	54	35.43	32.5	11.34	30.95	373	104	A	V
	*	5260	104.01	-	-	91.25	32.45	11.26	30.95	373	104	P	V
	*	5260	93.07	-	-	80.31	32.45	11.26	30.95	373	104	A	V
		5359.92	60.36	-13.64	74	47.36	32.43	11.52	30.95	373	104	P	V
		5413.44	48.59	-5.41	54	35.52	32.42	11.6	30.95	373	104	A	V
802.11a CH 60 5300MHz		5008.05	60.05	-13.95	74	47.16	32.5	11.34	30.95	100	181	P	H
		5014.7	48.38	-5.62	54	35.49	32.5	11.34	30.95	100	181	A	H
	*	5300	106.68	-	-	93.84	32.44	11.35	30.95	100	181	P	H
	*	5300	95.46	-	-	82.62	32.44	11.35	30.95	100	181	A	H
		5414.64	59.88	-14.12	74	46.81	32.42	11.6	30.95	100	181	P	H
		5363.28	48.95	-5.05	54	35.95	32.43	11.52	30.95	100	181	A	H
		5082.25	59.67	-14.33	74	46.87	32.48	11.27	30.95	329	109	P	V
		5147.35	48.2	-5.8	54	35.47	32.47	11.21	30.95	329	109	A	V
	*	5300	104.02	-	-	91.18	32.44	11.35	30.95	329	109	P	V
	*	5300	93.13	-	-	80.29	32.44	11.35	30.95	329	109	A	V
		5452.08	60.24	-13.76	74	47.14	32.41	11.64	30.95	329	109	P	V
		5411.04	48.77	-5.23	54	35.7	32.42	11.6	30.95	329	109	A	V



802.11a CH 64 5320MHz	*	5320	106.39	-	-	93.47	32.44	11.43	30.95	100	178	P	H
	*	5320	95.25	-	-	82.33	32.44	11.43	30.95	100	178	A	H
		5366.56	61.54	-12.46	74	48.54	32.43	11.52	30.95	100	178	P	H
		5351.04	49.39	-4.61	54	36.39	32.43	11.52	30.95	100	178	A	H
													H
													H
	*	5320	104.2	-	-	91.28	32.44	11.43	30.95	365	110	P	V
	*	5320	93.19	-	-	80.27	32.44	11.43	30.95	365	110	A	V
		5363.04	60.42	-13.58	74	47.42	32.43	11.52	30.95	365	110	P	V
		5364.48	48.76	-5.24	54	35.76	32.43	11.52	30.95	365	110	A	V
													V
													V
Remark	1. No other spurious found. 2. All results are PASS against Peak and Average limit line.												



Band 2 5250~5350MHz

WIFI 802.11a (Harmonic @ 3m)

WIFI Ant. 1	Note	Frequency (MHz)	Level (dBμV/m)	Over Limit (dB)	Limit Line (dBμV/m)	Read Level (dBμV)	Antenna Factor (dB/m)	Cable Loss (dB)	Preamp Factor (dB)	Ant Pos (cm)	Table Pos (deg)	Peak Avg. (P/A)	Pol. (H/V)
802.11a CH 52 5260MHz		10520	46.31	-21.89	68.2	46.19	40.01	17.31	57.2	100	0	P	H
		15780	59.71	-14.29	74	57.31	38.66	21.79	58.05	121	137	P	H
		15780	44.53	-9.47	54	42.13	38.66	21.79	58.05	121	137	A	H
													H
		10520	46.31	-21.89	68.2	46.19	40.01	17.31	57.2	100	0	P	V
		15780	61.96	-12.04	74	59.56	38.66	21.79	58.05	119	153	P	V
		15780	46.91	-7.09	54	44.51	38.66	21.79	58.05	119	153	A	V
802.11a CH 60 5300MHz		10600	47.25	-26.75	74	46.99	40.04	17.4	57.18	100	0	P	H
		15900	61.01	-12.99	74	58.64	38.3	21.88	57.81	123	138	P	H
		15900	44.47	-9.53	54	42.1	38.3	21.88	57.81	123	138	A	H
													H
		10600	47.83	-26.17	74	47.57	40.04	17.4	57.18	100	0	P	V
		15900	62.03	-11.97	74	59.66	38.3	21.88	57.81	125	152	P	V
		15900	46.95	-7.05	54	44.58	38.3	21.88	57.81	125	152	A	V
802.11a CH 64 5320MHz		10640	47.7	-26.3	74	47.36	40.06	17.45	57.17	100	0	P	H
		15960	60.04	-13.96	74	57.65	38.12	21.94	57.67	116	137	P	H
		15960	44.5	-9.5	54	42.11	38.12	21.94	57.67	116	137	A	H
													H
		10640	47.88	-26.12	74	47.54	40.06	17.45	57.17	100	0	P	V
		15960	61.87	-12.13	74	59.48	38.12	21.94	57.67	129	152	P	V
		15960	46.86	-7.14	54	44.47	38.12	21.94	57.67	129	152	A	V
Remark	1. No other spurious found. 2. All results are PASS against Peak and Average limit line.												



Band 2 5250~5350MHz

WIFI 802.11n HT20 (Band Edge @ 3m)

WIFI Ant. 1	Note	Frequency (MHz)	Level (dBμV/m)	Over Limit (dB)	Limit Line (dBμV/m)	Read Level (dBμV)	Antenna Factor (dB/m)	Cable Loss (dB)	Preamp Factor (dB)	Ant Pos (cm)	Table Pos (deg)	Peak Avg. (P/A)	Pol. (H/V)
802.11n HT20 CH 52 5260MHz		5145.86	59.66	-14.34	74	46.93	32.47	11.21	30.95	118	185	P	H
		5043.16	48.3	-5.7	54	35.45	32.49	11.31	30.95	118	185	A	H
	*	5260	106.04	-	-	93.28	32.45	11.26	30.95	118	185	P	H
	*	5260	94.88	-	-	82.12	32.45	11.26	30.95	118	185	A	H
		5424.24	60.38	-13.62	74	47.27	32.42	11.64	30.95	118	185	P	H
		5395.2	48.58	-5.42	54	35.51	32.42	11.6	30.95	118	185	A	H
		5139.62	59.62	-14.38	74	46.86	32.47	11.24	30.95	374	105	P	V
		5027.82	48.31	-5.69	54	35.46	32.49	11.31	30.95	374	105	A	V
	*	5260	103.76	-	-	91	32.45	11.26	30.95	374	105	P	V
	*	5260	92.39	-	-	79.63	32.45	11.26	30.95	374	105	A	V
		5408.64	60.4	-13.6	74	47.33	32.42	11.6	30.95	374	105	P	V
		5436.96	48.55	-5.45	54	35.45	32.41	11.64	30.95	374	105	A	V
802.11n HT20 CH 60 5300MHz		5021.76	59.52	-14.48	74	46.66	32.5	11.31	30.95	101	183	P	H
		5058.48	48.26	-5.74	54	35.41	32.49	11.31	30.95	101	183	A	H
	*	5300	106.16	-	-	93.32	32.44	11.35	30.95	101	183	P	H
	*	5300	94.5	-	-	81.66	32.44	11.35	30.95	101	183	A	H
		5359.92	60.39	-13.61	74	47.39	32.43	11.52	30.95	101	183	P	H
		5355.12	48.85	-5.15	54	35.85	32.43	11.52	30.95	101	183	A	H
		5039.44	59.81	-14.19	74	46.96	32.49	11.31	30.95	367	103	P	V
		5122.06	48.31	-5.69	54	35.54	32.48	11.24	30.95	367	103	A	V
	*	5300	103.03	-	-	90.19	32.44	11.35	30.95	367	103	P	V
	*	5300	91.8	-	-	78.96	32.44	11.35	30.95	367	103	A	V
	5459.52	60.18	-13.82	74	47.08	32.41	11.64	30.95	367	103	P	V	
	5435.52	48.55	-5.45	54	35.45	32.41	11.64	30.95	367	103	A	V	



802.11n HT20 CH 64 5320MHz	*	5320	105.31	-	-	92.39	32.44	11.43	30.95	101	191	P	H
	*	5320	94.03	-	-	81.11	32.44	11.43	30.95	101	191	A	H
		5364	60.22	-13.78	74	47.22	32.43	11.52	30.95	101	191	P	H
		5351.04	49.06	-4.94	54	36.06	32.43	11.52	30.95	101	191	A	H
													H
													H
	*	5320	103.38	-	-	90.46	32.44	11.43	30.95	383	106	P	V
	*	5320	91.88	-	-	78.96	32.44	11.43	30.95	383	106	A	V
		5455.52	59.71	-14.29	74	46.61	32.41	11.64	30.95	383	106	P	V
		5362.72	48.91	-5.09	54	35.91	32.43	11.52	30.95	383	106	A	V
													V
													V
Remark	1. No other spurious found. 2. All results are PASS against Peak and Average limit line.												



Band 2 5250~5350MHz

WIFI 802.11n HT20 (Harmonic @ 3m)

WIFI Ant. 1	Note	Frequency (MHz)	Level (dBμV/m)	Over Limit (dB)	Limit Line (dBμV/m)	Read Level (dBμV)	Antenna Factor (dB/m)	Cable Loss (dB)	Preamp Factor (dB)	Ant Pos (cm)	Table Pos (deg)	Peak Avg. (P/A)	Pol. (H/V)
802.11n HT20 CH 52 5260MHz		10520	46.31	-21.89	68.2	46.19	40.01	17.31	57.2	100	0	P	H
		15780	57.71	-16.29	74	55.31	38.66	21.79	58.05	126	140	P	H
		15780	41.5	-12.5	54	39.1	38.66	21.79	58.05	126	140	A	H
													H
		10520	46.12	-22.08	68.2	46	40.01	17.31	57.2	100	0	P	V
		15780	60.75	-13.25	74	58.35	38.66	21.79	58.05	142	19	P	V
		15780	44.21	-9.79	54	41.81	38.66	21.79	58.05	142	19	A	V
													V
802.11n HT20 CH 60 5300MHz		10600	47.58	-26.42	74	47.32	40.04	17.4	57.18	100	0	P	H
		15900	57.98	-16.02	74	55.61	38.3	21.88	57.81	128	139	P	H
		15900	42.39	-11.61	54	40.02	38.3	21.88	57.81	128	139	A	H
													H
		10600	46.66	-27.34	74	46.4	40.04	17.4	57.18	100	0	P	V
		15900	60.76	-13.24	74	58.39	38.3	21.88	57.81	131	21	P	V
		15900	44.76	-9.24	54	42.39	38.3	21.88	57.81	131	21	A	V
													V
802.11n HT20 CH 64 5320MHz		10640	47.08	-26.92	74	46.74	40.06	17.45	57.17	100	0	P	H
		15960	58.45	-15.55	74	56.06	38.12	21.94	57.67	133	137	P	H
		15960	42.67	-11.33	54	40.28	38.12	21.94	57.67	133	137	A	H
													H
		10640	47.75	-26.25	74	47.41	40.06	17.45	57.17	100	0	P	V
		15960	60.8	-13.2	74	58.41	38.12	21.94	57.67	139	19	P	V
		15960	45.14	-8.86	54	42.75	38.12	21.94	57.67	139	19	A	V
													V
Remark	1. No other spurious found. 2. All results are PASS against Peak and Average limit line.												



Band 2 5250~5350MHz

WIFI 802.11n HT40 (Band Edge @ 3m)

WIFI Ant. 1	Note	Frequency (MHz)	Level (dBμV/m)	Over Limit (dB)	Limit Line (dBμV/m)	Read Level (dBμV)	Antenna Factor (dB/m)	Cable Loss (dB)	Preamp Factor (dB)	Ant Pos (cm)	Table Pos (deg)	Peak Avg. (P/A)	Pol. (H/V)
802.11n HT40 CH 54 5270MHz		5088.14	59.22	-14.78	74	46.42	32.48	11.27	30.95	100	181	P	H
		5120.12	49.16	-4.84	54	36.39	32.48	11.24	30.95	100	181	A	H
	*	5270	102.05	-	-	89.2	32.45	11.35	30.95	100	181	P	H
	*	5270	90.91	-	-	78.06	32.45	11.35	30.95	100	181	A	H
		5400.72	59.99	-14.01	74	46.92	32.42	11.6	30.95	100	181	P	H
		5429.76	49.26	-4.74	54	36.16	32.41	11.64	30.95	100	181	A	H
		5072.8	59.34	-14.66	74	46.53	32.49	11.27	30.95	350	111	P	V
		5119.08	48.97	-5.03	54	36.2	32.48	11.24	30.95	350	111	A	V
	*	5270	98.08	-	-	85.23	32.45	11.35	30.95	350	111	P	V
	*	5270	88.07	-	-	75.22	32.45	11.35	30.95	350	111	A	V
		5408.16	60.85	-13.15	74	47.78	32.42	11.6	30.95	350	111	P	V
		5429.28	49.34	-4.66	54	36.24	32.41	11.64	30.95	350	111	A	V
802.11n HT40 CH 62 5310MHz		5088.4	60.61	-13.39	74	47.81	32.48	11.27	30.95	100	200	P	H
		5013.6	49.43	-4.57	54	36.54	32.5	11.34	30.95	100	200	A	H
	*	5310	98.02	-	-	85.1	32.44	11.43	30.95	100	200	P	H
	*	5310	88.28	-	-	75.36	32.44	11.43	30.95	100	200	A	H
		5351.76	61.98	-12.02	74	48.98	32.43	11.52	30.95	100	200	P	H
		5350.08	50.59	-3.41	54	37.59	32.43	11.52	30.95	100	200	A	H
		5005.78	59.98	-14.02	74	47.09	32.5	11.34	30.95	382	107	P	V
		5025.5	49.28	-4.72	54	36.43	32.49	11.31	30.95	382	107	A	V
	*	5310	95.24	-	-	82.32	32.44	11.43	30.95	382	107	P	V
	*	5310	85.52	-	-	72.6	32.44	11.43	30.95	382	107	A	V
	5350.56	60.68	-13.32	74	47.68	32.43	11.52	30.95	382	107	P	V	
	5350.08	50.14	-3.86	54	37.14	32.43	11.52	30.95	382	107	A	V	
Remark	1. No other spurious found. 2. All results are PASS against Peak and Average limit line.												



Band 2 5250~5350MHz

WIFI 802.11n HT40 (Harmonic @ 3m)

WIFI Ant. 1	Note	Frequency (MHz)	Level (dBμV/m)	Over Limit (dB)	Limit Line (dBμV/m)	Read Level (dBμV)	Antenna Factor (dB/m)	Cable Loss (dB)	Preamp Factor (dB)	Ant Pos (cm)	Table Pos (deg)	Peak Avg. (P/A)	Pol. (H/V)
802.11n HT40 CH 54		10540	46.5	-21.7	68.2	46.36	40.02	17.31	57.19	100	0	P	H
		15810	49.8	-24.2	74	47.39	38.57	21.82	57.98	100	0	P	H
													H
													H
5270MHz		10540	46.13	-22.07	68.2	45.99	40.02	17.31	57.19	100	0	P	V
		15810	56.93	-17.07	74	54.52	38.57	21.82	57.98	140	21	P	V
		15810	42.91	-11.09	54	40.5	38.57	21.82	57.98	140	21	A	V
													V
802.11n HT40 CH 62		10620	47.11	-26.89	74	46.84	40.05	17.4	57.18	100	0	P	H
		15930	46.69	-27.31	74	44.31	38.21	21.91	57.74	100	0	P	H
													H
													H
5310MHz		10620	47.44	-26.56	74	47.17	40.05	17.4	57.18	100	0	P	V
		15930	47.72	-26.28	74	45.34	38.21	21.91	57.74	100	0	P	V
													V
													V
Remark	1. No other spurious found. 2. All results are PASS against Peak and Average limit line.												



Band 3 - 5470~5725MHz

WIFI 802.11a (Band Edge @ 3m)

WIFI	Note	Frequency	Level	Over	Limit	Read	Antenna	Cable	Preamp	Ant	Table	Peak	Pol.	
Ant.				Limit	Line	Level	Factor	Loss	Factor	Pos	Pos	Avg.		
1		(MHz)	(dBμV/m)	(dB)	(dBμV/m)	(dBμV)	(dB/m)	(dB)	(dB)	(cm)	(deg)	(P/A)	(H/V)	
802.11a CH 100 5500MHz		5439.12	59.87	-14.13	74	46.77	32.41	11.64	30.95	100	197	P	H	
		5469.52	60.02	-8.18	68.2	46.89	32.41	11.67	30.95	100	197	P	H	
		5443.92	49.09	-4.91	54	35.99	32.41	11.64	30.95	100	197	P	H	
	*	5500	105.8	-	-	92.68	32.4	11.67	30.95	100	197	P	H	
	*	5500	94.62	-	-	81.5	32.4	11.67	30.95	100	197	A	H	
														H
			5390	60.47	-13.53	74	47.4	32.42	11.6	30.95	341	109	P	V
			5465.52	59.85	-8.35	68.2	46.72	32.41	11.67	30.95	341	109	P	V
			5390.16	48.73	-5.27	54	35.66	32.42	11.6	30.95	341	109	P	V
	*		55001	103.14	-	-	90.02	32.4	11.67	30.95	341	109	P	V
	*		5500	91.72	-	-	78.6	32.4	11.67	30.95	341	109	A	V
														V
802.11a CH 116 5580MHz		5407.36	60.07	-13.93	74	47	32.42	11.6	30.95	100	196	P	H	
		5460.4	59.9	-8.3	68.2	46.77	32.41	11.67	30.95	100	196	P	H	
		5455.36	48.71	-5.29	54	35.61	32.41	11.64	30.95	100	196	P	H	
	*	5580	106.57	-	-	93.19	32.62	11.74	30.98	100	196	P	H	
	*	5580	95.87	-	-	82.49	32.62	11.74	30.98	100	196	A	H	
			5760.905	60.36	-7.84	68.2	46.41	33.13	11.86	31.04	100	196	P	H
			5458.48	60.31	-13.69	74	47.21	32.41	11.64	30.95	351	109	P	V
			5465.92	60.18	-8.02	68.2	47.05	32.41	11.67	30.95	351	109	P	V
			5444.08	48.48	-5.52	54	35.38	32.41	11.64	30.95	351	109	P	V
	*		5580	103.6	-	-	90.22	32.62	11.74	30.98	351	109	P	V
	*		5580	92.56	-	-	79.18	32.62	11.74	30.98	351	109	A	V
			5748.62	60.63	-7.57	68.2	46.7	33.1	11.86	31.03	351	109	P	V



802.11a CH 140 5700MHz	*	5700	107.86	-	-	94.09	32.96	11.82	31.01	100	192	P	H
	*	5700	96.34	-	-	82.57	32.96	11.82	31.01	100	192	A	H
		5731.32	61.99	-6.21	68.2	48.13	33.05	11.84	31.03	100	192	P	H
													H
													H
													H
	*	5700	104.38	-	-	90.61	32.96	11.82	31.01	322	99	P	V
	*	5700	93.09	-	-	79.32	32.96	11.82	31.01	322	99	A	V
		5732.2	61.39	-6.81	68.2	47.53	33.05	11.84	31.03	322	99	P	V
													V
													V
													V
Remark	1. No other spurious found. 2. All results are PASS against Peak and Average limit line.												



Band 3 - 5470~5725MHz

WIFI 802.11a (Harmonic @ 3m)

WIFI Ant. 1	Note	Frequency (MHz)	Level (dBµV/m)	Over Limit (dB)	Limit Line (dBµV/m)	Read Level (dBµV)	Antenna Factor (dB/m)	Cable Loss (dB)	Preamp Factor (dB)	Ant Pos (cm)	Table Pos (deg)	Peak Avg. (P/A)	Pol. (H/V)
802.11a CH 100 5500MHz		11000	49.47	-24.53	74	48.51	40.2	17.86	57.1	100	0	P	H
		16500	52.07	-16.13	68.2	46.15	39.5	22.42	56	100	0	P	H
													H
													H
		11000	48.85	-25.15	74	47.89	40.2	17.86	57.1	100	0	P	V
		16500	55.4	-12.8	68.2	49.48	39.5	22.42	56	100	0	P	V
													V
													V
802.11a CH 116 5580MHz		11160	47.49	-26.51	74	46.58	40.2	18.04	57.33	100	0	P	H
		16740	53.05	-15.15	68.2	46.13	40.41	22.65	56.14	100	0	P	H
													H
													H
		11160	47.69	-26.31	74	46.78	40.2	18.04	57.33	100	0	P	V
		16740	57.51	-10.69	68.2	50.59	40.41	22.65	56.14	100	0	P	V
													V
													V
802.11a CH 140 5700MHz		11400	45.95	-28.05	74	45.1	40.2	18.31	57.66	100	0	P	H
		17100	58.74	-9.46	68.2	50.79	41.62	22.99	56.66	100	0	P	H
													H
													H
		11400	45.57	-28.43	74	44.72	40.2	18.31	57.66	100	0	P	V
		17100	59.67	-8.53	68.2	51.72	41.62	22.99	56.66	100	0	P	V
													V
													V
Remark	1. No other spurious found. 2. All results are PASS against Peak and Average limit line.												



Band 3 - 5470~5725MHz

WIFI 802.11n HT20 (Band Edge @ 3m)

WIFI Ant. 1	Note	Frequency (MHz)	Level (dBμV/m)	Over Limit (dB)	Limit Line (dBμV/m)	Read Level (dBμV)	Antenna Factor (dB/m)	Cable Loss (dB)	Preamp Factor (dB)	Ant Pos (cm)	Table Pos (deg)	Peak Avg. (P/A)	Pol. (H/V)	
802.11n HT20 CH 100 5500MHz		5448.24	60.29	-13.71	74	47.19	32.41	11.64	30.95	100	196	P	H	
		5463.44	59.98	-8.22	68.2	46.85	32.41	11.67	30.95	100	196	P	H	
		5453.04	49.05	-4.95	54	35.95	32.41	11.64	30.95	100	196	P	H	
	*	5500	105.04	-	-	91.92	32.4	11.67	30.95	100	196	P	H	
	*	5500	93.54	-	-	80.42	32.4	11.67	30.95	100	196	A	H	
														H
			5434	60.34	-13.66	74	47.24	32.41	11.64	30.95	341	101	P	V
			5466	59.32	-8.88	68.2	46.19	32.41	11.67	30.95	341	101	P	V
			5431.28	48.85	-5.15	54	35.75	32.41	11.64	30.95	341	101	A	V
	*		5500	103.05	-	-	89.93	32.4	11.67	30.95	341	101	P	V
	*		5500	91.15	-	-	78.03	32.4	11.67	30.95	341	101	A	V
														V
802.11n HT20 CH 116 5580MHz		5442.4	60.61	-13.39	74	47.51	32.41	11.64	30.95	100	197	P	H	
		5465.68	59.65	-8.55	68.2	46.52	32.41	11.67	30.95	100	197	P	H	
		5455.36	48.69	-5.31	54	35.59	32.41	11.64	30.95	100	197	A	H	
	*	5580	105.79	-	-	92.41	32.62	11.74	30.98	100	197	P	H	
	*	5580	94.64	-	-	81.26	32.62	11.74	30.98	100	197	A	H	
			5761.22	60.36	-7.84	68.2	46.41	33.13	11.86	31.04	100	197	P	H
			5416.24	60.89	-13.11	74	47.82	32.42	11.6	30.95	300	110	P	V
			5469.76	58.77	-9.43	68.2	45.64	32.41	11.67	30.95	300	110	P	V
			5435.44	48.45	-5.55	54	35.35	32.41	11.64	30.95	300	110	P	V
	*		5580	102.14	-	-	88.76	32.62	11.74	30.98	300	110	P	V
	*		5580	91.09	-	-	77.71	32.62	11.74	30.98	300	110	A	V
			5737.28	59.81	-8.39	68.2	45.94	33.06	11.84	31.03	300	110	P	V



802.11n HT20 CH 140 5700MHz	*	5700	105.45	-	-	91.68	32.96	11.82	31.01	109	190	P	H
	*	5700	95.57	-	-	81.8	32.96	11.82	31.01	109	190	A	H
		5725.08	62.19	-6.01	68.2	48.34	33.03	11.84	31.02	109	190	P	H
													H
													H
													H
	*	5700	103.38	-	-	89.61	32.96	11.82	31.01	321	103	P	V
	*	5700	91.95	-	-	78.18	32.96	11.82	31.01	321	103	A	V
		5725.16	61.79	-6.41	68.2	47.94	33.03	11.84	31.02	321	103	P	V
													V
													V
													V
Remark	1. No other spurious found. 2. All results are PASS against Peak and Average limit line.												



Band 3 - 5470~5725MHz

WIFI 802.11n HT20 (Harmonic @ 3m)

WIFI Ant. 1	Note	Frequency (MHz)	Level (dBμV/m)	Over Limit (dB)	Limit Line (dBμV/m)	Read Level (dBμV)	Antenna Factor (dB/m)	Cable Loss (dB)	Preamp Factor (dB)	Ant Pos (cm)	Table Pos (deg)	Peak Avg. (P/A)	Pol. (H/V)
802.11n HT20 CH 100 5500MHz		11000	47.26	-26.74	74	46.3	40.2	17.86	57.1	100	0	P	H
		16500	49.45	-18.75	68.2	43.53	39.5	22.42	56	100	0	P	H
													H
													H
		11000	48.2	-25.8	74	47.24	40.2	17.86	57.1	100	0	P	V
		16500	52.04	-16.16	68.2	46.12	39.5	22.42	56	100	0	P	V
													V
802.11n HT20 CH 116 5580MHz		11160	46.95	-27.05	74	46.04	40.2	18.04	57.33	100	0	P	H
		16740	50.79	-17.41	68.2	43.87	40.41	22.65	56.14	100	0	P	H
													H
													H
		11160	46.58	-27.42	74	45.67	40.2	18.04	57.33	100	0	P	V
		16740	54.24	-13.96	68.2	47.32	40.41	22.65	56.14	100	0	P	V
													V
802.11n HT20 CH 140 5700MHz		11400	46.35	-27.65	74	45.5	40.2	18.31	57.66	100	0	P	H
		17100	57.02	-11.18	68.2	49.07	41.62	22.99	56.66	100	0	P	H
													H
													H
		11400	45.53	-28.47	74	44.68	40.2	18.31	57.66	100	0	P	V
		17100	58.82	-9.38	68.2	50.87	41.62	22.99	56.66	100	0	P	V
													V
Remark	1. No other spurious found.												
	2. All results are PASS against Peak and Average limit line.												



Band 3 - 5470~5725MHz

WIFI 802.11n HT40 (Band Edge @ 3m)

WIFI Ant. 1	Note	Frequency (MHz)	Level (dBμV/m)	Over Limit (dB)	Limit Line (dBμV/m)	Read Level (dBμV)	Antenna Factor (dB/m)	Cable Loss (dB)	Preamp Factor (dB)	Ant Pos (cm)	Table Pos (deg)	Peak Avg. (P/A)	Pol. (H/V)
802.11n HT40 CH 102 5510MHz		5456.56	60.18	-13.82	74	47.08	32.41	11.64	30.95	100	194	P	H
		5468.8	64.52	-3.68	68.2	51.39	32.41	11.67	30.95	100	194	P	H
		5459.2	50.25	-3.75	54	37.15	32.41	11.64	30.95	100	194	A	H
	*	5510	99.68	-	-	86.51	32.43	11.7	30.96	100	194	P	H
	*	5510	90	-	-	76.83	32.43	11.7	30.96	100	194	A	H
		5740.745	60.66	-7.54	68.2	46.76	33.07	11.86	31.03	100	194	P	H
		5445.76	60.08	-13.92	74	46.98	32.41	11.64	30.95	400	95	P	V
		5470	63.62	-4.58	68.2	50.49	32.41	11.67	30.95	400	95	P	V
		5453.44	49.49	-4.51	54	36.39	32.41	11.64	30.95	400	95	A	V
	*	5510	97.3	-	-	84.13	32.43	11.7	30.96	400	95	P	V
	*	5510	87.83	-	-	74.66	32.43	11.7	30.96	400	95	A	V
		5749.25	62.2	-6	68.2	48.27	33.1	11.86	31.03	400	95	P	V
802.11n HT40 CH 110 5550MHz		5433.52	59.81	-14.19	74	46.71	32.41	11.64	30.95	100	196	P	H
		5468.32	59.52	-8.68	68.2	46.39	32.41	11.67	30.95	100	196	P	H
		5411.2	49.54	-4.46	54	36.47	32.42	11.6	30.95	100	196	A	H
	*	5550	101.45	-	-	88.14	32.54	11.74	30.97	100	196	P	H
	*	5550	91.79	-	-	78.48	32.54	11.74	30.97	100	196	A	H
		5762.165	60.27	-7.93	68.2	46.32	33.13	11.86	31.04	100	196	P	H
		5379.52	59.99	-14.01	74	47	32.42	11.52	30.95	373	94	P	V
		5468.08	59.65	-8.55	68.2	46.52	32.41	11.67	30.95	373	94	P	V
		5376.16	49.27	-4.73	54	36.28	32.42	11.52	30.95	373	94	A	V
	*	5550	98.27	-	-	84.96	32.54	11.74	30.97	373	94	P	V
	*	5550	88.86	-	-	75.55	32.54	11.74	30.97	373	94	A	V
		5756.81	59.47	-8.73	68.2	45.53	33.12	11.86	31.04	373	94	P	V



802.11n HT40 CH 134 5670MHz		5382.9	60.51	-13.49	74	47.44	32.42	11.6	30.95	100	192	P	H
		5469	58.52	-9.68	68.2	45.39	32.41	11.67	30.95	100	192	P	H
		5382.2	49.47	-4.53	54	36.4	32.42	11.6	30.95	100	192	A	H
	*	5670	102.32	-	-	88.63	32.88	11.82	31.01	100	192	P	H
	*	5670	92.13	-	-	78.44	32.88	11.82	31.01	100	192	A	H
		5758.35	61.16	-7.04	68.2	47.22	33.12	11.86	31.04	100	192	P	H
		5409.5	59.91	-14.09	74	46.84	32.42	11.6	30.95	323	93	P	V
		5469.35	58.64	-9.56	68.2	45.51	32.41	11.67	30.95	323	93	P	V
		5412.65	49.18	-4.82	54	36.11	32.42	11.6	30.95	323	93	A	V
	*	5670	99.54	-	-	85.85	32.88	11.82	31.01	323	93	P	V
	*	5670	89.52	-	-	75.83	32.88	11.82	31.01	323	93	A	V
		5760.625	61.11	-7.09	68.2	47.16	33.13	11.86	31.04	323	93	P	V
Remark	1. No other spurious found. 2. All results are PASS against Peak and Average limit line.												



Band 3 - 5470~5725MHz

WIFI 802.11n HT40 (Harmonic @ 3m)

WIFI Ant. 1	Note	Frequency (MHz)	Level (dBμV/m)	Over Limit (dB)	Limit Line (dBμV/m)	Read Level (dBμV)	Antenna Factor (dB/m)	Cable Loss (dB)	Preamp Factor (dB)	Ant Pos (cm)	Table Pos (deg)	Peak Avg. (P/A)	Pol. (H/V)
802.11n HT40 CH 102 5510MHz		11020	46.65	-27.35	74	45.71	40.2	17.86	57.12	100	0	P	H
		16530	46.25	-21.95	68.2	40.2	39.61	22.46	56.02	100	0	P	H
													H
													H
		11020	47.22	-26.78	74	46.28	40.2	17.86	57.12	100	0	P	V
		16530	46.56	-21.64	68.2	40.51	39.61	22.46	56.02	100	0	P	V
													V
802.11n HT40 CH 110 5550MHz		11100	47.73	-26.27	74	46.82	40.2	17.95	57.24	100	0	P	H
		16650	47.38	-20.82	68.2	40.83	40.07	22.57	56.09	100	0	P	H
													H
													H
		11100	47.12	-26.88	74	46.21	40.2	17.95	57.24	100	0	P	V
		16650	51.12	-17.08	68.2	44.57	40.07	22.57	56.09	100	0	P	V
													V
802.11n HT40 CH 134 5670MHz		11340	45.53	-28.47	74	44.68	40.2	18.22	57.57	100	0	P	H
		17010	53.99	-14.21	68.2	46.02	41.42	22.91	56.36	100	0	P	H
													H
													H
		11340	47.7	-26.3	74	46.85	40.2	18.22	57.57	100	0	P	V
		17010	54.38	-13.82	68.2	46.41	41.42	22.91	56.36	100	0	P	V
													V
Remark	1. No other spurious found.												
	2. All results are PASS against Peak and Average limit line.												



Emission below 1GHz

WIFI 802.11n HT20 (LF @ 3m)

WIFI	Note	Frequency	Level	Over	Limit	Read	Antenna	Cable	Preamp	Ant	Table	Peak	Pol.	
Ant.				Limit	Line	Level	Factor	Loss	Factor	Pos	Pos	Avg.		
1		(MHz)	(dBμV/m)	(dB)	(dBμV/m)	(dBμV)	(dB/m)	(dB)	(dB)	(cm)	(deg)	(P/A)	(H/V)	
802.11n HT20 LF		47.82	25.04	-14.96	40	40.52	16.2	0.78	32.46	-	-	P	H	
		100.47	27.23	-16.27	43.5	42.12	16.11	1.43	32.43	-	-	P	H	
		148.8	37.94	-5.56	43.5	51.06	17.55	1.75	32.42	100	0	P	H	
		341.3	30.02	-15.98	46	39.13	20.74	2.44	32.29	-	-	P	H	
		746.6	31.15	-14.85	46	31.96	27.53	3.97	32.31	-	-	P	H	
		968.5	33.21	-20.79	54	29.36	30.07	4.75	30.97	-	-	P	H	
														H
														H
														H
														H
														H
														H
			44.31	34.65	-5.35	40	48.83	17.5	0.78	32.46	100	0	P	V
			91.29	28.16	-15.34	43.5	44.62	14.92	1.06	32.44	-	-	P	V
			149.34	29.13	-14.37	43.5	42.27	17.53	1.75	32.42	-	-	P	V
			747.3	37.88	-8.12	46	38.69	27.53	3.97	32.31	-	-	P	V
			898.5	35.58	-10.42	46	33.82	28.89	4.45	31.58	-	-	P	V
			930.7	33.6	-12.4	46	30.52	29.78	4.6	31.3	-	-	P	V
														V
														V
													V	
													V	
													V	
													V	
Remark	1. No other spurious found. 2. All results are PASS against limit line.													



Emission below 1GHz

WIFI 802.11n HT40 (LF @ 3m)

WIFI	Note	Frequency	Level	Over	Limit	Read	Antenna	Cable	Preamp	Ant	Table	Peak	Pol.	
Ant.				Limit	Line	Level	Factor	Loss	Factor	Pos	Pos	Avg.		
1		(MHz)	(dBμV/m)	(dB)	(dBμV/m)	(dBμV)	(dB/m)	(dB)	(dB)	(cm)	(deg)	(P/A)	(H/V)	
802.11n HT40 LF		99.66	27.78	-15.72	43.5	43.15	16	1.06	32.43	-	-	P	H	
		149.07	38.12	-5.38	43.5	51.26	17.53	1.75	32.42	100	0	P	H	
		241.95	28.39	-17.61	46	41.04	17.85	1.83	32.33	-	-	P	H	
		342.7	30.38	-15.62	46	39.46	20.77	2.44	32.29	-	-	P	H	
		747.3	32.03	-13.97	46	32.84	27.53	3.97	32.31	-	-	P	H	
		935.6	33.08	-12.92	46	29.81	29.92	4.6	31.25	-	-	P	H	
														H
														H
														H
														H
														H
														H
			44.04	34.82	-5.18	40	48.44	18.06	0.78	32.46	100	0	P	V
			99.66	28.34	-15.16	43.5	43.71	16	1.06	32.43	-	-	P	V
			149.61	28.75	-14.75	43.5	41.89	17.53	1.75	32.42	-	-	P	V
			519.8	24.92	-21.08	46	29.93	24.2	3.19	32.4	-	-	P	V
			868.4	32.14	-13.86	46	30.75	28.71	4.45	31.77	-	-	P	V
			944	33.63	-12.37	46	29.92	30.14	4.75	31.18	-	-	P	V
														V
														V
													V	
													V	
													V	
													V	
Remark	1. No other spurious found. 2. All results are PASS against limit line.													



Note symbol

*	Fundamental Frequency which can be ignored. However, the level of any unwanted emissions shall not exceed the level of the fundamental frequency.
!	Test result is over limit line.
P/A	Peak or Average
H/V	Horizontal or Vertical



A calculation example for radiated spurious emission is shown as below:

WIFI	Note	Frequency	Level	Over	Limit	Read	Antenna	Cable	Preamp	Ant	Table	Peak	Pol.
Ant.				Limit	Line	Level	Factor	Loss	Factor	Pos	Pos	Avg.	
1		(MHz)	(dBμV/m)	(dB)	(dBμV/m)	(dBμV)	(dB/m)	(dB)	(dB)	(cm)	(deg)	(P/A)	(H/V)
802.11b		2390	55.45	-18.55	74	54.51	32.22	4.58	35.86	103	308	P	H
CH 01													
2412MHz		2390	43.54	-10.46	54	42.6	32.22	4.58	35.86	103	308	A	H

- Level(dBμV/m) =
Antenna Factor(dB/m) + Cable Loss(dB) + Read Level(dBμV) - Preamp Factor(dB)
- Over Limit(dB) = Level(dBμV/m) – Limit Line(dBμV/m)

For Peak Limit @ 2390MHz:

- Level(dBμV/m)
= Antenna Factor(dB/m) + Cable Loss(dB) + Read Level(dBμV) - Preamp Factor(dB)
= 32.22(dB/m) + 4.58(dB) + 54.51(dBμV) – 35.86 (dB)
= 55.45 (dBμV/m)
- Over Limit(dB)
= Level(dBμV/m) – Limit Line(dBμV/m)
= 55.45(dBμV/m) – 74(dBμV/m)
= -18.55(dB)

For Average Limit @ 2390MHz:

- Level(dBμV/m)
= Antenna Factor(dB/m) + Cable Loss(dB) + Read Level(dBμV) - Preamp Factor(dB)
= 32.22(dB/m) + 4.58(dB) + 42.6(dBμV) – 35.86 (dB)
= 43.54 (dBμV/m)
- Over Limit(dB)
= Level(dBμV/m) – Limit Line(dBμV/m)
= 43.54(dBμV/m) – 54(dBμV/m)
= -10.46(dB)

Both peak and average measured complies with the limit line, so test result is “PASS”.



Appendix C. Radiated Spurious Emission

Test Engineer :	Nick Yu, Karl Hou, Peter Liao, and Citta Ke.	Temperature :	21~23°C
		Relative Humidity :	53~55%

Note symbol

-L	Low channel location
-R	High channel location



Band 1 - 5150~5250MHz

WIFI 802.11a (Band Edge @ 3m)

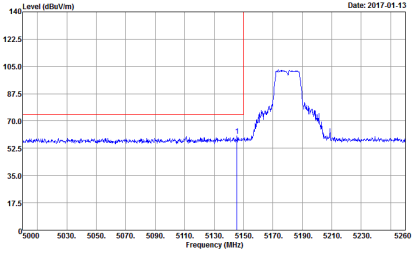
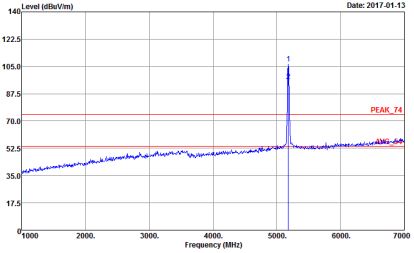
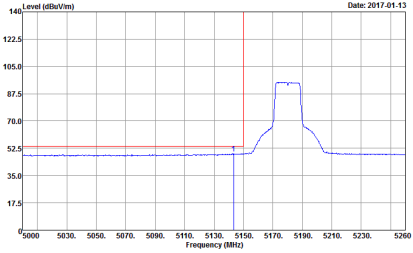
WIFI	Band 1 5150~5250MHz Band Edge @ 3m	
ANT	802.11a CH36 5180MHz	
1	<p style="text-align: center;">Horizontal</p>  <p style="font-size: small;">Date: 2017-01-13 Site Condition : 03CH12-HY : PEAK_BE_74 3m HORN_9120D_1328 HORIZONTAL : RBW:1000.000KHz VBW:3000.000KHz SWT:Auto</p>	<p style="text-align: center;">Fundamental</p>  <p style="font-size: small;">Date: 2017-01-13 Site Condition : 03CH12-HY : PEAK_74 3m HORN_9120D_1328 HORIZONTAL : RBW:1000.000KHz VBW:3000.000KHz SWT:Auto</p>
Peak	 <p style="font-size: small;">Date: 2017-01-13 Site Condition : 03CH12-HY : AVG_BE_54 3m HORN_9120D_1328 HORIZONTAL : RBW:1000.000KHz VBW:1.000KHz SWT:Auto</p>	<p style="text-align: center;">Left blank</p>
Avg.		



WIFI	Band 1 5150~5250MHz Band Edge @ 3m	
ANT	802.11a CH36 5180MHz	
<p>1</p> <p>Vertical</p> <p>Peak</p>		<p>Fundamental</p>
<p>Avg.</p>		<p>Left blank</p>

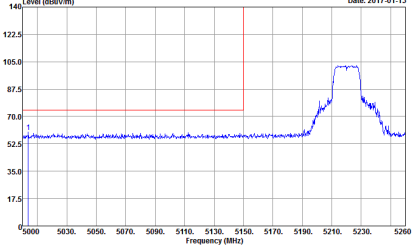
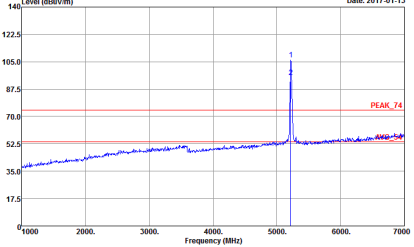
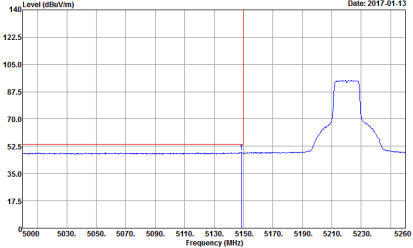

WIFI	Band 1 5150~5250MHz Band Edge @ 3m	
ANT	802.11a CH44 5220MHz - L	
1	Horizontal	Fundamental
Peak	 <p>Date: 2017-01-13</p> <p>Site Condition : 03CH12-HY : PEAK_BE_74 3m HORN_9120D_1328 HORIZONTAL : RBW:1000.000KHz VBW:3000.000KHz SWT:Auto</p>	 <p>Date: 2017-01-13</p> <p>Site Condition : 03CH12-HY : PEAK_74 3m HORN_9120D_1328 HORIZONTAL : RBW:1000.000KHz VBW:3000.000KHz SWT:Auto</p>
Avg.	 <p>Date: 2017-01-13</p> <p>Site Condition : 03CH12-HY : AVG_BE_54 3m HORN_9120D_1328 HORIZONTAL : RBW:1000.000KHz VBW:1.000KHz SWT:Auto</p>	Left blank

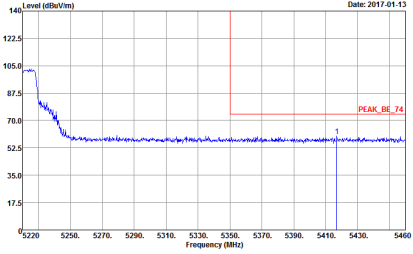
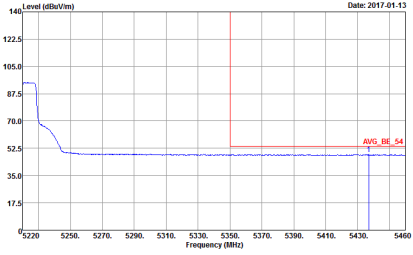

WIFI	Band 1 5150~5250MHz Band Edge @ 3m	
ANT	802.11a CH44 5220MHz - R	
1	Horizontal	Fundamental
Peak	 <p>Date: 2017.01.13</p> <p>Site : 03CH12-HY Condition : : PEAK_BE_74 3m HORN_9120D_1328 HORIZONTAL : RBW:1000.000KHz VBW:3000.000KHz SWT:Auto</p>	Left blank
Avg.	 <p>Date: 2017.01.13</p> <p>Site : 03CH12-HY Condition : : AVG_BE_54 3m HORN_9120D_1328 HORIZONTAL : RBW:1000.000KHz VBW:1.000KHz SWT:Auto</p>	Left blank

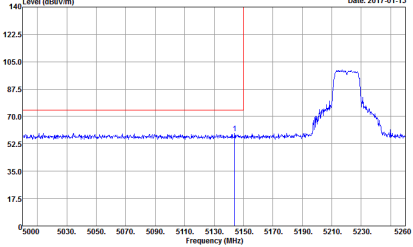
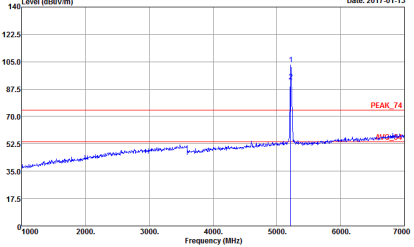
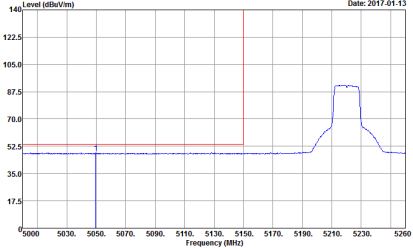

WIFI	Band 1 5150~5250MHz Band Edge @ 3m	
ANT	802.11a CH44 5220MHz - L	
1	Vertical	Fundamental
Peak	 <p>Site Condition : :03CH12-HY :PEAK_BE_74 3m HORN_9120D_1328 VERTICAL :RBW:1000.000kHz VBW:3000.000kHz SWT:Auto</p>	 <p>Site Condition : :03CH12-HY :PEAK_74 3m HORN_9120D_1328 VERTICAL :RBW:1000.000kHz VBW:3000.000kHz SWT:Auto</p>
Avg.	 <p>Site Condition : :03CH12-HY :AVG_BE_54 3m HORN_9120D_1328 VERTICAL :RBW:1000.000kHz VBW:1.000kHz SWT:Auto</p>	Left blank

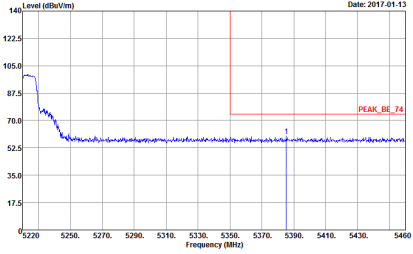
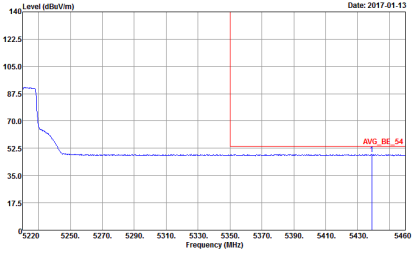

WIFI	Band 1 5150~5250MHz Band Edge @ 3m	
ANT	802.11a CH44 5220MHz - R	
1	Vertical	Fundamental
Peak	 <p>Date: 2017.01.13</p> <p>Site : 03CH12-HY Condition : PEAK_BE_74 3m HORN_9120D_132B VERTICAL : RBW:1000.000KHz VBW:3000.000KHz SWT:Auto</p>	Left blank
Avg.	 <p>Date: 2017.01.13</p> <p>Site : 03CH12-HY Condition : AVG_BE_54 3m HORN_9120D_132B VERTICAL : RBW:1000.000KHz VBW:1.000KHz SWT:Auto</p>	Left blank

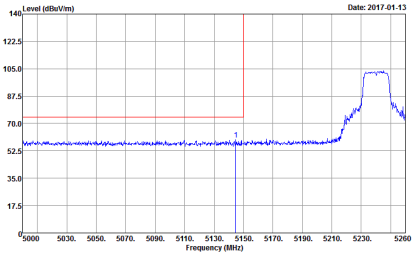
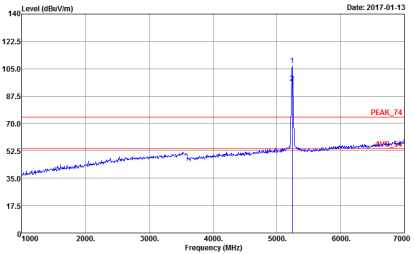
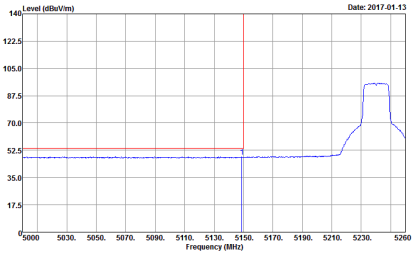

WIFI	Band 1 5150~5250MHz Band Edge @ 3m	
ANT	802.11a CH48 5240MHz - L	
1	Horizontal	Fundamental
Peak	 <p>Site Condition : 03CH12-HY : PEAK_BE_74 3m HORN_9120D_1328 HORIZONTAL : RBW:1000.000KHz VBW:3000.000KHz SWT:Auto</p>	 <p>Site Condition : 03CH12-HY : PEAK_74 3m HORN_9120D_1328 HORIZONTAL : RBW:1000.000KHz VBW:3000.000KHz SWT:Auto</p>
Avg.	 <p>Site Condition : 03CH12-HY : AVG_BE_54 3m HORN_9120D_1328 HORIZONTAL : RBW:1000.000KHz VBW:1.000KHz SWT:Auto</p>	Left blank

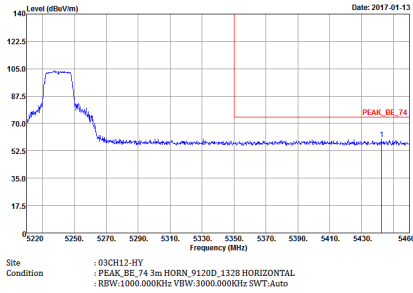
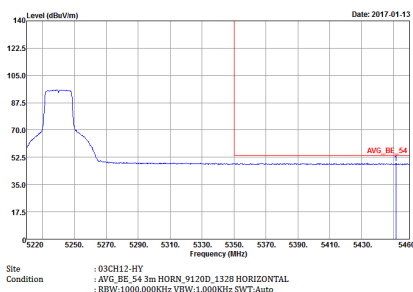

WIFI	Band 1 5150~5250MHz Band Edge @ 3m	
ANT	802.11a CH48 5240MHz - R	
1	Horizontal	Fundamental
Peak	 <p>Site : 03CH12-HY Condition : PEAK_BE_74 3m HORN_9120D_1328 HORIZONTAL RBW:1000.000kHz VBW:3000.000kHz SWT:Auto</p>	Left blank
Avg.	 <p>Site : 03CH12-HY Condition : AVG_BE_54 3m HORN_9120D_1328 HORIZONTAL RBW:1000.000kHz VBW:1.000kHz SWT:Auto</p>	Left blank

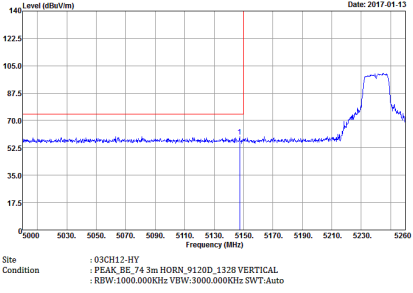
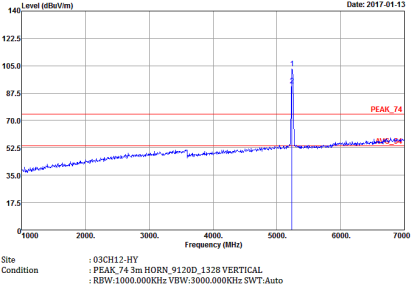
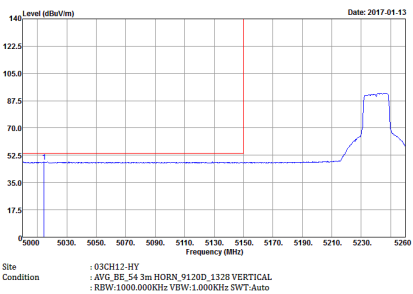

WIFI	Band 1 5150~5250MHz Band Edge @ 3m	
ANT	802.11a CH48 5240MHz - L	
<p>1</p> <p>Vertical</p> <p>Peak</p>	 <p>Site : 03CH12-HY Condition : PEAK_BE_74 3m HORN_9120D_1328 VERTICAL : RBW:1000.000KHz VBW:3000.000KHz SWT:Auto</p>	<p>Fundamental</p>  <p>Site : 03CH12-HY Condition : PEAK_74 3m HORN_9120D_1328 VERTICAL : RBW:1000.000KHz VBW:3000.000KHz SWT:Auto</p>
<p>Avg.</p>	 <p>Site : 03CH12-HY Condition : AVG_BE_54 3m HORN_9120D_1328 VERTICAL : RBW:1000.000KHz VBW:1.000KHz SWT:Auto</p>	<p>Left blank</p>



WIFI	Band 1 5150~5250MHz Band Edge @ 3m	
ANT	802.11a CH48 5240MHz - R	
1	Vertical	Fundamental
Peak	<p>Date: 2017.01.13</p> <p>Site : 03CH12-HY Condition : PEAK_BE_74 3m HORN_9120D_1328 VERTICAL : RBW:1000.000KHz VBW:3000.000KHz SWT:Auto</p>	Left blank
Avg.	<p>Date: 2017.01.13</p> <p>Site : 03CH12-HY Condition : AVG_BE_54 3m HORN_9120D_1328 VERTICAL : RBW:1000.000KHz VBW:1.000KHz SWT:Auto</p>	Left blank

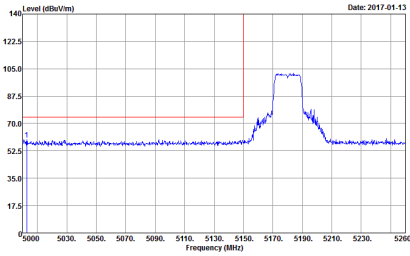
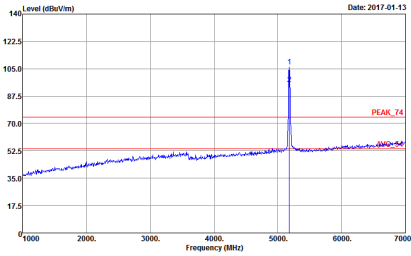
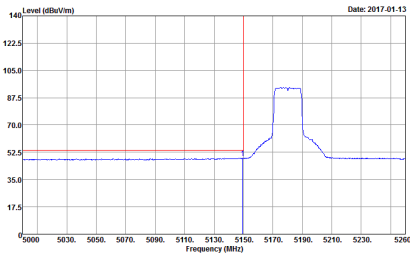

Band 1 5150~5250MHz
WIFI 802.11n HT20 (Band Edge @ 3m)

WIFI	Band 1 5150~5250MHz Band Edge @ 3m	
ANT	802.11n HT20 CH36 5180MHz	
1	Horizontal	Fundamental
Peak	 <p>Site Condition : 03CH12-HY : PEAK_BE_74 3m HORN_9120D_1328 HORIZONTAL : RBW:1000.000KHz VBW:3000.000KHz SWT:Auto</p>	 <p>Site Condition : 03CH12-HY : PEAK_74 3m HORN_9120D_1328 HORIZONTAL : RBW:1000.000KHz VBW:3000.000KHz SWT:Auto</p>
Avg.	 <p>Site Condition : 03CH12-HY : AVG_BE_54 3m HORN_9120D_1328 HORIZONTAL : RBW:1000.000KHz VBW:1.000KHz SWT:Auto</p>	Left blank



WIFI	Band 1 5150~5250MHz Band Edge @ 3m	
ANT	802.11n HT20 CH36 5180MHz	
<p>1</p> <p>Vertical</p> <p>Peak</p>	<p>Site Condition : 03CH12-HY : PEAK_BE_74 3m HORN_9120D_1328 VERTICAL : RBW:1000.000KHz VBW:3000.000KHz SWT:Auto</p>	<p>Fundamental</p> <p>Site Condition : 03CH12-HY : PEAK_74 3m HORN_9120D_1328 VERTICAL : RBW:1000.000KHz VBW:3000.000KHz SWT:Auto</p>
<p>Avg.</p>	<p>Site Condition : 03CH12-HY : AVG_BE_54 3m HORN_9120D_1328 VERTICAL : RBW:1000.000KHz VBW:1.000KHz SWT:Auto</p>	<p>Left blank</p>

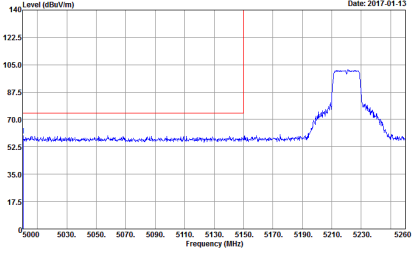
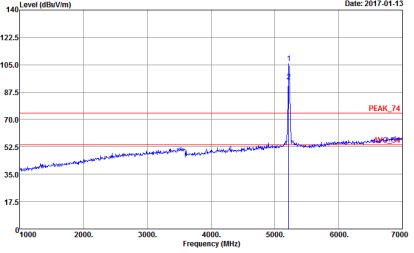
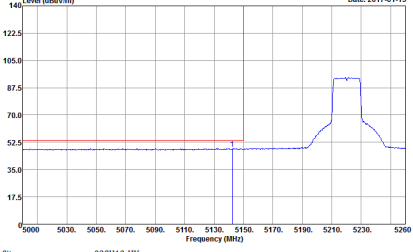

WIFI	Band 1 5150~5250MHz Band Edge @ 3m	
ANT	802.11n HT20 CH44 5220MHz - L	
1	<p style="text-align: center;">Horizontal</p>  <p style="font-size: small;">Date: 2017-01-13 Site : 03CH12-HY Condition : PEAK_SE_74 3m HORN_9120D_1328 HORIZONTAL : RBW:1000.000KHz VBW:3000.000KHz SWT:Auto</p>	<p style="text-align: center;">Fundamental</p>  <p style="font-size: small;">Date: 2017-01-13 Site : 03CH12-HY Condition : PEAK_74 3m HORN_9120D_1328 HORIZONTAL : RBW:1000.000KHz VBW:3000.000KHz SWT:Auto</p>
Peak	<p style="text-align: center;">Avg.</p>  <p style="font-size: small;">Date: 2017-01-13 Site : 03CH12-HY Condition : AVG_BE_54 3m HORN_9120D_1328 HORIZONTAL : RBW:1000.000KHz VBW:1.000KHz SWT:Auto</p>	<p style="text-align: center;">Left blank</p>



WIFI	Band 1 5150~5250MHz Band Edge @ 3m	
ANT	802.11n HT20 CH44 5220MHz - R	
1	Horizontal	Fundamental
<p>Peak</p>	<p>Date: 2017.01.13</p> <p>Site Condition : :03CH12-HY :PEAK_BE_74 3m HORN_9120D_1328 HORIZONTAL :RBW:1000.000KHz VBW:3000.000KHz SWT:Auto</p>	<p>Left blank</p>
<p>Avg.</p>	<p>Date: 2017.01.13</p> <p>Site Condition : :03CH12-HY :AVG_BE_54 3m HORN_9120D_1328 HORIZONTAL :RBW:1000.000KHz VBW:1.000KHz SWT:Auto</p>	<p>Left blank</p>

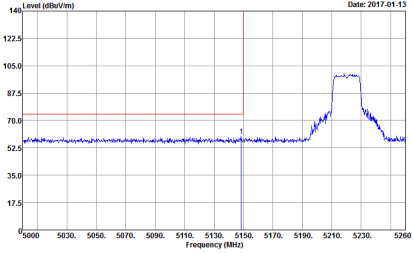
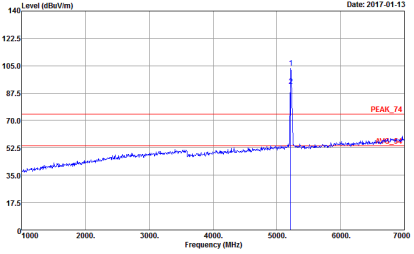
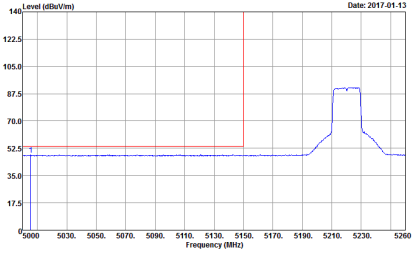

WIFI	Band 1 5150~5250MHz Band Edge @ 3m	
ANT	802.11n HT20 CH44 5220MHz - L	
<p style="text-align: center;">1</p>	<p style="text-align: center;">Vertical</p>  <p style="font-size: small;">Date: 2017-01-13 Level (dBuV/m) 140 122.5 105.0 87.5 70.0 52.5 35.0 17.5 0 5000 5030 5050 5070 5090 5110 5130 5150 5170 5190 5210 5230 5250 Frequency (MHz)</p> <p style="font-size: x-small;">Site : 03CH12-HY Condition : PEAK_BE_74 3m HORN_9120D_1328 VERTICAL : RBW:1000.000KHz VBW:3000.000KHz SWT:Auto</p>	<p style="text-align: center;">Fundamental</p>  <p style="font-size: small;">Date: 2017-01-13 Level (dBuV/m) 140 122.5 105.0 87.5 70.0 52.5 35.0 17.5 0 1000 2000 3000 4000 5000 6000 7000 Frequency (MHz)</p> <p style="font-size: x-small;">Site : 03CH12-HY Condition : PEAK_74 3m HORN_9120D_1328 VERTICAL : RBW:1000.000KHz VBW:3000.000KHz SWT:Auto</p>
<p style="text-align: center;">Peak</p>	 <p style="font-size: small;">Date: 2017-01-13 Level (dBuV/m) 140 122.5 105.0 87.5 70.0 52.5 35.0 17.5 0 5000 5030 5050 5070 5090 5110 5130 5150 5170 5190 5210 5230 5250 Frequency (MHz)</p> <p style="font-size: x-small;">Site : 03CH12-HY Condition : AVG_BE_54 3m HORN_9120D_1328 VERTICAL : RBW:1000.000KHz VBW:1.000KHz SWT:Auto</p>	<p style="text-align: center;">Left blank</p>
<p style="text-align: center;">Avg.</p>		



WIFI	Band 1 5150~5250MHz Band Edge @ 3m	
ANT	802.11n HT20 CH44 5220MHz - R	
1	Vertical	Fundamental
Peak	<p>Date: 2017.01.13</p> <p>Site : 03CH12-HY Condition : : PEAK_BE_74 3m HORN_9120D_1328 VERTICAL : RBW:1000.000KHz VBW:3000.000KHz SWT:Auto</p>	Left blank
Avg.	<p>Date: 2017.01.13</p> <p>Site : 03CH12-HY Condition : : AVG_BE_54 3m HORN_9120D_1328 VERTICAL : RBW:1000.000KHz VBW:1.000KHz SWT:Auto</p>	Left blank



WIFI	Band 1 5150~5250MHz Band Edge @ 3m	
ANT	802.11n HT20 CH48 5240MHz - L	
1	Horizontal	Fundamental
Peak	<p>Level (dBuV/m) vs Frequency (MHz) plot for Peak Horizontal. The plot shows a signal level around 52.5 dBuV/m with a peak at 5240 MHz reaching approximately 105 dBuV/m. The x-axis ranges from 5000 to 5260 MHz, and the y-axis ranges from 0 to 140 dBuV/m. A red vertical line is at 5150 MHz. The date is 2017-01-13.</p> <p>Site : 03CH12-HY Condition : PEAK_BE_74 3m HORN_9120D_1328 HORIZONTAL : RBW:1000.000kHz VBW:3000.000kHz SWT:Auto</p>	<p>Level (dBuV/m) vs Frequency (MHz) plot for Peak Fundamental. The plot shows a signal level around 52.5 dBuV/m with a sharp peak at 5240 MHz reaching approximately 105 dBuV/m. The x-axis ranges from 4000 to 7000 MHz, and the y-axis ranges from 0 to 140 dBuV/m. A red vertical line is at 5150 MHz. The date is 2017-01-13.</p> <p>Site : 03CH12-HY Condition : PEAK_74 3m HORN_9120D_1328 HORIZONTAL : RBW:1000.000kHz VBW:3000.000kHz SWT:Auto</p>
Avg.	<p>Level (dBuV/m) vs Frequency (MHz) plot for Avg. Horizontal. The plot shows a signal level around 52.5 dBuV/m with a peak at 5240 MHz reaching approximately 105 dBuV/m. The x-axis ranges from 5000 to 5260 MHz, and the y-axis ranges from 0 to 140 dBuV/m. A red vertical line is at 5150 MHz. The date is 2017-01-13.</p> <p>Site : 03CH12-HY Condition : AVG_BE_54 3m HORN_9120D_1328 HORIZONTAL : RBW:1000.000kHz VBW:1.000kHz SWT:Auto</p>	Left blank



WIFI	Band 1 5150~5250MHz Band Edge @ 3m	
ANT	802.11n HT20 CH48 5240MHz - R	
1	Horizontal	Fundamental
Peak	<p>Site : 03CH12-HY Condition : :PEAK_BE_74 3m HORN_9120D_1328 HORIZONTAL :RBW:1000.000kHz VBW:3000.000kHz SWT:Auto</p>	Left blank
Avg.	<p>Site : 03CH12-HY Condition : :AVG_BE_54 3m HORN_9120D_1328 HORIZONTAL :RBW:1000.000kHz VBW:1.000kHz SWT:Auto</p>	Left blank

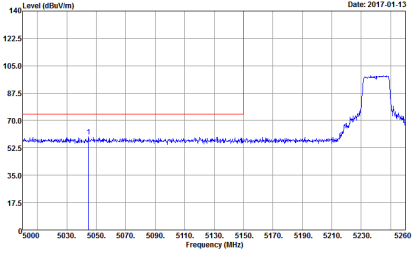
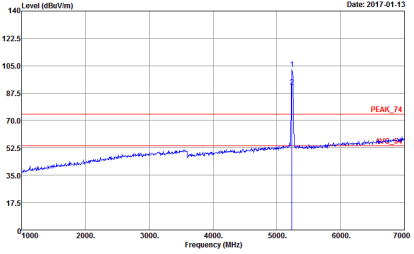
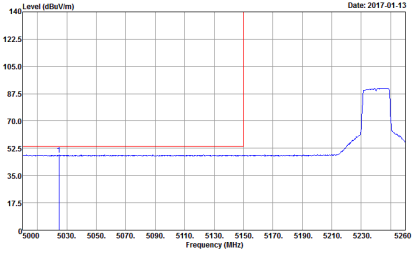

WIFI	Band 1 5150~5250MHz Band Edge @ 3m	
ANT	802.11n HT20 CH48 5240MHz - L	
<p>1</p> <p>Vertical</p> <p>Peak</p>	 <p>Date: 2017-01-13</p> <p>Site Condition : 03CH12-HY : PEAK_BE_74 3m HORN_9120D_1328 VERTICAL : RBW:1000.000KHz VBW:3000.000KHz SWT:Auto</p>	<p>Fundamental</p>  <p>Date: 2017-01-13</p> <p>Site Condition : 03CH12-HY : PEAK_74 3m HORN_9120D_1328 VERTICAL : RBW:1000.000KHz VBW:3000.000KHz SWT:Auto</p>
<p>Avg.</p>	 <p>Date: 2017-01-13</p> <p>Site Condition : 03CH12-HY : AVG_BE_54 3m HORN_9120D_1328 VERTICAL : RBW:1000.000KHz VBW:1.000KHz SWT:Auto</p>	<p>Left blank</p>



WIFI	Band 1 5150~5250MHz Band Edge @ 3m	
ANT	802.11n HT20 CH48 5240MHz - R	
1	Vertical	Fundamental
<p>Peak</p>	<p>Date: 2017.01.13</p> <p>Site : 03CH12-HY Condition : : PEAK_BE_74 3m HORN_9120D_1328 VERTICAL : RBW:1000.000kHz VBW:3000.000kHz SWT:Auto</p>	<p>Left blank</p>
<p>Avg.</p>	<p>Date: 2017.01.13</p> <p>Site : 03CH12-HY Condition : : AVG_BE_54 3m HORN_9120D_1328 VERTICAL : RBW:1000.000kHz VBW:1.000kHz SWT:Auto</p>	<p>Left blank</p>



Band 1 5150~5250MHz
WIFI 802.11n HT40 (Band Edge @ 3m)

Table with 2 columns (WIFI, ANT) and 2 rows (Peak, Avg.). The table contains spectral analysis plots for 'Horizontal' and 'Fundamental' views. The 'Peak' row shows a signal peak at 5180 MHz in the horizontal view and a peak at 5180 MHz in the fundamental view. The 'Avg.' row shows the average signal level, which is blank in the fundamental view.

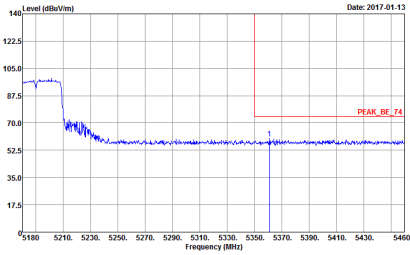
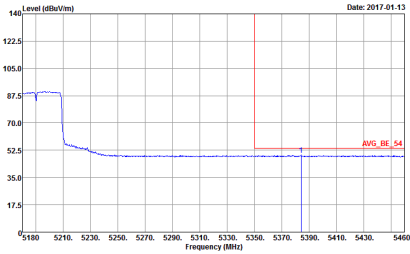

WIFI	Band 1 5150~5250MHz Band Edge @ 3m	
ANT	802.11n HT40 CH38 5190MHz - R	
1	Horizontal	Fundamental
Peak	 <p>Date: 2017.01.13</p> <p>Site : 03CH12-HY Condition : PEAK_BE_74 3m HORN_9120D_1328 HORIZONTAL</p>	Left blank
Avg.	 <p>Date: 2017.01.13</p> <p>Site : 03CH12-HY Condition : AVG_BE_54 3m HORN_9120D_1328 HORIZONTAL</p>	Left blank

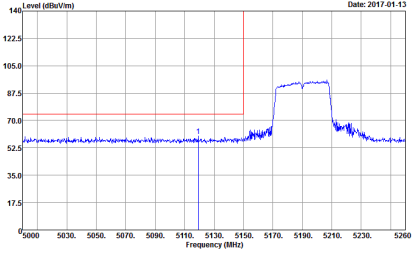
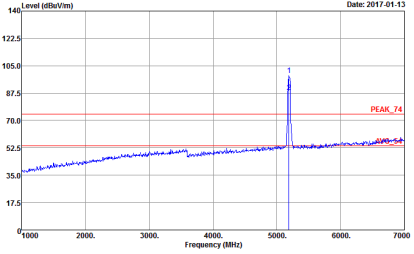
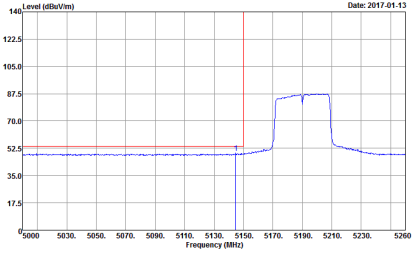

WIFI	Band 1 5150~5250MHz Band Edge @ 3m	
ANT	802.11n HT40 CH38 5190MHz - L	
<p>1</p> <p>Vertical</p> <p>Peak</p>	 <p>Level (dBuV/m)</p> <p>Frequency (MHz)</p> <p>Date: 2017-01-13</p> <p>Site Condition : 03CH12-HY : PEAK_BE_74 3m HORN_9120D_1328 VERTICAL : RBW:1000.000KHz VBW:3000.000KHz SWT:Auto</p>	<p>Fundamental</p>  <p>Level (dBuV/m)</p> <p>Frequency (MHz)</p> <p>Date: 2017-01-13</p> <p>Site Condition : 03CH12-HY : PEAK_74 3m HORN_9120D_1328 VERTICAL : RBW:1000.000KHz VBW:3000.000KHz SWT:Auto</p>
<p>Avg.</p>	 <p>Level (dBuV/m)</p> <p>Frequency (MHz)</p> <p>Date: 2017-01-13</p> <p>Site Condition : 03CH12-HY : AVG_BE_54 3m HORN_9120D_1328 VERTICAL : RBW:1000.000KHz VBW:3.000KHz SWT:Auto</p>	<p>Left blank</p>



WIFI	Band 1 5150~5250MHz Band Edge @ 3m	
ANT	802.11n HT40 CH38 5190MHz - R	
1	Vertical	Fundamental
<p>Peak</p>	<p>Site : 03CH12-HY Condition : PEAK_BE_74 3m HORN_9120D_1328 VERTICAL</p>	<p>Left blank</p>
<p>Avg.</p>	<p>Site : 03CH12-HY Condition : AVG_BE_54 3m HORN_9120D_1328 VERTICAL</p>	<p>Left blank</p>

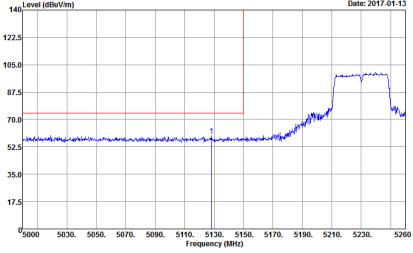
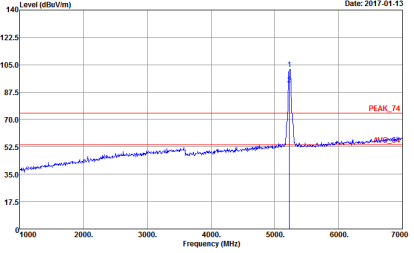
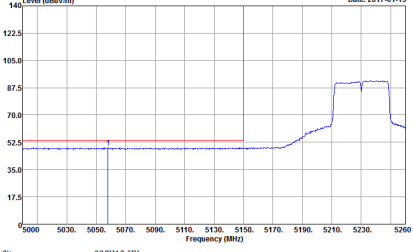

WIFI	Band 1 5150~5250MHz Band Edge @ 3m	
ANT	802.11n HT40 CH46 5230MHz - L	
1	<p style="text-align: center;">Horizontal</p>  <p style="text-align: right;">Date: 2017-01-13</p> <p>Site : 03CH12-HY Condition : PEAK_SE_74 3m HORN_9120D_1328 HORIZONTAL : RBW:1000.000KHz VBW:3000.000KHz SWT:Auto</p>	<p style="text-align: center;">Fundamental</p>  <p style="text-align: right;">Date: 2017-01-13</p> <p>Site : 03CH12-HY Condition : PEAK_74 3m HORN_9120D_1328 HORIZONTAL : RBW:1000.000KHz VBW:3000.000KHz SWT:Auto</p>
Peak	<p style="text-align: center;">Avg.</p>  <p style="text-align: right;">Date: 2017-01-13</p> <p>Site : 03CH12-HY Condition : AVG_BE_54 3m HORN_9120D_1328 HORIZONTAL : RBW:1000.000KHz VBW:3.000KHz SWT:Auto</p>	<p style="text-align: center;">Left blank</p>



WIFI	Band 1 5150~5250MHz Band Edge @ 3m	
ANT	802.11n HT40 CH46 5230MHz - R	
1	Horizontal	Fundamental
Peak	<p>Site : 03CH12-HY Condition : PEAK_BE_74 3m HORN_9120D_1328 HORIZONTAL : RBW:1000.000kHz VBW:3000.000kHz SWT-Auto</p>	Left blank
Avg.	<p>Site : 03CH12-HY Condition : AVG_BE_54 3m HORN_9120D_1328 HORIZONTAL : RBW:1000.000kHz VBW:3.000kHz SWT-Auto</p>	Left blank

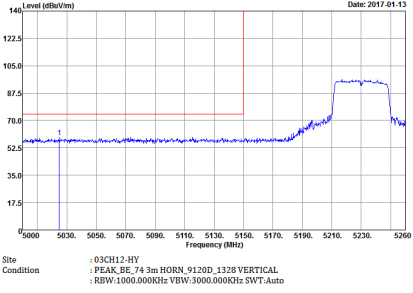
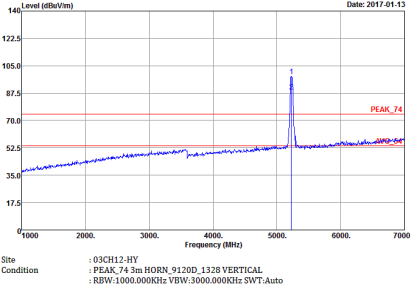
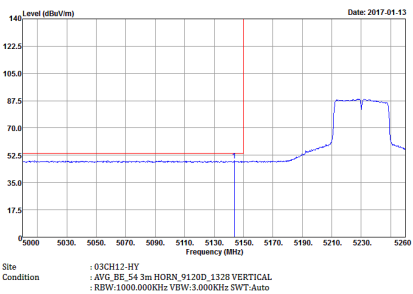

WIFI	Band 1 5150~5250MHz Band Edge @ 3m	
ANT	802.11n HT40 CH46 5230MHz - L	
<p>1</p> <p>Vertical</p> <p>Peak</p>	 <p>Site Condition : 03CH12-HY : PEAK_BE_74 3m HORN_9120D_1328 VERTICAL : RBW:1000.000KHz VBW:3000.000KHz SWT:Auto</p>	<p>Fundamental</p>  <p>Site Condition : 03CH12-HY : PEAK_74 3m HORN_9120D_1328 VERTICAL : RBW:1000.000KHz VBW:3000.000KHz SWT:Auto</p>
<p>Avg.</p>	 <p>Site Condition : 03CH12-HY : AVG_BE_54 3m HORN_9120D_1328 VERTICAL : RBW:1000.000KHz VBW:3.000KHz SWT:Auto</p>	<p>Left blank</p>



WIFI	Band 1 5150~5250MHz Band Edge @ 3m	
ANT	802.11n HT40 CH46 5230MHz - R	
1	Vertical	Fundamental
<p>Peak</p>	<p>Date: 2017.01.13</p> <p>Site : 03CH12-HY Condition : PEAK_BE_74 3m HORN_9120D_132B VERTICAL : RBW:1000.000KHz VBW:3000.000KHz SWT:Auto</p>	<p>Left blank</p>
<p>Avg.</p>	<p>Date: 2017.01.13</p> <p>Site : 03CH12-HY Condition : AVG_BE_54 3m HORN_9120D_132B VERTICAL : RBW:1000.000KHz VBW:3.000KHz SWT:Auto</p>	<p>Left blank</p>



Band 1 - 5150~5250MHz

WIFI 802.11a (Harmonic @ 3m)

WIFI	Band 1 5150~5250MHz Harmonic @ 3m	
ANT	802.11a CH36 5180MHz	
1	Horizontal	Vertical
<p>Peak</p> <p>Avg.</p>	<p>Site : 03CH12-HY Condition : PEAK(UNII) 3m HORN_9120D_1328 HORIZONTAL Detector : Peak</p>	<p>Site : 03CH12-HY Condition : PEAK(UNII) 3m HORN_9120D_1328 VERTICAL Detector : Peak</p>

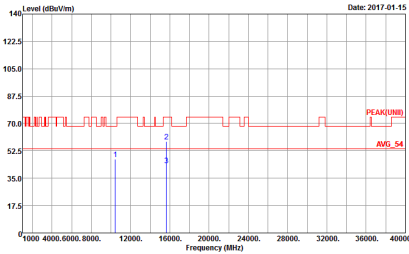
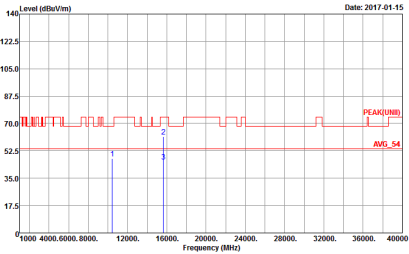

WIFI	Band 1 5150~5250MHz Harmonic @ 3m	
ANT	802.11a CH44 5220MHz	
1	Horizontal	Vertical
<p>Peak Avg.</p>	 <p>Site : 03CH12-HY Condition : PEAK(UNII) 3m HORN_9120D_1328 HORIZONTAL Detector : Peak</p>	 <p>Site : 03CH12-HY Condition : PEAK(UNII) 3m HORN_9120D_1328 VERTICAL Detector : Peak</p>

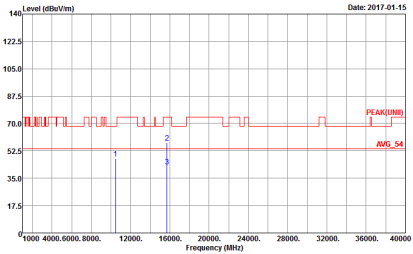
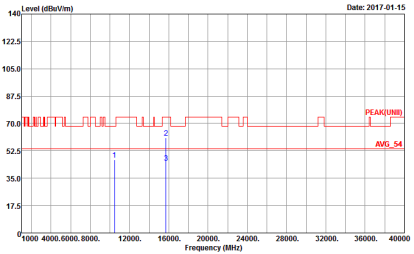

WIFI	Band 1 5150~5250MHz Harmonic @ 3m	
ANT	802.11a CH48 5240MHz	
1	Horizontal	Vertical
<p>Peak Avg.</p>	 <p>Site : 03CH12-HY Condition : PEAK(UNIT) 3m HORN_9120D_1328 HORIZONTAL Detector : Peak</p>	 <p>Site : 03CH12-HY Condition : PEAK(UNIT) 3m HORN_9120D_1328 VERTICAL Detector : Peak</p>



Band 1 5150~5250MHz
WIFI 802.11n HT20 (Harmonic @ 3m)

WIFI	Band 1 5150~5250MHz Harmonic @ 3m	
ANT	802.11n HT20 CH36 5180MHz	
1	Horizontal	Vertical
<p>Peak</p> <p>Avg.</p>	<p>Site : 03CH12-HY Condition : PEAK(UMI) 3m HORN_9120D_1328 HORIZONTAL Detector : Peak</p>	<p>Site : 03CH12-HY Condition : PEAK(UMI) 3m HORN_9120D_1328 VERTICAL Detector : Peak</p>



WIFI	Band 1 5150~5250MHz Harmonic @ 3m	
ANT	802.11n HT20 CH44 5220MHz	
1	Horizontal	Vertical
Peak Avg.	<p>Site : 03CH12-HY Condition : PEAK(UNII) 3m HORN_9120D_1328 HORIZONTAL Detector : Peak</p>	<p>Site : 03CH12-HY Condition : PEAK(UNII) 3m HORN_9120D_1328 VERTICAL Detector : Peak</p>

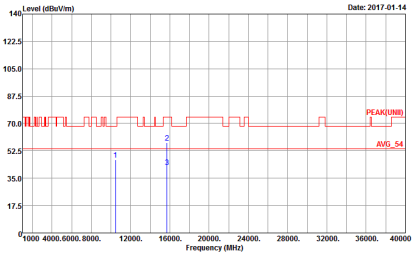
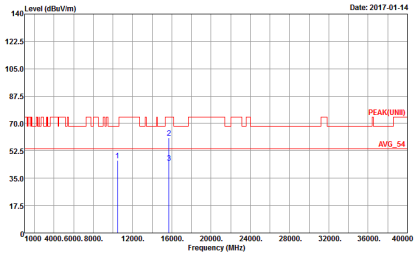

WIFI	Band 1 5150~5250MHz Harmonic @ 3m	
ANT	802.11n HT20 CH48 5240MHz	
1	Horizontal	Vertical
<p>Peak Avg.</p>	 <p>Site : 03CH12-HY Condition : PEAK(UNII) 3m HORN_9120D_1328 HORIZONTAL Detector : Peak</p>	 <p>Site : 03CH12-HY Condition : PEAK(UNII) 3m HORN_9120D_1328 VERTICAL Detector : Peak</p>

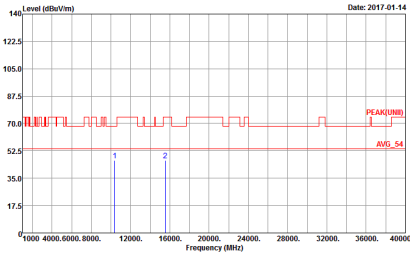
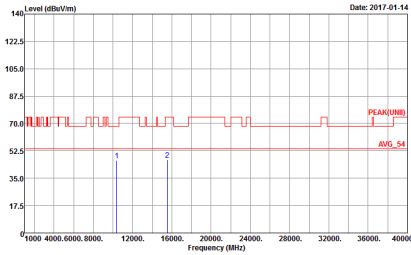

Band 1 5150~5250MHz
WIFI 802.11n HT40 (Harmonic @ 3m)

WIFI	Band 1 5150~5250MHz Harmonic @ 3m	
ANT	802.11n HT40 CH38 5190MHz	
1	Horizontal	Vertical
<p>Peak</p> <p>Avg.</p>	 <p>Site : 03CH12-HY Condition : PEAK(UNI) 3m HORN_9120D_1328 HORIZONTAL Detector : Peak</p>	 <p>Site : 03CH12-HY Condition : PEAK(UNI) 3m HORN_9120D_1328 VERTICAL Detector : Peak</p>



WIFI	Band 1 5150~5250MHz Harmonic @ 3m	
ANT	802.11n HT40 CH46 5230MHz	
1	Horizontal	Vertical
Peak Avg.	<p>Site : 03CH12-HY Condition : PEAK(UNII) 3m HORN_9120D_1328 HORIZONTAL Detector : Peak</p>	<p>Site : 03CH12-HY Condition : PEAK(UNII) 3m HORN_9120D_1328 VERTICAL Detector : Peak</p>



Band 2 - 5250~5350MHz

WIFI 802.11a (Band Edge @ 3m)

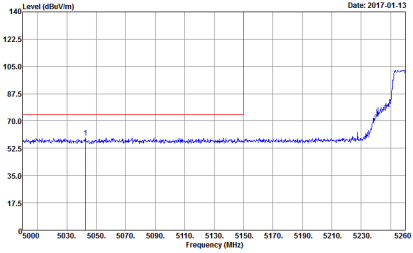
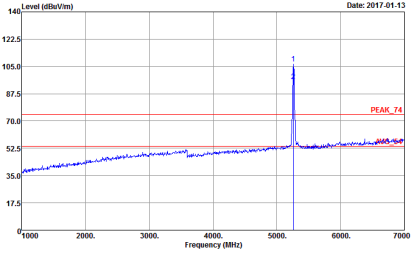
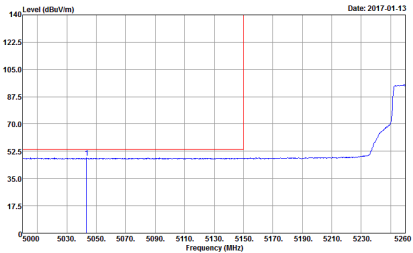
WIFI	Band 2 5250~5350MHz Band Edge @ 3m	
ANT	802.11a CH52 5260MHz - L	
<p>1</p>	<p style="text-align: center;">Horizontal</p>  <p style="font-size: small;">Date: 2017-01-13</p> <p style="font-size: x-small;">Site Condition : 03CH12-HY : PEAK_BE_74 3m HORN_9120D_1328 HORIZONTAL : RBW:1000.000KHz VBW:3000.000KHz SWT:Auto</p>	<p style="text-align: center;">Fundamental</p>  <p style="font-size: small;">Date: 2017-01-13</p> <p style="font-size: x-small;">Site Condition : 03CH12-HY : PEAK_74 3m HORN_9120D_1328 HORIZONTAL : RBW:1000.000KHz VBW:3000.000KHz SWT:Auto</p>
<p>Peak</p>	<p style="text-align: center;">Avg.</p>  <p style="font-size: small;">Date: 2017-01-13</p> <p style="font-size: x-small;">Site Condition : 03CH12-HY : AVG_BE_54 3m HORN_9120D_1328 HORIZONTAL : RBW:1000.000KHz VBW:1.000KHz SWT:Auto</p>	<p style="text-align: center;">Left blank</p>



WIFI	Band 2 5250~5350MHz Band Edge @ 3m	
ANT	802.11a CH52 5260MHz - R	
1	Horizontal	Fundamental
Peak	<p>Site : 03CH12-HY Condition : PEAK_BE_74 3m HORN_9120D_1328 HORIZONTAL : RBW:1000.000KHz VBW:3000.000KHz SWT:Auto</p>	Left blank
Avg.	<p>Site : 03CH12-HY Condition : AVG_BE_54 3m HORN_9120D_1328 HORIZONTAL : RBW:1000.000KHz VBW:1.000KHz SWT:Auto</p>	Left blank

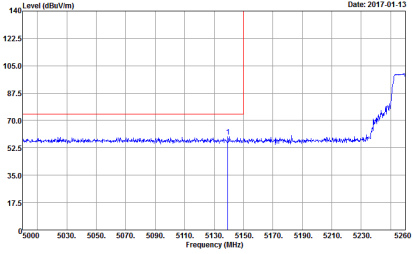
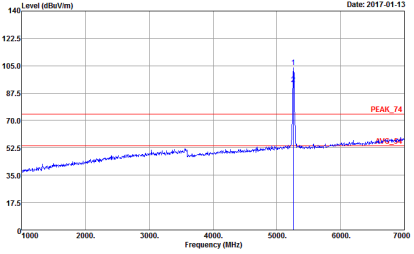
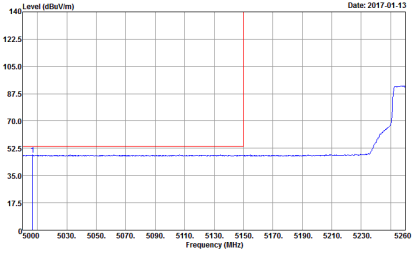

WIFI	Band 2 5250~5350MHz Band Edge @ 3m	
ANT	802.11a CH52 5260MHz - L	
<p>1</p> <p>Vertical</p> <p>Peak</p>	 <p>Date: 2017-01-13</p> <p>Site Condition : 03CH12-HY : PEAK_BE_74 3m HORN_9120D_1328 VERTICAL : RBW:1000.000KHz VBW:3000.000KHz SWT:Auto</p>	<p>Fundamental</p>  <p>Date: 2017-01-13</p> <p>Site Condition : 03CH12-HY : PEAK_74 3m HORN_9120D_1328 VERTICAL : RBW:1000.000KHz VBW:3000.000KHz SWT:Auto</p>
<p>Avg.</p>	 <p>Date: 2017-01-13</p> <p>Site Condition : 03CH12-HY : AVG_BE_54 3m HORN_9120D_1328 VERTICAL : RBW:1000.000KHz VBW:1.000KHz SWT:Auto</p>	<p>Left blank</p>

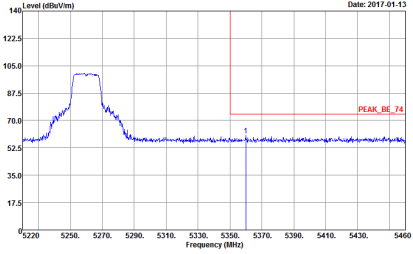
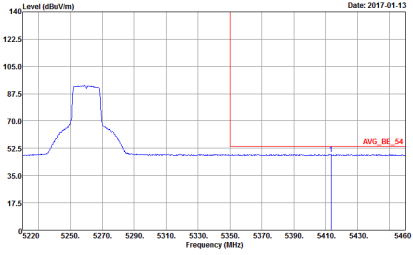

WIFI	Band 2 5250~5350MHz Band Edge @ 3m	
ANT	802.11a CH52 5260MHz - R	
1	Vertical	Fundamental
Peak	 <p>Site : 03CH12-HY Condition : : PEAK_BE_74 3m HORN_9120D_1328 VERTICAL : RBW:1000.000KHz VBW:3000.000KHz SWT:Auto</p>	Left blank
Avg.	 <p>Site : 03CH12-HY Condition : : AVG_BE_54 3m HORN_9120D_1328 VERTICAL : RBW:1000.000KHz VBW:1.000KHz SWT:Auto</p>	Left blank

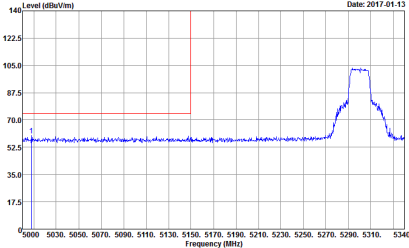
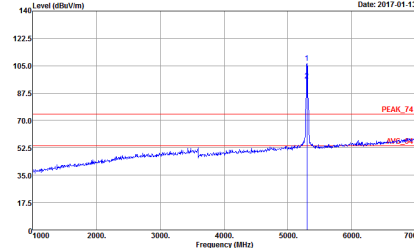
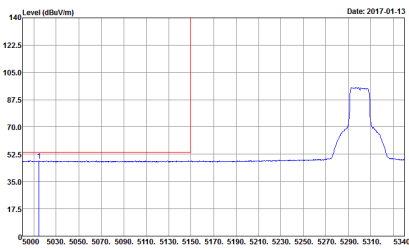

WIFI	Band 2 5250~5350MHz Band Edge @ 3m	
ANT	802.11a CH60 5300MHz - L	
1	Horizontal	Fundamental
Peak	 <p>Date: 2017-01-13</p> <p>Site : 03CH12-HY Condition : PEAK_BE_74 3m HORN_9120D_1328 HORIZONTAL</p>	 <p>Date: 2017-01-13</p> <p>Site : 03CH12-HY Condition : PEAK_74 3m HORN_9120D_1328 HORIZONTAL</p>
Avg.	 <p>Date: 2017-01-13</p> <p>Site : 03CH12-HY Condition : AVG_BE_54 3m HORN_9120D_1328 HORIZONTAL</p>	Left blank



WIFI	Band 2 5250~5350MHz Band Edge @ 3m	
ANT	802.11a CH60 5300MHz - R	
1	Horizontal	Fundamental
<p>Peak</p>	<p>Site : 03CH12-HY Condition : :PEAK_BE_74 3m HORN_9120D_1328 HORIZONTAL :RBW:1000.000KHz VBW:3000.000KHz SWT:Auto</p>	<p>Left blank</p>
<p>Avg.</p>	<p>Site : 03CH12-HY Condition : :AVG_BE_54 3m HORN_9120D_1328 HORIZONTAL :RBW:1000.000KHz VBW:1.000KHz SWT:Auto</p>	<p>Left blank</p>

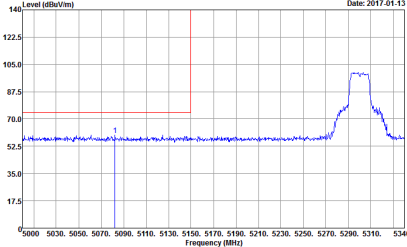
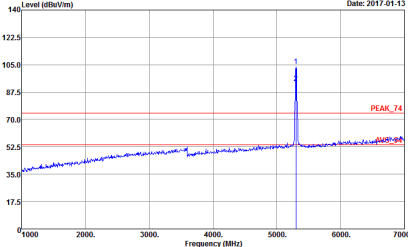
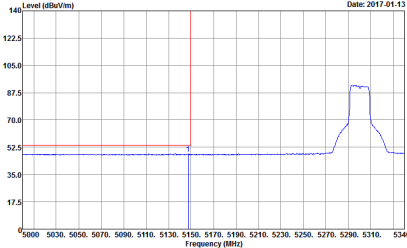

WIFI	Band 2 5250~5350MHz Band Edge @ 3m	
ANT	802.11a CH60 5300MHz - L	
1	Vertical	Fundamental
Peak	 <p>Date: 2017-01-13</p> <p>Site : 03CH12-HY Condition : PEAK_BE_74 3m HORN_9120D_1328 VERTICAL</p>	 <p>Date: 2017-01-13</p> <p>Site : 03CH12-HY Condition : PEAK_74 3m HORN_9120D_1328 VERTICAL</p>
Avg.	 <p>Date: 2017-01-13</p> <p>Site : 03CH12-HY Condition : AVG_BE_54 3m HORN_9120D_1328 VERTICAL</p>	Left blank

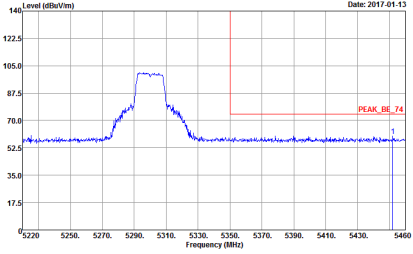
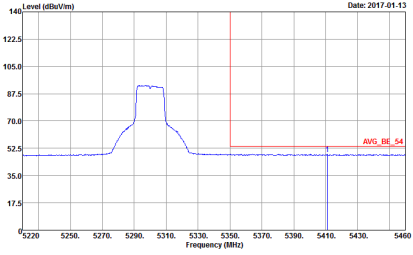

WIFI	Band 2 5250~5350MHz Band Edge @ 3m	
ANT	802.11a CH60 5300MHz - R	
1	Vertical	Fundamental
Peak	 <p>Date: 2017.01.13</p> <p>Site : 03CH12-HY Condition : : PEAK_BE_74 3m HORN_9120D_132B VERTICAL : RBW:1000.000KHz VBW:3000.000KHz SWT:Auto</p>	Left blank
Avg.	 <p>Date: 2017.01.13</p> <p>Site : 03CH12-HY Condition : : AVG_BE_54 3m HORN_9120D_132B VERTICAL : RBW:1000.000KHz VBW:1.000KHz SWT:Auto</p>	Left blank

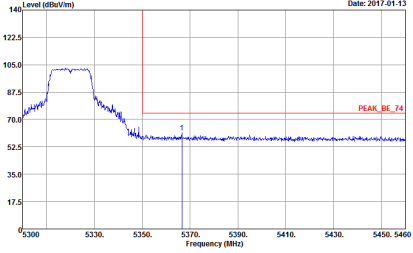
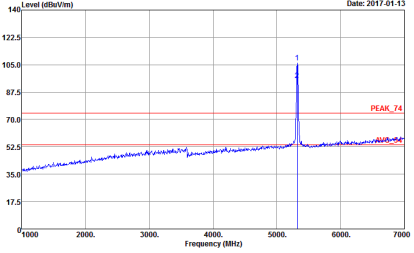
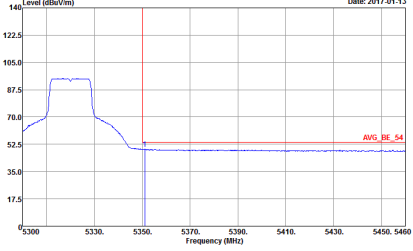

WIFI	Band 2 5250~5350MHz Band Edge @ 3m	
ANT	802.11a CH64 5320MHz	
1	<p style="text-align: center;">Horizontal</p>  <p style="text-align: right;">Date: 2017-01-13</p> <p style="text-align: right;">PEAK_BE_74</p> <p>Site Condition : 03CH12-HY : PEAK_BE_74 3m HORN_9120D_1328 HORIZONTAL : RBW:1000.000KHz VBW:3000.000KHz SWT:Auto</p>	<p style="text-align: center;">Fundamental</p>  <p style="text-align: right;">Date: 2017-01-13</p> <p style="text-align: right;">PEAK_74</p> <p>Site Condition : 03CH12-HY : PEAK_74 3m HORN_9120D_1328 HORIZONTAL : RBW:1000.000KHz VBW:3000.000KHz SWT:Auto</p>
Peak	 <p style="text-align: right;">Date: 2017-01-13</p> <p style="text-align: right;">AVG_BE_54</p> <p>Site Condition : 03CH12-HY : AVG_BE_54 3m HORN_9120D_1328 HORIZONTAL : RBW:1000.000KHz VBW:1.000KHz SWT:Auto</p>	<p style="text-align: center;">Left blank</p>
Avg.		

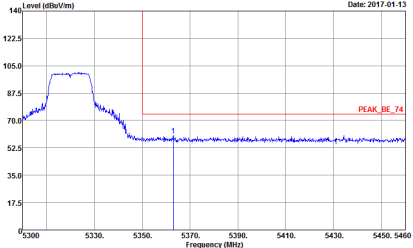
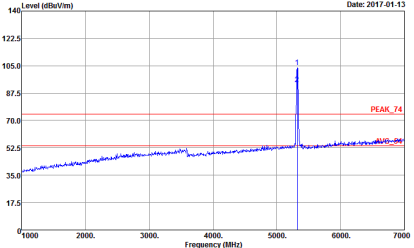
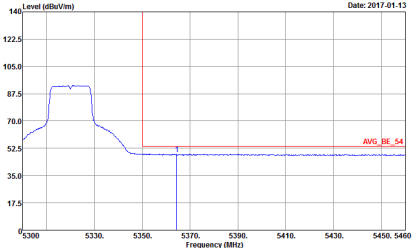

WIFI	Band 2 5250~5350MHz Band Edge @ 3m	
ANT	802.11a CH64 5320MHz	
<p style="text-align: center;">1</p>	<p style="text-align: center;">Vertical</p>  <p style="font-size: small;">Date: 2017-01-13</p> <p style="font-size: x-small;">Site Condition : 03CH12-HY : PEAK_BE_74 3m HORN_9120D_1328 VERTICAL : RBW:1000.000KHz VBW:3000.000KHz SWT:Auto</p>	<p style="text-align: center;">Fundamental</p>  <p style="font-size: small;">Date: 2017-01-13</p> <p style="font-size: x-small;">Site Condition : 03CH12-HY : PEAK_74 3m HORN_9120D_1328 VERTICAL : RBW:1000.000KHz VBW:3000.000KHz SWT:Auto</p>
<p style="text-align: center;">Peak</p>	 <p style="font-size: small;">Date: 2017-01-13</p> <p style="font-size: x-small;">Site Condition : 03CH12-HY : AVG_BE_54 3m HORN_9120D_1328 VERTICAL : RBW:1000.000KHz VBW:1.000KHz SWT:Auto</p>	<p style="text-align: center;">Left blank</p>
<p style="text-align: center;">Avg.</p>		

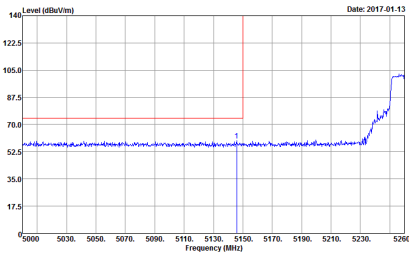
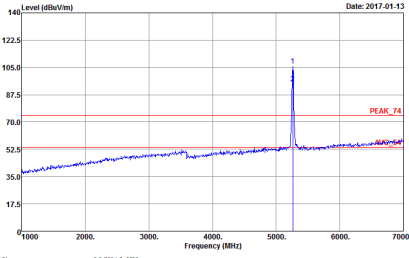
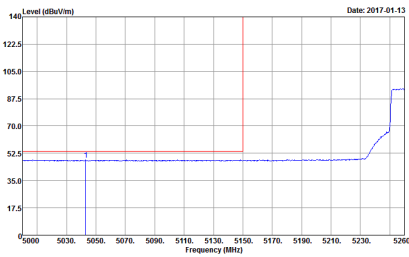

Band 2 5250~5350MHz
WIFI 802.11n HT20 (Band Edge @ 3m)

WIFI	Band 2 5250~5350MHz Band Edge @ 3m	
ANT	802.11n HT20 CH52 5260MHz - L	
1	Horizontal	Fundamental
<p>Peak</p>	 <p>Site Condition : 03CH12-HY : PEAK_BE_74 3m HORN_9120D_1328 HORIZONTAL : RBW:1000.000KHz VBW:3000.000KHz SWT:Auto</p>	 <p>Site Condition : 03CH12-HY : PEAK_74 3m HORN_9120D_1328 HORIZONTAL : RBW:1000.000KHz VBW:3000.000KHz SWT:Auto</p> <p align="right">3</p>
<p>Avg.</p>	 <p>Site Condition : 03CH12-HY : AVG_BE_54 3m HORN_9120D_1328 HORIZONTAL : RBW:1000.000KHz VBW:1.000KHz SWT:Auto</p>	<p align="center">Left blank</p>



WIFI	Band 2 5250~5350MHz Band Edge @ 3m	
ANT	802.11n HT20 CH52 5260MHz - R	
1	Horizontal	Fundamental
Peak	<p>Site : 03CH12-HY Condition : :PEAK_BE_74 3m HORN_9120D_1328 HORIZONTAL :RBW:1000.000KHz VBW:3000.000KHz SWT:Auto</p>	Left blank
Avg.	<p>Site : 03CH12-HY Condition : :AVG_BE_54 3m HORN_9120D_1328 HORIZONTAL :RBW:1000.000KHz VBW:1.000KHz SWT:Auto</p>	Left blank

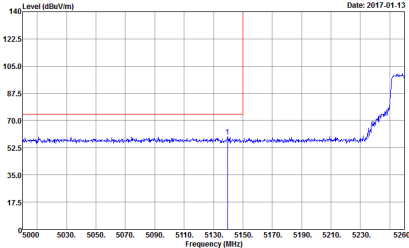
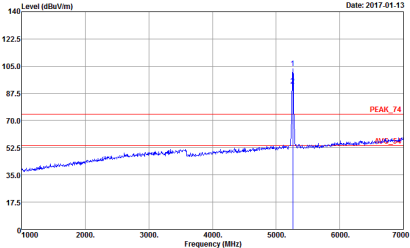
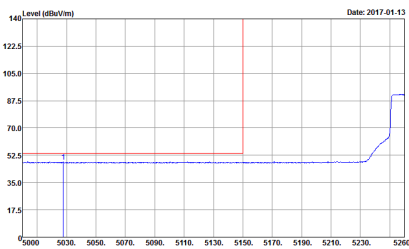

WIFI	Band 2 5250~5350MHz Band Edge @ 3m	
ANT	802.11n HT20 CH52 5260MHz - L	
1	<p style="text-align: center;">Vertical</p>  <p style="text-align: right;">Date: 2017-01-13</p> <p>Site Condition : 03CH12-HY : PEAK_BE_74 3m HORN_9120D_1328 VERTICAL : RBW:1000.000KHz VBW:3000.000KHz SWT:Auto</p>	<p style="text-align: center;">Fundamental</p>  <p style="text-align: right;">Date: 2017-01-13</p> <p>Site Condition : 03CH12-HY : PEAK_74 3m HORN_9120D_1328 VERTICAL : RBW:1000.000KHz VBW:3000.000KHz SWT:Auto</p>
Peak	<p style="text-align: center;">Avg.</p>  <p style="text-align: right;">Date: 2017-01-13</p> <p>Site Condition : 03CH12-HY : AVG_BE_54 3m HORN_9120D_1328 VERTICAL : RBW:1000.000KHz VBW:1.000KHz SWT:Auto</p>	Left blank

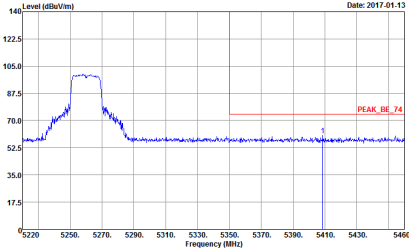
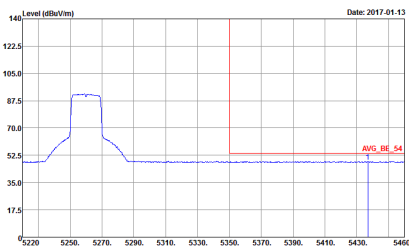

WIFI	Band 2 5250~5350MHz Band Edge @ 3m	
ANT	802.11n HT20 CH52 5260MHz - R	
1	Vertical	Fundamental
Peak	 <p>Date: 2017.01.13</p> <p>Site : 03CH12-HY Condition : : PEAK_BE_74 3m HORN_9120D_132B VERTICAL : RBW:1000.000KHz VBW:3000.000KHz SWT:Auto</p>	Left blank
Avg.	 <p>Date: 2017.01.13</p> <p>Site : 03CH12-HY Condition : : AVG_BE_54 3m HORN_9120D_132B VERTICAL : RBW:1000.000KHz VBW:1.000KHz SWT:Auto</p>	Left blank

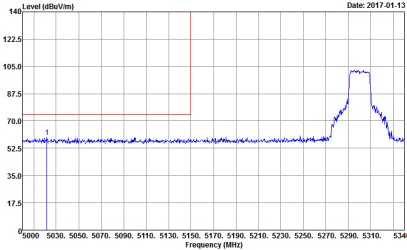
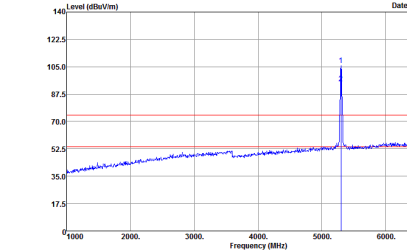
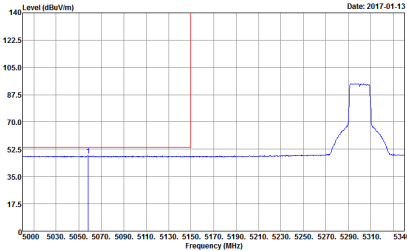

WIFI	Band 2 5250~5350MHz Band Edge @ 3m	
ANT	802.11n HT20 CH60 5300MHz - L	
1	Horizontal	Fundamental
Peak	 <p>Site Condition : 03CH12-HY : PEAK_BE_74 3m HORN_9120D_1328 HORIZONTAL</p>	 <p>Site Condition : 03CH12-HY : PEAK_74 3m HORN_9120D_1328 HORIZONTAL</p>
Avg.	 <p>Site Condition : 03CH12-HY : AVG_BE_54 3m HORN_9120D_1328 HORIZONTAL</p>	Left blank



WIFI	Band 2 5250~5350MHz Band Edge @ 3m	
ANT	802.11n HT20 CH60 5300MHz - R	
1	Horizontal	Vertical
<p>Peak</p>	<p>Site : 03CH12-HY Condition : :PEAK_BE_74 3m HORN_9120D_1328 HORIZONTAL :RBW:1000.000kHz VBW:3000.000kHz SWT-Auto</p>	<p>Left blank</p>
<p>Avg.</p>	<p>Site : 03CH12-HY Condition : :AVG_BE_54 3m HORN_9120D_1328 HORIZONTAL :RBW:1000.000kHz VBW:1.000kHz SWT-Auto</p>	<p>Left blank</p>



WIFI	Band 2 5250~5350MHz Band Edge @ 3m	
ANT	802.11n HT20 CH60 5300MHz - L	
1	Vertical	Fundamental
Peak	<p>Date: 2017-01-13</p> <p>Site : 03CH12-HY Condition : PEAK_BE_74 3m HORN_9120D_1328 VERTICAL</p>	<p>Date: 2017-01-13</p> <p>Site : 03CH12-HY Condition : PEAK_74 3m HORN_9120D_1328 VERTICAL</p>
Avg.	<p>Date: 2017-01-13</p> <p>Site : 03CH12-HY Condition : AVG_BE_54 3m HORN_9120D_1328 VERTICAL</p>	Left blank



WIFI	Band 2 5250~5350MHz Band Edge @ 3m	
ANT	802.11n HT20 CH60 5300MHz - R	
<p>1</p> <p>Vertical</p> <p>Peak</p>	<p>Date: 2017.01.13</p> <p>Site : 03CH12-HY Condition : PEAK_BE_74 3m HORN_9120D_132B VERTICAL : RBW:1000.000KHz VBW:3000.000KHz SWT:Auto</p>	<p>Fundamental</p> <p>Left blank</p>
<p>Avg.</p>	<p>Date: 2017.01.13</p> <p>Site : 03CH12-HY Condition : AVG_BE_54 3m HORN_9120D_132B VERTICAL : RBW:1000.000KHz VBW:1.000KHz SWT:Auto</p>	<p>Left blank</p>

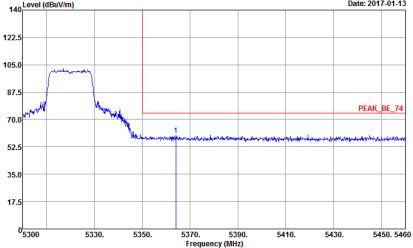
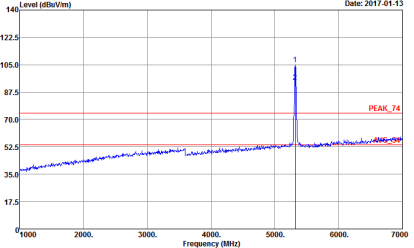
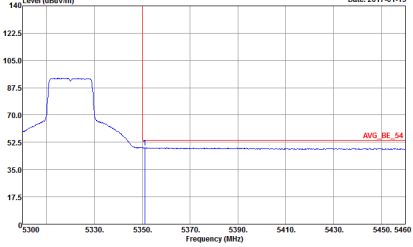

WIFI	Band 2 5250~5350MHz Band Edge @ 3m	
ANT	802.11n HT20 CH64 5320MHz	
1	<p style="text-align: center;">Horizontal</p>  <p>Site Condition : 03CH12-HY : PEAK_BE_74 3m HORN_9120D_1328 HORIZONTAL : RBW:1000.000KHz VBW:3000.000KHz SWT:Auto</p>	<p style="text-align: center;">Fundamental</p>  <p>Site Condition : 03CH12-HY : PEAK_74 3m HORN_9120D_1328 HORIZONTAL : RBW:1000.000KHz VBW:3000.000KHz SWT:Auto</p>
Peak	 <p>Site Condition : 03CH12-HY : AVG_BE_54 3m HORN_9120D_1328 HORIZONTAL : RBW:1000.000KHz VBW:1.000KHz SWT:Auto</p>	<p style="text-align: center;">Left blank</p>
Avg.		

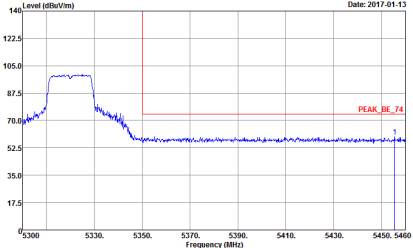
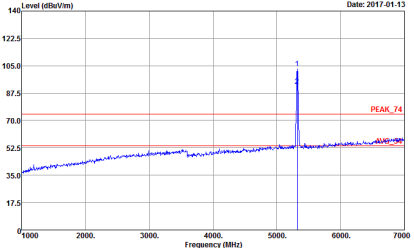
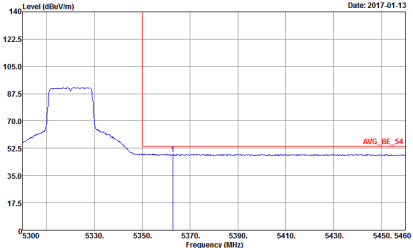

WIFI	Band 2 5250~5350MHz Band Edge @ 3m	
ANT	802.11n HT20 CH64 5320MHz	
<p style="text-align: center;">1</p>	<p style="text-align: center;">Vertical</p>  <p style="text-align: center;">Peak</p> <p>Site Condition : 03CH12-HY : PEAK_BE_74 3m HORN_9120D_1328 VERTICAL : RBW:1000.000KHz VBW:3000.000KHz SWT:Auto</p>	<p style="text-align: center;">Fundamental</p>  <p style="text-align: center;">Peak</p> <p>Site Condition : 03CH12-HY : PEAK_74 3m HORN_9120D_1328 VERTICAL : RBW:1000.000KHz VBW:3000.000KHz SWT:Auto</p>
<p style="text-align: center;">Avg.</p>	 <p style="text-align: center;">Avg.</p> <p>Site Condition : 03CH12-HY : AVG_BE_54 3m HORN_9120D_1328 VERTICAL : RBW:1000.000KHz VBW:1.000KHz SWT:Auto</p>	<p style="text-align: center;">Left blank</p>

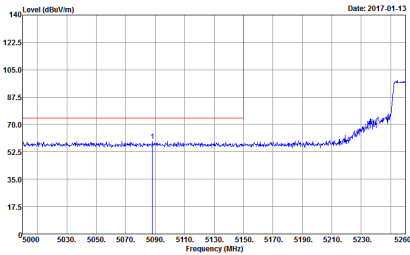
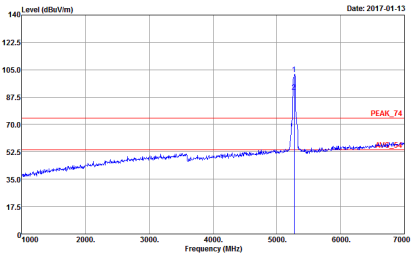
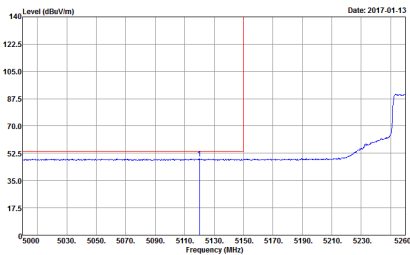

Band 2 5250~5350MHz
WIFI 802.11n HT40 (Band Edge @ 3m)

WIFI	Band 2 5250~5350MHz Band Edge @ 3m	
ANT	802.11n HT40 CH54 5270 MHz - L	
1	Horizontal	Fundamental
<p>Peak</p>	 <p>Site Condition : :03CH12-HY :PEAK_BE_74 3m HORN_9120D_1328 HORIZONTAL :RBW:1000.000kHz VBW:3000.000kHz SWT:Auto</p>	 <p>Site Condition : :03CH12-HY :PEAK_74 3m HORN_9120D_1328 HORIZONTAL :RBW:1000.000kHz VBW:3000.000kHz SWT:Auto</p>
<p>Avg.</p>	 <p>Site Condition : :03CH12-HY :AVG_BE_54 3m HORN_9120D_1328 HORIZONTAL :RBW:1000.000kHz VBW:3.000kHz SWT:Auto</p>	<p align="center">Left blank</p>



WIFI	Band 2 5250~5350MHz Band Edge @ 3m	
ANT	802.11n HT40 CH54 5270 MHz - R	
1	Horizontal	Fundamental
Peak	<p>Date: 2017.01.13</p> <p>Site : 03CH12-HY Condition : :PEAK_BE_74 3m HORN_9120D_1328 HORIZONTAL :RBW:1000.000KHz VBW:3000.000KHz SWT:Auto</p>	Left blank
Avg.	<p>Date: 2017.01.13</p> <p>Site : 03CH12-HY Condition : :AVG_BE_54 3m HORN_9120D_1328 HORIZONTAL :RBW:1000.000KHz VBW:3.000KHz SWT:Auto</p>	Left blank

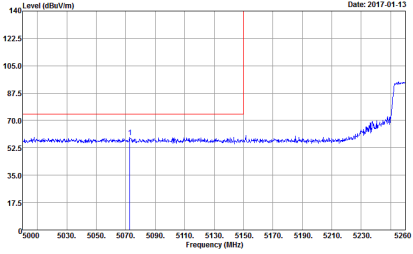
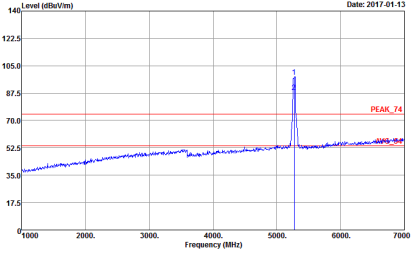
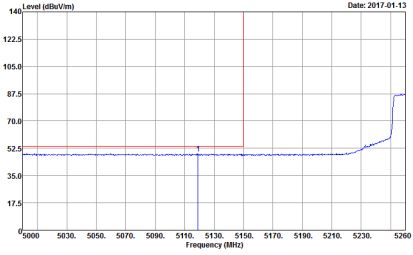

WIFI	Band 2 5250~5350MHz Band Edge @ 3m	
ANT	802.11n HT40 CH54 5270 MHz - L	
1	<p style="text-align: center;">Vertical</p>  <p>Site : 03CH12-HY Condition : PEAK_BE_74 3m HORN_9120D_1328 VERTICAL : RBW:1000.000KHz VBW:3000.000KHz SWT:Auto</p>	<p style="text-align: center;">Vertical</p>  <p>Site : 03CH12-HY Condition : PEAK_74 3m HORN_9120D_1328 VERTICAL : RBW:1000.000KHz VBW:3000.000KHz SWT:Auto</p>
Avg.	 <p>Site : 03CH12-HY Condition : AVG_BE_54 3m HORN_9120D_1328 VERTICAL : RBW:1000.000KHz VBW:3.000KHz SWT:Auto</p>	Left blank



WIFI	Band 2 5250~5350MHz Band Edge @ 3m	
ANT	802.11n HT40 CH54 5270 MHz - R	
<p>1</p> <p>Vertical</p> <p>Peak</p>	<p>Date: 2017.01.13</p> <p>Site : 03CH12-HY Condition : : PEAK_BE_74 3m HORN_9120D_132B VERTICAL : RBW:1000.000KHz VBW:3000.000KHz SWT:Auto</p>	<p>Vertical</p> <p>Left blank</p>
<p>Avg.</p>	<p>Date: 2017.01.13</p> <p>Site : 03CH12-HY Condition : : AVG_BE_54 3m HORN_9120D_132B VERTICAL : RBW:1000.000KHz VBW:3.000KHz SWT:Auto</p>	<p>Left blank</p>

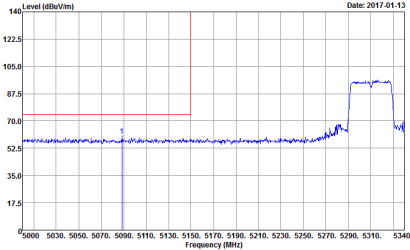
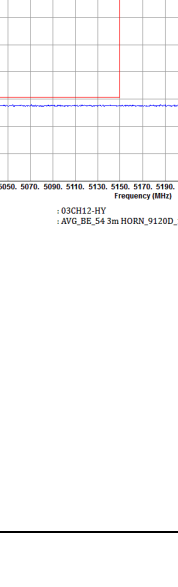
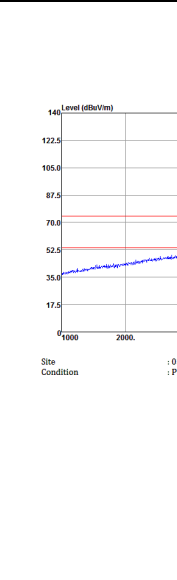

WIFI	Band 2 5250~5350MHz Band Edge @ 3m	
ANT	802.11n HT40 CH62 5310 MHz - L	
1	Horizontal	Fundamental
Peak	 <p>Date: 2017-01-13</p> <p>Site : 03CH12-HY Condition : PEAK_BE_74 3m HORN_9120D_1328 HORIZONTAL</p>	 <p>Date: 2017-01-13</p> <p>Site : 03CH12-HY Condition : PEAK_74 3m HORN_9120D_1328 HORIZONTAL</p>
Avg.	 <p>Date: 2017-01-13</p> <p>Site : 03CH12-HY Condition : AVG_BE_54 3m HORN_9120D_1328 HORIZONTAL</p>	Left blank



WIFI	Band 2 5250~5350MHz Band Edge @ 3m	
ANT	802.11n HT40 CH62 5310 MHz - R	
1	Horizontal	Fundamental
Peak	<p>Site : 03CH12-HY Condition : PEAK_BE_74 3m HORN_9120D_1328 HORIZONTAL : RBW:1000.000KHz VBW:3000.000KHz SWT:Auto</p>	Left blank
Avg.	<p>Site : 03CH12-HY Condition : AVG_BE_54 3m HORN_9120D_1328 HORIZONTAL : RBW:1000.000KHz VBW:3.000KHz SWT:Auto</p>	Left blank



WIFI	Band 2 5250~5350MHz Band Edge @ 3m	
ANT	802.11n HT40 CH62 5310 MHz - L	
1	Vertical	Fundamental
Peak	<p>Date: 2017-01-13</p> <p>Site : 03CH12-HY Condition : PEAK_BE_74 3m HORN_9120D_1328 VERTICAL</p>	<p>Date: 2017-01-13</p> <p>Site : 03CH12-HY Condition : PEAK_74 3m HORN_9120D_1328 VERTICAL</p>
Avg.	<p>Date: 2017-01-13</p> <p>Site : 03CH12-HY Condition : AVG_BE_54 3m HORN_9120D_1328 VERTICAL</p>	Left blank



WIFI	Band 2 5250~5350MHz Band Edge @ 3m	
ANT	802.11n HT40 CH62 5310 MHz - R	
<p style="text-align: center;">1</p>	<p style="text-align: center;">Vertical</p>	<p style="text-align: center;">Fundamental</p>
<p style="text-align: center;">Peak</p>	<p style="font-size: small;">Date: 2017.01.13 Site : 03CH12-HY Condition : PEAK_BE_74 3m HORN_9120D_1328 VERTICAL : RBW:1000.000KHz VBW:3000.000KHz SWT:Auto</p>	<p style="text-align: center;">Left blank</p>
<p style="text-align: center;">Avg.</p>	<p style="font-size: small;">Date: 2017.01.13 Site : 03CH12-HY Condition : AVG_BE_54 3m HORN_9120D_1328 VERTICAL : RBW:1000.000KHz VBW:3.000KHz SWT:Auto</p>	<p style="text-align: center;">Left blank</p>



Band 2 - 5250~5350MHz

WIFI 802.11a (Harmonic @ 3m)

WIFI	Band 2 5250~5350MHz Harmonic @ 3m	
ANT	802.11a CH52 5260MHz	
1	Horizontal	Vertical
<p>Peak</p> <p>Avg.</p>	<p>Site : 03CH12-HY Condition : PEAK(UNI) 3m HORN_9120D_1328 HORIZONTAL Detector : Peak</p>	<p>Site : 03CH12-HY Condition : PEAK(UNI) 3m HORN_9120D_1328 VERTICAL Detector : Peak</p>



WIFI	Band 2 5250~5350MHz Harmonic @ 3m	
ANT	802.11a CH60 5300MHz	
1	Horizontal	Vertical
Peak Avg.	<p>Site : 03CH12-HY Condition : PEAK(UNIT) 3m HORN_9120D_1328 HORIZONTAL Detector : Peak</p>	<p>Site : 03CH12-HY Condition : PEAK(UNIT) 3m HORN_9120D_1328 VERTICAL Detector : Peak</p>



WIFI	Band 2 5250~5350MHz Harmonic @ 3m	
ANT	802.11a CH64 5320MHz	
1	Horizontal	Vertical
<p>Peak Avg.</p>	<p>Site : 03CH12-HY Condition : PEAK(UNIT) 3m HORN_9120D_1328 HORIZONTAL Detector : Peak</p>	<p>Site : 03CH12-HY Condition : PEAK(UNIT) 3m HORN_9120D_1328 VERTICAL Detector : Peak</p>



Band 2 5250~5350MHz
WIFI 802.11n HT20 (Harmonic @ 3m)

WIFI	Band 2 5250~5350MHz Harmonic @ 3m	
ANT	802.11n HT20 CH52 5260MHz	
1	Horizontal	Vertical
<p>Peak</p> <p>Avg.</p>		



WIFI	Band 2 5250~5350MHz Harmonic @ 3m	
ANT	802.11n HT20 CH60 5300MHz	
1	Horizontal	Vertical
Peak Avg.	<p>Horizontal spectrum plot showing Level (dBuV/m) vs Frequency (MHz). The plot displays a series of peaks across the frequency range from 0 to 40000 MHz. Three specific peaks are highlighted with blue vertical lines and labeled 1, 2, and 3. The peak levels are approximately 70 dBuV/m. The plot also shows a red line for the average level (AVG_54) and a red line for the peak level (PEAK(UNII)).</p> <p>Site : 03CH12-HY Condition : PEAK(UNII) 3m HORN_9120D_1328 HORIZONTAL Detector : Peak</p>	<p>Vertical spectrum plot showing Level (dBuV/m) vs Frequency (MHz). The plot displays a series of peaks across the frequency range from 0 to 40000 MHz. Three specific peaks are highlighted with blue vertical lines and labeled 1, 2, and 3. The peak levels are approximately 70 dBuV/m. The plot also shows a red line for the average level (AVG_54) and a red line for the peak level (PEAK(UNII)).</p> <p>Site : 03CH12-HY Condition : PEAK(UNII) 3m HORN_9120D_1328 VERTICAL Detector : Peak</p>



WIFI	Band 2 5250~5350MHz Harmonic @ 3m	
ANT	802.11n HT20 CH64 5320MHz	
1	Horizontal	Vertical
<p>Peak</p> <p>Avg.</p>	<p>Site : 03CH12-HY Condition : PEAK(UNII) 3m HORN_9120D_1328 HORIZONTAL Detector : Peak</p>	<p>Site : 03CH12-HY Condition : PEAK(UNII) 3m HORN_9120D_1328 VERTICAL Detector : Peak</p>

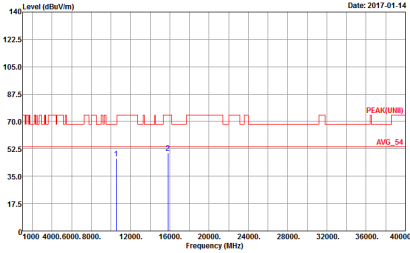
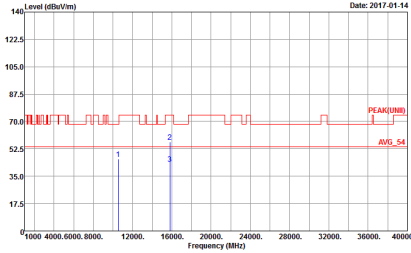

Band 2 5250~5350MHz
WIFI 802.11n HT40 (Harmonic @ 3m)

WIFI	Band 2 5250~5350MHz Harmonic @ 3m	
ANT	802.11n HT40 CH54 5270	
1	Horizontal	Vertical
<p>Peak</p> <p>Avg.</p>	 <p>Site : 03CH12-HY Condition : PEAK(UNI) 3m HORN_9120D_1328 HORIZONTAL Detector : Peak</p>	 <p>Site : 03CH12-HY Condition : PEAK(UNI) 3m HORN_9120D_1328 VERTICAL Detector : Peak</p>



WIFI	Band 2 5250~5350MHz Harmonic @ 3m	
ANT	802.11n HT40 CH62 5310	
1	Horizontal	Vertical
Peak Avg.	<p>Site : 03CH12-HY Condition : PEAK(UNIT) 3m HORN_9120D_1328 HORIZONTAL Detector : Peak</p>	<p>Site : 03CH12-HY Condition : PEAK(UNIT) 3m HORN_9120D_1328 VERTICAL Detector : Peak</p>



Band 3 - 5470~5725MHz

WIFI 802.11a (Band Edge @ 3m)

WIFI	Band 3 5470~5725MHz Band Edge @ 3m	
ANT	802.11a CH100 5500MHz	
1	Horizontal	Fundamental
Peak	<p>Date: 2017-01-14</p> <p>Site Condition : 03CH12-HY : PEAK_BE(UNIT), B3 3m HORN, 9120D_1328 HORIZONTAL : RBW:1000.000kHz VBW:3000.000kHz SWT:Auto</p>	<p>Date: 2017-01-12</p> <p>Site Condition : 03CH12-HY : PEAK(UNIT) 3m HORN, 9120D_1328 HORIZONTAL : RBW:1000.000kHz VBW:3000.000kHz SWT:Auto</p>
Avg.	<p>Date: 2017-01-14</p> <p>Site Condition : 03CH12-HY : AVG_BE(UNIT), B3 3m HORN, 9120D_1328 HORIZONTAL : RBW:1000.000kHz VBW:1.000kHz SWT:Auto</p>	Left blank

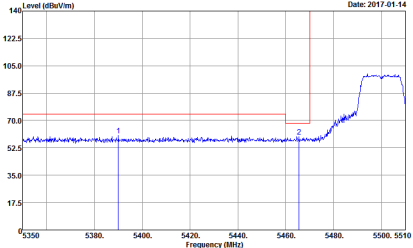
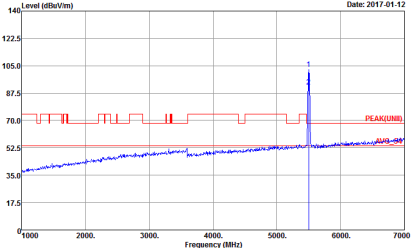
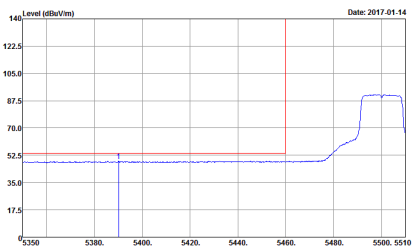

WIFI	Band 3 5470~5725MHz Band Edge @ 3m	
ANT	802.11a CH100 5500MHz	
<p>1</p> <p>Vertical</p> <p>Peak</p>	 <p>Date: 2017-01-14</p> <p>Site Condition : 03CH12-HY : PEAK_BE(UNII)_B3 3m HORN_9120D_1328 VERTICAL : RBW:1000.000KHz VBW:3000.000KHz SWT:Auto</p>	<p>Fundamental</p>  <p>Date: 2017-01-12</p> <p>Site Condition : 03CH12-HY : PEAK(UNII) 3m HORN_9120D_1328 VERTICAL : RBW:1000.000KHz VBW:3000.000KHz SWT:Auto</p>
<p>Avg.</p>	 <p>Date: 2017-01-14</p> <p>Site Condition : 03CH12-HY : AVG_BE(UNII)_B3 3m HORN_9120D_1328 VERTICAL : RBW:1000.000KHz VBW:1.000KHz SWT:Auto</p>	<p>Left blank</p>

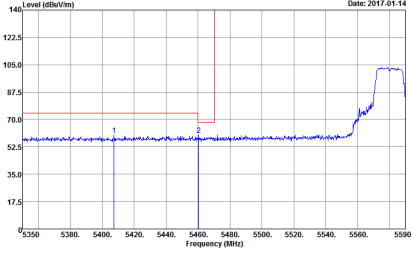
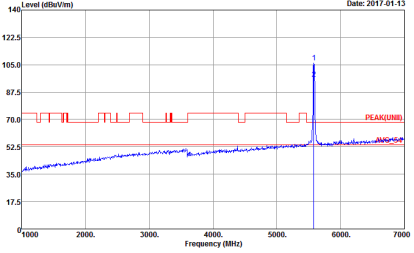
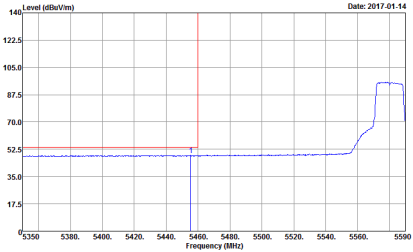

WIFI	Band 3 5470~5725MHz Band Edge @ 3m	
ANT	802.11a CH116 5580MHz - L	
1	<p style="text-align: center;">Horizontal</p>  <p style="font-size: small;">Date: 2017-01-14</p> <p style="font-size: x-small;">Site : 03CH12-HY Condition : :PEAK_SE(UNII)_B3 3m HORN_9120D_1328 HORIZONTAL :RBW:1000.000kHz VBW:3000.000kHz SWT:Auto</p>	<p style="text-align: center;">Fundamental</p>  <p style="font-size: small;">Date: 2017-01-13</p> <p style="font-size: x-small;">Site : 03CH12-HY Condition : :PEAK(UNII) 3m HORN_9120D_1328 HORIZONTAL :RBW:1000.000kHz VBW:3000.000kHz SWT:Auto</p>
Peak	<p style="text-align: center;">Avg.</p>  <p style="font-size: small;">Date: 2017-01-14</p> <p style="font-size: x-small;">Site : 03CH12-HY Condition : :AVG_BE(UNII)_B3 3m HORN_9120D_1328 HORIZONTAL :RBW:1000.000kHz VBW:1.000kHz SWT:Auto</p>	<p style="text-align: center;">Left blank</p>



WIFI	Band 3 5470~5725MHz Band Edge @ 3m	
ANT	802.11a CH116 5580MHz - R	
1	Horizontal	Fundamental
Peak	<p>Site : 03CH12-HY Condition : PEAK_BE(UNI)_B3 3m HORN_9120D_1328 HORIZONTAL</p>	Left blank

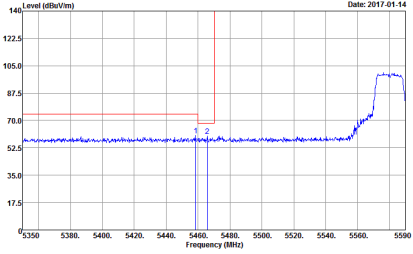
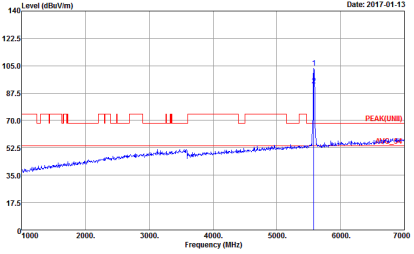
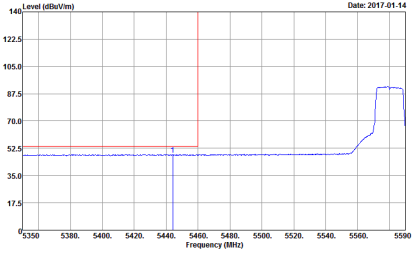

WIFI	Band 3 5470~5725MHz Band Edge @ 3m	
ANT	802.11a CH116 5580MHz - L	
<p>1</p> <p>Vertical</p> <p>Peak</p>	 <p>Date: 2017-01-14</p> <p>Site Condition : 03CH12-HY : PEAK_BE(UNII)_B3 3m HORN_9120D_1328 VERTICAL : RBW:1000.000KHz VBW:3000.000KHz SWT:Auto</p>	<p>Fundamental</p>  <p>Date: 2017-01-13</p> <p>Site Condition : 03CH12-HY : PEAK(UNII) 3m HORN_9120D_1328 VERTICAL : RBW:1000.000KHz VBW:3000.000KHz SWT:Auto</p>
<p>Avg.</p>	 <p>Date: 2017-01-14</p> <p>Site Condition : 03CH12-HY : AVG_BE(UNII)_B3 3m HORN_9120D_1328 VERTICAL : RBW:1000.000KHz VBW:1.000KHz SWT:Auto</p>	<p>Left blank</p>



WIFI	Band 3 5470~5725MHz Band Edge @ 3m	
ANT	802.11a CH116 5580MHz - R	
1	Vertical	Fundamental
Peak	<p>Site: 03CH12-HY Condition: PEAK_BE(UNI)_B3 3m HORN_9120D_1328 VERTICAL</p>	Left blank

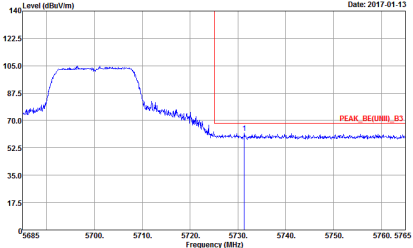
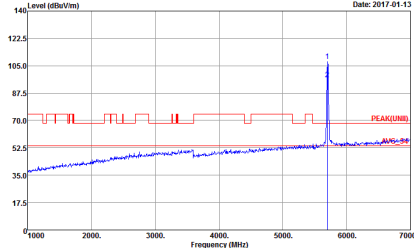

WIFI	Band 3 5470~5725MHz Band Edge @ 3m	
ANT	802.11a CH140 5700MHz	
1	Horizontal	Fundamental
Peak	 <p>Date: 2017-01-13</p> <p>Site : 03CH12-HY Condition : PEAK(SE(UM)), 33 3m HORN, 91200_1328 HORIZONTAL : RBW:1000.000KHz VBW:3000.000KHz SWT:Auto</p>	 <p>Date: 2017-01-13</p> <p>Site : 03CH12-HY Condition : PEAK(UMI) 3m HORN 91200_1328 HORIZONTAL : RBW:1000.000KHz VBW:3000.000KHz SWT:Auto</p>



WIFI	Band 3 5470~5725MHz Band Edge @ 3m	
ANT	802.11a CH140 5700MHz	
1	Vertical	Fundamental
Peak	<p>Site : 03CH12-HY Condition : PEAK (UWB)_03 3m HORN_9130D_1328 VERTICAL : RBW:1000.000KHz VBW:3000.000KHz SWT:Auto</p>	<p>Site : 03CH12-HY Condition : PEAK (UWB) 3m HORN_9130D_1328 VERTICAL : RBW:1000.000KHz VBW:3000.000KHz SWT:Auto</p>

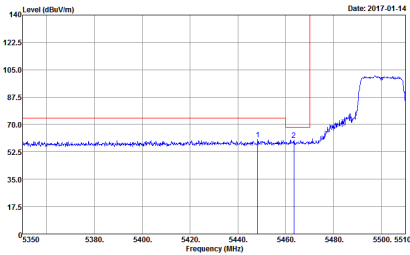
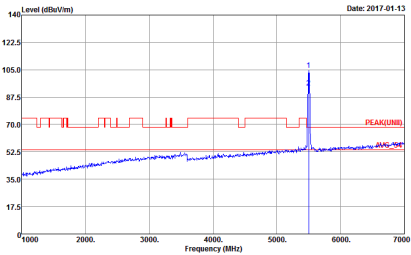
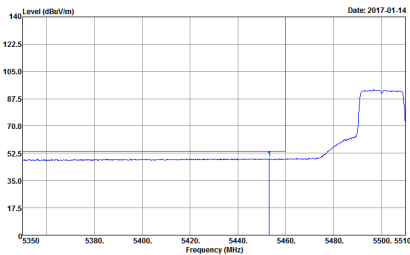

Band 3 5470~5725MHz
WIFI 802.11n HT20 (Band Edge @ 3m)

WIFI	Band 3 5470~5725MHz Band Edge @ 3m	
ANT	802.11n HT20 CH100 5500MHz	
1	Horizontal	Fundamental
<p>Peak</p>	 <p>Date: 2017.01.14</p> <p>Site Condition : :03CH12-HY :PEAK_BE(UNII)_B3 3m HORN_9120D_1328 HORIZONTAL :RBW:1000.000KHz VBW:3000.000KHz SWT:Auto</p>	 <p>Date: 2017.01.13</p> <p>Site Condition : :03CH12-HY :PEAK(UNII) 3m HORN_9120D_1328 HORIZONTAL :RBW:1000.000KHz VBW:3000.000KHz SWT:Auto</p>
<p>Avg.</p>	 <p>Date: 2017.01.14</p> <p>Site Condition : :03CH12-HY :AVG_BE(UNII)_B3 3m HORN_9120D_1328 HORIZONTAL :RBW:1000.000KHz VBW:1.000KHz SWT:Auto</p>	<p align="center">Left blank</p>



WIFI	Band 3 5470~5725MHz Band Edge @ 3m	
ANT	802.11n HT20 CH100 5500MHz	
<p>1</p> <p>Vertical</p> <p>Peak</p>	<p>Date: 2017-01-14</p> <p>Site Condition : 03CH12-HY : PEAK_BE(UNII)_B3 3m HORN_9120D_1328 VERTICAL : RBW:1000.000KHz VBW:3000.000KHz SWT:Auto</p>	<p>Fundamental</p> <p>Date: 2017-01-13</p> <p>Site Condition : 03CH12-HY : PEAK(UNII) 3m HORN_9120D_1328 VERTICAL : RBW:1000.000KHz VBW:3000.000KHz SWT:Auto</p>
<p>Avg.</p>	<p>Date: 2017-01-13</p> <p>Site Condition : 03CH12-HY : AVG_BE(UNII)_B3 3m HORN_9120D_1328 VERTICAL : RBW:1000.000KHz VBW:1.000KHz SWT:Auto</p>	<p>Left blank</p>

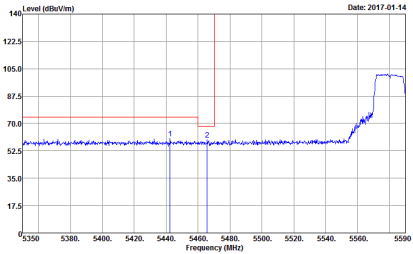
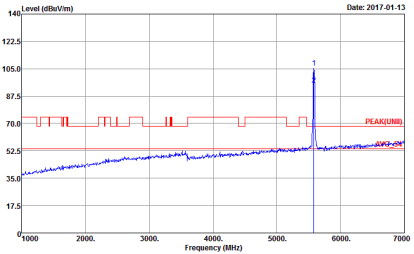
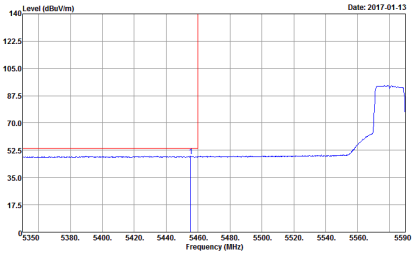

WIFI	Band 3 5470~5725MHz Band Edge @ 3m	
ANT	802.11n HT20 CH116 5580MHz - L	
1	Horizontal	Fundamental
Peak	 <p>Date: 2017-01-14</p> <p>Site : 03CH12-HY Condition : :PEAK_BE(UNII)_B3 3m HORN_9120D_1328 HORIZONTAL :RBW:1000.000KHz VBW:3000.000KHz SWT:Auto</p>	 <p>Date: 2017-01-13</p> <p>Site : 03CH12-HY Condition : :PEAK(UNII) 3m HORN_9120D_1328 HORIZONTAL :RBW:1000.000KHz VBW:3000.000KHz SWT:Auto</p>
Avg.	 <p>Date: 2017-01-13</p> <p>Site : 03CH12-HY Condition : :AVG_BE(UNII)_B3 3m HORN_9120D_1328 HORIZONTAL :RBW:1000.000KHz VBW:1.000KHz SWT:Auto</p>	Left blank



WIFI	Band 3 5470~5725MHz Band Edge @ 3m	
ANT	802.11n HT20 CH116 5580MHz - R	
1	Horizontal	Fundamental
Peak	<p>Site: -03CH12-HY Condition: -PEAK_BE(UNI)_B3 3m HORN_9120D_1328 HORIZONTAL</p>	Left blank



WIFI	Band 3 5470~5725MHz Band Edge @ 3m	
ANT	802.11n HT20 CH116 5580MHz - L	
<p>1</p> <p>Vertical</p> <p>Fundamental</p>	<p>Site Condition : 03CH12-HY : PEAK_BE(UNII)_B3 3m HORN_9120D_1328 VERTICAL : RBW:1000.000KHz VBW:3000.000KHz SWT:Auto</p>	<p>Site Condition : 03CH12-HY : PEAK(UNII) 3m HORN_9120D_1328 VERTICAL : RBW:1000.000KHz VBW:3000.000KHz SWT:Auto</p>
<p>Avg.</p>	<p>Site Condition : 03CH12-HY : AVG_BE(UNII)_B3 3m HORN_9120D_1328 VERTICAL : RBW:1000.000KHz VBW:1.000KHz SWT:Auto</p>	<p>Left blank</p>



WIFI	Band 3 5470~5725MHz Band Edge @ 3m	
ANT	802.11n HT20 CH116 5580MHz - R	
1	Vertical	Fundamental
Peak	<p>Site: 03CH12-HY Condition: PEAK_BE(UNI)_B3 3m HORN_9120D_1328 VERTICAL</p> <p>Date: 2017-01-13</p>	Left blank



WIFI	Band 3 5470~5725MHz Band Edge @ 3m	
ANT	802.11n HT20 CH140 5700MHz	
1	Horizontal	Fundamental
Peak	<p>Date: 2017-01-13</p> <p>Site : 03CH12-HY Condition : PEAK_RE(UM)_B3 3m HORN_9120D_1328 HORIZONTAL : RBW:1000.000KHz VBW:3000.000KHz SWT:Auto</p>	<p>Date: 2017-01-13</p> <p>Site : 03CH12-HY Condition : PEAK(UM)_B3 3m HORN_9120D_1328 HORIZONTAL : RBW:1000.000KHz VBW:3000.000KHz SWT:Auto</p>



WIFI	Band 3 5470~5725MHz Band Edge @ 3m	
ANT	802.11n HT20 CH140 5700MHz	
1	Vertical	Fundamental
Peak.	<p>Site Condition : 03CH12-HY : PEAK_REL(UMD)_B3 3m HORN_9120D_1328 VERTICAL : RBW:1000.000KHz VBW:3000.000KHz SWT:Auto</p>	<p>Site Condition : 03CH12-HY : PEAK(UMD) 3m HORN_9120D_1328 VERTICAL : RBW:1000.000KHz VBW:3000.000KHz SWT:Auto</p>

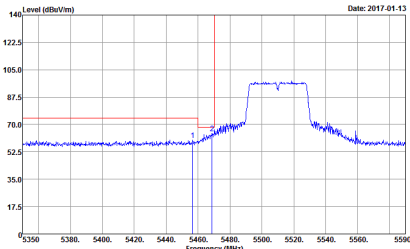
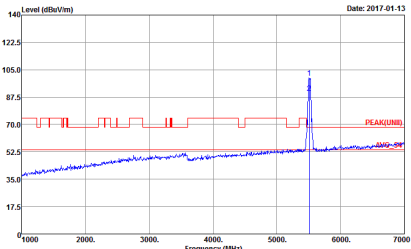
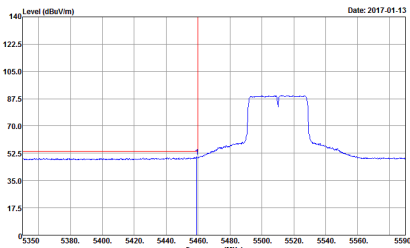

Band 3 5470~5725MHz
WIFI 802.11n HT40 (Band Edge @ 3m)

WIFI	Band 3 5470~5725MHz Band Edge @ 3m	
ANT	802.11n HT40 CH102 5510MHz - L	
1	Horizontal	Fundamental
Peak	 <p>Site Condition : 03CH12-HY : PEAK_BE(UNI)_B3 3m HORN_9120D_1328 HORIZONTAL : RBW:1000.000KHz VBW:3000.000KHz SWT:Auto</p>	 <p>Site Condition : 03CH12-HY : PEAK(UNI) 3m HORN_9120D_1328 HORIZONTAL : RBW:1000.000KHz VBW:3000.000KHz SWT:Auto</p>
Avg.	 <p>Site Condition : 03CH12-HY : AVG_BE(UNI)_B3 3m HORN_9120D_1328 HORIZONTAL : RBW:1000.000KHz VBW:3.000KHz SWT:Auto</p>	Left blank



WIFI	Band 3 5470~5725MHz Band Edge @ 3m	
ANT	802.11n HT40 CH102 5510MHz - R	
1	Horizontal	Fundamental
Peak	<p>Site : 03CH12-HY Condition : PEAK_BE(UNIT)_B3 3m HORN_9120D_1328 HORIZONTAL</p>	Left blank

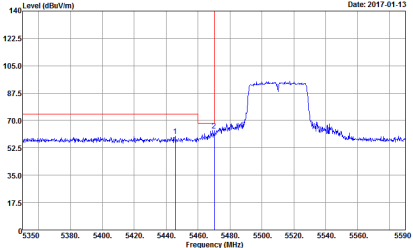
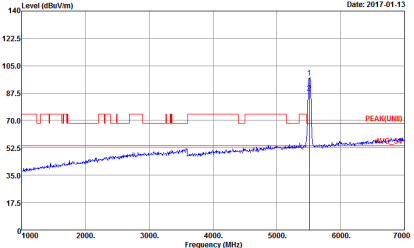
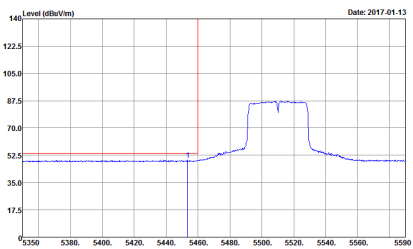

WIFI	Band 3 5470~5725MHz Band Edge @ 3m	
ANT	802.11n HT40 CH102 5510MHz - L	
<p>1</p> <p>Vertical</p> <p>Fundamental</p>	 <p>Level (dBuV/m)</p> <p>Frequency (MHz)</p> <p>Date: 2017-01-13</p> <p>Site Condition : 03CH12-HY : PEAK_BE(UNII)_B3 3m HORN_9120D_1320 VERTICAL : RBW:1000.000KHz VBW:3000.000KHz SWT:Auto</p>	 <p>Level (dBuV/m)</p> <p>Frequency (MHz)</p> <p>Date: 2017-01-13</p> <p>Site Condition : 03CH12-HY : PEAK(UNII) 3m HORN_9120D_1320 VERTICAL : RBW:1000.000KHz VBW:3000.000KHz SWT:Auto</p>
<p>Peak</p>	 <p>Level (dBuV/m)</p> <p>Frequency (MHz)</p> <p>Date: 2017-01-13</p> <p>Site Condition : 03CH12-HY : AVG_BE(UNII)_B3 3m HORN_9120D_1320 VERTICAL : RBW:1000.000KHz VBW:3.000KHz SWT:Auto</p>	<p>Left blank</p>



WIFI	Band 3 5470~5725MHz Band Edge @ 3m	
ANT	802.11n HT40 CH102 5510MHz - R	
1	Vertical	Fundamental
Peak	<p>Site : 03CH12-HY Condition : PEAK_BE(UNIT)_B3 3m HORN_9120D_1328 VERTICAL</p>	Left blank

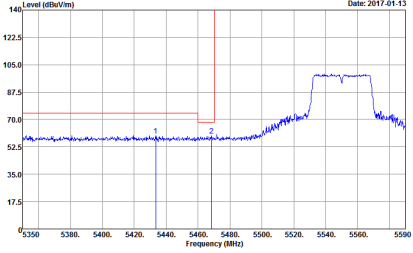
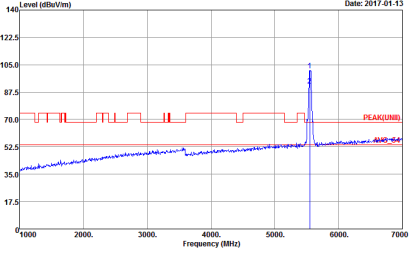
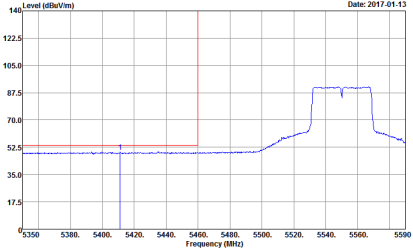

WIFI	Band 3 5470~5725MHz Band Edge @ 3m	
ANT	802.11n HT40 CH110 5550MHz - L	
1	<p style="text-align: center;">Horizontal</p>  <p style="font-size: small;">Date: 2017-01-13 Site : 03CH12-HY Condition : :PEAK_SE(UNII)_B3 3m HORN_9120D_1328 HORIZONTAL :RBW:1000.000kHz VBW:3000.000kHz SWT:Auto</p>	<p style="text-align: center;">Fundamental</p>  <p style="font-size: small;">Date: 2017-01-13 Site : 03CH12-HY Condition : :PEAK(UNII)_3m HORN_9120D_1328 HORIZONTAL :RBW:1000.000kHz VBW:3000.000kHz SWT:Auto</p>
Avg.	 <p style="font-size: small;">Date: 2017-01-13 Site : 03CH12-HY Condition : :AVG_BE(UNII)_B3 3m HORN_9120D_1328 HORIZONTAL :RBW:1000.000kHz VBW:3000.000kHz SWT:Auto</p>	<p style="text-align: center;">Left blank</p>



WIFI	Band 3 5470~5725MHz Band Edge @ 3m	
ANT	802.11n HT40 CH110 5550MHz - R	
1	Horizontal	Fundamental
Peak	<p>Site: 03CH12-HY Condition: PEAK_BE(UNII)_B3 3m HORN_9120D_1328 HORIZONTAL</p>	Left blank

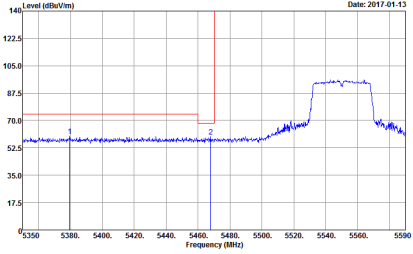
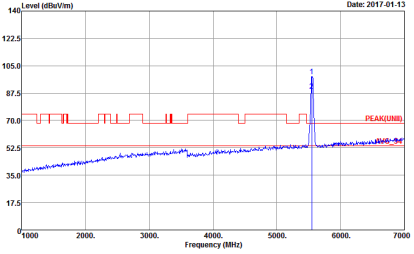
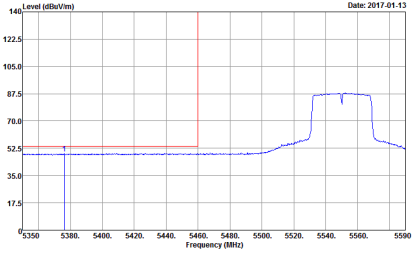

WIFI	Band 3 5470~5725MHz Band Edge @ 3m	
ANT	802.11n HT40 CH110 5550MHz - L	
<p>1</p> <p>Vertical</p> <p>Peak</p>	 <p>Date: 2017-01-13</p> <p>Site Condition : 03CH12-HY : PEAK_BE(UNII)_B3 3m HORN_9120D_1328 VERTICAL : RBW:1000.000KHz VBW:3000.000KHz SWT:Auto</p>	<p>Fundamental</p>  <p>Date: 2017-01-13</p> <p>Site Condition : 03CH12-HY : PEAK(UNII) 3m HORN_9120D_1328 VERTICAL : RBW:1000.000KHz VBW:3000.000KHz SWT:Auto</p>
<p>Avg.</p>	 <p>Date: 2017-01-13</p> <p>Site Condition : 03CH12-HY : AVG_BE(UNII)_B3 3m HORN_9120D_1328 VERTICAL : RBW:1000.000KHz VBW:3.000KHz SWT:Auto</p>	<p>Left blank</p>



WIFI	Band 3 5470~5725MHz Band Edge @ 3m	
ANT	802.11n HT40 CH110 5550MHz - R	
1	Vertical	Fundamental
Peak	<p>Site : :03CH12-HY Condition : :PEAK_BE(UNI)_B3 3m HORN_9120D_1328 VERTICAL</p>	Left blank

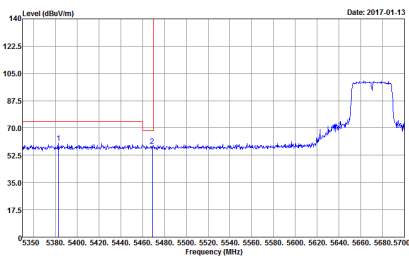
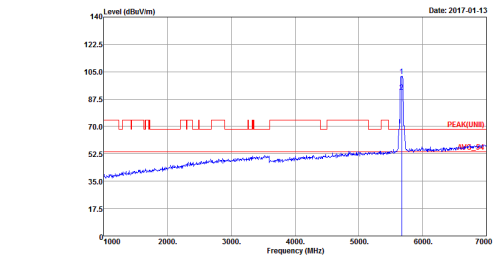
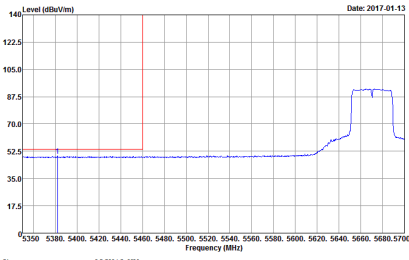

WIFI	Band 3 5470~5725MHz Band Edge @ 3m	
ANT	802.11n HT40 CH134 5670MHz - L	
1	Horizontal	Fundamental
Peak	 <p>Date: 2017-01-13</p> <p>Site Condition : 03CH12-HY : PEAK_BE(UNH)_B3 3m HORN_9120D_1328 HORIZONTAL</p>	 <p>Date: 2017-01-13</p> <p>Site Condition : 03CH12-HY : PEAK(UNH) 3m HORN_9120D_1328 HORIZONTAL : RBW:1000.000kHz VBW:3000.000kHz SWT:Auto</p>
Avg.	 <p>Date: 2017-01-13</p> <p>Site Condition : 03CH12-HY : AVG_BE(UNH)_B3 3m HORN_9120D_1328 HORIZONTAL</p>	Left blank

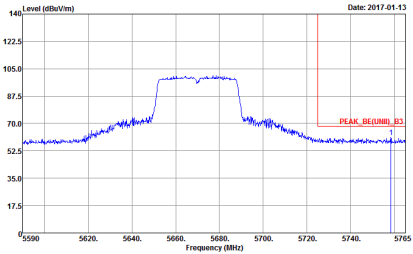

WIFI	Band 3 5470~5725MHz Band Edge @ 3m	
ANT	802.11n HT40 CH134 5670MHz - R	
1	Horizontal	Fundamental
Peak	 <p data-bbox="347 734 762 772">Site : 03CH12-HV Condition : PEAK_BE(UMI)_S3 3m HORN_9130D_1320 HORIZONTAL RBW:1000.000kHz VBW:3000.000kHz SWT:Auto</p>	Left blank

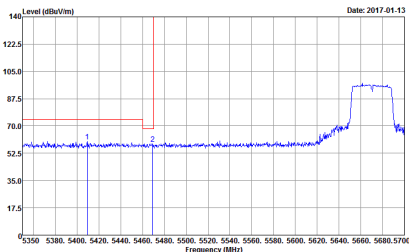
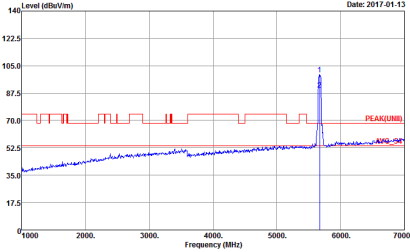
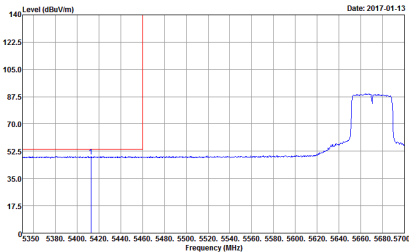

WIFI	Band 3 5470~5725MHz Band Edge @ 3m	
ANT	802.11n HT40 CH134 5670MHz - L	
1	Vertical	Fundamental
Peak	 <p>Date: 2017-01-13</p> <p>Site : 03CH12-HY Condition : :PEAK_BE(UNII)_B3 3m HORN_9120D_1328 VERTICAL</p>	 <p>Date: 2017-01-13</p> <p>Site : 03CH12-HY Condition : :PEAK(UNII) 3m HORN_9120D_1328 VERTICAL : RBW:1000.000kHz VBW:3000.000kHz SWT:Auto</p>
Avg.	 <p>Date: 2017-01-13</p> <p>Site : 03CH12-HY Condition : :AVG_BE(UNII)_B3 3m HORN_9120D_1328 VERTICAL</p>	Left blank



WIFI	Band 3 5470~5725MHz Band Edge @ 3m	
ANT	802.11n HT40 CH134 5670MHz - R	
1	Vertical	Fundamental
Peak	<p>Site : 03CH12-HV Condition : PEAK_BE(UND)_S3 3m HORN_9130D_1320 VERTICAL : RBW:1000.000KHz VBW:3000.000KHz SWT:Auto</p>	Left blank



Band 3 - 5470~5725MHz

WIFI 802.11a (Harmonic @ 3m)

WIFI	Band 3 5470~5725MHz Harmonic @ 3m	
ANT	802.11a CH100 5500MHz	
1	Horizontal	Vertical
<p>Peak</p> <p>Avg.</p>	<p>Site : 03CH12-HY Condition : PEAK(UNIT) 3m HORN_9120D_1328 HORIZONTAL Detector : Peak</p>	<p>Site : 03CH12-HY Condition : PEAK(UNIT) 3m HORN_9120D_1328 VERTICAL Detector : Peak</p>

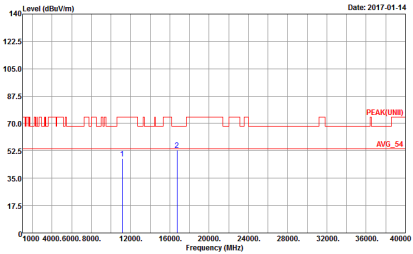
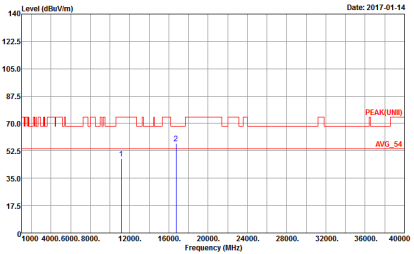

WIFI	Band 3 5470~5725MHz Harmonic @ 3m	
ANT	802.11a CH116 5580MHz	
1	Horizontal	Vertical
<p>Peak Avg.</p>	 <p>Site : 03CH12-HY Condition : PEAK(UNII) 3m HORN_9120D_1328 HORIZONTAL Detector : Peak</p>	 <p>Site : 03CH12-HY Condition : PEAK(UNII) 3m HORN_9120D_1328 VERTICAL Detector : Peak</p>



WIFI	Band 3 5470~5725MHz Harmonic @ 3m	
ANT	802.11a CH140 5700MHz	
1	Horizontal	Vertical
Peak Avg.	<p>Site : 03CH12-HY Condition : PEAK(UNIT) 3m HORN_9120D_1328 HORIZONTAL Detector : Peak</p>	<p>Site : 03CH12-HY Condition : PEAK(UNIT) 3m HORN_9120D_1328 VERTICAL Detector : Peak</p>

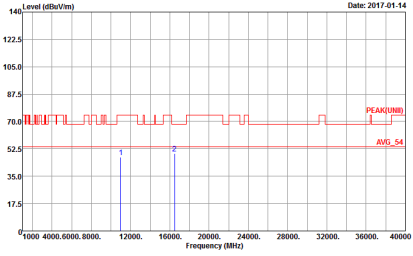
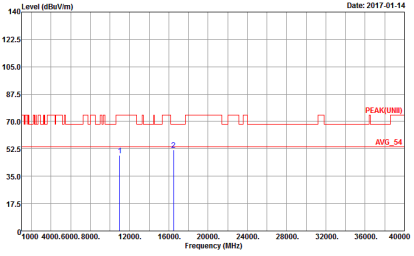

**Band 3 5470~5725MHz
WIFI 802.11n HT20 (Harmonic @ 3m)**

WIFI	Band 3 5470~5725MHz Harmonic @ 3m	
ANT	802.11n HT20 CH100 5500MHz	
1	Horizontal	Vertical
<p>Peak</p> <p>Avg.</p>	 <p>Site : 03CH12-HY Condition : PEAK(UNI) 3m HORN_9120D_1328 HORIZONTAL Detector : Peak</p>	 <p>Site : 03CH12-HY Condition : PEAK(UNI) 3m HORN_9120D_1328 VERTICAL Detector : Peak</p>

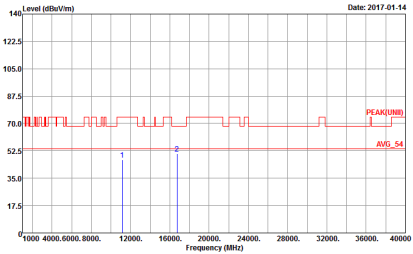
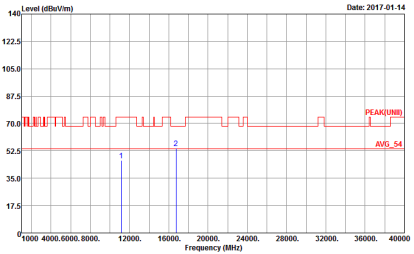

WIFI	Band 3 5470~5725MHz Harmonic @ 3m	
ANT	802.11n HT20 CH116 5580MHz	
1	Horizontal	Vertical
<p>Peak Avg.</p>	 <p>Site : 03CH12-HY Condition : PEAK(UNII) 3m HORN_9120D_1328 HORIZONTAL Detector : Peak</p>	 <p>Site : 03CH12-HY Condition : PEAK(UNII) 3m HORN_9120D_1328 VERTICAL Detector : Peak</p>



WIFI	Band 3 5470~5725MHz Harmonic @ 3m	
ANT	802.11n HT20 CH140 5700MHz	
1	Horizontal	Vertical
Peak Avg.	<p>Horizontal spectrum plot showing Level (dBuV/m) vs Frequency (MHz). The plot includes a red line for the signal level and a blue line for the average level (AVG_54). Two peaks are marked with blue arrows and labeled '1' and '2'. The plot is dated 2017-01-14. The site is 03CH12-HY, the condition is PEAK(UNII) 3m HORN_9120D_1328 HORIZONTAL, and the detector is Peak.</p>	<p>Vertical spectrum plot showing Level (dBuV/m) vs Frequency (MHz). The plot includes a red line for the signal level and a blue line for the average level (AVG_54). Two peaks are marked with blue arrows and labeled '1' and '2'. The plot is dated 2017-01-14. The site is 03CH12-HY, the condition is PEAK(UNII) 3m HORN_9120D_1328 VERTICAL, and the detector is Peak.</p>



Band 3 5470~5725MHz
WIFI 802.11n HT40 (Harmonic @ 3m)

Table with 2 columns: Horizontal and Vertical. Each column contains a graph of Level (dBuV/m) vs Frequency (MHz) with peak and average markers. Includes site and condition details for both orientations.



WIFI	Band 3 5470~5725MHz Harmonic @ 3m	
ANT	802.11n HT40 CH110 5550MHz	
1	Horizontal	Vertical
Peak Avg.	<p>Site : 03CH12-HY Condition : PEAK(UNII) 3m HORN_9120D_1328 HORIZONTAL Detector : Peak</p>	<p>Site : 03CH12-HY Condition : PEAK(UNII) 3m HORN_9120D_1328 VERTICAL Detector : Peak</p>

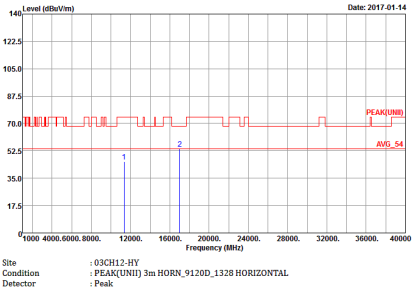
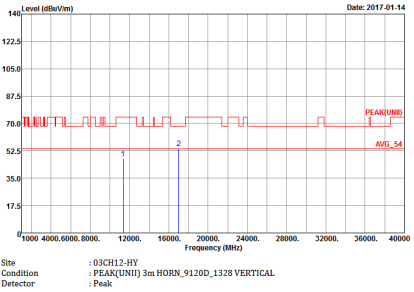

WIFI	Band 3 5470~5725MHz Harmonic @ 3m	
ANT	802.11n HT40 CH134 5670MHz	
1	Horizontal	Vertical
<p>Peak Avg.</p>	 <p>Site : 03CH12-HY Condition : PEAK(UNII) 3m HORN_9120D_1328 HORIZONTAL Detector : Peak</p>	 <p>Site : 03CH12-HY Condition : PEAK(UNII) 3m HORN_9120D_1328 VERTICAL Detector : Peak</p>



Emission below 1GHz

5GHz WIFI 802.11a (LF)

WIFI	5GHz WIFI	
ANT	802.11a LF	
1	Horizontal	Vertical
QP / Peak	<p>Site : 03CH12-HY Condition : QP 3m BIL06_6111D_37059 HORIZONTAL Detector : Peak</p>	<p>Site : 03CH12-HY Condition : QP 3m BIL06_6111D_37059 VERTICAL Detector : Peak</p>



Emission below 1GHz
5GHz WIFI 802.11n HT20 (LF)

WIFI	5GHz WIFI	
ANT	802.11n HT20 LF	
1	Horizontal	Vertical
QP / Peak	<p>Site : 03CH12-HY Condition : QP 3m BIL06_6111D_37059 HORIZONTAL Detector : Peak</p>	<p>Site : 03CH12-HY Condition : QP 3m BIL06_6111D_37059 VERTICAL Detector : Peak</p>



Emission below 1GHz
5GHz WIFI 802.11n HT40 (LF)

WIFI	5GHz WIFI	
ANT	802.11n HT40 LF	
1	Horizontal	Vertical
QP / Peak	<p>Site : 03CH12-HY Condition : QP 3m BIL06_6111D_37059 HORIZONTAL Detector : Peak</p>	<p>Site : 03CH12-HY Condition : QP 3m BIL06_6111D_37059 VERTICAL Detector : Peak</p>

Appendix D Duty Cycle Plots

Band	Duty Cycle(%)	T(us)	1/T(kHz)	VBW Setting
802.11a	97.20	1390	0.72	1kHz
5GHz 802.11n HT20	96.30	1300	0.77	1kHz
5GHz 802.11n HT40	94.74	648	1.54	3kHz

802.11a

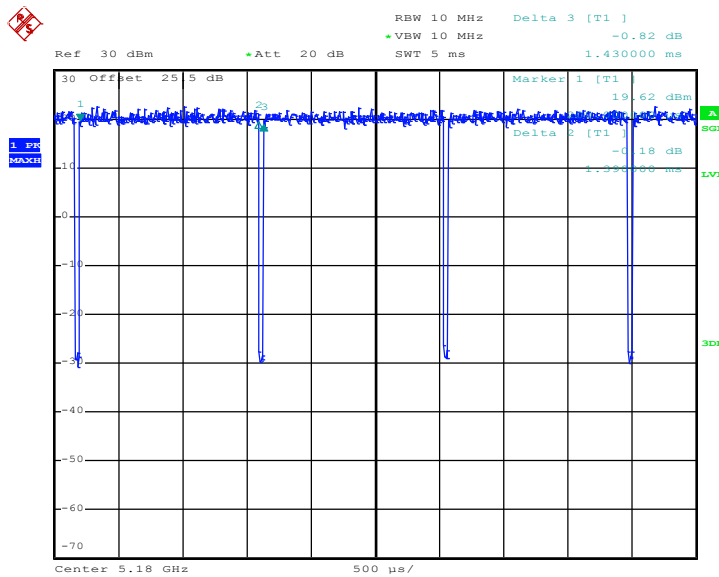

Date: 3.JAN.2017 20:05:11



5GHz 802.11n HT20

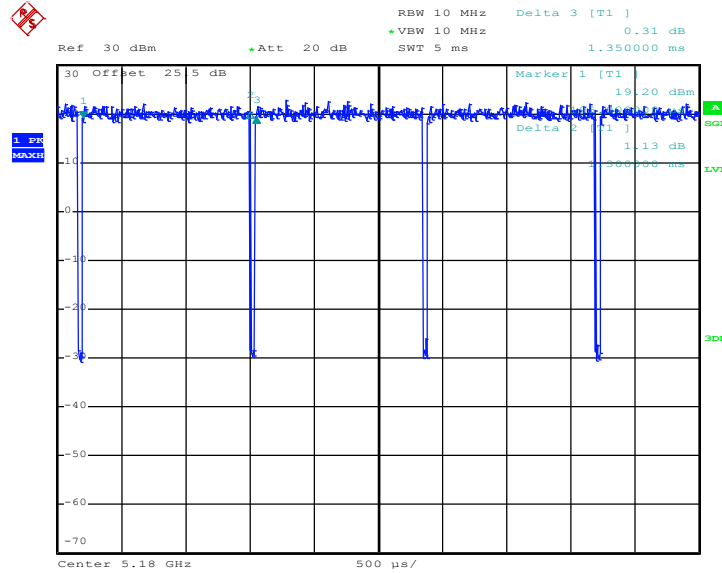

Date: 3.JAN.2017 20:24:43

5GHz 802.11n HT40

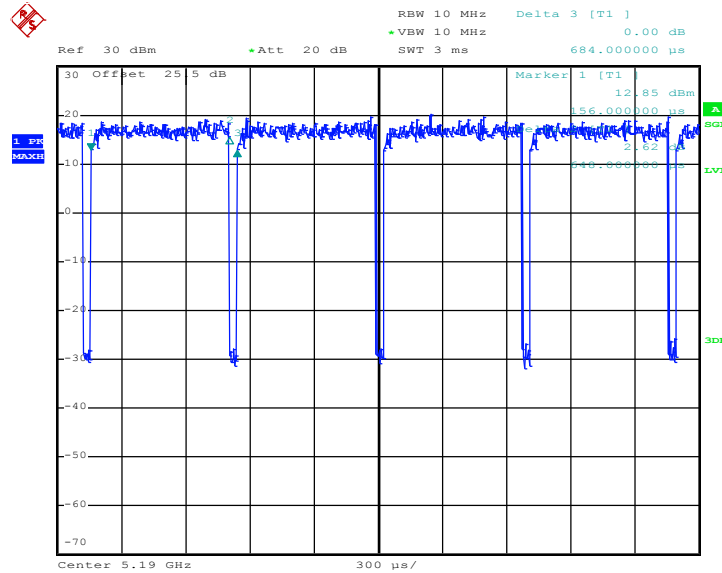

Date: 3.JAN.2017 21:16:59