



# **CERTIFICATION TEST REPORT**

**Report Number. :** 11626381H-E2V2

**Applicant :** SONY MOBILE COMMUNICATIONS, INC.  
4-12-3 HIGASHI-SHINAGAWA,  
SHINAGAWA -KU, TOKYO, 140-0002, JAPAN

**FCC ID :** PY7-54254H

**EUT Description :** GSM/WCDMA/LTE Phone with BT, DTS/UNII a/b/g/n/ac, GPS & NFC

**Test Standard(s) :** FCC 47 CFR PART 15 SUBPART C

**Date Of Issue:**

April 07, 2017

**Prepared by:**

UL Verification Services Inc.  
47173 Benicia Street  
Fremont, CA 94538, U.S.A.  
TEL: (510) 771-1000  
FAX: (510) 661-0888



NVLAP LAB CODE 200065-0

---

Revision History

<u>Rev.</u>	<u>Issue Date</u>	<u>Revisions</u>	<u>Revised By</u>
V1	03/23/2017	Initial Review	C. Vergonio
V2	04/07/2017	Deleted error message in Section 1.	C. Vergonio

## TABLE OF CONTENTS

<b>1. ATTESTATION OF TEST RESULTS</b> .....	<b>5</b>
<b>2. TEST METHODOLOGY</b> .....	<b>6</b>
<b>3. FACILITIES AND ACCREDITATION</b> .....	<b>6</b>
<b>4. CALIBRATION AND UNCERTAINTY</b> .....	<b>7</b>
4.1. <i>MEASURING INSTRUMENT CALIBRATION</i> .....	7
4.1. <i>SAMPLE CALCULATION</i> .....	7
4.2. <i>MEASUREMENT UNCERTAINTY</i> .....	7
<b>5. EQUIPMENT UNDER TEST</b> .....	<b>8</b>
5.1. <i>DESCRIPTION OF EUT</i> .....	8
5.2. <i>MAXIMUM OUTPUT POWER</i> .....	8
5.3. <i>DESCRIPTION OF AVAILABLE ANTENNAS</i> .....	8
5.4. <i>SOFTWARE AND FIRMWARE</i> .....	8
5.5. <i>WORST-CASE CONFIGURATION AND MODE</i> .....	9
5.6. <i>DESCRIPTION OF TEST SETUP</i> .....	10
<b>6. TEST AND MEASUREMENT EQUIPMENT</b> .....	<b>13</b>
<b>7. ANTENNA PORT TEST RESULTS</b> .....	<b>14</b>
7.1. <i>BASIC DATA RATE GFSK MODULATION</i> .....	15
7.1.1. 20 dB AND 99% BANDWIDTH .....	15
7.1.2. HOPPING FREQUENCY SEPARATION .....	18
7.1.3. NUMBER OF HOPPING CHANNELS.....	19
7.1.4. AVERAGE TIME OF OCCUPANCY .....	22
7.1.5. OUTPUT POWER.....	26
7.1.6. AVERAGE POWER .....	28
7.1.7. CONDUCTED BANDEDGE AND SPURIOUS EMISSIONS .....	29
7.2. <i>ENHANCED DATA RATE 8PSK MODULATION</i> .....	33
7.2.1. 20 dB AND 99% BANDWIDTH .....	33
7.2.2. HOPPING FREQUENCY SEPARATION .....	36
7.2.3. NUMBER OF HOPPING CHANNELS.....	37
7.2.4. AVERAGE TIME OF OCCUPANCY .....	40
7.2.5. OUTPUT POWER.....	44
7.2.6. AVERAGE POWER .....	46
7.2.7. CONDUCTED BANDEDGE AND SPURIOUS EMISSIONS .....	47
<b>8. RADIATED TEST RESULTS</b> .....	<b>51</b>

---

8.1.	<i>LIMITS AND PROCEDURE</i>	51
8.2.	<i>BASIC DATA RATE GFSK MODULATION</i>	52
8.2.1.	RESTRICTED BANDEDGE (LOW CHANNEL)	52
8.2.2.	AUTHORIZED BANDEDGE (HIGH CHANNEL)	54
8.2.3.	HARMONICS AND SPURIOUS EMISSIONS	56
8.3.	<i>ENHANCED DATA RATE 8PSK MODULATION</i>	62
8.3.1.	RESTRICTED BANDEDGE (LOW CHANNEL)	62
8.3.2.	AUTHORIZED BANDEDGE (HIGH CHANNEL)	64
8.3.3.	HARMONICS AND SPURIOUS EMISSIONS	66
8.4.	<i>WORST-CASE BELOW 30 MHz</i>	72
8.5.	<i>WORST-CASE BELOW 1 GHz</i>	73
8.6.	<i>WORST-CASE ABOVE 18 GHz</i>	76
<b>9.</b>	<b>AC POWER LINE CONDUCTED EMISSIONS</b>	<b>78</b>
9.1.	<i>EUT POWERED WITH AC/DC ADAPTER &amp; HEADSET</i>	79
<b>10.</b>	<b>SETUP PHOTOS</b>	<b>81</b>

# 1. ATTESTATION OF TEST RESULTS

**COMPANY NAME:** SONY MOBILE COMMUNICATIONS, INC.  
4-12-3 HIGASHI-SHINAGAWA,  
SHINAGAWA -KU, TOKYO, 140-0002, JAPAN

**EUT DESCRIPTION:** GSM/WCDMA/LTE Phone with BT, DTS/UNII a/b/g/n/ac, GPS & NFC

**SERIAL NUMBER:** RADIATED: CB512DQZV2, CB512DQZU5  
CONDUCTED: CB512DHRTV, CB512DHRVC

**DATE TESTED:** MARCH 14, 2017 – MARCH 23, 2017

APPLICABLE STANDARDS	
STANDARD	TEST RESULTS
CFR 47 Part 15 Subpart C	Pass

UL Verification Services Inc. tested the above equipment in accordance with the requirements set forth in the above standards. All indications of Pass/Fail in this report are opinions expressed by UL Verification Services Inc. based on interpretations and/or observations of test results. Measurement Uncertainties were not taken into account and are published for informational purposes only. The test results show that the equipment tested is capable of demonstrating compliance with the requirements as documented in this report.

**Note:** The results documented in this report apply only to the tested sample, under the conditions and modes of operation as described herein. This document may not be altered or revised in any way unless done so by UL Verification Services Inc. and all revisions are duly noted in the revisions section. Any alteration of this document not carried out by UL Verification Services Inc. will constitute fraud and shall nullify the document. This report must not be used by the client to claim product certification, approval, or endorsement by NVLAP, NIST, any agency of the Federal Government, or any agency of any government.

Approved & Released For  
UL Verification Services Inc. By:



CHARLES VERGONIO  
WISE PROJECT LEAD  
UL VERIFICATION SERVICES INC.

Prepared By:



JASON QIAN  
WISE LAB ENGINEER  
UL VERIFICATION SERVICES INC.

## 2. TEST METHODOLOGY

The tests documented in this report were performed in accordance with FCC CFR 47 Part 2, FCC CFR 47 Part 15, ANSI C63.10-2013.

## 3. FACILITIES AND ACCREDITATION

The test sites and measurement facilities used to collect data are located at 47173 and 47266 Benicia Street, Fremont, California, USA. Line conducted emissions are measured only at the 47173 address. The following table identifies which facilities were utilized for radiated emission measurements documented in this report. Specific facilities are also identified in the test results sections.

47173 Benicia Street		47266 Benicia Street	
<input type="checkbox"/>	Chamber A (IC:2324B-1)	<input type="checkbox"/>	Chamber D (IC:2324B-4)
<input checked="" type="checkbox"/>	Chamber B (IC:2324B-2)	<input type="checkbox"/>	Chamber E (IC:2324B-5)
<input checked="" type="checkbox"/>	Chamber C (IC:2324B-3)	<input type="checkbox"/>	Chamber F (IC:2324B-6)
		<input type="checkbox"/>	Chamber G (IC:2324B-7)
		<input type="checkbox"/>	Chamber H (IC:2324B-8)

The above test sites and facilities are covered under FCC Test Firm Registration # 208313.

UL Verification Services Inc. is accredited by NVLAP, Laboratory Code 200065-0. The full scope of accreditation can be viewed at <http://ts.nist.gov/standards/scopes/2000650.htm>.

## 4. CALIBRATION AND UNCERTAINTY

### 4.1. MEASURING INSTRUMENT CALIBRATION

The measuring equipment utilized to perform the tests documented in this report has been calibrated in accordance with the manufacturer's recommendations, and is traceable to recognized national standards.

### 4.1. SAMPLE CALCULATION

Where relevant, the following sample calculation is provided:

$$\begin{aligned} \text{Field Strength (dBuV/m)} &= \text{Measured Voltage (dBuV)} + \text{Antenna Factor (dB/m)} + \\ &\text{Cable Loss (dB)} - \text{Preamp Gain (dB)} \\ 36.5 \text{ dBuV} + 18.7 \text{ dB/m} + 0.6 \text{ dB} - 26.9 \text{ dB} &= 28.9 \text{ dBuV/m} \end{aligned}$$

### 4.2. MEASUREMENT UNCERTAINTY

Where relevant, the following measurement uncertainty levels have been estimated for tests performed on the apparatus:

Parameter	Uncertainty
Worst Case Conducted Disturbance, 9KHz to 0.15 MHz	3.84 dB
Worst Case Conducted Disturbance, 0.15 to 30 MHz	3.65 dB
Worst Case Radiated Disturbance, 9KHz to 30 MHz	3.15 dB
Worst Case Radiated Disturbance, 30 to 1000 MHz	5.36 dB
Worst Case Radiated Disturbance, 1000 to 18000 MHz	4.32 dB
Worst Case Radiated Disturbance, 18000 to 26000 MHz	4.45 dB
Worst Case Radiated Disturbance, 26000 to 40000 MHz	5.24 dB

Uncertainty figures are valid to a confidence level of 95%.

## 5. EQUIPMENT UNDER TEST

### 5.1. DESCRIPTION OF EUT

The EUT is a GSM/WCDMA/LTE Phone with BT, DTS/UNII a/b/g/n/ac, GPS & NFC.

### 5.2. MAXIMUM OUTPUT POWER

The transmitter has a maximum peak conducted output power as follows:

Frequency Range (MHz)	Mode	Output Power (dBm)	Output Power (mW)
2402 - 2480	Basic GFSK	11.84	15.28
2402 - 2480	Enhanced 8PSK	11.24	13.30

### 5.3. DESCRIPTION OF AVAILABLE ANTENNAS

The radio utilizes two integrated antennas, with the following maximum gains:

Frequency Band (GHz)	Antenna Gain (dBi)
2402-2480	-5.20

### 5.4. SOFTWARE AND FIRMWARE

The firmware installed in the EUT during testing was SONY, s\_atp\_1\_00067\_A\_9\_4.  
The test utility software used during testing was Tera Term Ver 4.79.



---

## 5.5. WORST-CASE CONFIGURATION AND MODE

Radiated band edge, harmonics, and spurious emissions from 1 GHz to 18GHz were performed with the EUT was set to transmit at the Low/Middle/High channels.

Radiated emission below 30MHz, below 1GHz, above 18GHz, and power line conducted emission were performed with the EUT was set to transmit at the channel with highest output power as worst-case scenario.

The fundamental of the EUT was investigated in three orthogonal orientations X, Y, & Z, and it was determined that Z-Axis orientation was worst-case orientation; therefore, all final radiated testing was performed with the EUT in Z-Axis orientation.

Worst-case data rates were:

GFSK mode: DH5  
8PSK mode: 3-DH5

DQPSK mode has been verified to have the lowest power.

## 5.6. DESCRIPTION OF TEST SETUP

### SUPPORT EQUIPMENT

Support Equipment List				
Description	Manufacturer	Model	Serial Number	FCC ID
Laptop	Lenovo	20B7S0A200	PC015REW	NA
AC Adapter	SONY	1300-7137.1	4016W40310044	NA
Headphones	SONY	N/A	N/A	N/A

### I/O CABLES (CONDUCTED TEST)

I/O Cable List						
Cable No	Port	# of identical ports	Connector Type	Cable Type	Cable Length (m)	Remarks
1	Antenna	1	RF	Shielded	0.2	To spectrum Analyzer
2	USB	1	USB	Shielded	1	N/A
3	DC	1	DC	Shielded	0.3	N/A

### I/O CABLES (RADIATED AND CONDUCTED EMISSIONS)

I/O Cable List						
Cable No	Port	# of identical ports	Connector Type	Cable Type	Cable Length (m)	Remarks
1	USB	1	USB	Shielded	3	N/A
2	Audio	1	3.5mm	Shielded	1	N/A

**TEST SETUP- CONDUCTED PORT**

The EUT was tested connected to a host Laptop via USB cable adapter and spectrum analyzer to antenna port. Test software exercised the EUT.

**SETUP DIAGRAM**

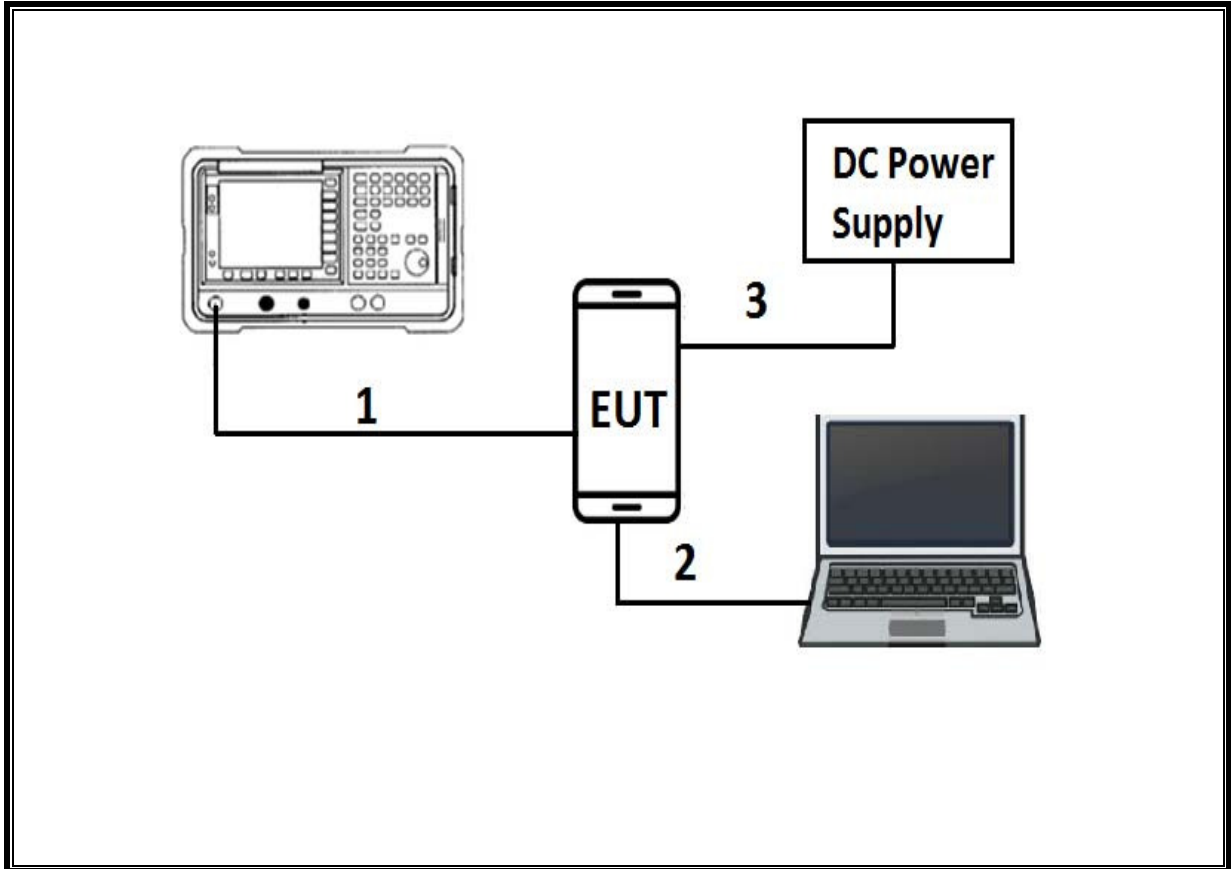

**TEST SETUP- RADIATED-ABOVE 1 GHZ and AC LINE CONDUCTED TESTS**

The EUT was powered by AC Adapter. Test software exercised the EUT.

**SETUP DIAGRAM**

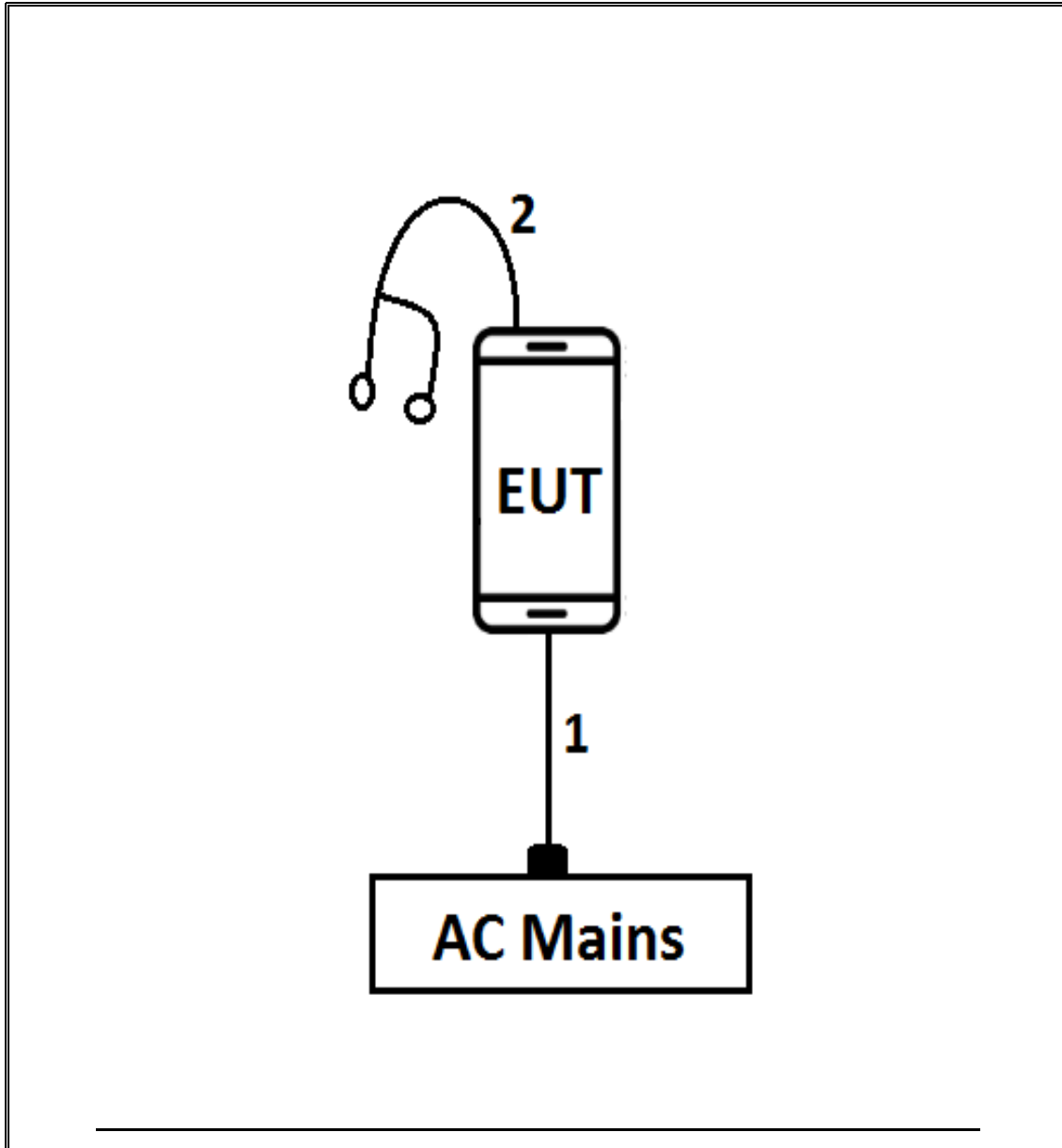

## 6. TEST AND MEASUREMENT EQUIPMENT

TEST EQUIPMENT LIST				
Description	Manufacturer	Model	Asset	Cal Due
Antenna, Broadband Hybrid, 30MHz to 2000MHz w/4dB Pad	Sunol Sciences Corp.	JB3	T477	06/22/2017
Antenna, Active Loop 9kHz-30MHz	ETS-Lindgren	6502	T1683	02/17/2018
Antenna, Horn 1-18GHz	ETS-Lindgren	3117	T345	03/07/2018
Antenna, Horn 18-26.5GHz	ARA	MWH-1826/B	T449	05/26/2017
Power Meter, P-series single channel	Agilent (Keysight) Technologies	N1911A	T1264	07/08/2017
Power Sensor, P – series, 50MHz to 18GHz, Wideband	Agilent (Keysight) Technologies	N1921A	T413	06/20/2017
Amplifier, 1-26.5GHz	Agilent (Keysight) Technologies	8449B	T404	07/05/2017
Amplifier, 10kHz-1GHz	Agilent (Keysight) Technologies	8447D	T15	08/26/2017
RF Amplifier	MITEQ	AFS42-00101800-25-S-42	T493	02/15/2018
Spectrum Analyzer, PSA, 3Hz to 26.5GHz	Agilent (Keysight) Technologies	E4440A	T199	07/22/2017
Spectrum Analyzer, PXA, 3Hz to 44GHz	Agilent (Keysight) Technologies	N9030A	T907	01/23/2018
Spectrum Analyzer, PSA, 3Hz to 26.5GHz	Agilent (Keysight) Technologies	E9030A	T905	01/11/2018
LISN	FISCHER	FCC-LISN-50/250-25-2-01	T1310	06/08/2017

Test Software List			
Description	Manufacturer	Model	Version
Radiated Software	UL	UL EMC	Ver 9.5, Apr 26, 2016
Conducted Software	UL	UL EMC	Ver 9.5, May 26, 2015
Antenna Port Software	UL	UL RF	Ver 5.1.1, July 15, 2016

## 7. ANTENNA PORT TEST RESULTS

### ON TIME AND DUTY CYCLE

#### LIMITS

None; for reporting purposes only.

#### PROCEDURE

KDB 558074 Zero-Span Spectrum Analyzer Method.

### ON TIME AND DUTY CYCLE RESULTS

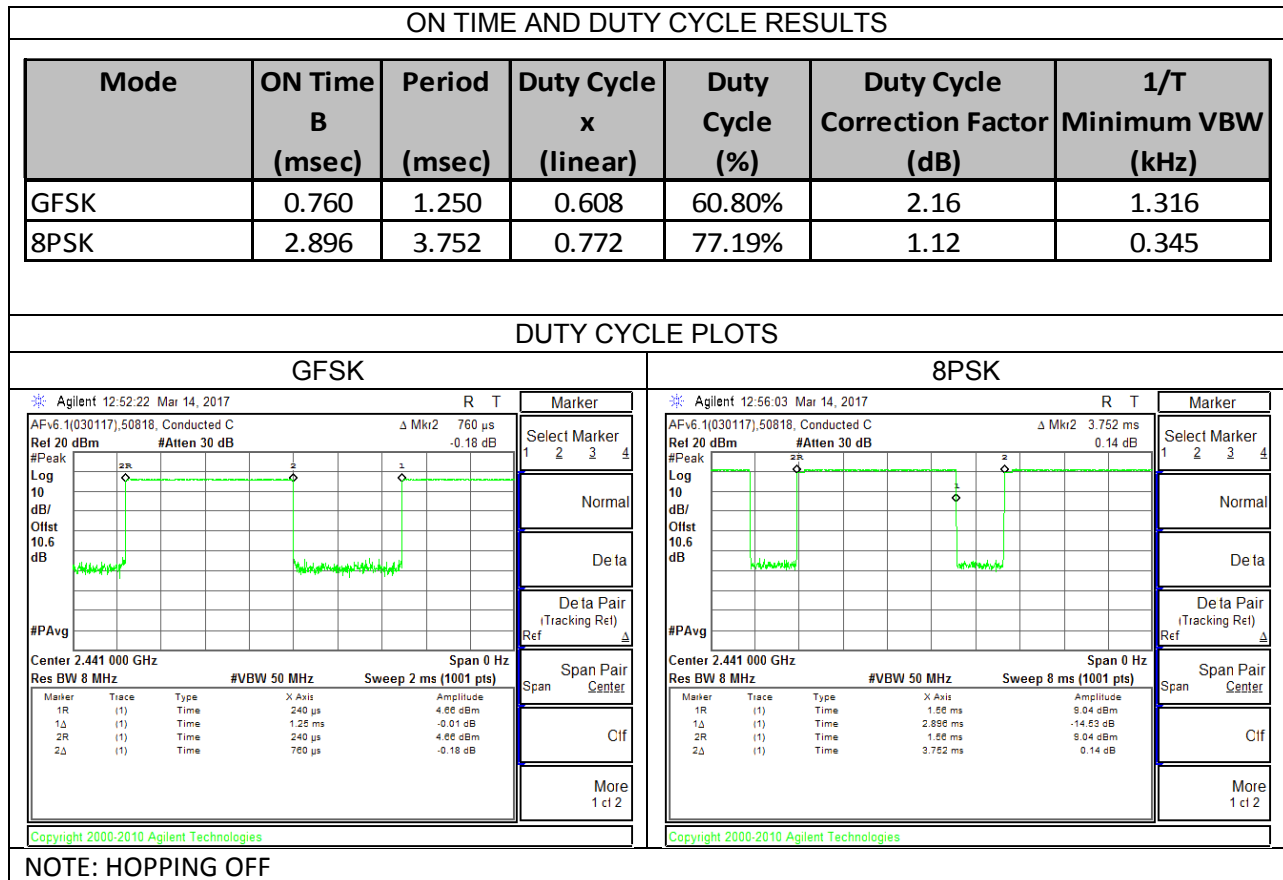

NOTE: HOPPING OFF

---

## 7.1. BASIC DATA RATE GFSK MODULATION

### 7.1.1. 20 dB AND 99% BANDWIDTH

#### LIMITS

None; for reporting purposes only.

#### TEST PROCEDURE

The transmitter output is connected to a spectrum analyzer. The RBW is set to  $\geq 1\%$  of the 20 dB bandwidth. The VBW is set to  $\geq$  RBW. The sweep time is coupled.

#### RESULTS

Channel	Frequency (MHz)	20 dB Bandwidth (KHz)	99% Bandwidth (KHz)
Low	2402	872.27	856.38
Middle	2441	856.23	850.13
High	2480	875.84	857.61

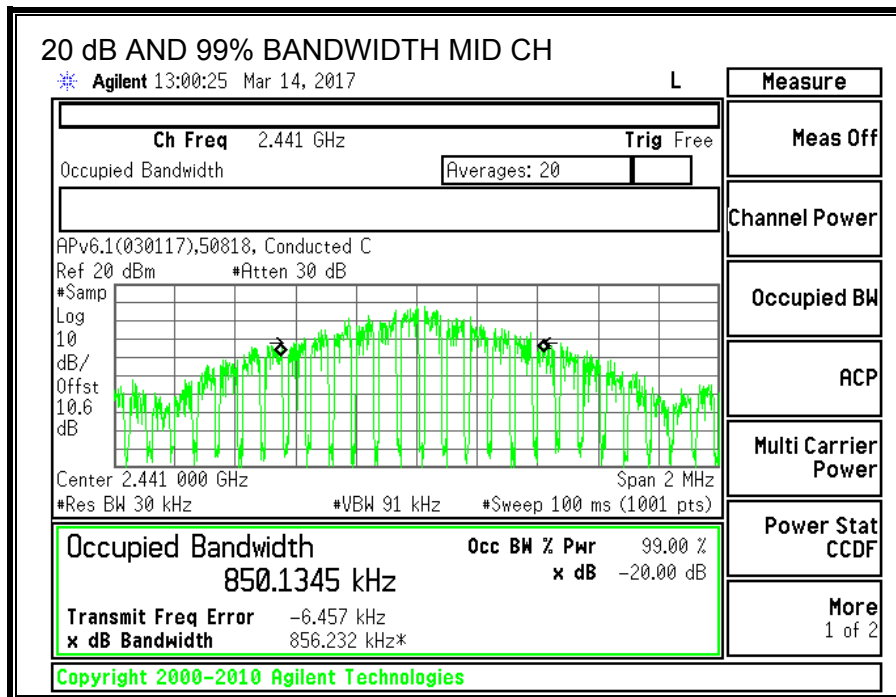
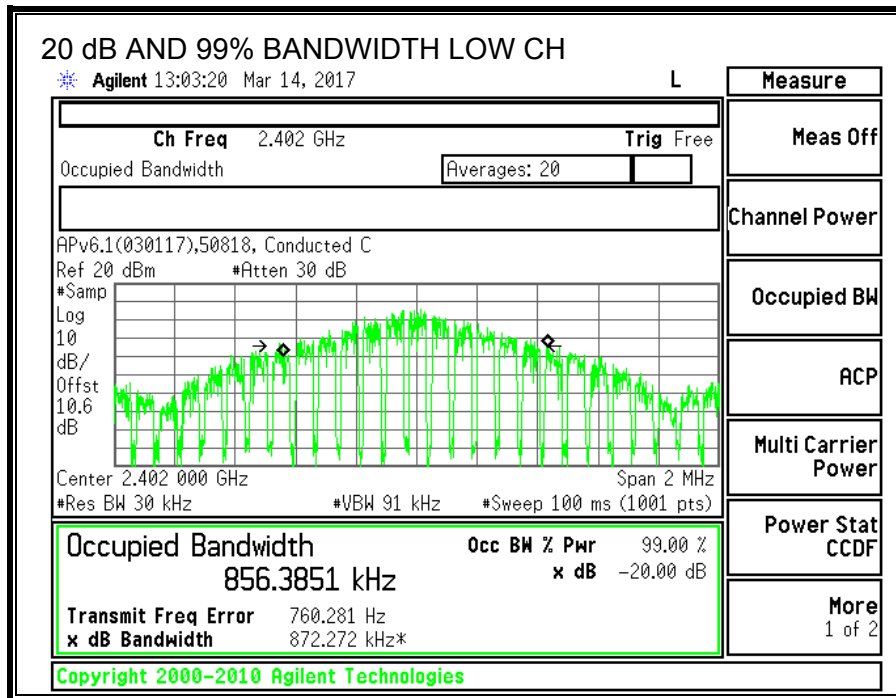



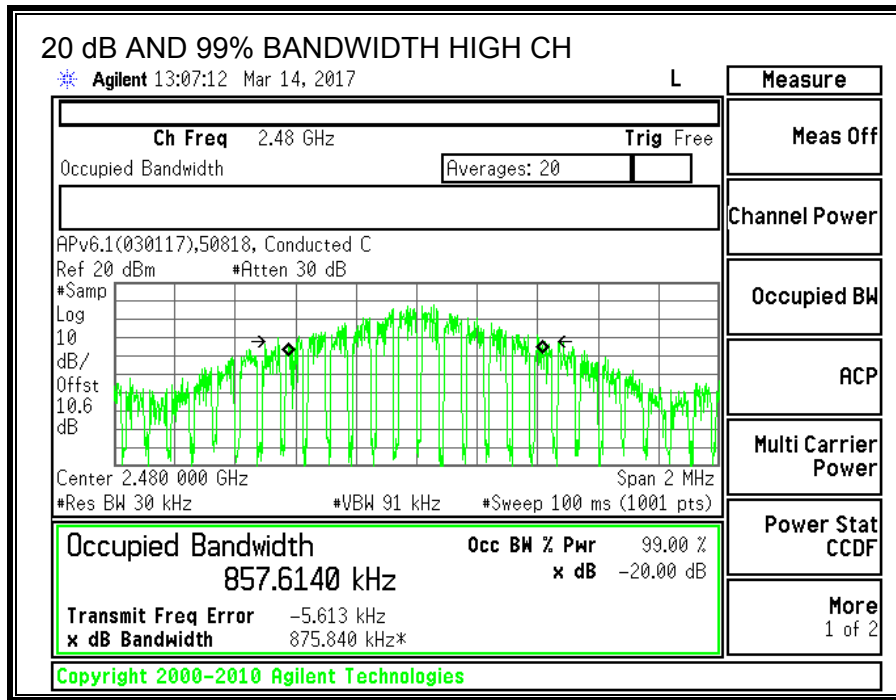

## 7.1.2. HOPPING FREQUENCY SEPARATION

### LIMITS

FCC §15.247 (a) (1)

Frequency hopping systems shall have hopping channel carrier frequencies separated by a minimum of 25 kHz or the 20 dB bandwidth of the hopping channel, whichever is greater.

Alternatively, frequency hopping systems operating in the 2400-2483.5 MHz band may have hopping channel carrier frequencies that are separated by 25 kHz or two-thirds of the 20 dB bandwidth of the hopping channel, whichever is greater, provided the systems operate with an output power no greater than 125 mW.

### TEST PROCEDURE

The transmitter output is connected to a spectrum analyzer. The RBW is set to 300 kHz and the VBW is set to 910 kHz. The sweep time is coupled.

### RESULTS

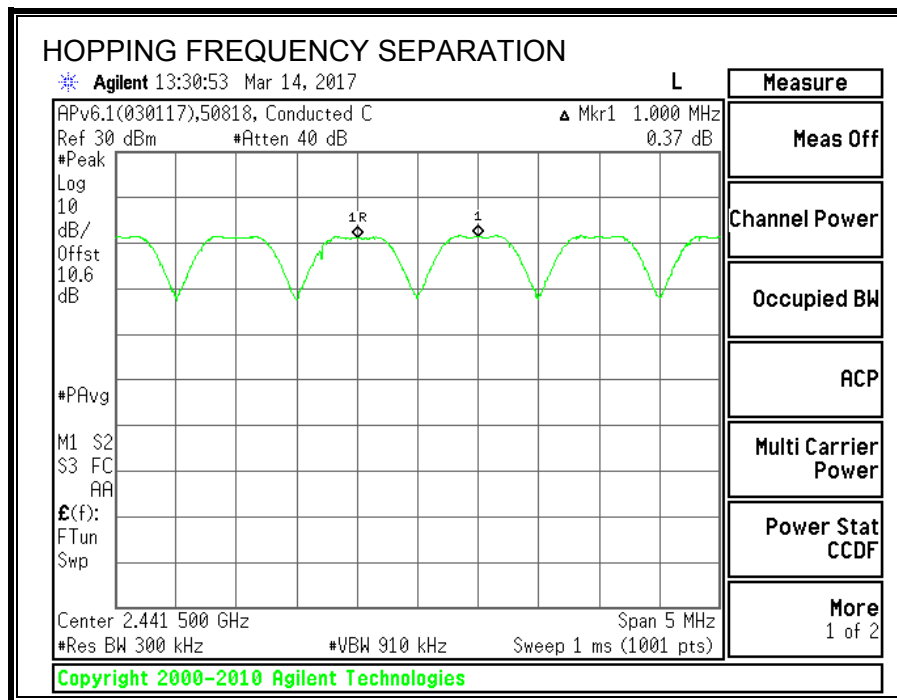

### 7.1.3. NUMBER OF HOPPING CHANNELS

#### LIMITS

FCC §15.247 (a) (1) (iii)

IC RSS-247 (5.1) (4)

Frequency hopping systems in the 2400 – 2483.5 MHz band shall use at least 15 non-overlapping channels.

#### TEST PROCEDURE

The transmitter output is connected to a spectrum analyzer. The span is set to cover the entire authorized band, in either a single sweep or in multiple contiguous sweeps. The RBW is set to a maximum of 1 % of the span. The analyzer is set to Max Hold.

#### RESULTS

Normal Mode: 79 Channels observed.

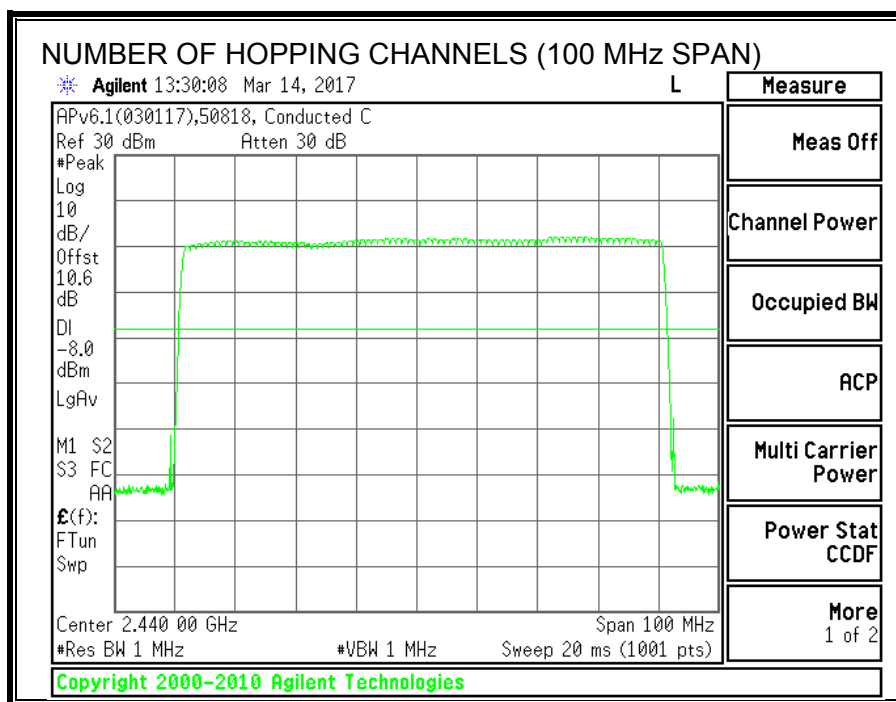

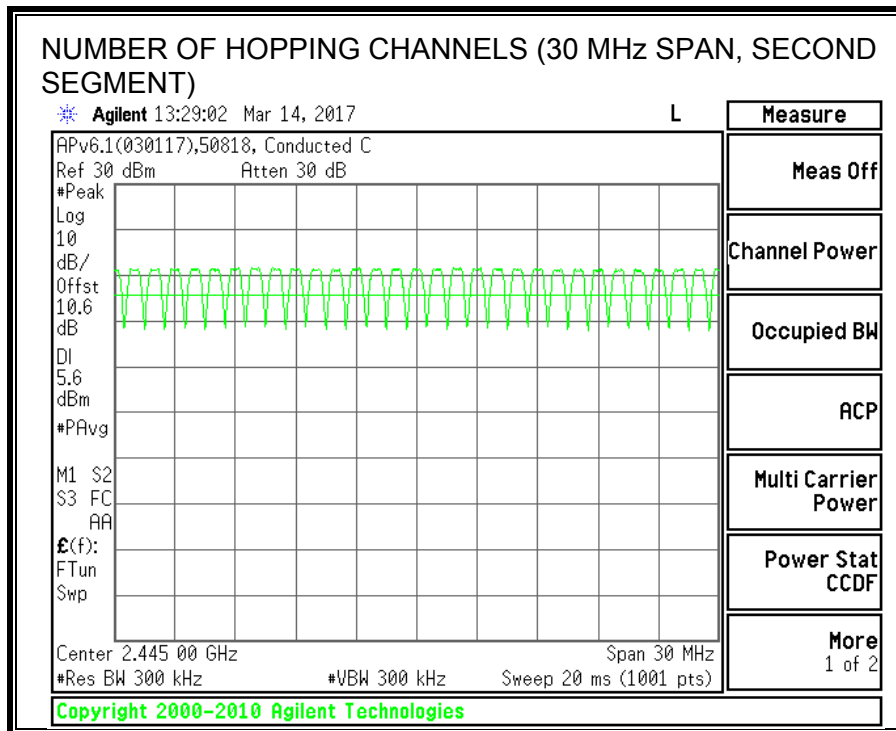
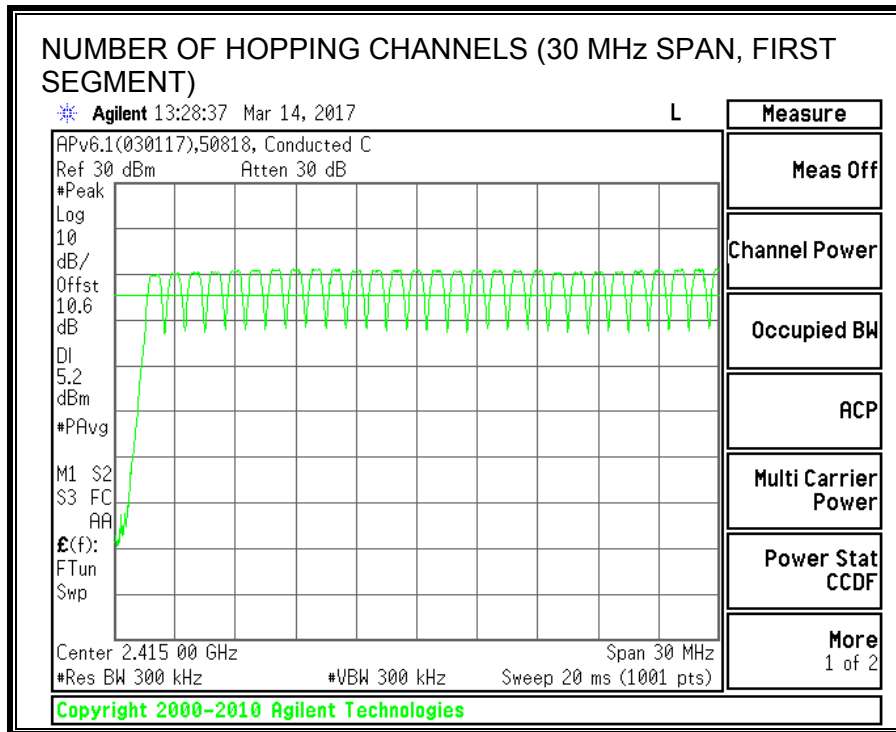

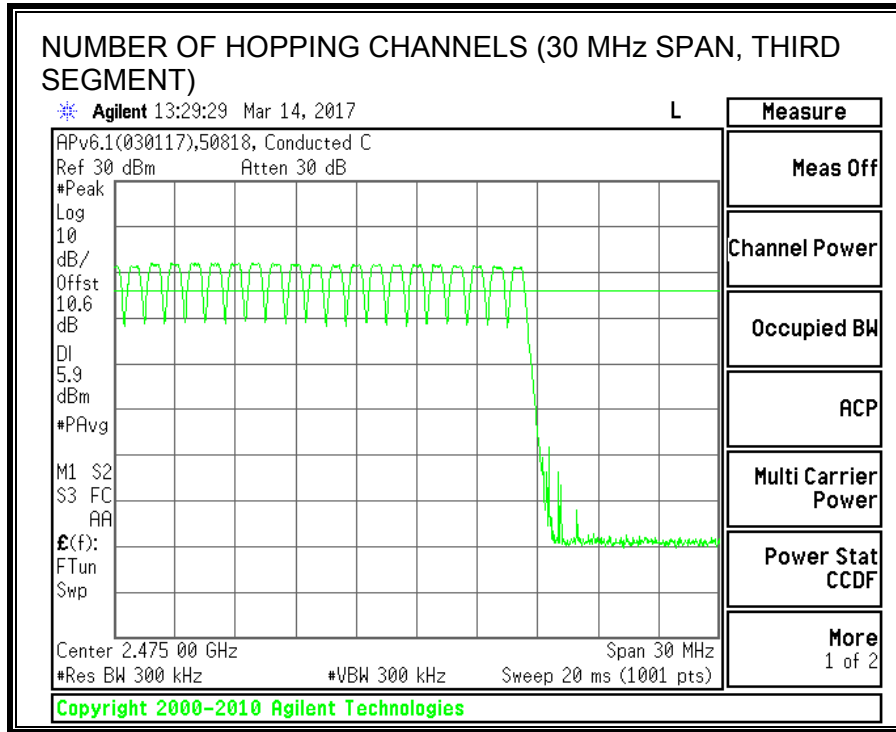

**7.1.4. AVERAGE TIME OF OCCUPANCY**

**LIMITS**

FCC §15.247 (a) (1) (iii)

IC RSS-247 (5.1) (4)

The average time of occupancy on any channel shall not be greater than 0.4 seconds within a period of 0.4 seconds multiplied by the number of hopping channels employed.

**TEST PROCEDURE**

The transmitter output is connected to a spectrum analyzer. The span is set to 0 Hz, centered on a single, selected hopping channel. The width of a single pulse is measured in a fast scan. The number of pulses is measured in a 3.16 second scan, to enable resolution of each occurrence.

The average time of occupancy in the specified 31.6 second period (79 channels \* 0.4 s) is equal to  $10 * (\# \text{ of pulses in } 3.16 \text{ s}) * \text{ pulse width}$ .

For AFH mode, the average time of occupancy in the specified 8 second period (20 channels \* 0.4 seconds) is equal to  $10 * (\# \text{ of pulses in } 0.8 \text{ s}) * \text{ pulse width}$ .

**RESULTS**

AVERAGE TIME OF OCCUPANCY					
DH Packet	Pulse Width (msec)	Number of Pulses in 3.16 seconds	Average Time of Occupancy (sec)	Limit (sec)	Margin (sec)
GFSK Normal Mode					
DH1	0.382	31	0.1185	0.4	-0.2815
DH3	1.639	17	0.2786	0.4	-0.1214
DH5	2.888	9	0.2599	0.4	-0.1401
DH Packet	Pulse Width (sec)	Number of Pulses in 0.8 seconds	Average Time of Occupancy (sec)	Limit (sec)	Margin (sec)
GFSK AFH Mode					
DH1	0.382	7.75	0.02962	0.4	-0.3704
DH3	1.639	4.25	0.06966	0.4	-0.3303
DH5	2.888	2.25	0.06498	0.4	-0.3350
NOTE: --					

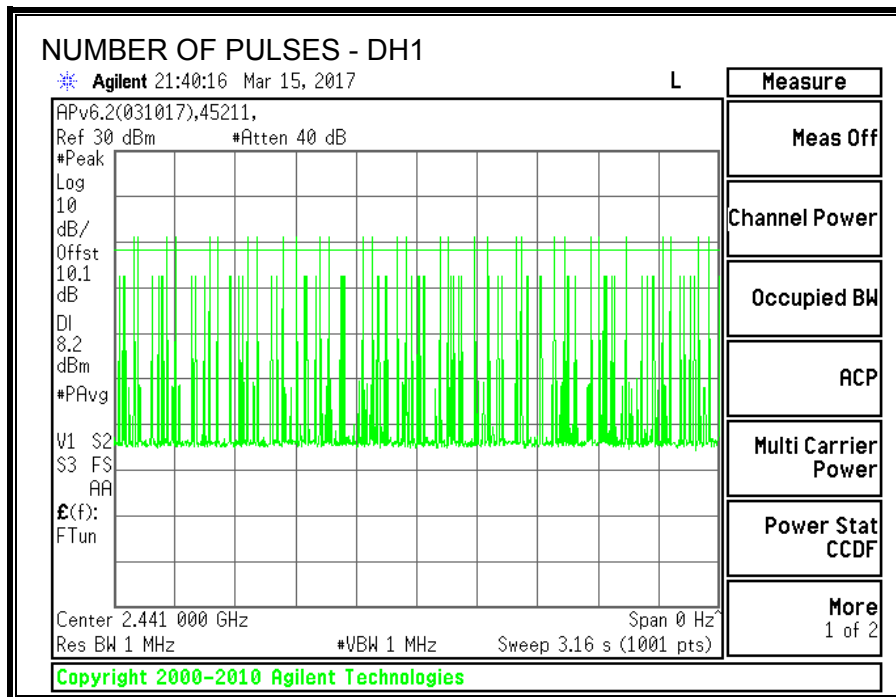
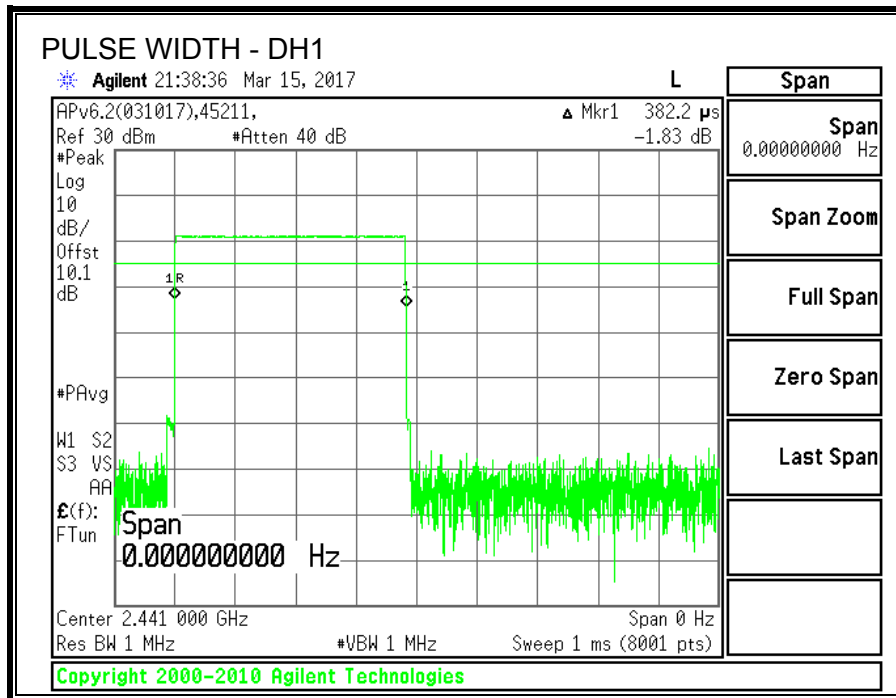

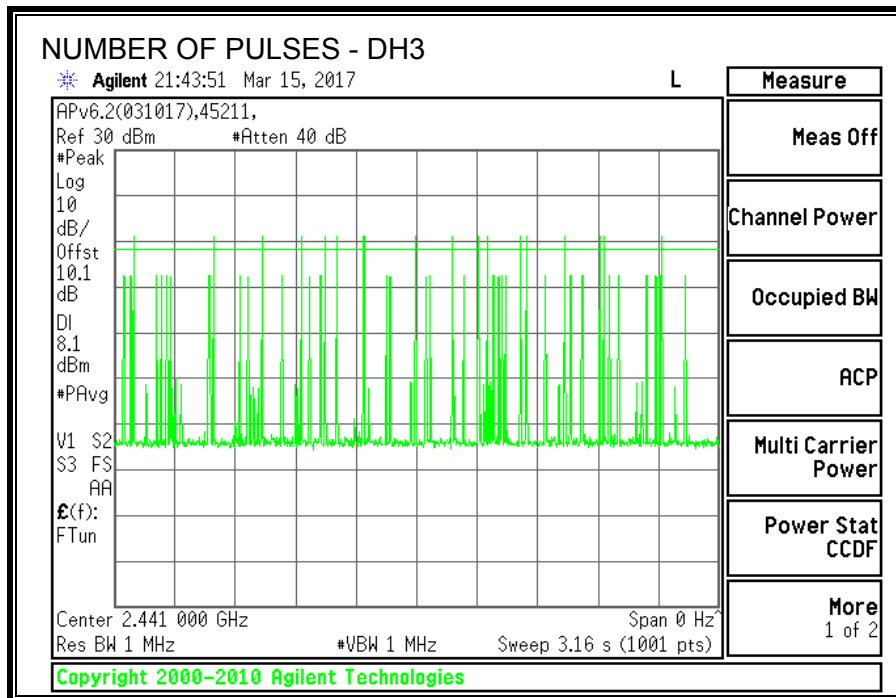
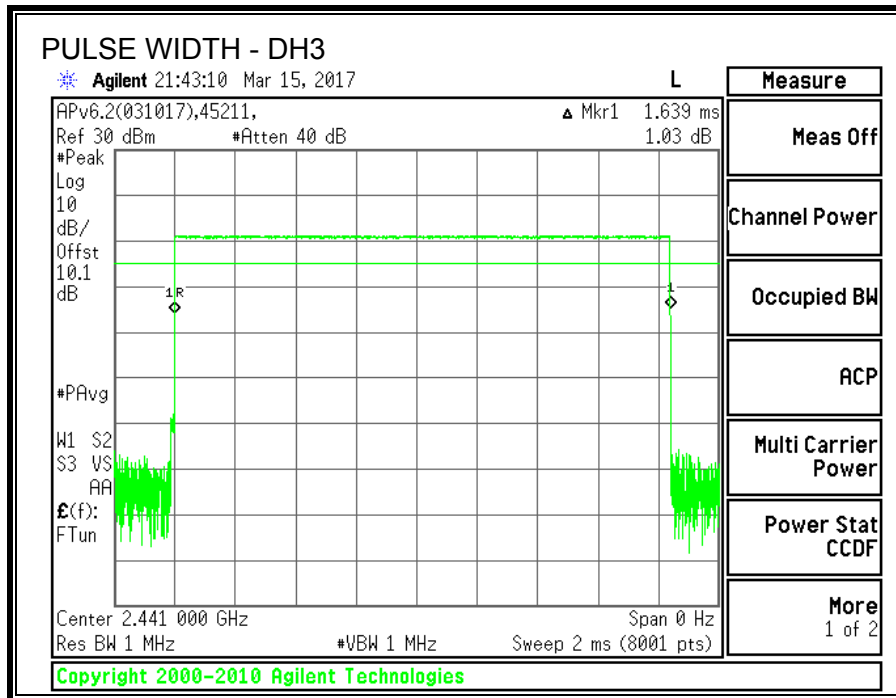



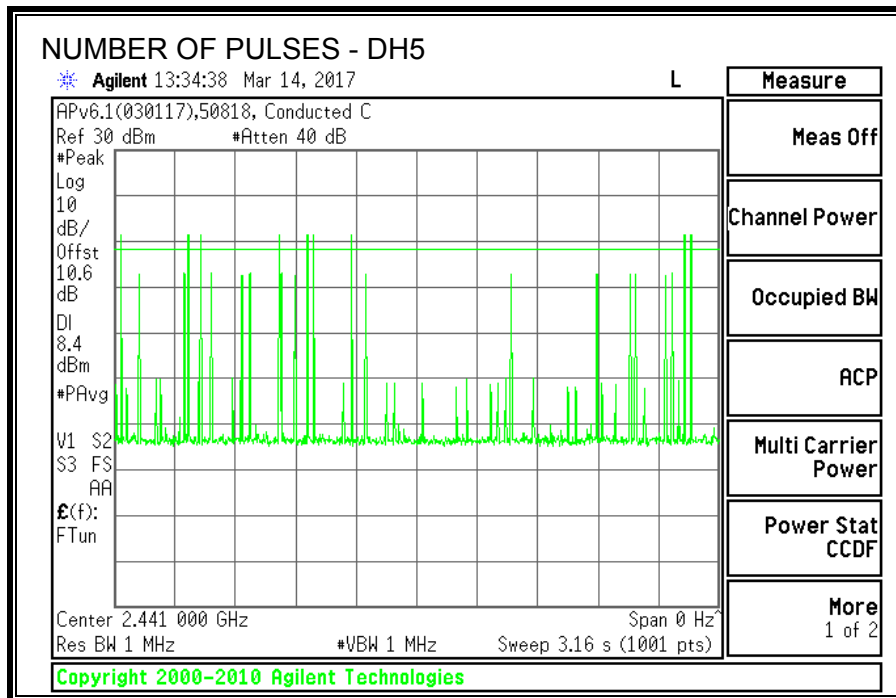
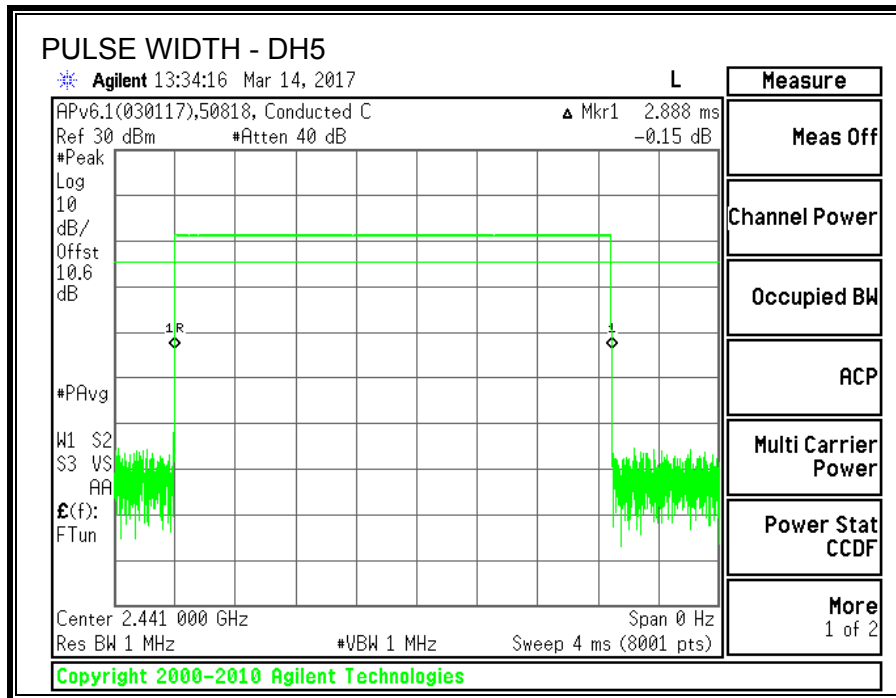

---

### 7.1.5. OUTPUT POWER

#### LIMITS

§15.247 (b) (1)

RSS-247 (5.4) (2)

The maximum antenna gain is less than 6 dBi, therefore the limit is 30 dBm.

#### TEST PROCEDURE

The transmitter output is connected to a wideband peak and average power meter.

#### RESULTS

<b>TEST ENGINEER:</b>	45250	<b>Date:</b>	3/23/2017
-----------------------	-------	--------------	-----------

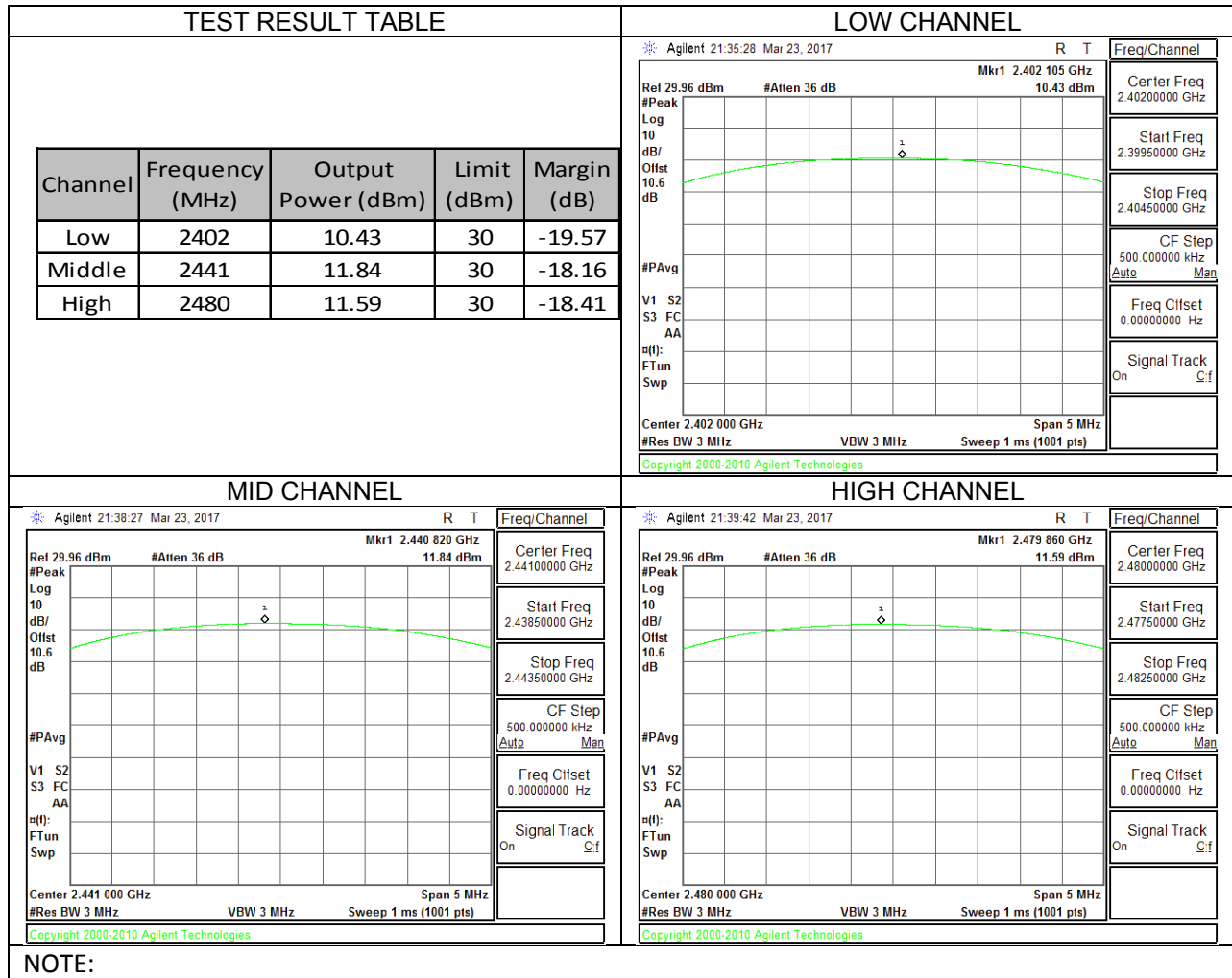

---

### 7.1.6. AVERAGE POWER

#### LIMITS

None; for reporting purposes only.

#### TEST PROCEDURE

The transmitter output is connected to a power meter.

#### RESULTS

The cable assembly insertion loss of 11 dB (including 10 dB pad and 1 dB cable) was entered as an offset in the power meter to allow for direct reading of power.

<b>TEST ENGINEER:</b>	50818	<b>Date:</b>	3/14/2017
-----------------------	-------	--------------	-----------

Channel	Frequency (MHz)	Average Power (dBm)
Low	2402	9.78
Middle	2441	11.13
High	2480	10.94

**7.1.7. CONDUCTED BANDEDGE AND SPURIOUS EMISSIONS**

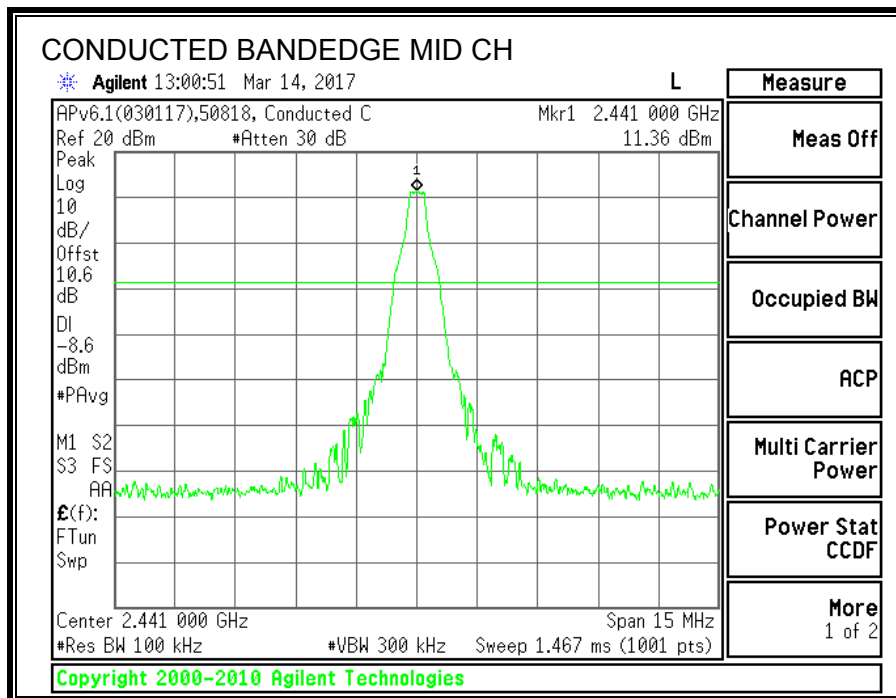
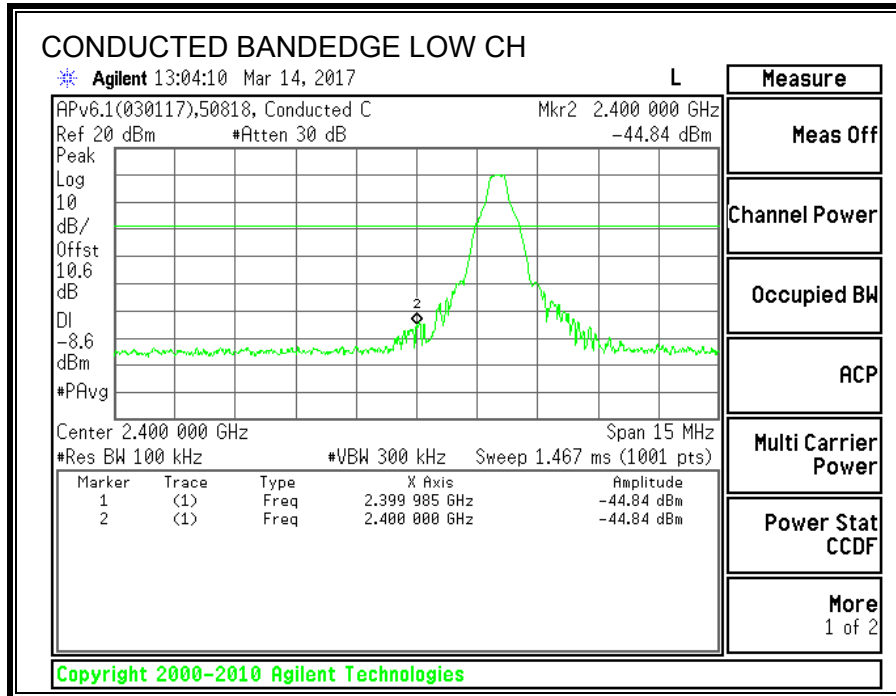

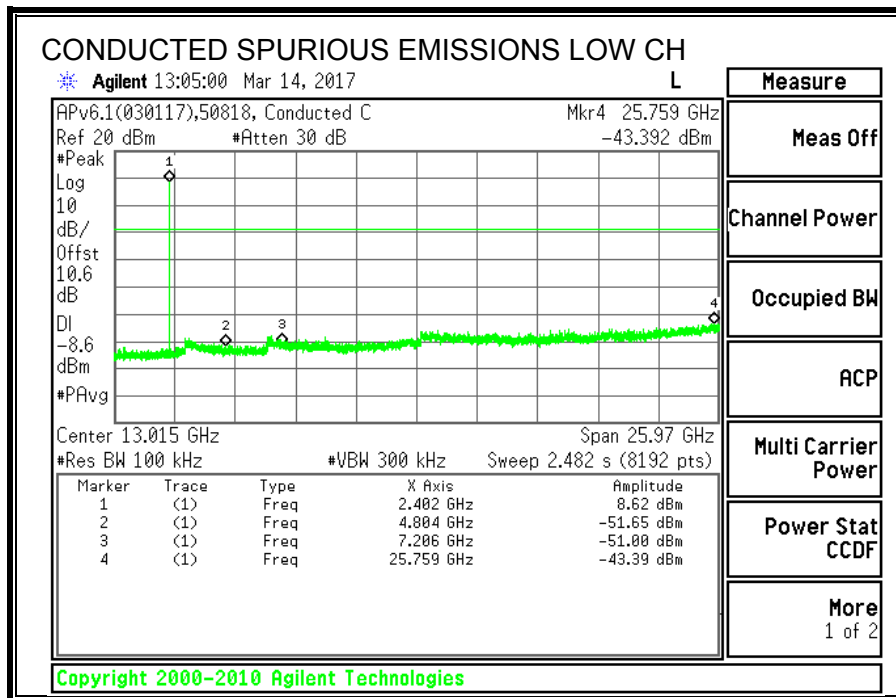
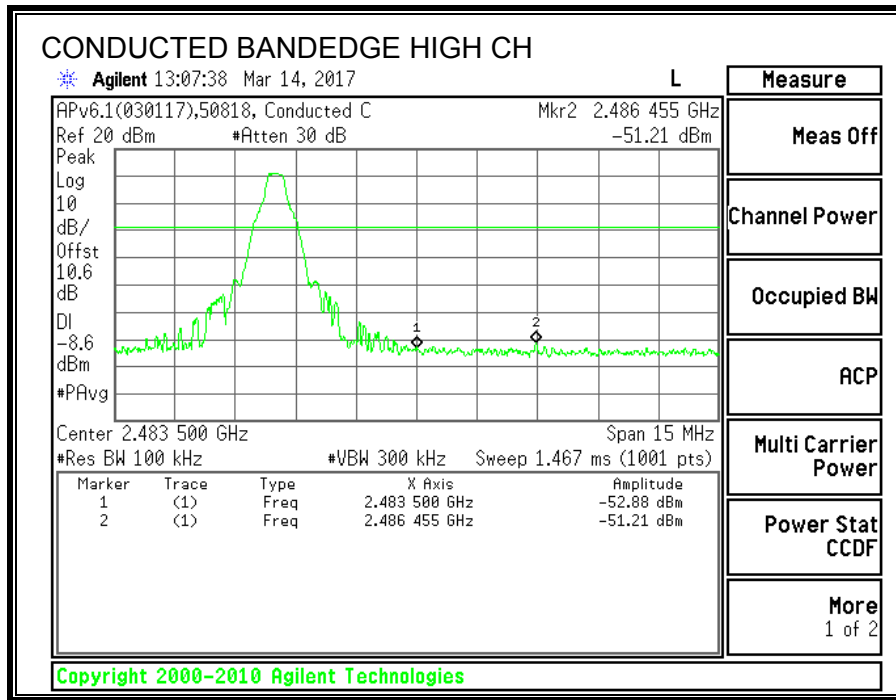

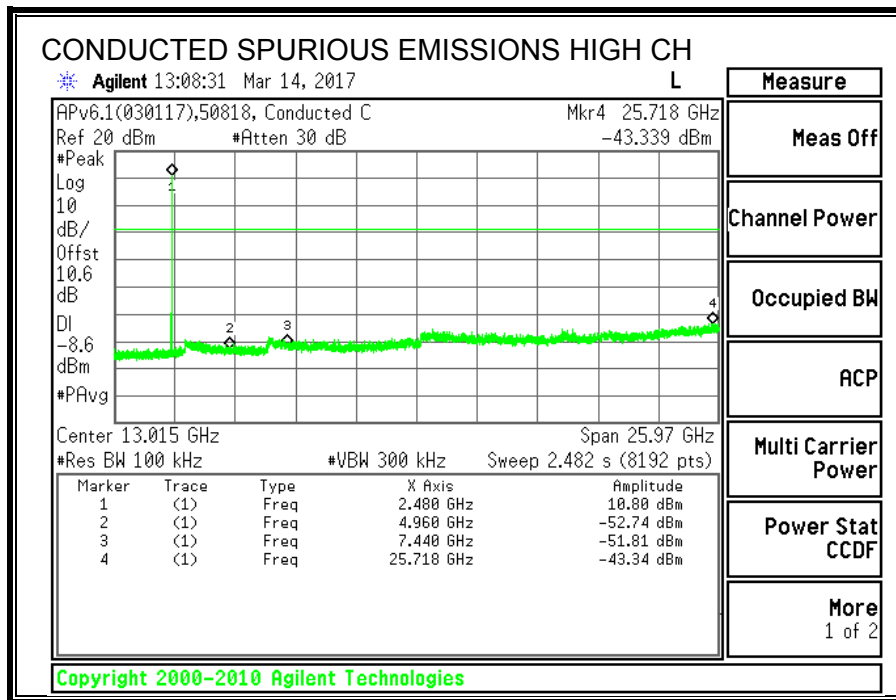
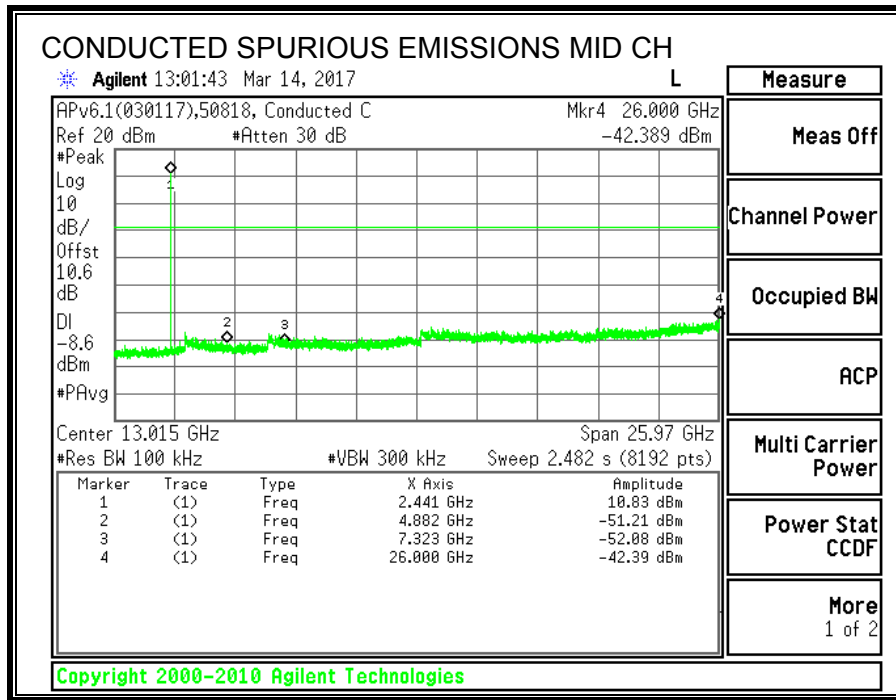

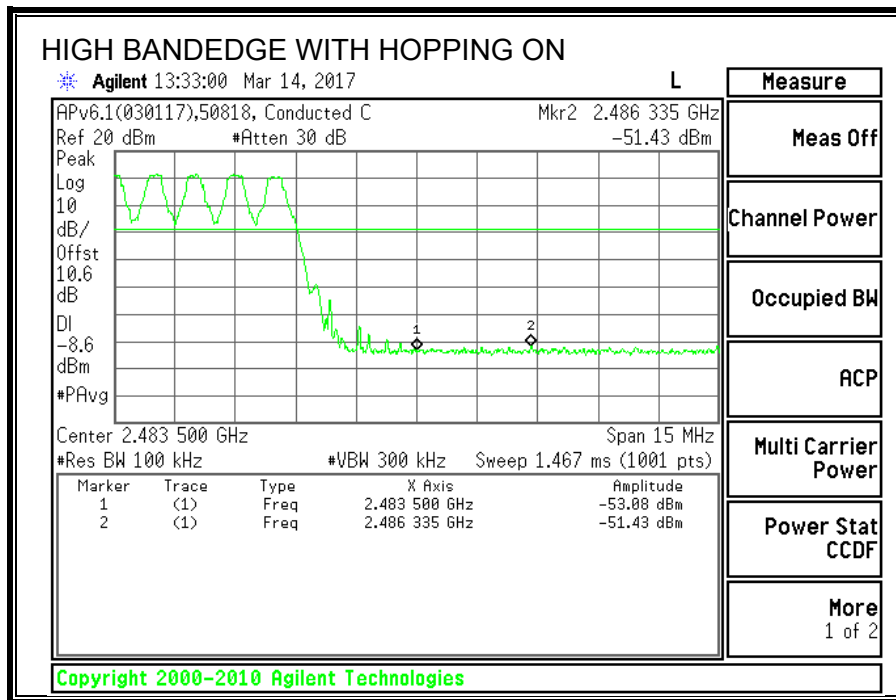
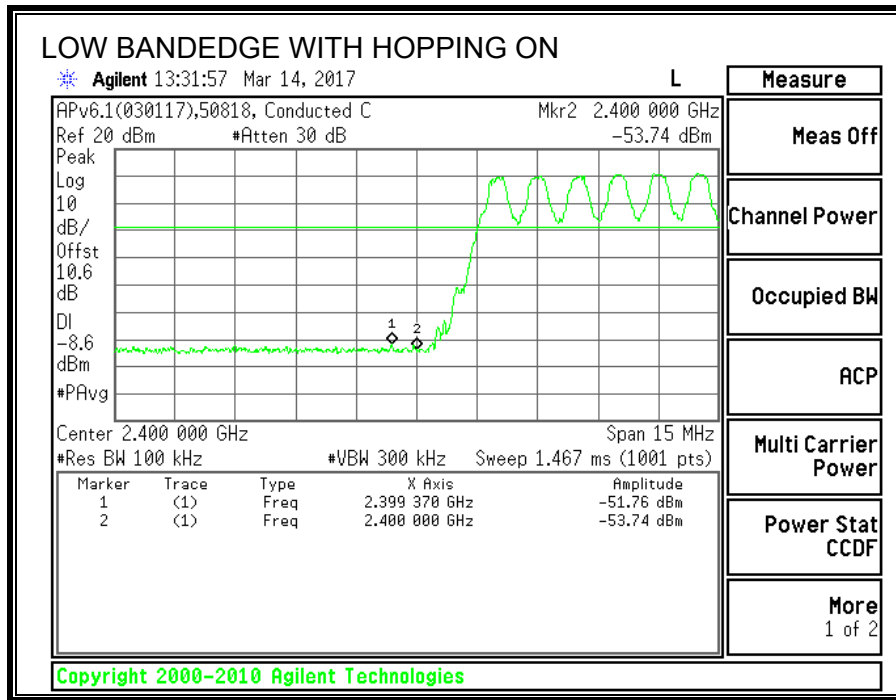



## 7.2. ENHANCED DATA RATE 8PSK MODULATION

### 7.2.1. 20 dB AND 99% BANDWIDTH

#### LIMITS

None; for reporting purposes only.

#### TEST PROCEDURE

The transmitter output is connected to a spectrum analyzer. The RBW is set to  $\geq 1\%$  of the 20 dB bandwidth. The VBW is set to  $\geq$  RBW. The sweep time is coupled.

#### RESULTS

Channel	Frequency (MHz)	20 dB Bandwidth (MHz)	99% Bandwidth (MHz)
Low	2402	1.187	1.1518
Middle	2441	1.186	1.1541
High	2480	1.231	1.1984

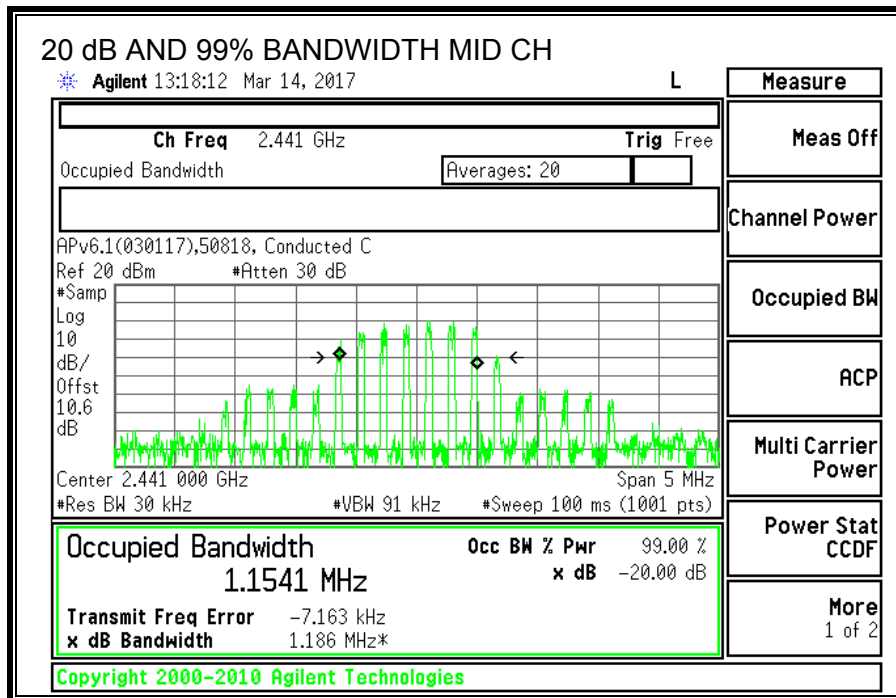
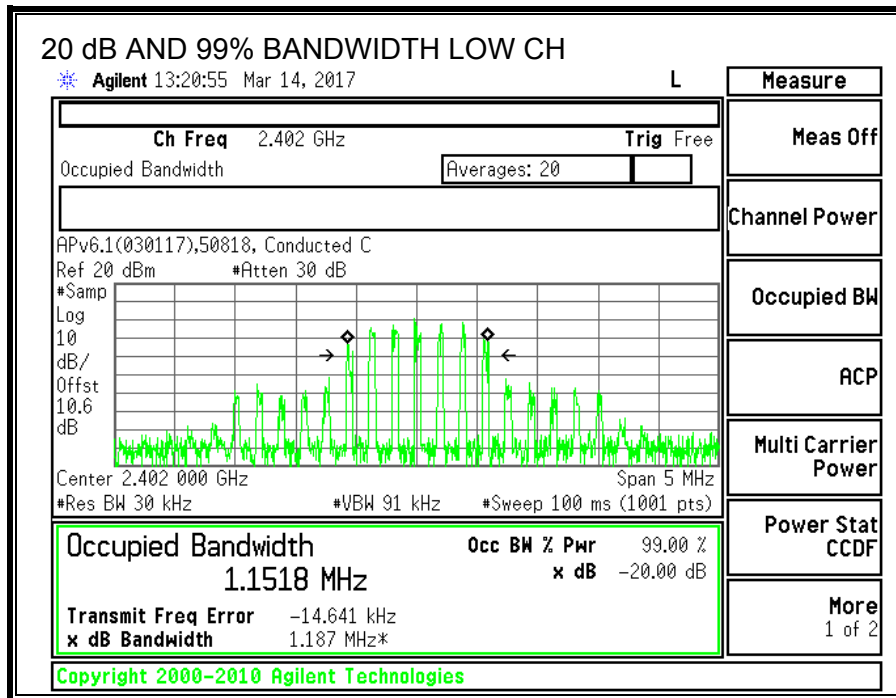

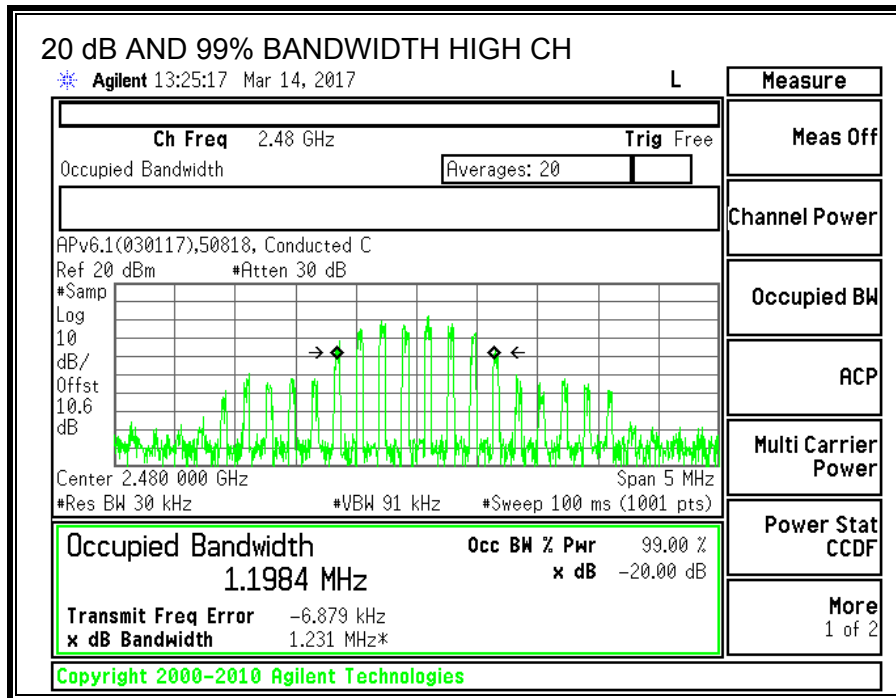

## 7.2.2. HOPPING FREQUENCY SEPARATION

### LIMITS

FCC §15.247 (a) (1)

IC RSS-247 (5.1) (2)

Frequency hopping systems shall have hopping channel carrier frequencies separated by a minimum of 25 kHz or the 20 dB bandwidth of the hopping channel, whichever is greater.

Alternatively, frequency hopping systems operating in the 2400-2483.5 MHz band may have hopping channel carrier frequencies that are separated by 25 kHz or two-thirds of the 20 dB bandwidth of the hopping channel, whichever is greater, provided the systems operate with an output power no greater than 125 mW.

### TEST PROCEDURE

The transmitter output is connected to a spectrum analyzer. The RBW is set to 300 kHz and the VBW is set to 910 kHz. The sweep time is coupled.

### RESULTS

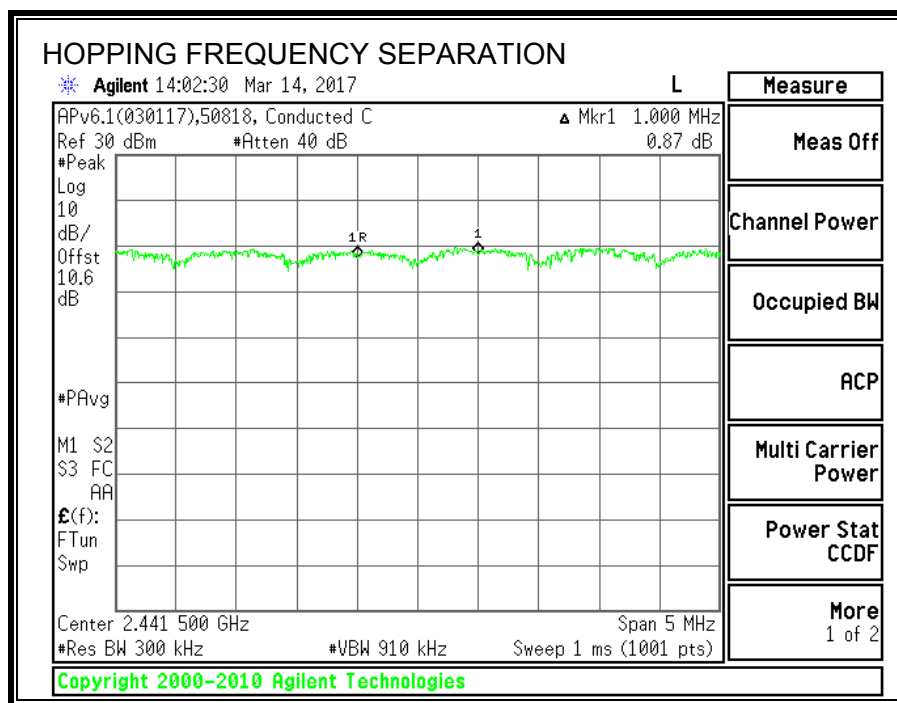

### 7.2.3. NUMBER OF HOPPING CHANNELS

#### LIMITS

FCC §15.247 (a) (1) (iii)

IC RSS-247 (5.1) (4)

Frequency hopping systems in the 2400 – 2483.5 MHz band shall use at least 15 non-overlapping channels.

#### TEST PROCEDURE

The transmitter output is connected to a spectrum analyzer. The span is set to cover the entire authorized band, in either a single sweep or in multiple contiguous sweeps. The RBW is set to a maximum of 1 % of the span. The analyzer is set to Max Hold.

#### RESULTS

Normal Mode: 79 Channels observed.

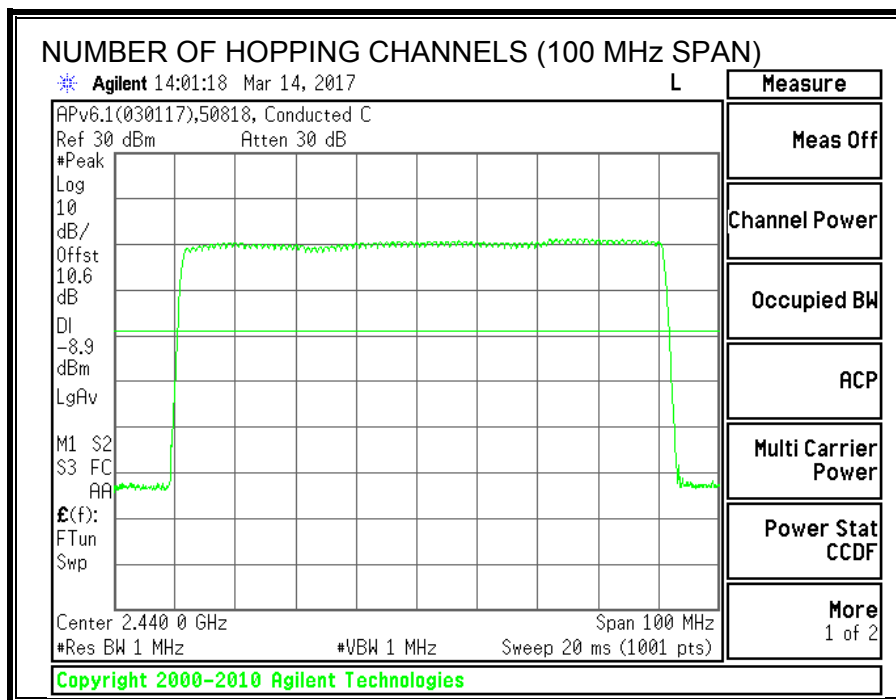

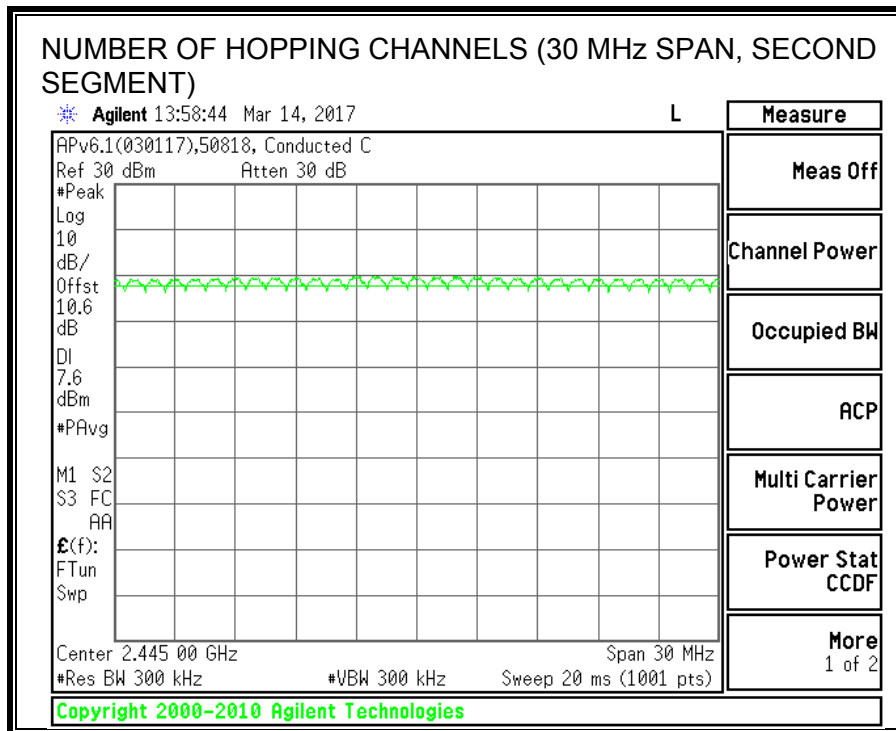
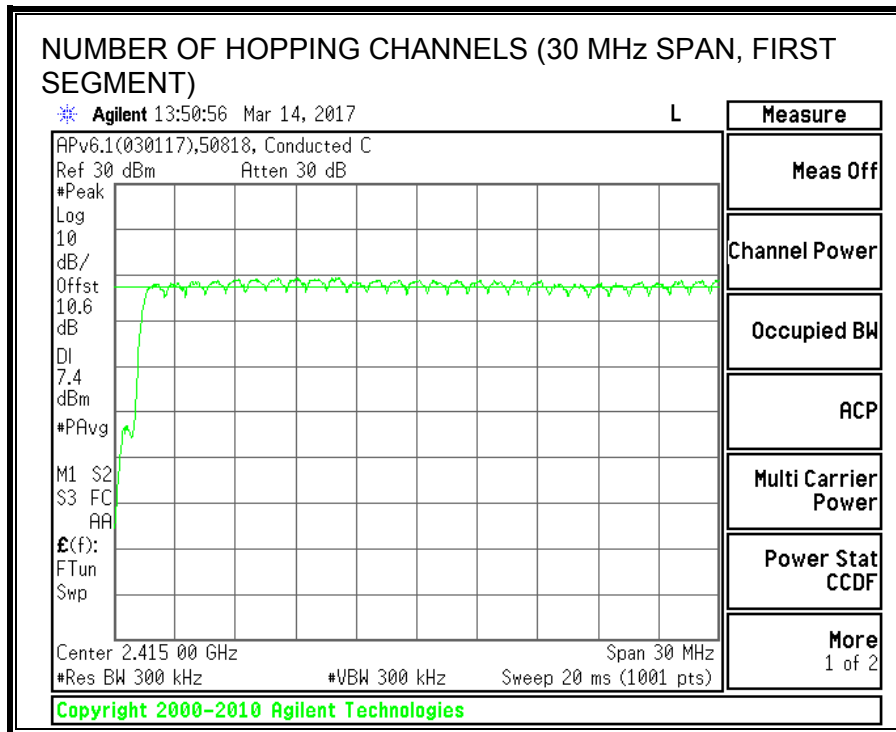

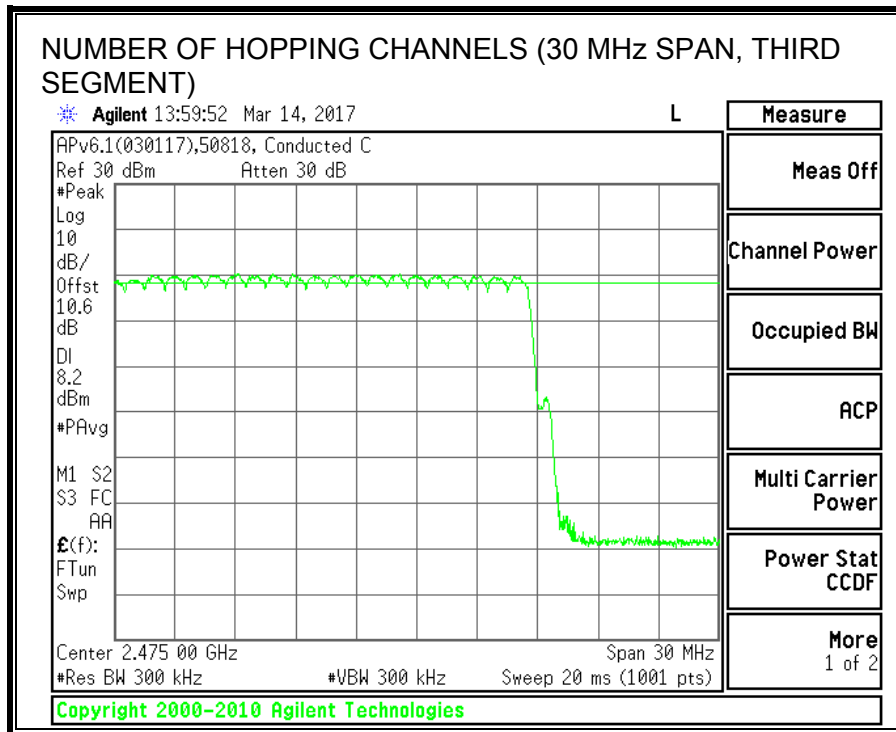

**7.2.4. AVERAGE TIME OF OCCUPANCY**

**LIMITS**

FCC §15.247 (a) (1) (iii)

IC RSS-247 (5.1) (4)

The average time of occupancy on any channel shall not be greater than 0.4 seconds within a period of 0.4 seconds multiplied by the number of hopping channels employed.

**TEST PROCEDURE**

The transmitter output is connected to a spectrum analyzer. The span is set to 0 Hz, centered on a single, selected hopping channel. The width of a single pulse is measured in a fast scan. The number of pulses is measured in a 3.16 second scan, to enable resolution of each occurrence.

The average time of occupancy in the specified 31.6 second period (79 channels \* 0.4 s) is equal to  $10 * (\# \text{ of pulses in } 3.16 \text{ s}) * \text{ pulse width}$ .

For AFH mode, the average time of occupancy in the specified 8 second period (20 channels \* 0.4 seconds) is equal to  $10 * (\# \text{ of pulses in } 0.8 \text{ s}) * \text{ pulse width}$ .

**RESULTS**

AVERAGE TIME OF OCCUPANCY					
DH Packet	Pulse Width (msec)	Number of Pulses in 3.16 seconds	Average Time of Occupancy (sec)	Limit (sec)	Margin (sec)
GFSK Normal Mode					
DH1	0.388	31	0.1203	0.4	-0.2797
DH3	1.639	17	0.2786	0.4	-0.1214
DH5	2.889	12	0.3467	0.4	-0.0533
DH Packet	Pulse Width (sec)	Number of Pulses in 0.8 seconds	Average Time of Occupancy (sec)	Limit (sec)	Margin (sec)
GFSK AFH Mode					
DH1	0.388	7.75	0.03008	0.4	-0.3699
DH3	1.639	4.25	0.06966	0.4	-0.3303
DH5	2.889	3	0.08667	0.4	-0.3133

NOTE: --



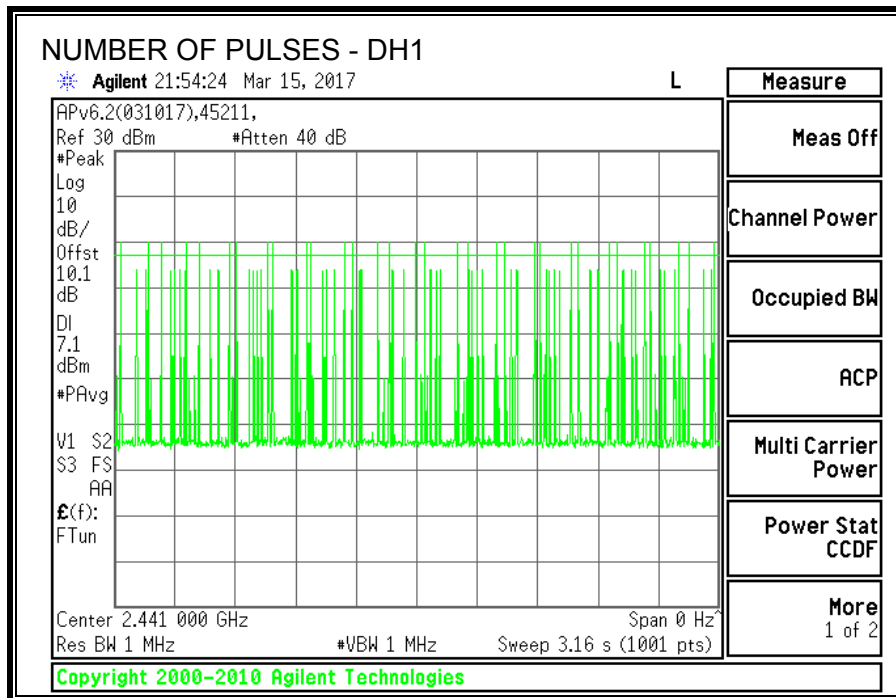
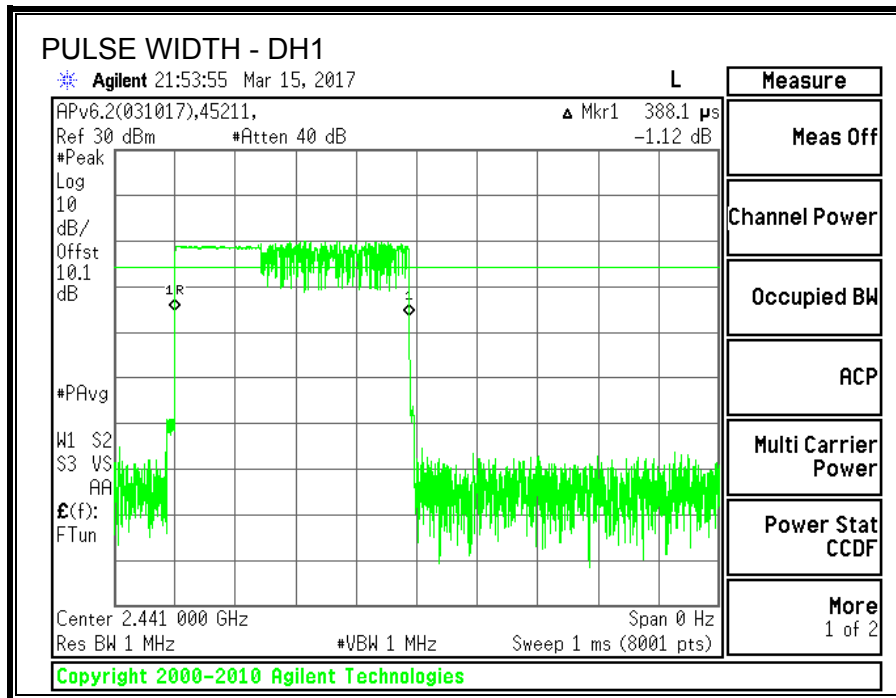

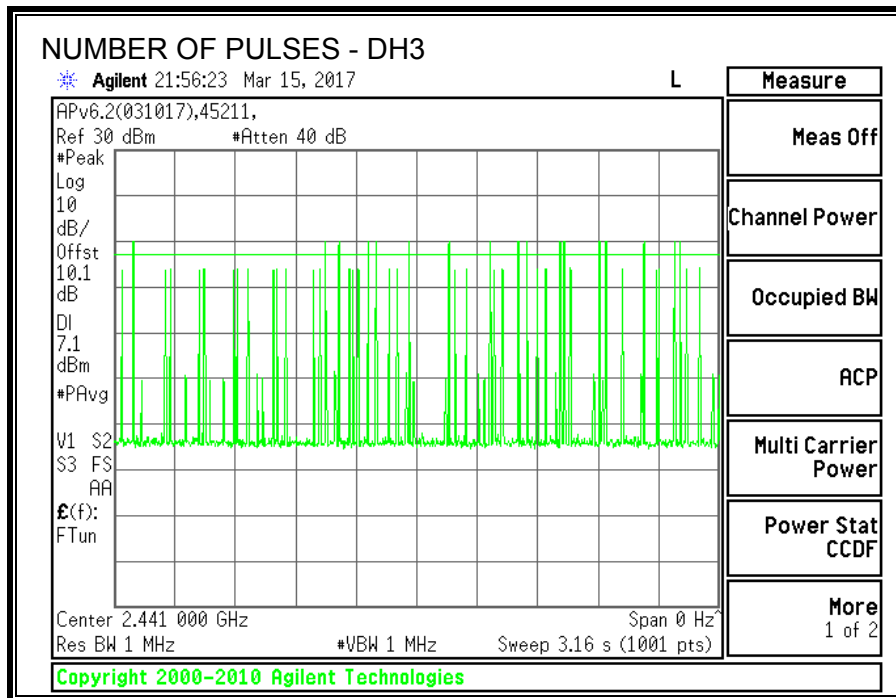
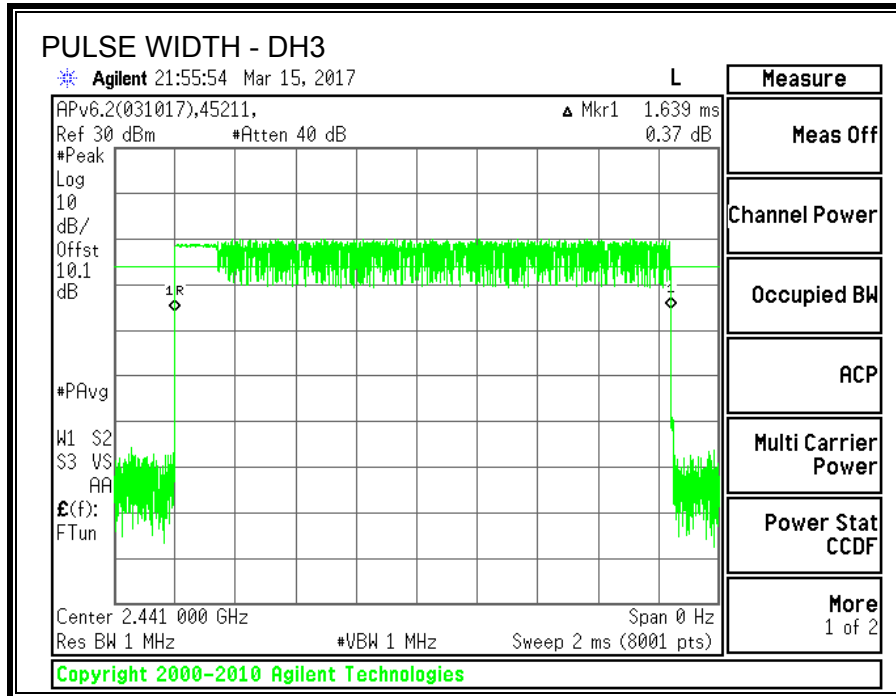

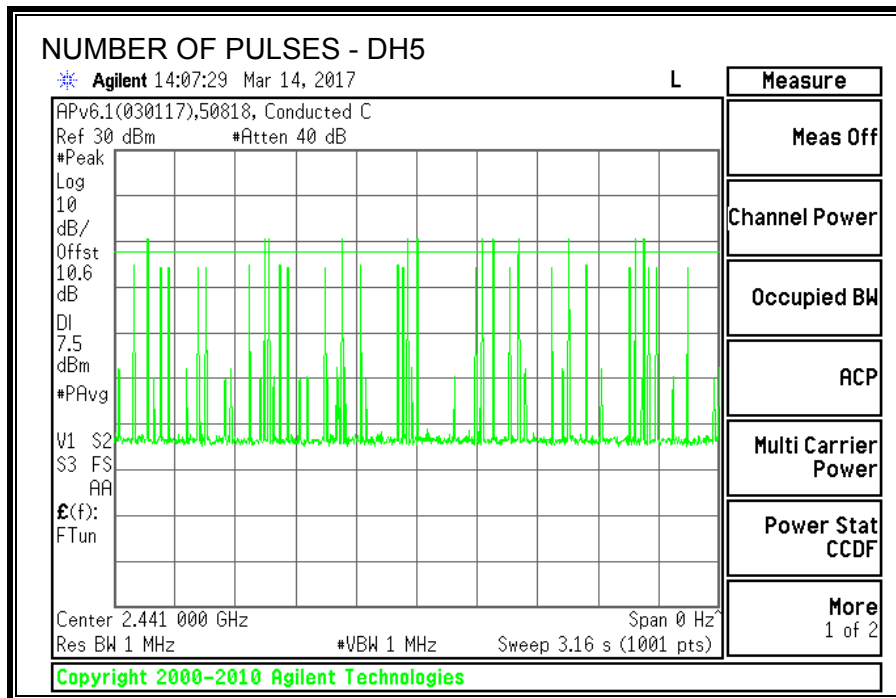
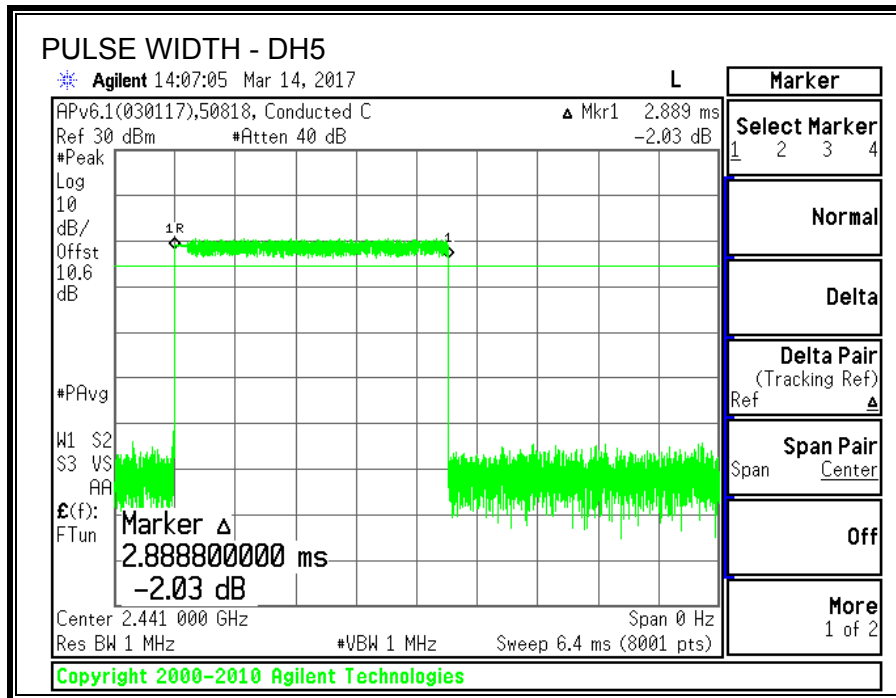

---

## 7.2.5. OUTPUT POWER

### LIMITS

§15.247 (b) (1)

RSS-247 (5.4) (2)

The maximum antenna gain is less than 6 dBi, therefore the limit is 30 dBm.

### TEST PROCEDURE

The transmitter output is connected to a wideband peak and average power meter.

### RESULTS

<b>TEST ENGINEER:</b>	45250	<b>Date:</b>	3/23/2017
-----------------------	-------	--------------	-----------

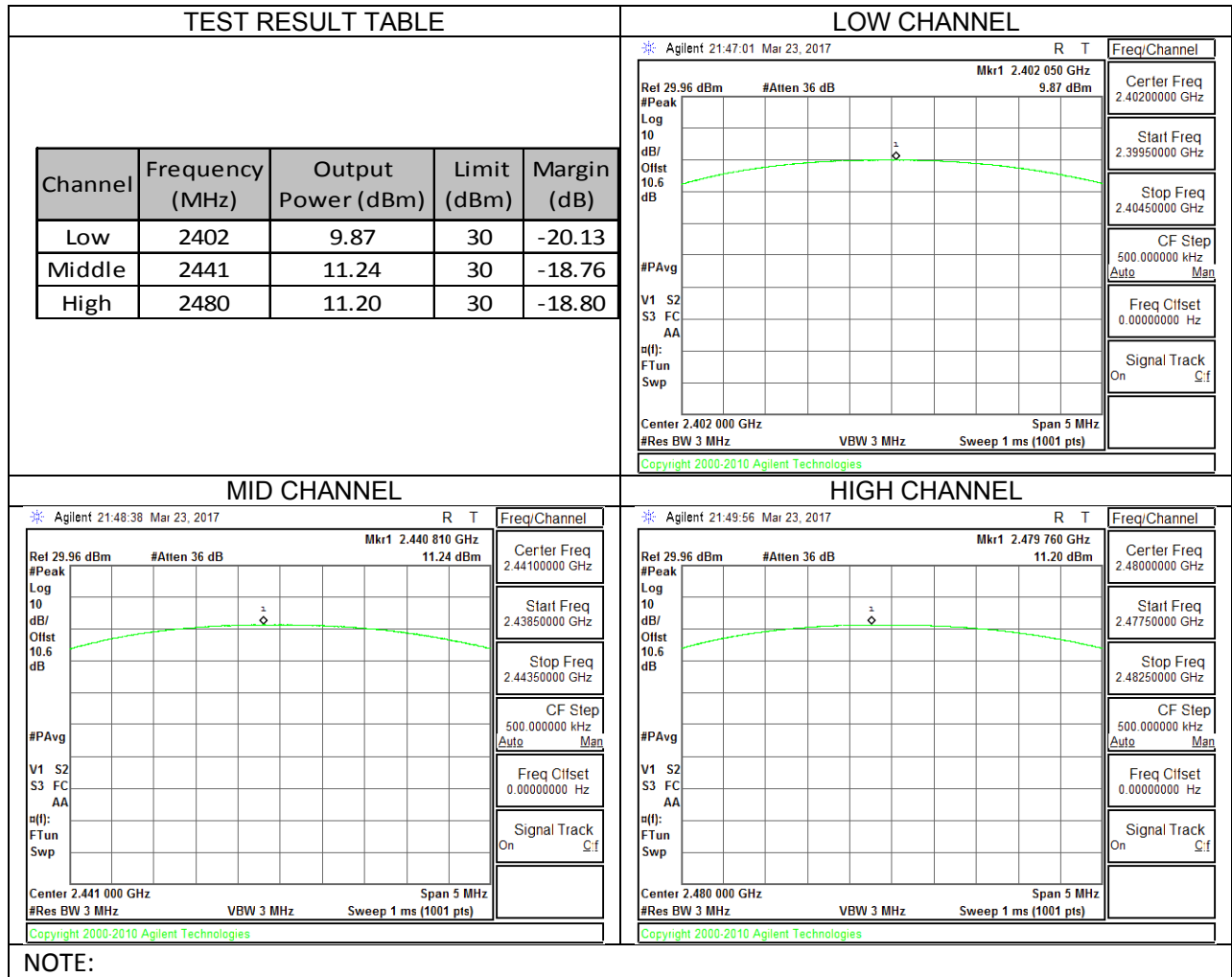

---

### 7.2.6. AVERAGE POWER

#### LIMITS

None; for reporting purposes only.

#### TEST PROCEDURE

The transmitter output is connected to a power meter.

#### RESULTS

The cable assembly insertion loss of 11 dB (including 10 dB pad and 1 dB cable) was entered as an offset in the power meter to allow for direct reading of power.

<b>TEST ENGINEER:</b>	50818	<b>Date:</b>	3/14/2017
-----------------------	-------	--------------	-----------

Channel	Frequency (MHz)	Average Power (dBm)
Low	2402	7.71
Middle	2441	8.94
High	2480	9.47

### 7.2.7. CONDUCTED BANDEDGE AND SPURIOUS EMISSIONS

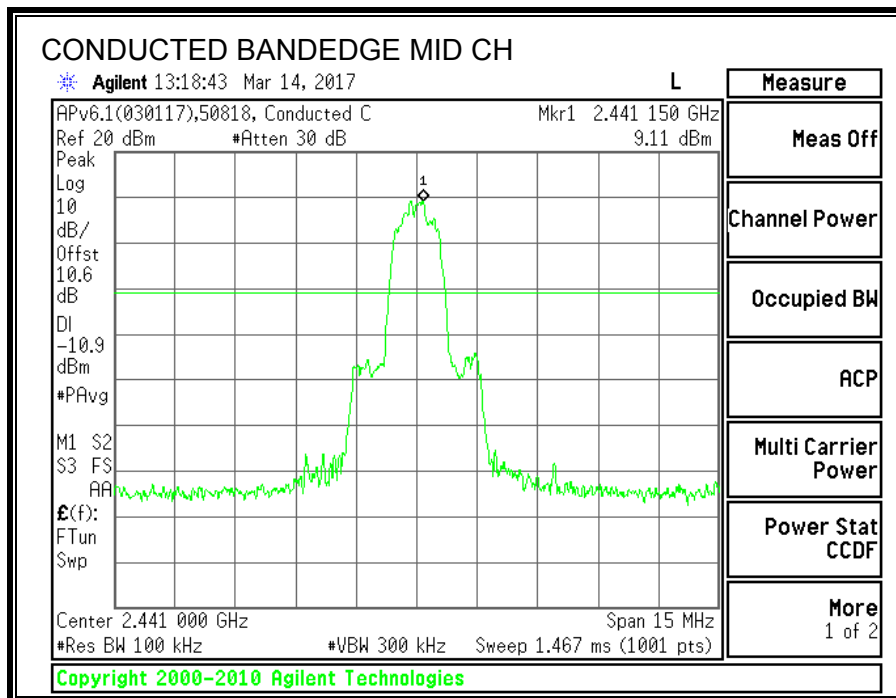
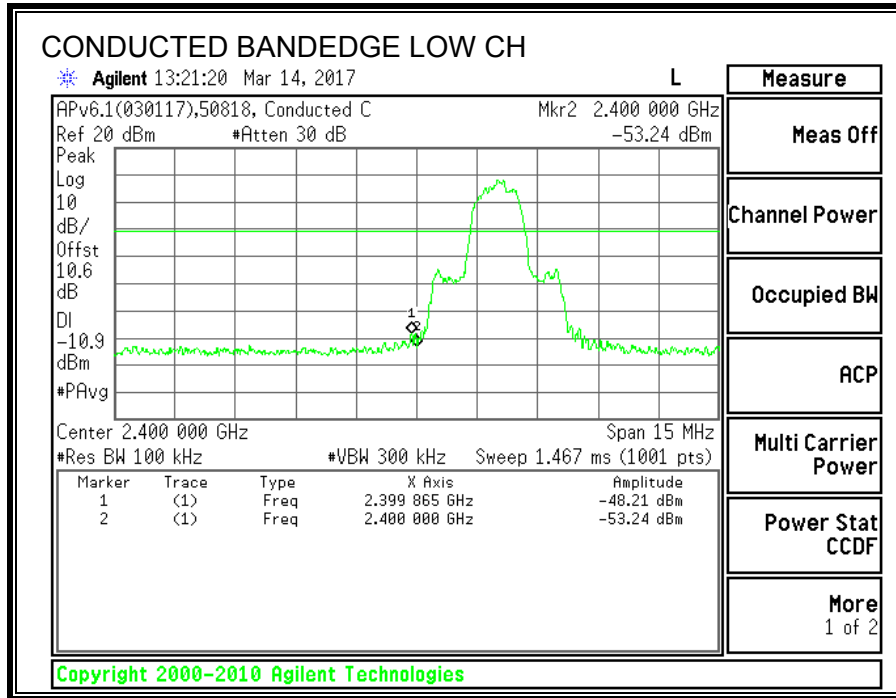

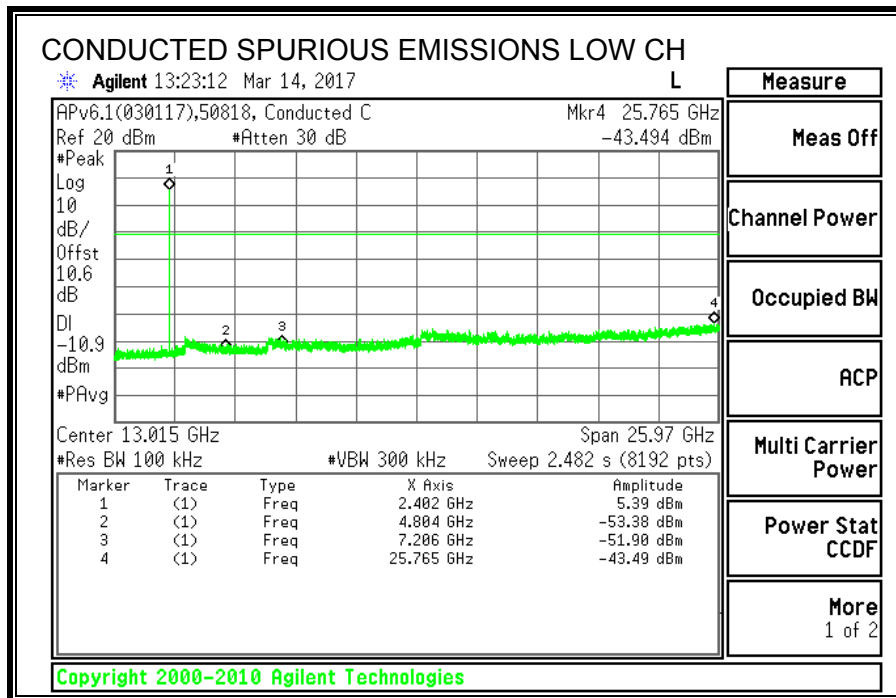
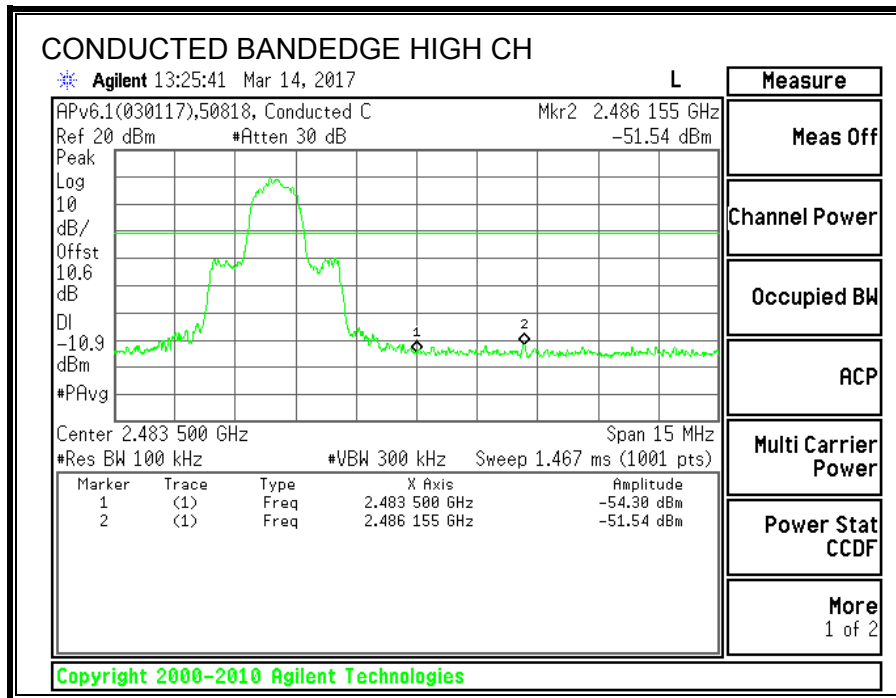



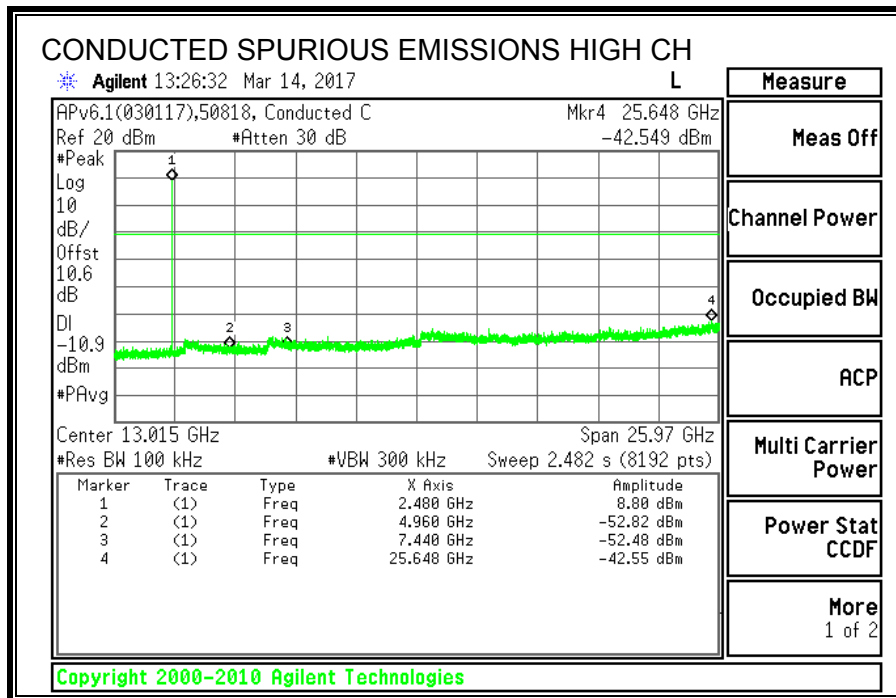
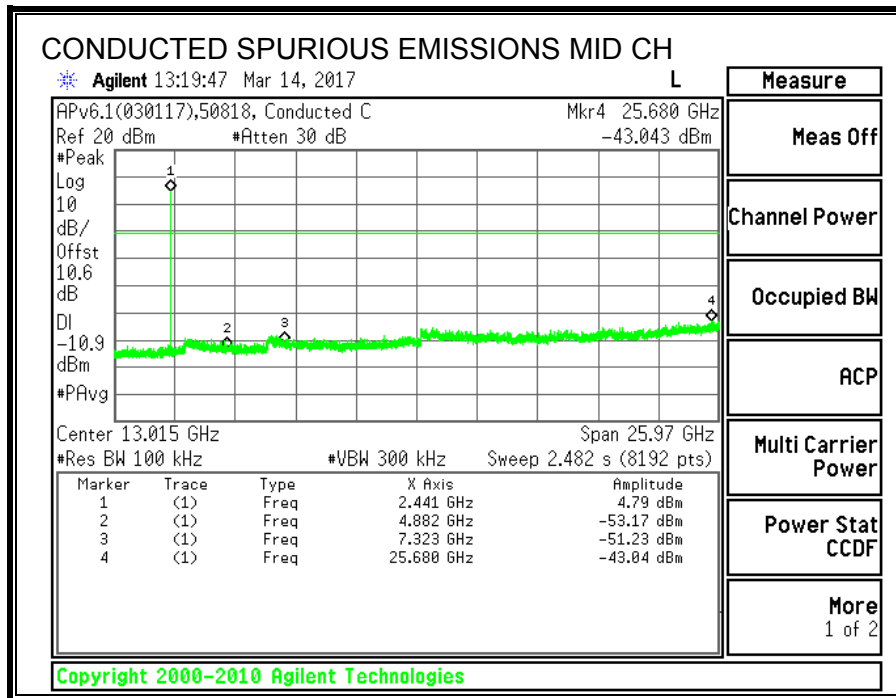

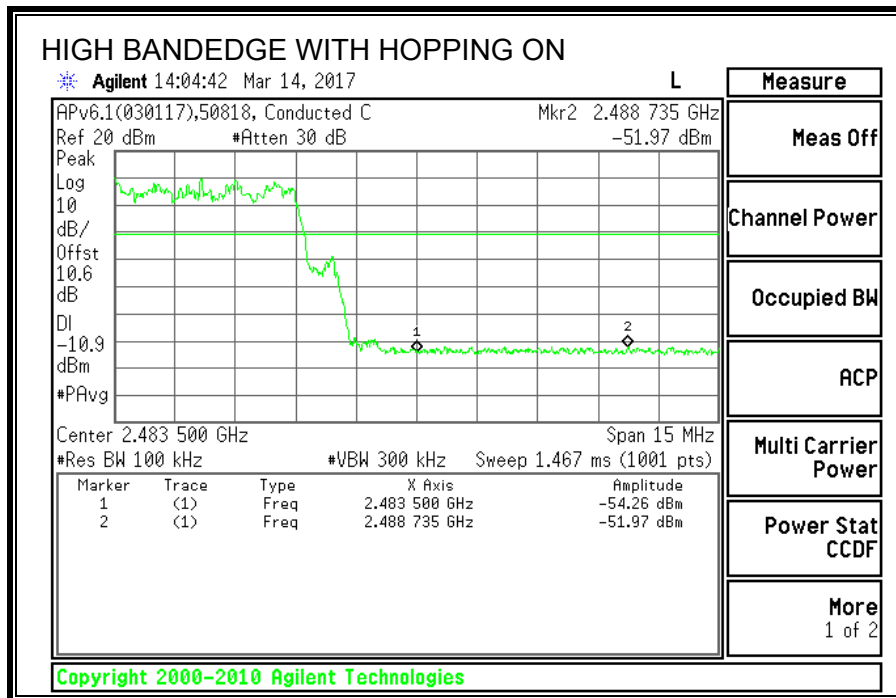
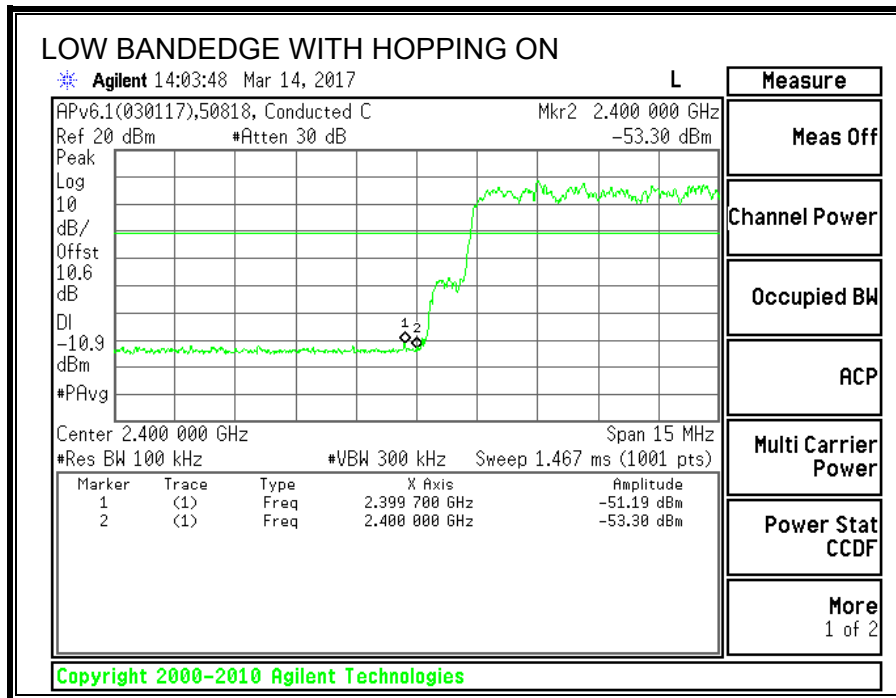

## 8. RADIATED TEST RESULTS

### 8.1. LIMITS AND PROCEDURE

#### LIMITS

FCC §15.205 and §15.209

IC RSS-GEN, Section 8.9 and 8.10.

Frequency Range (MHz)	Field Strength Limit (uV/m) at 3 m	Field Strength Limit (dBuV/m) at 3 m
30 - 88	100	40
88 - 216	150	43.5
216 - 960	200	46
Above 960	500	54

#### TEST PROCEDURE

The EUT is placed on a non-conducting table 80 cm above the ground plane for measurement below 1GHz; 1.5 m above the ground plane for measurement above 1GHz. The antenna to EUT distance is 3 meters. The EUT is configured in accordance with ANSI C63.10. The EUT is set to transmit in a continuous mode.

For measurements below 1 GHz the resolution bandwidth is set to 100 kHz for peak detection measurements or 120 kHz for quasi-peak detection measurements. Peak detection is used unless otherwise noted as quasi-peak.

For measurements above 1 GHz the resolution bandwidth is set to 1 MHz, then the video bandwidth is set to 3 MHz for peak measurements and 1 MHz resolution bandwidth with 1/T (10 Hz) video bandwidth with peak detector for average measurements.

The spectrum from 30 MHz to 26 GHz is investigated with the transmitter set to the lowest, middle, and highest channels in the 2.4 GHz band.

The frequency range of interest is monitored at a fixed antenna height and EUT azimuth. The EUT is rotated through 360 degrees to maximize emissions received. The antenna is scanned from 1 to 4 meters above the ground plane to further maximize the emission. Measurements are made with the antenna polarized in both the vertical and the horizontal positions.

#### RESULTS

## 8.2. BASIC DATA RATE GFSK MODULATION

### 8.2.1. RESTRICTED BANDEDGE (LOW CHANNEL)

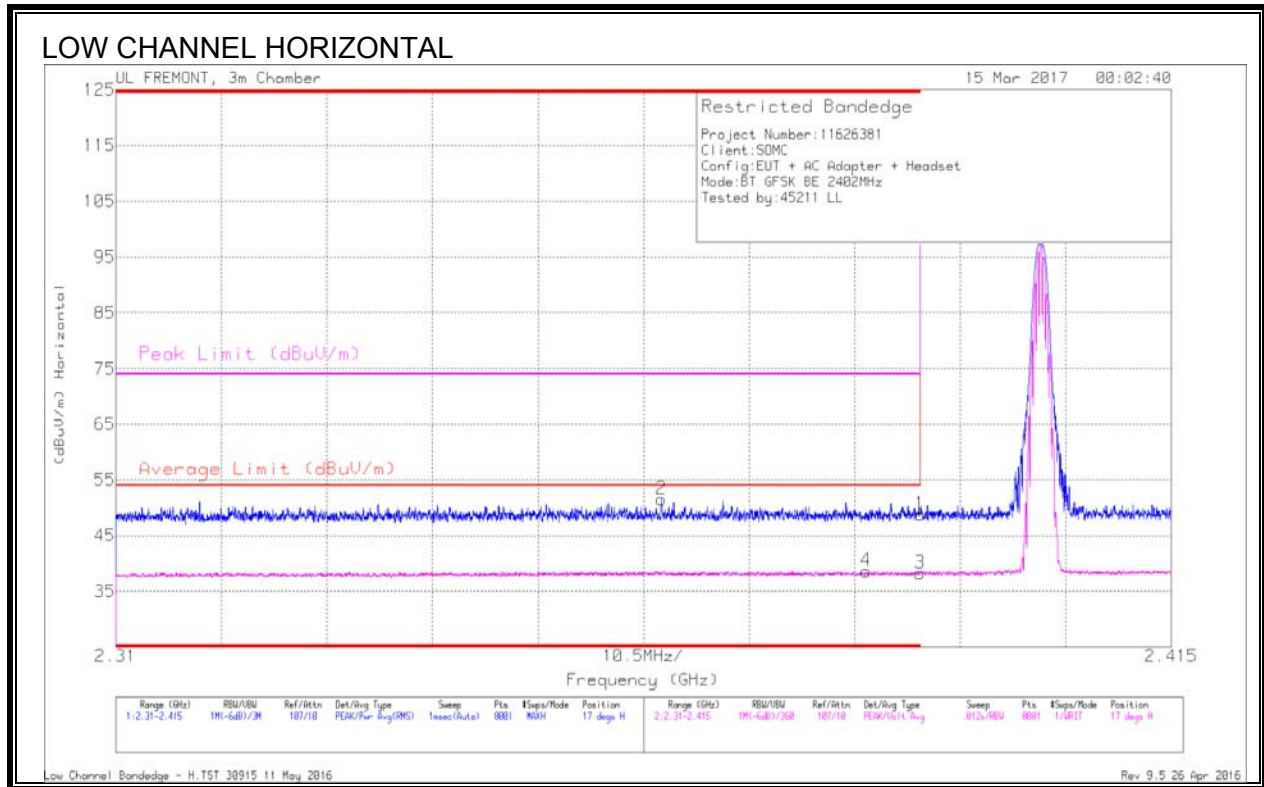

Marker	Frequency (GHz)	Meter Reading (dBUV)	Det	AF T712 (dB/m)	Amp/CbI/Fitr/Pad (dB)	Corrected Reading (dBUV/m)	Average Limit (dBUV/m)	Margin (dB)	Peak Limit (dBUV/m)	PK Margin (dB)	Azimuth (Degs)	Height (cm)	Polarity
2	* 2.364	40.48	Pk	31.9	-20.8	51.58	-	-	74	-22.42	17	186	H
4	* 2.385	27.68	VA1T	31.9	-20.9	38.68	54	-15.32	-	-	17	186	H
1	* 2.39	37.75	Pk	31.9	-20.8	48.85	-	-	74	-25.15	17	186	H
3	* 2.39	27.1	VA1T	31.9	-20.8	38.2	54	-15.8	-	-	17	186	H

\* - indicates frequency in CFR15.205/RSS-GEN 8.10 -Restricted Band

Pk - Peak detector

VA1T - FHSS: Linear Voltage Average  $V_B = 1/T_{on}$  where:  $T_{on}$  is transmit duration

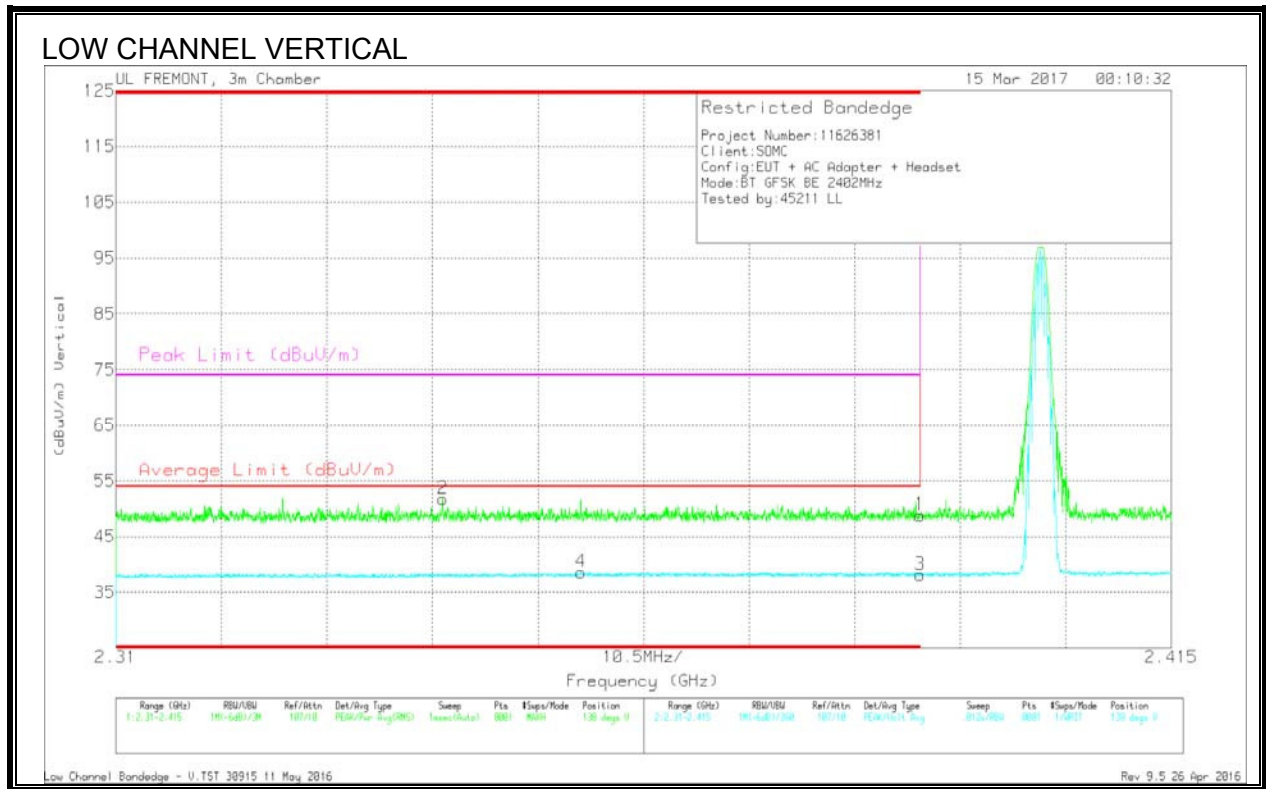

Marker	Frequenc y (GHz)	Meter Reading (dBuV)	Det	AF T712 (dB/m)	Amp/Cbl/Fitr/Pad (dB)	Correcte d Reading (dBuV/m)	Average Limit (dBuV/m)	Margin (dB)	Peak Limit (dBuV/m)	PK Margin (dB)	Azimuth (Degs)	Height (cm)	Polarity
2	* 2.343	40.92	Pk	31.8	-20.9	51.82	-	-	74	-22.18	138	220	V
4	* 2.356	27.55	VA1T	31.9	-20.8	38.65	54	-15.35	-	-	138	220	V
1	* 2.39	37.76	Pk	31.9	-20.8	48.86	-	-	74	-25.14	138	220	V
3	* 2.39	26.99	VA1T	31.9	-20.8	38.09	54	-15.91	-	-	138	220	V

\* - indicates frequency in CFR15.205/RSS-GEN 8.10 -Restricted Band  
 Pk - Peak detector  
 VA1T - FHSS: Linear Voltage Average VB=1/Ton where: Ton is transmit duration

**8.2.2. AUTHORIZED BANDEDGE (HIGH CHANNEL)**

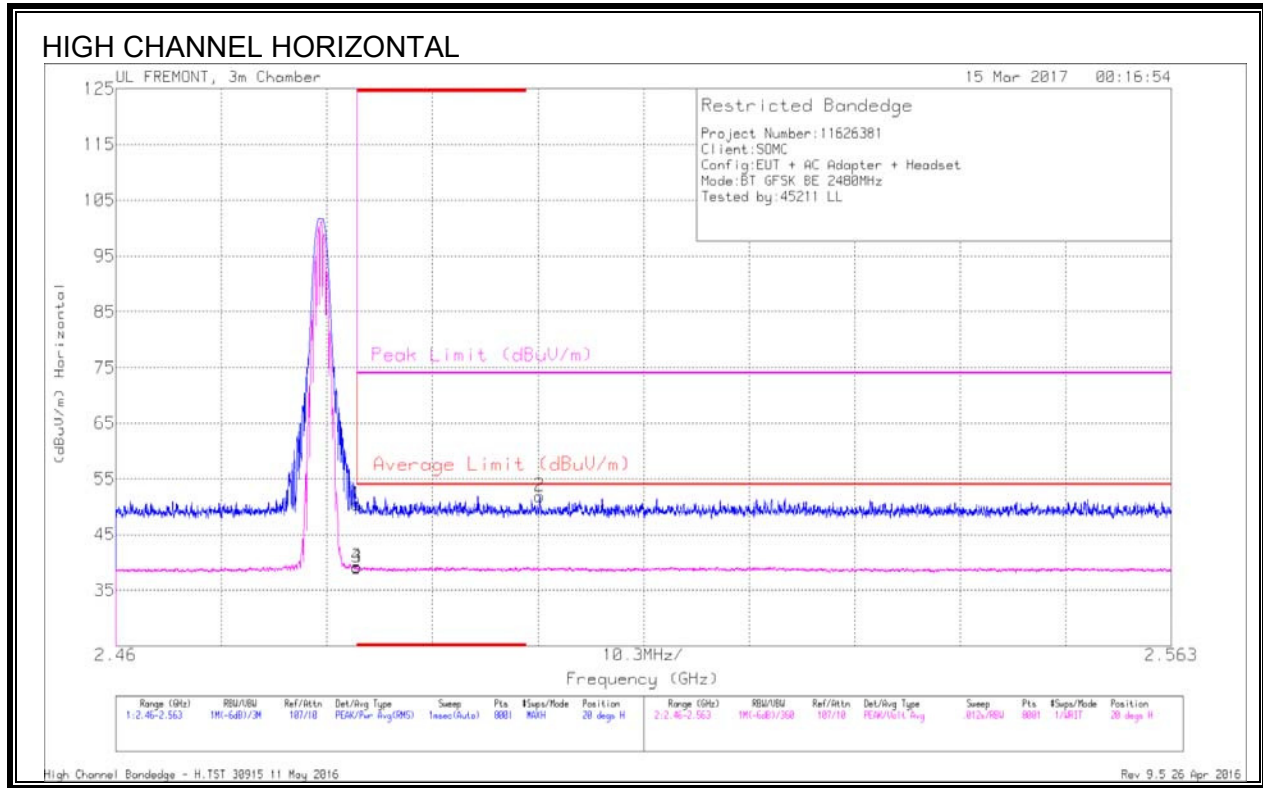

Marker	Frequency (GHz)	Meter Reading (dBuV)	Det	AF T712 (dB/m)	Amp/CbI/Fitr/Pad (dB)	Corrected Reading (dBuV/m)	Average Limit (dBuV/m)	Margin (dB)	Peak Limit (dBuV/m)	PK Margin (dB)	Azimuth (Degs)	Height (cm)	Polarity
1	* 2.484	38.84	Pk	32.4	-20.8	50.44	-	-	74	-23.56	20	142	H
3	* 2.484	27.48	VA1T	32.4	-20.8	39.08	54	-14.92	-	-	20	142	H
4	* 2.484	27.69	VA1T	32.4	-20.8	39.29	54	-14.71	-	-	20	142	H
2	2.501	40.26	Pk	32.5	-20.8	51.96	-	-	74	-22.04	20	142	H

\* - indicates frequency in CFR15.205/RSS-GEN 8.10 -Restricted Band  
 Pk - Peak detector  
 VA1T - FHSS: Linear Voltage Average VB=1/Ton where: Ton is transmit duration

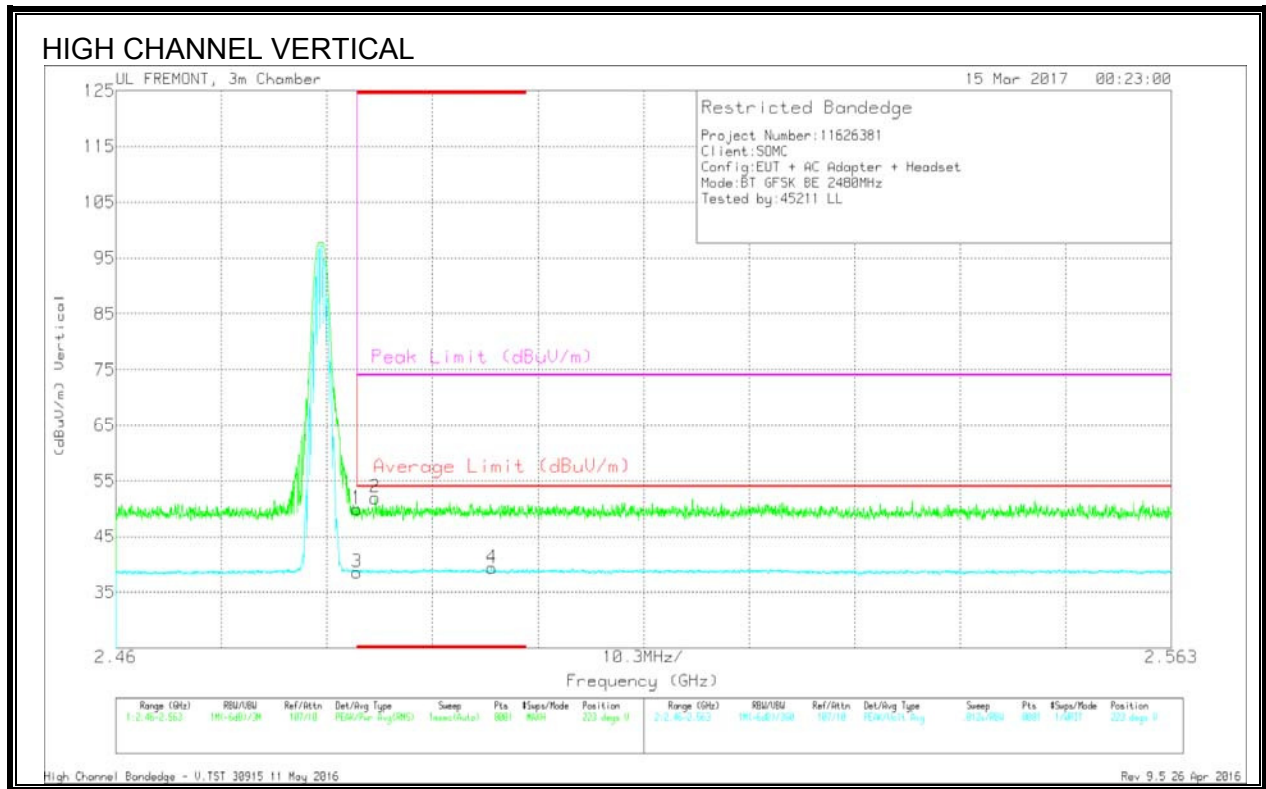

Marker	Frequenc y (GHz)	Meter Reading (dBuV)	Det	AF T712 (dB/m)	Amp/Cbl/Fitr/Pad (dB)	Correcte d Reading (dBuV/m)	Average Limit (dBuV/m)	Margin (dB)	Peak Limit (dBuV/m)	PK Margin (dB)	Azimuth (Degs)	Height (cm)	Polarity
1	* 2.484	38.38	Pk	32.4	-20.8	49.98	-	-	74	-24.02	223	192	V
3	* 2.484	27	VA1T	32.4	-20.8	38.6	54	-15.4	-	-	223	192	V
2	* 2.485	40.47	Pk	32.4	-20.9	51.97	-	-	74	-22.03	223	192	V
4	* 2.497	27.7	VA1T	32.5	-20.8	39.4	54	-14.6	-	-	223	192	V

\* - indicates frequency in CFR15.205/RSS-GEN 8.10 -Restricted Band  
 Pk - Peak detector  
 VA1T - FHSS: Linear Voltage Average VB=1/Ton where: Ton is transmit duration



### 8.2.3. HARMONICS AND SPURIOUS EMISSIONS

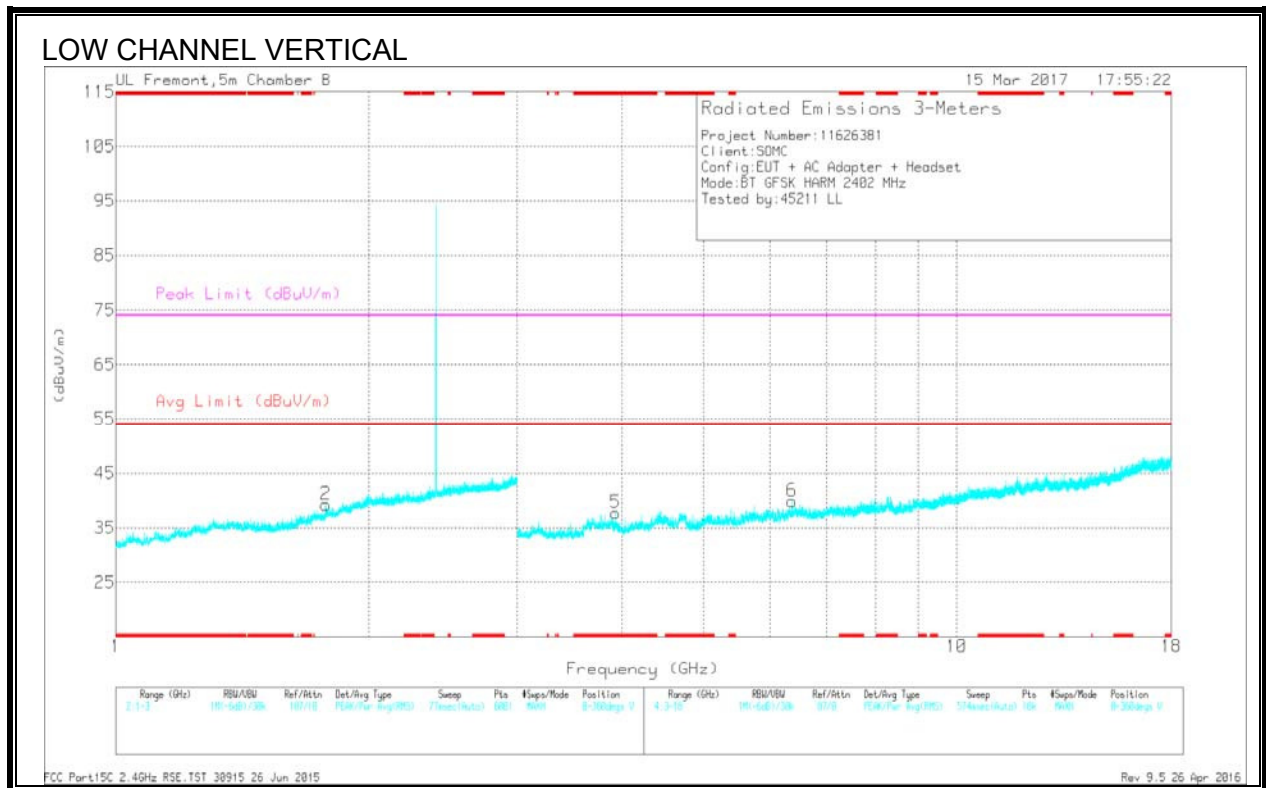
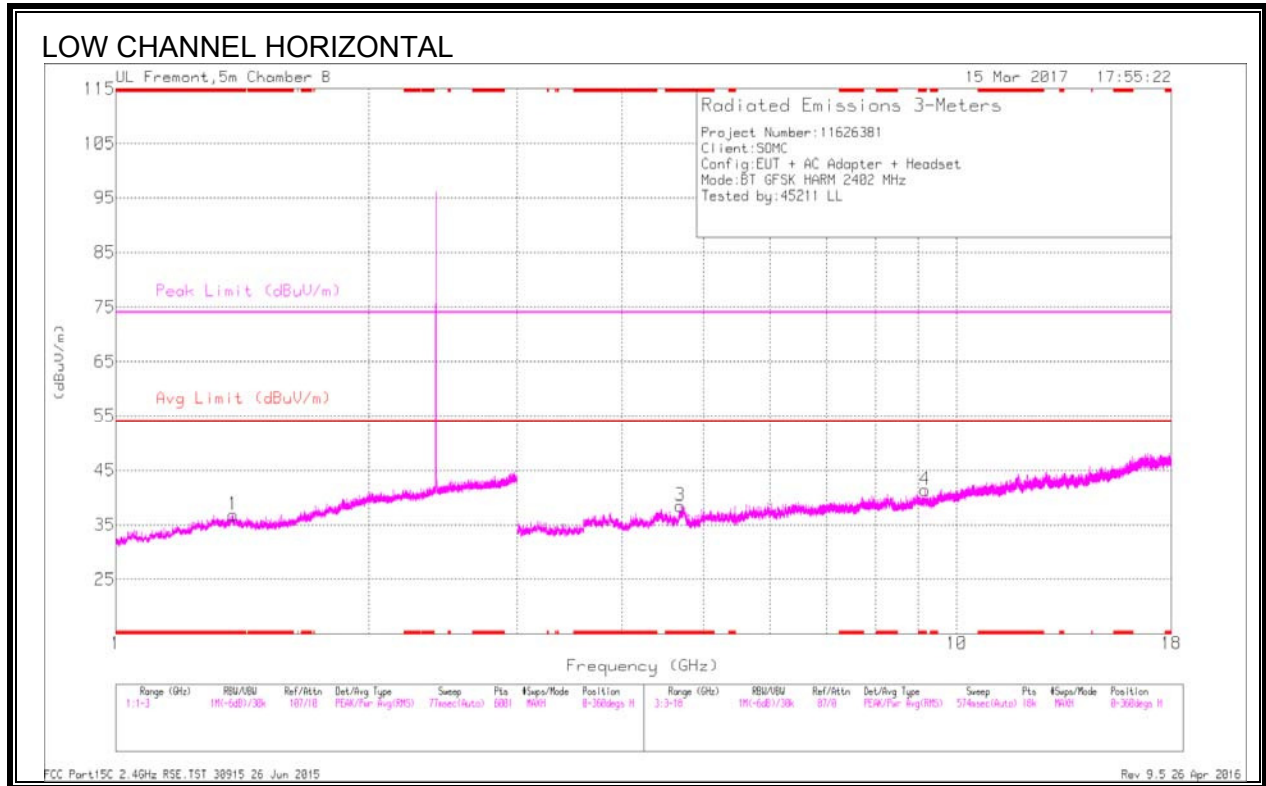



Frequency (GHz)	Meter Reading (dBuV)	Det	AF T345 (dB/m)	Amp/Cb/Filtr/Prod (dB)	Corrected Reading (dBuV/m)	Avg Limit (dBuV/m)	Margin (dB)	Peak Limit (dBuV/m)	PK Margin (dB)	Azimuth (Degs)	Height (cm)	Polarity
* 1.38	33.79	PKFH	28.9	-21.8	40.89	-	-	74	-33.11	241	203	H
* 1.38	22.63	VA1T	28.9	-21.9	29.63	54	-24.37	-	-	241	203	H
* 4.688	38.64	PKFH	34.1	-29.8	42.94	-	-	74	-31.06	287	123	H
* 4.686	27.24	VA1T	34.1	-29.8	31.54	54	-22.46	-	-	287	123	H
* 9.177	33.83	PKFH	36.3	-24.7	45.43	-	-	74	-28.57	252	100	H
* 9.176	22.37	VA1T	36.3	-24.8	33.87	54	-20.13	-	-	252	100	H
* 3.93	38.79	PKFH	33.3	-29.9	42.19	-	-	74	-31.81	174	119	V
* 3.928	26.82	VA1T	33.3	-29.9	30.22	54	-23.78	-	-	174	119	V
1.777	22.57	VA1T	29.9	-21	31.47	54	-22.53	-	-	256	110	V
1.778	34.28	PKFH	29.9	-21	43.18	-	-	74	-30.82	256	110	V
6.373	36.94	PKFH	35.6	-29	43.54	-	-	74	-30.46	146	203	V
6.374	25.84	VA1T	35.6	-29	32.44	54	-21.56	-	-	146	203	V

\* - indicates frequency in CFR15.205/RSS-GEN 8.10 -Restricted Band  
 PKFH - FHSS: RB=100k/1MHz VB=3 x RB, Peak  
 VA1T - FHSS: Linear Voltage Average VB=1/Ton where: Ton is transmit duration

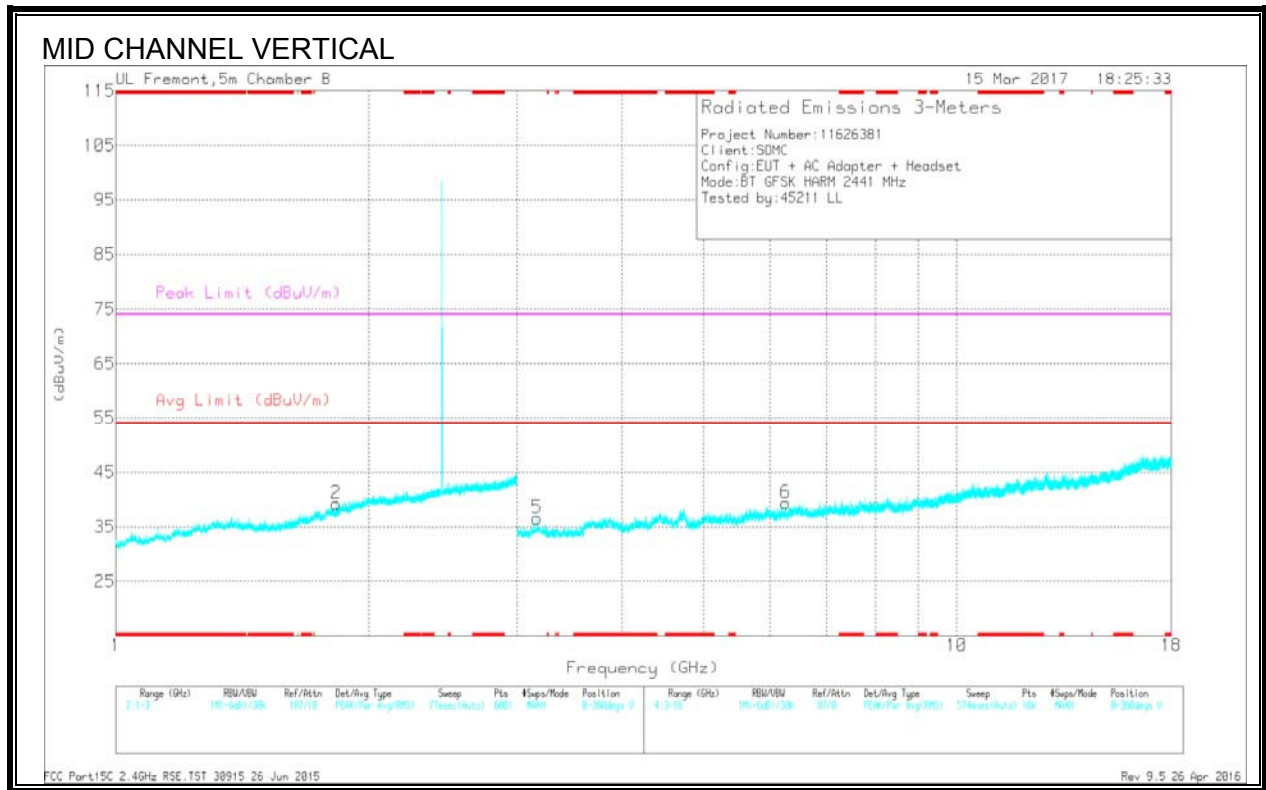
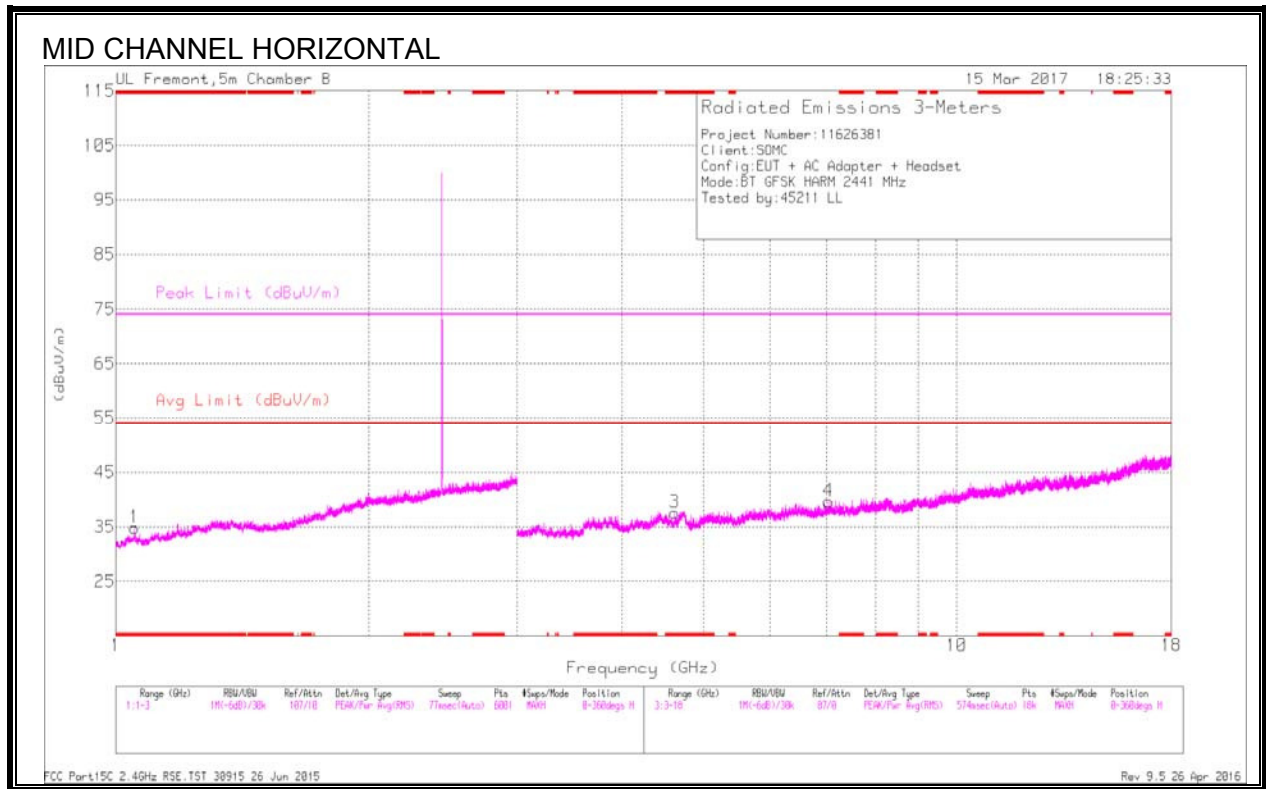

Frequency (GHz)	Meter Reading (dBuV)	Det	AF T345 (dB/m)	Amp/Cbl/Filtr/PA d (dB)	Corrected Reading (dBuV/m)	Avg Limit (dBuV/m)	Margin (dB)	Peak Limit (dBuV/m)	PK Margin (dB)	Azimuth (Degs)	Height (cm)	Polarity
* 1.052	34.47	PKFH	27.8	-23	39.27	-	-	74	-34.73	120	218	H
* 1.055	22.39	VA1T	27.8	-23.1	27.09	54	-26.91	-	-	120	218	H
* 4.617	37.75	PKFH	34.1	-30.6	41.25	-	-	74	-32.75	95	151	H
* 4.616	26.92	VA1T	34.1	-30.6	30.42	54	-23.58	-	-	95	151	H
1.825	22.45	VA1T	30.3	-21.2	31.55	54	-	-	-	156	192	V
1.827	33.66	PKFH	30.3	-21.2	42.76	-	-	74	-	156	192	V
3.167	26.23	VA1T	32.9	-30.1	29.03	54	-24.97	-	-	259	130	V
3.168	37.34	PKFH	32.9	-30.1	40.14	-	-	74	-33.86	259	130	V
6.262	36.67	PKFH	35.5	-28.6	43.57	-	-	74	-30.43	246	111	V
6.264	25.13	VA1T	35.5	-28.6	32.03	54	-21.97	-	-	246	111	V
7.042	24.32	VA1T	35.5	-27.6	32.22	54	-21.78	-	-	212	110	H
7.043	36.26	PKFH	35.5	-27.6	44.16	-	-	74	-29.84	212	110	H

\* - indicates frequency in CFR15.205/RSS-GEN 8.10 -Restricted Band  
 PKFH - FHSS: RB=100k/1MHz VB=3 x RB, Peak  
 VA1T - FHSS: Linear Voltage Average VB=1/Ton where: Ton is transmit duration

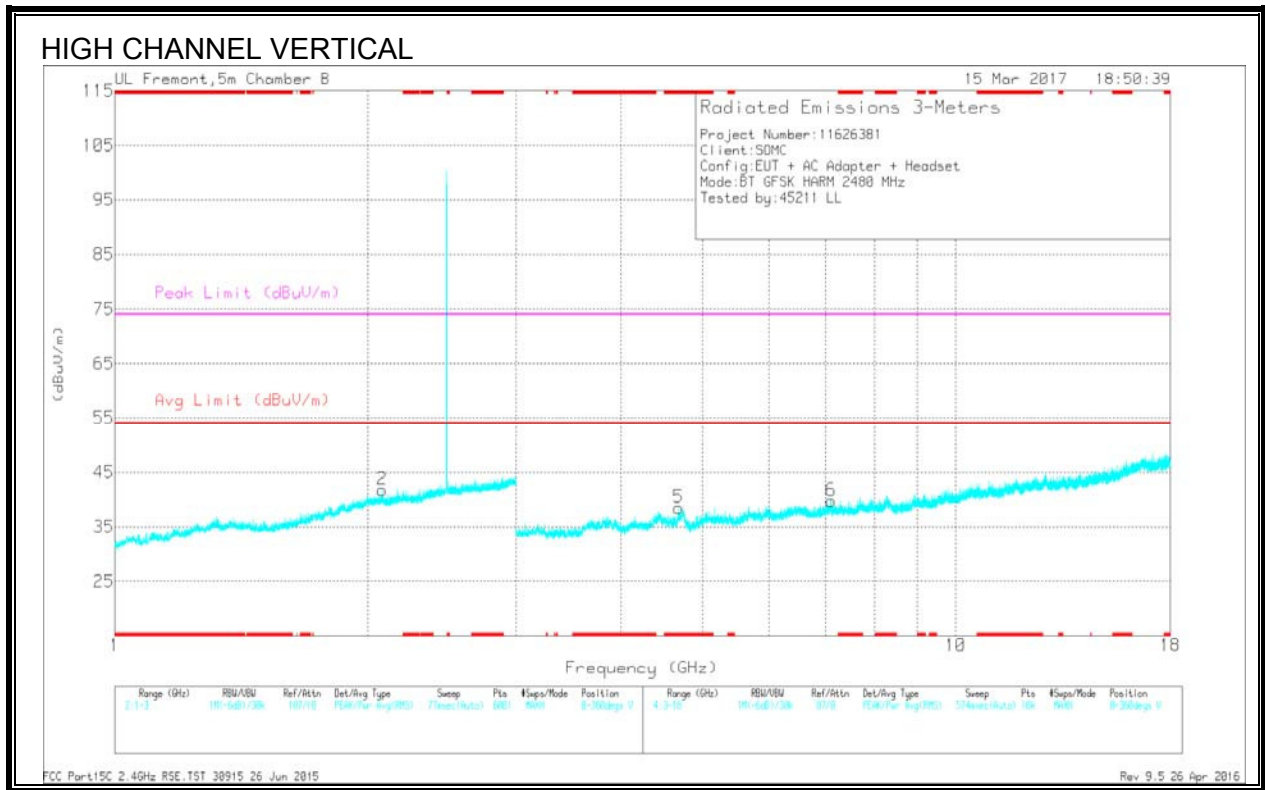
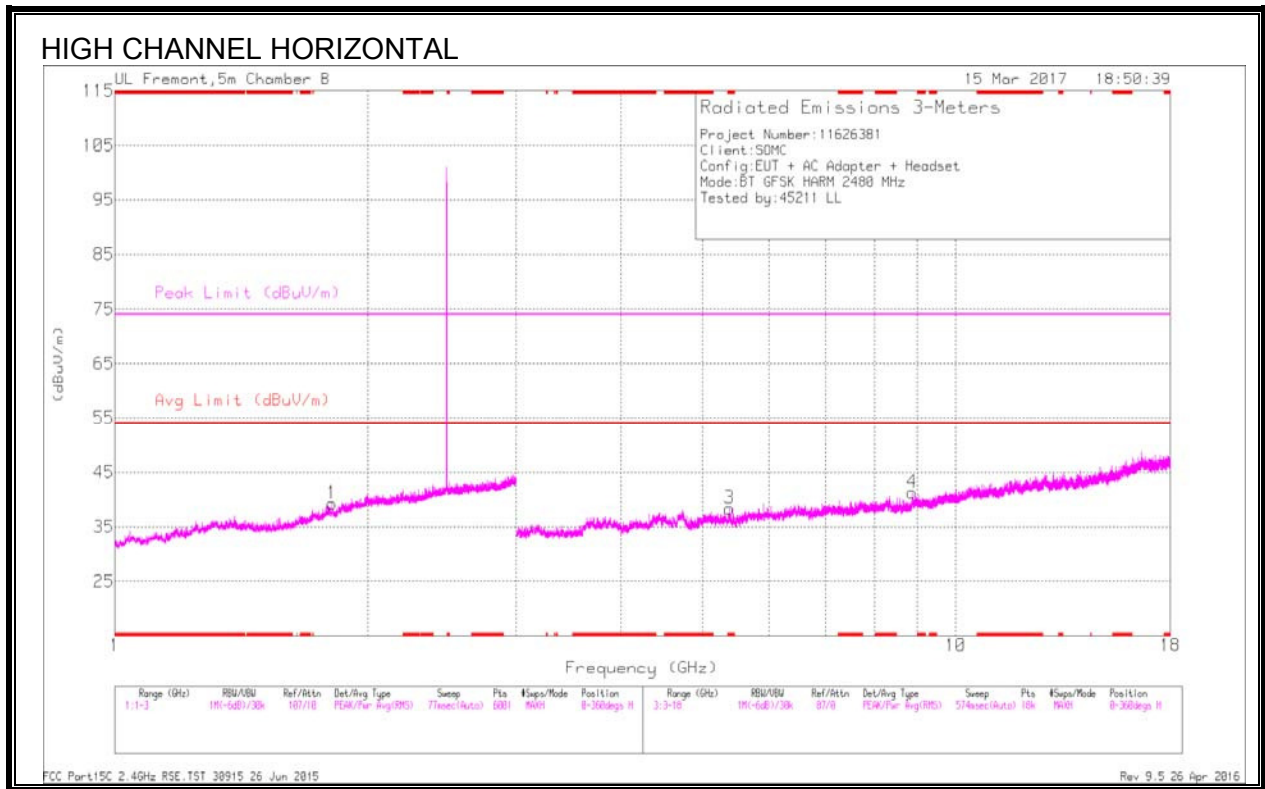

Frequency (GHz)	Meter Reading (dBuV)	Det	AF T345 (dB/m)	Amp/Cbl/Filtr/PA d (dB)	Corrected Reading (dBuV/m)	Avg Limit (dBuV/m)	Margin (dB)	Peak Limit (dBuV/m)	PK Margin (dB)	Azimuth (Degs)	Height (cm)	Polarity
* 5.385	36.48	PKFH	34.5	-28.5	42.48	-	-	74	-31.52	300	159	H
* 5.387	25.39	VA1T	34.5	-28.6	31.29	54	-22.71	-	-	300	159	H
* 4.682	38.61	PKFH	34.1	-29.8	42.91	-	-	74	-31.09	5	139	V
* 4.684	27.23	VA1T	34.1	-29.8	31.53	54	-22.47	-	-	5	139	V
1.811	22.54	VA1T	30.2	-20.9	31.84	54	-22.16	-	-	342	126	H
1.812	34.5	PKFH	30.2	-21	43.7	-	-	74	-30.3	342	126	H
2.078	34.79	PKFH	31.3	-20.8	45.29	-	-	74	-	302	184	V
2.08	23.17	VA1T	31.3	-20.9	33.57	54	-20.43	-	-	302	184	V
7.106	35.2	PKFH	35.5	-27	43.7	-	-	74	-30.3	58	157	V
7.106	23.77	VA1T	35.5	-27	32.27	54	-21.73	-	-	58	157	V
8.879	22.84	VA1T	36	-24.9	33.94	54	-20.06	-	-	33	199	H
8.88	34.4	PKFH	36	-24.9	45.5	-	-	74	-28.5	33	199	H

\* - indicates frequency in CFR15.205/RSS-GEN 8.10 -Restricted Band

PKFH - FHSS: RB=100k/1MHz VB=3 x RB, Peak

VA1T - FHSS: Linear Voltage Average VB=1/Ton where: Ton is transmit duration

### 8.3. ENHANCED DATA RATE 8PSK MODULATION

#### 8.3.1. RESTRICTED BANDEDGE (LOW CHANNEL)

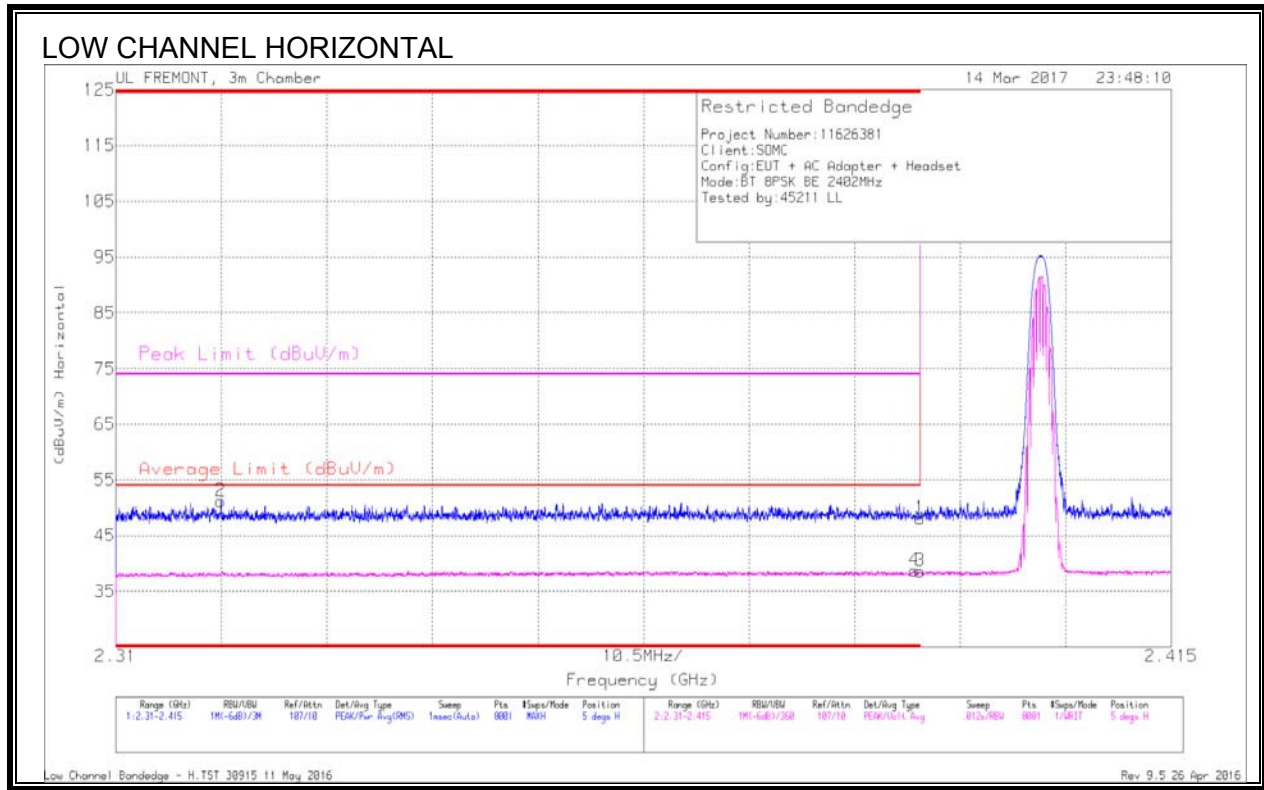

Marker	Frequency (GHz)	Meter Reading (dBuV)	Det	AF T712 (dB/m)	Amp/Cb/Fitr/Pad (dB)	Corrected Reading (dBuV/m)	Average Limit (dBuV/m)	Margin (dB)	Peak Limit (dBuV/m)	PK Margin (dB)	Azimuth (Degs)	Height (cm)	Polarity
2	* 2.32	40.25	Pk	31.8	-20.9	51.15	-	-	74	-22.85	5	182	H
4	* 2.389	27.6	VA1T	31.9	-20.8	38.7	54	-15.3	-	-	5	182	H
1	* 2.39	36.95	Pk	31.9	-20.8	48.05	-	-	74	-25.95	5	182	H
3	* 2.39	27.47	VA1T	31.9	-20.8	38.57	54	-15.43	-	-	5	182	H

\* - indicates frequency in CFR15.205/RSS-GEN 8.10 -Restricted Band

Pk - Peak detector

VA1T - FHSS: Linear Voltage Average  $V_B = 1/T_{on}$  where:  $T_{on}$  is transmit duration

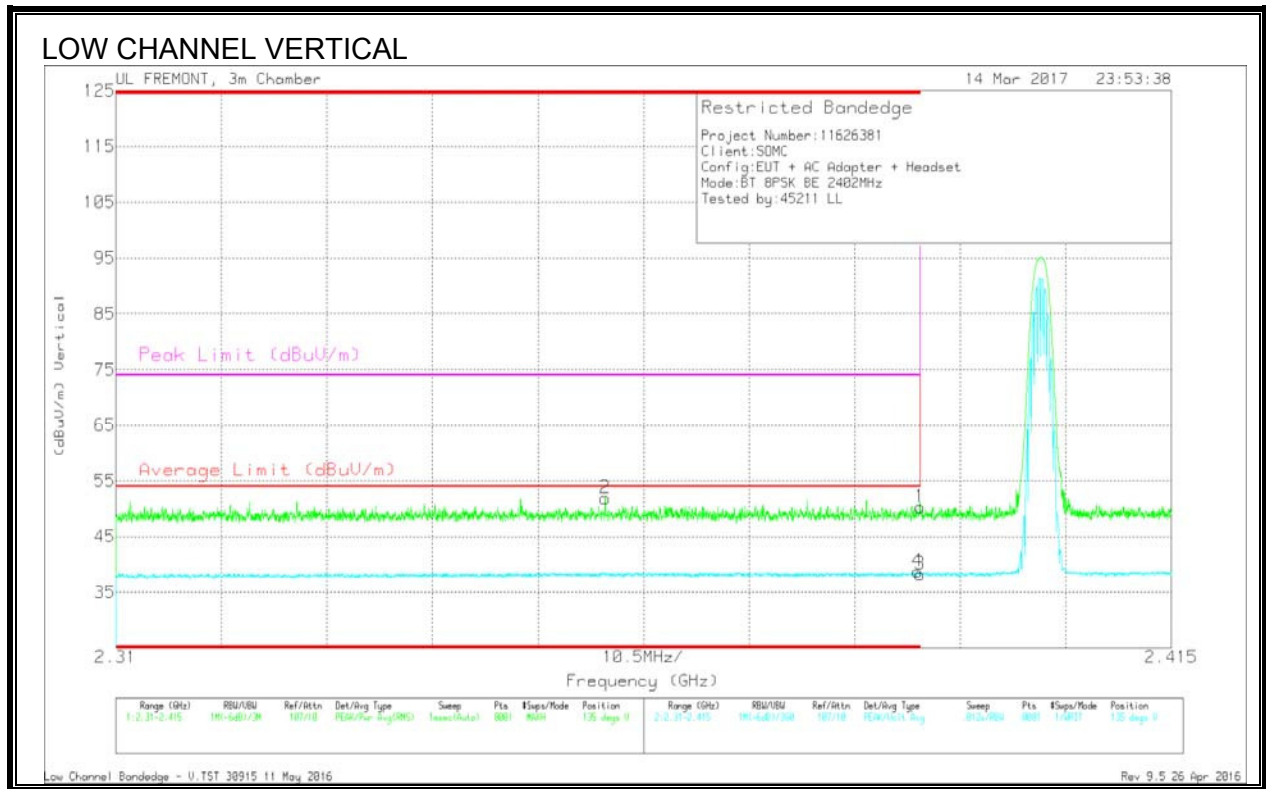

Marker	Frequenc y (GHz)	Meter Reading (dBuV)	Det	AF T712 (dB/m)	Amp/Cbl/Fitr/Pad (dB)	Correcte d Reading (dBuV/m)	Average Limit (dBuV/m)	Margin (dB)	Peak Limit (dBuV/m)	PK Margin (dB)	Azimuth (Degs)	Height (cm)	Polarity
2	* 2.359	40.87	Pk	31.9	-20.9	51.87	-	-	74	-22.13	135	219	V
1	* 2.39	39.23	Pk	31.9	-20.8	50.33	-	-	74	-23.67	135	219	V
3	* 2.39	27.13	VA1T	31.9	-20.8	38.23	54	-15.77	-	-	135	219	V
4	* 2.39	27.62	VA1T	31.9	-20.8	38.72	54	-15.28	-	-	135	219	V

\* - indicates frequency in CFR15.205/RSS-GEN 8.10 -Restricted Band

Pk - Peak detector

VA1T - FHSS: Linear Voltage Average VB=1/Ton where: Ton is transmit duration

**8.3.2. AUTHORIZED BANDEDGE (HIGH CHANNEL)**

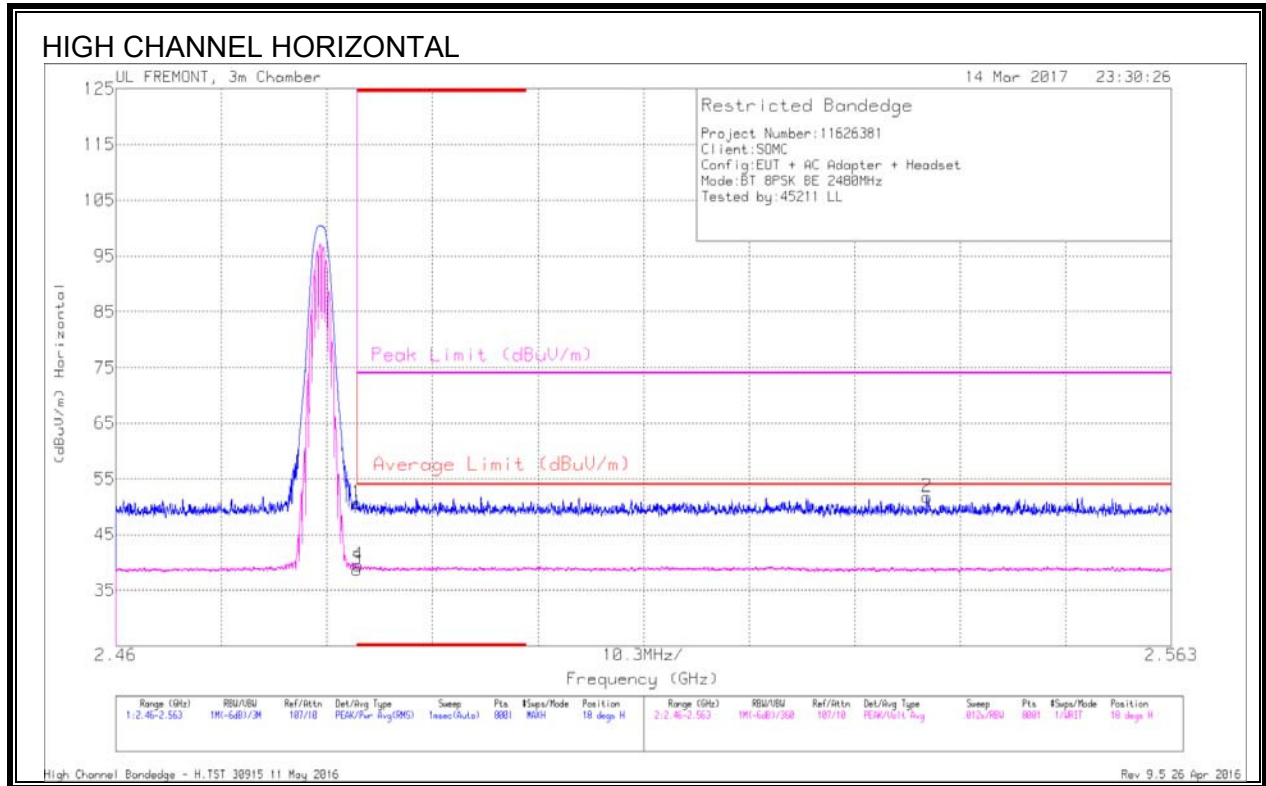

Marker	Frequency (GHz)	Meter Reading (dBuV)	Det	AF T712 (dB/m)	Amp/Cbl/Fitr/Pad (dB)	Corrected Reading (dBuV/m)	Average Limit (dBuV/m)	Margin (dB)	Peak Limit (dBuV/m)	PK Margin (dB)	Azimuth (Degs)	Height (cm)	Polarity
1	* 2.484	39.1	Pk	32.4	-20.8	50.7	-	-	74	-23.3	18	143	H
3	* 2.484	27.17	VA1T	32.4	-20.8	38.77	54	-15.23	-	-	18	143	H
4	* 2.484	27.92	VA1T	32.4	-20.8	39.52	54	-14.48	-	-	18	143	H
2	2.539	40.15	Pk	32.4	-20.8	51.75	-	-	74	-22.25	18	143	H

\* - indicates frequency in CFR15.205/RSS-GEN 8.10 -Restricted Band  
 Pk - Peak detector  
 VA1T - FHSS: Linear Voltage Average VB=1/Ton where: Ton is transmit duration



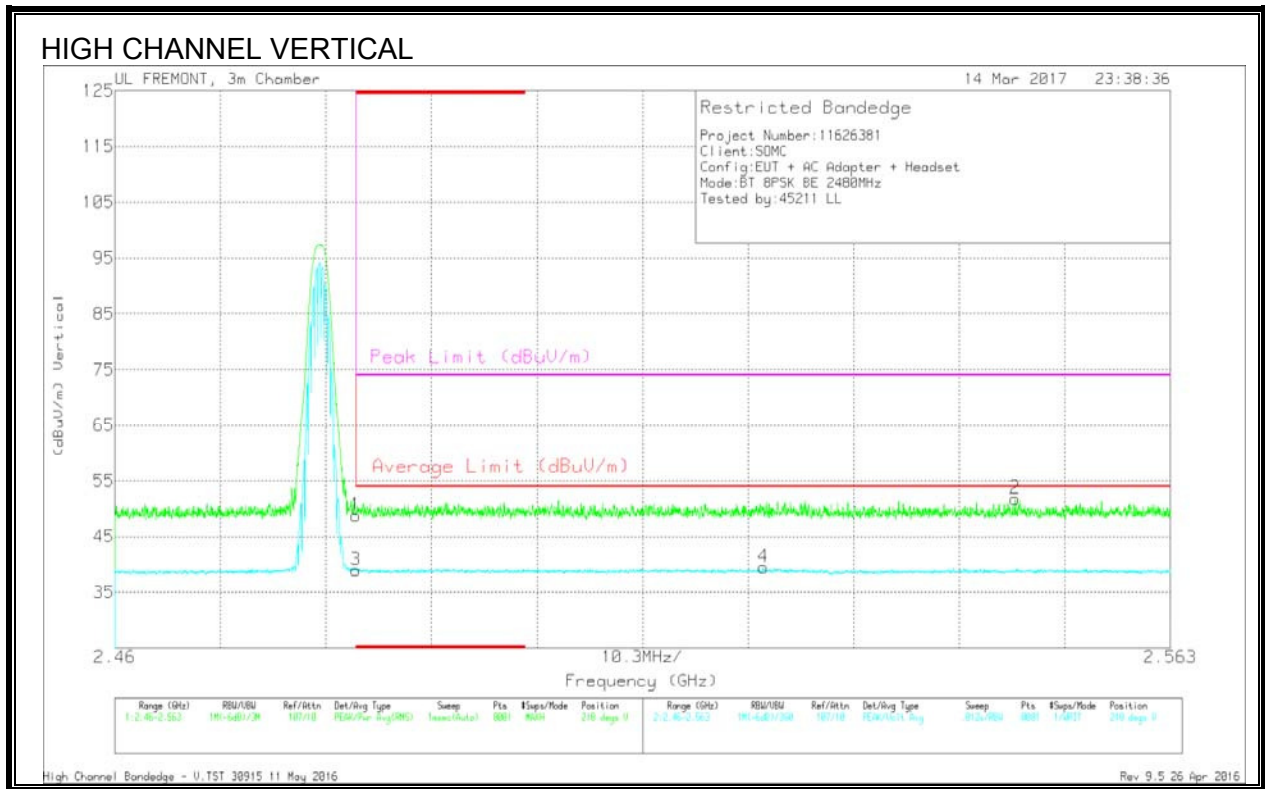

Marker	Frequency (GHz)	Meter Reading (dBuV)	Det	AF T712 (dB/m)	Amp/Cbl/Fitr/Pad (dB)	Corrected Reading (dBuV/m)	Average Limit (dBuV/m)	Margin (dB)	Peak Limit (dBuV/m)	PK Margin (dB)	Azimuth (Degs)	Height (cm)	Polarity
1	* 2.484	37.25	Pk	32.4	-20.8	48.85	-	-	74	-25.15	218	179	V
3	* 2.484	27.45	VA1T	32.4	-20.8	39.05	54	-14.95	-	-	218	179	V
4	2.523	27.64	VA1T	32.4	-20.6	39.44	54	-14.56	-	-	218	179	V
2	2.548	40.24	Pk	32.4	-20.8	51.84	-	-	74	-22.16	218	179	V

\* - indicates frequency in CFR15.205/RSS-GEN 8.10 -Restricted Band  
 Pk - Peak detector  
 VA1T - FHSS: Linear Voltage Average VB=1/Ton where: Ton is transmit duration

### 8.3.3. HARMONICS AND SPURIOUS EMISSIONS

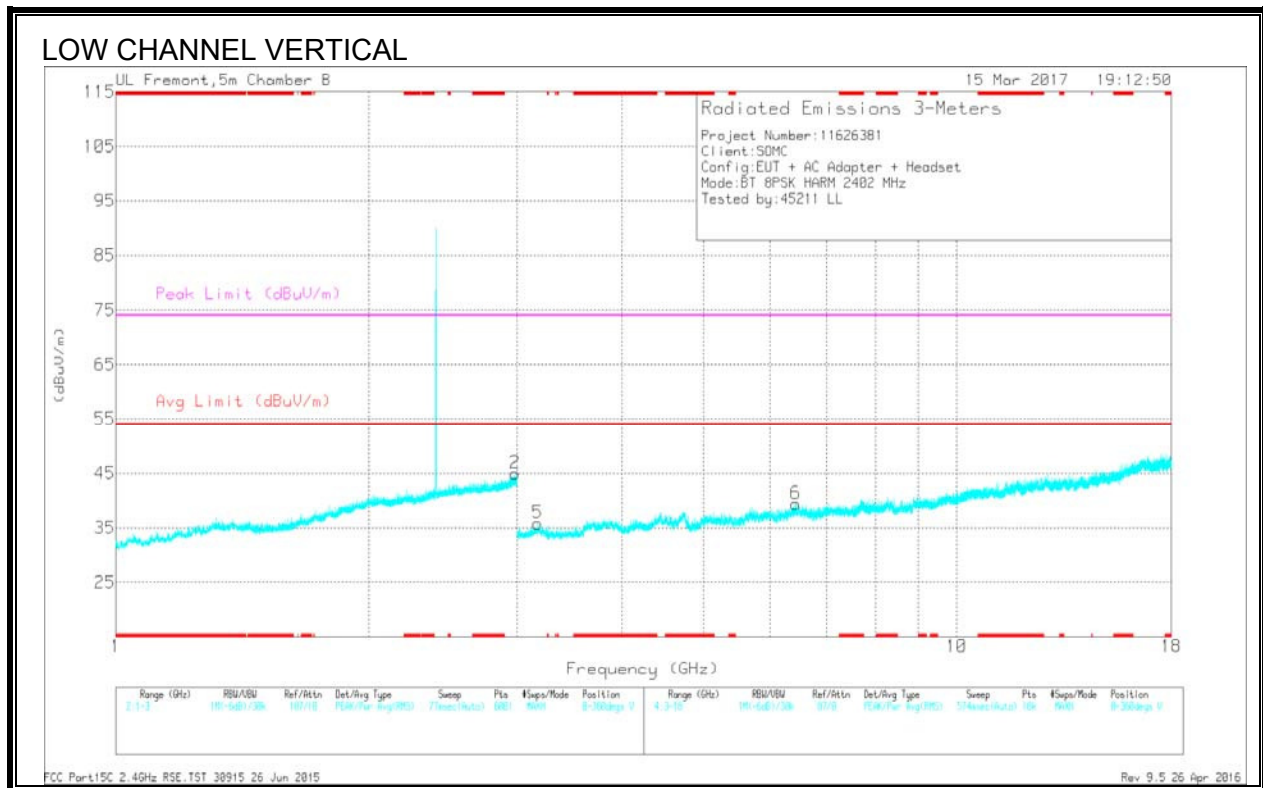
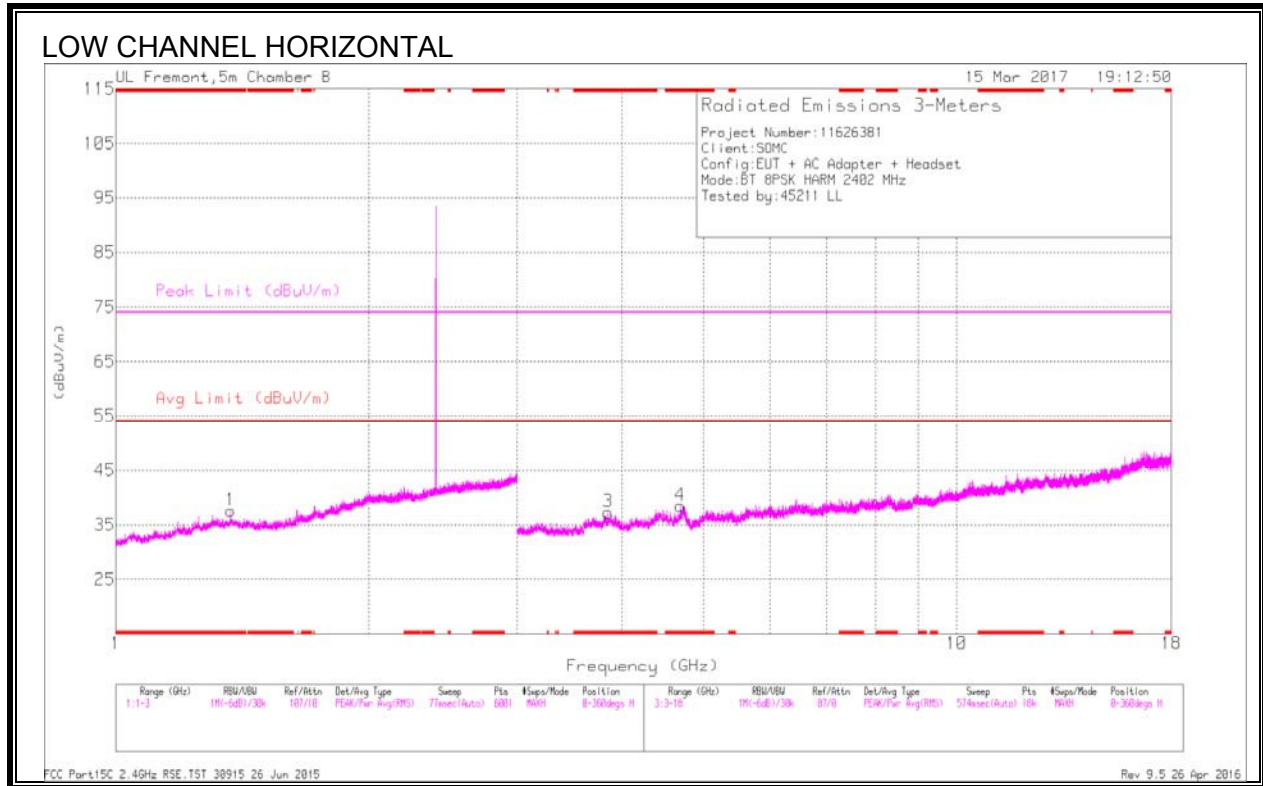

Frequency (GHz)	Meter Reading (dBuV)	Det	AF T345 (dB/m)	Amp/Cbl/Filtr/PA d (dB)	Corrected Reading (dBuV/m)	Avg Limit (dBuV/m)	Margin (dB)	Peak Limit (dBuV/m)	PK Margin (dB)	Azimuth (Degs)	Height (cm)	Polarity
* 1.369	33.88	PKFH	28.9	-21.7	41.08	-	-	74	-32.92	62	190	H
* 1.368	22.45	VA1T	28.9	-21.7	29.65	54	-24.35	-	-	62	190	H
* 3.852	37.71	PKFH	33.4	-30.1	41.01	-	-	74	-32.99	62	202	H
* 3.853	26.88	VA1T	33.4	-30	30.28	54	-23.72	-	-	62	202	H
* 4.692	38.57	PKFH	34.1	-29.7	42.97	-	-	74	-31.03	111	100	H
* 4.691	27.07	VA1T	34.1	-29.7	31.47	54	-22.53	-	-	111	100	H
2.984	35.31	PKFH	32.5	-19.7	48.11	-	-	74	-25.89	62	125	V
2.986	23.87	VA1T	32.5	-19.7	36.67	54	-17.33	-	-	62	125	V
3.172	37.56	PKFH	32.9	-30.1	40.36	-	-	74	-33.64	120	115	V
3.174	26.24	VA1T	32.9	-30.1	29.04	54	-24.96	-	-	120	115	V
6.429	37.2	PKFH	35.6	-28.4	44.4	-	-	74	-29.6	120	126	V
6.432	25.56	VA1T	35.6	-28.2	32.96	54	-21.06	-	-	120	126	V

\* - indicates frequency in CFR15.205/RSS-GEN 8.10 -Restricted Band  
 PKFH - FHSS: RB=100k/1MHz VB=3 x RB, Peak  
 VA1T - FHSS: Linear Voltage Average VB=1/Ton where: Ton is transmit duration

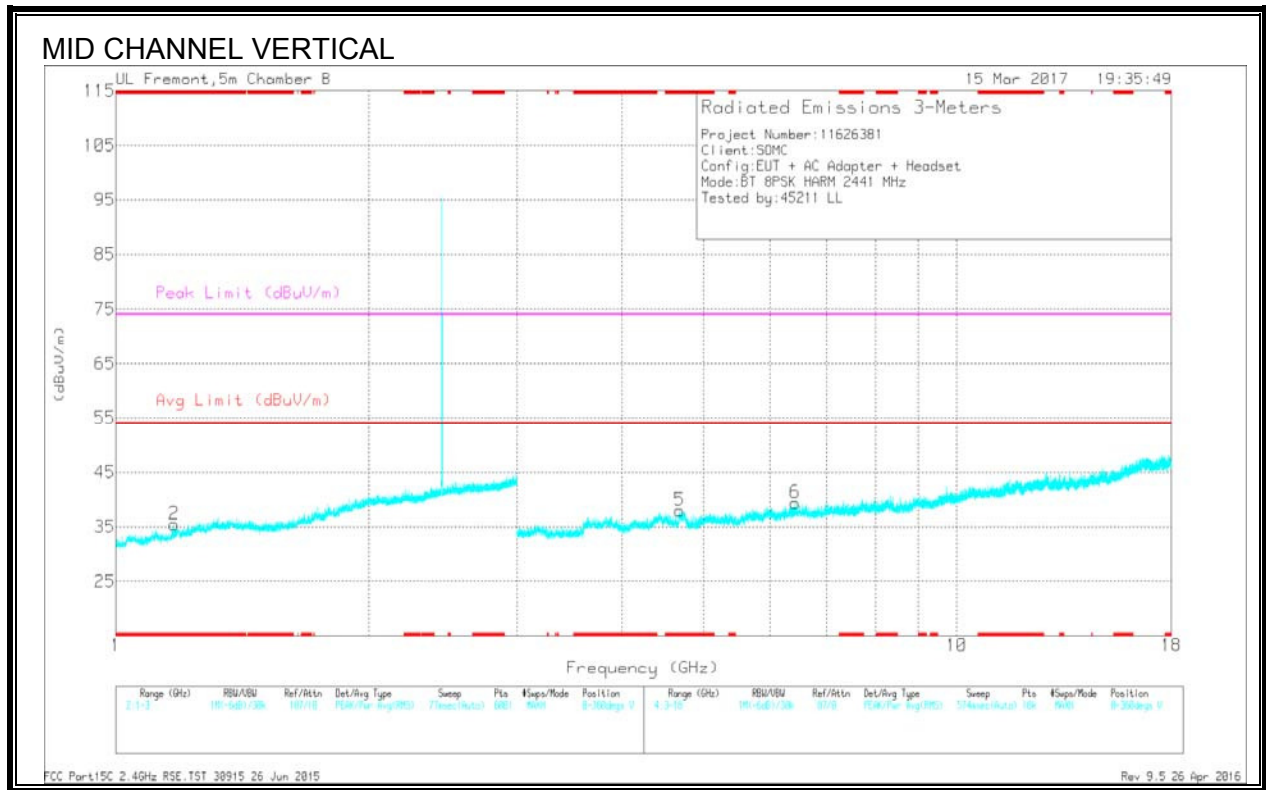
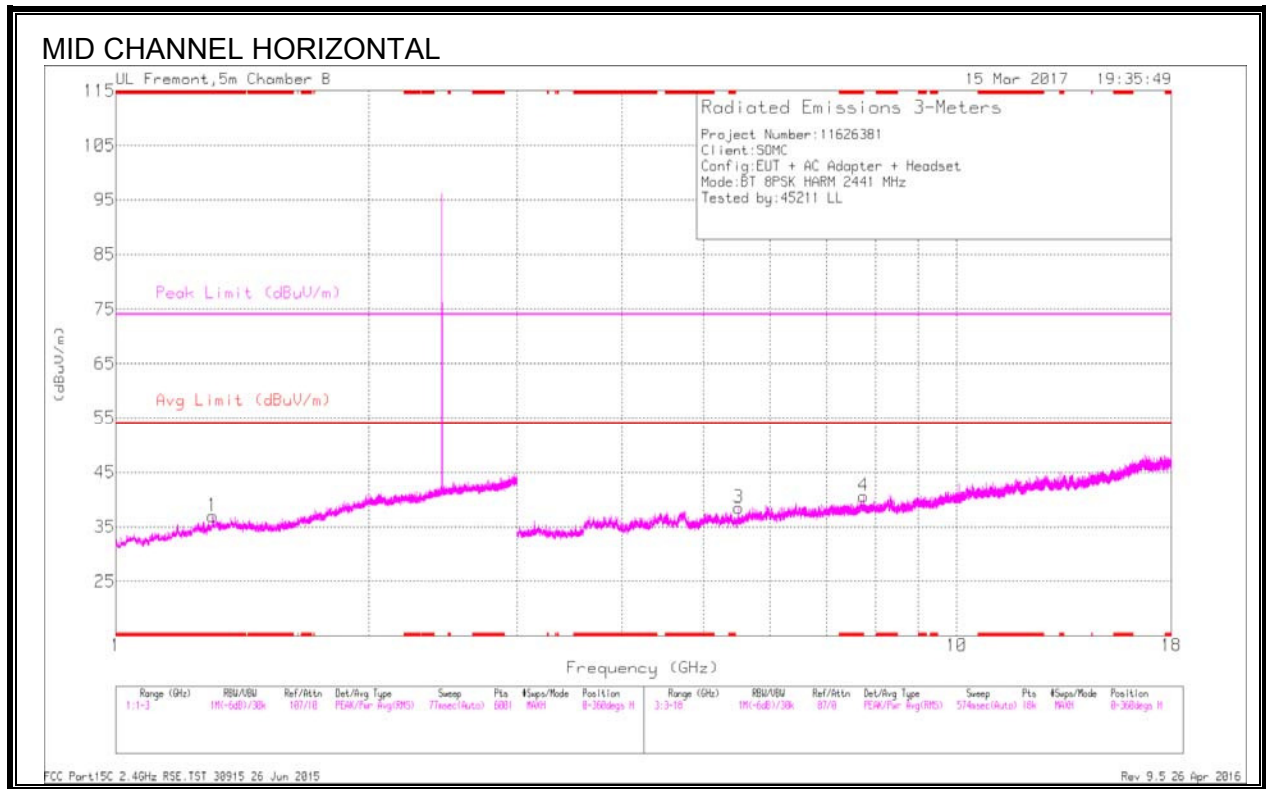

Frequency (GHz)	Meter Reading (dBuV)	Det	AF T345 (dB/m)	Amp/Cbl/Filtr/Paid (dB)	Corrected Reading (dBuV/m)	Avg Limit (dBuV/m)	Margin (dB)	Peak Limit (dBuV/m)	PK Margin (dB)	Azimuth (Degs)	Height (cm)	Polarity
* 1.302	34	PKFH	29	-21.9	41.1	-	-	74	-32.9	1	206	H
* 1.305	22.78	VA1T	29	-21.9	29.88	54	-24.12	-	-	1	206	H
* 1.174	34.8	PKFH	28.2	-22.7	40.3	-	-	74	-33.7	1	203	V
* 1.173	22.55	VA1T	28.2	-22.7	28.05	54	-25.95	-	-	1	203	V
* 7.747	34.81	PKFH	35.8	-26.1	44.51	-	-	74	-29.49	1	203	H
* 7.747	23.31	VA1T	35.8	-26.1	33.01	54	-20.99	-	-	1	203	H
* 4.686	38.28	PKFH	34.1	-29.8	42.58	-	-	74	-31.42	1	100	V
* 4.685	27.16	VA1T	34.1	-29.8	31.46	54	-22.54	-	-	1	100	V
5.507	38.5	PKFH	34.5	-30.1	42.9	-	-	74	-31.1	1	203	H
5.507	26.3	VA1T	34.5	-30.1	30.7	54	-23.3	-	-	1	203	H
6.428	36.94	PKFH	35.6	-28.4	44.14	-	-	74	-29.86	1	118	V
6.431	25.35	VA1T	35.6	-28.3	32.65	54	-21.35	-	-	1	118	V

\* - indicates frequency in CFR15.205/RSS-GEN 8.10 -Restricted Band  
 PKFH - FHSS: RB=100k/1MHz VB=3 x RB, Peak  
 VA1T - FHSS: Linear Voltage Average VB=1/Ton where: Ton is transmit duration

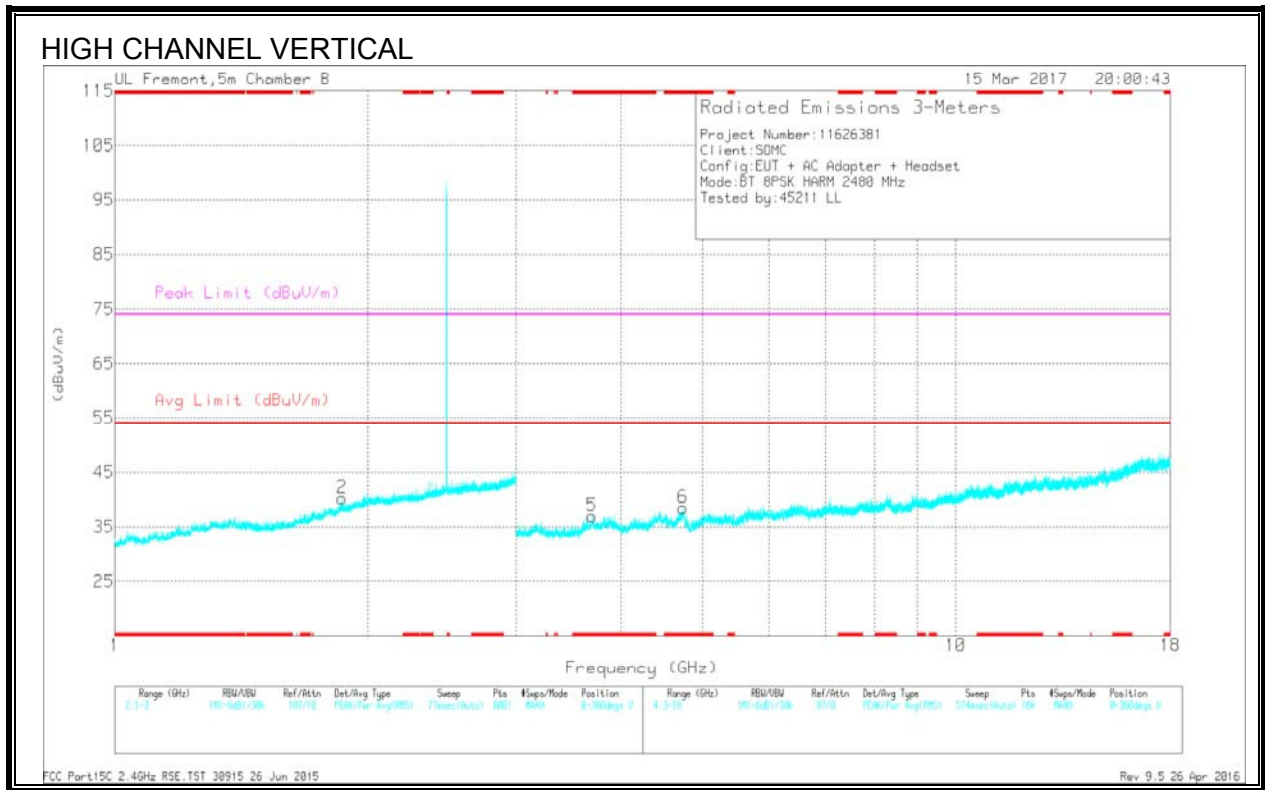
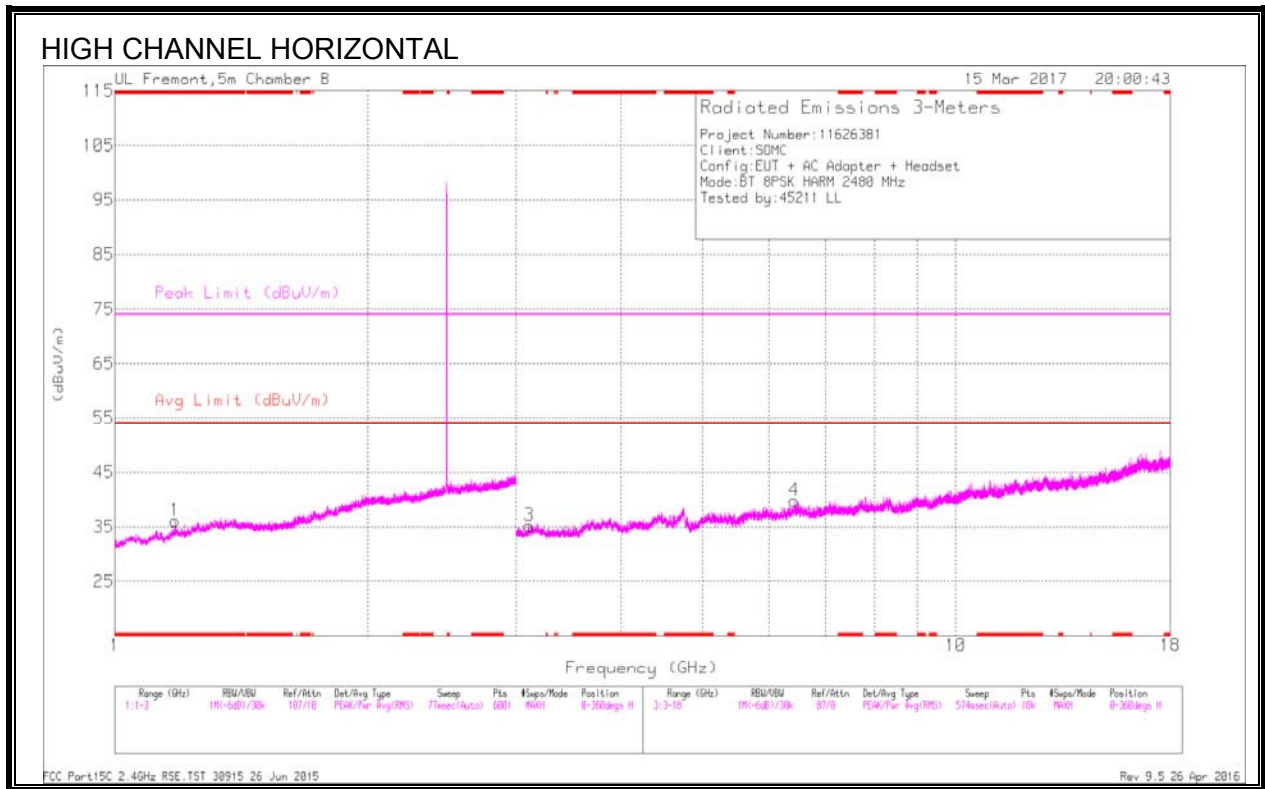

Frequency (GHz)	Meter Reading (dBuV)	Det	AF T345 (dB/m)	Amp/Cb/Fitr/Pad (dB)	Corrected Reading (dBuV/m)	Avg Limit (dBuV/m)	Margin (dB)	Peak Limit (dBuV/m)	PK Margin (dB)	Azimuth (Degs)	Height (cm)	Polarity
* 1.177	32.89	PKFH	28.2	-22.8	38.29	-	-	74	-35.71	360	206	H
* 1.18	22.62	VA1T	28.2	-22.7	28.12	54	-25.88	-	-	360	206	H
* 3.692	38.03	PKFH	33.3	-30.6	40.73	-	-	74	-33.27	325	106	V
* 3.692	27.13	VA1T	33.3	-30.6	29.83	54	-24.17	-	-	325	106	V
* 4.737	38.34	PKFH	34	-28.6	43.74	-	-	74	-30.26	256	101	V
* 4.735	26.89	VA1T	34	-28.6	32.29	54	-21.71	-	-	256	101	V
1.861	22.85	VA1T	30.5	-20.8	32.55	54	-21.45	-	-	360	100	V
1.862	33.87	PKFH	30.6	-20.8	43.67	-	-	74	-30.33	360	100	V
3.108	37.94	PKFH	32.7	-31	39.64	-	-	74	-34.36	360	153	H
3.109	26.72	VA1T	32.7	-31	28.42	54	-25.58	-	-	360	153	H
6.428	25.51	VA1T	35.6	-28.4	32.71	54	-21.29	-	-	325	132	H
6.429	36.21	PKFH	35.6	-28.4	43.41	-	-	74	-30.59	325	132	H

\* - indicates frequency in CFR15.205/RSS-GEN 8.10 -Restricted Band  
 PKFH - FHSS: RB=100k/1MHz VB=3 x RB, Peak  
 VA1T - FHSS: Linear Voltage Average VB=1/Ton where: Ton is transmit duration



### 8.4. WORST-CASE BELOW 30 MHz

#### SPURIOUS EMISSIONS BELOW 30 MHz (WORST-CASE CONFIGURATION)

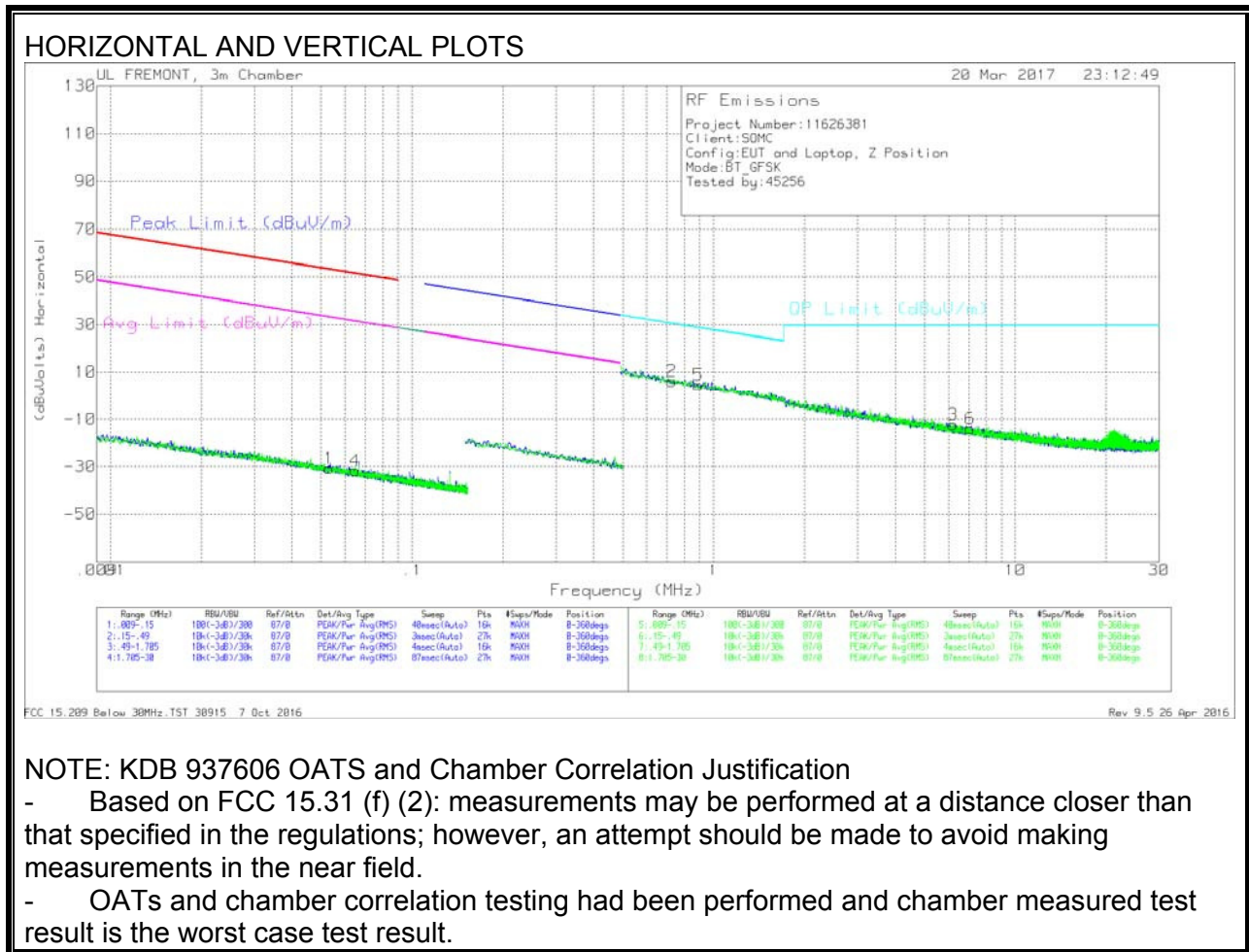

#### Trace Markers

Marker	Frequency (MHz)	Meter Reading (dBuV)	Det	Loop Antenna (dB/m)	Cbl (dB)	Dist Corr 300m	DC Corr (dB)	Corrected Reading (dBuVolts)	Peak Limit (dBuV/m)	Margin (dB)	Avg Limit (dBuV/m)	Margin (dB)	QP Limit (dBuV/m)	Margin (dB)	Azimuth (Degs)
1	.05307	35.78	Pk	12.2	1.4	-80	0	-30.62	53.09	-83.71	33.09	-63.71	-	-	0-360
4	.06476	34.77	Pk	12	1.4	-80	0	-31.83	51.36	-83.19	31.36	-63.19	-	-	0-360

Marker	Frequency (MHz)	Meter Reading (dBuV)	Det	Loop Antenna (dB/m)	Cbl (dB)	Dist Corr 30m	DC Corr (dB)	Corrected Reading (dBuVolts)	Peak Limit (dBuV/m)	Margin (dB)	Avg Limit (dBuV/m)	Margin (dB)	QP Limit (dBuV/m)	Margin (dB)	Azimuth (Degs)
2	.72594	32.81	Pk	11.8	1.5	-40	0	6.11	-	-	-	-	30.4	-24.29	0-360
5	.88972	31.29	Pk	11.8	1.5	-40	0	4.59	-	-	-	-	28.63	-24.04	0-360
3	6.21612	14.79	Pk	11.4	1.5	-40	0	-12.31	-	-	-	-	29.5	-41.81	0-360
6	7.08543	13.17	Pk	11.3	1.5	-40	0	-14.03	-	-	-	-	29.5	-43.53	0-360



## 8.5. WORST-CASE BELOW 1 GHz

### SPURIOUS EMISSIONS 30 TO 1000 MHz (WORST-CASE CONFIGURATION)

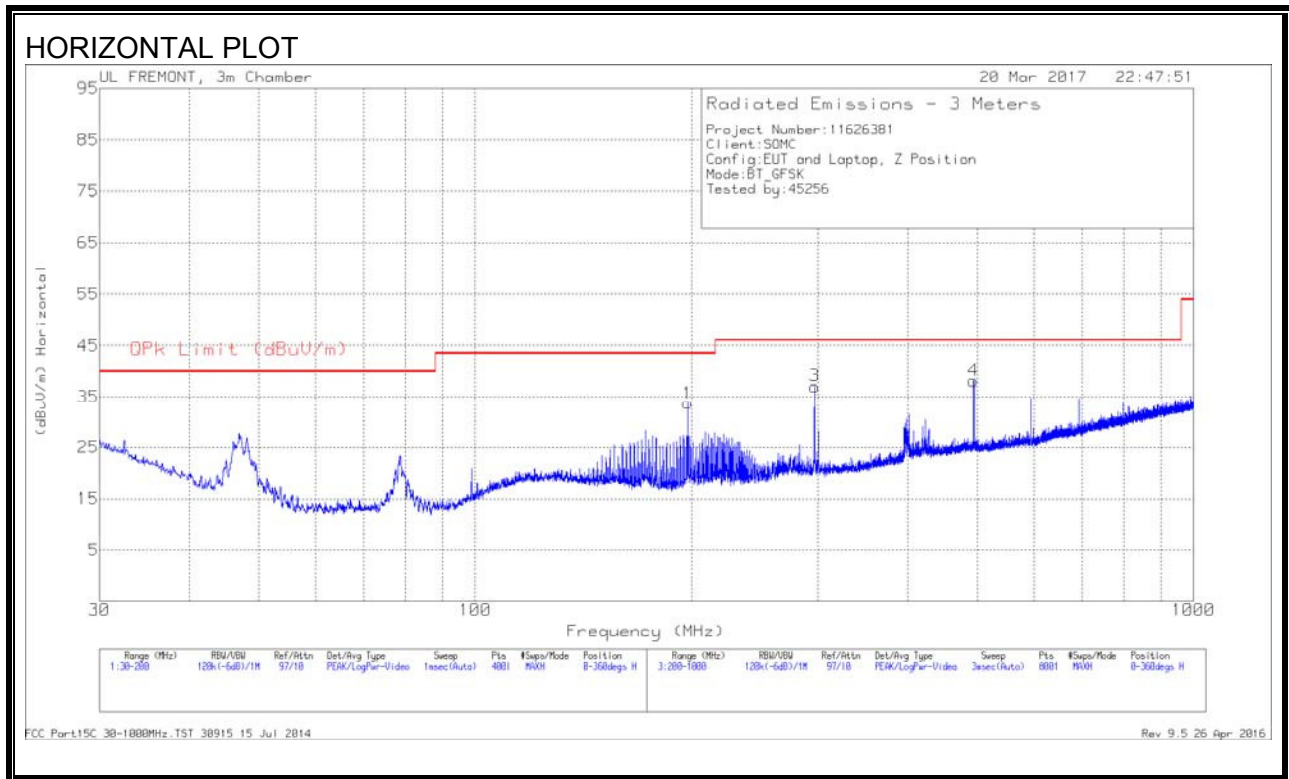

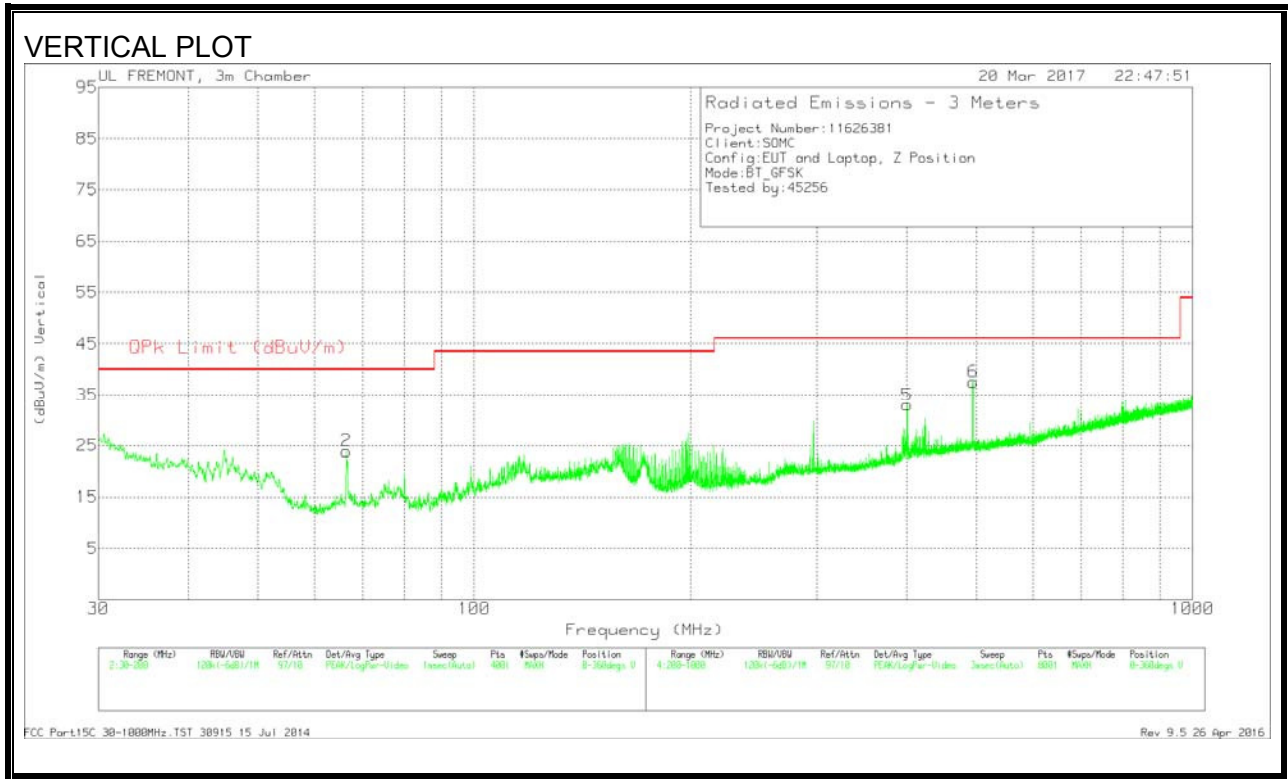

**DATA**

Marker	Frequency (MHz)	Meter Reading (dBuV)	Det	AF T408 (dB/m)	Amp/Cbl (dB)	DC Corr (dB)	Corrected Reading (dBuV/m)	QPk Limit (dBuV/m)	Margin (dB)	Azimuth (Degs)	Height (cm)	Polarity
2	66.4225	38.59	Pk	12	-26.7	0	23.89	40	-16.11	0-360	100	V
1	197.7475	42.62	Pk	16.2	-25.1	0	33.72	43.52	-9.8	0-360	100	H
3	296.7	44.09	Pk	17.2	-24.2	0	37.09	46.02	-8.93	0-360	100	H
5	400.5	37.88	Pk	19.6	-24.5	0	32.98	46.02	-13.04	0-360	200	V
4	494.4	41.22	Pk	21.6	-24.7	0	38.12	46.02	-7.9	0-360	200	H
6	494.5	40.65	Pk	21.6	-24.7	0	37.55	46.02	-8.47	0-360	200	V

Pk - Peak detector

## 8.6. WORST-CASE ABOVE 18 GHz

### SPURIOUS EMISSIONS 18 TO 26 GHz (WORST-CASE CONFIGURATION)

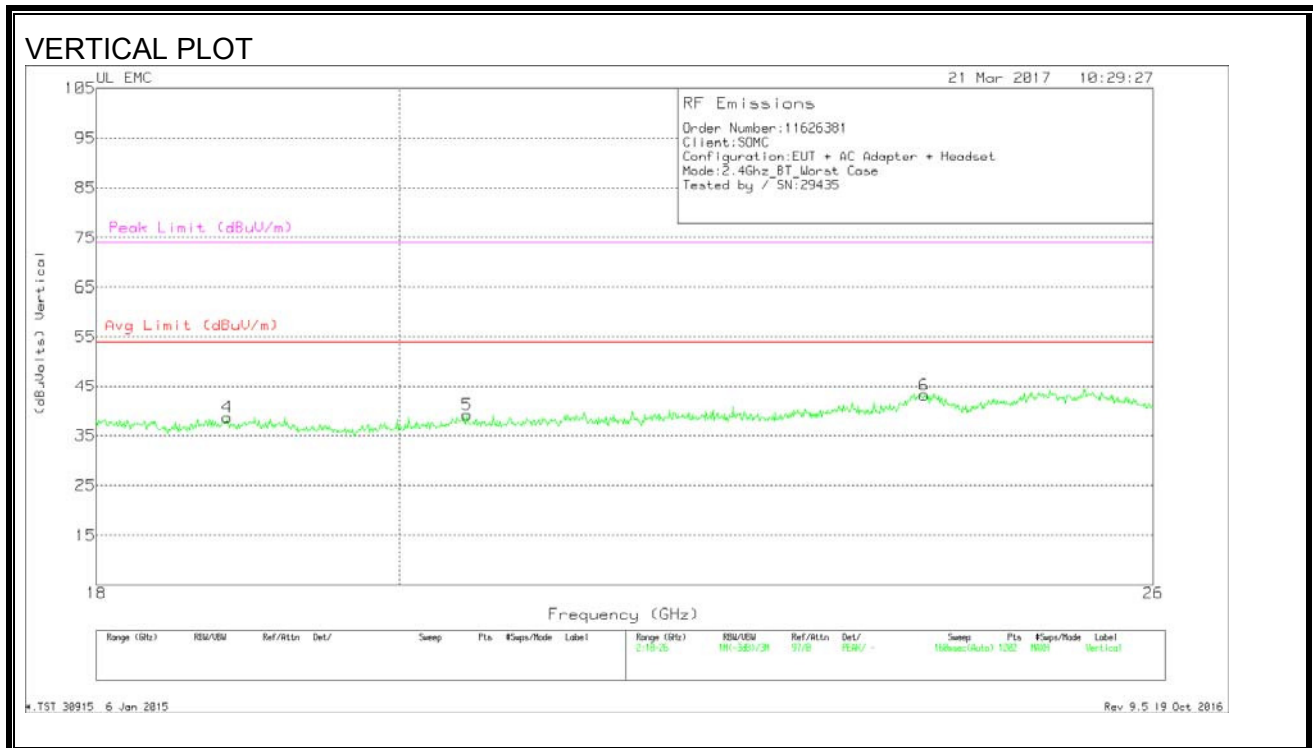
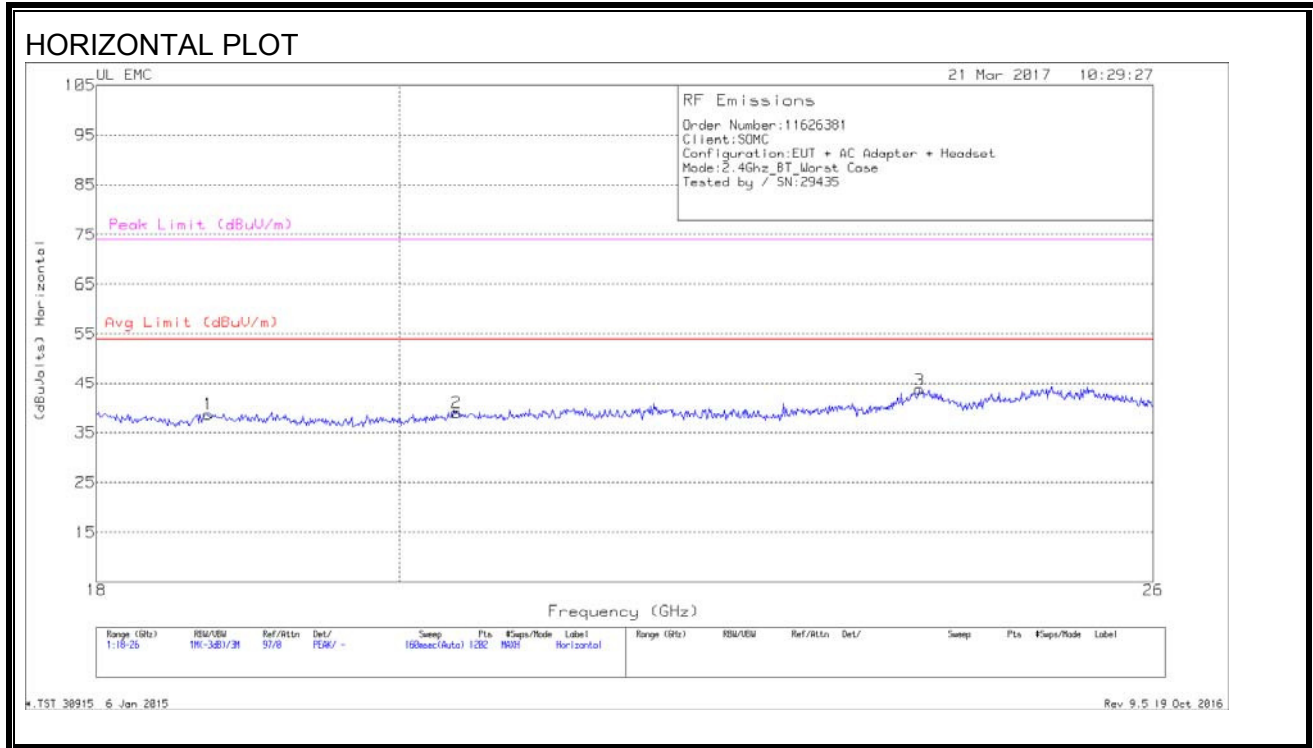

**Data**

Marker	Frequency (GHz)	Meter Reading (dBuV)	Det	AF T449 (dB/m)	Amp/Cbl (dB)	Dist Corr (dB)	Corrected Reading (dBuVolts)	Avg Limit (dBuV/m)	Margin (dB)	Peak Limit (dBuV/m)	PK Margin (dB)
1	18.713	40.27	Pk	32.4	-24.5	-9.5	38.667	54	-15.333	74	-35.333
2	20.401	40.7	Pk	32.9	-25.1	-9.5	39	54	-15	74	-35
3	23.968	43.37	Pk	34	-24.2	-9.5	43.667	54	-10.333	74	-30.333
4	18.839	40.67	Pk	32.5	-25	-9.5	38.667	54	-15.333	74	-35.333
5	20.478	41.17	Pk	32.9	-25.4	-9.5	39.167	54	-14.833	74	-34.833
6	24.008	43.07	Pk	34	-24.4	-9.5	43.1667	54	-10.833	74	-30.8333

Pk - Peak detector

## 9. AC POWER LINE CONDUCTED EMISSIONS

### LIMITS

FCC §15.207 (a)

RSS-Gen 8.8

Frequency of Emission (MHz)	Conducted Limit (dB $\mu$ V)	
	Quasi-peak	Average
0.15-0.5	66 to 56 *	56 to 46 *
0.5-5	56	46
5-30	60	50

\*Decreases with the logarithm of the frequency.

### TEST PROCEDURE

The EUT is placed on a non-conducting table 40 cm from the vertical ground plane and 80 cm above the horizontal ground plane. The EUT is configured in accordance with ANSI C63.10.

The receiver is set to a resolution bandwidth of 9 kHz. Peak detection is used unless otherwise noted as quasi-peak or average.

Line conducted data is recorded for both NEUTRAL and HOT lines.

### RESULTS

## 9.1. EUT POWERED WITH AC/DC ADAPTER & HEADSET

### LINE 1 RESULTS

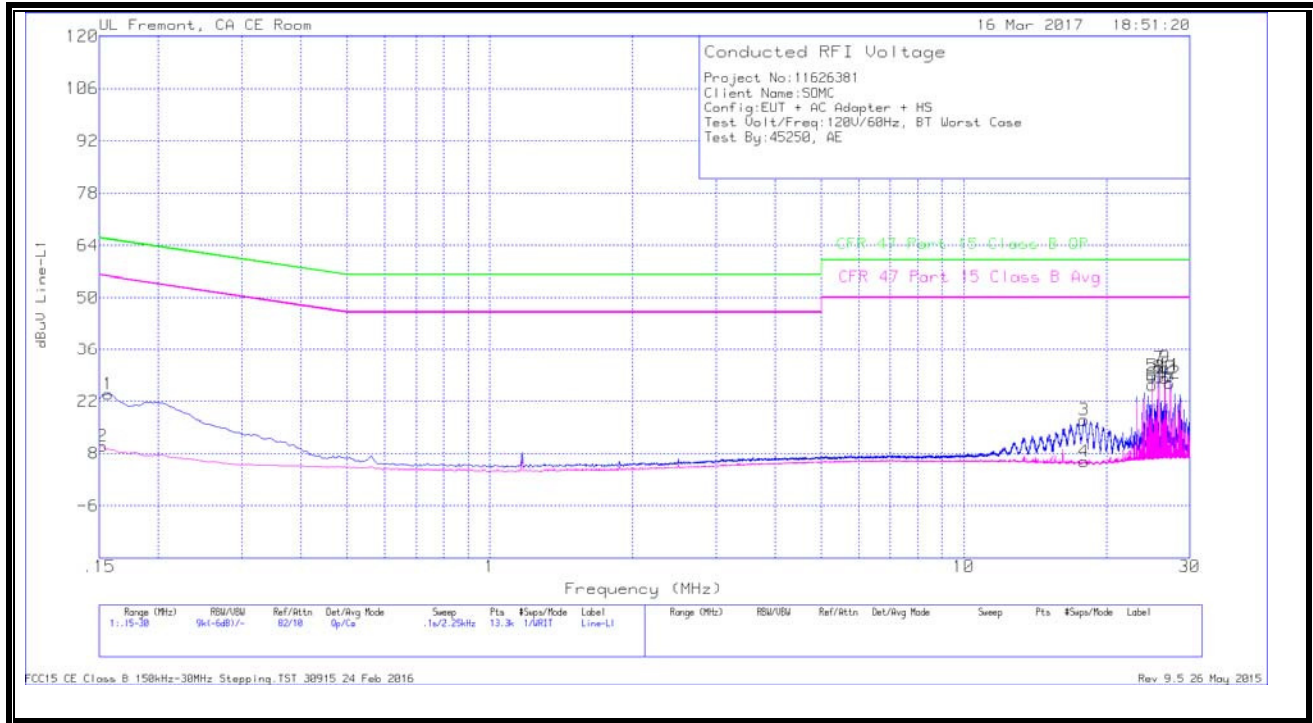

### WORST EMISSIONS

Range 1: Line-L1 .15 - 30MHz											
Marker	Frequency (MHz)	Meter Reading (dBuV)	Det	LISN L1	LC Cables C1&C3	Limiter (dB)	Corrected Reading dBuV	CFR 47 Part 15 Class B QP	QP Margin (dB)	CFR 47 Part 15 Class B Avg	Av(CISPR) Margin (dB)
1	.15675	13.8	Qp	0	.1	10.1	24	65.63	-41.63	-	-
2	.15225	-35	Ca	.1	.1	10.1	9.95	-	-	55.88	-45.93
3	17.9655	6.37	Qp	0	.3	10.3	16.97	60	-43.03	-	-
4	17.94075	-4.76	Ca	0	.3	10.3	5.84	-	-	50	-44.16
5	24.963	17.85	Qp	.1	.3	10.5	28.75	60	-31.25	-	-
6	24.963	15.55	Ca	.1	.3	10.5	26.45	-	-	50	-23.55
7	25.87875	20.03	Qp	.1	.3	10.5	30.93	60	-29.07	-	-
8	25.881	17.51	Ca	.1	.3	10.5	28.41	-	-	50	-21.59
9	26.61225	20.09	Qp	.1	.3	10.5	30.99	60	-29.01	-	-
10	26.61225	17.33	Ca	.1	.3	10.5	28.23	-	-	50	-21.77
11	27.16125	18.04	Qp	.1	.3	10.5	28.94	60	-31.06	-	-
12	27.1635	15.92	Ca	.1	.3	10.5	26.82	-	-	50	-23.18

Qp - Quasi-Peak detector

Ca - CISPR average detection

**LINE 2 RESULTS**

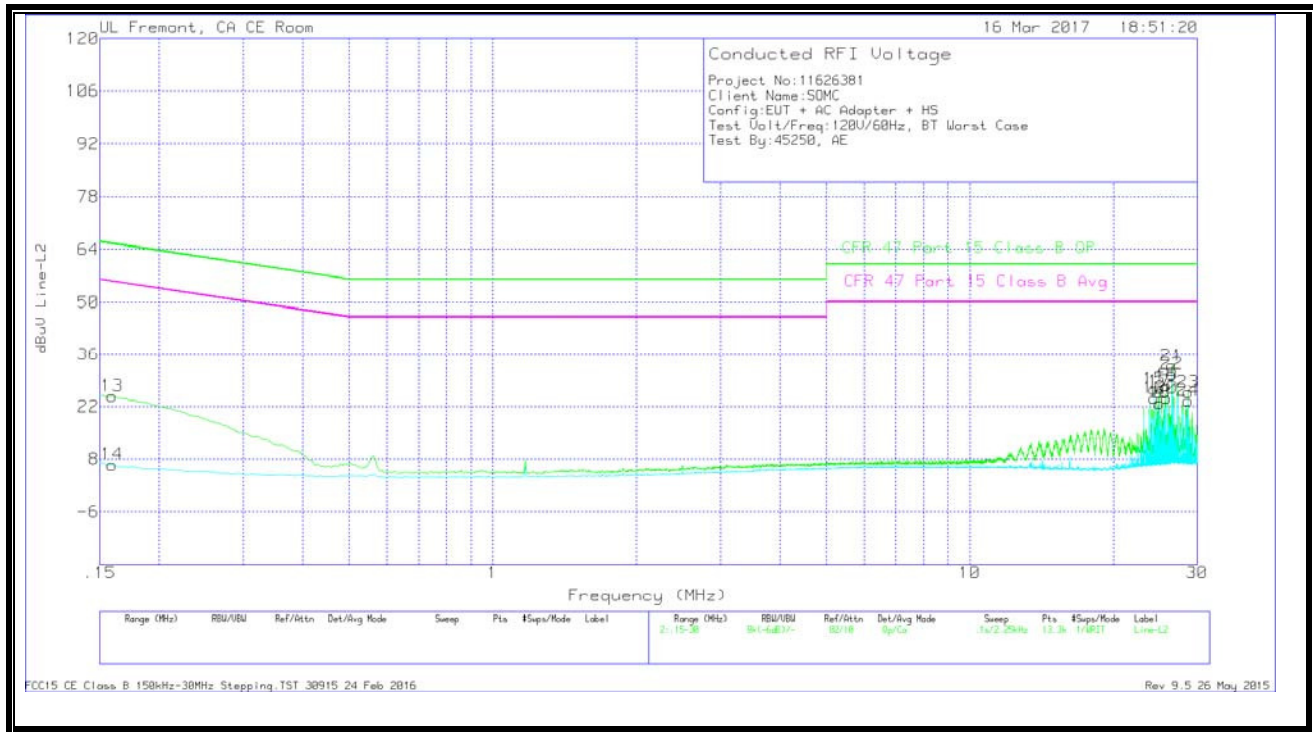

**WORST EMISSIONS**

Range 2: Line-L2 .15 - 30MHz											
Marker	Frequency (MHz)	Meter Reading (dBuV)	Det	LISN L2	LC Cables C2&C3	Limiter (dB)	Corrected Reading dBuV	CFR 47 Part 15 Class B QP	QP Margin (dB)	CFR 47 Part 15 Class B Avg	Av(CISPR) Margin (dB)
13	.159	14.56	Qp	0	.1	10.1	24.76	65.52	-40.76	-	-
14	.159	-3.72	Ca	0	.1	10.1	6.48	-	-	55.52	-49.04
15	24.35325	15.74	Qp	.1	.3	10.5	26.64	60	-33.36	-	-
16	24.35325	13.42	Ca	.1	.3	10.5	24.32	-	-	50	-25.68
17	24.963	15.03	Qp	.1	.3	10.5	25.93	60	-34.07	-	-
18	24.963	12.07	Ca	.1	.3	10.5	22.97	-	-	50	-27.03
19	25.87875	16.7	Qp	.1	.3	10.5	27.6	60	-32.4	-	-
20	25.881	13.42	Ca	.1	.3	10.5	24.32	-	-	50	-25.68
21	26.49075	22.14	Qp	.1	.3	10.5	33.04	60	-26.96	-	-
22	26.49075	19.85	Ca	.1	.3	10.5	30.75	-	-	50	-19.25
23	28.689	14.93	Qp	.1	.3	10.5	25.83	60	-34.17	-	-
24	28.689	12.67	Ca	.1	.3	10.5	23.57	-	-	50	-26.43

Qp - Quasi-Peak detector

Ca - CISPR average detection