



FCC RF Test Report

APPLICANT : Sony Mobile Communications Inc.
EQUIPMENT : GSM/WCDMA/LTE Phone+Bluetooth,
DTS/UNII a/b/g/n/ac and NFC
BRAND NAME : Sony
FCC ID : PY7-08608T
STANDARD : FCC 47 CFR Part 2, 22(H), 24(E)
CLASSIFICATION : PCS Licensed Transmitter Held to Ear (PCE)

The product was received on Jun. 07, 2017 and testing was completed on Sep. 17, 2017. We, SPORTON INTERNATIONAL INC., would like to declare that the tested sample has been evaluated in accordance with the test procedures given in ANSI / TIA / EIA-603-D-2010 and has been in compliance with the applicable technical standards.

The test results in this report apply exclusively to the tested model / sample. Without written approval of SPORTON INTERNATIONAL INC., the test report shall not be reproduced except in full.

Reviewed by: Joseph Lin / Supervisor

Approved by: Jones Tsai / Manager



SPORTON INTERNATIONAL INC.

No. 52, Hwa Ya 1st Rd., Hwa Ya Technology Park, Kwei-Shan District, Tao Yuan City, Taiwan, R.O.C.

SPORTON INTERNATIONAL INC.

TEL : 886-3-327-3456

FAX : 886-3-328-4978

FCC ID : PY7-08608T

Page Number : 1 of 23

Report Issued Date : Oct. 26, 2017

Report Version : Rev. 02

Report Template No.: BU5-FG22/24/27 Version 2.0



TABLE OF CONTENTS

REVISION HISTORY..... 3

SUMMARY OF TEST RESULT 4

1 GENERAL DESCRIPTION 5

 1.1 Applicant..... 5

 1.2 Manufacturer 5

 1.3 Product Feature of Equipment Under Test 5

 1.4 Modification of EUT 5

 1.5 Maximum ERP/EIRP Power, Frequency Tolerance, and Emission Designator 6

 1.6 Testing Location 7

 1.7 Applicable Standards 8

2 TEST CONFIGURATION OF EQUIPMENT UNDER TEST 9

 2.1 Test Mode..... 9

 2.2 Connection Diagram of Test System 10

 2.3 Support Unit used in test configuration 10

 2.4 Measurement Results Explanation Example 10

 2.5 Frequency List of Low/Middle/High Channels 11

3 CONDUCTED TEST RESULT 12

 3.1 Measuring Instruments..... 12

 3.2 Test Setup 12

 3.3 Test Result of Conducted Test..... 12

 3.4 Conducted Output Power and ERP/EIRP 13

 3.5 Peak-to-Average Ratio 14

 3.6 99% Occupied Bandwidth and 26dB Bandwidth Measurement..... 15

 3.7 Conducted Band Edge 16

 3.8 Conducted Spurious Emission 17

 3.9 Frequency Stability..... 18

4 RADIATED TEST ITEMS 19

 4.1 Measuring Instruments..... 19

 4.2 Test Setup 19

 4.3 Test Result of Radiated Test..... 19

 4.4 Field Strength of Spurious Radiation Measurement 20

5 LIST OF MEASURING EQUIPMENT 21

6 UNCERTAINTY OF EVALUATION 23

APPENDIX A. TEST RESULTS OF CONDUCTED TEST

APPENDIX B. TEST RESULTS OF RADIATED TEST



REVISION HISTORY

REPORT NO.	VERSION	DESCRIPTION	ISSUED DATE
FG760710-01A	Rev. 01	Initial issue of report	Oct. 24, 2017
FG760710-01A	Rev. 02	Add FCC designation No. in section 1.6.	Oct. 26, 2017



SUMMARY OF TEST RESULT

Report Section	FCC Rule	Description	Limit	Result	Remark
3.4	§2.1046	Conducted Output Power	Reporting Only	PASS	-
	§22.913(a)(2)	Effective Radiated Power	< 7 Watts	PASS	-
	§24.232(c)	Equivalent Isotropic Radiated Power	< 2 Watts	PASS	-
3.5	§24.232(d)	Peak-to-Average Ratio	< 13 dB	PASS	-
3.6	§2.1049 §22.917(b) §24.238(b)	Occupied Bandwidth	Reporting Only	PASS	-
3.7	§2.1051 §22.917(a) §24.238(a)	Band Edge Measurement	< 43+10log10(P[Watts])	PASS	-
3.8	§2.1051 §22.917(a) §24.238(a)	Conducted Emission	< 43+10log10(P[Watts])	PASS	-
3.9	§2.1055 §22.355	Frequency Stability for Temperature & Voltage	< 2.5 ppm for Part 22	PASS	-
	§2.1055 §24.235		Within Authorized Band		
4.4	§2.1053 §22.917(a) §24.238(a)	Field Strength of Spurious Radiation	< 43+10log10(P[Watts])	PASS	Under limit 13.35 dB at 2544.000 MHz



1 General Description

1.1 Applicant

Sony Mobile Communications Inc.

4-12-3 Higashi-Shinagawa, Shinagawa-ku, Tokyo, 140-0002, Japan

1.2 Manufacturer

Sony Mobile Communications Inc.

4-12-3 Higashi-Shinagawa, Shinagawa-ku, Tokyo, 140-0002, Japan

1.3 Product Feature of Equipment Under Test

GSM/WCDMA/LTE, Bluetooth, DTS/UNII a/b/g/n/ac, FM Receiver, NFC, and GPS.

Standards-related Product Specification	
Antenna Type	Main : PIFA Antenna Aux. : C-feed Antenna

EUT Information List			
HW Version	SW Version	S/N	Performed Test Item
A	1.14	RQ3005VWR1	Conducted Measurement
		CQ300000F1	ERP/EIRP Test Radiated Spurious Emission

Accessory List	
AC Adapter 1	Model Name: UCH12
	S/N: VB17W34100228
Earphone 1	Model Name: MH410c
	S/N: N/A
USB Cable	Model Name: UCB20
	S/N: N/A

Note:

1. Above EUT list and accessory list used are electrically identical per declared by manufacturer.
2. Above the accessories list are used to exercise the EUT during test.
3. For other wireless features of this EUT, test report will be issued separately.

1.4 Modification of EUT

No modifications are made to the EUT during all test items.



1.5 Maximum ERP/EIRP Power, Frequency Tolerance, and Emission Designator

FCC Rule	Frequency Range (MHz)	System	Type of Modulation	Maximum ERP/EIRP (W)	Frequency Tolerance (ppm)	Emission Designator
Part 22	824.2 ~848.8	GSM850 GPRS class 8	GMSK	1.2735	0.0108 ppm	248KGXW
Part 22	824.2 ~848.8	GSM850 EDGE class 8	8PSK	0.2799	0.0681 ppm	247KG7W
Part 22	826.4 ~846.6	WCDMA Band V RMC 12.2Kbps	BPSK	0.1560	0.0120 ppm	4M16F9W
Part 24	1850.2 ~1909.8	GSM1900 GPRS class 8	GMSK	1.2882	0.0027 ppm	247KGXW
Part 24	1850.2 ~1909.8	GSM1900 EDGE class 8	8PSK	0.4074	0.0186 ppm	245KG7W
Part 24	1852.4 ~ 1907.6	WCDMA Band II RMC 12.2Kbps	BPSK	0.2535	0.0021 ppm	4M14F9W



1.6 Testing Location

Sporton Lab is accredited to ISO 17025 by Taiwan Accreditation Foundation (TAF code : 1190) and the FCC designation No. TW1190 and TW0007 under the FCC 2.948(e) by Mutual Recognition Agreement (MRA) in FCC Test.

Test Site	SPORTON INTERNATIONAL INC.
Test Site Location	No. 52, Hwa Ya 1 st Rd., Hwa Ya Technology Park, Kwei-Shan District, Tao Yuan City, Taiwan, R.O.C. TEL: +886-3-327-3456 FAX: +886-3-328-4978
Test Site No.	Sporton Site No.
	TH03-HY

Test Site	SPORTON INTERNATIONAL INC.
Test Site Location	No.58, Aly. 75, Ln. 564, Wenhua 3rd Rd. Guishan Dist, Taoyuan City, Taiwan (R.O.C.) TEL: +886-3-327-0868 FAX: +886-3-327-0855
Test Site No.	Sporton Site No.
	03CH15-HY



1.7 Applicable Standards

According to the specifications of the manufacturer, the EUT must comply with the requirements of the following standards:

- ♦ 47 CFR Part 2, 22(H), 24(E)
- ♦ ANSI / TIA / EIA-603-D-2010
- ♦ FCC KDB 971168 D01 Power Meas. License Digital Systems v02r02
- ♦ FCC KDB 412172 D01 Determining ERP and EIRP v01r01

Remark:

1. All test items were verified and recorded according to the standards and without any deviation during the test.
2. This EUT has also been tested and complied with the requirements of FCC Part 15, Subpart B, recorded in a separate test report.



2 Test Configuration of Equipment Under Test

2.1 Test Mode

Antenna port conducted and radiated test items were performed according to KDB 971168 D01 Power Meas. License Digital Systems v02r02 with maximum output power.

Radiated measurements were performed with rotating EUT in different three orthogonal test planes to find the maximum emission.

Radiated emissions were investigated as following frequency range:

1. 30 MHz to 9000 MHz for GSM850 and WCDMA Band V.
2. 30 MHz to 19100 MHz for GSM1900 and WCDMA Band II.

All modes and data rates and positions were investigated.

Test modes are chosen to be reported as the worst case configuration below:

Test Modes		
Band	Radiated TCs	Conducted TCs
GSM 850	■ GPRS class 8 Link ■ EDGE class 8 Link	■ GPRS class 8 Link ■ EDGE class 8 Link
GSM 1900	■ GPRS class 8 Link ■ EDGE class 8 Link	■ GPRS class 8 Link ■ EDGE class 8 Link
WCDMA Band V	■ RMC 12.2Kbps Link	■ RMC 12.2Kbps Link
WCDMA Band II	■ RMC 12.2Kbps Link	■ RMC 12.2Kbps Link

Remark: All tests were performed with Battery 1

2.2 Connection Diagram of Test System

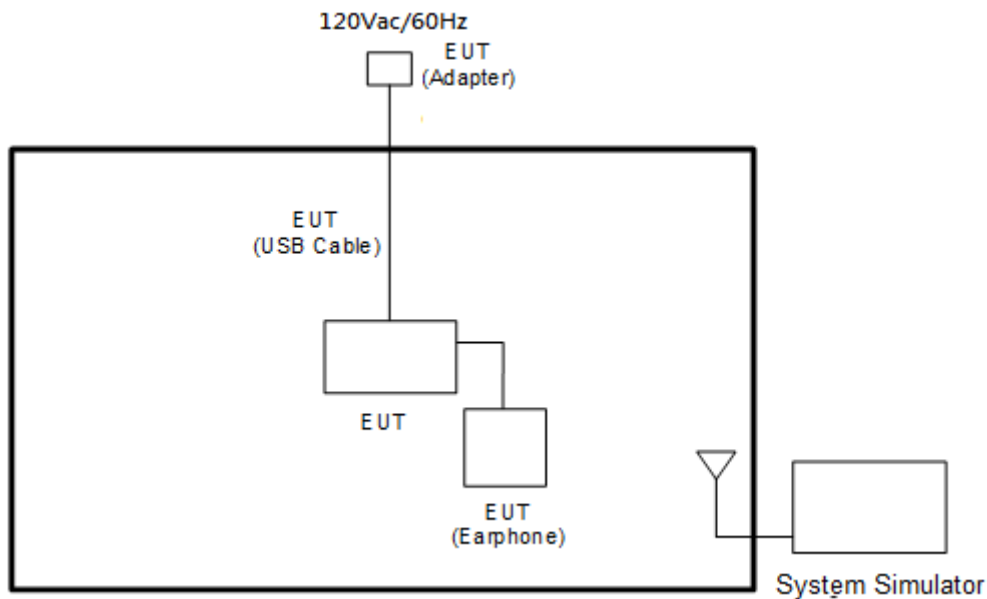

2.3 Support Unit used in test configuration

Item	Equipment	Trade Name	Model No.	FCC ID	Data Cable	Power Cord
1.	System Simulator	R&S	CMU 200	N/A	N/A	Unshielded, 1.8 m

2.4 Measurement Results Explanation Example

For all conducted test items:

The offset level is set in the spectrum analyzer to compensate the RF cable loss and attenuator factor between RF conducted output port and spectrum analyzer. With the offset compensation, the spectrum analyzer reading level will be exactly the RF output level.

The spectrum analyzer offset is derived from RF cable loss and attenuator factor.

Offset = RF cable loss + attenuator factor.

The following shows an offset computation example with RF cable loss 4.2 dB and a 10dB attenuator.

Example :

Offset(dB) = RF cable loss(dB) + attenuator factor(dB).

$$= 4.2 + 10 = 14.2 \text{ (dB)}$$



2.5 Frequency List of Low/Middle/High Channels

Frequency List				
Band	Channel/Frequency(MHz)	Lowest	Middle	Highest
GSM850	Channel	128	189	251
	Frequency	824.2	836.4	848.8
WCDMA Band V	Channel	4132	4182	4233
	Frequency	826.4	836.4	846.6
GSM1900	Channel	512	661	810
	Frequency	1850.2	1880.0	1909.8
WCDMA Band II	Channel	9262	9400	9538
	Frequency	1852.4	1880.0	1907.6

3 Conducted Test Result

3.1 Measuring Instruments

See list of measuring instruments of this test report.

3.2 Test Setup

3.2.1 Conducted Output Power



3.2.2 Peak-to-Average Ratio, Occupied Bandwidth, Conducted Band-Edge and Conducted Spurious Emission

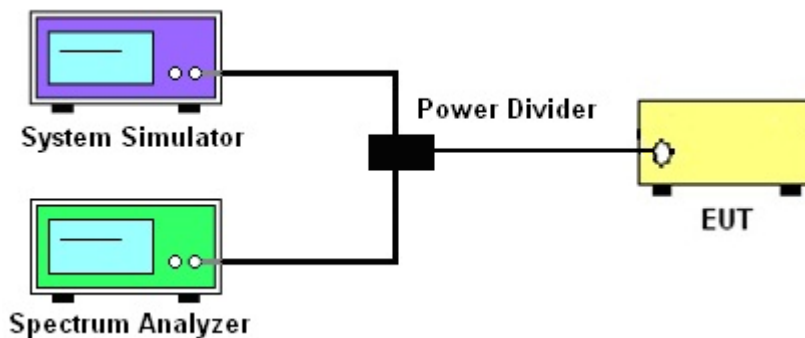

3.2.3 Frequency Stability

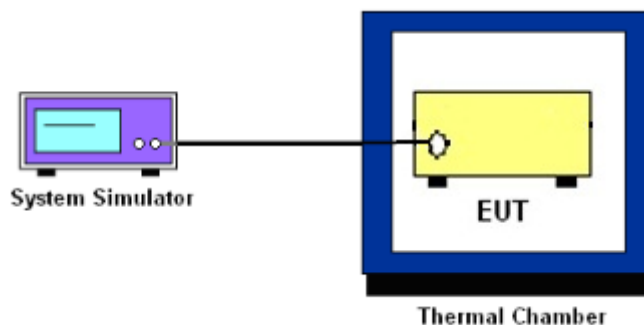

3.3 Test Result of Conducted Test

Please refer to Appendix A.



3.4 Conducted Output Power and ERP/EIRP

3.4.1 Description of the Conducted Output Power and ERP/EIRP

A system simulator was used to establish communication with the EUT. Its parameters were set to enforce EUT transmitting at the maximum power. The measured power in the radio frequency on the transmitter output terminals shall be reported.

The ERP of mobile transmitters must not exceed 7 Watts for GSM850 and WCDMA Band V.

The EIRP of mobile transmitters must not exceed 2 Watts for GSM1900 and WCDMA Band II.

According to KDB 412172 D01 Power Approach,

$EIRP = P_T + G_T - L_C$, $ERP = EIRP - 2.15$, where

P_T = transmitter output power in dBm

G_T = gain of the transmitting antenna in dBi

L_C = signal attenuation in the connecting cable between the transmitter and antenna in dB

3.4.2 Test Procedures

1. The transmitter output port was connected to the system simulator.
2. Set EUT at maximum power through system simulator.
3. Select lowest, middle, and highest channels for each band and different modulation.
4. Measure the maximum burst average power for GSM and maximum average power for other modulation signal.



3.5 Peak-to-Average Ratio

3.5.1 Description of the PAR Measurement

The peak-to-average ratio (PAR) of the transmission may not exceed 13 dB.

3.5.2 Test Procedures

1. The testing follows FCC KDB 971168 D01 v02r02 Section 5.7.1.
2. The EUT was connected to spectrum analyzer and system simulator via a power divider.
3. Set EUT to transmit at maximum output power.
4. When the duty cycle is less than 98%, then signal gating will be implemented on the spectrum analyzer by triggering from the system simulator.
5. Set the CCDF (Complementary Cumulative Distribution Function) option of the spectrum analyzer.
Record the maximum PAPR level associated with a probability of 0.1%.



3.6 99% Occupied Bandwidth and 26dB Bandwidth Measurement

3.6.1 Description of 99% Occupied Bandwidth and 26dB Bandwidth Measurement

The occupied bandwidth is the width of a frequency band such that, below the lower and above the upper frequency limits, the mean powers emitted are each equal to a specified percentage 0.5% of the total mean transmitted power.

The 26 dB emission bandwidth is defined as the frequency range between two points, one above and one below the carrier frequency, at which the spectral density of the emission is attenuated 26 dB below the maximum in-band spectral density of the modulated signal. Spectral density (power per unit bandwidth) is to be measured with a detector of resolution bandwidth equal to approximately 1.0% of the emission bandwidth.

3.6.2 Test Procedures

1. The testing follows FCC KDB 971168 v02r02 Section 4.2.
2. The EUT was connected to spectrum analyzer and system simulator via a power divider.
3. The spectrum analyzer center frequency is set to the nominal EUT channel center frequency. The span range for the spectrum analyzer shall be between two and five times the anticipated OBW.
4. The nominal resolution bandwidth (RBW) shall be in the range of 1 to 5 % of the anticipated OBW, and the VBW shall be at least 3 times the RBW.
5. Set the detection mode to peak, and the trace mode to max hold.
6. Determine the reference value: Set the EUT to transmit a modulated signal. Allow the trace to stabilize. Set the spectrum analyzer marker to the highest level of the displayed trace.
(this is the reference value)
7. Determine the “-26 dB down amplitude” as equal to (Reference Value – X).
8. Place two markers, one at the lowest and the other at the highest frequency of the envelope of the spectral display such that each marker is at or slightly below the “-X dB down amplitude” determined in step 6. If a marker is below this “-X dB down amplitude” value it shall be placed as close as possible to this value. The OBW is the positive frequency difference between the two markers.
9. Use the 99 % power bandwidth function of the spectrum analyzer and report the measured bandwidth.



3.7 Conducted Band Edge

3.7.1 Description of Conducted Band Edge Measurement

The power of any emission outside of the authorized operating frequency ranges must be lower than the transmitter power (P) by a factor of at least $43 + 10 \log (P)$ dB.

3.7.2 Test Procedures

1. The testing follows FCC KDB 971168 D01 v02r02 Section 6.0.
2. The EUT was connected to the spectrum analyzer and system simulator via a power divider.
3. The RF output of EUT was connected to the spectrum analyzer by an RF cable and attenuator. The path loss was compensated to the results for each measurement.
4. The band edges of low and high channels for the highest RF powers were measured.
5. The RF fundamental frequency should be excluded against the limit line in the operating frequency band.
6. The limit line is derived from $43 + 10\log(P)$ dB below the transmitter power P(Watts)



3.8 Conducted Spurious Emission

3.8.1 Description of Conducted Spurious Emission Measurement

The power of any emission outside of the authorized operating frequency ranges must be lower than the transmitter power (P) by a factor of at least $43 + 10 \log (P)$ dB.

It is measured by means of a calibrated spectrum analyzer and scanned from 30 MHz up to a frequency including its 10th harmonic.

3.8.2 Test Procedures

1. The testing follows FCC KDB 971168 D01 v02r02 Section 6.0.
2. The EUT was connected to the spectrum analyzer and system simulator via a power divider.
3. The RF output of EUT was connected to the spectrum analyzer by an RF cable and attenuator. The path loss was compensated to the results for each measurement.
4. The middle channel for the highest RF power within the transmitting frequency was measured.
5. The conducted spurious emission for the whole frequency range was taken.
6. The RF fundamental frequency should be excluded against the limit line in the operating frequency band.
7. The limit line is derived from $43 + 10\log(P)$ dB below the transmitter power P(Watts)



3.9 Frequency Stability

3.9.1 Description of Frequency Stability Measurement

The frequency stability shall be measured by variation of ambient temperature and variation of primary supply voltage to ensure that the fundamental emission stays within the authorized frequency block. The frequency stability of the transmitter shall be maintained within $\pm 0.00025\%$ ($\pm 2.5\text{ppm}$) of the center frequency.

3.9.2 Test Procedures for Temperature Variation

1. The testing follows FCC KDB 971168 D01 v02r02 Section 9.0.
2. The EUT was set up in the thermal chamber and connected with the system simulator.
3. With power OFF, the temperature was decreased to -30°C and the EUT was stabilized before testing. Power was applied and the maximum change in frequency was recorded within one minute.
4. With power OFF, the temperature was raised in 10°C steps up to 50°C . The EUT was stabilized at each step for at least half an hour. Power was applied and the maximum frequency change was recorded within one minute.

3.9.3 Test Procedures for Voltage Variation

1. The testing follows FCC KDB 971168 D01 v02r02 Section 9.0.
2. The EUT was placed in a temperature chamber at $20\pm 5^{\circ}\text{C}$ and connected with the system simulator.
3. The power supply voltage to the EUT was varied from 85% to 115% of the nominal value measured at the input to the EUT.
4. The variation in frequency was measured for the worst case.

4 Radiated Test Items

4.1 Measuring Instruments

See list of measuring instruments of this test report.

4.2 Test Setup

4.2.1 For radiated test from 30MHz to 1GHz



4.2.2 For radiated test above 1GHz

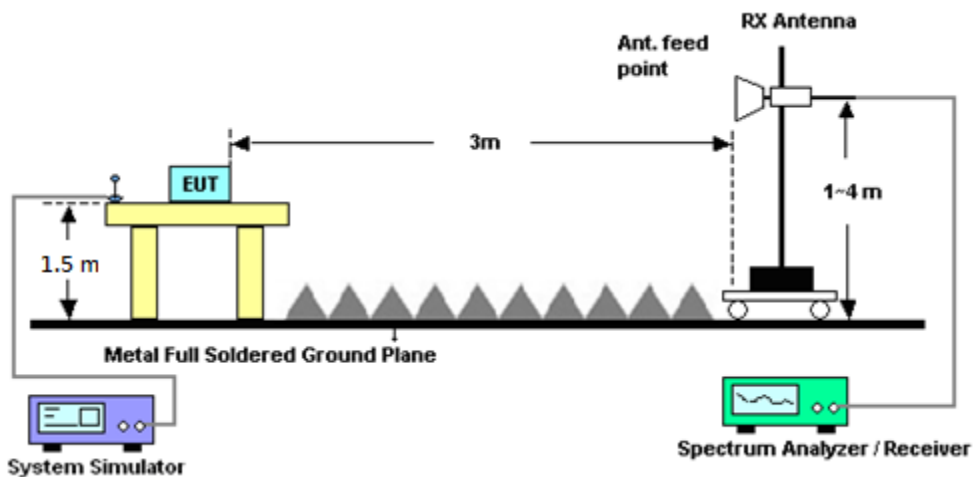

4.3 Test Result of Radiated Test

Please refer to Appendix B.



4.4 Field Strength of Spurious Radiation Measurement

4.4.1 Description of Field Strength of Spurious Radiated Measurement

The power of any emission outside of the authorized operating frequency ranges must be attenuated below the transmitter power (P) by a factor of at least $43 + 10 \log (P)$ dB. The spectrum is scanned from 30 MHz up to a frequency including its 10th harmonic.

4.4.2 Test Procedures

1. The testing follows FCC KDB 971168 D01 v02r02 Section 5.8 and ANSI / TIA-603-D-2010 Section 2.2.12.
2. The EUT was placed on a rotatable wooden table 0.8 meters for frequency below 1GHz and 1.5 meter for frequency above 1GHz above the ground.
3. The EUT was set 3 meters from the receiving antenna, which was mounted on the antenna tower.
4. The table was rotated 360 degrees to determine the position of the highest spurious emission.
5. The height of the receiving antenna is varied between one meter and four meters to search for the maximum spurious emission for both horizontal and vertical polarizations.
6. Make the measurement with the spectrum analyzer's RBW = 1MHz, VBW = 3MHz, taking record of maximum spurious emission.
7. A horn antenna was substituted in place of the EUT and was driven by a signal generator.
8. Tune the output power of signal generator to the same emission level with EUT maximum spurious emission.
9. Taking the record of output power at antenna port.
10. Repeat step 7 to step 8 for another polarization.
11. $EIRP \text{ (dBm)} = S.G. \text{ Power} - Tx \text{ Cable Loss} + Tx \text{ Antenna Gain}$
12. $ERP \text{ (dBm)} = EIRP - 2.15$
13. The RF fundamental frequency should be excluded against the limit line in the operating frequency band.
14. The limit line is derived from $43 + 10\log(P)$ dB below the transmitter power P(Watts)



5 List of Measuring Equipment

Instrument	Manufacturer	Model No.	Serial No.	Characteristics	Calibration Date	Test Date	Due Date	Remark
Hygrometer	Testo	608-H1	34893241	N/A	Mar. 20, 2017	Sep. 03, 2017~ Sep. 04, 2017	Mar. 19, 2018	Conducted (TH03-HY)
Spectrum Analyzer	Rohde & Schwarz	FSP30	101329	9kHz~30GHz	Jun. 29, 2017	Sep. 03, 2017~ Sep. 04, 2017	Jun. 28, 2018	Conducted (TH03-HY)
Temperature Chamber	ESPEC	SU-641	92013721	-30°C ~70°C	Nov. 16, 2016	Sep. 03, 2017~ Sep. 04, 2017	Nov. 15, 2017	Conducted (TH03-HY)
Programmable Power Supply	GW Instek	PSS-2005	EL883644	Voltage:0~20V;Current:0~5A	Nov. 22, 2016	Sep. 03, 2017~ Sep. 04, 2017	Nov. 21, 2017	Conducted (TH03-HY)
Base Station(Measu	Rohde & Schwarz	CMU200	117995	GSM / GPRS / WCDMA / CDMA	Aug. 09, 2017	Sep. 03, 2017~ Sep. 04, 2017	Aug. 08, 2018	Conducted (TH03-HY)
RF Cable	HUBER + SUHNER	SUCOFLEX 104	MY84209521	1GHz~26GHz	Dec. 02, 2016	Sep. 03, 2017~ Sep. 04, 2017	Dec. 01, 2017	Conducted (TH03-HY)
Bilog Antenna	TESEQ	CBL6111D&00800N1D0	41912&05	30MHz to 1GHz	Jan. 07, 2017	Sep. 15, 2017~ Sep. 17, 2017	Jan. 06, 2018	Radiation (03CH15-HY)
Horn Antenna	SCHWARZBECK	BBHA 9120D	9120D-1620	1G~18GHz	Sep. 30, 2016	Sep. 15, 2017~ Sep. 17, 2017	Sep. 29, 2017	Radiation (03CH15-HY)
Horn Antenna	SCHWARZBECK	BBHA 9120D	9120D-1522	1G~18GHz	Mar. 17, 2017	Sep. 15, 2017~ Sep. 17, 2017	Mar. 16, 2018	Radiation (03CH15-HY)
SHF-EHF Horn Antenna	SCHWARZBECK	BBHA 9170	BBHA9170584	18GHz- 40GHz	Nov. 08, 2016	Sep. 15, 2017~ Sep. 17, 2017	Nov. 07, 2017	Radiation (03CH15-HY)
SHF-EHF Horn Antenna	SCHWARZBECK	BBHA 9170	BBHA9170576	18GHz ~ 40GHz	Apr. 27, 2017	Sep. 15, 2017~ Sep. 17, 2017	Apr. 26, 2018	Radiation (03CH15-HY)
Amplifier	SONOMA	310N	363440	9kHz~1GHz	Nov. 09, 2016	Sep. 15, 2017~ Sep. 17, 2017	Nov. 08, 2017	Radiation (03CH15-HY)
Preamplifier	MITEQ	TTA 1840-35-HG	1887435	18GHz ~ 40GHz	Oct. 13, 2016	Sep. 15, 2017~ Sep. 17, 2017	Oct. 12, 2017	Radiation (03CH15-HY)
Preamplifier	Keysight	83017A	MY53270195	1GHz~26.5GHz	Aug. 21, 2017	Sep. 15, 2017~ Sep. 17, 2017	Aug. 20, 2018	Radiation (03CH15-HY)
Preamplifier	MITEQ	AMF-7D-00 101800	2025787	1GHZ~18GHZ	Feb. 13, 2017	Sep. 15, 2017~ Sep. 17, 2017	Feb. 12, 2018	Radiation (03CH15-HY)
Spectrum Analyzer	Agilent	N9030A	MY52350276	3Hz~44GHz	Mar. 23, 2017	Sep. 15, 2017~ Sep. 17, 2017	Mar. 22, 2018	Radiation (03CH15-HY)



Instrument	Manufacturer	Model No.	Serial No.	Characteristics	Calibration Date	Test Date	Due Date	Remark
Controller	ChainTek	3000-1	N/A	Control Turn table & Ant Mast	N/A	Sep. 15, 2017~ Sep. 17, 2017	N/A	Radiation (03CH15-HY)
Antenna Mast	ChainTek	MBS-520-1	N/A	1m~4m	N/A	Sep. 15, 2017~ Sep. 17, 2017	N/A	Radiation (03CH15-HY)
Turn Table	ChainTek	T-200-S-1	N/A	0~360 Degree	N/A	Sep. 15, 2017~ Sep. 17, 2017	N/A	Radiation (03CH15-HY)
Hygrometer	TECPEL	DTM-303B	TP140320	N/A	Mar. 20, 2017	Sep. 15, 2017~ Sep. 17, 2017	Mar. 19, 2018	Radiation (03CH15-HY)
Signal Generator	Rohde & Schwarz	SMF100A	101107	100kHz~40GHz	May 22, 2017	Sep. 15, 2017~ Sep. 17, 2017	May 21, 2018	Radiation (03CH15-HY)
RF Cable	HUBER + SUHNER	SUCOFLEX 104	MY249564 MY249524	25GHz~40GHz	Sep. 30, 2016	Sep. 15, 2017~ Sep. 17, 2017	Sep. 29, 2017	Radiation (03CH15-HY)
RF Cable	HUBER + SUHNER	SUCOFLEX 104	MY249564 MY249524	30MHz~1GHz	Sep. 30, 2016	Sep. 15, 2017~ Sep. 17, 2017	Sep. 29, 2017	Radiation (03CH15-HY)
RF Cable	HUBER + SUHNER	SUCOFLEX 104	MY249564 MY249524	1GHz~25GHz	Sep. 30, 2016	Sep. 15, 2017~ Sep. 17, 2017	Sep. 29, 2017	Radiation (03CH15-HY)
Filter	Wainwright	WHKX12-2700-3000-180	SN2	3 GHz High Pass	Nov. 22, 2016	Sep. 15, 2017~ Sep. 17, 2017	Nov. 21, 2017	Radiation (03CH15-HY)
Filter	Wainwright	WHKX12-1080-1200-150	SN1	1.2 GHz High Pass	Sep. 19, 2016	Sep. 15, 2017~ Sep. 17, 2017	Sep. 18, 2017	Radiation (03CH15-HY)
Filter	Wainwright	WLKS1200-12SS	SN2	1.2GHz Low Pass	Sep. 19, 2016	Sep. 15, 2017~ Sep. 17, 2017	Sep. 18, 2017	Radiation (03CH15-HY)
Notch Filter	Wainwright	WRCT/800/960-0.2/40-8	SN11	GSM850	Nov. 22, 2016	Sep. 15, 2017~ Sep. 17, 2017	Nov. 21, 2017	Radiation (03CH15-HY)
Notch Filter	Wainwright	WRCT1850/1910-40/8S	SN21	1900	Nov. 22, 2016	Sep. 15, 2017~ Sep. 17, 2017	Nov. 21, 2017	Radiation (03CH15-HY)
Notch Filter	Wainwright	WRCT2500/2570-10/40-	SN1 R	LTE Band7	Aug. 24, 2017	Sep. 15, 2017~ Sep. 17, 2017	Aug. 23, 2018	Radiation (03CH15-HY)
Test Software	N/A	E3	6.2009-8-24	N/A	N/A	Sep. 15, 2017~ Sep. 17, 2017	N/A	Radiation (03CH15-HY)



6 Uncertainty of Evaluation

Uncertainty of Radiated Emission Measurement (30 MHz ~ 1000 MHz)

Measuring Uncertainty for a Level of Confidence of 95% ($U = 2Uc(y)$)	3.37
---	------

Uncertainty of Radiated Emission Measurement (1 GHz ~ 18 GHz)

Measuring Uncertainty for a Level of Confidence of 95% ($U = 2Uc(y)$)	3.67
---	------

Uncertainty of Radiated Emission Measurement (1 GHz ~ 40 GHz)

Measuring Uncertainty for a Level of Confidence of 95% ($U = 2Uc(y)$)	4.03
---	------



Appendix A. Test Results of Conducted Test

Conducted Output Power(Average power)

Conducted Power (*Unit: dBm)						
Band	GSM850			GSM1900		
Channel	128	189	251	512	661	810
Frequency	824.2	836.4	848.8	1850.2	1880	1909.8
GSM	33.65	33.76	33.80	30.76	30.60	30.98
GPRS class 8	33.64	33.77	34.00	30.79	30.62	31.00
GPRS class 10	30.51	30.76	30.93	27.46	27.27	27.67
GPRS class 11	28.56	28.73	28.87	25.61	25.51	25.89
GPRS class 12	27.13	27.40	27.21	24.48	24.55	24.90
EGPRS class 8	27.18	27.26	27.42	25.80	25.64	26.00
EGPRS class 10	25.67	25.76	25.79	24.98	24.82	25.26
EGPRS class 11	25.34	25.32	25.46	23.97	23.81	24.15
EGPRS class 12	25.10	25.13	25.26	23.64	23.41	23.78

Conducted Power (*Unit: dBm)						
Band	WCDMA Band V			WCDMA Band II		
Channel	4132	4182	4233	9262	9400	9538
Frequency	826.4	836.4	846.6	1852.4	1880	1907.6
RMC 12.2K	24.84	24.87	24.88	23.94	23.75	23.85
HSDPA Subtest-1	23.88	23.88	23.92	22.95	22.74	22.84
HSDPA Subtest-2	23.87	23.87	23.95	22.92	22.72	22.87
HSDPA Subtest-3	23.40	23.41	23.44	22.42	22.29	22.33
HSDPA Subtest-4	23.40	23.39	23.41	22.48	22.28	22.39
HSUPA Subtest-1	23.49	23.45	23.50	22.48	22.46	22.50
HSUPA Subtest-2	21.48	21.49	21.50	20.80	20.78	20.82
HSUPA Subtest-3	22.47	22.50	22.45	21.79	21.77	21.81
HSUPA Subtest-4	21.45	21.49	21.50	20.41	20.38	20.42
HSUPA Subtest-5	23.47	23.43	23.49	22.49	22.45	22.50



A1. GSM

Peak-to-Average Ratio

Mode	GSM850		Limit: 13dB
Mod.	GPRS class 8	EDGE class 8	Result
Lowest CH	0.44	3.52	PASS
Middle CH	0.48	3.48	
Highest CH	0.44	3.56	

Mode	GSM1900		Limit: 13dB
Mod.	GPRS class 8	EDGE class 8	Result
Lowest CH	0.60	3.36	PASS
Middle CH	0.60	3.52	
Highest CH	0.64	3.52	



GSM850 (GPRS class 8)	GSM850 (EDGE class 8)
<p align="center">Lowest Channel</p> <p>Center 824.2 MHz 2 dB/ Mean Pwr + 20 dB</p> <p>Complementary Cumulative Distribution Function (100000 samples)</p> <p>Trace 1</p> <p>Mean 33.20 dBm Peak 33.70 dBm Crest 0.50 dB</p> <p>10 % 0.32 dB 1 % 0.40 dB .1 % 0.44 dB .01 % 0.48 dB</p> <p>Date: 3.SEP.2017 15:26:53</p>	<p align="center">Lowest Channel</p> <p>Center 824.2 MHz 2 dB/ Mean Pwr + 20 dB</p> <p>Complementary Cumulative Distribution Function (100000 samples)</p> <p>Trace 1</p> <p>Mean 26.93 dBm Peak 30.53 dBm Crest 3.60 dB</p> <p>10 % 2.68 dB 1 % 3.40 dB .1 % 3.52 dB .01 % 3.56 dB</p> <p>Date: 3.SEP.2017 15:54:34</p>
<p align="center">Middle Channel</p> <p>Center 836.4 MHz 2 dB/ Mean Pwr + 20 dB</p> <p>Complementary Cumulative Distribution Function (100000 samples)</p> <p>Trace 1</p> <p>Mean 33.16 dBm Peak 33.63 dBm Crest 0.47 dB</p> <p>10 % 0.32 dB 1 % 0.40 dB .1 % 0.48 dB .01 % 0.48 dB</p> <p>Date: 3.SEP.2017 15:27:13</p>	<p align="center">Middle Channel</p> <p>Center 836.4 MHz 2 dB/ Mean Pwr + 20 dB</p> <p>Complementary Cumulative Distribution Function (100000 samples)</p> <p>Trace 1</p> <p>Mean 26.89 dBm Peak 30.53 dBm Crest 3.63 dB</p> <p>10 % 2.60 dB 1 % 3.32 dB .1 % 3.48 dB .01 % 3.56 dB</p> <p>Date: 3.SEP.2017 15:54:55</p>
<p align="center">Highest Channel</p> <p>Center 848.8 MHz 2 dB/ Mean Pwr + 20 dB</p> <p>Complementary Cumulative Distribution Function (100000 samples)</p> <p>Trace 1</p> <p>Mean 33.15 dBm Peak 33.63 dBm Crest 0.48 dB</p> <p>10 % 0.32 dB 1 % 0.40 dB .1 % 0.44 dB .01 % 0.48 dB</p> <p>Date: 3.SEP.2017 15:27:30</p>	<p align="center">Highest Channel</p> <p>Center 848.8 MHz 2 dB/ Mean Pwr + 20 dB</p> <p>Complementary Cumulative Distribution Function (100000 samples)</p> <p>Trace 1</p> <p>Mean 26.80 dBm Peak 30.38 dBm Crest 3.59 dB</p> <p>10 % 2.64 dB 1 % 3.40 dB .1 % 3.56 dB .01 % 3.60 dB</p> <p>Date: 3.SEP.2017 15:55:15</p>

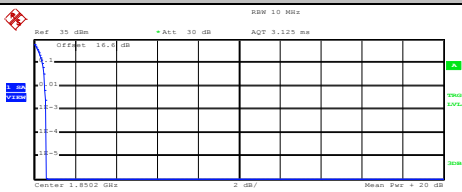
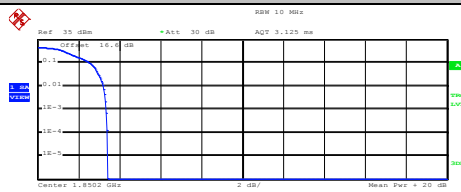
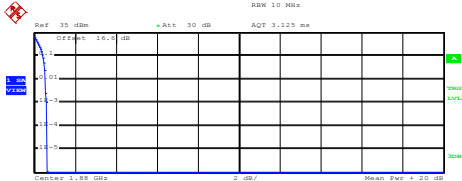
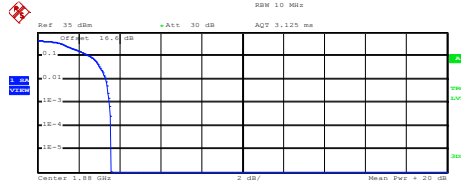
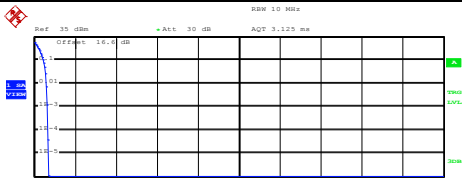
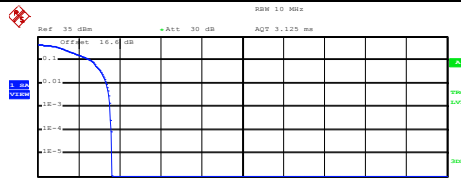

GSM1900 (GPRS class 8)	GSM1900 (EDGE class 8)																
<p style="text-align: center;">Lowest Channel</p>  <p>Ref: 35 dBm Att: 30 dB AQT: 3.125 ms Center: 1.8502 GHz 2 dB/ Mean Pwr: +20 dB</p> <p>Complementary Cumulative Distribution Function (100000 samples) Trace 1 Mean: 30.08 dBm Peak: 30.67 dBm Crest: 0.58 dB</p> <table border="1"> <tr><td>10 %</td><td>0.40 dB</td></tr> <tr><td>1 %</td><td>0.52 dB</td></tr> <tr><td>.1 %</td><td>0.60 dB</td></tr> <tr><td>.01 %</td><td>0.60 dB</td></tr> </table> <p>Date: 3.SEP.2017 16:14:47</p>	10 %	0.40 dB	1 %	0.52 dB	.1 %	0.60 dB	.01 %	0.60 dB	<p style="text-align: center;">Lowest Channel</p>  <p>Ref: 35 dBm Att: 30 dB AQT: 3.125 ms Center: 1.8502 GHz 2 dB/ Mean Pwr: +20 dB</p> <p>Complementary Cumulative Distribution Function (100000 samples) Trace 1 Mean: 25.57 dBm Peak: 28.97 dBm Crest: 3.40 dB</p> <table border="1"> <tr><td>10 %</td><td>2.56 dB</td></tr> <tr><td>1 %</td><td>3.20 dB</td></tr> <tr><td>.1 %</td><td>3.36 dB</td></tr> <tr><td>.01 %</td><td>3.40 dB</td></tr> </table> <p>Date: 3.SEP.2017 16:34:57</p>	10 %	2.56 dB	1 %	3.20 dB	.1 %	3.36 dB	.01 %	3.40 dB
10 %	0.40 dB																
1 %	0.52 dB																
.1 %	0.60 dB																
.01 %	0.60 dB																
10 %	2.56 dB																
1 %	3.20 dB																
.1 %	3.36 dB																
.01 %	3.40 dB																
<p style="text-align: center;">Middle Channel</p>  <p>Ref: 35 dBm Att: 30 dB AQT: 3.125 ms Center: 1.88 GHz 2 dB/ Mean Pwr: +20 dB</p> <p>Complementary Cumulative Distribution Function (100000 samples) Trace 1 Mean: 29.97 dBm Peak: 30.60 dBm Crest: 0.62 dB</p> <table border="1"> <tr><td>10 %</td><td>0.44 dB</td></tr> <tr><td>1 %</td><td>0.56 dB</td></tr> <tr><td>.1 %</td><td>0.60 dB</td></tr> <tr><td>.01 %</td><td>0.64 dB</td></tr> </table> <p>Date: 3.SEP.2017 16:15:06</p>	10 %	0.44 dB	1 %	0.56 dB	.1 %	0.60 dB	.01 %	0.64 dB	<p style="text-align: center;">Middle Channel</p>  <p>Ref: 35 dBm Att: 30 dB AQT: 3.125 ms Center: 1.88 GHz 2 dB/ Mean Pwr: +20 dB</p> <p>Complementary Cumulative Distribution Function (100000 samples) Trace 1 Mean: 25.33 dBm Peak: 28.90 dBm Crest: 3.58 dB</p> <table border="1"> <tr><td>10 %</td><td>2.56 dB</td></tr> <tr><td>1 %</td><td>3.32 dB</td></tr> <tr><td>.1 %</td><td>3.52 dB</td></tr> <tr><td>.01 %</td><td>3.60 dB</td></tr> </table> <p>Date: 3.SEP.2017 16:35:16</p>	10 %	2.56 dB	1 %	3.32 dB	.1 %	3.52 dB	.01 %	3.60 dB
10 %	0.44 dB																
1 %	0.56 dB																
.1 %	0.60 dB																
.01 %	0.64 dB																
10 %	2.56 dB																
1 %	3.32 dB																
.1 %	3.52 dB																
.01 %	3.60 dB																
<p style="text-align: center;">Highest Channel</p>  <p>Ref: 35 dBm Att: 30 dB AQT: 3.125 ms Center: 1.9098 GHz 2 dB/ Mean Pwr: +20 dB</p> <p>Complementary Cumulative Distribution Function (100000 samples) Trace 1 Mean: 29.99 dBm Peak: 30.67 dBm Crest: 0.68 dB</p> <table border="1"> <tr><td>10 %</td><td>0.44 dB</td></tr> <tr><td>1 %</td><td>0.60 dB</td></tr> <tr><td>.1 %</td><td>0.64 dB</td></tr> <tr><td>.01 %</td><td>0.68 dB</td></tr> </table> <p>Date: 3.SEP.2017 16:15:27</p>	10 %	0.44 dB	1 %	0.60 dB	.1 %	0.64 dB	.01 %	0.68 dB	<p style="text-align: center;">Highest Channel</p>  <p>Ref: 35 dBm Att: 30 dB AQT: 3.125 ms Center: 1.9098 GHz 2 dB/ Mean Pwr: +20 dB</p> <p>Complementary Cumulative Distribution Function (100000 samples) Trace 1 Mean: 25.22 dBm Peak: 28.83 dBm Crest: 3.61 dB</p> <table border="1"> <tr><td>10 %</td><td>2.60 dB</td></tr> <tr><td>1 %</td><td>3.36 dB</td></tr> <tr><td>.1 %</td><td>3.52 dB</td></tr> <tr><td>.01 %</td><td>3.60 dB</td></tr> </table> <p>Date: 3.SEP.2017 16:35:48</p>	10 %	2.60 dB	1 %	3.36 dB	.1 %	3.52 dB	.01 %	3.60 dB
10 %	0.44 dB																
1 %	0.60 dB																
.1 %	0.64 dB																
.01 %	0.68 dB																
10 %	2.60 dB																
1 %	3.36 dB																
.1 %	3.52 dB																
.01 %	3.60 dB																



26dB Bandwidth

Mode	GSM850	
Mod.	GPRS class 8	EDGE class 8
Lowest CH	0.31	0.31
Middle CH	0.32	0.31
Highest CH	0.31	0.29

Mode	GSM1900	
Mod.	GPRS class 8	EDGE class 8
Lowest CH	0.30	0.31
Middle CH	0.32	0.30
Highest CH	0.31	0.31

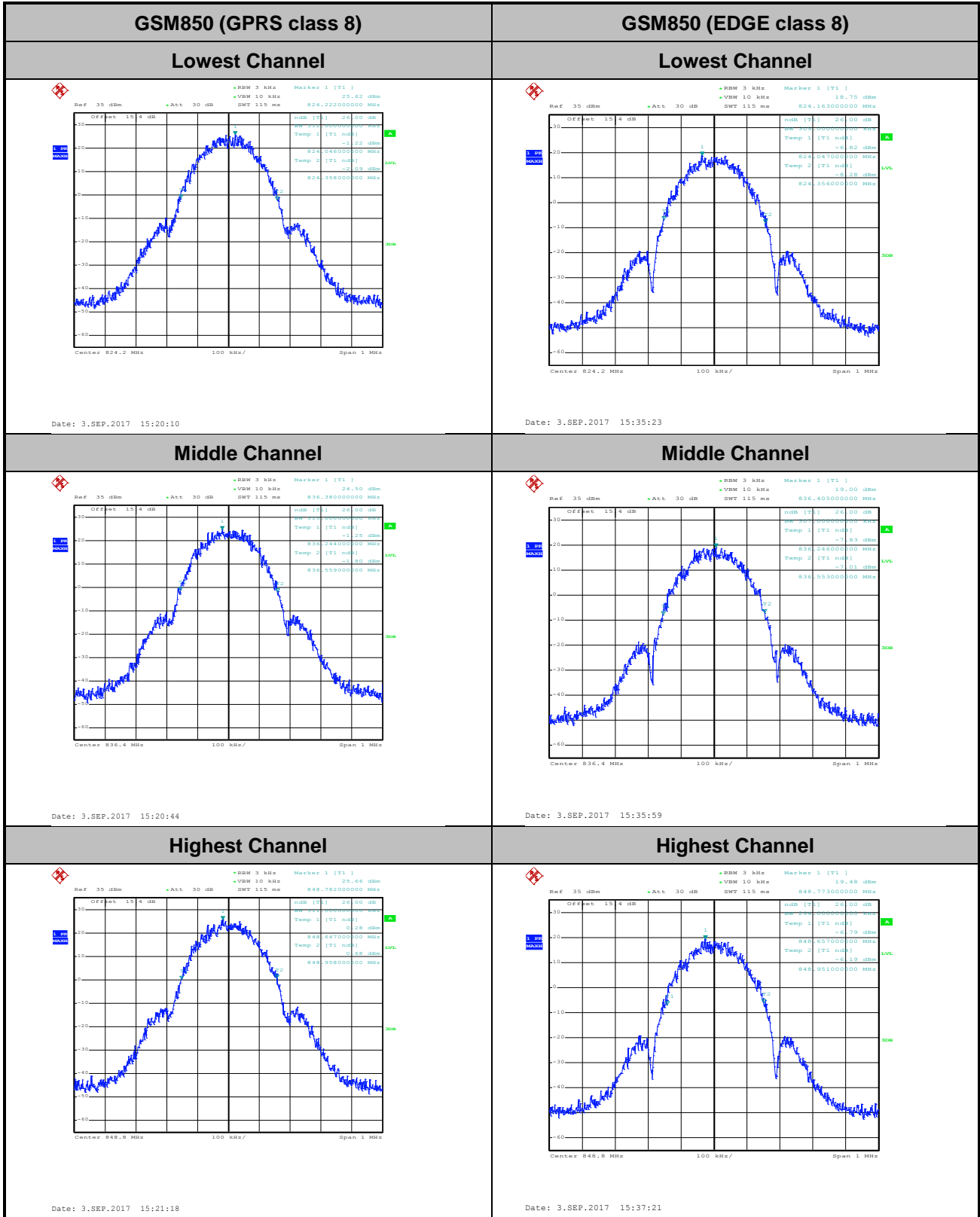

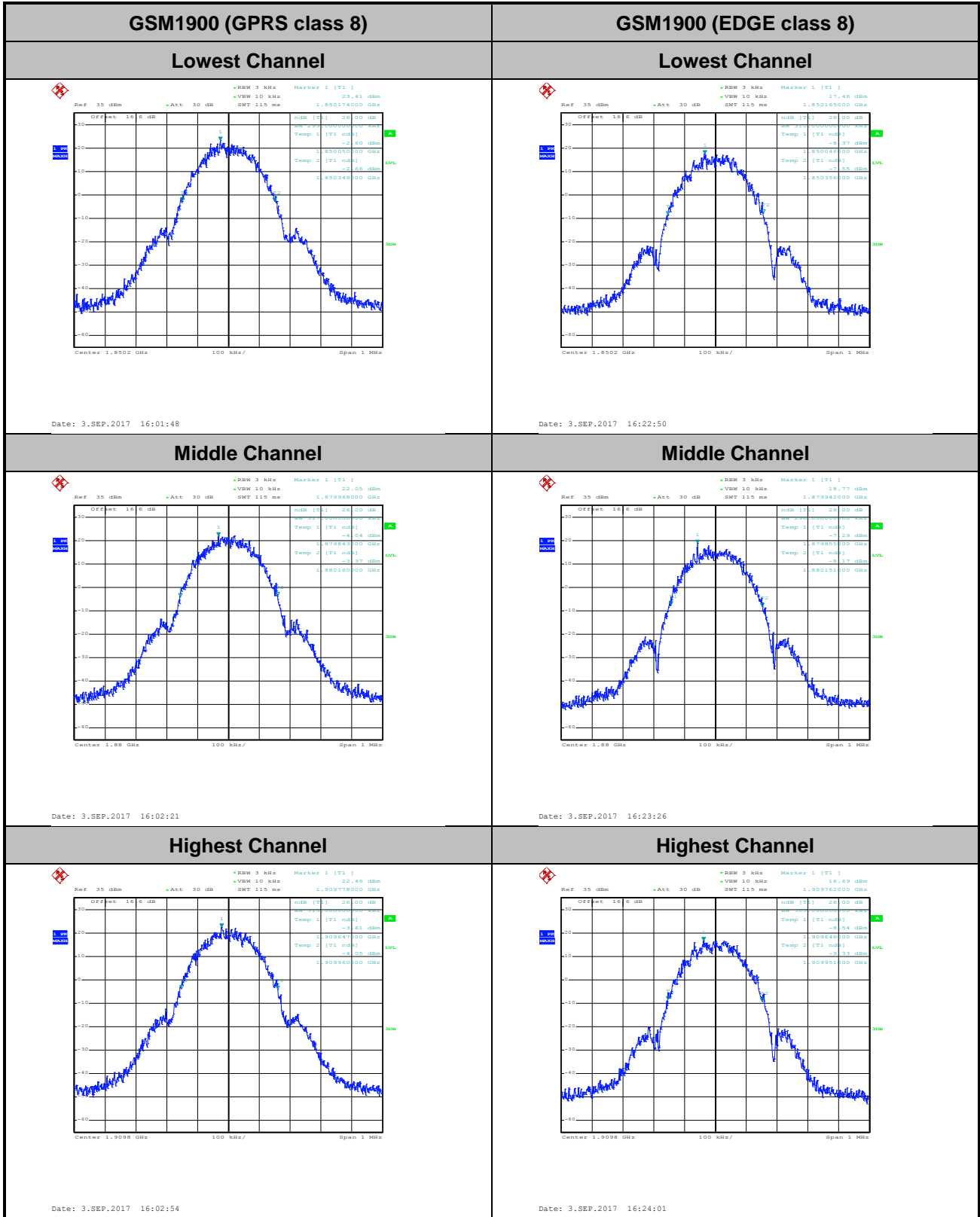



Occupied Bandwidth

Mode	GSM850	
Mod.	GPRS class 8	EDGE class 8
Lowest CH	0.246	0.247
Middle CH	0.243	0.242
Highest CH	0.248	0.242

Mode	GSM1900	
Mod.	GPRS class 8	EDGE class 8
Lowest CH	0.242	0.245
Middle CH	0.242	0.244
Highest CH	0.247	0.244

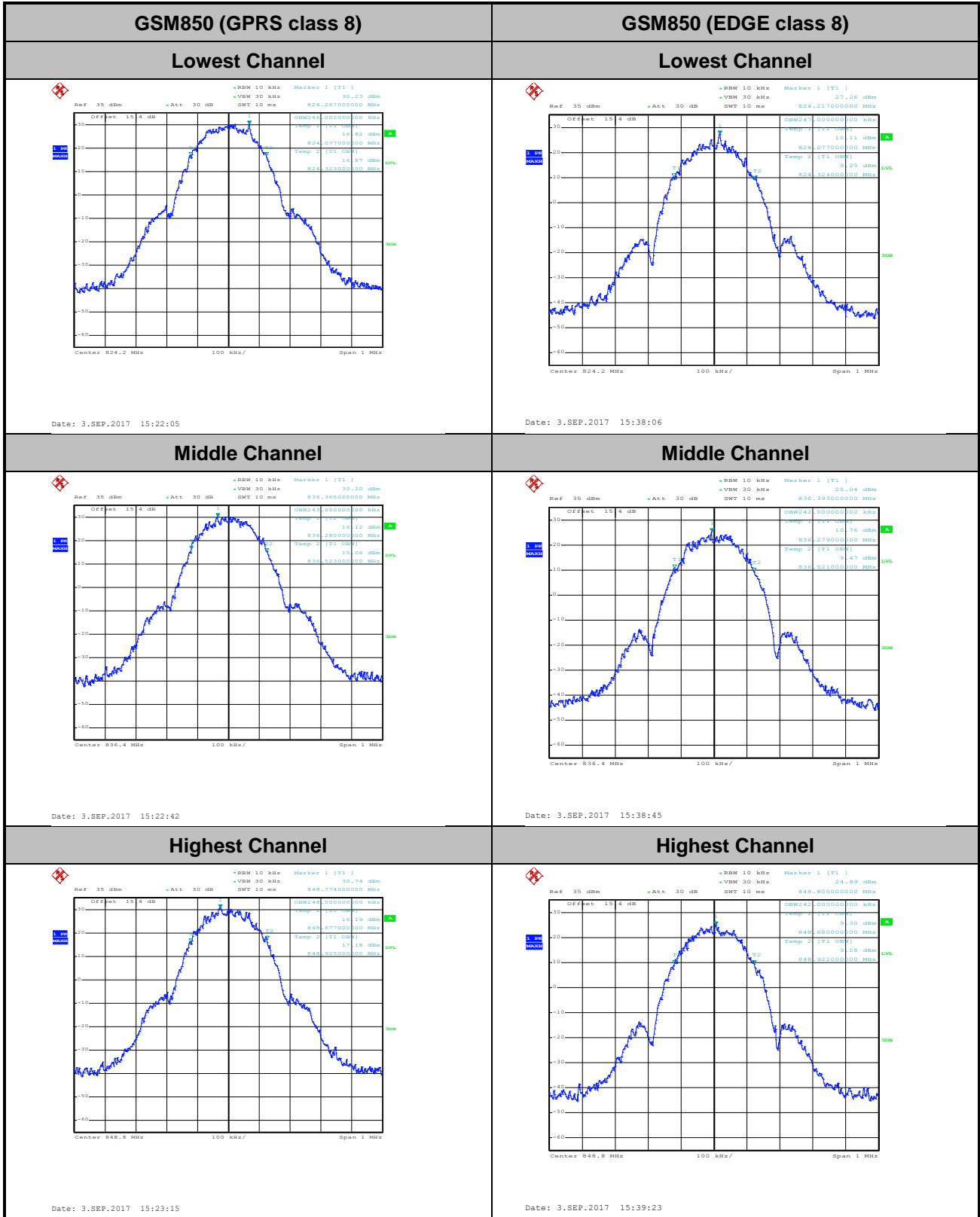

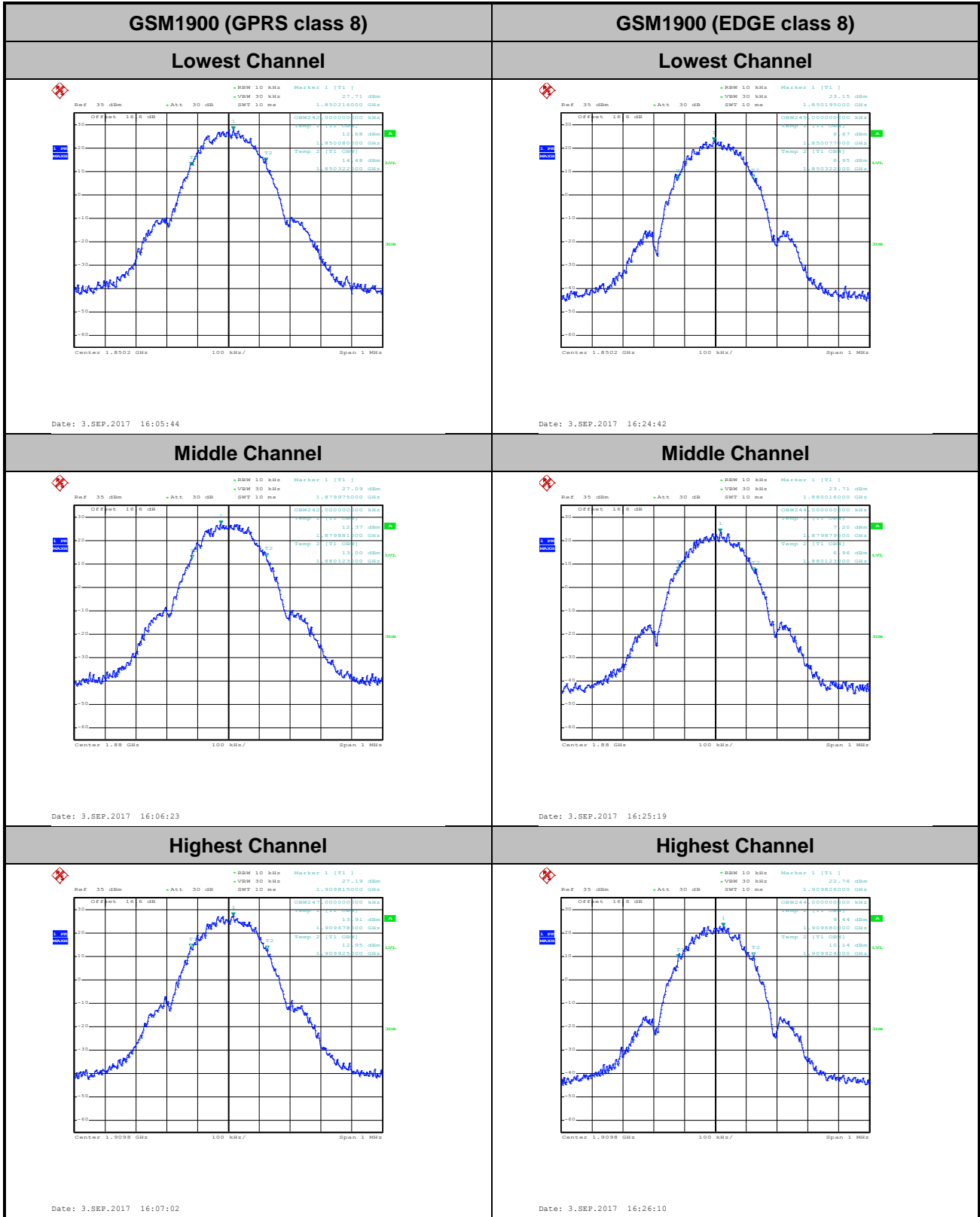



Conducted Band Edge



GSM850 (GPRS class 8)

Lowest Band Edge

Highest Band Edge

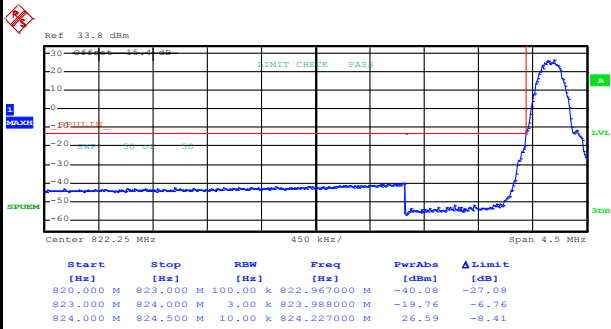

Date: 3.SEP.2017 15:24:51

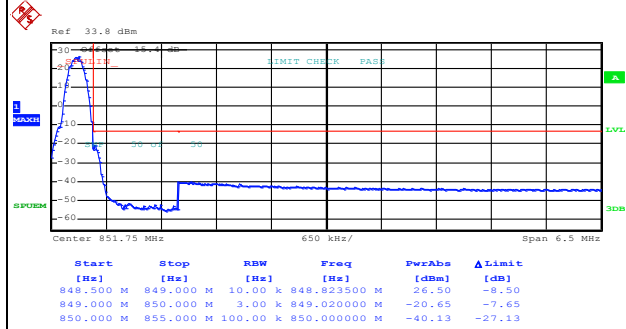

Date: 3.SEP.2017 15:26:24

GSM850 (EDGE class 8)

Lowest Band Edge

Highest Band Edge

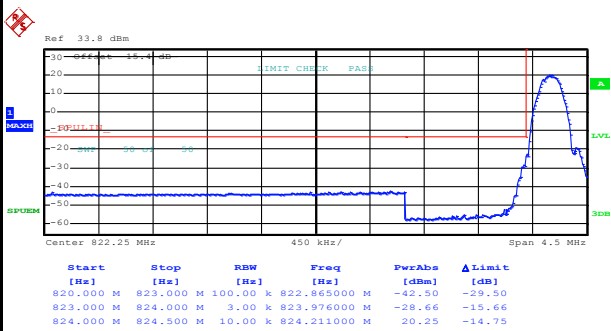

Date: 3.SEP.2017 15:41:02

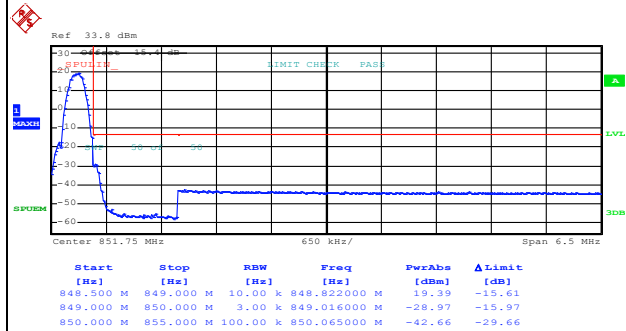

Date: 3.SEP.2017 15:44:06



GSM1900 (GPRS class 8)

Lowest Band Edge

Highest Band Edge

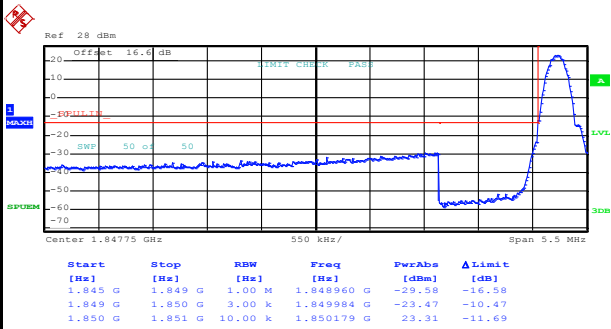

Date: 3.SEP.2017 16:09:53

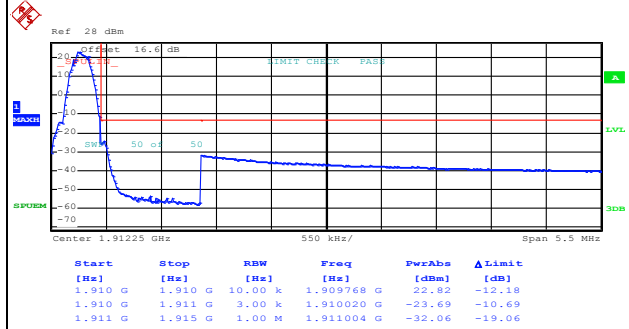

Date: 3.SEP.2017 16:11:26

GSM1900 (EDGE class 8)

Lowest Band Edge

Highest Band Edge

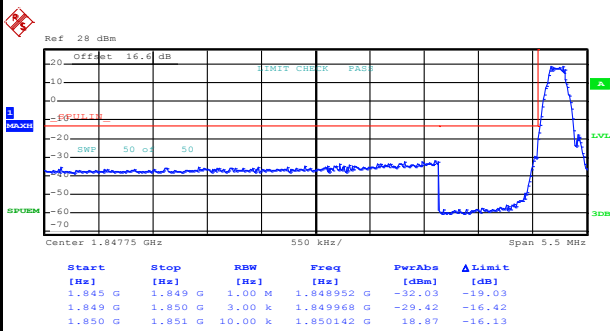

Date: 3.SEP.2017 16:27:50

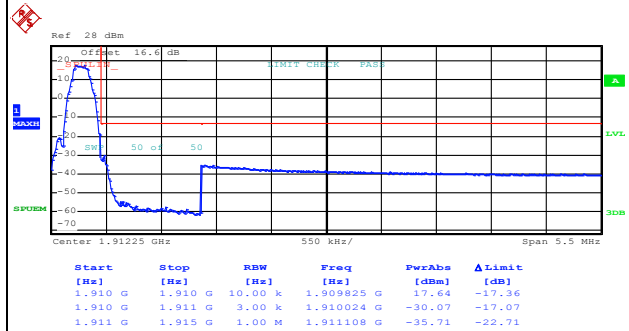

Date: 3.SEP.2017 16:29:27



Conducted Spurious Emission

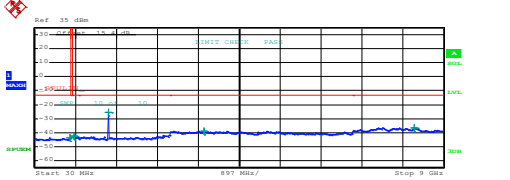
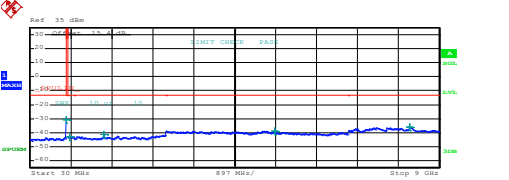
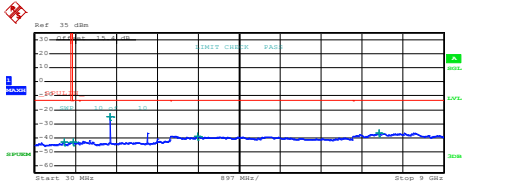
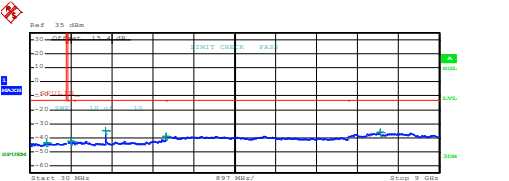
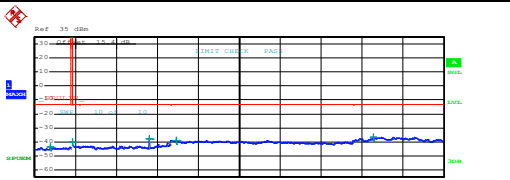
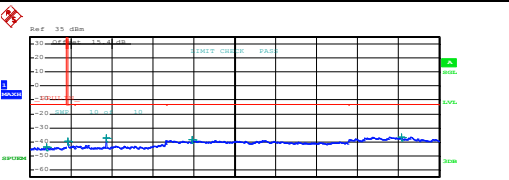

GSM850 (GPRS class 8)	GSM850 (EDGE class 8)																																																																								
Lowest Channel	Lowest Channel																																																																								
 <p>Date: 3.SEP.2017 15:17:41</p> <table border="1"> <thead> <tr> <th>Start [Hz]</th> <th>Stop [Hz]</th> <th>RBW [Hz]</th> <th>Freq [Hz]</th> <th>PwrAve [dBm]</th> <th>ΔLimit [dB]</th> </tr> </thead> <tbody> <tr> <td>35,000 M</td> <td>825,000 M</td> <td>1,000 M</td> <td>794,720000 M</td> <td>-43.93</td> <td>-30.73</td> </tr> <tr> <td>855,000 M</td> <td>1,000 G</td> <td>1,000 M</td> <td>885,848750 M</td> <td>-42.62</td> <td>-29.62</td> </tr> <tr> <td>1,000 G</td> <td>3,000 G</td> <td>1,000 M</td> <td>1,648000 G</td> <td>-23.42</td> <td>-22.42</td> </tr> <tr> <td>3,000 G</td> <td>7,000 G</td> <td>1,000 M</td> <td>3,743000 G</td> <td>-38.70</td> <td>-25.70</td> </tr> <tr> <td>7,000 G</td> <td>9,000 G</td> <td>1,000 M</td> <td>8,355000 G</td> <td>-36.37</td> <td>-23.37</td> </tr> </tbody> </table>	Start [Hz]	Stop [Hz]	RBW [Hz]	Freq [Hz]	PwrAve [dBm]	ΔLimit [dB]	35,000 M	825,000 M	1,000 M	794,720000 M	-43.93	-30.73	855,000 M	1,000 G	1,000 M	885,848750 M	-42.62	-29.62	1,000 G	3,000 G	1,000 M	1,648000 G	-23.42	-22.42	3,000 G	7,000 G	1,000 M	3,743000 G	-38.70	-25.70	7,000 G	9,000 G	1,000 M	8,355000 G	-36.37	-23.37	 <p>Date: 3.SEP.2017 15:52:15</p> <table border="1"> <thead> <tr> <th>Start [Hz]</th> <th>Stop [Hz]</th> <th>RBW [Hz]</th> <th>Freq [Hz]</th> <th>PwrAve [dBm]</th> <th>ΔLimit [dB]</th> </tr> </thead> <tbody> <tr> <td>35,000 M</td> <td>825,000 M</td> <td>1,000 M</td> <td>819,825000 M</td> <td>-35.55</td> <td>-17.55</td> </tr> <tr> <td>855,000 M</td> <td>1,000 G</td> <td>1,000 M</td> <td>899,913750 M</td> <td>-43.16</td> <td>-30.16</td> </tr> <tr> <td>1,000 G</td> <td>3,000 G</td> <td>1,000 M</td> <td>1,648000 G</td> <td>-41.21</td> <td>-28.21</td> </tr> <tr> <td>3,000 G</td> <td>7,000 G</td> <td>1,000 M</td> <td>3,397000 G</td> <td>-38.68</td> <td>-25.68</td> </tr> <tr> <td>7,000 G</td> <td>9,000 G</td> <td>1,000 M</td> <td>8,357500 G</td> <td>-36.15</td> <td>-23.15</td> </tr> </tbody> </table>	Start [Hz]	Stop [Hz]	RBW [Hz]	Freq [Hz]	PwrAve [dBm]	ΔLimit [dB]	35,000 M	825,000 M	1,000 M	819,825000 M	-35.55	-17.55	855,000 M	1,000 G	1,000 M	899,913750 M	-43.16	-30.16	1,000 G	3,000 G	1,000 M	1,648000 G	-41.21	-28.21	3,000 G	7,000 G	1,000 M	3,397000 G	-38.68	-25.68	7,000 G	9,000 G	1,000 M	8,357500 G	-36.15	-23.15
Start [Hz]	Stop [Hz]	RBW [Hz]	Freq [Hz]	PwrAve [dBm]	ΔLimit [dB]																																																																				
35,000 M	825,000 M	1,000 M	794,720000 M	-43.93	-30.73																																																																				
855,000 M	1,000 G	1,000 M	885,848750 M	-42.62	-29.62																																																																				
1,000 G	3,000 G	1,000 M	1,648000 G	-23.42	-22.42																																																																				
3,000 G	7,000 G	1,000 M	3,743000 G	-38.70	-25.70																																																																				
7,000 G	9,000 G	1,000 M	8,355000 G	-36.37	-23.37																																																																				
Start [Hz]	Stop [Hz]	RBW [Hz]	Freq [Hz]	PwrAve [dBm]	ΔLimit [dB]																																																																				
35,000 M	825,000 M	1,000 M	819,825000 M	-35.55	-17.55																																																																				
855,000 M	1,000 G	1,000 M	899,913750 M	-43.16	-30.16																																																																				
1,000 G	3,000 G	1,000 M	1,648000 G	-41.21	-28.21																																																																				
3,000 G	7,000 G	1,000 M	3,397000 G	-38.68	-25.68																																																																				
7,000 G	9,000 G	1,000 M	8,357500 G	-36.15	-23.15																																																																				
Middle Channel	Middle Channel																																																																								
 <p>Date: 3.SEP.2017 15:18:35</p> <table border="1"> <thead> <tr> <th>Start [Hz]</th> <th>Stop [Hz]</th> <th>RBW [Hz]</th> <th>Freq [Hz]</th> <th>PwrAve [dBm]</th> <th>ΔLimit [dB]</th> </tr> </thead> <tbody> <tr> <td>35,000 M</td> <td>825,000 M</td> <td>1,000 M</td> <td>883,132500 M</td> <td>-43.34</td> <td>-30.34</td> </tr> <tr> <td>855,000 M</td> <td>1,000 G</td> <td>1,000 M</td> <td>869,060000 M</td> <td>-42.98</td> <td>-29.98</td> </tr> <tr> <td>1,000 G</td> <td>3,000 G</td> <td>1,000 M</td> <td>1,673000 G</td> <td>-24.99</td> <td>-11.99</td> </tr> <tr> <td>3,000 G</td> <td>7,000 G</td> <td>1,000 M</td> <td>3,603000 G</td> <td>-38.71</td> <td>-25.71</td> </tr> <tr> <td>7,000 G</td> <td>9,000 G</td> <td>1,000 M</td> <td>7,374000 G</td> <td>-36.68</td> <td>-23.68</td> </tr> </tbody> </table>	Start [Hz]	Stop [Hz]	RBW [Hz]	Freq [Hz]	PwrAve [dBm]	ΔLimit [dB]	35,000 M	825,000 M	1,000 M	883,132500 M	-43.34	-30.34	855,000 M	1,000 G	1,000 M	869,060000 M	-42.98	-29.98	1,000 G	3,000 G	1,000 M	1,673000 G	-24.99	-11.99	3,000 G	7,000 G	1,000 M	3,603000 G	-38.71	-25.71	7,000 G	9,000 G	1,000 M	7,374000 G	-36.68	-23.68	 <p>Date: 3.SEP.2017 15:53:06</p> <table border="1"> <thead> <tr> <th>Start [Hz]</th> <th>Stop [Hz]</th> <th>RBW [Hz]</th> <th>Freq [Hz]</th> <th>PwrAve [dBm]</th> <th>ΔLimit [dB]</th> </tr> </thead> <tbody> <tr> <td>35,000 M</td> <td>825,000 M</td> <td>1,000 M</td> <td>396,560000 M</td> <td>-43.70</td> <td>-30.70</td> </tr> <tr> <td>855,000 M</td> <td>1,000 G</td> <td>1,000 M</td> <td>821,853250 M</td> <td>-42.78</td> <td>-29.78</td> </tr> <tr> <td>1,000 G</td> <td>3,000 G</td> <td>1,000 M</td> <td>1,673000 G</td> <td>-35.00</td> <td>-22.00</td> </tr> <tr> <td>3,000 G</td> <td>7,000 G</td> <td>1,000 M</td> <td>3,610000 G</td> <td>-38.72</td> <td>-25.72</td> </tr> <tr> <td>7,000 G</td> <td>9,000 G</td> <td>1,000 M</td> <td>7,730000 G</td> <td>-36.32</td> <td>-23.32</td> </tr> </tbody> </table>	Start [Hz]	Stop [Hz]	RBW [Hz]	Freq [Hz]	PwrAve [dBm]	ΔLimit [dB]	35,000 M	825,000 M	1,000 M	396,560000 M	-43.70	-30.70	855,000 M	1,000 G	1,000 M	821,853250 M	-42.78	-29.78	1,000 G	3,000 G	1,000 M	1,673000 G	-35.00	-22.00	3,000 G	7,000 G	1,000 M	3,610000 G	-38.72	-25.72	7,000 G	9,000 G	1,000 M	7,730000 G	-36.32	-23.32
Start [Hz]	Stop [Hz]	RBW [Hz]	Freq [Hz]	PwrAve [dBm]	ΔLimit [dB]																																																																				
35,000 M	825,000 M	1,000 M	883,132500 M	-43.34	-30.34																																																																				
855,000 M	1,000 G	1,000 M	869,060000 M	-42.98	-29.98																																																																				
1,000 G	3,000 G	1,000 M	1,673000 G	-24.99	-11.99																																																																				
3,000 G	7,000 G	1,000 M	3,603000 G	-38.71	-25.71																																																																				
7,000 G	9,000 G	1,000 M	7,374000 G	-36.68	-23.68																																																																				
Start [Hz]	Stop [Hz]	RBW [Hz]	Freq [Hz]	PwrAve [dBm]	ΔLimit [dB]																																																																				
35,000 M	825,000 M	1,000 M	396,560000 M	-43.70	-30.70																																																																				
855,000 M	1,000 G	1,000 M	821,853250 M	-42.78	-29.78																																																																				
1,000 G	3,000 G	1,000 M	1,673000 G	-35.00	-22.00																																																																				
3,000 G	7,000 G	1,000 M	3,610000 G	-38.72	-25.72																																																																				
7,000 G	9,000 G	1,000 M	7,730000 G	-36.32	-23.32																																																																				
Highest Channel	Highest Channel																																																																								
 <p>Date: 3.SEP.2017 15:19:26</p> <table border="1"> <thead> <tr> <th>Start [Hz]</th> <th>Stop [Hz]</th> <th>RBW [Hz]</th> <th>Freq [Hz]</th> <th>PwrAve [dBm]</th> <th>ΔLimit [dB]</th> </tr> </thead> <tbody> <tr> <td>35,000 M</td> <td>825,000 M</td> <td>1,000 M</td> <td>363,770000 M</td> <td>-43.39</td> <td>-30.39</td> </tr> <tr> <td>855,000 M</td> <td>1,000 G</td> <td>1,000 M</td> <td>855,580000 M</td> <td>-40.39</td> <td>-27.39</td> </tr> <tr> <td>1,000 G</td> <td>3,000 G</td> <td>1,000 M</td> <td>2,346000 G</td> <td>-37.75</td> <td>-24.75</td> </tr> <tr> <td>3,000 G</td> <td>7,000 G</td> <td>1,000 M</td> <td>3,132000 G</td> <td>-38.89</td> <td>-25.89</td> </tr> <tr> <td>7,000 G</td> <td>9,000 G</td> <td>1,000 M</td> <td>7,466000 G</td> <td>-36.78</td> <td>-23.78</td> </tr> </tbody> </table>	Start [Hz]	Stop [Hz]	RBW [Hz]	Freq [Hz]	PwrAve [dBm]	ΔLimit [dB]	35,000 M	825,000 M	1,000 M	363,770000 M	-43.39	-30.39	855,000 M	1,000 G	1,000 M	855,580000 M	-40.39	-27.39	1,000 G	3,000 G	1,000 M	2,346000 G	-37.75	-24.75	3,000 G	7,000 G	1,000 M	3,132000 G	-38.89	-25.89	7,000 G	9,000 G	1,000 M	7,466000 G	-36.78	-23.78	 <p>Date: 3.SEP.2017 15:53:58</p> <table border="1"> <thead> <tr> <th>Start [Hz]</th> <th>Stop [Hz]</th> <th>RBW [Hz]</th> <th>Freq [Hz]</th> <th>PwrAve [dBm]</th> <th>ΔLimit [dB]</th> </tr> </thead> <tbody> <tr> <td>35,000 M</td> <td>825,000 M</td> <td>1,000 M</td> <td>387,050000 M</td> <td>-43.60</td> <td>-30.60</td> </tr> <tr> <td>855,000 M</td> <td>1,000 G</td> <td>1,000 M</td> <td>855,036250 M</td> <td>-39.42</td> <td>-26.42</td> </tr> <tr> <td>1,000 G</td> <td>3,000 G</td> <td>1,000 M</td> <td>1,639000 G</td> <td>-37.44</td> <td>-24.44</td> </tr> <tr> <td>3,000 G</td> <td>7,000 G</td> <td>1,000 M</td> <td>3,588000 G</td> <td>-38.62</td> <td>-25.62</td> </tr> <tr> <td>7,000 G</td> <td>9,000 G</td> <td>1,000 M</td> <td>8,177500 G</td> <td>-36.55</td> <td>-23.55</td> </tr> </tbody> </table>	Start [Hz]	Stop [Hz]	RBW [Hz]	Freq [Hz]	PwrAve [dBm]	ΔLimit [dB]	35,000 M	825,000 M	1,000 M	387,050000 M	-43.60	-30.60	855,000 M	1,000 G	1,000 M	855,036250 M	-39.42	-26.42	1,000 G	3,000 G	1,000 M	1,639000 G	-37.44	-24.44	3,000 G	7,000 G	1,000 M	3,588000 G	-38.62	-25.62	7,000 G	9,000 G	1,000 M	8,177500 G	-36.55	-23.55
Start [Hz]	Stop [Hz]	RBW [Hz]	Freq [Hz]	PwrAve [dBm]	ΔLimit [dB]																																																																				
35,000 M	825,000 M	1,000 M	363,770000 M	-43.39	-30.39																																																																				
855,000 M	1,000 G	1,000 M	855,580000 M	-40.39	-27.39																																																																				
1,000 G	3,000 G	1,000 M	2,346000 G	-37.75	-24.75																																																																				
3,000 G	7,000 G	1,000 M	3,132000 G	-38.89	-25.89																																																																				
7,000 G	9,000 G	1,000 M	7,466000 G	-36.78	-23.78																																																																				
Start [Hz]	Stop [Hz]	RBW [Hz]	Freq [Hz]	PwrAve [dBm]	ΔLimit [dB]																																																																				
35,000 M	825,000 M	1,000 M	387,050000 M	-43.60	-30.60																																																																				
855,000 M	1,000 G	1,000 M	855,036250 M	-39.42	-26.42																																																																				
1,000 G	3,000 G	1,000 M	1,639000 G	-37.44	-24.44																																																																				
3,000 G	7,000 G	1,000 M	3,588000 G	-38.62	-25.62																																																																				
7,000 G	9,000 G	1,000 M	8,177500 G	-36.55	-23.55																																																																				

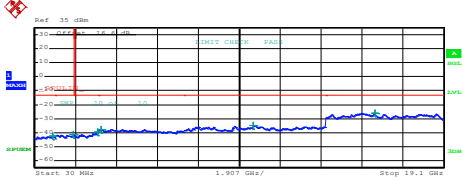
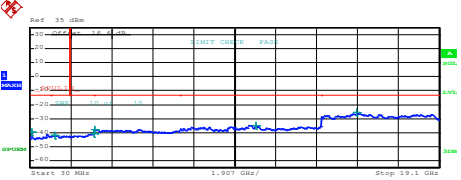
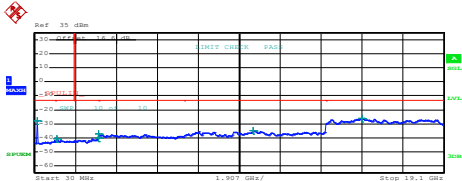
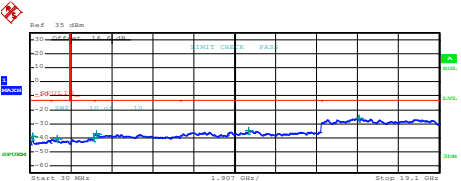
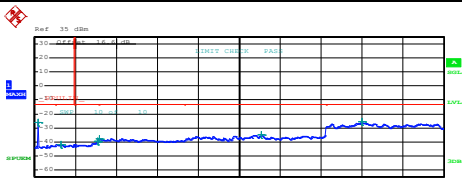
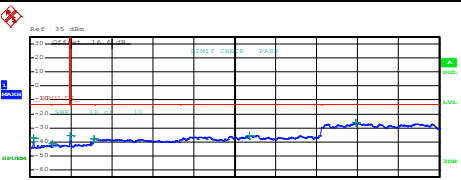

GSM1900 (GPRS class 8)	GSM1900 (EDGE class 8)																																																																																				
Lowest Channel	Lowest Channel																																																																																				
 <table border="1" data-bbox="239 577 638 672"> <thead> <tr> <th>Start [Hz]</th> <th>Stop [Hz]</th> <th>RBW [Hz]</th> <th>Freq [Hz]</th> <th>PwrAve [dBm]</th> <th>ΔLimit [dB]</th> </tr> </thead> <tbody> <tr><td>30,000 M</td><td>1,000 G</td><td>1,000 M</td><td>865,633500 M</td><td>-42.25</td><td>-29.25</td></tr> <tr><td>1,000 G</td><td>1,845 G</td><td>1,000 M</td><td>1,843,409 G</td><td>-41.24</td><td>-28.24</td></tr> <tr><td>1,845 G</td><td>3,000 G</td><td>1,000 M</td><td>2,9022396 G</td><td>-39.81</td><td>-26.41</td></tr> <tr><td>3,000 G</td><td>7,000 G</td><td>1,000 M</td><td>3,127000 G</td><td>-37.77</td><td>-24.77</td></tr> <tr><td>7,000 G</td><td>13,600 G</td><td>1,000 M</td><td>10,218325 G</td><td>-34.77</td><td>-21.77</td></tr> <tr><td>13,600 G</td><td>19,100 G</td><td>1,000 M</td><td>15,898938 G</td><td>-25.96</td><td>-12.96</td></tr> </tbody> </table> <p>Date: 3.SEP.2017 16:12:27</p>	Start [Hz]	Stop [Hz]	RBW [Hz]	Freq [Hz]	PwrAve [dBm]	ΔLimit [dB]	30,000 M	1,000 G	1,000 M	865,633500 M	-42.25	-29.25	1,000 G	1,845 G	1,000 M	1,843,409 G	-41.24	-28.24	1,845 G	3,000 G	1,000 M	2,9022396 G	-39.81	-26.41	3,000 G	7,000 G	1,000 M	3,127000 G	-37.77	-24.77	7,000 G	13,600 G	1,000 M	10,218325 G	-34.77	-21.77	13,600 G	19,100 G	1,000 M	15,898938 G	-25.96	-12.96	 <table border="1" data-bbox="893 577 1292 672"> <thead> <tr> <th>Start [Hz]</th> <th>Stop [Hz]</th> <th>RBW [Hz]</th> <th>Freq [Hz]</th> <th>PwrAve [dBm]</th> <th>ΔLimit [dB]</th> </tr> </thead> <tbody> <tr><td>30,000 M</td><td>1,000 G</td><td>1,000 M</td><td>112,207800 M</td><td>-39.27</td><td>-26.27</td></tr> <tr><td>1,000 G</td><td>1,845 G</td><td>1,000 M</td><td>1,371746 G</td><td>-41.89</td><td>-28.89</td></tr> <tr><td>1,845 G</td><td>3,000 G</td><td>1,000 M</td><td>2,998866 G</td><td>-40.59</td><td>-27.59</td></tr> <tr><td>3,000 G</td><td>7,000 G</td><td>1,000 M</td><td>3,035000 G</td><td>-37.65</td><td>-24.65</td></tr> <tr><td>7,000 G</td><td>13,600 G</td><td>1,000 M</td><td>10,544200 G</td><td>-34.64</td><td>-21.64</td></tr> <tr><td>13,600 G</td><td>19,100 G</td><td>1,000 M</td><td>15,237625 G</td><td>-25.69</td><td>-12.69</td></tr> </tbody> </table> <p>Date: 3.SEP.2017 16:30:32</p>	Start [Hz]	Stop [Hz]	RBW [Hz]	Freq [Hz]	PwrAve [dBm]	ΔLimit [dB]	30,000 M	1,000 G	1,000 M	112,207800 M	-39.27	-26.27	1,000 G	1,845 G	1,000 M	1,371746 G	-41.89	-28.89	1,845 G	3,000 G	1,000 M	2,998866 G	-40.59	-27.59	3,000 G	7,000 G	1,000 M	3,035000 G	-37.65	-24.65	7,000 G	13,600 G	1,000 M	10,544200 G	-34.64	-21.64	13,600 G	19,100 G	1,000 M	15,237625 G	-25.69	-12.69
Start [Hz]	Stop [Hz]	RBW [Hz]	Freq [Hz]	PwrAve [dBm]	ΔLimit [dB]																																																																																
30,000 M	1,000 G	1,000 M	865,633500 M	-42.25	-29.25																																																																																
1,000 G	1,845 G	1,000 M	1,843,409 G	-41.24	-28.24																																																																																
1,845 G	3,000 G	1,000 M	2,9022396 G	-39.81	-26.41																																																																																
3,000 G	7,000 G	1,000 M	3,127000 G	-37.77	-24.77																																																																																
7,000 G	13,600 G	1,000 M	10,218325 G	-34.77	-21.77																																																																																
13,600 G	19,100 G	1,000 M	15,898938 G	-25.96	-12.96																																																																																
Start [Hz]	Stop [Hz]	RBW [Hz]	Freq [Hz]	PwrAve [dBm]	ΔLimit [dB]																																																																																
30,000 M	1,000 G	1,000 M	112,207800 M	-39.27	-26.27																																																																																
1,000 G	1,845 G	1,000 M	1,371746 G	-41.89	-28.89																																																																																
1,845 G	3,000 G	1,000 M	2,998866 G	-40.59	-27.59																																																																																
3,000 G	7,000 G	1,000 M	3,035000 G	-37.65	-24.65																																																																																
7,000 G	13,600 G	1,000 M	10,544200 G	-34.64	-21.64																																																																																
13,600 G	19,100 G	1,000 M	15,237625 G	-25.69	-12.69																																																																																
Middle Channel	Middle Channel																																																																																				
 <table border="1" data-bbox="239 1093 638 1187"> <thead> <tr> <th>Start [Hz]</th> <th>Stop [Hz]</th> <th>RBW [Hz]</th> <th>Freq [Hz]</th> <th>PwrAve [dBm]</th> <th>ΔLimit [dB]</th> </tr> </thead> <tbody> <tr><td>30,000 M</td><td>1,000 G</td><td>1,000 M</td><td>141,792500 M</td><td>-27.82</td><td>-14.82</td></tr> <tr><td>1,000 G</td><td>1,845 G</td><td>1,000 M</td><td>1,0069864 G</td><td>-41.00</td><td>-28.00</td></tr> <tr><td>1,845 G</td><td>3,000 G</td><td>1,000 M</td><td>2,986745 G</td><td>-40.13</td><td>-27.13</td></tr> <tr><td>3,000 G</td><td>7,000 G</td><td>1,000 M</td><td>3,013000 G</td><td>-37.51</td><td>-24.51</td></tr> <tr><td>7,000 G</td><td>13,600 G</td><td>1,000 M</td><td>10,222450 G</td><td>-34.69</td><td>-21.69</td></tr> <tr><td>13,600 G</td><td>19,100 G</td><td>1,000 M</td><td>15,294688 G</td><td>-26.11</td><td>-13.11</td></tr> </tbody> </table> <p>Date: 3.SEP.2017 16:13:20</p>	Start [Hz]	Stop [Hz]	RBW [Hz]	Freq [Hz]	PwrAve [dBm]	ΔLimit [dB]	30,000 M	1,000 G	1,000 M	141,792500 M	-27.82	-14.82	1,000 G	1,845 G	1,000 M	1,0069864 G	-41.00	-28.00	1,845 G	3,000 G	1,000 M	2,986745 G	-40.13	-27.13	3,000 G	7,000 G	1,000 M	3,013000 G	-37.51	-24.51	7,000 G	13,600 G	1,000 M	10,222450 G	-34.69	-21.69	13,600 G	19,100 G	1,000 M	15,294688 G	-26.11	-13.11	 <table border="1" data-bbox="893 1093 1292 1187"> <thead> <tr> <th>Start [Hz]</th> <th>Stop [Hz]</th> <th>RBW [Hz]</th> <th>Freq [Hz]</th> <th>PwrAve [dBm]</th> <th>ΔLimit [dB]</th> </tr> </thead> <tbody> <tr><td>30,000 M</td><td>1,000 G</td><td>1,000 M</td><td>141,792500 M</td><td>-38.93</td><td>-25.93</td></tr> <tr><td>1,000 G</td><td>1,845 G</td><td>1,000 M</td><td>1,0281808 G</td><td>-40.89</td><td>-27.89</td></tr> <tr><td>1,845 G</td><td>3,000 G</td><td>1,000 M</td><td>2,997830 G</td><td>-40.08</td><td>-27.08</td></tr> <tr><td>3,000 G</td><td>7,000 G</td><td>1,000 M</td><td>3,032000 G</td><td>-37.44</td><td>-24.44</td></tr> <tr><td>7,000 G</td><td>13,600 G</td><td>1,000 M</td><td>10,230700 G</td><td>-34.80</td><td>-21.80</td></tr> <tr><td>13,600 G</td><td>19,100 G</td><td>1,000 M</td><td>15,353813 G</td><td>-26.23</td><td>-13.23</td></tr> </tbody> </table> <p>Date: 3.SEP.2017 16:31:24</p>	Start [Hz]	Stop [Hz]	RBW [Hz]	Freq [Hz]	PwrAve [dBm]	ΔLimit [dB]	30,000 M	1,000 G	1,000 M	141,792500 M	-38.93	-25.93	1,000 G	1,845 G	1,000 M	1,0281808 G	-40.89	-27.89	1,845 G	3,000 G	1,000 M	2,997830 G	-40.08	-27.08	3,000 G	7,000 G	1,000 M	3,032000 G	-37.44	-24.44	7,000 G	13,600 G	1,000 M	10,230700 G	-34.80	-21.80	13,600 G	19,100 G	1,000 M	15,353813 G	-26.23	-13.23
Start [Hz]	Stop [Hz]	RBW [Hz]	Freq [Hz]	PwrAve [dBm]	ΔLimit [dB]																																																																																
30,000 M	1,000 G	1,000 M	141,792500 M	-27.82	-14.82																																																																																
1,000 G	1,845 G	1,000 M	1,0069864 G	-41.00	-28.00																																																																																
1,845 G	3,000 G	1,000 M	2,986745 G	-40.13	-27.13																																																																																
3,000 G	7,000 G	1,000 M	3,013000 G	-37.51	-24.51																																																																																
7,000 G	13,600 G	1,000 M	10,222450 G	-34.69	-21.69																																																																																
13,600 G	19,100 G	1,000 M	15,294688 G	-26.11	-13.11																																																																																
Start [Hz]	Stop [Hz]	RBW [Hz]	Freq [Hz]	PwrAve [dBm]	ΔLimit [dB]																																																																																
30,000 M	1,000 G	1,000 M	141,792500 M	-38.93	-25.93																																																																																
1,000 G	1,845 G	1,000 M	1,0281808 G	-40.89	-27.89																																																																																
1,845 G	3,000 G	1,000 M	2,997830 G	-40.08	-27.08																																																																																
3,000 G	7,000 G	1,000 M	3,032000 G	-37.44	-24.44																																																																																
7,000 G	13,600 G	1,000 M	10,230700 G	-34.80	-21.80																																																																																
13,600 G	19,100 G	1,000 M	15,353813 G	-26.23	-13.23																																																																																
Highest Channel	Highest Channel																																																																																				
 <table border="1" data-bbox="239 1608 638 1702"> <thead> <tr> <th>Start [Hz]</th> <th>Stop [Hz]</th> <th>RBW [Hz]</th> <th>Freq [Hz]</th> <th>PwrAve [dBm]</th> <th>ΔLimit [dB]</th> </tr> </thead> <tbody> <tr><td>30,000 M</td><td>1,000 G</td><td>1,000 M</td><td>171,620000 M</td><td>-25.96</td><td>-12.96</td></tr> <tr><td>1,000 G</td><td>1,845 G</td><td>1,000 M</td><td>1,250880 G</td><td>-41.85</td><td>-28.85</td></tr> <tr><td>1,845 G</td><td>3,000 G</td><td>1,000 M</td><td>2,972519 G</td><td>-39.82</td><td>-26.82</td></tr> <tr><td>3,000 G</td><td>7,000 G</td><td>1,000 M</td><td>3,040000 G</td><td>-37.81</td><td>-24.81</td></tr> <tr><td>7,000 G</td><td>13,600 G</td><td>1,000 M</td><td>10,576375 G</td><td>-35.13</td><td>-22.13</td></tr> <tr><td>13,600 G</td><td>19,100 G</td><td>1,000 M</td><td>15,304313 G</td><td>-25.60</td><td>-12.60</td></tr> </tbody> </table> <p>Date: 3.SEP.2017 16:14:11</p>	Start [Hz]	Stop [Hz]	RBW [Hz]	Freq [Hz]	PwrAve [dBm]	ΔLimit [dB]	30,000 M	1,000 G	1,000 M	171,620000 M	-25.96	-12.96	1,000 G	1,845 G	1,000 M	1,250880 G	-41.85	-28.85	1,845 G	3,000 G	1,000 M	2,972519 G	-39.82	-26.82	3,000 G	7,000 G	1,000 M	3,040000 G	-37.81	-24.81	7,000 G	13,600 G	1,000 M	10,576375 G	-35.13	-22.13	13,600 G	19,100 G	1,000 M	15,304313 G	-25.60	-12.60	 <table border="1" data-bbox="893 1608 1292 1702"> <thead> <tr> <th>Start [Hz]</th> <th>Stop [Hz]</th> <th>RBW [Hz]</th> <th>Freq [Hz]</th> <th>PwrAve [dBm]</th> <th>ΔLimit [dB]</th> </tr> </thead> <tbody> <tr><td>30,000 M</td><td>1,000 G</td><td>1,000 M</td><td>171,620000 M</td><td>-37.35</td><td>-24.35</td></tr> <tr><td>1,000 G</td><td>1,845 G</td><td>1,000 M</td><td>1,044785 G</td><td>-41.30</td><td>-28.30</td></tr> <tr><td>1,845 G</td><td>3,000 G</td><td>1,000 M</td><td>1,93271 G</td><td>-35.40</td><td>-22.40</td></tr> <tr><td>3,000 G</td><td>7,000 G</td><td>1,000 M</td><td>3,030000 G</td><td>-37.72</td><td>-24.72</td></tr> <tr><td>7,000 G</td><td>13,600 G</td><td>1,000 M</td><td>10,233175 G</td><td>-35.25</td><td>-22.25</td></tr> <tr><td>13,600 G</td><td>19,100 G</td><td>1,000 M</td><td>15,221325 G</td><td>-26.01</td><td>-13.01</td></tr> </tbody> </table> <p>Date: 3.SEP.2017 16:32:30</p>	Start [Hz]	Stop [Hz]	RBW [Hz]	Freq [Hz]	PwrAve [dBm]	ΔLimit [dB]	30,000 M	1,000 G	1,000 M	171,620000 M	-37.35	-24.35	1,000 G	1,845 G	1,000 M	1,044785 G	-41.30	-28.30	1,845 G	3,000 G	1,000 M	1,93271 G	-35.40	-22.40	3,000 G	7,000 G	1,000 M	3,030000 G	-37.72	-24.72	7,000 G	13,600 G	1,000 M	10,233175 G	-35.25	-22.25	13,600 G	19,100 G	1,000 M	15,221325 G	-26.01	-13.01
Start [Hz]	Stop [Hz]	RBW [Hz]	Freq [Hz]	PwrAve [dBm]	ΔLimit [dB]																																																																																
30,000 M	1,000 G	1,000 M	171,620000 M	-25.96	-12.96																																																																																
1,000 G	1,845 G	1,000 M	1,250880 G	-41.85	-28.85																																																																																
1,845 G	3,000 G	1,000 M	2,972519 G	-39.82	-26.82																																																																																
3,000 G	7,000 G	1,000 M	3,040000 G	-37.81	-24.81																																																																																
7,000 G	13,600 G	1,000 M	10,576375 G	-35.13	-22.13																																																																																
13,600 G	19,100 G	1,000 M	15,304313 G	-25.60	-12.60																																																																																
Start [Hz]	Stop [Hz]	RBW [Hz]	Freq [Hz]	PwrAve [dBm]	ΔLimit [dB]																																																																																
30,000 M	1,000 G	1,000 M	171,620000 M	-37.35	-24.35																																																																																
1,000 G	1,845 G	1,000 M	1,044785 G	-41.30	-28.30																																																																																
1,845 G	3,000 G	1,000 M	1,93271 G	-35.40	-22.40																																																																																
3,000 G	7,000 G	1,000 M	3,030000 G	-37.72	-24.72																																																																																
7,000 G	13,600 G	1,000 M	10,233175 G	-35.25	-22.25																																																																																
13,600 G	19,100 G	1,000 M	15,221325 G	-26.01	-13.01																																																																																



Frequency Stability

Test Conditions	Middle Channel	GSM850 (GPRS class 8)	GSM850 (EDGE class 8)	Limit 2.5ppm
Temperature (°C)	Voltage (Volt)	Deviation (ppm)		Result
50	Normal Voltage	0.0084	0.0048	PASS
40	Normal Voltage	0.0048	0.0036	
30	Normal Voltage	0.0096	0.0060	
20(Ref.)	Normal Voltage	0.0000	0.0000	
10	Normal Voltage	0.0060	0.0084	
0	Normal Voltage	0.0012	0.0048	
-10	Normal Voltage	0.0024	0.0096	
-20	Normal Voltage	0.0108	0.0681	
-30	Normal Voltage	0.0072	0.0036	
20	Maximum Voltage	0.0060	0.0048	
20	Normal Voltage	0.0000	0.0000	
20	Battery End Point	0.0108	0.0000	

Test Conditions	Middle Channel	GSM1900 (GPRS class 8)	GSM1900 (EDGE class 8)	Limit Note 2.
Temperature (°C)	Voltage (Volt)	Deviation (ppm)		Result
50	Normal Voltage	0.0005	0.0037	PASS
40	Normal Voltage	0.0000	0.0181	
30	Normal Voltage	0.0021	0.0170	
20(Ref.)	Normal Voltage	0.0000	0.0000	
10	Normal Voltage	0.0027	0.0165	
0	Normal Voltage	0.0005	0.0186	
-10	Normal Voltage	0.0005	0.0176	
-20	Normal Voltage	0.0011	0.0170	
-30	Normal Voltage	0.0011	0.0181	
20	Maximum Voltage	0.0027	0.0186	
20	Normal Voltage	0.0000	0.0000	
20	Battery End Point	0.0016	0.0032	

Note:

1. Normal Voltage = 3.85V. ; Battery End Point (BEP) = 3.4 V. ; Maximum Voltage =4.4 V
2. The frequency fundamental emissions stay within the authorized frequency block.



A2. WCDMA

Peak-to-Average Ratio

Mode	WCDMA Band V	WCDMA Band II	Limit: 13dB
Mod.	RMC 12.2Kbps	RMC 12.2Kbps	Result
Lowest CH	2.64	2.64	PASS
Middle CH	2.76	3.20	
Highest CH	2.36	3.04	

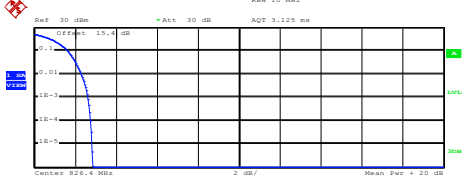
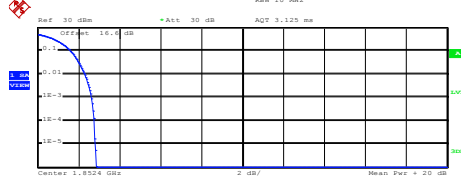
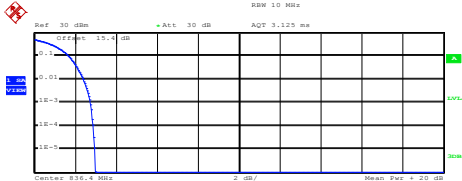
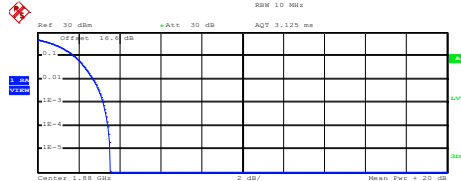
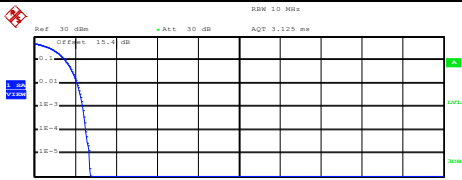
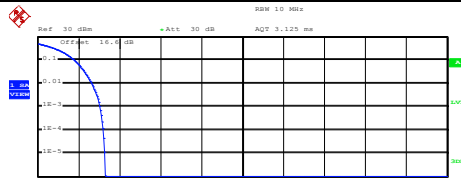

WCDMA Band V (RMC 12.2Kbps)	WCDMA Band II (RMC 12.2Kbps)																
<p style="text-align: center;">Lowest Channel</p>  <p>Center 826.4 MHz 2 dB/ Mean Pwr + 20 dB</p> <p>Complementary Cumulative Distribution Function (100000 samples) Trace 1 Mean 22.40 dBm Peak 25.24 dBm Crest 2.84 dB</p> <table border="1"> <tr><td>10 %</td><td>1.64 dB</td></tr> <tr><td>1 %</td><td>2.28 dB</td></tr> <tr><td>.1 %</td><td>2.64 dB</td></tr> <tr><td>.01 %</td><td>2.76 dB</td></tr> </table> <p>Date: 3.SEP.2017 17:48:44</p>	10 %	1.64 dB	1 %	2.28 dB	.1 %	2.64 dB	.01 %	2.76 dB	<p style="text-align: center;">Lowest Channel</p>  <p>Center 1.8524 GHz 2 dB/ Mean Pwr + 20 dB</p> <p>Complementary Cumulative Distribution Function (100000 samples) Trace 1 Mean 23.16 dBm Peak 26.02 dBm Crest 2.86 dB</p> <table border="1"> <tr><td>10 %</td><td>1.60 dB</td></tr> <tr><td>1 %</td><td>2.32 dB</td></tr> <tr><td>.1 %</td><td>2.64 dB</td></tr> <tr><td>.01 %</td><td>2.76 dB</td></tr> </table> <p>Date: 3.SEP.2017 17:10:31</p>	10 %	1.60 dB	1 %	2.32 dB	.1 %	2.64 dB	.01 %	2.76 dB
10 %	1.64 dB																
1 %	2.28 dB																
.1 %	2.64 dB																
.01 %	2.76 dB																
10 %	1.60 dB																
1 %	2.32 dB																
.1 %	2.64 dB																
.01 %	2.76 dB																
<p style="text-align: center;">Middle Channel</p>  <p>Center 830.4 MHz 2 dB/ Mean Pwr + 20 dB</p> <p>Complementary Cumulative Distribution Function (100000 samples) Trace 1 Mean 22.48 dBm Peak 25.46 dBm Crest 2.98 dB</p> <table border="1"> <tr><td>10 %</td><td>1.68 dB</td></tr> <tr><td>1 %</td><td>2.40 dB</td></tr> <tr><td>.1 %</td><td>2.76 dB</td></tr> <tr><td>.01 %</td><td>2.88 dB</td></tr> </table> <p>Date: 3.SEP.2017 17:48:58</p>	10 %	1.68 dB	1 %	2.40 dB	.1 %	2.76 dB	.01 %	2.88 dB	<p style="text-align: center;">Middle Channel</p>  <p>Center 1.88 GHz 2 dB/ Mean Pwr + 20 dB</p> <p>Complementary Cumulative Distribution Function (100000 samples) Trace 1 Mean 21.77 dBm Peak 25.31 dBm Crest 3.55 dB</p> <table border="1"> <tr><td>10 %</td><td>1.80 dB</td></tr> <tr><td>1 %</td><td>2.72 dB</td></tr> <tr><td>.1 %</td><td>3.20 dB</td></tr> <tr><td>.01 %</td><td>3.44 dB</td></tr> </table> <p>Date: 3.SEP.2017 17:10:46</p>	10 %	1.80 dB	1 %	2.72 dB	.1 %	3.20 dB	.01 %	3.44 dB
10 %	1.68 dB																
1 %	2.40 dB																
.1 %	2.76 dB																
.01 %	2.88 dB																
10 %	1.80 dB																
1 %	2.72 dB																
.1 %	3.20 dB																
.01 %	3.44 dB																
<p style="text-align: center;">Highest Channel</p>  <p>Center 846.6 MHz 2 dB/ Mean Pwr + 20 dB</p> <p>Complementary Cumulative Distribution Function (100000 samples) Trace 1 Mean 22.03 dBm Peak 24.75 dBm Crest 2.72 dB</p> <table border="1"> <tr><td>10 %</td><td>1.52 dB</td></tr> <tr><td>1 %</td><td>2.08 dB</td></tr> <tr><td>.1 %</td><td>2.36 dB</td></tr> <tr><td>.01 %</td><td>2.52 dB</td></tr> </table> <p>Date: 3.SEP.2017 17:49:13</p>	10 %	1.52 dB	1 %	2.08 dB	.1 %	2.36 dB	.01 %	2.52 dB	<p style="text-align: center;">Highest Channel</p>  <p>Center 1.9076 GHz 2 dB/ Mean Pwr + 20 dB</p> <p>Complementary Cumulative Distribution Function (100000 samples) Trace 1 Mean 22.87 dBm Peak 26.16 dBm Crest 3.29 dB</p> <table border="1"> <tr><td>10 %</td><td>1.80 dB</td></tr> <tr><td>1 %</td><td>2.64 dB</td></tr> <tr><td>.1 %</td><td>3.04 dB</td></tr> <tr><td>.01 %</td><td>3.20 dB</td></tr> </table> <p>Date: 3.SEP.2017 17:11:46</p>	10 %	1.80 dB	1 %	2.64 dB	.1 %	3.04 dB	.01 %	3.20 dB
10 %	1.52 dB																
1 %	2.08 dB																
.1 %	2.36 dB																
.01 %	2.52 dB																
10 %	1.80 dB																
1 %	2.64 dB																
.1 %	3.04 dB																
.01 %	3.20 dB																



26dB Bandwidth

Mode	WCDMA Band V	WCDMA Band II
Mod.	RMC 12.2Kbps	RMC 12.2Kbps
Lowest CH	4.73	4.71
Middle CH	4.74	4.69
Highest CH	4.75	4.71



WCDMA Band V (RMC 12.2Kbps)

WCDMA Band II (RMC 12.2Kbps)

Lowest Channel

Lowest Channel

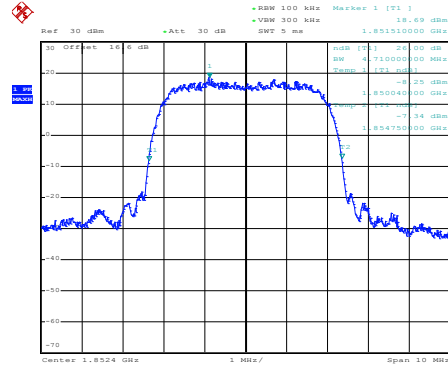
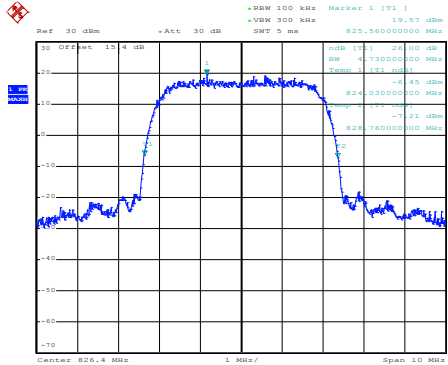

Date: 3.SEP.2017 17:18:10

Date: 3.SEP.2017 16:56:38

Middle Channel

Middle Channel

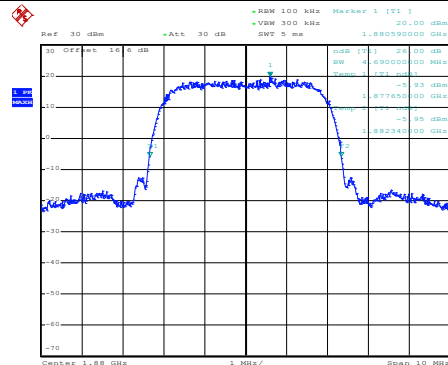
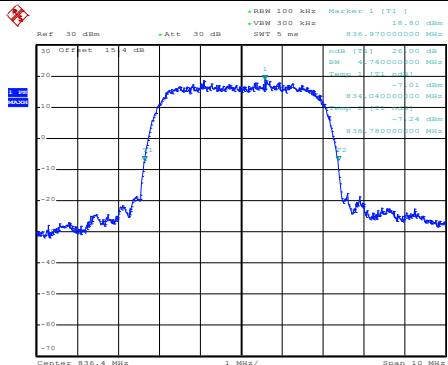

Date: 3.SEP.2017 17:18:50

Date: 3.SEP.2017 16:57:12

Highest Channel

Highest Channel

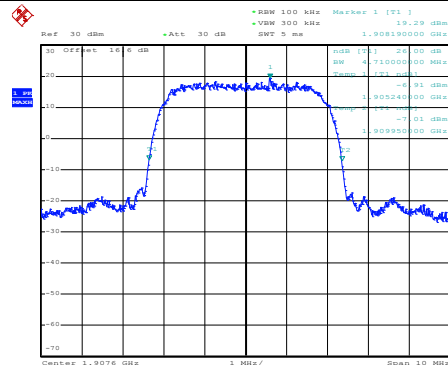
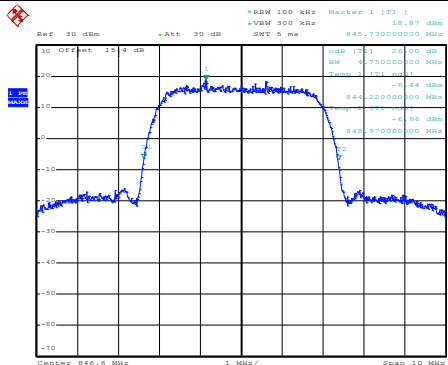

Date: 3.SEP.2017 17:19:23

Date: 3.SEP.2017 16:57:49



Occupied Bandwidth

Mode	WCDMA Band V	WCDMA Band II
Mod.	RMC 12.2Kbps	RMC 12.2Kbps
Lowest CH	4.14	4.13
Middle CH	4.16	4.14
Highest CH	4.15	4.12

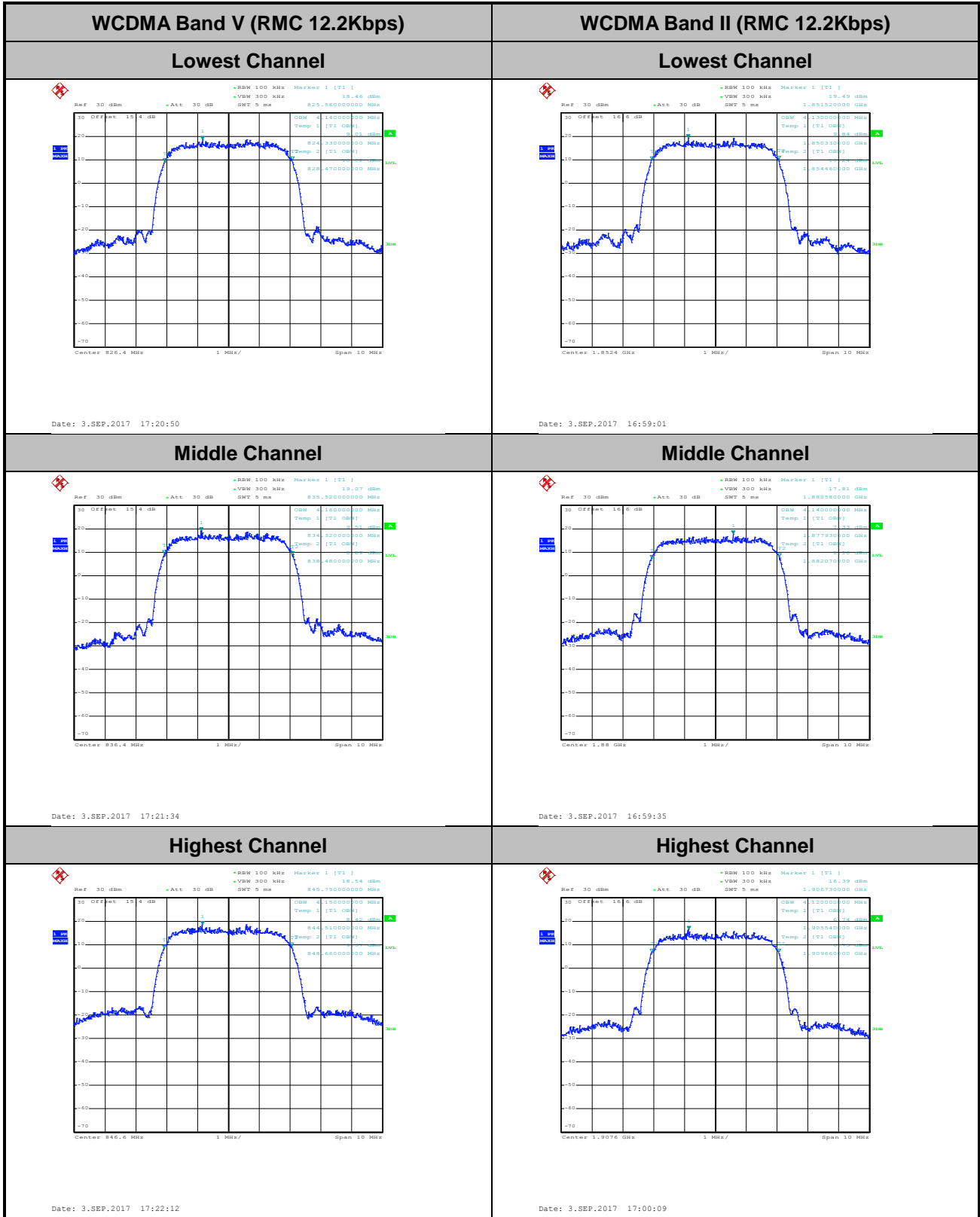



Conducted Band Edge

WCDMA Band V (RMC 12.2Kbps)

Lowest Band Edge

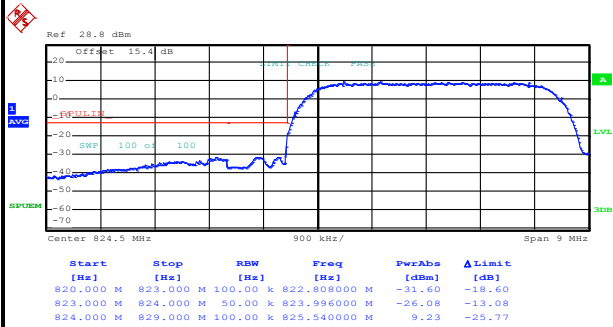

Date: 3.SEP.2017 17:25:15

Highest Band Edge

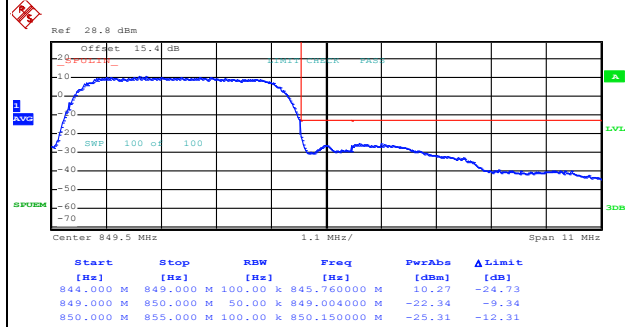

Date: 3.SEP.2017 17:28:06



WCDMA Band II (RMC 12.2Kbps)

Lowest Band Edge

Highest Band Edge

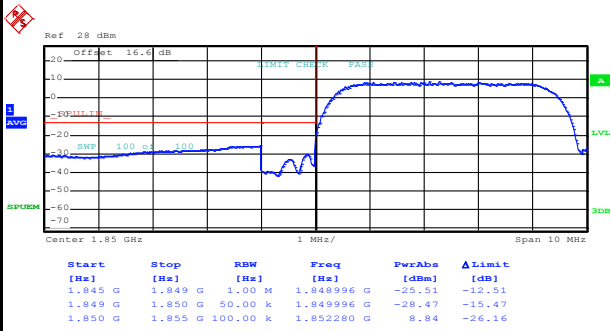

Date: 3.SEP.2017 17:03:05

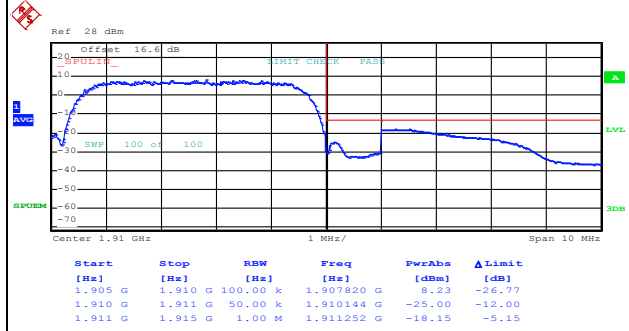

Date: 3.SEP.2017 17:06:11



Conducted Spurious Emission



WCDMA Band V (RMC 12.2Kbps)

WCDMA Band II (RMC 12.2Kbps)

Lowest Channel

Lowest Channel

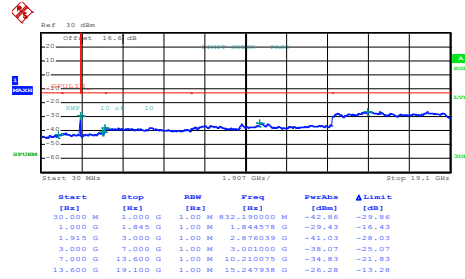
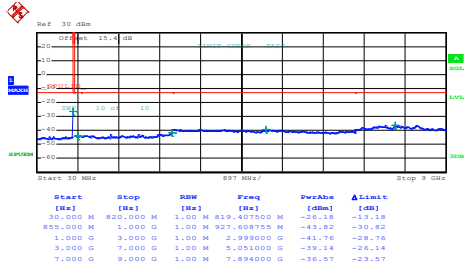

Date: 3.SEP.2017 17:40:51

Date: 3.SEP.2017 17:07:40

Middle Channel

Middle Channel

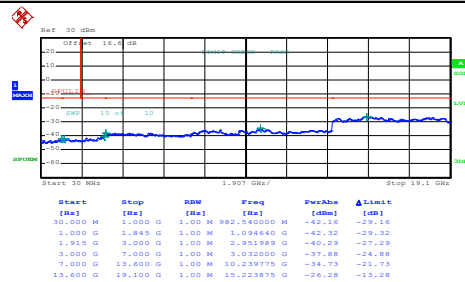
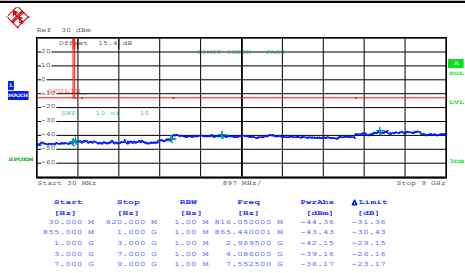

Date: 3.SEP.2017 17:41:48

Date: 3.SEP.2017 17:08:34

Highest Channel

Highest Channel

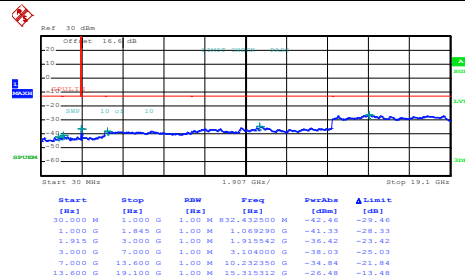
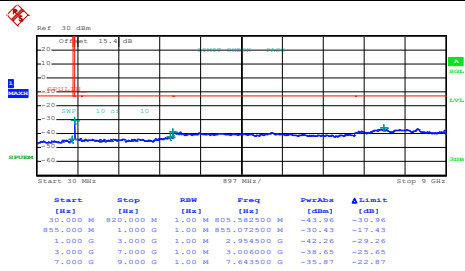

Date: 3.SEP.2017 17:42:29

Date: 3.SEP.2017 17:09:32



Frequency Stability

Test Conditions	Middle Channel	WCDMA Band V (RMC 12.2Kbps)	Limit 2.5ppm
Temperature (°C)	Voltage (Volt)	Deviation (ppm)	Result
50	Normal Voltage	0.0024	PASS
40	Normal Voltage	0.0120	
30	Normal Voltage	0.0012	
20(Ref.)	Normal Voltage	0.0000	
10	Normal Voltage	0.0036	
0	Normal Voltage	0.0096	
-10	Normal Voltage	0.0000	
-20	Normal Voltage	0.0108	
-30	Normal Voltage	0.0012	
20	Maximum Voltage	0.0120	
20	Normal Voltage	0.0012	
20	Battery End Point	0.0024	

Test Conditions	Middle Channel	WCDMA Band II (RMC 12.2Kbps)	Limit Note 2.
Temperature (°C)	Voltage (Volt)	Deviation (ppm)	Result
50	Normal Voltage	0.0016	PASS
40	Normal Voltage	0.0021	
30	Normal Voltage	0.0005	
20(Ref.)	Normal Voltage	0.0000	
10	Normal Voltage	0.0005	
0	Normal Voltage	0.0011	
-10	Normal Voltage	0.0005	
-20	Normal Voltage	0.0016	
-30	Normal Voltage	0.0011	
20	Maximum Voltage	0.0011	
20	Normal Voltage	0.0000	
20	Battery End Point	0.0005	

Note:

1. Normal Voltage = 3.85V. ; Battery End Point (BEP) = 3.4 V. ; Maximum Voltage =4.4 V
2. The frequency fundamental emissions stay within the authorized frequency block.



Appendix B. Test Results of ERP/EIRP and Radiated Test

ERP/EIRP

Channel	Mode	Conducted		ERP	
		Power (dBm)	Power (Watts)	ERP(dBm)	ERP(W)
Lowest	GSM850	33.64	2.3121	30.69	1.1722
Middle	GPRS class 8	33.77	2.3823	30.82	1.2078
Highest	(GT - LC = -0.8 dB)	34.00	2.5119	31.05	1.2735
Lowest	GSM850	27.18	0.5224	24.23	0.2649
Middle	EDGE class 8	27.26	0.5321	24.31	0.2698
Highest	(GT - LC = -0.8 dB)	27.42	0.5521	24.47	0.2799
Lowest	WCDMA Band V	24.84	0.3048	21.89	0.1545
Middle	RMC 12.2Kbps	24.87	0.3069	21.92	0.1556
Highest	(GT - LC = -0.8 dB)	24.88	0.3076	21.93	0.1560
Limit	ERP < 7W	Result		PASS	

Channel	Mode	Conducted		EIRP	
		Power (dBm)	Power (Watts)	EIRP(dBm)	EIRP(W)
Lowest	GSM1900	30.79	1.1995	30.89	1.2274
Middle	GPRS class 8	30.62	1.1535	30.72	1.1803
Highest	(GT - LC = 0.1 dB)	31.00	1.2589	31.10	1.2882
Lowest	GSM1900	25.80	0.3802	25.90	0.3890
Middle	EDGE class 8	25.64	0.3664	25.74	0.3750
Highest	(GT - LC = 0.1 dB)	26.00	0.3981	26.10	0.4074
Lowest	WCDMA Band II	23.94	0.2477	24.04	0.2535
Middle	RMC 12.2Kbps	23.75	0.2371	23.85	0.2427
Highest	(GT - LC = 0.1 dB)	23.85	0.2427	23.95	0.2483
Limit	EIRP < 2W	Result		PASS	



Radiated Spurious Emission

Part22H GPRS 850

Mode 1_GPRS 850									
Channel	Frequency (MHz)	ERP (dBm)	Limit (dBm)	Over Limit (dB)	SPA Reading (dBm)	S.G. Power (dBm)	TX Cable loss (dB)	TX Antenna Gain (dBi)	Polarization (H/V)
Highest	1696	-46.30	-13	-33.30	-57.2	-52.74	0.41	9.01	H
	2544	-26.35	-13	-13.35	-41.44	-34.48	0.51	10.79	H
	4248	-51.30	-13	-38.30	-70.39	-60.57	0.68	12.10	H
									H
									H
									H
									H
	1696	-48.91	-13	-35.91	-59.85	-55.35	0.41	9.01	V
	2544	-30.32	-13	-17.32	-44.79	-38.45	0.51	10.79	V
	4248	-56.70	-13	-43.70	-76.38	-65.97	0.68	12.10	V
									V
									V
									V
									V

Remark: Spurious emissions within 30-1000MHz were found more than 20dB below limit line.



Part22H EDGE 850

Mode 2_EDGE 850									
Channel	Frequency (MHz)	ERP (dBm)	Limit (dBm)	Over Limit (dB)	SPA Reading (dBm)	S.G. Power (dBm)	TX Cable loss (dB)	TX Antenna Gain (dBi)	Polarization (H/V)
Highest	1696	-56.13	-13	-43.13	-67.03	-62.57	0.41	9.01	H
	2544	-46.88	-13	-33.88	-61.97	-55.01	0.51	10.79	H
	3392	-59.53	-13	-46.53	-75.64	-68.89	0.60	12.11	H
									H
									H
									H
									H
	1696	-57.44	-13	-44.44	-68.38	-63.88	0.41	9.01	V
	2544	-48.31	-13	-35.31	-62.78	-56.44	0.51	10.79	V
	3392	-59.37	-13	-46.37	-75.88	-68.73	0.60	12.11	V
									V
									V
									V
									V

Remark: Spurious emissions within 30-1000MHz were found more than 20dB below limit line.



Part22H WCDMA 850

Mode 3_WCDMA 850									
Channel	Frequency (MHz)	ERP (dBm)	Limit (dBm)	Over Limit (dB)	SPA Reading (dBm)	S.G. Power (dBm)	TX Cable loss (dB)	TX Antenna Gain (dBi)	Polarization (H/V)
Highest	1696	-63.32	-13	-50.32	-74.22	-69.76	0.41	9.01	H
	2544	-57.91	-13	-44.91	-73	-66.04	0.51	10.79	H
	3384	-59.57	-13	-46.57	-75.71	-68.90	0.60	12.08	H
									H
									H
									H
									H
	1696	-63.13	-13	-50.13	-74.07	-69.57	0.41	9.01	V
	2544	-56.73	-13	-43.73	-71.21	-64.86	0.51	10.79	V
	3384	-59.33	-13	-46.33	-75.87	-68.66	0.60	12.08	V
									V
									V
									V
									V

Remark: Spurious emissions within 30-1000MHz were found more than 20dB below limit line.



Part24E GPRS 1900

Mode 1_GPRS 1900									
Channel	Frequency (MHz)	EIRP (dBm)	Limit (dBm)	Over Limit (dB)	SPA Reading (dBm)	S.G. Power (dBm)	TX Cable loss (dB)	TX Antenna Gain (dBi)	Polarization (H/V)
Highest	3819	-55.95	-13	-42.95	-74.95	-67.61	0.65	12.31	H
	5730	-39.11	-13	-26.11	-60.04	-50.62	0.82	12.33	H
	7639	-51.10	-13	-38.10	-75.72	-60.66	0.98	10.54	H
									H
									H
									H
									H
	3819	-55.93	-13	-42.93	-75.78	-67.59	0.65	12.31	V
	5730	-38.42	-13	-25.42	-60.44	-49.93	0.82	12.33	V
	7639	-51.00	-13	-38.00	-75.49	-60.56	0.98	10.54	V
									V
									V
									V
									V

Remark: Spurious emissions within 30-1000MHz were found more than 20dB below limit line.



Part24E EDGE 1900

Mode 2_EDGE 1900									
Channel	Frequency (MHz)	EIRP (dBm)	Limit (dBm)	Over Limit (dB)	SPA Reading (dBm)	S.G. Power (dBm)	TX Cable loss (dB)	TX Antenna Gain (dBi)	Polarization (H/V)
Highest	3819	-56.42	-13	-43.42	-75.42	-68.08	0.65	12.31	H
	5630	-45.06	-13	-32.06	-65.99	-56.46	0.83	12.23	H
	7639	-51.29	-13	-38.29	-75.91	-60.85	0.98	10.54	H
									H
									H
									H
									H
	3819	-54.06	-13	-41.06	-73.91	-65.72	0.65	12.31	V
	5630	-40.19	-13	-27.19	-62.21	-51.59	0.83	12.23	V
	7639	-51.23	-13	-38.23	-75.72	-60.79	0.98	10.54	V
									V
									V
									V
									V

Remark: Spurious emissions within 30-1000MHz were found more than 20dB below limit line.



Part24E WCDMA 1900

Mode 3_WCDMA 1900									
Channel	Frequency (MHz)	EIRP (dBm)	Limit (dBm)	Over Limit (dB)	SPA Reading (dBm)	S.G. Power (dBm)	TX Cable loss (dB)	TX Antenna Gain (dBi)	Polarization (H/V)
Lowest	3704	-57.04	-13	-44.04	-75.95	-68.79	0.63	12.38	H
	5555	-45.56	-13	-32.56	-66.56	-56.90	0.81	12.16	H
	7409	-51.67	-13	-38.67	-75.85	-60.78	0.99	10.10	H
									H
									H
									H
									H
	3704	-56.64	-13	-43.64	-76.25	-68.39	0.63	12.38	V
	5555	-49.26	-13	-36.26	-70.93	-60.60	0.81	12.16	V
	7409	-51.85	-13	-38.85	-76.03	-60.96	0.99	10.10	V
									V
									V
									V
									V

Remark: Spurious emissions within 30-1000MHz were found more than 20dB below limit line.