



# FCC RF Test Report

**APPLICANT** : Sony Mobile Communications Inc.  
**EQUIPMENT** : GSM/WCDMA/LTE Phone+Bluetooth, DTS/UNII  
a/b/g/n/ac and NFC  
**BRAND NAME** : Sony  
**FCC ID** : PY7-08608T  
**STANDARD** : FCC Part 15 Subpart E §15.407  
**CLASSIFICATION** : (NII) Unlicensed National Information Infrastructure

The product was received on Jun. 07, 2017 and testing was completed on Oct. 03, 2017. We, SPORTON INTERNATIONAL INC., would like to declare that the tested sample has been evaluated in accordance with the test procedures and has been in compliance with the applicable technical standards.

The test results in this report apply exclusively to the tested model / sample. Without written approval of SPORTON INTERNATIONAL INC., the test report shall not be reproduced except in full.

Reviewed by: Joseph Lin / Supervisor

Approved by: Jones Tsai / Manager



## SPORTON INTERNATIONAL INC.

No. 52, Hwa Ya 1<sup>st</sup> Rd., Hwa Ya Technology Park, Kwei-Shan District, Tao Yuan City, Taiwan, R.O.C.

SPORTON INTERNATIONAL INC.

TEL : 886-3-327-3456

FAX : 886-3-328-4978

FCC ID : PY7-08608T

Page Number : 1 of 31

Report Issued Date : Oct. 26, 2017

Report Version : Rev. 02

Report Template No.: BU5-FR15EWLB4 AC MA Version 2.0



# TABLE OF CONTENTS

**REVISION HISTORY..... 3**

**SUMMARY OF TEST RESULT ..... 4**

**1 GENERAL DESCRIPTION ..... 5**

    1.1 Applicant ..... 5

    1.2 Manufacturer ..... 5

    1.3 Product Feature of Equipment Under Test ..... 5

    1.4 Modification of EUT ..... 6

    1.5 Testing Location ..... 7

    1.6 Applicable Standards ..... 7

**2 TEST CONFIGURATION OF EQUIPMENT UNDER TEST ..... 8**

    2.1 Carrier Frequency Channel ..... 8

    2.2 Test Mode ..... 9

    2.3 Connection Diagram of Test System ..... 10

    2.4 Support Unit used in test configuration and system ..... 11

    2.5 EUT Operation Test Setup ..... 11

    2.6 Measurement Results Explanation Example ..... 11

**3 TEST RESULT ..... 12**

    3.1 6dB, 26dB and 99% Occupied Bandwidth Measurement ..... 12

    3.2 Maximum Conducted Output Power Measurement ..... 15

    3.3 Power Spectral Density Measurement ..... 16

    3.4 Unwanted Radiated Emission Measurement ..... 18

    3.5 AC Conducted Emission Measurement ..... 24

    3.6 Frequency Stability Measurement ..... 26

    3.7 Automatically Discontinue Transmission ..... 27

    3.8 Antenna Requirements ..... 28

**4 LIST OF MEASURING EQUIPMENTS ..... 29**

**5 UNCERTAINTY OF EVALUATION ..... 31**

**APPENDIX A. CONDUCTED TEST RESULTS**

**APPENDIX B. AC CONDUCTED EMISSION TEST RESULT**

**APPENDIX C. RADIATED SPURIOUS EMISSION**

**APPENDIX D. RADIATED SPURIOUS EMISSION PLOTS**

**APPENDIX E. DUTY CYCLE PLOTS**





### SUMMARY OF TEST RESULT

| Report Section | FCC Rule           | Description                            | Limit                       | Result | Remark                            |
|----------------|--------------------|----------------------------------------|-----------------------------|--------|-----------------------------------|
| 3.1            | 15.403(i)          | 6dB, 26dB and 99% Occupied Bandwidth   | > 500kHz                    | Pass   | -                                 |
| 3.2            | 15.407(a)          | Maximum Conducted Output Power         | ≤ 30 dBm                    | Pass   | -                                 |
| 3.3            | 15.407(a)          | Power Spectral Density                 | ≤ 30 dBm/500kHz             | Pass   | -                                 |
| 3.4            | 15.407(b)          | Unwanted Emissions                     | 15.407(b)(4)(i) & 15.209(a) | Pass   | Under limit 5.28 dB at 36.750 MHz |
| 3.5            | 15.207             | AC Conducted Emission                  | 15.207(a)                   | Pass   | Under limit 15.30 dB at 0.150 MHz |
| 3.6            | 15.407(g)          | Frequency Stability                    | Within Operation Band       | Pass   | -                                 |
| 3.7            | 15.407(c)          | Automatically Discontinue Transmission | Discontinue Transmission    | Pass   | -                                 |
| 3.8            | 15.203 & 15.407(a) | Antenna Requirement                    | N/A                         | Pass   | -                                 |



# 1 General Description

## 1.1 Applicant

**Sony Mobile Communications Inc.**

4-12-3 Higashi-Shinagawa, Shinagawa-ku, Tokyo, 140-0002, Japan

## 1.2 Manufacturer

**Sony Mobile Communications Inc.**

4-12-3 Higashi-Shinagawa, Shinagawa-ku, Tokyo, 140-0002, Japan

## 1.3 Product Feature of Equipment Under Test

GSM/WCDMA/LTE, Bluetooth, DTS/UNII a/b/g/n/ac, FM Receiver, NFC, and GPS.

| Standards-related Product Specification |                                  |
|-----------------------------------------|----------------------------------|
| Antenna Type / Gain                     | PIFA Antenna with gain -4.50 dBi |

| EUT Information List |            |            |                            |
|----------------------|------------|------------|----------------------------|
| HW Version           | SW Version | S/N        | Performed Test Item        |
| A                    | 1.14       | RQ3005UYBC | RF conducted measurement   |
|                      |            | CQ300000EW | Radiated Spurious Emission |
|                      |            | CQ300000EL | AC Conducted Emission      |



| Accessory List |                                                                                 |
|----------------|---------------------------------------------------------------------------------|
| AC Adapter 1   | Model Name: UCH12                                                               |
|                | S/N:                                                                            |
|                | VB17W34100174 (for radiated emission)<br>VB17W34100230 (for conducted emission) |
| Earphone 1     | Model Name: MH410c                                                              |
|                | S/N: N/A                                                                        |
| USB Cable      | Model Name: UCB20                                                               |
|                | S/N: N/A                                                                        |

**Note:**

1. Above EUT list and accessory list used are electrically identical per declared by manufacturer.
2. Above the accessories list are used to exercise the EUT during test.
3. For other wireless features of this EUT, test report will be issued separately.

### 1.4 Modification of EUT

No modifications are made to the EUT during all test items.



### 1.5 Testing Location

Sporton Lab is accredited to ISO 17025 by Taiwan Accreditation Foundation (TAF code : 1190) and the FCC designation No. TW1190 and TW0007 under the FCC 2.948(e) by Mutual Recognition Agreement (MRA) in FCC Test.

|                           |                                                                                                                                                                  |         |
|---------------------------|------------------------------------------------------------------------------------------------------------------------------------------------------------------|---------|
| <b>Test Site</b>          | SPORTON INTERNATIONAL INC.                                                                                                                                       |         |
| <b>Test Site Location</b> | No. 52, Hwa Ya 1 <sup>st</sup> Rd., Hwa Ya Technology Park,<br>Kwei-Shan District, Tao Yuan City, Taiwan, R.O.C.<br>TEL: +886-3-327-3456<br>FAX: +886-3-328-4978 |         |
| <b>Test Site No.</b>      | <b>Sporton Site No.</b>                                                                                                                                          |         |
|                           | TH05-HY                                                                                                                                                          | CO05-HY |

**Note:** The test site complies with ANSI C63.4 2014 requirement.

|                           |                                                                                                                                        |  |
|---------------------------|----------------------------------------------------------------------------------------------------------------------------------------|--|
| <b>Test Site</b>          | SPORTON INTERNATIONAL INC.                                                                                                             |  |
| <b>Test Site Location</b> | No.58, Aly. 75, Ln. 564, Wenhua 3rd Rd. Guishan Dist,<br>Taoyuan City, Taiwan (R.O.C.)<br>TEL: +886-3-327-0868<br>FAX: +886-3-327-0855 |  |
| <b>Test Site No.</b>      | <b>Sporton Site No.</b>                                                                                                                |  |
|                           | 03CH13-HY                                                                                                                              |  |

**Note:** The test site complies with ANSI C63.4 2014 requirement.

### 1.6 Applicable Standards

According to the specifications of the manufacturer, the EUT must comply with the requirements of the following standards:

- ♦ FCC Part 15 Subpart E
- ♦ FCC KDB 789033 D02 General UNII Test Procedures New Rules v01r04.
- ♦ ANSI C63.10-2013

**Remark:**

1. All test items were verified and recorded according to the standards and without any deviation during the test.
2. This EUT has also been tested and complied with the requirements of FCC Part 15, Subpart B, recorded in a separate test report.



## 2 Test Configuration of Equipment Under Test

- a. The EUT has been associated with peripherals and configuration operated in a manner tended to maximize its emission characteristics in a typical application. Frequency range investigated: conduction emission (150 kHz to 30 MHz), radiation emission (9 kHz to the 10th harmonic of the highest fundamental frequency or to 40 GHz, whichever is lower). For radiated measurement, pre-scanned in three orthogonal panels, X, Y, Z. The worst cases (Z plane) were recorded in this report.
- b. AC power line Conducted Emission was tested under maximum output power.

### 2.1 Carrier Frequency Channel

| Frequency Band                       | Channel | Freq. (MHz) | Channel | Freq. (MHz) |
|--------------------------------------|---------|-------------|---------|-------------|
| 5725-5850 MHz<br>Band 4<br>(U-NII-3) | 149     | 5745        | 157     | 5785        |
|                                      | 151*    | 5755        | 159*    | 5795        |
|                                      | 153     | 5765        | 161     | 5805        |
|                                      | 155#    | 5775        | 165     | 5825        |

**Note:**

- 1. The above Frequency and Channel in "\*" were 802.11n HT40 and 802.11ac VHT40.
- 2. The above Frequency and Channel in "#n" were 802.11ac VHT80.





## 2.2 Test Mode

Final test mode of conducted test items and radiated spurious emissions are considering the modulation and worse data rates as below table.

| Modulation     | Data Rate |
|----------------|-----------|
| 802.11a        | 6 Mbps    |
| 802.11ac VHT20 | MCS0      |
| 802.11ac VHT40 | MCS0      |
| 802.11ac VHT80 | MCS0      |

| Test Cases                                                                         |                                                                                                              |
|------------------------------------------------------------------------------------|--------------------------------------------------------------------------------------------------------------|
| AC Conducted Emission                                                              | Mode 1 : Bluetooth Link + WLAN (5GHz) Link + Earphone 1 + Battery 1 + USB Cable<br>(Charging from Adapter 1) |
| <b>Remark:</b> For Radiated Test Cases, The tests were performance with Battery 1. |                                                                                                              |

| Ch. # |        | Band IV : 5725-5850 MHz |                |                |                |
|-------|--------|-------------------------|----------------|----------------|----------------|
|       |        | 802.11a                 | 802.11ac VHT20 | 802.11ac VHT40 | 802.11ac VHT80 |
| L     | Low    | 149                     | 149            | 151            | -              |
| M     | Middle | 157                     | 157            | -              | 155            |
| H     | High   | 165                     | 165            | 159            | -              |

## 2.3 Connection Diagram of Test System

### <WLAN Tx Mode>

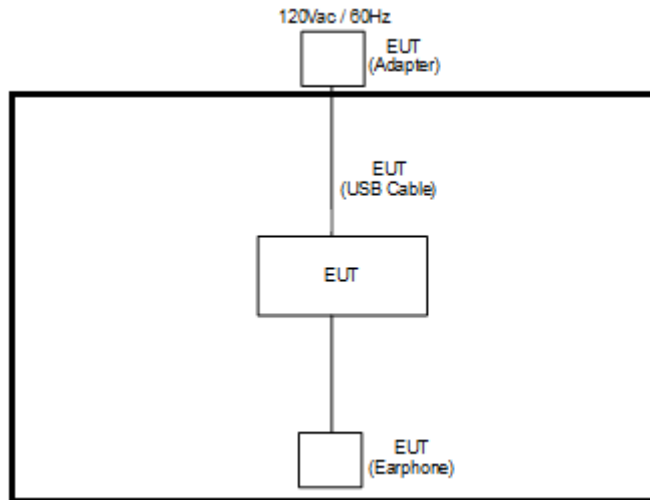

### <AC Conducted Emission Mode>

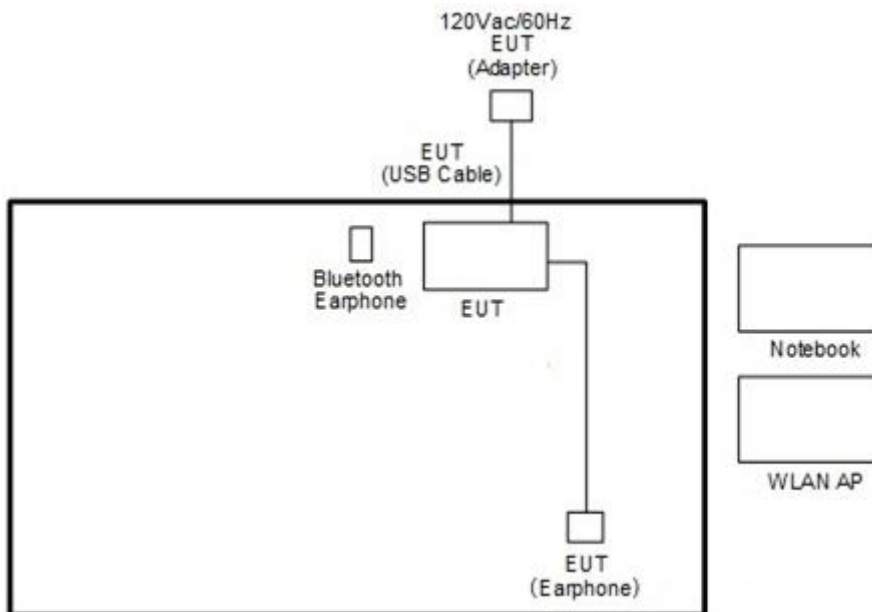



## 2.4 Support Unit used in test configuration and system

| Item | Equipment          | Trade Name | Model Name     | FCC ID                                       | Data Cable | Power Cord                                                 |
|------|--------------------|------------|----------------|----------------------------------------------|------------|------------------------------------------------------------|
| 1.   | Bluetooth Earphone | Sony       | SBH20          | PY7-RD0010                                   | N/A        | N/A                                                        |
| 2.   | WLAN AP            | ASUS       | RT-AC66U       | MSQ-RTAC66U                                  | N/A        | Unshielded, 1.8 m                                          |
| 3.   | Notebook           | DELL       | Latitude E6320 | FCC DoC/<br>Contains FCC ID:<br>QDS-BRCM1054 | N/A        | AC I/P:<br>Unshielded, 1.2 m<br>DC O/P:<br>Shielded, 1.8 m |
| 4.   | SD Card            | SanDisk    | MicroSD HC     | FCC DoC                                      | N/A        | N/A                                                        |

## 2.5 EUT Operation Test Setup

The RF test items, an engineering test program was provided and enabled to make EUT continuous transmit.

## 2.6 Measurement Results Explanation Example

For all conducted test items:

The offset level is set in the spectrum analyzer to compensate the RF cable loss and attenuator factor between EUT conducted output port and spectrum analyzer. With the offset compensation, the spectrum analyzer reading level is exactly the EUT RF output level.

Example :

The spectrum analyzer offset is derived from RF cable loss and attenuator factor.

*Offset = RF cable loss + attenuator factor.*

Following shows an offset computation example with cable loss 4.2 dB and 10dB attenuator.

$$\begin{aligned} \text{Offset(dB)} &= \text{RF cable loss(dB)} + \text{attenuator factor(dB)}. \\ &= 4.2 + 10 = 14.2 \text{ (dB)} \end{aligned}$$

### 3 Test Result

#### 3.1 6dB, 26dB and 99% Occupied Bandwidth Measurement

##### 3.1.1 Description of 6dB, 26dB & 99% Occupied Bandwidth

The minimum 6 dB bandwidth shall be at least 500 kHz.

26dB and 99% Occupied bandwidth are reporting only.

##### 3.1.2 Measuring Instruments

The measuring equipment is listed in the section 4 of this test report.

##### 3.1.3 Test Procedures

1. The testing follows FCC KDB 789033 D02 General UNII Test Procedures New Rules v01r04.  
Section C) Emission bandwidth for the band 5.725-5.85GHz
2. Set RBW = 100kHz.
3. Set the VBW  $\geq 3 \times$  RBW.
4. Detector = Peak.
5. Trace mode = max hold
6. Measure the maximum width of the emission that is 6 dB down from the peak of the emission.
7. Measure and record the results in the test report.

##### 3.1.4 Test Setup

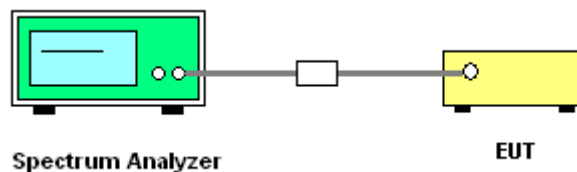



### 3.1.5 Test Result of 6db & 26dB & 99% Occupied Bandwidth Plots

Please refer to Appendix A.

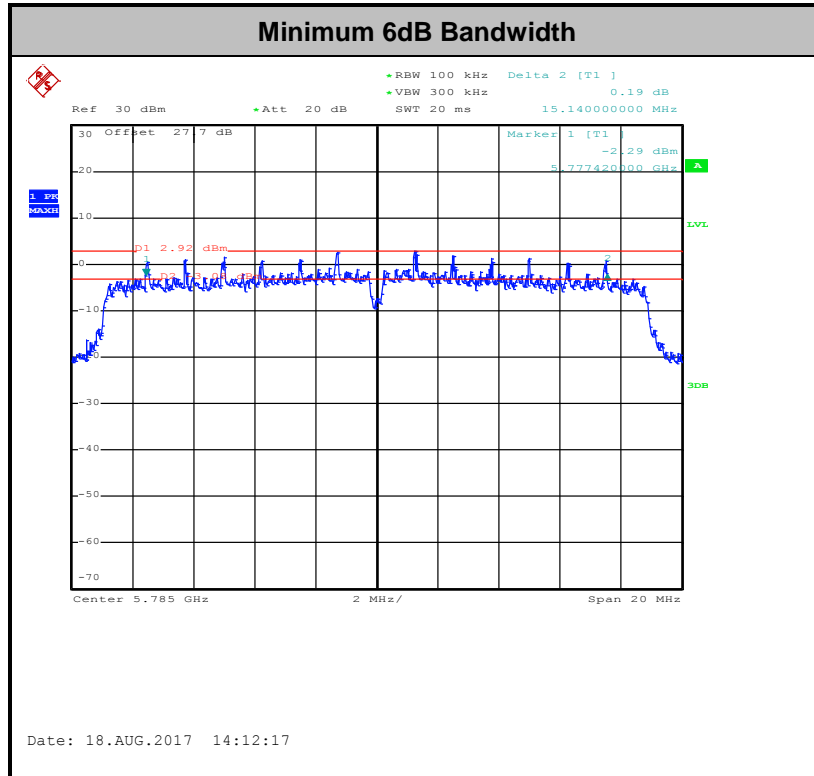

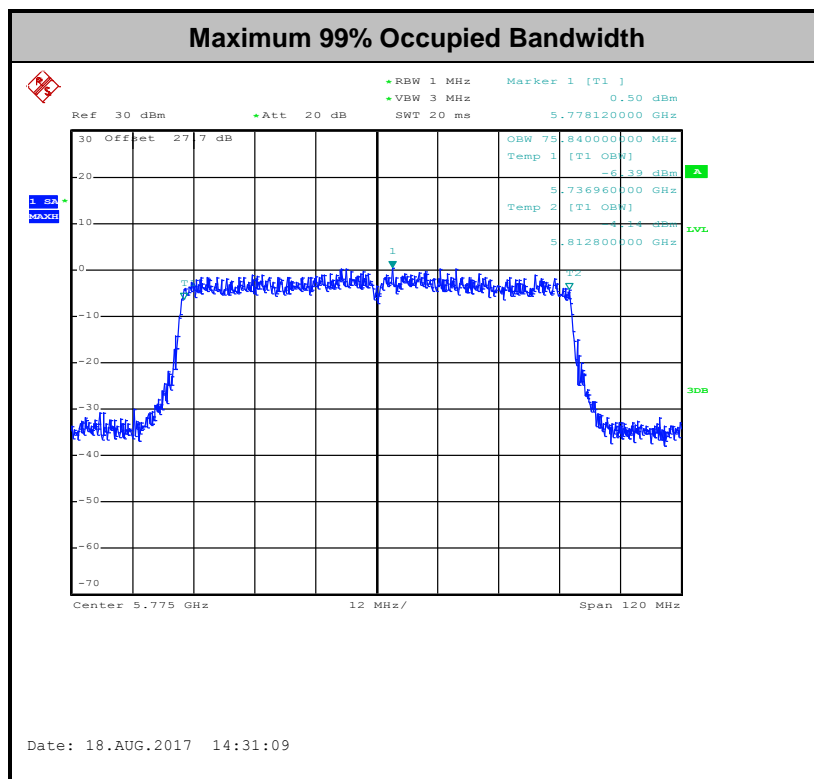
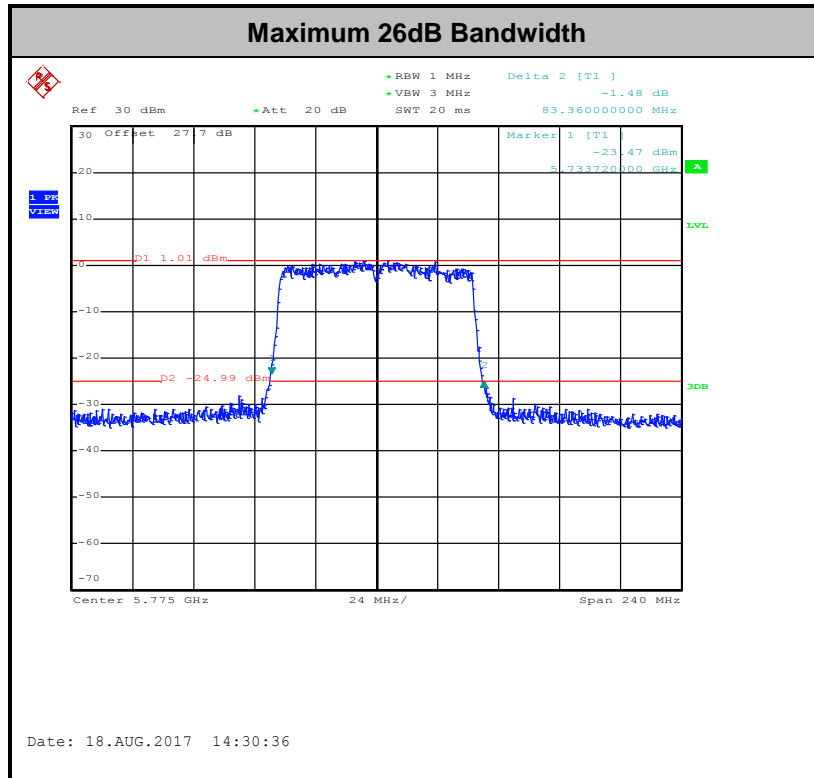

Note : The occupied channel bandwidth is maintained within the band of operation for all of the modulations.

## 3.2 Maximum Conducted Output Power Measurement

### 3.2.1 Limit of Maximum Conducted Output Power

For the band 5.725–5.85 GHz, the maximum conducted output power over the frequency band of operation shall not exceed 1 W.

If transmitting antennas of directional gain greater than 6 dBi are used, the peak output power shall be reduced by the amount in dB that the directional gain of the antenna exceeds 6 dBi.

### 3.2.2 Measuring Instruments

The measuring equipment is listed in the section 4 of this test report.

### 3.2.3 Test Procedures

The testing follows Method PM of FCC KDB 789033 D02 General UNII Test Procedures New Rules v01r04.

Method PM (Measurement using an RF average power meter):

1. Measurement is performed using a wideband RF power meter.
2. The EUT is configured to transmit continuously with a consistent duty cycle at its maximum power control level.
3. Measure the average power of the transmitter, and the average power is corrected with duty factor,  $10 \log(1/x)$ , where  $x$  is the duty cycle.

### 3.2.4 Test Setup

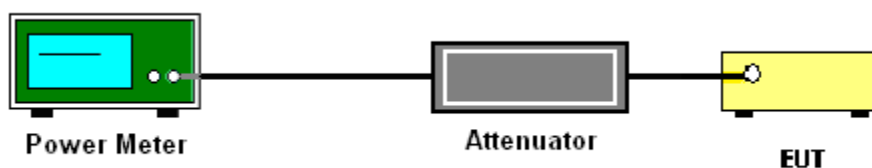

### 3.2.5 Test Result of Maximum Conducted Output Power

Please refer to Appendix A.



### 3.3 Power Spectral Density Measurement

#### 3.3.1 Limit of Power Spectral Density

For the band 5.725–5.85 GHz, the maximum power spectral density shall not exceed 30 dBm in any 500-kHz band.

If transmitting antennas of directional gain greater than 6 dBi are used, the peak output power shall be reduced by the amount in dB that the directional gain of the antenna exceeds 6 dBi.

#### 3.3.2 Measuring Instruments

The measuring equipment is listed in the section 4 of this test report.

#### 3.3.3 Test Procedures

The testing follows FCC KDB 789033 D02 General UNII Test Procedures New Rules v01r04. Section F) Maximum power spectral density.

##### # Method SA-2 #

(trace averaging across on and off times of the EUT transmissions, followed by duty cycle correction).

- Measure the duty cycle.
  - Set span to encompass the entire emission bandwidth (EBW) of the signal.
  - Set RBW = 1 MHz.
  - Set VBW  $\geq$  3 MHz.
  - Number of points in sweep  $\geq$  2 Span / RBW.
  - Sweep time = auto.
  - Detector = RMS
  - Trace average at least 100 traces in power averaging mode.
  - Add  $10 \log(1/x)$ , where  $x$  is the duty cycle, to the measured power in order to compute the average power during the actual transmission times. For example, add  $10 \log(1/0.25) = 6$  dB if the duty cycle is 25 percent.
1. The RF output of EUT was connected to the spectrum analyzer by a low loss cable.
  2. Each plot has already offset with cable loss, and attenuator loss. Measure the PPSD and record it.



### 3.3.4 Test Setup

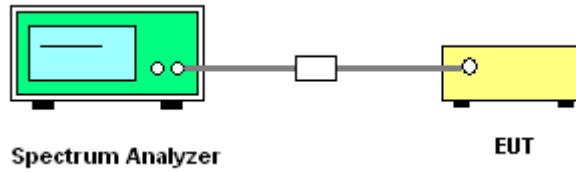

### 3.3.5 Test Result of Power Spectral Density

Please refer to Appendix A.

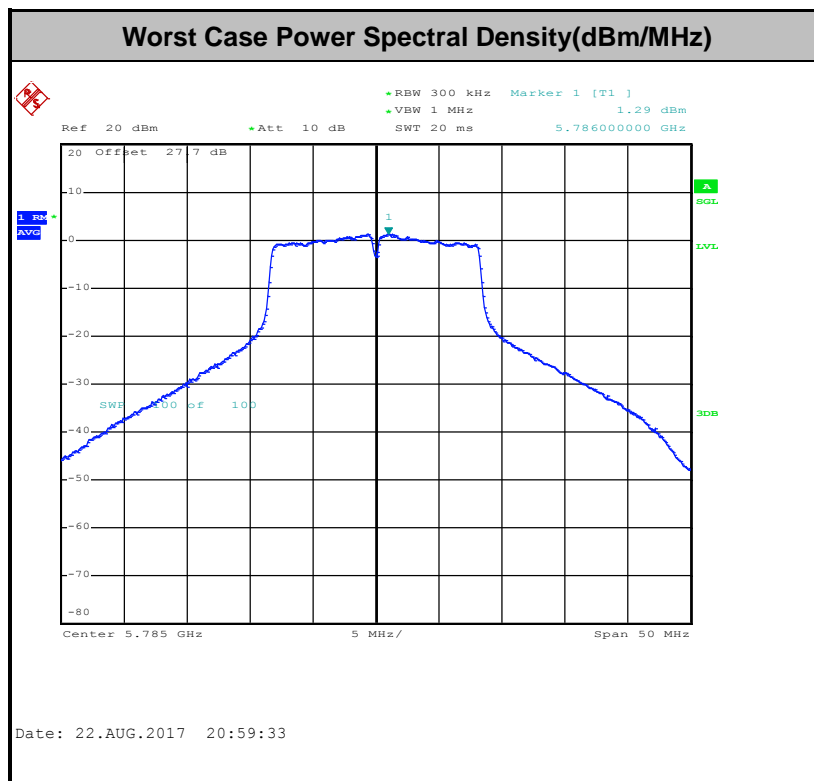

**Note:** Average Power Density (dB) = Measured value+ Duty Factor



### 3.4 Unwanted Radiated Emission Measurement

This section is to measure unwanted emissions through radiated measurement for band edge spurious emissions and out of band emissions measurement.

#### 3.4.1 Limit of Unwanted Emissions

(1) For transmitters operating in the 5.725-5.85 GHz band:

15.407(b)(4)(i) All emissions shall be limited to a level of -27 dBm/MHz at 75 MHz or more above or below the band edge increasing linearly to 10 dBm/MHz at 25 MHz above or below the band edge, and from 25 MHz above or below the band edge increasing linearly to a level of 15.6 dBm/MHz at 5 MHz above or below the band edge, and from 5 MHz above or below the band edge increasing linearly to a level of 27 dBm/MHz at the band edge.

(2) Unwanted spurious emissions fallen in restricted bands shall comply with the general field strength limits as below table,

| Frequency (MHz) | Field Strength (microvolts/meter) | Measurement Distance (meters) |
|-----------------|-----------------------------------|-------------------------------|
| 0.009 – 0.490   | 2400/F(kHz)                       | 300                           |
| 0.490 – 1.705   | 24000/F(kHz)                      | 30                            |
| 1.705 – 30.0    | 30                                | 30                            |
| 30 – 88         | 100                               | 3                             |
| 88 – 216        | 150                               | 3                             |
| 216 - 960       | 200                               | 3                             |
| Above 960       | 500                               | 3                             |

**Note:** The following formula is used to convert the EIRP to field strength.

$$E = \frac{1000000\sqrt{30P}}{3} \mu V/m, \text{ where } P \text{ is the eirp (Watts)}$$



| EIRP (dBm) | Field Strength at 3m (dBµV/m) |
|------------|-------------------------------|
| -17        | 78.3                          |
| - 27       | 68.3                          |

(3) KDB789033 D02 v01r04 G)2)c)

- (i) Section 15.407(b)(1-3) specifies the unwanted emissions limit for the U-NII-1 and 2 bands. As specified, emissions above 1000 MHz that are outside of the restricted bands are subject to a peak emission limit of -27 dBm/MHz. However, an out-of-band emission that complies with both the average and peak limits of Section 15.209 is not required to satisfy the -27 dBm/MHz dBm/MHz peak emission limit.
- (ii) Section 15.407(b)(4) specifies the unwanted emissions limit for the U-NII-3 band. A band emissions mask is specified in Section 15.407(b)(4)(i). An alternative to the band emissions mask is specified in Section 15.407(b)(4)(ii). The alternative limits are based on the highest antenna gain specified in the filing. There are also marketing and importation restrictions for the alternative limit.

**Note 3:** An out-of-band emission that complies with both the average and peak limits of Section 15.209 is not required to satisfy the -27 dBm/MHz peak emission limit.

**Note 4:** Only devices with antenna gains of 10 dBi or less may be approved using the emission limits specified in Section 15.247(d) till March 2, 2018; all other devices operating in this band must use the mask specified in Section 15.407(b)(4)(i).

### 3.4.2 Measuring Instruments

The measuring equipment is listed in the section 4 of this test report.



### **3.4.3 Test Procedures**

1. The testing follows FCC KDB 789033 D02 General UNII Test Procedures New Rules v01r04. Section G) Unwanted emissions measurement.

(1) Procedure for Unwanted Emissions Measurements Below 1000MHz

- RBW = 120 kHz
- VBW = 300 kHz
- Detector = Peak
- Trace mode = max hold

(2) Procedure for Peak Unwanted Emissions Measurements Above 1000 MHz

- RBW = 1 MHz
- VBW  $\geq$  3 MHz
- Detector = Peak
- Sweep time = auto
- Trace mode = max hold

(3) Procedures for Average Unwanted Emissions Measurements Above 1000MHz

- RBW = 1 MHz
- VBW = 10 Hz, when duty cycle is no less than 98 percent.
- VBW  $\geq$  1/T, when duty cycle is less than 98 percent where T is the minimum transmission duration over which the transmitter is on and is transmitting at its maximum power control level for the tested mode of operation.

2. The EUT was placed on a turntable with 0.8 meter for frequency below 1GHz and 1.5 meter for frequency above 1GHz respectively above ground.
3. The EUT was set 3 meters from the interference receiving antenna which was mounted on the top of a variable height antenna tower.
4. The antenna is a broadband antenna and its height is adjusted between one meter and four meters above ground to find the maximum value of the field strength for both horizontal polarization and vertical polarization of the antenna.
5. For each suspected emission, the EUT was arranged to its worst case and then adjust the antenna tower (from 1 m to 4 m) and turntable (from 0 degree to 360 degrees) to find the maximum reading.
6. For testing below 1GHz, if the emission level of the EUT in peak mode was 3 dB lower than the limit specified, then peak values of EUT will be reported, otherwise, the emissions will be repeated one by one using the CISPR quasi-peak method and reported.
7. For testing above 1GHz, the emission level of the EUT in peak mode was 20dB lower than average limit (that means the emission level in average mode also complies with the limit in average mode), then peak values of EUT will be reported, otherwise, the emissions will be measured in average mode again and reported.

### 3.4.4 Test Setup

For radiated emissions below 30MHz

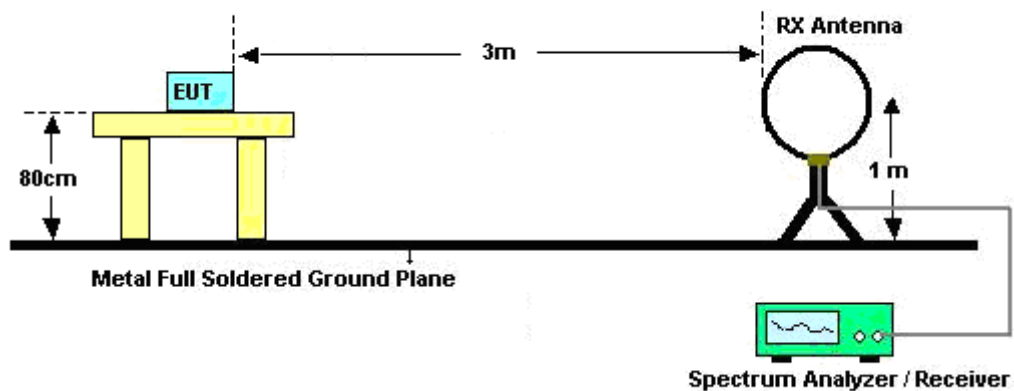

For radiated emissions from 30MHz to 1GHz

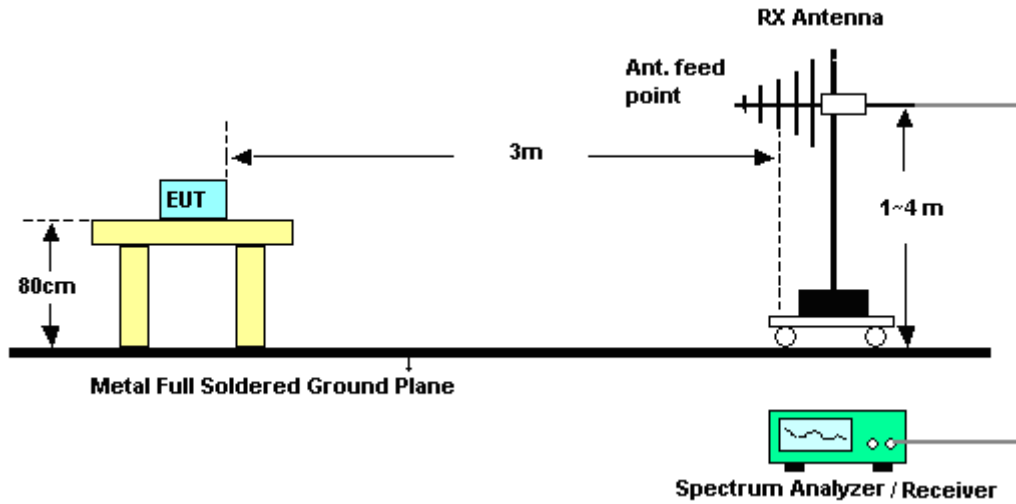

For radiated emissions above 1GHz

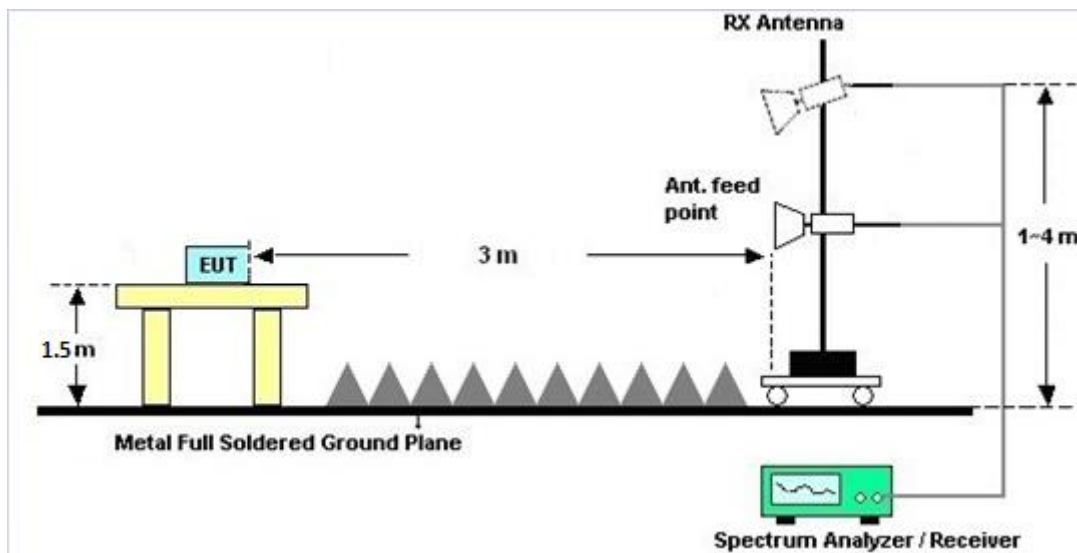



### **3.4.5 Test Results of Radiated Spurious Emissions (9 kHz ~ 30 MHz)**

The low frequency, which started from 9 kHz to 30MHz, was pre-scanned and the result which was 20dB lower than the limit line was not reported.

There is a comparison data of both open-field test site and semi-Anechoic chamber, and the result came out very similar.

### **3.4.6 Test Result of Radiated Spurious at Band Edges**

Please refer to Appendix C and D.

### **3.4.7 Duty Cycle**

Please refer to Appendix E.

### **3.4.8 Test Result of Radiated Spurious Emissions (30MHz ~ 10th Harmonic)**

Please refer to Appendix C and D.



### 3.5 AC Conducted Emission Measurement

#### 3.5.1 Limit of AC Conducted Emission

For equipment that is designed to be connected to the public utility (AC) power line, the radio frequency voltage that is conducted back onto the AC power line on any frequency or frequencies within the band 150 kHz to 30 MHz shall not exceed the limits in the following table.

| Frequency of emission (MHz) | Conducted limit (dB $\mu$ V) |           |
|-----------------------------|------------------------------|-----------|
|                             | Quasi-peak                   | Average   |
| 0.15-0.5                    | 66 to 56*                    | 56 to 46* |
| 0.5-5                       | 56                           | 46        |
| 5-30                        | 60                           | 50        |

\*Decreases with the logarithm of the frequency.

#### 3.5.2 Measuring Instruments

The measuring equipment is listed in the section 4 of this test report.

#### 3.5.3 Test Procedures

1. The EUT was placed 0.4 meter from the conducting wall of the shielding room was kept at least 80 centimeters from any other grounded conducting surface.
2. Connect EUT to the power mains through a line impedance stabilization network (LISN).
3. All the support units are connecting to the other LISN.
4. The LISN provides 50 ohm coupling impedance for the measuring instrument.
5. The FCC states that a 50 ohm, 50 microhenry LISN should be used.
6. Both sides of AC line were checked for maximum conducted interference.
7. The frequency range from 150 kHz to 30 MHz was searched.
8. Set the test-receiver system to Peak Detect Function and specified bandwidth with Maximum Hold Mode.



### 3.5.4 Test Setup

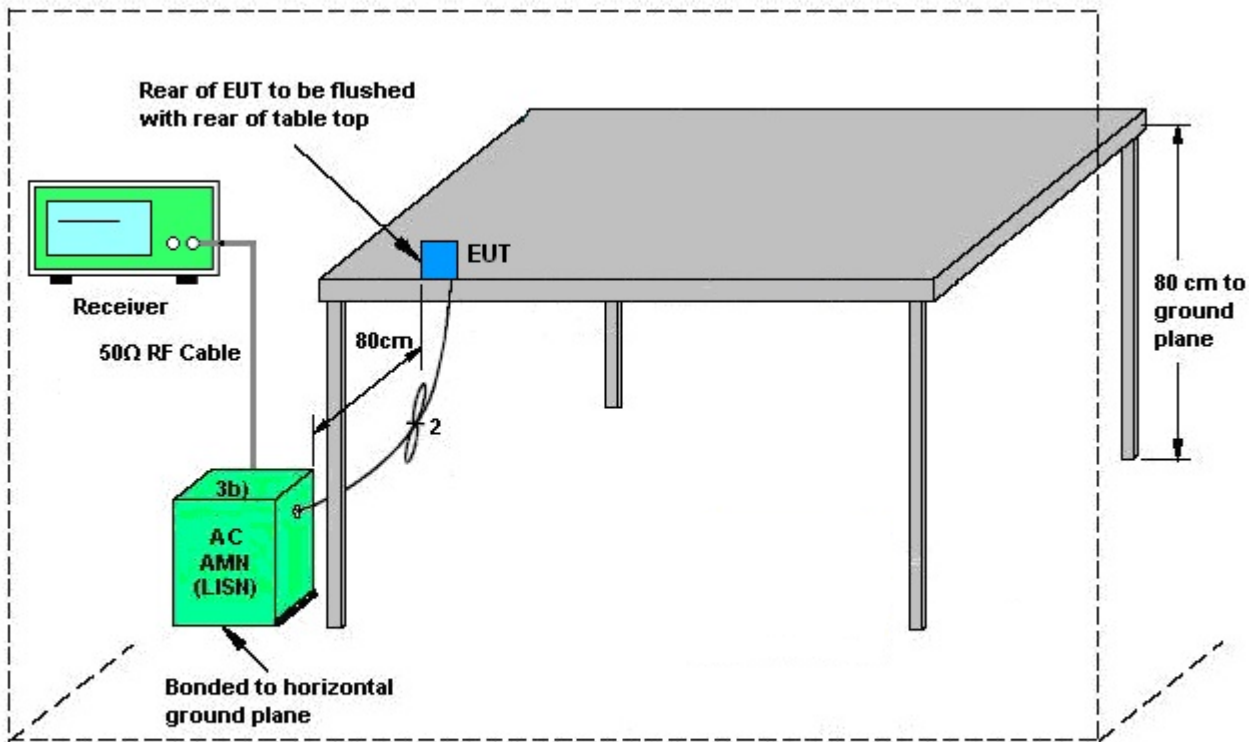

AMN = Artificial mains network (LISN)  
AE = Associated equipment  
EUT = Equipment under test  
ISN = Impedance stabilization network

### 3.5.5 Test Result of AC Conducted Emission

Please refer to Appendix B.

### 3.6 Frequency Stability Measurement

#### 3.6.1 Limit of Frequency Stability

Manufacturers of U-NII devices are responsible for ensuring frequency stability such that an emission is maintained within the band of operation under all conditions of normal operation as specified in the user's manual.

#### 3.6.2 Measuring Instruments

The measuring equipment is listed in the section 4 of this test report.

#### 3.6.3 Test Procedures

1. To ensure emission at the band edge is maintained within the authorized band, those values shall be measured by radiation emissions at upper and lower frequency points, and finally compensated by frequency deviation as procedures below.
2. The EUT was operated at the maximum output power, and connected to the spectrum analyzer, which is set to maximum hold function and peak detector. The peak value of the power envelope was measured and noted. The upper and lower frequency points were respectively measured relatively 10dB lower than the measured peak value.
3. The frequency deviation was calculated by adding the upper frequency point and the lower frequency point divided by two. Those detailed values of frequency deviation are provided in table below.

#### 3.6.4 Test Setup

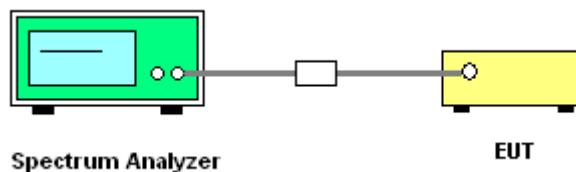

#### 3.6.5 Test Result of Frequency Stability

Please refer to Appendix A.



## **3.7 Automatically Discontinue Transmission**

### **3.7.1 Limit of Automatically Discontinue Transmission**

The device shall automatically discontinue transmission in case of either absence of information to transmit or operational failure. These provisions are not intended to preclude the transmission of control or signaling information or the use of repetitive codes used by certain digital technologies to complete frame or burst intervals. Applicants shall include in their application for equipment authorization to describe how this requirement is met.

### **3.7.2 Measuring Instruments**

The measuring equipment is listed in the section 4 of this test report.

### **3.7.3 Test Result of Automatically Discontinue Transmission**

While the EUT is not transmitting any information, the EUT can automatically discontinue transmission and become standby mode for power saving. The EUT can detect the controlling signal of ACK message transmitting from remote device and verify whether it shall resend or discontinue transmission.



## **3.8 Antenna Requirements**

### **3.8.1 Standard Applicable**

If transmitting antenna directional gain is greater than 6 dBi, both the peak transmit power and the peak power spectral density shall be reduced by the amount in dB that the directional gain of the antenna exceeds 6 dBi.

### **3.8.2 Antenna Anti-Replacement Construction**

An embedded-in antenna design is used.

### **3.8.3 Antenna Gain**

The antenna gain is less than 6 dBi. Therefore, it is not necessary to reduce maximum peak output power limit.



## 4 List of Measuring Equipments

| Instrument           | Manufacturer    | Model No.                 | Serial No.  | Characteristics                     | Calibration Date | Test Date                        | Due Date      | Remark                   |
|----------------------|-----------------|---------------------------|-------------|-------------------------------------|------------------|----------------------------------|---------------|--------------------------|
| Power Meter          | Anritsu         | ML2495A                   | 0932001     | N/A                                 | Sep. 29, 2016    | Aug. 10, 2017~<br>Aug. 25, 2017  | Sep. 28, 2017 | Conducted<br>(TH05-HY)   |
| Power Sensor         | Anritsu         | MA2411B                   | 0846202     | 300MHz~40GHz                        | Sep. 29, 2016    | Aug. 10, 2017~<br>Aug. 25, 2017  | Sep. 28, 2017 | Conducted<br>(TH05-HY)   |
| Spectrum Analyzer    | Rohde & Schwarz | FSP30                     | 101067      | 9kHz ~ 30GHz                        | Nov. 17, 2016    | Aug. 10, 2017~<br>Aug. 25, 2017  | Nov. 16, 2017 | Conducted<br>(TH05-HY)   |
| Hygrometer           | Testo           | 608-H2                    | 41410069    | N/A                                 | Aug. 28, 2016    | Aug. 10, 2017~<br>Aug. 25, 2017  | Aug. 27, 2017 | Conducted<br>(TH05-HY)   |
| RF Cable             | HUBER + SUHNER  | SUCOFLEX 104              | MY84209521  | 1GHz~26GHz                          | Dec. 02, 2016    | Aug. 10, 2017~<br>Aug. 25, 2017  | Dec. 01, 2017 | Conducted<br>(TH05-HY)   |
| Temperature Chamber  | ESPEC           | SH-641                    | 92013720    | -40℃ ~90℃                           | Sep. 01, 2016    | Aug. 10, 2017~<br>Aug. 25, 2017  | Aug. 31, 2017 | Conducted<br>(TH05-HY)   |
| AC Power Source      | ChainTek        | APC-1000W                 | N/A         | N/A                                 | N/A              | Oct. 02, 2017 ~<br>Oct. 03, 2017 | N/A           | Conduction<br>(CO05-HY)  |
| EMI Test Receiver    | Rohde & Schwarz | ESCI 7                    | 100724      | 9kHz~7GHz                           | Sep. 20, 2017    | Oct. 02, 2017 ~<br>Oct. 03, 2017 | Sep. 19, 2018 | Conduction<br>(CO05-HY)  |
| Hygrometer           | Testo           | 608-H1                    | 34913912    | N/A                                 | May 02, 2017     | Oct. 02, 2017 ~<br>Oct. 03, 2017 | May 01, 2018  | Conduction<br>(CO05-HY)  |
| LISN                 | Rohde & Schwarz | ENV216                    | 100080      | 9kHz~30MHz                          | Nov. 29, 2016    | Oct. 02, 2017 ~<br>Oct. 03, 2017 | Nov. 28, 2017 | Conduction<br>(CO05-HY)  |
| LF Cable             | HUBER + SUHNER  | RG-214/U                  | LF01        | N/A                                 | Jan. 05, 2017    | Oct. 02, 2017 ~<br>Oct. 03, 2017 | Jan. 04, 2018 | Conduction<br>(CO05-HY)  |
| Test Software        | N/A             | EMC32                     | 8.40.0      | N/A                                 | N/A              | Oct. 02, 2017 ~<br>Oct. 03, 2017 | N/A           | Conduction<br>(CO05-HY)  |
| Loop Antenna         | Rohde & Schwarz | HFH2-Z2                   | 100488      | 9 kHz~30 MHz                        | Oct. 20, 2016    | Sep. 19, 2017 ~<br>Sep. 29, 2017 | Oct. 19, 2018 | Radiation<br>(03CH12-HY) |
| Bilog Antenna        | TESEQ           | CBL 6111D&00800 N1D01N-06 | 37059&01    | 30MHz~1GHz                          | Oct. 15, 2016    | Sep. 19, 2017 ~<br>Sep. 29, 2017 | Oct. 14, 2017 | Radiation<br>(03CH12-HY) |
| Horn Antenna         | SCHWARZBECK     | BBHA 9120D                | 9120D-1328  | 1GHz ~ 18GHz                        | Oct. 25, 2016    | Sep. 19, 2017 ~<br>Sep. 29, 2017 | Oct. 24, 2017 | Radiation<br>(03CH12-HY) |
| SHF-EHF Horn Antenna | SCHWARZBECK     | BBHA 9170                 | BBHA9170576 | 18GHz ~ 40GHz                       | Apr. 27, 2017    | Sep. 19, 2017 ~<br>Sep. 29, 2017 | Apr. 26, 2018 | Radiation<br>(03CH12-HY) |
| Spectrum Analyzer    | Keysight        | N9010A                    | MY54200486  | 10Hz ~ 44GHz                        | Oct. 12, 2016    | Sep. 19, 2017 ~<br>Sep. 29, 2017 | Oct. 11, 2017 | Radiation<br>(03CH12-HY) |
| EMI Test Receiver    | Rohde & Schwarz | ESU26                     | 100390      | 20Hz~26.5GHz                        | Dec. 23, 2016    | Sep. 19, 2017 ~<br>Sep. 29, 2017 | Dec. 22, 2017 | Radiation<br>(03CH12-HY) |
| Amplifier            | MITEQ           | TTA1840-35-HG             | 1871923     | 18GHz~40GHz,<br>VSWR : 2.5:1<br>max | Jul. 18, 2017    | Sep. 19, 2017 ~<br>Sep. 29, 2017 | Jul. 17, 2018 | Radiation<br>(03CH12-HY) |
| Preamplifier         | COM-POWER       | PA-103                    | 161075      | 10MHz~1GHz                          | Mar. 23, 2017    | Sep. 19, 2017 ~<br>Sep. 29, 2017 | Mar. 22, 2018 | Radiation<br>(03CH12-HY) |
| Preamplifier         | MITEQ           | AMF-7D-0010 1800-30-10P   | 1815698     | 1GHz~18GHz                          | Dec. 01, 2016    | Sep. 19, 2017 ~<br>Sep. 29, 2017 | Nov. 30, 2017 | Radiation<br>(03CH12-HY) |
| Preamplifier         | Keysight        | 83017A                    | MY53270148  | 1GHz~26.5GHz                        | Jan. 12, 2017    | Sep. 19, 2017 ~<br>Sep. 29, 2017 | Jan. 11, 2018 | Radiation<br>(03CH12-HY) |



| Instrument    | Manufacturer      | Model No.                            | Serial No.                             | Characteristics                  | Calibration Date | Test Date                        | Due Date      | Remark                   |
|---------------|-------------------|--------------------------------------|----------------------------------------|----------------------------------|------------------|----------------------------------|---------------|--------------------------|
| Hygrometer    | TECEPEL           | DTM-303B                             | TP140349                               | N/A                              | Nov. 14, 2016    | Sep. 19, 2017 ~<br>Sep. 29, 2017 | Nov. 13, 2017 | Radiation<br>(03CH12-HY) |
| RF Cable      | HUBER +<br>SUHNER | SUCOFLEX<br>104                      | MY24958/4,<br>MY28653/4,<br>MY9839/4PE | 26GHz~40GHz                      | Jan. 10, 2017    | Sep. 19, 2017 ~<br>Sep. 29, 2017 | Jan. 09, 2018 | Radiation<br>(03CH12-HY) |
| RF Cable      | HUBER +<br>SUHNER | SUCOFLEX<br>104                      | MY24958/4,<br>MY28653/4,<br>MY9839/4PE | 1GHz~26GHz                       | Jan. 10, 2017    | Sep. 19, 2017 ~<br>Sep. 29, 2017 | Jan. 09, 2018 | Radiation<br>(03CH12-HY) |
| RF Cable      | HUBER +<br>SUHNER | SUCOFLEX<br>104                      | MY24958/4,<br>MY28653/4,<br>MY9839/4PE | 30MHz~1GHz                       | Jan. 10, 2017    | Sep. 19, 2017 ~<br>Sep. 29, 2017 | Jan. 09, 2018 | Radiation<br>(03CH12-HY) |
| Controller    | EMEC              | EM1000                               | N/A                                    | Control Turn<br>table & Ant Mast | N/A              | Sep. 19, 2017 ~<br>Sep. 29, 2017 | N/A           | Radiation<br>(03CH12-HY) |
| Antenna Mast  | EMEC              | AM-BS-4500-B                         | N/A                                    | 1m~4m                            | N/A              | Sep. 19, 2017 ~<br>Sep. 29, 2017 | N/A           | Radiation<br>(03CH12-HY) |
| Turn Table    | EMEC              | TT2000                               | N/A                                    | 0~360 Degree                     | N/A              | Sep. 19, 2017 ~<br>Sep. 29, 2017 | N/A           | Radiation<br>(03CH12-HY) |
| Test Software | Audix             | E3                                   | 6.2009-8-24                            | N/A                              | N/A              | Sep. 19, 2017 ~<br>Sep. 29, 2017 | N/A           | Radiation<br>(03CH12-HY) |
| Filter        | Wainwright        | WLKS1200-12<br>SS                    | SN2                                    | 1.2G Low Pass                    | Mar. 24, 2017    | Sep. 19, 2017 ~<br>Sep. 29, 2017 | Mar. 23, 2018 | Radiation<br>(03CH12-HY) |
| Filter        | Wainwright        | WHKX12-2700<br>-3000-18000-6<br>0SS  | SN2                                    | 3G High Pass                     | Sep. 18, 2017    | Sep. 19, 2017 ~<br>Sep. 29, 2017 | Sep. 17, 2018 | Radiation<br>(03CH12-HY) |
| Filter        | Woken             | WHKX8-5272.<br>5-6750-18000-<br>40ST | SN2                                    | 6.75G Highpass                   | Mar. 22, 2017    | Sep. 19, 2017 ~<br>Sep. 29, 2017 | Mar. 21, 2018 | Radiation<br>(03CH12-HY) |



## 5 Uncertainty of Evaluation

### Uncertainty of Conducted Emission Measurement (150kHz ~ 30MHz)

|                                                                         |      |
|-------------------------------------------------------------------------|------|
| Measuring Uncertainty for a Level of Confidence of 95% ( $U = 2Uc(y)$ ) | 2.70 |
|-------------------------------------------------------------------------|------|

### Uncertainty of Radiated Emission Measurement (30 MHz ~ 1000 MHz)

|                                                                         |      |
|-------------------------------------------------------------------------|------|
| Measuring Uncertainty for a Level of Confidence of 95% ( $U = 2Uc(y)$ ) | 5.10 |
|-------------------------------------------------------------------------|------|

### Uncertainty of Radiated Emission Measurement (1000 MHz ~ 18000 MHz)

|                                                                         |      |
|-------------------------------------------------------------------------|------|
| Measuring Uncertainty for a Level of Confidence of 95% ( $U = 2Uc(y)$ ) | 5.20 |
|-------------------------------------------------------------------------|------|

### Uncertainty of Radiated Emission Measurement (18000 MHz ~ 40000 MHz)

|                                                                         |      |
|-------------------------------------------------------------------------|------|
| Measuring Uncertainty for a Level of Confidence of 95% ( $U = 2Uc(y)$ ) | 4.70 |
|-------------------------------------------------------------------------|------|

**Appendix A. Test Result of Conducted Test Items**

|                |                       |                    |       |    |
|----------------|-----------------------|--------------------|-------|----|
| Test Engineer: | Shiming Liu/Derek Hsu | Temperature:       | 21~25 | °C |
| Test Date:     | 2017/8/10~2017/8/25   | Relative Humidity: | 51~54 | %  |



**TEST RESULTS DATA**  
**6dB and 26dB EBW and 99% OBW**

| Band IV |           |     |     |             |                     |                       |                      |                                |           |
|---------|-----------|-----|-----|-------------|---------------------|-----------------------|----------------------|--------------------------------|-----------|
| Mod.    | Data Rate | NTX | CH. | Freq. (MHz) | 99% Bandwidth (MHz) | 26 dB Bandwidth (MHz) | 6 dB Bandwidth (MHz) | 6dB Bandwidth min. Limit (MHz) | Pass/Fail |
| 11a     | 6M bps    | 1   | 149 | 5745        | 17.9                | 28.44                 | 15.88                | 0.5                            | Pass      |
| 11a     | 6Mbps     | 1   | 157 | 5785        | 17.8                | 28.74                 | 15.68                | 0.5                            | Pass      |
| 11a     | 6Mbps     | 1   | 165 | 5825        | 17.95               | 28.2                  | 15.68                | 0.5                            | Pass      |
| VHT20   | MCS 0     | 1   | 149 | 5745        | 18.5                | 25.9                  | 15.62                | 0.5                            | Pass      |
| VHT20   | MCS 0     | 1   | 157 | 5785        | 18.8                | 25.26                 | 15.14                | 0.5                            | Pass      |
| VHT20   | MCS 0     | 1   | 165 | 5825        | 18.65               | 25.97                 | 15.4                 | 0.5                            | Pass      |
| VHT40   | MCS 0     | 1   | 151 | 5755        | 36.7                | 42.12                 | 36.04                | 0.5                            | Pass      |
| VHT40   | MCS 0     | 1   | 159 | 5795        | 36.7                | 41.28                 | 35.28                | 0.5                            | Pass      |
| VHT80   | MCS 0     | 1   | 155 | 5775        | 75.84               | 83.36                 | 75.2                 | 0.5                            | Pass      |

**TEST RESULTS DATA**  
**Average Power Table**

| Band IV |           |     |     |             |                  |                               |                                 |          |  |           |
|---------|-----------|-----|-----|-------------|------------------|-------------------------------|---------------------------------|----------|--|-----------|
| Mod.    | Data Rate | NTX | CH. | Freq. (MHz) | Duty Factor (dB) | Average Conducted Power (dBm) | FCC Conducted Power Limit (dBm) | DG (dBi) |  | Pass/Fail |
| 11a     | 6M bps    | 1   | 149 | 5745        | 0.29             | 16.69                         | 30.00                           | -4.50    |  | Pass      |
| 11a     | 6Mbps     | 1   | 157 | 5785        | 0.29             | 16.80                         | 30.00                           | -4.50    |  | Pass      |
| 11a     | 6Mbps     | 1   | 165 | 5825        | 0.29             | 16.82                         | 30.00                           | -4.50    |  | Pass      |
| HT20    | MCS 0     | 1   | 149 | 5745        | 0.29             | 13.80                         | 30.00                           | -4.50    |  | Pass      |
| HT20    | MCS 0     | 1   | 157 | 5785        | 0.29             | 13.82                         | 30.00                           | -4.50    |  | Pass      |
| HT20    | MCS 0     | 1   | 165 | 5825        | 0.29             | 13.50                         | 30.00                           | -4.50    |  | Pass      |
| HT40    | MCS 0     | 1   | 151 | 5755        | 0.56             | 12.75                         | 30.00                           | -4.50    |  | Pass      |
| HT40    | MCS 0     | 1   | 159 | 5795        | 0.56             | 12.56                         | 30.00                           | -4.50    |  | Pass      |
| VHT20   | MCS 0     | 1   | 149 | 5745        | 0.31             | 13.82                         | 30.00                           | -4.50    |  | Pass      |
| VHT20   | MCS 0     | 1   | 157 | 5785        | 0.31             | 14.00                         | 30.00                           | -4.50    |  | Pass      |
| VHT20   | MCS 0     | 1   | 165 | 5825        | 0.31             | 13.53                         | 30.00                           | -4.50    |  | Pass      |
| VHT40   | MCS 0     | 1   | 151 | 5755        | 0.56             | 12.77                         | 30.00                           | -4.50    |  | Pass      |
| VHT40   | MCS 0     | 1   | 159 | 5795        | 0.56             | 12.58                         | 30.00                           | -4.50    |  | Pass      |
| VHT80   | MCS 0     | 1   | 155 | 5775        | 0.57             | 11.82                         | 30.00                           | -4.50    |  | Pass      |

**TEST RESULTS DATA**  
**Power Spectral Density**

| Band IV |           |     |     |             |                  |                                 |                                    |                                |          |           |
|---------|-----------|-----|-----|-------------|------------------|---------------------------------|------------------------------------|--------------------------------|----------|-----------|
| Mod.    | Data Rate | NTX | CH. | Freq. (MHz) | Duty Factor (dB) | 10log (500kHz /RBW) Factor (dB) | Average Power Density (dBm/500kHz) | Average PSD Limit (dBm/500kHz) | DG (dBi) | Pass/Fail |
| 11a     | 6M bps    | 1   | 149 | 5745        | 0.29             | 2.22                            | 3.49                               | 30.00                          | -4.50    | Pass      |
| 11a     | 6Mbps     | 1   | 157 | 5785        | 0.29             | 2.22                            | 3.80                               | 30.00                          | -4.50    | Pass      |
| 11a     | 6Mbps     | 1   | 165 | 5825        | 0.29             | 2.22                            | 3.74                               | 30.00                          | -4.50    | Pass      |
| VHT20   | MCS 0     | 1   | 149 | 5745        | 0.31             | 2.22                            | 0.03                               | 30.00                          | -4.50    | Pass      |
| VHT20   | MCS 0     | 1   | 157 | 5785        | 0.31             | 2.22                            | -0.09                              | 30.00                          | -4.50    | Pass      |
| VHT20   | MCS 0     | 1   | 165 | 5825        | 0.31             | 2.22                            | -0.65                              | 30.00                          | -4.50    | Pass      |
| VHT40   | MCS 0     | 1   | 151 | 5755        | 0.56             | 2.22                            | -4.19                              | 30.00                          | -4.50    | Pass      |
| VHT40   | MCS 0     | 1   | 159 | 5795        | 0.56             | 2.22                            | -4.40                              | 30.00                          | -4.50    | Pass      |
| VHT80   | MCS 0     | 1   | 155 | 5775        | 0.57             | 2.22                            | -8.37                              | 30.00                          | -4.50    | Pass      |

**TEST RESULTS DATA**  
**Frequency Stability**

| Band IV |           |     |     |             |                        |                           |                           |                  |             |      |
|---------|-----------|-----|-----|-------------|------------------------|---------------------------|---------------------------|------------------|-------------|------|
| Mod.    | Data Rate | NTX | CH. | Freq. (MHz) | Center Frequency (MHz) | Frequency Deviation (MHz) | Frequency Stability (ppm) | Temperature (°C) | Voltage (V) | Note |
| 11a     | 6M bps    | 1   | 149 | 5745        | 5745.025               | 0.025                     | 4.35                      | 55               | 3.85        |      |
| 11a     | 6M bps    | 1   | 149 | 5745        | 5745.100               | 0.100                     | 17.41                     | -30              | 3.85        |      |
| 11a     | 6M bps    | 1   | 149 | 5745        | 5744.975               | -0.025                    | -4.35                     | 20               | 4.4         |      |
| 11a     | 6M bps    | 1   | 149 | 5745        | 5745.000               | 0.000                     | 0.00                      | 20               | 3.4         |      |
| 11a     | 6M bps    | 1   | 149 | 5745        | 5745.000               | 0.000                     | 0.00                      | 20               | 3.85        |      |



## Appendix B. AC Conducted Emission Test Results

|                 |          |                     |         |
|-----------------|----------|---------------------|---------|
| Test Engineer : | Blue Lan | Temperature :       | 26~27°C |
|                 |          | Relative Humidity : | 51~52%  |

# EUT Information

Report NO : 760710-01  
 Test Mode : Mode 1  
 Test Voltage : 120Vac/60Hz  
 Phase : Line

ENV216 Auto Test FCC Power Bar - L

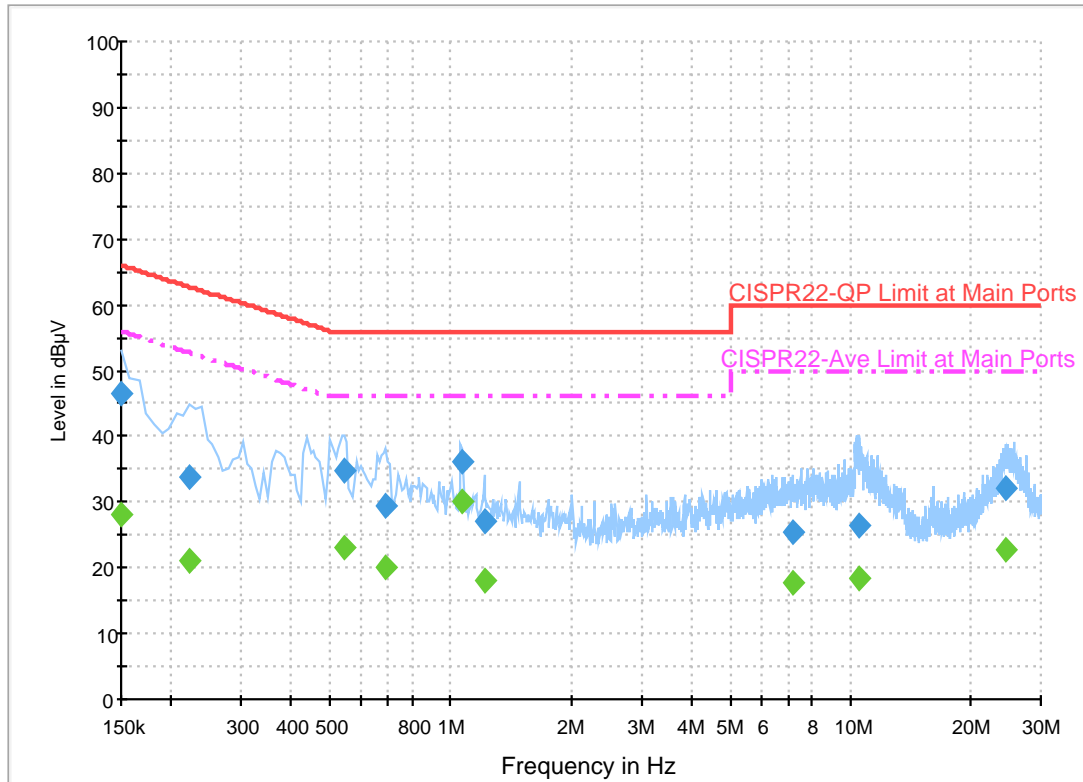

## Final Result 1

| Frequency (MHz) | QuasiPeak (dBµV) | Filter | Line | Corr. (dB) | Margin (dB) | Limit (dBµV) |
|-----------------|------------------|--------|------|------------|-------------|--------------|
| 0.150000        | 46.5             | Off    | L1   | 19.6       | 19.5        | 66.0         |
| 0.222000        | 33.7             | Off    | L1   | 19.6       | 29.0        | 62.7         |
| 0.542000        | 34.7             | Off    | L1   | 19.6       | 21.3        | 56.0         |
| 0.686000        | 29.5             | Off    | L1   | 19.6       | 26.5        | 56.0         |
| 1.070000        | 36.0             | Off    | L1   | 19.6       | 20.0        | 56.0         |
| 1.214000        | 26.9             | Off    | L1   | 19.6       | 29.1        | 56.0         |
| 7.206000        | 25.3             | Off    | L1   | 19.9       | 34.7        | 60.0         |
| 10.558000       | 26.5             | Off    | L1   | 20.1       | 33.5        | 60.0         |
| 24.494000       | 32.1             | Off    | L1   | 20.8       | 27.9        | 60.0         |

## Final Result 2

| Frequency (MHz) | Average (dBµV) | Filter | Line | Corr. (dB) | Margin (dB) | Limit (dBµV) |
|-----------------|----------------|--------|------|------------|-------------|--------------|
| 0.150000        | 28.0           | Off    | L1   | 19.6       | 28.0        | 56.0         |
| 0.222000        | 21.1           | Off    | L1   | 19.6       | 31.6        | 52.7         |
| 0.542000        | 23.0           | Off    | L1   | 19.6       | 23.0        | 46.0         |
| 0.686000        | 20.2           | Off    | L1   | 19.6       | 25.8        | 46.0         |
| 1.070000        | 30.0           | Off    | L1   | 19.6       | 16.0        | 46.0         |
| 1.214000        | 18.0           | Off    | L1   | 19.6       | 28.0        | 46.0         |
| 7.206000        | 17.7           | Off    | L1   | 19.9       | 32.3        | 50.0         |
| 10.558000       | 18.5           | Off    | L1   | 20.1       | 31.5        | 50.0         |
| 24.494000       | 22.8           | Off    | L1   | 20.8       | 27.2        | 50.0         |

# EUT Information

Report NO : 760710-01  
 Test Mode : Mode 1  
 Test Voltage : 120Vac/60Hz  
 Phase : Neutral

ENV216 Auto Test FCC Power Bar - N

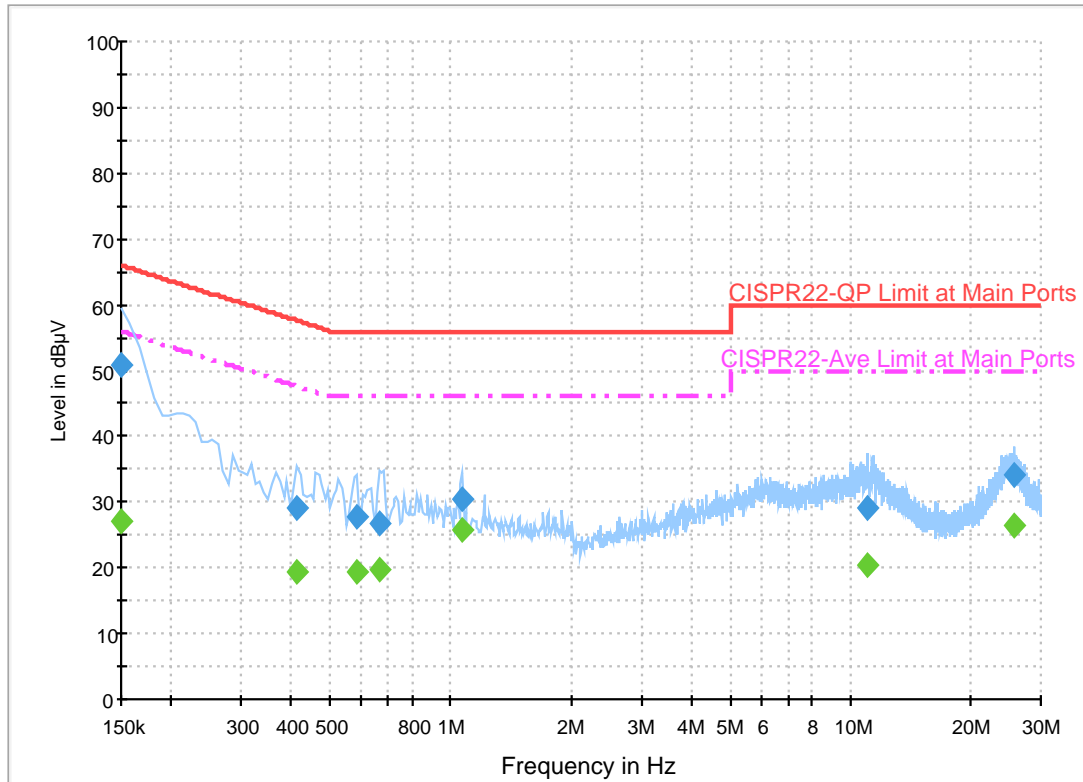

## Final Result 1

| Frequency (MHz) | QuasiPeak (dBµV) | Filter | Line | Corr. (dB) | Margin (dB) | Limit (dBµV) |
|-----------------|------------------|--------|------|------------|-------------|--------------|
| 0.150000        | 50.7             | Off    | N    | 19.5       | 15.3        | 66.0         |
| 0.414000        | 29.2             | Off    | N    | 19.5       | 28.4        | 57.6         |
| 0.582000        | 27.9             | Off    | N    | 19.5       | 28.1        | 56.0         |
| 0.662000        | 26.8             | Off    | N    | 19.5       | 29.2        | 56.0         |
| 1.070000        | 30.5             | Off    | N    | 19.6       | 25.5        | 56.0         |
| 11.054000       | 29.1             | Off    | N    | 20.1       | 30.9        | 60.0         |
| 25.598000       | 34.2             | Off    | N    | 21.0       | 25.8        | 60.0         |

## Final Result 2

| Frequency (MHz) | Average (dBµV) | Filter | Line | Corr. (dB) | Margin (dB) | Limit (dBµV) |
|-----------------|----------------|--------|------|------------|-------------|--------------|
| 0.150000        | 27.1           | Off    | N    | 19.5       | 28.9        | 56.0         |
| 0.414000        | 19.4           | Off    | N    | 19.5       | 28.2        | 47.6         |
| 0.582000        | 19.3           | Off    | N    | 19.5       | 26.7        | 46.0         |
| 0.662000        | 19.8           | Off    | N    | 19.5       | 26.2        | 46.0         |
| 1.070000        | 25.8           | Off    | N    | 19.6       | 20.2        | 46.0         |
| 11.054000       | 20.4           | Off    | N    | 20.1       | 29.6        | 50.0         |
| 25.598000       | 26.3           | Off    | N    | 21.0       | 23.7        | 50.0         |



### Appendix C. Radiated Spurious Emission

|                 |                                 |                     |         |
|-----------------|---------------------------------|---------------------|---------|
| Test Engineer : | Nick Yu / Peter Liao / Ray Chen | Temperature :       | 23~25°C |
|                 |                                 | Relative Humidity : | 61~63%  |

**Band 4 - 5725~5850MHz**

**WIFI 802.11a (Band Edge @ 3m)**

| WIFI Ant. 1                  | Note | Frequency ( MHz ) | Level ( dBμV/m ) | Over Limit ( dB ) | Limit Line ( dBμV/m ) | Read Level ( dBμV ) | Antenna Factor ( dB/m ) | Cable Loss ( dB ) | Preamp Factor ( dB ) | Ant Pos ( cm ) | Table Pos ( deg ) | Peak Avg. ( P/A ) | Pol. ( H/V ) |   |
|------------------------------|------|-------------------|------------------|-------------------|-----------------------|---------------------|-------------------------|-------------------|----------------------|----------------|-------------------|-------------------|--------------|---|
| 802.11a<br>CH 149<br>5745MHz |      | 5638.6            | 49.45            | -18.75            | 68.2                  | 41.31               | 32.79                   | 6.35              | 31                   | 102            | 72                | P                 | H            |   |
|                              |      | 5685.2            | 50.65            | -43.63            | 94.28                 | 42.38               | 32.92                   | 6.36              | 31.01                | 102            | 72                | P                 | H            |   |
|                              |      | 5720              | 58.84            | -51.96            | 110.8                 | 50.47               | 33.02                   | 6.37              | 31.02                | 102            | 72                | P                 | H            |   |
|                              |      | 5724.6            | 70.16            | -51.13            | 121.29                | 61.78               | 33.03                   | 6.37              | 31.02                | 102            | 72                | P                 | H            |   |
|                              | *    | 5745              | 107.83           | -                 | -                     | 99.4                | 33.09                   | 6.37              | 31.03                | 102            | 72                | P                 | H            |   |
|                              | *    | 5745              | 96.62            | -                 | -                     | 88.19               | 33.09                   | 6.37              | 31.03                | 102            | 72                | A                 | H            |   |
|                              |      |                   |                  |                   |                       |                     |                         |                   |                      |                |                   |                   |              | H |
|                              |      |                   |                  |                   |                       |                     |                         |                   |                      |                |                   |                   |              | H |
|                              |      |                   | 5644.6           | 49.82             | -18.38                | 68.2                | 41.67                   | 32.8              | 6.35                 | 31             | 100               | 31                | P            | V |
|                              |      |                   | 5677.6           | 51.13             | -37.53                | 88.66               | 42.89                   | 32.9              | 6.35                 | 31.01          | 100               | 31                | P            | V |
|                              |      |                   | 5719.8           | 56.65             | -54.09                | 110.74              | 48.28                   | 33.02             | 6.37                 | 31.02          | 100               | 31                | P            | V |
|                              |      |                   | 5724.8           | 65.51             | -56.23                | 121.74              | 57.13                   | 33.03             | 6.37                 | 31.02          | 100               | 31                | P            | V |
|                              | *    |                   | 5745             | 104.4             | -                     | -                   | 95.97                   | 33.09             | 6.37                 | 31.03          | 100               | 31                | P            | V |
|                              | *    |                   | 5745             | 93.34             | -                     | -                   | 84.91                   | 33.09             | 6.37                 | 31.03          | 100               | 31                | A            | V |
|                              |      |                   |                  |                   |                       |                     |                         |                   |                      |                |                   |                   |              | V |
|                              |      |                   |                  |                   |                       |                     |                         |                   |                      |                |                   |                   | V            |   |





| WIFI Ant. 1 | Note | Frequency ( MHz ) | Level ( dBμV/m ) | Over Limit ( dB ) | Limit Line ( dBμV/m ) | Read Level ( dBμV ) | Antenna Factor ( dB/m ) | Cable Loss ( dB ) | Preamp Factor ( dB ) | Ant Pos ( cm ) | Table Pos ( deg ) | Peak Avg. ( P/A ) | Pol. ( H/V ) |
|-------------|------|-------------------|------------------|-------------------|-----------------------|---------------------|-------------------------|-------------------|----------------------|----------------|-------------------|-------------------|--------------|
|             |      | 5616              | 49.16            | -19.04            | 68.2                  | 41.09               | 32.72                   | 6.34              | 30.99                | 109            | 77                | P                 | H            |
|             |      | 5650.6            | 49.71            | -18.94            | 68.65                 | 41.54               | 32.82                   | 6.35              | 31                   | 109            | 77                | P                 | H            |
|             |      | 5719.6            | 50.36            | -60.33            | 110.69                | 42                  | 33.01                   | 6.37              | 31.02                | 109            | 77                | P                 | H            |
|             |      | 5723.6            | 51.02            | -67.99            | 119.01                | 42.64               | 33.03                   | 6.37              | 31.02                | 109            | 77                | P                 | H            |
|             | *    | 5785              | 107.75           | -                 | -                     | 99.22               | 33.2                    | 6.38              | 31.05                | 109            | 77                | P                 | H            |
|             | *    | 5785              | 96.91            | -                 | -                     | 88.38               | 33.2                    | 6.38              | 31.05                | 109            | 77                | A                 | H            |
|             |      | 5855              | 50.63            | -60.17            | 110.8                 | 41.88               | 33.39                   | 6.42              | 31.06                | 109            | 77                | P                 | H            |
|             |      | 5856.6            | 50.84            | -59.51            | 110.35                | 42.08               | 33.4                    | 6.42              | 31.06                | 109            | 77                | P                 | H            |
|             |      | 5907.2            | 50.42            | -30.92            | 81.34                 | 41.5                | 33.54                   | 6.46              | 31.08                | 109            | 77                | P                 | H            |
|             |      | 5937.4            | 51.03            | -17.17            | 68.2                  | 42.02               | 33.62                   | 6.48              | 31.09                | 109            | 77                | P                 | H            |
|             |      |                   |                  |                   |                       |                     |                         |                   |                      |                |                   |                   | H            |
|             |      |                   |                  |                   |                       |                     |                         |                   |                      |                |                   |                   | H            |
| 802.11a     |      |                   |                  |                   |                       |                     |                         |                   |                      |                |                   |                   |              |
| CH 157      |      |                   |                  |                   |                       |                     |                         |                   |                      |                |                   |                   |              |
| 5785MHz     |      | 5643.8            | 49.75            | -18.45            | 68.2                  | 41.6                | 32.8                    | 6.35              | 31                   | 100            | 20                | P                 | V            |
|             |      | 5684.6            | 50.46            | -43.38            | 93.84                 | 42.19               | 32.92                   | 6.36              | 31.01                | 100            | 20                | P                 | V            |
|             |      | 5708              | 50.32            | -57.12            | 107.44                | 42                  | 32.98                   | 6.36              | 31.02                | 100            | 20                | P                 | V            |
|             |      | 5723.2            | 50.82            | -67.28            | 118.1                 | 42.45               | 33.02                   | 6.37              | 31.02                | 100            | 20                | P                 | V            |
|             | *    | 5785              | 101.41           | -                 | -                     | 92.88               | 33.2                    | 6.38              | 31.05                | 100            | 20                | P                 | V            |
|             | *    | 5785              | 90.76            | -                 | -                     | 82.23               | 33.2                    | 6.38              | 31.05                | 100            | 20                | A                 | V            |
|             |      | 5852.2            | 49.34            | -67.84            | 117.18                | 40.59               | 33.39                   | 6.42              | 31.06                | 100            | 20                | P                 | V            |
|             |      | 5864              | 50.06            | -58.22            | 108.28                | 41.28               | 33.42                   | 6.43              | 31.07                | 100            | 20                | P                 | V            |
|             |      | 5884              | 50.42            | -48.1             | 98.52                 | 41.58               | 33.48                   | 6.44              | 31.08                | 100            | 20                | P                 | V            |
|             |      | 5942.2            | 50.77            | -17.43            | 68.2                  | 41.74               | 33.64                   | 6.48              | 31.09                | 100            | 20                | P                 | V            |
|             |      |                   |                  |                   |                       |                     |                         |                   |                      |                |                   |                   | V            |
|             |      |                   |                  |                   |                       |                     |                         |                   |                      |                |                   |                   | V            |



| WIFI Ant. 1                  | Note                                                                                        | Frequency ( MHz ) | Level ( dBμV/m ) | Over Limit ( dB ) | Limit Line ( dBμV/m ) | Read Level ( dBμV ) | Antenna Factor ( dB/m ) | Cable Loss ( dB ) | Preamp Factor ( dB ) | Ant Pos ( cm ) | Table Pos ( deg ) | Peak Avg. ( P/A ) | Pol. ( H/V ) |   |
|------------------------------|---------------------------------------------------------------------------------------------|-------------------|------------------|-------------------|-----------------------|---------------------|-------------------------|-------------------|----------------------|----------------|-------------------|-------------------|--------------|---|
| 802.11a<br>CH 165<br>5825MHz | *                                                                                           | 5825              | 109.17           | -                 | -                     | 100.52              | 33.31                   | 6.39              | 31.05                | 111            | 77                | P                 | H            |   |
|                              | *                                                                                           | 5825              | 98.19            | -                 | -                     | 89.54               | 33.31                   | 6.39              | 31.05                | 111            | 77                | A                 | H            |   |
|                              |                                                                                             | 5850              | 60.89            | -61.31            | 122.2                 | 52.15               | 33.38                   | 6.42              | 31.06                | 111            | 77                | P                 | H            |   |
|                              |                                                                                             | 5859              | 53.67            | -56.01            | 109.68                | 44.91               | 33.41                   | 6.42              | 31.07                | 111            | 77                | P                 | H            |   |
|                              |                                                                                             | 5875.6            | 51.98            | -52.77            | 104.75                | 43.17               | 33.45                   | 6.43              | 31.07                | 111            | 77                | P                 | H            |   |
|                              |                                                                                             | 5931.8            | 50.62            | -17.58            | 68.2                  | 41.63               | 33.61                   | 6.47              | 31.09                | 111            | 77                | P                 | H            |   |
|                              |                                                                                             |                   |                  |                   |                       |                     |                         |                   |                      |                |                   |                   |              | H |
|                              |                                                                                             |                   |                  |                   |                       |                     |                         |                   |                      |                |                   |                   |              | H |
|                              | *                                                                                           | 5825              | 101.4            | -                 | -                     | 92.75               | 33.31                   | 6.39              | 31.05                | 100            | 25                | P                 | V            |   |
|                              | *                                                                                           | 5825              | 89.96            | -                 | -                     | 81.31               | 33.31                   | 6.39              | 31.05                | 100            | 25                | A                 | V            |   |
|                              |                                                                                             | 5850.4            | 52.33            | -68.96            | 121.29                | 43.59               | 33.38                   | 6.42              | 31.06                | 100            | 25                | P                 | V            |   |
|                              |                                                                                             | 5862              | 50.43            | -58.41            | 108.84                | 41.66               | 33.41                   | 6.43              | 31.07                | 100            | 25                | P                 | V            |   |
|                              |                                                                                             | 5904.6            | 50.57            | -32.69            | 83.26                 | 41.66               | 33.53                   | 6.46              | 31.08                | 100            | 25                | P                 | V            |   |
|                              |                                                                                             | 5947.6            | 50.05            | -18.15            | 68.2                  | 41.01               | 33.65                   | 6.48              | 31.09                | 100            | 25                | P                 | V            |   |
|                              |                                                                                             |                   |                  |                   |                       |                     |                         |                   |                      |                |                   |                   |              | V |
|                              |                                                                                             |                   |                  |                   |                       |                     |                         |                   |                      |                |                   |                   |              | V |
|                              |                                                                                             |                   |                  |                   |                       |                     |                         |                   |                      |                |                   |                   | V            |   |
| <b>Remark</b>                | 1. No other spurious found.<br>2. All results are PASS against Peak and Average limit line. |                   |                  |                   |                       |                     |                         |                   |                      |                |                   |                   |              |   |



**Band 4 5725~5850MHz**  
**WIFI 802.11a (Harmonic @ 3m)**

| WIFI Ant. 1                  | Note                                                                                        | Frequency ( MHz ) | Level ( dBμV/m ) | Over Limit ( dB ) | Limit Line ( dBμV/m ) | Read Level ( dBμV ) | Antenna Factor ( dB/m ) | Cable Loss ( dB ) | Preamp Factor ( dB ) | Ant Pos ( cm ) | Table Pos ( deg ) | Peak Avg. ( P/A ) | Pol. ( H/V ) |   |
|------------------------------|---------------------------------------------------------------------------------------------|-------------------|------------------|-------------------|-----------------------|---------------------|-------------------------|-------------------|----------------------|----------------|-------------------|-------------------|--------------|---|
| 802.11a<br>CH 149<br>5745MHz |                                                                                             | 11490             | 48.5             | -25.5             | 74                    | 55.54               | 40.2                    | 9.82              | 57.57                | 100            | 0                 | P                 | H            |   |
|                              |                                                                                             | 17235             | 52.72            | -15.48            | 68.2                  | 54.9                | 41.92                   | 12.09             | 56.83                | 100            | 0                 | P                 | H            |   |
|                              |                                                                                             |                   |                  |                   |                       |                     |                         |                   |                      |                |                   |                   | H            |   |
|                              |                                                                                             |                   |                  |                   |                       |                     |                         |                   |                      |                |                   |                   | H            |   |
|                              |                                                                                             |                   | 11490            | 48.06             | -25.94                | 74                  | 55.1                    | 40.2              | 9.82                 | 57.57          | 100               | 0                 | P            | V |
|                              |                                                                                             |                   | 17235            | 54.35             | -13.85                | 68.2                | 56.53                   | 41.92             | 12.09                | 56.83          | 100               | 0                 | P            | V |
|                              |                                                                                             |                   |                  |                   |                       |                     |                         |                   |                      |                |                   |                   |              | V |
|                              |                                                                                             |                   |                  |                   |                       |                     |                         |                   |                      |                |                   |                   |              | V |
| 802.11a<br>CH 157<br>5785MHz |                                                                                             | 11570             | 47.55            | -26.45            | 74                    | 54.72               | 40.06                   | 9.86              | 57.6                 | 100            | 0                 | P                 | H            |   |
|                              |                                                                                             | 17355             | 51.96            | -16.24            | 68.2                  | 54.26               | 42.18                   | 12.19             | 57.3                 | 100            | 0                 | P                 | H            |   |
|                              |                                                                                             |                   |                  |                   |                       |                     |                         |                   |                      |                |                   |                   | H            |   |
|                              |                                                                                             |                   |                  |                   |                       |                     |                         |                   |                      |                |                   |                   | H            |   |
|                              |                                                                                             |                   | 11570            | 47.12             | -26.88                | 74                  | 54.29                   | 40.06             | 9.86                 | 57.6           | 100               | 0                 | P            | V |
|                              |                                                                                             |                   | 17355            | 53.91             | -14.29                | 68.2                | 56.21                   | 42.18             | 12.19                | 57.3           | 100               | 0                 | P            | V |
|                              |                                                                                             |                   |                  |                   |                       |                     |                         |                   |                      |                |                   |                   |              | V |
|                              |                                                                                             |                   |                  |                   |                       |                     |                         |                   |                      |                |                   |                   |              | V |
| 802.11a<br>CH 165<br>5825MHz |                                                                                             | 11650             | 48.2             | -25.8             | 74                    | 55.49               | 39.9                    | 9.9               | 57.6                 | 100            | 0                 | P                 | H            |   |
|                              |                                                                                             | 17475             | 51.57            | -16.63            | 68.2                  | 53.99               | 42.44                   | 12.29             | 57.77                | 100            | 0                 | P                 | H            |   |
|                              |                                                                                             |                   |                  |                   |                       |                     |                         |                   |                      |                |                   |                   | H            |   |
|                              |                                                                                             |                   |                  |                   |                       |                     |                         |                   |                      |                |                   |                   | H            |   |
|                              |                                                                                             |                   | 11650            | 47.55             | -26.45                | 74                  | 54.84                   | 39.9              | 9.9                  | 57.6           | 100               | 0                 | P            | V |
|                              |                                                                                             |                   | 17475            | 51.16             | -17.04                | 68.2                | 53.58                   | 42.44             | 12.29                | 57.77          | 100               | 0                 | P            | V |
|                              |                                                                                             |                   |                  |                   |                       |                     |                         |                   |                      |                |                   |                   |              | V |
|                              |                                                                                             |                   |                  |                   |                       |                     |                         |                   |                      |                |                   |                   |              | V |
| <b>Remark</b>                | 1. No other spurious found.<br>2. All results are PASS against Peak and Average limit line. |                   |                  |                   |                       |                     |                         |                   |                      |                |                   |                   |              |   |



**Band 4 5725~5850MHz**  
**WIFI 802.11ac VHT20 (Band Edge @ 3m)**

| WIFI Ant. 1                   | Note | Frequency ( MHz ) | Level ( dBμV/m ) | Over Limit ( dB ) | Limit Line ( dBμV/m ) | Read Level ( dBμV ) | Antenna Factor ( dB/m ) | Cable Loss ( dB ) | Preamp Factor ( dB ) | Ant Pos ( cm ) | Table Pos ( deg ) | Peak Avg. ( P/A ) | Pol. ( H/V ) |   |
|-------------------------------|------|-------------------|------------------|-------------------|-----------------------|---------------------|-------------------------|-------------------|----------------------|----------------|-------------------|-------------------|--------------|---|
| 802.11ac VHT20 CH 149 5745MHz |      | 5603              | 50.12            | -18.08            | 68.2                  | 42.08               | 32.69                   | 6.34              | 30.99                | 100            | 73                | P                 | H            |   |
|                               |      | 5696.6            | 50.62            | -52.07            | 102.69                | 42.32               | 32.95                   | 6.36              | 31.01                | 100            | 73                | P                 | H            |   |
|                               |      | 5720              | 55.91            | -54.89            | 110.8                 | 47.54               | 33.02                   | 6.37              | 31.02                | 100            | 73                | P                 | H            |   |
|                               |      | 5725              | 62.59            | -59.61            | 122.2                 | 54.21               | 33.03                   | 6.37              | 31.02                | 100            | 73                | P                 | H            |   |
|                               | *    | 5745              | 105.84           | -                 | -                     | 97.41               | 33.09                   | 6.37              | 31.03                | 100            | 73                | P                 | H            |   |
|                               | *    | 5745              | 94.58            | -                 | -                     | 86.15               | 33.09                   | 6.37              | 31.03                | 100            | 73                | A                 | H            |   |
|                               |      |                   |                  |                   |                       |                     |                         |                   |                      |                |                   |                   |              | H |
|                               |      |                   |                  |                   |                       |                     |                         |                   |                      |                |                   |                   |              | H |
|                               |      |                   | 5646.6           | 49.41             | -18.79                | 68.2                | 41.25                   | 32.81             | 6.35                 | 31             | 116               | 17                | P            | V |
|                               |      |                   | 5678.4           | 50.05             | -39.21                | 89.26               | 41.81                   | 32.9              | 6.35                 | 31.01          | 116               | 17                | P            | V |
|                               |      |                   | 5719             | 52.3              | -58.22                | 110.52              | 43.94                   | 33.01             | 6.37                 | 31.02          | 116               | 17                | P            | V |
|                               |      |                   | 5725             | 59.23             | -62.97                | 122.2               | 50.85                   | 33.03             | 6.37                 | 31.02          | 116               | 17                | P            | V |
|                               | *    |                   | 5745             | 101.69            | -                     | -                   | 93.26                   | 33.09             | 6.37                 | 31.03          | 116               | 17                | P            | V |
|                               | *    |                   | 5745             | 90.46             | -                     | -                   | 82.03                   | 33.09             | 6.37                 | 31.03          | 116               | 17                | A            | V |
|                               |      |                   |                  |                   |                       |                     |                         |                   |                      |                |                   |                   | V            |   |
|                               |      |                   |                  |                   |                       |                     |                         |                   |                      |                |                   |                   | V            |   |



| WIFI Ant. 1 | Note | Frequency ( MHz ) | Level ( dBμV/m ) | Over Limit ( dB ) | Limit Line ( dBμV/m ) | Read Level ( dBμV ) | Antenna Factor ( dB/m ) | Cable Loss ( dB ) | Preamp Factor ( dB ) | Ant Pos ( cm ) | Table Pos ( deg ) | Peak Avg. ( P/A ) | Pol. ( H/V ) |
|-------------|------|-------------------|------------------|-------------------|-----------------------|---------------------|-------------------------|-------------------|----------------------|----------------|-------------------|-------------------|--------------|
|             |      | 5640.6            | 49.05            | -19.15            | 68.2                  | 40.91               | 32.79                   | 6.35              | 31                   | 100            | 72                | P                 | H            |
|             |      | 5655.8            | 51.09            | -21.42            | 72.51                 | 42.91               | 32.84                   | 6.35              | 31.01                | 100            | 72                | P                 | H            |
|             |      | 5717.4            | 49.74            | -60.33            | 110.07                | 41.39               | 33.01                   | 6.36              | 31.02                | 100            | 72                | P                 | H            |
|             |      | 5722.8            | 50.9             | -66.28            | 117.18                | 42.53               | 33.02                   | 6.37              | 31.02                | 100            | 72                | P                 | H            |
|             | *    | 5785              | 106.23           | -                 | -                     | 97.7                | 33.2                    | 6.38              | 31.05                | 100            | 72                | P                 | H            |
|             | *    | 5785              | 94.74            | -                 | -                     | 86.21               | 33.2                    | 6.38              | 31.05                | 100            | 72                | A                 | H            |
|             |      | 5851.8            | 50.55            | -67.55            | 118.1                 | 41.8                | 33.39                   | 6.42              | 31.06                | 100            | 72                | P                 | H            |
|             |      | 5858.4            | 51.07            | -58.78            | 109.85                | 42.32               | 33.4                    | 6.42              | 31.07                | 100            | 72                | P                 | H            |
|             |      | 5889.4            | 50.57            | -43.94            | 94.51                 | 41.72               | 33.49                   | 6.44              | 31.08                | 100            | 72                | P                 | H            |
|             |      | 5926.6            | 51.27            | -16.93            | 68.2                  | 42.3                | 33.59                   | 6.47              | 31.09                | 100            | 72                | P                 | H            |
| 802.11ac    |      |                   |                  |                   |                       |                     |                         |                   |                      |                |                   |                   | H            |
| VHT20       |      |                   |                  |                   |                       |                     |                         |                   |                      |                |                   |                   | H            |
| CH 157      |      | 5611.2            | 49.79            | -18.41            | 68.2                  | 41.73               | 32.71                   | 6.34              | 30.99                | 285            | 286               | P                 | V            |
| 5785MHz     |      | 5689.4            | 49.62            | -47.76            | 97.38                 | 41.34               | 32.93                   | 6.36              | 31.01                | 285            | 286               | P                 | V            |
|             |      | 5703              | 49.78            | -56.26            | 106.04                | 41.46               | 32.97                   | 6.36              | 31.01                | 285            | 286               | P                 | V            |
|             |      | 5721.4            | 50.38            | -63.61            | 113.99                | 42.01               | 33.02                   | 6.37              | 31.02                | 285            | 286               | P                 | V            |
|             | *    | 5785              | 100.63           | -                 | -                     | 92.1                | 33.2                    | 6.38              | 31.05                | 285            | 286               | P                 | V            |
|             | *    | 5785              | 89.41            | -                 | -                     | 80.88               | 33.2                    | 6.38              | 31.05                | 285            | 286               | A                 | V            |
|             |      | 5853.8            | 49.65            | -63.89            | 113.54                | 40.9                | 33.39                   | 6.42              | 31.06                | 285            | 286               | P                 | V            |
|             |      | 5859              | 51.02            | -58.66            | 109.68                | 42.26               | 33.41                   | 6.42              | 31.07                | 285            | 286               | P                 | V            |
|             |      | 5907.8            | 51.19            | -29.7             | 80.89                 | 42.27               | 33.54                   | 6.46              | 31.08                | 285            | 286               | P                 | V            |
|             |      | 5949.8            | 51.02            | -17.18            | 68.2                  | 41.97               | 33.66                   | 6.48              | 31.09                | 285            | 286               | P                 | V            |
|             |      |                   |                  |                   |                       |                     |                         |                   |                      |                |                   |                   | V            |
|             |      |                   |                  |                   |                       |                     |                         |                   |                      |                |                   |                   | V            |



| WIFI Ant. 1                            | Note                                                                                        | Frequency ( MHz ) | Level ( dBμV/m ) | Over Limit ( dB ) | Limit Line ( dBμV/m ) | Read Level ( dBμV ) | Antenna Factor ( dB/m ) | Cable Loss ( dB ) | Preamp Factor ( dB ) | Ant Pos ( cm ) | Table Pos ( deg ) | Peak Avg. ( P/A ) | Pol. ( H/V ) |   |
|----------------------------------------|---------------------------------------------------------------------------------------------|-------------------|------------------|-------------------|-----------------------|---------------------|-------------------------|-------------------|----------------------|----------------|-------------------|-------------------|--------------|---|
| 802.11ac<br>VHT20<br>CH 165<br>5825MHz | *                                                                                           | 5825              | 106.91           | -                 | -                     | 98.26               | 33.31                   | 6.39              | 31.05                | 100            | 70                | P                 | H            |   |
|                                        | *                                                                                           | 5825              | 95.6             | -                 | -                     | 86.95               | 33.31                   | 6.39              | 31.05                | 100            | 70                | A                 | H            |   |
|                                        |                                                                                             | 5850.8            | 54.28            | -66.1             | 120.38                | 45.54               | 33.38                   | 6.42              | 31.06                | 100            | 70                | P                 | H            |   |
|                                        |                                                                                             | 5863              | 52.44            | -56.12            | 108.56                | 43.66               | 33.42                   | 6.43              | 31.07                | 100            | 70                | P                 | H            |   |
|                                        |                                                                                             | 5881.8            | 51.76            | -48.39            | 100.15                | 42.92               | 33.47                   | 6.44              | 31.07                | 100            | 70                | P                 | H            |   |
|                                        |                                                                                             | 5948.2            | 50.47            | -17.73            | 68.2                  | 41.43               | 33.65                   | 6.48              | 31.09                | 100            | 70                | P                 | H            |   |
|                                        |                                                                                             |                   |                  |                   |                       |                     |                         |                   |                      |                |                   |                   |              | H |
|                                        |                                                                                             |                   |                  |                   |                       |                     |                         |                   |                      |                |                   |                   |              | H |
|                                        | *                                                                                           | 5825              | 100.31           | -                 | -                     | 91.66               | 33.31                   | 6.39              | 31.05                | 299            | 287               | P                 | V            |   |
|                                        | *                                                                                           | 5825              | 88.91            | -                 | -                     | 80.26               | 33.31                   | 6.39              | 31.05                | 299            | 287               | A                 | V            |   |
|                                        |                                                                                             | 5850.4            | 51.16            | -70.13            | 121.29                | 42.42               | 33.38                   | 6.42              | 31.06                | 299            | 287               | P                 | V            |   |
|                                        |                                                                                             | 5856.2            | 50.21            | -60.25            | 110.46                | 41.45               | 33.4                    | 6.42              | 31.06                | 299            | 287               | P                 | V            |   |
|                                        |                                                                                             | 5919.4            | 51.25            | -21.08            | 72.33                 | 42.3                | 33.57                   | 6.47              | 31.09                | 299            | 287               | P                 | V            |   |
|                                        |                                                                                             | 5941              | 50.85            | -17.35            | 68.2                  | 41.83               | 33.63                   | 6.48              | 31.09                | 299            | 287               | P                 | V            |   |
|                                        |                                                                                             |                   |                  |                   |                       |                     |                         |                   |                      |                |                   |                   |              | V |
|                                        |                                                                                             |                   |                  |                   |                       |                     |                         |                   |                      |                |                   |                   | V            |   |
| <b>Remark</b>                          | 1. No other spurious found.<br>2. All results are PASS against Peak and Average limit line. |                   |                  |                   |                       |                     |                         |                   |                      |                |                   |                   |              |   |



**Band 4 5725~5850MHz**  
**WIFI 802.11ac VHT20 (Harmonic @ 3m)**

| WIFI Ant. 1                   | Note                                                         | Frequency ( MHz ) | Level ( dBμV/m ) | Over Limit ( dB ) | Limit Line ( dBμV/m ) | Read Level ( dBμV ) | Antenna Factor ( dB/m ) | Cable Loss ( dB ) | Preamp Factor ( dB ) | Ant Pos ( cm ) | Table Pos ( deg ) | Peak Avg. ( P/A ) | Pol. ( H/V ) |   |
|-------------------------------|--------------------------------------------------------------|-------------------|------------------|-------------------|-----------------------|---------------------|-------------------------|-------------------|----------------------|----------------|-------------------|-------------------|--------------|---|
| 802.11ac VHT20 CH 149 5745MHz |                                                              | 11490             | 48.17            | -25.83            | 74                    | 55.21               | 40.2                    | 9.82              | 57.57                | 100            | 0                 | P                 | H            |   |
|                               |                                                              | 17235             | 49.98            | -18.22            | 68.2                  | 52.16               | 41.92                   | 12.09             | 56.83                | 100            | 0                 | P                 | H            |   |
|                               |                                                              |                   |                  |                   |                       |                     |                         |                   |                      |                |                   |                   | H            |   |
|                               |                                                              |                   |                  |                   |                       |                     |                         |                   |                      |                |                   |                   | H            |   |
|                               |                                                              |                   | 11490            | 46.7              | -27.3                 | 74                  | 53.74                   | 40.2              | 9.82                 | 57.57          | 100               | 0                 | P            | V |
|                               |                                                              |                   | 17235            | 49.66             | -18.54                | 68.2                | 51.84                   | 41.92             | 12.09                | 56.83          | 100               | 0                 | P            | V |
|                               |                                                              |                   |                  |                   |                       |                     |                         |                   |                      |                |                   |                   |              | V |
| 802.11ac VHT20 CH 157 5785MHz |                                                              | 11570             | 47.83            | -26.17            | 74                    | 55                  | 40.06                   | 9.86              | 57.6                 | 100            | 0                 | P                 | H            |   |
|                               |                                                              | 17355             | 49.03            | -19.17            | 68.2                  | 51.33               | 42.18                   | 12.19             | 57.3                 | 100            | 0                 | P                 | H            |   |
|                               |                                                              |                   |                  |                   |                       |                     |                         |                   |                      |                |                   |                   | H            |   |
|                               |                                                              |                   |                  |                   |                       |                     |                         |                   |                      |                |                   |                   | H            |   |
|                               |                                                              |                   | 11570            | 47.89             | -26.11                | 74                  | 55.06                   | 40.06             | 9.86                 | 57.6           | 100               | 0                 | P            | V |
|                               |                                                              |                   | 17355            | 49.43             | -18.77                | 68.2                | 51.73                   | 42.18             | 12.19                | 57.3           | 100               | 0                 | P            | V |
|                               |                                                              |                   |                  |                   |                       |                     |                         |                   |                      |                |                   |                   |              | V |
| 802.11ac VHT20 CH 165 5825MHz |                                                              | 11650             | 47.15            | -26.85            | 74                    | 54.44               | 39.9                    | 9.9               | 57.6                 | 100            | 0                 | P                 | H            |   |
|                               |                                                              | 17475             | 48.82            | -19.38            | 68.2                  | 51.24               | 42.44                   | 12.29             | 57.77                | 100            | 0                 | P                 | H            |   |
|                               |                                                              |                   |                  |                   |                       |                     |                         |                   |                      |                |                   |                   | H            |   |
|                               |                                                              |                   |                  |                   |                       |                     |                         |                   |                      |                |                   |                   | H            |   |
|                               |                                                              |                   | 11650            | 47.94             | -26.06                | 74                  | 55.23                   | 39.9              | 9.9                  | 57.6           | 100               | 0                 | P            | V |
|                               |                                                              |                   | 17475            | 48.11             | -20.09                | 68.2                | 50.53                   | 42.44             | 12.29                | 57.77          | 100               | 0                 | P            | V |
|                               |                                                              |                   |                  |                   |                       |                     |                         |                   |                      |                |                   |                   |              | V |
| Remark                        | 1. No other spurious found.                                  |                   |                  |                   |                       |                     |                         |                   |                      |                |                   |                   |              |   |
|                               | 2. All results are PASS against Peak and Average limit line. |                   |                  |                   |                       |                     |                         |                   |                      |                |                   |                   |              |   |



**Band 4 5725~5850MHz**  
**WIFI 802.11ac VHT40 (Band Edge @ 3m)**

| WIFI Ant. 1     | Note | Frequency ( MHz ) | Level ( dBμV/m ) | Over Limit ( dB ) | Limit Line ( dBμV/m ) | Read Level ( dBμV ) | Antenna Factor ( dB/m ) | Cable Loss ( dB ) | Preamp Factor ( dB ) | Ant Pos ( cm ) | Table Pos ( deg ) | Peak Avg. ( P/A ) | Pol. ( H/V ) |
|-----------------|------|-------------------|------------------|-------------------|-----------------------|---------------------|-------------------------|-------------------|----------------------|----------------|-------------------|-------------------|--------------|
|                 |      | 5647.6            | 49.42            | -18.78            | 68.2                  | 41.26               | 32.81                   | 6.35              | 31                   | 100            | 64                | P                 | H            |
|                 |      | 5697.4            | 50.97            | -52.31            | 103.28                | 42.67               | 32.95                   | 6.36              | 31.01                | 100            | 64                | P                 | H            |
|                 |      | 5719.6            | 61.31            | -49.38            | 110.69                | 52.95               | 33.01                   | 6.37              | 31.02                | 100            | 64                | P                 | H            |
|                 |      | 5723.4            | 62.33            | -56.22            | 118.55                | 53.95               | 33.03                   | 6.37              | 31.02                | 100            | 64                | P                 | H            |
|                 | *    | 5755              | 101.97           | -                 | -                     | 93.52               | 33.11                   | 6.37              | 31.03                | 100            | 64                | P                 | H            |
|                 | *    | 5755              | 91.02            | -                 | -                     | 82.57               | 33.11                   | 6.37              | 31.03                | 100            | 64                | A                 | H            |
|                 |      | 5852.4            | 50.44            | -66.29            | 116.73                | 41.69               | 33.39                   | 6.42              | 31.06                | 100            | 64                | P                 | H            |
|                 |      | 5861.2            | 49.9             | -59.16            | 109.06                | 41.14               | 33.41                   | 6.42              | 31.07                | 100            | 64                | P                 | H            |
|                 |      | 5883.6            | 50.74            | -48.07            | 98.81                 | 41.91               | 33.47                   | 6.44              | 31.08                | 100            | 64                | P                 | H            |
|                 |      | 5925.4            | 50.95            | -17.25            | 68.2                  | 41.98               | 33.59                   | 6.47              | 31.09                | 100            | 64                | P                 | H            |
|                 |      |                   |                  |                   |                       |                     |                         |                   |                      |                |                   |                   | H            |
|                 |      |                   |                  |                   |                       |                     |                         |                   |                      |                |                   |                   | H            |
| <b>802.11ac</b> |      |                   |                  |                   |                       |                     |                         |                   |                      |                |                   |                   |              |
| <b>VHT40</b>    |      |                   |                  |                   |                       |                     |                         |                   |                      |                |                   |                   |              |
| <b>CH 151</b>   |      | 5643.6            | 49.92            | -18.28            | 68.2                  | 41.77               | 32.8                    | 6.35              | 31                   | 287            | 277               | P                 | V            |
| <b>5755MHz</b>  |      | 5699.8            | 50.56            | -54.49            | 105.05                | 42.25               | 32.96                   | 6.36              | 31.01                | 287            | 277               | P                 | V            |
|                 |      | 5715              | 57.1             | -52.3             | 109.4                 | 48.76               | 33                      | 6.36              | 31.02                | 287            | 277               | P                 | V            |
|                 |      | 5722.8            | 57.76            | -59.42            | 117.18                | 49.39               | 33.02                   | 6.37              | 31.02                | 287            | 277               | P                 | V            |
|                 | *    | 5755              | 96.98            | -                 | -                     | 88.53               | 33.11                   | 6.37              | 31.03                | 287            | 277               | P                 | V            |
|                 | *    | 5755              | 85.8             | -                 | -                     | 77.35               | 33.11                   | 6.37              | 31.03                | 287            | 277               | A                 | V            |
|                 |      | 5853.2            | 50.21            | -64.69            | 114.9                 | 41.46               | 33.39                   | 6.42              | 31.06                | 287            | 277               | P                 | V            |
|                 |      | 5867              | 49.92            | -57.52            | 107.44                | 41.13               | 33.43                   | 6.43              | 31.07                | 287            | 277               | P                 | V            |
|                 |      | 5886              | 50.56            | -46.47            | 97.03                 | 41.72               | 33.48                   | 6.44              | 31.08                | 287            | 277               | P                 | V            |
|                 |      | 5935              | 50.29            | -17.91            | 68.2                  | 41.28               | 33.62                   | 6.48              | 31.09                | 287            | 277               | P                 | V            |
|                 |      |                   |                  |                   |                       |                     |                         |                   |                      |                |                   |                   | V            |
|                 |      |                   |                  |                   |                       |                     |                         |                   |                      |                |                   |                   | V            |





| WIFI Ant. 1   | Note                                                                                        | Frequency ( MHz ) | Level ( dBμV/m ) | Over Limit ( dB ) | Limit Line ( dBμV/m ) | Read Level ( dBμV ) | Antenna Factor ( dB/m ) | Cable Loss ( dB ) | Preamp Factor ( dB ) | Ant Pos ( cm ) | Table Pos ( deg ) | Peak Avg. ( P/A ) | Pol. ( H/V ) |
|---------------|---------------------------------------------------------------------------------------------|-------------------|------------------|-------------------|-----------------------|---------------------|-------------------------|-------------------|----------------------|----------------|-------------------|-------------------|--------------|
|               |                                                                                             | 5615              | 49.54            | -18.66            | 68.2                  | 41.47               | 32.72                   | 6.34              | 30.99                | 107            | 65                | P                 | H            |
|               |                                                                                             | 5686              | 49.85            | -45.02            | 94.87                 | 41.58               | 32.92                   | 6.36              | 31.01                | 107            | 65                | P                 | H            |
|               |                                                                                             | 5719.2            | 50.68            | -59.9             | 110.58                | 42.32               | 33.01                   | 6.37              | 31.02                | 107            | 65                | P                 | H            |
|               |                                                                                             | 5724.2            | 49.81            | -70.57            | 120.38                | 41.43               | 33.03                   | 6.37              | 31.02                | 107            | 65                | P                 | H            |
|               | *                                                                                           | 5795              | 102.09           | -                 | -                     | 93.53               | 33.23                   | 6.38              | 31.05                | 107            | 65                | P                 | H            |
|               | *                                                                                           | 5795              | 91.53            | -                 | -                     | 82.97               | 33.23                   | 6.38              | 31.05                | 107            | 65                | A                 | H            |
|               |                                                                                             | 5852.4            | 51.68            | -65.05            | 116.73                | 42.93               | 33.39                   | 6.42              | 31.06                | 107            | 65                | P                 | H            |
|               |                                                                                             | 5858.2            | 51.03            | -58.87            | 109.9                 | 42.28               | 33.4                    | 6.42              | 31.07                | 107            | 65                | P                 | H            |
|               |                                                                                             | 5886.8            | 51.81            | -44.63            | 96.44                 | 42.97               | 33.48                   | 6.44              | 31.08                | 107            | 65                | P                 | H            |
|               |                                                                                             | 5943.8            | 50.26            | -17.94            | 68.2                  | 41.23               | 33.64                   | 6.48              | 31.09                | 107            | 65                | P                 | H            |
| 802.11ac      |                                                                                             |                   |                  |                   |                       |                     |                         |                   |                      |                |                   |                   | H            |
| VHT40         |                                                                                             |                   |                  |                   |                       |                     |                         |                   |                      |                |                   |                   | H            |
| CH 159        |                                                                                             | 5619.2            | 49.83            | -18.37            | 68.2                  | 41.75               | 32.73                   | 6.34              | 30.99                | 287            | 288               | P                 | V            |
| 5795MHz       |                                                                                             | 5657.6            | 49.88            | -23.97            | 73.85                 | 41.7                | 32.84                   | 6.35              | 31.01                | 287            | 288               | P                 | V            |
|               |                                                                                             | 5712              | 49.81            | -58.75            | 108.56                | 41.48               | 32.99                   | 6.36              | 31.02                | 287            | 288               | P                 | V            |
|               |                                                                                             | 5724.6            | 50.11            | -71.18            | 121.29                | 41.73               | 33.03                   | 6.37              | 31.02                | 287            | 288               | P                 | V            |
|               | *                                                                                           | 5795              | 96.59            | -                 | -                     | 88.03               | 33.23                   | 6.38              | 31.05                | 287            | 288               | P                 | V            |
|               | *                                                                                           | 5795              | 85.87            | -                 | -                     | 77.31               | 33.23                   | 6.38              | 31.05                | 287            | 288               | A                 | V            |
|               |                                                                                             | 5854.4            | 49.58            | -62.59            | 112.17                | 40.83               | 33.39                   | 6.42              | 31.06                | 287            | 288               | P                 | V            |
|               |                                                                                             | 5872.8            | 51.14            | -54.68            | 105.82                | 42.34               | 33.44                   | 6.43              | 31.07                | 287            | 288               | P                 | V            |
|               |                                                                                             | 5915.4            | 50.41            | -24.87            | 75.28                 | 41.47               | 33.56                   | 6.47              | 31.09                | 287            | 288               | P                 | V            |
|               |                                                                                             | 5928.2            | 50.39            | -17.81            | 68.2                  | 41.41               | 33.6                    | 6.47              | 31.09                | 287            | 288               | P                 | V            |
|               |                                                                                             |                   |                  |                   |                       |                     |                         |                   |                      |                |                   |                   | V            |
|               |                                                                                             |                   |                  |                   |                       |                     |                         |                   |                      |                |                   |                   | V            |
| <b>Remark</b> | 1. No other spurious found.<br>2. All results are PASS against Peak and Average limit line. |                   |                  |                   |                       |                     |                         |                   |                      |                |                   |                   |              |



**Band 4 5725~5850MHz**  
**WIFI 802.11ac VHT40 (Harmonic @ 3m)**

| WIFI Ant. 1                   | Note                                                                                        | Frequency ( MHz ) | Level ( dBμV/m ) | Over Limit ( dB ) | Limit Line ( dBμV/m ) | Read Level ( dBμV ) | Antenna Factor ( dB/m ) | Cable Loss ( dB ) | Preamp Factor ( dB ) | Ant Pos ( cm ) | Table Pos ( deg ) | Peak Avg. ( P/A ) | Pol. ( H/V ) |   |
|-------------------------------|---------------------------------------------------------------------------------------------|-------------------|------------------|-------------------|-----------------------|---------------------|-------------------------|-------------------|----------------------|----------------|-------------------|-------------------|--------------|---|
| 802.11ac VHT40 CH 151 5755MHz |                                                                                             | 11510             | 47.66            | -26.34            | 74                    | 54.74               | 40.18                   | 9.83              | 57.6                 | 100            | 0                 | P                 | H            |   |
|                               |                                                                                             | 17265             | 50.22            | -17.98            | 68.2                  | 52.46               | 41.98                   | 12.11             | 56.97                | 100            | 0                 | P                 | H            |   |
|                               |                                                                                             |                   |                  |                   |                       |                     |                         |                   |                      |                |                   |                   | H            |   |
|                               |                                                                                             |                   |                  |                   |                       |                     |                         |                   |                      |                |                   |                   | H            |   |
|                               |                                                                                             |                   | 11510            | 47.52             | -26.48                | 74                  | 54.6                    | 40.18             | 9.83                 | 57.6           | 100               | 0                 | P            | V |
|                               |                                                                                             |                   | 17265            | 50.12             | -18.08                | 68.2                | 52.36                   | 41.98             | 12.11                | 56.97          | 100               | 0                 | P            | V |
|                               |                                                                                             |                   |                  |                   |                       |                     |                         |                   |                      |                |                   |                   |              | V |
|                               |                                                                                             |                   |                  |                   |                       |                     |                         |                   |                      |                |                   |                   |              | V |
| 802.11ac VHT40 CH 159 5795MHz |                                                                                             | 11590             | 48.01            | -25.99            | 74                    | 55.21               | 40.02                   | 9.87              | 57.6                 | 100            | 0                 | P                 | H            |   |
|                               |                                                                                             | 17385             | 49.27            | -18.93            | 68.2                  | 51.61               | 42.25                   | 12.21             | 57.43                | 100            | 0                 | P                 | H            |   |
|                               |                                                                                             |                   |                  |                   |                       |                     |                         |                   |                      |                |                   |                   | H            |   |
|                               |                                                                                             |                   |                  |                   |                       |                     |                         |                   |                      |                |                   |                   | H            |   |
|                               |                                                                                             |                   | 11590            | 48.2              | -25.8                 | 74                  | 55.4                    | 40.02             | 9.87                 | 57.6           | 100               | 0                 | P            | V |
|                               |                                                                                             |                   | 17385            | 49.39             | -18.81                | 68.2                | 51.73                   | 42.25             | 12.21                | 57.43          | 100               | 0                 | P            | V |
|                               |                                                                                             |                   |                  |                   |                       |                     |                         |                   |                      |                |                   |                   |              | V |
|                               |                                                                                             |                   |                  |                   |                       |                     |                         |                   |                      |                |                   |                   |              | V |
| <b>Remark</b>                 | 1. No other spurious found.<br>2. All results are PASS against Peak and Average limit line. |                   |                  |                   |                       |                     |                         |                   |                      |                |                   |                   |              |   |



**Band 4 5725~5850MHz**  
**WIFI 802.11ac VHT80 (Band Edge @ 3m)**

| WIFI Ant. 1 | Note | Frequency ( MHz ) | Level ( dBμV/m ) | Over Limit ( dB ) | Limit Line ( dBμV/m ) | Read Level ( dBμV ) | Antenna Factor ( dB/m ) | Cable Loss ( dB ) | Preamp Factor ( dB ) | Ant Pos ( cm ) | Table Pos ( deg ) | Peak Avg. ( P/A ) | Pol. ( H/V ) |
|-------------|------|-------------------|------------------|-------------------|-----------------------|---------------------|-------------------------|-------------------|----------------------|----------------|-------------------|-------------------|--------------|
|             |      | 5647.4            | 50.23            | -17.97            | 68.2                  | 42.07               | 32.81                   | 6.35              | 31                   | 105            | 78                | P                 | H            |
|             |      | 5700              | 55.89            | -49.31            | 105.2                 | 47.58               | 32.96                   | 6.36              | 31.01                | 105            | 78                | P                 | H            |
|             |      | 5719              | 60.57            | -49.95            | 110.52                | 52.21               | 33.01                   | 6.37              | 31.02                | 105            | 78                | P                 | H            |
|             |      | 5722              | 59.88            | -55.48            | 115.36                | 51.51               | 33.02                   | 6.37              | 31.02                | 105            | 78                | P                 | H            |
|             | *    | 5775              | 97.57            | -                 | -                     | 89.06               | 33.17                   | 6.38              | 31.04                | 105            | 78                | P                 | H            |
|             | *    | 5775              | 86.94            | -                 | -                     | 78.43               | 33.17                   | 6.38              | 31.04                | 105            | 78                | A                 | H            |
|             |      | 5851.2            | 57.43            | -62.03            | 119.46                | 48.69               | 33.38                   | 6.42              | 31.06                | 105            | 78                | P                 | H            |
|             |      | 5856.4            | 57.45            | -52.96            | 110.41                | 48.69               | 33.4                    | 6.42              | 31.06                | 105            | 78                | P                 | H            |
|             |      | 5875.2            | 52.74            | -52.31            | 105.05                | 43.93               | 33.45                   | 6.43              | 31.07                | 105            | 78                | P                 | H            |
|             |      | 5941.4            | 50.42            | -17.78            | 68.2                  | 41.39               | 33.64                   | 6.48              | 31.09                | 105            | 78                | P                 | H            |
| 802.11ac    |      |                   |                  |                   |                       |                     |                         |                   |                      |                |                   |                   | H            |
| VHT80       |      |                   |                  |                   |                       |                     |                         |                   |                      |                |                   |                   | H            |
| CH 155      |      | 5621.6            | 49.26            | -18.94            | 68.2                  | 41.17               | 32.74                   | 6.34              | 30.99                | 102            | 17                | P                 | V            |
| 5775MHz     |      | 5700              | 53.65            | -51.55            | 105.2                 | 45.34               | 32.96                   | 6.36              | 31.01                | 102            | 17                | P                 | V            |
|             |      | 5715.6            | 57.29            | -52.28            | 109.57                | 48.95               | 33                      | 6.36              | 31.02                | 102            | 17                | P                 | V            |
|             |      | 5720.4            | 57.49            | -54.22            | 111.71                | 49.12               | 33.02                   | 6.37              | 31.02                | 102            | 17                | P                 | V            |
|             | *    | 5775              | 92.82            | -                 | -                     | 84.31               | 33.17                   | 6.38              | 31.04                | 102            | 17                | P                 | V            |
|             | *    | 5775              | 81.22            | -                 | -                     | 72.71               | 33.17                   | 6.38              | 31.04                | 102            | 17                | A                 | V            |
|             |      | 5854.4            | 49.38            | -62.79            | 112.17                | 40.63               | 33.39                   | 6.42              | 31.06                | 102            | 17                | P                 | V            |
|             |      | 5864.6            | 50.74            | -57.37            | 108.11                | 41.96               | 33.42                   | 6.43              | 31.07                | 102            | 17                | P                 | V            |
|             |      | 5905.8            | 50.49            | -31.88            | 82.37                 | 41.57               | 33.54                   | 6.46              | 31.08                | 102            | 17                | P                 | V            |
|             |      | 5944              | 51.36            | -16.84            | 68.2                  | 42.33               | 33.64                   | 6.48              | 31.09                | 102            | 17                | P                 | V            |
|             |      |                   |                  |                   |                       |                     |                         |                   |                      |                |                   |                   | V            |
|             |      |                   |                  |                   |                       |                     |                         |                   |                      |                |                   |                   | V            |

**Remark**

- No other spurious found.
- All results are PASS against Peak and Average limit line.



Band 4 5725~5850MHz

WIFI 802.11ac VHT80 (Harmonic @ 3m)

| WIFI Ant. 1                   | Note                                                                                        | Frequency ( MHz ) | Level ( dBμV/m ) | Over Limit ( dB ) | Limit Line ( dBμV/m ) | Read Level ( dBμV ) | Antenna Factor ( dB/m ) | Cable Loss ( dB ) | Preamp Factor ( dB ) | Ant Pos ( cm ) | Table Pos ( deg ) | Peak Avg. ( P/A ) | Pol. ( H/V ) |   |
|-------------------------------|---------------------------------------------------------------------------------------------|-------------------|------------------|-------------------|-----------------------|---------------------|-------------------------|-------------------|----------------------|----------------|-------------------|-------------------|--------------|---|
| 802.11ac VHT80 CH 155 5775MHz |                                                                                             | 11550             | 49.41            | -24.59            | 74                    | 56.55               | 40.1                    | 9.85              | 57.6                 | 100            | 0                 | P                 | H            |   |
|                               |                                                                                             | 17325             | 49.62            | -18.58            | 68.2                  | 51.88               | 42.12                   | 12.16             | 57.17                | 100            | 0                 | P                 | H            |   |
|                               |                                                                                             |                   |                  |                   |                       |                     |                         |                   |                      |                |                   |                   | H            |   |
|                               |                                                                                             |                   |                  |                   |                       |                     |                         |                   |                      |                |                   |                   | H            |   |
|                               |                                                                                             |                   | 11550            | 48.51             | -25.49                | 74                  | 55.65                   | 40.1              | 9.85                 | 57.6           | 100               | 0                 | P            | V |
|                               |                                                                                             |                   | 17325            | 48.81             | -19.39                | 68.2                | 51.07                   | 42.12             | 12.16                | 57.17          | 100               | 0                 | P            | V |
|                               |                                                                                             |                   |                  |                   |                       |                     |                         |                   |                      |                |                   |                   |              | V |
|                               |                                                                                             |                   |                  |                   |                       |                     |                         |                   |                      |                |                   |                   |              | V |
| Remark                        | 1. No other spurious found.<br>2. All results are PASS against Peak and Average limit line. |                   |                  |                   |                       |                     |                         |                   |                      |                |                   |                   |              |   |





**Note symbol**

|     |                                                                                                                                                          |
|-----|----------------------------------------------------------------------------------------------------------------------------------------------------------|
| *   | <b>Fundamental Frequency</b> which can be ignored. However, the level of any unwanted emissions shall not exceed the level of the fundamental frequency. |
| !   | Test result is <b>over limit</b> line.                                                                                                                   |
| P/A | <b>Peak</b> or <b>Average</b>                                                                                                                            |
| H/V | <b>Horizontal</b> or <b>Vertical</b>                                                                                                                     |



A calculation example for radiated spurious emission is shown as below:

| WIFI    | Note | Frequency | Level      | Over   | Limit      | Read     | Antenna  | Cable  | Preamp | Ant    | Table   | Peak    | Pol.    |
|---------|------|-----------|------------|--------|------------|----------|----------|--------|--------|--------|---------|---------|---------|
| Ant.    |      |           |            | Limit  | Line       | Level    | Factor   | Loss   | Factor | Pos    | Pos     | Avg.    |         |
| 1       |      | ( MHz )   | ( dBμV/m ) | ( dB ) | ( dBμV/m ) | ( dBμV ) | ( dB/m ) | ( dB ) | ( dB ) | ( cm ) | ( deg ) | ( P/A ) | ( H/V ) |
| 802.11b |      | 2390      | 55.45      | -18.55 | 74         | 54.51    | 32.22    | 4.58   | 35.86  | 103    | 308     | P       | H       |
| CH 01   |      |           |            |        |            |          |          |        |        |        |         |         |         |
| 2412MHz |      | 2390      | 43.54      | -10.46 | 54         | 42.6     | 32.22    | 4.58   | 35.86  | 103    | 308     | A       | H       |

- Level(dBμV/m) =  
Antenna Factor(dB/m) + Cable Loss(dB) + Read Level(dBμV) - Preamp Factor(dB)
- Over Limit(dB) = Level(dBμV/m) – Limit Line(dBμV/m)

**For Peak Limit @ 2390MHz:**

- Level(dBμV/m)  
= Antenna Factor(dB/m) + Cable Loss(dB) + Read Level(dBμV) - Preamp Factor(dB)  
= 32.22(dB/m) + 4.58(dB) + 54.51(dBμV) – 35.86 (dB)  
= 55.45 (dBμV/m)
- Over Limit(dB)  
= Level(dBμV/m) – Limit Line(dBμV/m)  
= 55.45(dBμV/m) – 74(dBμV/m)  
= -18.55(dB)

**For Average Limit @ 2390MHz:**

- Level(dBμV/m)  
= Antenna Factor(dB/m) + Cable Loss(dB) + Read Level(dBμV) - Preamp Factor(dB)  
= 32.22(dB/m) + 4.58(dB) + 42.6(dBμV) – 35.86 (dB)  
= 43.54 (dBμV/m)
- Over Limit(dB)  
= Level(dBμV/m) – Limit Line(dBμV/m)  
= 43.54(dBμV/m) – 54(dBμV/m)  
= -10.46(dB)

Both peak and average measured complies with the limit line, so test result is “PASS”.



## Appendix D. Radiated Spurious Emission Plots

|                 |                                 |                     |         |
|-----------------|---------------------------------|---------------------|---------|
| Test Engineer : | Nick Yu / Peter Liao / Ray Chen | Temperature :       | 23~25°C |
|                 |                                 | Relative Humidity : | 61~63%  |

### Note symbol

|    |                       |
|----|-----------------------|
| -L | Low channel location  |
| -R | High channel location |





**Band 4 - 5725~5850MHz**  
**WIFI 802.11a (Band Edge @ 3m)**

| WIFI | Band 4 5725~5850MHz Band Edge @ 3m                                                   |                                                                                 |
|------|--------------------------------------------------------------------------------------|---------------------------------------------------------------------------------|
| ANT  | 802.11a CH149 5745MHz                                                                |                                                                                 |
| 1    | Horizontal                                                                           | Fundamental                                                                     |
| Peak | <p>Site Condition : 03CH12-HY<br/>: PEAK(BE) 16-24 3m HORN_9120D_1328 HORIZONTAL</p> | <p>Site Condition : 03CH12-HY<br/>: PEAK(UNI) 3m HORN_9120D_1328 HORIZONTAL</p> |



| WIFI | Band 4 5725~5850MHz Band Edge @ 3m                                                |                                                                           |
|------|-----------------------------------------------------------------------------------|---------------------------------------------------------------------------|
| ANT  | 802.11a CH149 5745MHz                                                             |                                                                           |
| 1    | Vertical                                                                          | Fundamental                                                               |
| Peak | <p>Site Condition : 03CH12-RY : PEAK_BE(B4)_16-24 3m HORN_91200_1328 VERTICAL</p> | <p>Site Condition : 03CH12-RY : PEAK(UNI) 3m HORN_91200_1328 VERTICAL</p> |



| WIFI | Band 4 5725~5850MHz Band Edge @ 3m |             |
|------|------------------------------------|-------------|
| ANT  | 802.11a CH157 5785MHz              |             |
| 1    | Horizontal                         | Fundamental |
| Peak |                                    |             |
| Peak |                                    | Left blank  |



| WIFI               | Band 4 5725~5850MHz Band Edge @ 3m |                          |
|--------------------|------------------------------------|--------------------------|
| ANT                | 802.11a CH157 5785MHz              |                          |
| 1                  | Vertical                           | Fundamental              |
| <p><b>Peak</b></p> |                                    |                          |
| <p><b>Peak</b></p> |                                    | <p><b>Left blank</b></p> |



| WIFI | Band 4 5725~5850MHz Band Edge @ 3m                                                      |                                                                                 |
|------|-----------------------------------------------------------------------------------------|---------------------------------------------------------------------------------|
| ANT  | 802.11a CH165 5825MHz                                                                   |                                                                                 |
| 1    | Horizontal                                                                              | Fundamental                                                                     |
| Peak | <p>Site : 03C112-HY<br/>Condition : PEAK_BE(B4)_16-24 3m HORN_91200_1328 HORIZONTAL</p> | <p>Site : 03C112-HY<br/>Condition : PEAK(UNI) 3m HORN_91200_1328 HORIZONTAL</p> |



| WIFI | Band 4 5725~5850MHz Band Edge @ 3m                                                    |                                                                               |
|------|---------------------------------------------------------------------------------------|-------------------------------------------------------------------------------|
| ANT  | 802.11a CH165 5825MHz                                                                 |                                                                               |
| 1    | Vertical                                                                              | Fundamental                                                                   |
| Peak | <p>Site : 03CH12-HY<br/>Condition : PEAK_BE(B4)_16-24 3m HORN_91200_1328 VERTICAL</p> | <p>Site : 03CH12-HY<br/>Condition : PEAK(UNI) 3m HORN_91200_1328 VERTICAL</p> |



**Band 4 5725~5850MHz**  
**WIFI 802.11ac VHT20 (Band Edge @ 3m)**

| WIFI | Band 4 5725~5850MHz Band Edge @ 3m                                                                       |                                                                                                  |
|------|----------------------------------------------------------------------------------------------------------|--------------------------------------------------------------------------------------------------|
| ANT  | 802.11ac VHT20 CH149 5745MHz                                                                             |                                                                                                  |
| 1    | Horizontal                                                                                               | Fundamental                                                                                      |
| Peak | <p>Site Condition : 03CH12-HY : PEAK_BE(B4)_16-24 3m HORN_91200_1328 HORIZONTAL<br/>Date: 2017-09-22</p> | <p>Site Condition : 03CH12-HY : PEAK(UNI) 3m HORN_91200_1328 HORIZONTAL<br/>Date: 2017-09-22</p> |



| WIFI         | Band 4 5725~5850MHz Band Edge @ 3m                                                |                                                                           |
|--------------|-----------------------------------------------------------------------------------|---------------------------------------------------------------------------|
| ANT          | 802.11ac VHT20 CH149 5745MHz                                                      |                                                                           |
| 1            | Vertical                                                                          | Fundamental                                                               |
| Peak<br>Avg. | <p>Site Condition : 03CH12-RY : PEAK_BE(B4)_16-24 3m HORN_9120D_1328 VERTICAL</p> | <p>Site Condition : 03CH12-RY : PEAK(UNI) 3m HORN_9120D_1328 VERTICAL</p> |





| WIFI | Band 4 5725~5850MHz Band Edge @ 3m |             |
|------|------------------------------------|-------------|
| ANT  | 802.11ac VHT20 CH157 5785MHz       |             |
| 1    | Horizontal                         | Fundamental |
| Peak |                                    |             |
| Peak |                                    | Left blank  |



| WIFI | Band 4 5725~5850MHz Band Edge @ 3m |             |
|------|------------------------------------|-------------|
| ANT  | 802.11ac VHT20 CH157 5785MHz       |             |
| 1    | Vertical                           | Fundamental |
| Peak |                                    |             |
| Peak |                                    | Left blank  |



| WIFI | Band 4 5725~5850MHz Band Edge @ 3m |             |
|------|------------------------------------|-------------|
| ANT  | 802.11ac VHT20 CH165 5825MHz       |             |
| 1    | Horizontal                         | Fundamental |
| Peak |                                    |             |



| WIFI         | Band 4 5725~5850MHz Band Edge @ 3m                                                |                                                                           |
|--------------|-----------------------------------------------------------------------------------|---------------------------------------------------------------------------|
| ANT          | 802.11ac VHT20 CH165 5825MHz                                                      |                                                                           |
| 1            | Vertical                                                                          | Fundamental                                                               |
| Peak<br>Avg. | <p>Site Condition : 03CH12-RT : PEAK_BE(B4)_16-24 3m HORN_91200_1328 VERTICAL</p> | <p>Site Condition : 03CH12-RT : PEAK(UNI) 3m HORN_91200_1328 VERTICAL</p> |



**Band 4 5725~5850MHz  
WIFI 802.11ac VHT40 (Band Edge @ 3m)**

| WIFI | Band 4 5725~5850MHz Band Edge @ 3m                                                  |                                                                             |
|------|-------------------------------------------------------------------------------------|-----------------------------------------------------------------------------|
| ANT  | 802.11ac VHT40 CH151 5755MHz                                                        |                                                                             |
| 1    | Horizontal                                                                          | Fundamental                                                                 |
| Peak | <p>Site Condition : 03CH12-HY : PEAK_BE(B4)_16-24 3m HORN_91200_1328 HORIZONTAL</p> | <p>Site Condition : 03CH12-HY : PEAK(UNI) 3m HORN_91200_1328 HORIZONTAL</p> |
| Peak | <p>Site Condition : 03CH12-HY : PEAK_BE(B4)_16-24 3m HORN_91200_1328 HORIZONTAL</p> | Left blank                                                                  |



| WIFI | Band 4 5725~5850MHz Band Edge @ 3m |             |
|------|------------------------------------|-------------|
| ANT  | 802.11ac VHT40 CH151 5755MHz       |             |
| 1    | Vertical                           | Fundamental |
| Peak |                                    |             |
| Peak |                                    | Left blank  |



| WIFI | Band 4 5725~5850MHz Band Edge @ 3m |             |
|------|------------------------------------|-------------|
| ANT  | 802.11ac VHT40 CH159 5795MHz       |             |
| 1    | Horizontal                         | Fundamental |
| Peak |                                    |             |
| Peak |                                    | Left blank  |



| WIFI | Band 4 5725~5850MHz Band Edge @ 3m                                                |                                                                           |
|------|-----------------------------------------------------------------------------------|---------------------------------------------------------------------------|
| ANT  | 802.11ac VHT40 CH159 5795MHz                                                      |                                                                           |
| 1    | Vertical                                                                          | Fundamental                                                               |
| Peak | <p>Site Condition : 03CH12-HY : PEAK_BE(B4)_16-24 3m HORN_91200_1328 VERTICAL</p> | <p>Site Condition : 03CH12-HY : PEAK(UNI) 3m HORN_91200_1328 VERTICAL</p> |
| Peak | <p>Site Condition : 03CH12-HY : PEAK_BE(B4)_16-24 3m HORN_91200_1328 VERTICAL</p> | Left blank                                                                |





**Band 4 5725~5850MHz  
WIFI 802.11ac VHT80 (Band Edge @ 3m)**

| WIFI | Band 4 5725~5850MHz Band Edge @ 3m                                                  |                                                                             |
|------|-------------------------------------------------------------------------------------|-----------------------------------------------------------------------------|
| ANT  | 802.11ac VHT80 CH155 5775MHz                                                        |                                                                             |
| 1    | Horizontal                                                                          | Fundamental                                                                 |
| Peak | <p>Site Condition : 03CH12-HY : PEAK_BE(B4)_16-24 3m HORN_91200_1328 HORIZONTAL</p> | <p>Site Condition : 03CH12-HY : PEAK(UN1) 3m HORN_91200_1328 HORIZONTAL</p> |
| Peak | <p>Site Condition : 03CH12-HY : PEAK_BE(B4)_16-24 3m HORN_91200_1328 HORIZONTAL</p> | Left blank                                                                  |



| WIFI | Band 4 5725~5850MHz Band Edge @ 3m                                                |                                                                           |
|------|-----------------------------------------------------------------------------------|---------------------------------------------------------------------------|
| ANT  | 802.11ac VHT80 CH155 5775MHz                                                      |                                                                           |
| 1    | Vertical                                                                          | Fundamental                                                               |
| Peak | <p>Site Condition : 03CH12-HY : PEAK_BE(B4)_16-24 3m HORN_91200_1328 VERTICAL</p> | <p>Site Condition : 03CH12-HY : PEAK(UNB) 3m HORN_91200_1328 VERTICAL</p> |
| Peak | <p>Site Condition : 03CH12-HY : PEAK_BE(B4)_16-24 3m HORN_91200_1328 VERTICAL</p> | Left blank                                                                |



**Band 4 - 5725~5850MHz**  
**WIFI 802.11a (Harmonic @ 3m)**

| WIFI                               | Band 4 5725~5850MHz Harmonic @ 3m                                                |                                                                                |
|------------------------------------|----------------------------------------------------------------------------------|--------------------------------------------------------------------------------|
| ANT                                | 802.11a CH149 5745MHz                                                            |                                                                                |
| 1                                  | Horizontal                                                                       | Vertical                                                                       |
| <p><b>Peak</b><br/><b>Avg.</b></p> | <p>Site Condition : 03CH12-HY<br/>: PEAK(UNIT) 3m HORN_9120D_1328 HORIZONTAL</p> | <p>Site Condition : 03CH12-HY<br/>: PEAK(UNIT) 3m HORN_9120D_1328 VERTICAL</p> |



| WIFI         | Band 4 5725~5850MHz Harmonic @ 3m                                                                                                                                                                                                                                                                                                            |                                                                                                                                                                                                                                                                                                                                          |
|--------------|----------------------------------------------------------------------------------------------------------------------------------------------------------------------------------------------------------------------------------------------------------------------------------------------------------------------------------------------|------------------------------------------------------------------------------------------------------------------------------------------------------------------------------------------------------------------------------------------------------------------------------------------------------------------------------------------|
| ANT          | 802.11a CH157 5785MHz                                                                                                                                                                                                                                                                                                                        |                                                                                                                                                                                                                                                                                                                                          |
| 1            | Horizontal                                                                                                                                                                                                                                                                                                                                   | Vertical                                                                                                                                                                                                                                                                                                                                 |
| Peak<br>Avg. | <p>Horizontal spectrum plot showing Level (dBuV/m) vs Frequency (MHz). The plot includes a red line for the average level (AVG: 54) and a red line for the peak level (PEAK(UNIT)). Two peaks are marked with blue vertical lines at 12000 MHz and 1328 MHz. The site condition is 03CH12-RY : PEAK(UNIT) 3m HORN_9120D_1328 HORIZONTAL.</p> | <p>Vertical spectrum plot showing Level (dBuV/m) vs Frequency (MHz). The plot includes a red line for the average level (AVG: 54) and a red line for the peak level (PEAK(UNIT)). Two peaks are marked with blue vertical lines at 12000 MHz and 1328 MHz. The site condition is 03CH12-RY : PEAK(UNIT) 3m HORN_9120D_1328 VERTICAL.</p> |



| WIFI         | Band 4 5725~5850MHz Harmonic @ 3m                                            |                                                                            |
|--------------|------------------------------------------------------------------------------|----------------------------------------------------------------------------|
| ANT          | 802.11a CH165 5825MHz                                                        |                                                                            |
| 1            | Horizontal                                                                   | Vertical                                                                   |
| Peak<br>Avg. | <p>Site Condition : 03CH12-RY : PEAK(UNIT) 3m HORN_9120D_1328 HORIZONTAL</p> | <p>Site Condition : 03CH12-RY : PEAK(UNIT) 3m HORN_9120D_1328 VERTICAL</p> |



**Band 4 5725~5850MHz**  
**WIFI 802.11ac VHT20 (Harmonic @ 3m)**

|                            |                                                                                  |                                                                                |
|----------------------------|----------------------------------------------------------------------------------|--------------------------------------------------------------------------------|
| <b>WIFI</b>                | <b>Band 4 5725~5850MHz Harmonic @ 3m</b>                                         |                                                                                |
| <b>ANT</b>                 | <b>802.11ac VHT20 CH149 5745MHz</b>                                              |                                                                                |
| <b>1</b>                   | <b>Horizontal</b>                                                                | <b>Vertical</b>                                                                |
| <b>Peak</b><br><b>Avg.</b> | <p>Site Condition : 03CH12-HY<br/>: PEAQ(UNIT) 3m HORN_9120D_1328 HORIZONTAL</p> | <p>Site Condition : 03CH12-HY<br/>: PEAQ(UNIT) 3m HORN_9120D_1328 VERTICAL</p> |



| WIFI         | Band 4 5725~5850MHz Harmonic @ 3m                                            |                                                                            |
|--------------|------------------------------------------------------------------------------|----------------------------------------------------------------------------|
| ANT          | 802.11ac VHT20 CH157 5785MHz                                                 |                                                                            |
| 1            | Horizontal                                                                   | Vertical                                                                   |
| Peak<br>Avg. | <p>Site Condition : 03CH12-RY : PEAK(UNIT) 3m HORN_9120D_1328 HORIZONTAL</p> | <p>Site Condition : 03CH12-RY : PEAK(UNIT) 3m HORN_9120D_1328 VERTICAL</p> |



| WIFI         | Band 4 5725~5850MHz Harmonic @ 3m                                            |                                                                            |
|--------------|------------------------------------------------------------------------------|----------------------------------------------------------------------------|
| ANT          | 802.11ac VHT20 CH165 5825MHz                                                 |                                                                            |
| 1            | Horizontal                                                                   | Vertical                                                                   |
| Peak<br>Avg. | <p>Site Condition : 03CH12-RY : PEAK(UNIT) 3m HORN_9120D_1328 HORIZONTAL</p> | <p>Site Condition : 03CH12-RY : PEAK(UNIT) 3m HORN_9120D_1328 VERTICAL</p> |





**Band 4 5725~5850MHz**  
**WIFI 802.11ac VHT40 (Harmonic @ 3m)**

|                      |                                                                                  |                                                                                |
|----------------------|----------------------------------------------------------------------------------|--------------------------------------------------------------------------------|
| <b>WIFI</b>          | <b>Band 4 5725~5850MHz Harmonic @ 3m</b>                                         |                                                                                |
| <b>ANT</b>           | <b>802.11ac VHT40 CH151 5755MHz</b>                                              |                                                                                |
| <b>1</b>             | <b>Horizontal</b>                                                                | <b>Vertical</b>                                                                |
| <b>Peak<br/>Avg.</b> | <p>Site Condition : 03CH12-HY<br/>: PEAQ(UNIT) 3m HORN_9120D_1328 HORIZONTAL</p> | <p>Site Condition : 03CH12-HY<br/>: PEAQ(UNIT) 3m HORN_9120D_1328 VERTICAL</p> |



| WIFI         | Band 4 5725~5850MHz Harmonic @ 3m                                            |                                                                            |
|--------------|------------------------------------------------------------------------------|----------------------------------------------------------------------------|
| ANT          | 802.11ac VHT40 CH159 5795MHz                                                 |                                                                            |
| 1            | Horizontal                                                                   | Vertical                                                                   |
| Peak<br>Avg. | <p>Site Condition : 03CH12-RY : PEAK(UNIT) 3m HORN_9120D_1328 HORIZONTAL</p> | <p>Site Condition : 03CH12-RY : PEAK(UNIT) 3m HORN_9120D_1328 VERTICAL</p> |



**Band 4 5725~5850MHz**  
**WIFI 802.11ac VHT80 (Harmonic @ 3m)**

|                            |                                                                                  |                                                                                |
|----------------------------|----------------------------------------------------------------------------------|--------------------------------------------------------------------------------|
| <b>WIFI</b>                | <b>Band 4 5725~5850MHz Harmonic @ 3m</b>                                         |                                                                                |
| <b>ANT</b>                 | <b>802.11ac VHT80 CH155 5775MHz</b>                                              |                                                                                |
| <b>1</b>                   | <b>Horizontal</b>                                                                | <b>Vertical</b>                                                                |
| <b>Peak</b><br><b>Avg.</b> | <p>Site Condition : 03CH12-HY<br/>: PEAQ(UNIT) 3m HORN_9120D_1328 HORIZONTAL</p> | <p>Site Condition : 03CH12-HY<br/>: PEAQ(UNIT) 3m HORN_9120D_1328 VERTICAL</p> |



Emission below 1GHz  
5GHz WIFI 802.11a (LF)

| WIFI         | 5GHz 5725~5850MHz |          |
|--------------|-------------------|----------|
| ANT          | 802.11a LF        |          |
| 1            | Horizontal        | Vertical |
| QP /<br>Peak |                   |          |



## Appendix E. Duty Cycle Plots

| Band                | Duty Cycle(%) | T(us) | 1/T(kHz) | VBW Setting | Duty Factor(dB) |
|---------------------|---------------|-------|----------|-------------|-----------------|
| 802.11a             | 93.55         | 2030  | 0.49     | 1kHz        | 0.29            |
| 5GHz 802.11ac VHT20 | 93.17         | 1910  | 0.52     | 1kHz        | 0.31            |
| 5GHz 802.11ac VHT40 | 87.85         | 933   | 1.07     | 3kHz        | 0.56            |
| 5GHz 802.11ac VHT80 | 87.65         | 852   | 1.17     | 3kHz        | 0.57            |



802.11a

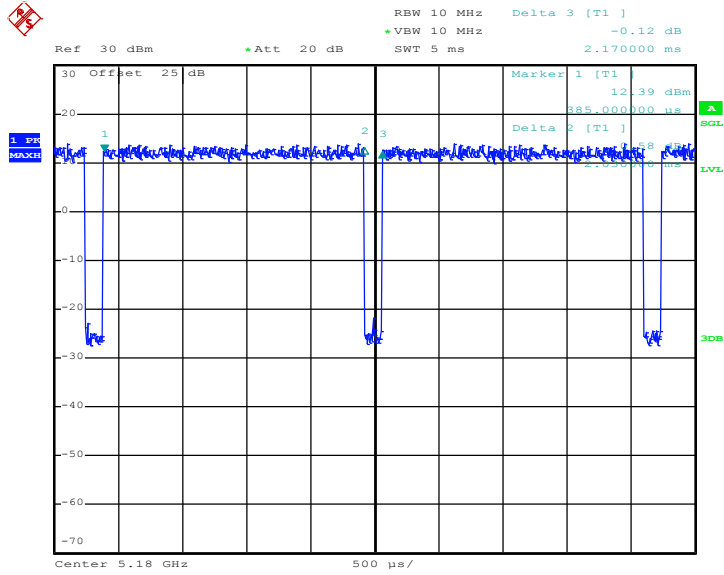

Date: 10.AUG.2017 16:58:22

802.11ac VHT20

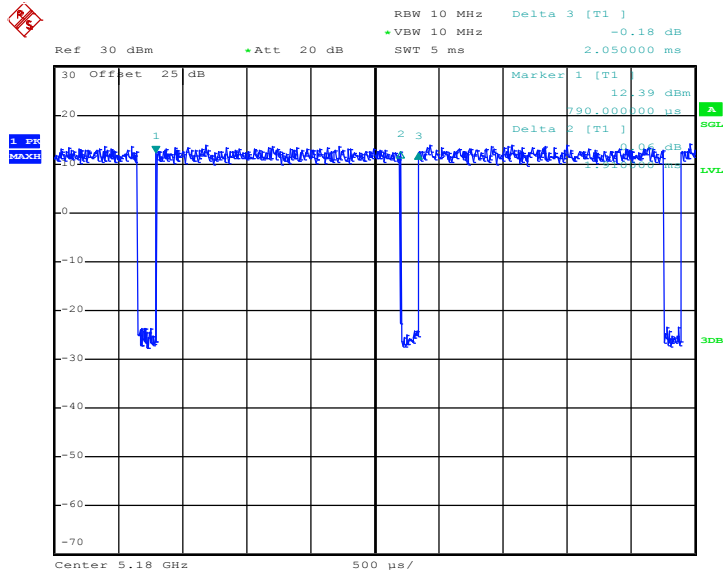

Date: 10.AUG.2017 17:03:50



802.11ac VHT40

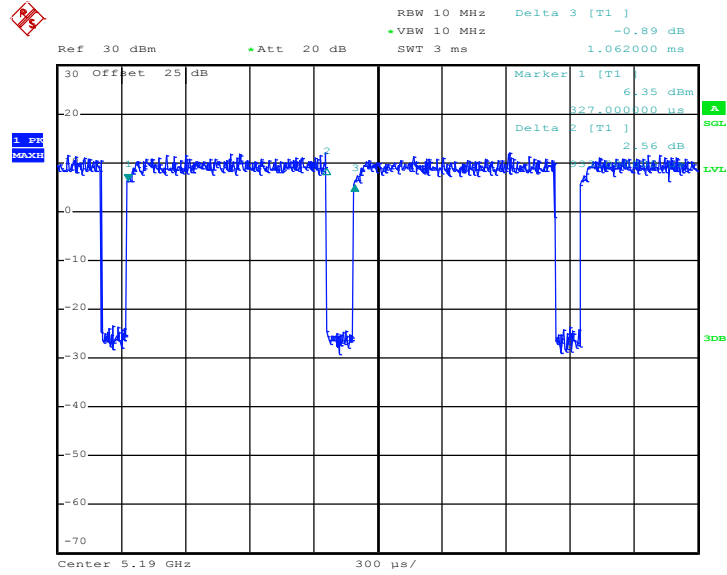

Date: 10.AUG.2017 17:09:49

802.11ac VHT80

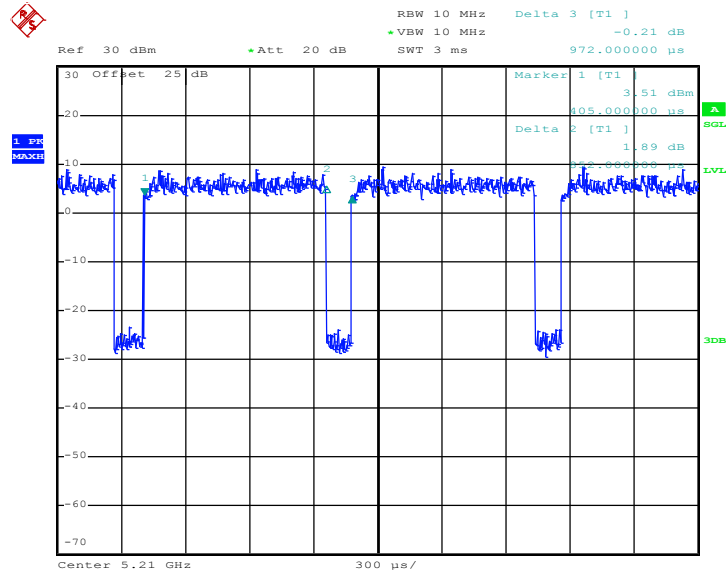

Date: 10.AUG.2017 17:12:25