

#01_GSM850_GPRS (4 Tx slots)_Left Cheek_Ch128

Communication System: GSM850; Frequency: 824.2 MHz; Duty Cycle: 1:2.08

Medium: HSL_850_170912 Medium parameters used: $f = 824.2$ MHz; $\sigma = 0.888$ S/m; $\epsilon_r = 42.554$; $\rho = 1000$ kg/m³

Ambient Temperature : 23.1 °C; Liquid Temperature : 22.1 °C

DASY5 Configuration:

- Probe: ES3DV3 - SN3169; ConvF(5.99, 5.99, 5.99); Calibrated: 2017/5/11;
- Sensor-Surface: 3mm (Mechanical Surface Detection)
- Electronics: DAE4 Sn1399; Calibrated: 2016/11/17
- Phantom: SAM_Right; Type: QD000P40CD; Serial: 1884
- Measurement SW: DASY52, Version 52.8 (8); SEMCAD X Version 14.6.10 (7331)

Area Scan (61x111x1): Interpolated grid: dx=1.500 mm, dy=1.500 mm

Maximum value of SAR (interpolated) = 0.295 W/kg

Zoom Scan (5x5x7)/Cube 0: Measurement grid: dx=8mm, dy=8mm, dz=5mm

Reference Value = 18.25 V/m; Power Drift = 0.04 dB

Peak SAR (extrapolated) = 0.332 W/kg

SAR(1 g) = 0.266 W/kg; SAR(10 g) = 0.208 W/kg

Maximum value of SAR (measured) = 0.294 W/kg

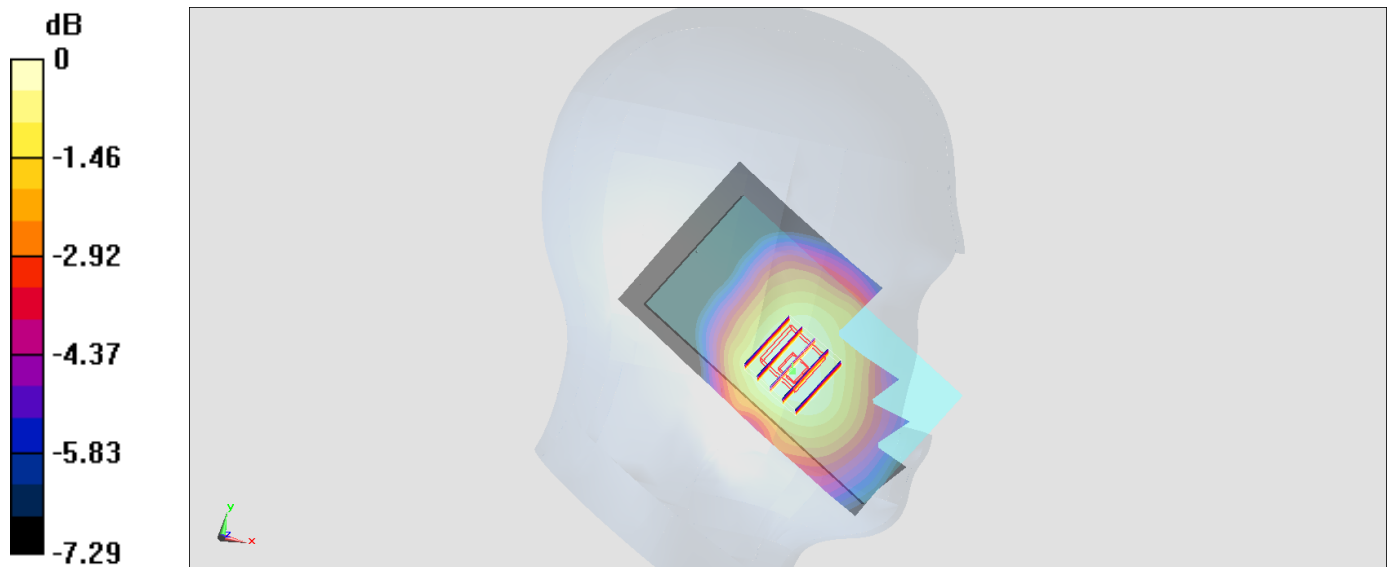

0 dB = 0.294 W/kg = -5.32 dBW/kg

#02_GSM1900_GPRS (4 Tx slots)_Left Cheek_Ch810

Communication System: PCS; Frequency: 1909.8 MHz; Duty Cycle: 1:2.08

Medium: HSL_1900_170913 Medium parameters used: $f = 1910$ MHz; $\sigma = 1.425$ S/m; $\epsilon_r = 39.785$; $\rho = 1000$ kg/m³

Ambient Temperature : 23.7 °C; Liquid Temperature : 22.7 °C

DASY5 Configuration:

- Probe: ES3DV3 - SN3169; ConvF(5.03, 5.03, 5.03); Calibrated: 2017/5/11;
- Sensor-Surface: 3mm (Mechanical Surface Detection)
- Electronics: DAE4 Sn1399; Calibrated: 2016/11/17
- Phantom: SAM_Right; Type: QD000P40CD; Serial: 1884
- Measurement SW: DASY52, Version 52.8 (8); SEMCAD X Version 14.6.10 (7331)

Area Scan (61x111x1): Interpolated grid: dx=1.500 mm, dy=1.500 mm

Maximum value of SAR (interpolated) = 0.314 W/kg

Zoom Scan (5x5x7)/Cube 0: Measurement grid: dx=8mm, dy=8mm, dz=5mm

Reference Value = 14.65 V/m; Power Drift = -0.01 dB

Peak SAR (extrapolated) = 0.367 W/kg

SAR(1 g) = 0.256 W/kg; SAR(10 g) = 0.171 W/kg

Maximum value of SAR (measured) = 0.294 W/kg

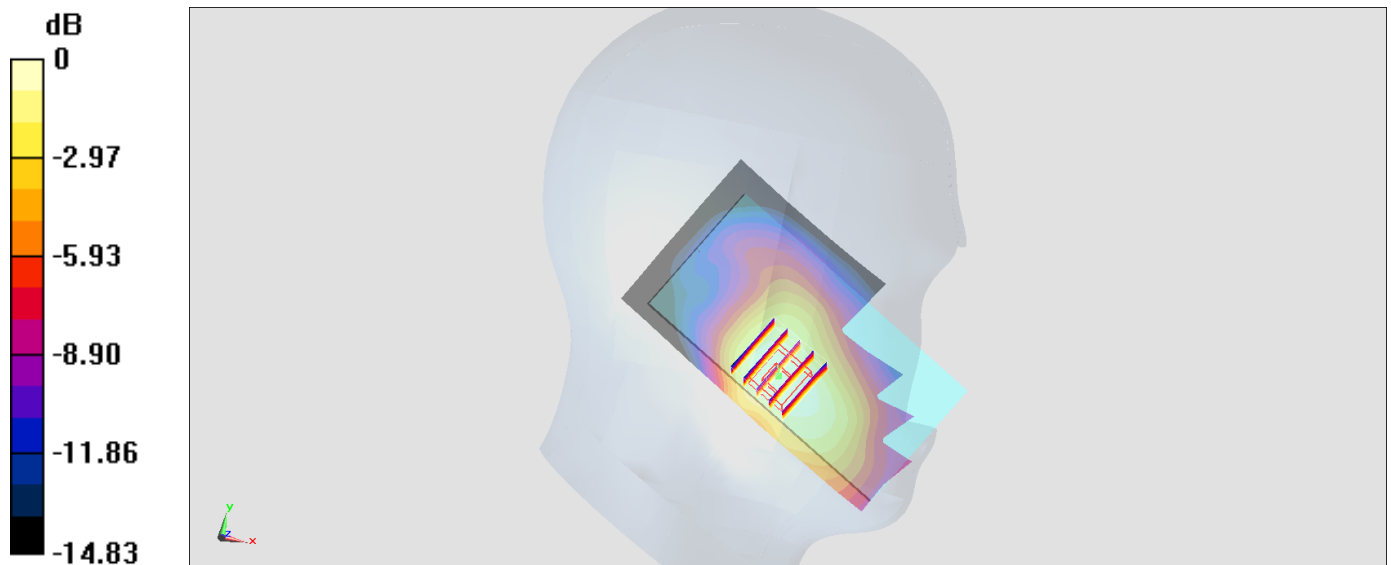

0 dB = 0.294 W/kg = -5.32 dBW/kg

#03_WCDMA II_RMC 12.2Kbps_Left Cheek_Ch9538

Communication System: WCDMA; Frequency: 1907.6 MHz; Duty Cycle: 1:1

Medium: HSL_1900_170913 Medium parameters used: $f = 1908$ MHz; $\sigma = 1.423$ S/m; $\epsilon_r = 39.799$; $\rho = 1000$ kg/m³

Ambient Temperature : 23.7 °C; Liquid Temperature : 22.7 °C

DASY5 Configuration:

- Probe: ES3DV3 - SN3169; ConvF(5.03, 5.03, 5.03); Calibrated: 2017/5/11;
- Sensor-Surface: 3mm (Mechanical Surface Detection)
- Electronics: DAE4 Sn1399; Calibrated: 2016/11/17
- Phantom: SAM_Right; Type: QD000P40CD; Serial: 1884
- Measurement SW: DASY52, Version 52.8 (8); SEMCAD X Version 14.6.10 (7331)

Area Scan (61x111x1): Interpolated grid: dx=1.500 mm, dy=1.500 mm

Maximum value of SAR (interpolated) = 0.732 W/kg

Zoom Scan (5x5x7)/Cube 0: Measurement grid: dx=8mm, dy=8mm, dz=5mm

Reference Value = 22.06 V/m; Power Drift = 0.12 dB

Peak SAR (extrapolated) = 0.852 W/kg

SAR(1 g) = 0.593 W/kg; SAR(10 g) = 0.399 W/kg

Maximum value of SAR (measured) = 0.675 W/kg

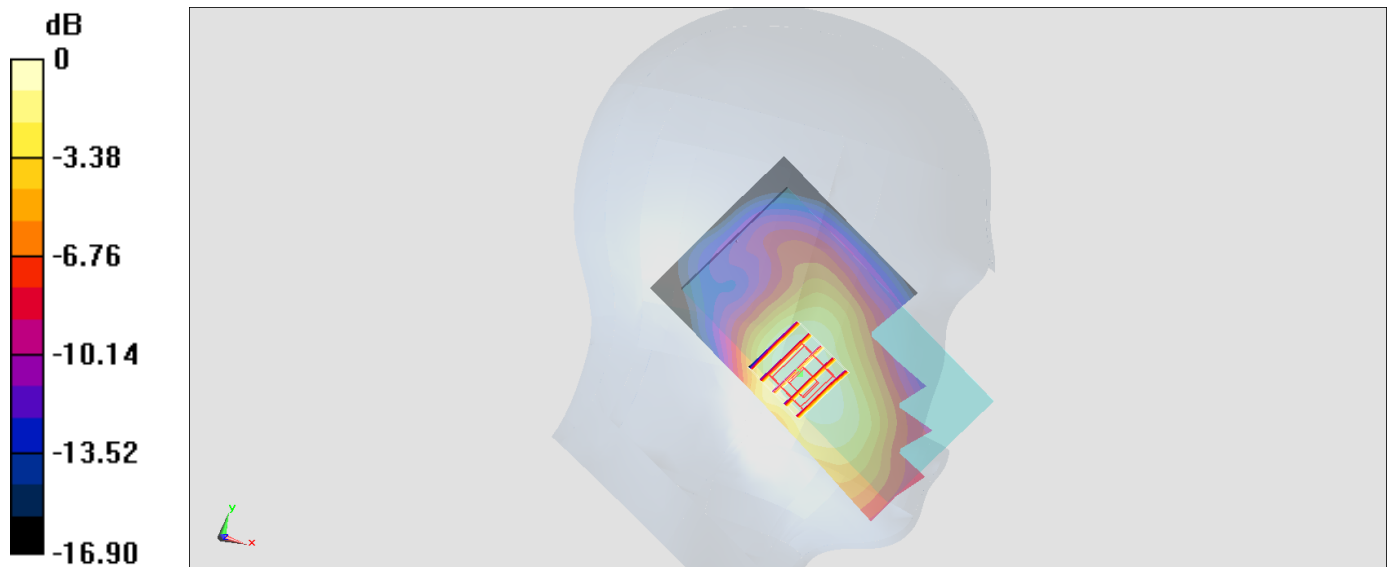

0 dB = 0.675 W/kg = -1.71 dBW/kg

#04_WCDMA V_RMC 12.2Kbps_Left Cheek_Ch4132

Communication System: WCDMA; Frequency: 826.4 MHz; Duty Cycle: 1:1

Medium: HSL_850_170912 Medium parameters used: $f = 826.4$ MHz; $\sigma = 0.89$ S/m; $\epsilon_r = 42.528$; $\rho = 1000$ kg/m³

Ambient Temperature : 23.1 °C; Liquid Temperature : 22.1 °C

DASY5 Configuration:

- Probe: ES3DV3 - SN3169; ConvF(5.99, 5.99, 5.99); Calibrated: 2017/5/11;
- Sensor-Surface: 3mm (Mechanical Surface Detection)
- Electronics: DAE4 Sn1399; Calibrated: 2016/11/17
- Phantom: SAM_Right; Type: QD000P40CD; Serial: 1884
- Measurement SW: DASY52, Version 52.8 (8); SEMCAD X Version 14.6.10 (7331)

Area Scan (61x111x1): Interpolated grid: dx=1.500 mm, dy=1.500 mm

Maximum value of SAR (interpolated) = 0.442 W/kg

Zoom Scan (5x5x7)/Cube 0: Measurement grid: dx=8mm, dy=8mm, dz=5mm

Reference Value = 22.53 V/m; Power Drift = -0.12 dB

Peak SAR (extrapolated) = 0.501 W/kg

SAR(1 g) = 0.403 W/kg; SAR(10 g) = 0.315 W/kg

Maximum value of SAR (measured) = 0.442 W/kg

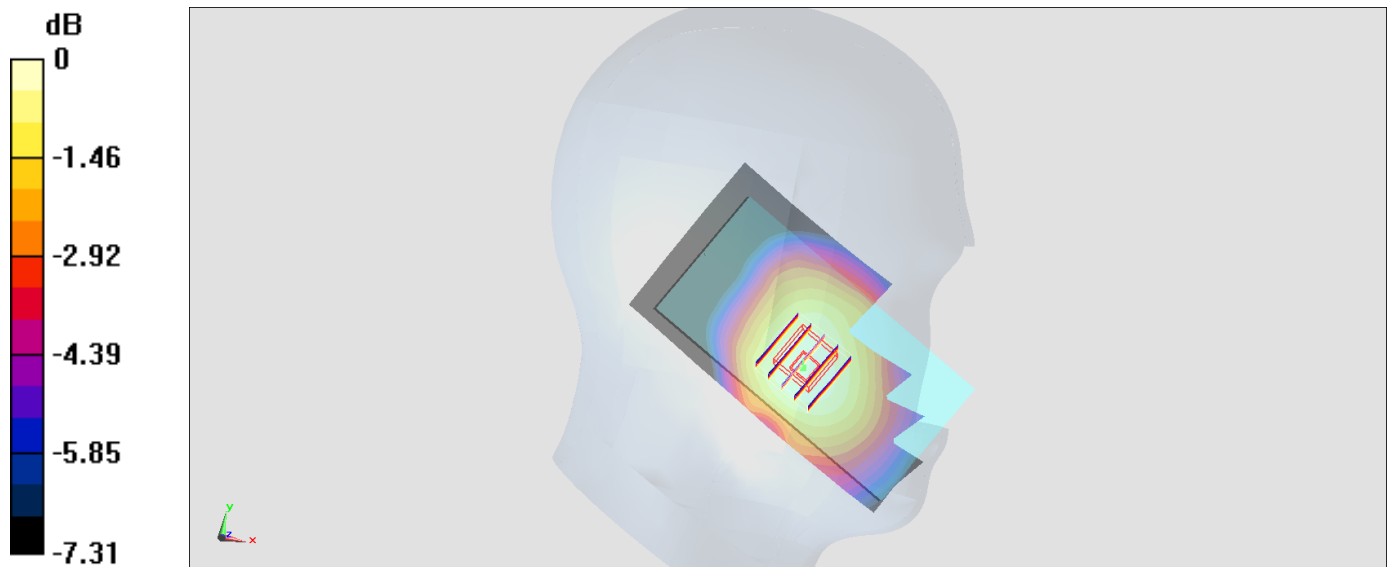

0 dB = 0.442 W/kg = -3.55 dBW/kg

#05_LTE Band 2_20M_QPSK_1_0_Left Cheek_Ch18700

Communication System: LTE; Frequency: 1860 MHz; Duty Cycle: 1:1

Medium: HSL_1900_170913 Medium parameters used: $f = 1860$ MHz; $\sigma = 1.372$ S/m; $\epsilon_r = 39.961$; $\rho = 1000$ kg/m³

Ambient Temperature : 23.7 °C; Liquid Temperature : 22.7 °C

DASY5 Configuration:

- Probe: ES3DV3 - SN3169; ConvF(5.03, 5.03, 5.03); Calibrated: 2017/5/11;
- Sensor-Surface: 3mm (Mechanical Surface Detection)
- Electronics: DAE4 Sn1399; Calibrated: 2016/11/17
- Phantom: SAM_Right; Type: QD000P40CD; Serial: 1884
- Measurement SW: DASY52, Version 52.8 (8); SEMCAD X Version 14.6.10 (7331)

Area Scan (61x111x1): Interpolated grid: dx=1.500 mm, dy=1.500 mm

Maximum value of SAR (interpolated) = 0.688 W/kg

Zoom Scan (5x5x7)/Cube 0: Measurement grid: dx=8mm, dy=8mm, dz=5mm

Reference Value = 21.53 V/m; Power Drift = 0.02 dB

Peak SAR (extrapolated) = 0.817 W/kg

SAR(1 g) = 0.575 W/kg; SAR(10 g) = 0.384 W/kg

Maximum value of SAR (measured) = 0.642 W/kg

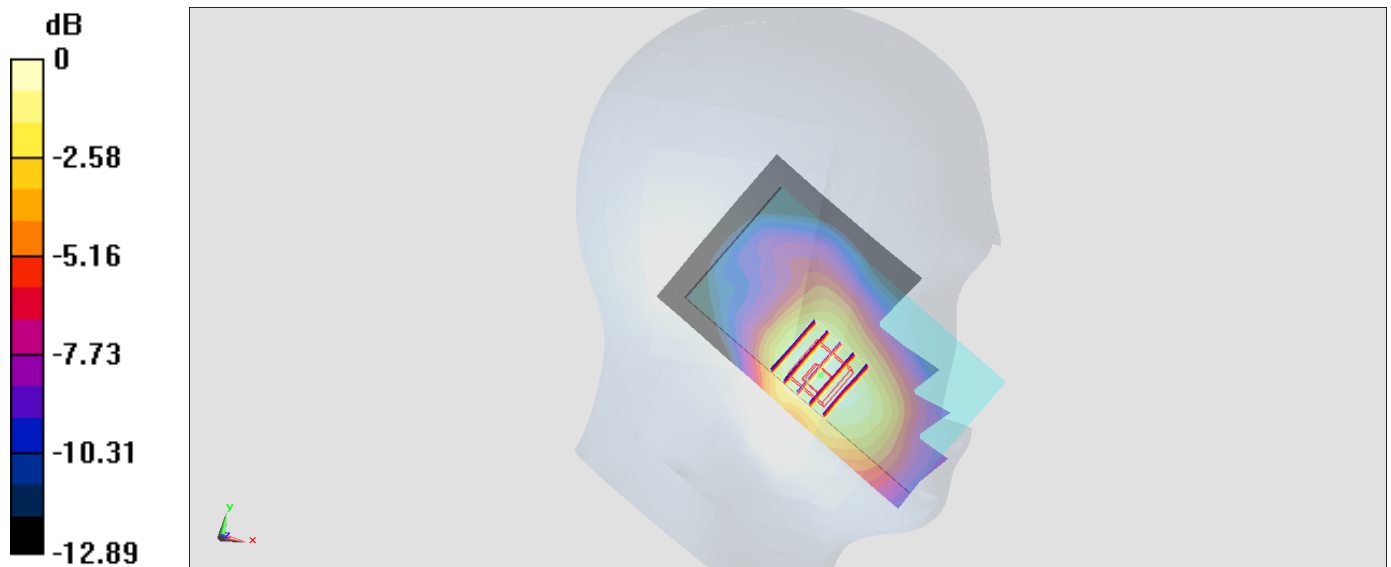

0 dB = 0.642 W/kg = -1.92 dBW/kg

#06_LTE Band 5_10M_QPSK_1_0_Left Cheek_Ch20525

Communication System: LTE ; Frequency: 836.5 MHz;Duty Cycle: 1:1

Medium: HSL_850_170912 Medium parameters used: $f = 836.5$ MHz; $\sigma = 0.899$ S/m; $\epsilon_r = 42.401$; $\rho = 1000$ kg/m³

Ambient Temperature : 23.1 °C ; Liquid Temperature : 22.1 °C

DASY5 Configuration:

- Probe: ES3DV3 - SN3169; ConvF(5.99, 5.99, 5.99); Calibrated: 2017/5/11;
- Sensor-Surface: 3mm (Mechanical Surface Detection)
- Electronics: DAE4 Sn1399; Calibrated: 2016/11/17
- Phantom: SAM_Right; Type: QD000P40CD; Serial: 1884
- Measurement SW: DASY52, Version 52.8 (8);SEMCAD X Version 14.6.10 (7331)

Area Scan (61x111x1): Interpolated grid: dx=1.500 mm, dy=1.500 mm

Maximum value of SAR (interpolated) = 0.316 W/kg

Zoom Scan (5x5x7)/Cube 0: Measurement grid: dx=8mm, dy=8mm, dz=5mm

Reference Value = 19.13 V/m; Power Drift = -0.08 dB

Peak SAR (extrapolated) = 0.363 W/kg

SAR(1 g) = 0.293 W/kg; SAR(10 g) = 0.231 W/kg

Maximum value of SAR (measured) = 0.322 W/kg

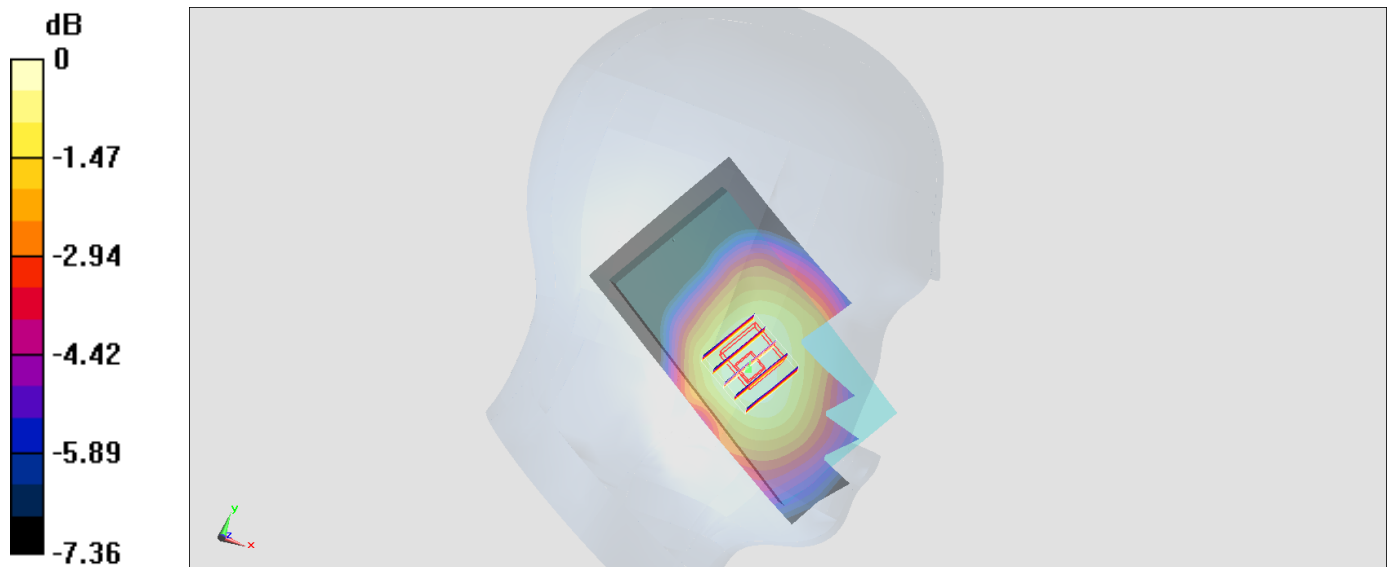

0 dB = 0.322 W/kg = -4.92 dBW/kg

#07_LTE Band 7_20M_QPSK_1_49_Right Cheek_Ch21350

Communication System: LTE ; Frequency: 2560 MHz;Duty Cycle: 1:1

Medium: HSL_2600_170913 Medium parameters used: $f = 2560$ MHz; $\sigma = 1.924$ S/m; $\epsilon_r = 39.751$; $\rho = 1000$ kg/m³

Ambient Temperature : 23.7 °C ; Liquid Temperature : 22.7 °C

DASY5 Configuration:

- Probe: ES3DV3 - SN3169; ConvF(4.47, 4.47, 4.47); Calibrated: 2017/5/11;
- Sensor-Surface: 3mm (Mechanical Surface Detection)
- Electronics: DAE4 Sn1399; Calibrated: 2016/11/17
- Phantom: SAM_Right; Type: QD000P40CD; Serial: 1884
- Measurement SW: DASY52, Version 52.8 (8);SEMCAD X Version 14.6.10 (7331)

Area Scan (71x131x1): Interpolated grid: dx=1.200 mm, dy=1.200 mm

Maximum value of SAR (interpolated) = 0.431 W/kg

Zoom Scan (7x7x7)/Cube 0: Measurement grid: dx=5mm, dy=5mm, dz=5mm

Reference Value = 6.603 V/m; Power Drift = 0.11 dB

Peak SAR (extrapolated) = 0.723 W/kg

SAR(1 g) = 0.346 W/kg; SAR(10 g) = 0.178 W/kg

Maximum value of SAR (measured) = 0.446 W/kg

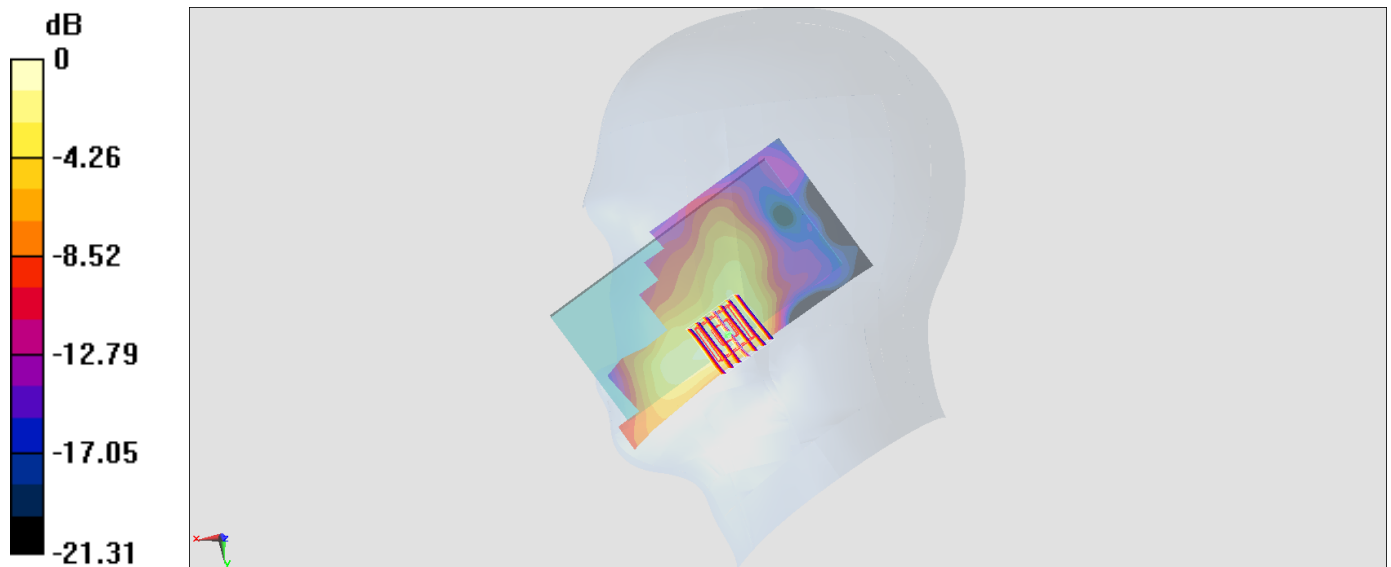

0 dB = 0.446 W/kg = -3.51 dBW/kg

#08_LTE Band 41_20M_QPSK_1_49_Right Cheek_Ch41140

Communication System: LTE; Frequency: 2645 MHz; Duty Cycle: 1:1.59

Medium: HSL_2600_170913 Medium parameters used: $f = 2645$ MHz; $\sigma = 2.023$ S/m; $\epsilon_r = 39.401$; $\rho = 1000$ kg/m³

Ambient Temperature : 23.7 °C; Liquid Temperature : 22.7 °C

DASY5 Configuration:

- Probe: ES3DV3 - SN3169; ConvF(4.47, 4.47, 4.47); Calibrated: 2017/5/11;
- Sensor-Surface: 3mm (Mechanical Surface Detection)
- Electronics: DAE4 Sn1399; Calibrated: 2016/11/17
- Phantom: SAM_Right; Type: QD000P40CD; Serial: 1884
- Measurement SW: DASY52, Version 52.8 (8); SEMCAD X Version 14.6.10 (7331)

Area Scan (81x131x1): Interpolated grid: dx=1.200 mm, dy=1.200 mm

Maximum value of SAR (interpolated) = 0.150 W/kg

Zoom Scan (7x7x7)/Cube 0: Measurement grid: dx=5mm, dy=5mm, dz=5mm

Reference Value = 5.721 V/m; Power Drift = 0.11 dB

Peak SAR (extrapolated) = 0.218 W/kg

SAR(1 g) = 0.103 W/kg; SAR(10 g) = 0.054 W/kg

Maximum value of SAR (measured) = 0.132 W/kg

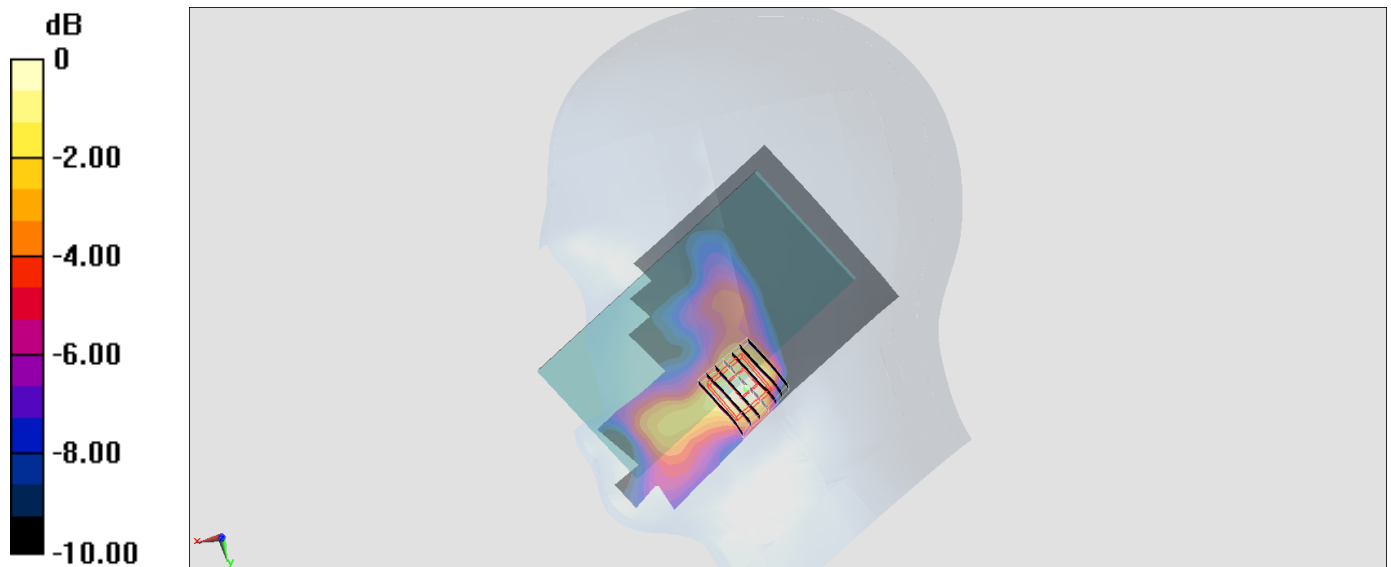

0 dB = 0.132 W/kg = -8.79 dBW/kg

#09_WLAN2.4GHz_802.11b 1Mbps_Left Cheek_Ch1

Communication System: 802.11b; Frequency: 2412 MHz; Duty Cycle: 1:1.015

Medium: HSL_2450_170917 Medium parameters used: $f = 2412$ MHz; $\sigma = 1.732$ S/m; $\epsilon_r = 38.774$; $\rho = 1000$ kg/m³

Ambient Temperature : 23.3 °C; Liquid Temperature : 22.3 °C

DASY5 Configuration

- Probe: ES3DV3 - SN3169; ConvF(4.5, 4.5, 4.5); Calibrated: 2017/5/11;
- Sensor-Surface: 3mm (Mechanical Surface Detection)
- Electronics: DAE4 Sn1399; Calibrated: 2016/11/17
- Phantom: SAM_RIGHT; Type: QD000P40CD; Serial: 1719
- Measurement SW: DASY52, Version 52.8 (8); SEMCAD X Version 14.6.10 (7373)

Area Scan (71x131x1): Interpolated grid: dx=1.200 mm, dy=1.200 mm

Maximum value of SAR (interpolated) = 1.42 W/kg

Zoom Scan (7x7x7)/Cube 0: Measurement grid: dx=5mm, dy=5mm, dz=5mm

Reference Value = 22.86 V/m; Power Drift = 0.11 dB

Peak SAR (extrapolated) = 2.05 W/kg

SAR(1 g) = 0.749 W/kg; SAR(10 g) = 0.367 W/kg

Maximum value of SAR (measured) = 1.08 W/kg

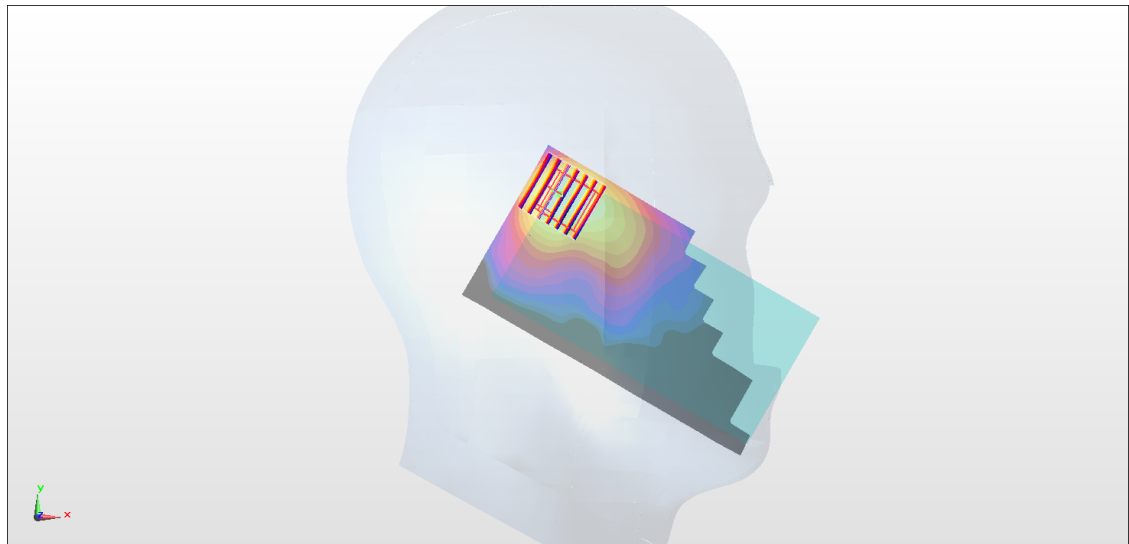
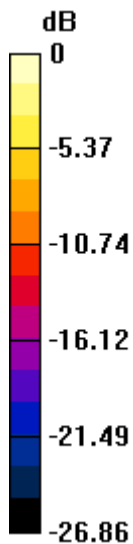

0 dB = 1.08 W/kg = 0.33 dBW/kg

#10_WLAN5GHz_802.11a_6Mbps_Left Cheek_Ch64

Communication System: U802.11a; Frequency: 5320 MHz; Duty Cycle: 1:1.069

Medium: HSL_5G_170918 Medium parameters used: $f = 5320$ MHz; $\sigma = 4.575$ S/m; $\epsilon_r = 35.473$; $\rho = 1000$ kg/m³

Ambient Temperature : 23.8 °C; Liquid Temperature : 22.8 °C

DASY5 Configuration:

- Probe: EX3DV4 - SN3873; ConvF(5.04, 5.04, 5.04); Calibrated: 2017/8/25;
- Sensor-Surface: 1.4mm (Mechanical Surface Detection)
- Electronics: DAE4 Sn916; Calibrated: 2016/12/15
- Phantom: SAM_Right; Type: QD000P40CD; Serial: 1884
- Measurement SW: DASY52, Version 52.8 (8); SEMCAD X Version 14.6.10 (7331)

Area Scan (91x101x1): Interpolated grid: dx=1.000 mm, dy=1.000 mm

Maximum value of SAR (interpolated) = 1.01 W/kg

Zoom Scan (7x7x7)/Cube 0: Measurement grid: dx=4mm, dy=4mm, dz=1.4mm

Reference Value = 15.34 V/m; Power Drift = 0.04 dB

Peak SAR (extrapolated) = 1.53 W/kg

SAR(1 g) = 0.377 W/kg; SAR(10 g) = 0.117 W/kg

Maximum value of SAR (measured) = 0.935 W/kg

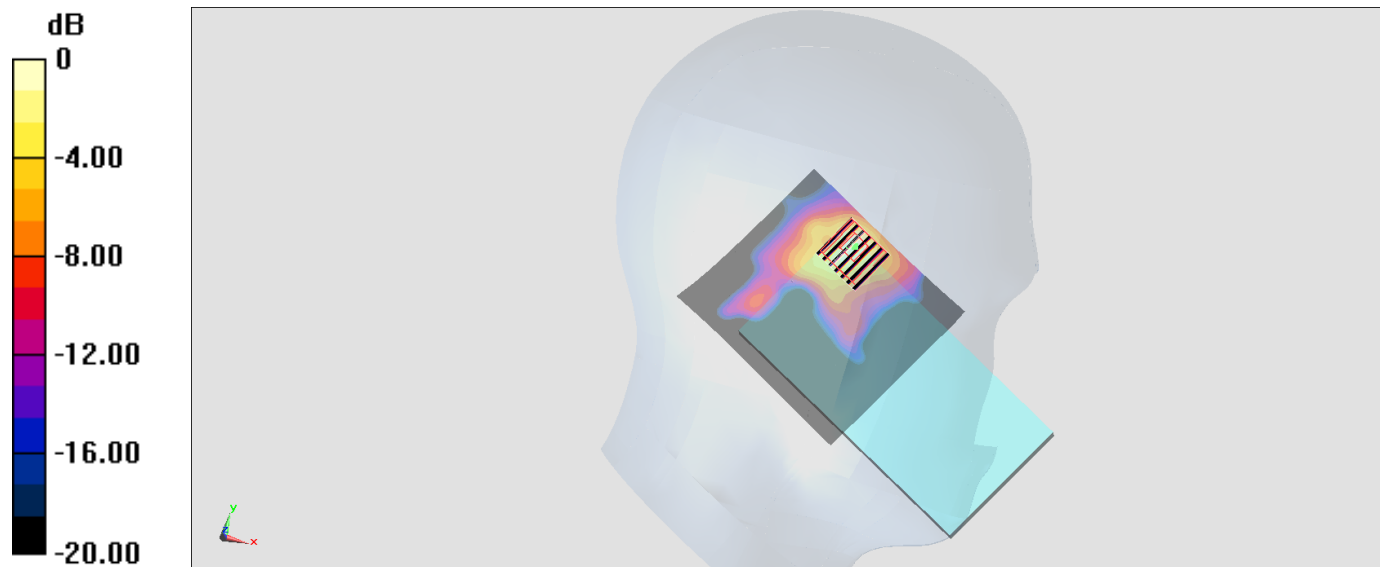

0 dB = 0.935 W/kg = -0.29 dBW/kg

#11_WLAN5GHz_802.11a 6Mbps_Left Cheek_Ch100

Communication System: 802.11a; Frequency: 5500 MHz; Duty Cycle: 1:1.069

Medium: HSL_5G_170918 Medium parameters used: $f = 5500$ MHz; $\sigma = 4.744$ S/m; $\epsilon_r = 35.237$; $\rho = 1000$ kg/m³

Ambient Temperature : 23.8 °C; Liquid Temperature : 22.8 °C

DASY5 Configuration:

- Probe: EX3DV4 - SN3873; ConvF(4.66, 4.66, 4.66); Calibrated: 2017/8/25;
- Sensor-Surface: 1.4mm (Mechanical Surface Detection)
- Electronics: DAE4 Sn916; Calibrated: 2016/12/15
- Phantom: SAM_Right; Type: QD000P40CD; Serial: 1884
- Measurement SW: DASY52, Version 52.8 (8); SEMCAD X Version 14.6.10 (7331)

Area Scan (91x101x1): Interpolated grid: dx=1.000 mm, dy=1.000 mm

Maximum value of SAR (interpolated) = 1.14 W/kg

Zoom Scan (7x7x7)/Cube 0: Measurement grid: dx=4mm, dy=4mm, dz=1.4mm

Reference Value = 13.39 V/m; Power Drift = -0.05 dB

Peak SAR (extrapolated) = 1.85 W/kg

SAR(1 g) = 0.464 W/kg; SAR(10 g) = 0.143 W/kg

Maximum value of SAR (measured) = 1.13 W/kg

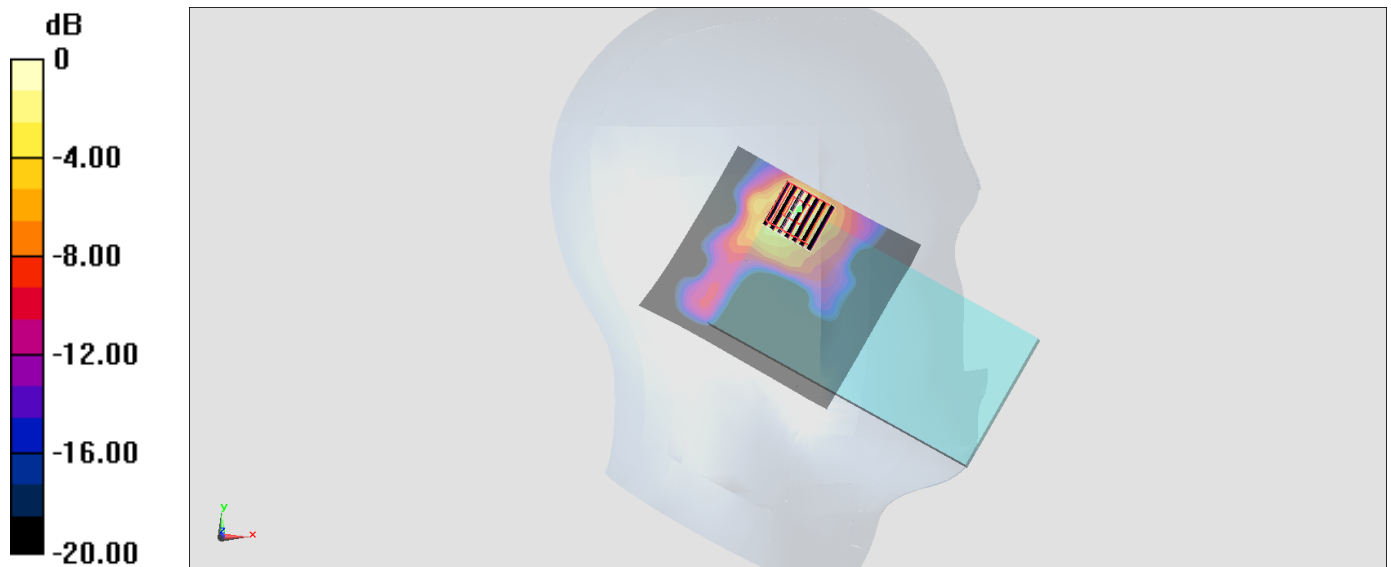

0 dB = 1.13 W/kg = 0.53 dBW/kg

#12_WLAN5GHz_802.11a 6Mbps_Left Cheek_Ch165

Communication System: 802.11a; Frequency: 5825 MHz; Duty Cycle: 1:1.069

Medium: HSL_5G_170918 Medium parameters used: $f = 5825$ MHz; $\sigma = 5.068$ S/m; $\epsilon_r = 34.815$; $\rho = 1000$ kg/m³

Ambient Temperature : 23.8 °C; Liquid Temperature : 22.8 °C

DASY5 Configuration:

- Probe: EX3DV4 - SN3873; ConvF(4.7, 4.7, 4.7); Calibrated: 2017/8/25;
- Sensor-Surface: 1.4mm (Mechanical Surface Detection)
- Electronics: DAE4 Sn916; Calibrated: 2016/12/15
- Phantom: SAM_Right; Type: QD000P40CD; Serial: 1884
- Measurement SW: DASY52, Version 52.8 (8); SEMCAD X Version 14.6.10 (7331)

Area Scan (91x101x1): Interpolated grid: dx=1.000 mm, dy=1.000 mm

Maximum value of SAR (interpolated) = 0.944 W/kg

Zoom Scan (7x7x7)/Cube 0: Measurement grid: dx=4mm, dy=4mm, dz=1.4mm

Reference Value = 9.910 V/m; Power Drift = -0.04 dB

Peak SAR (extrapolated) = 1.78 W/kg

SAR(1 g) = 0.379 W/kg; SAR(10 g) = 0.128 W/kg

Maximum value of SAR (measured) = 0.983 W/kg

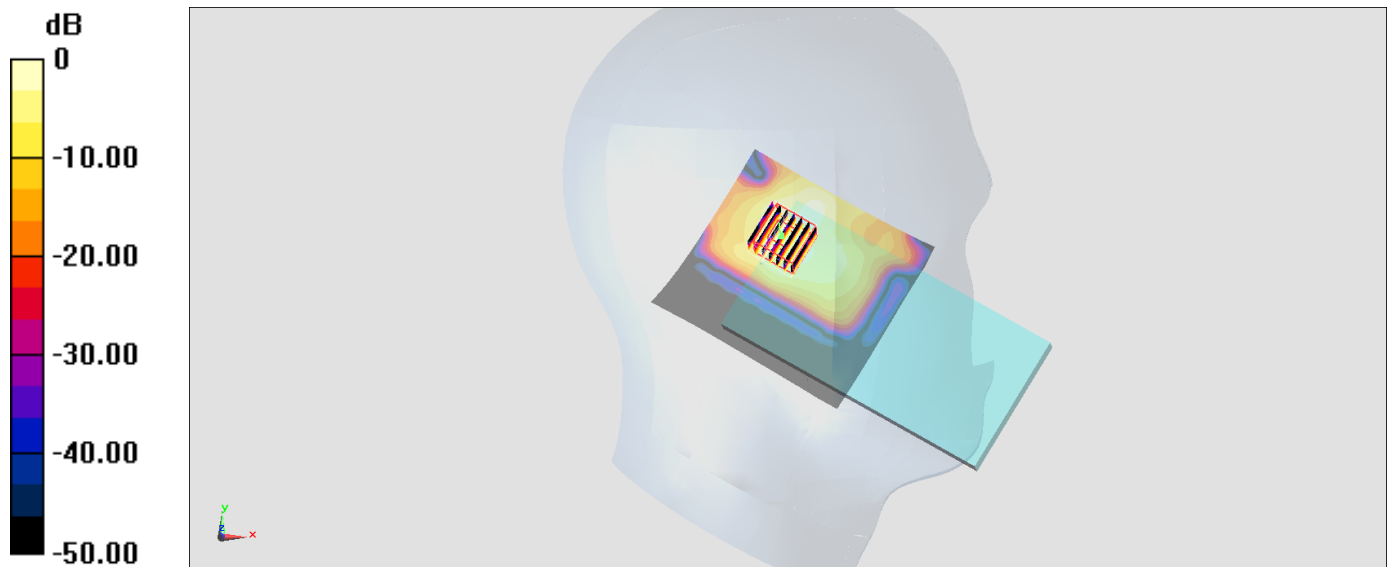

0 dB = 0.983 W/kg = -0.07 dBW/kg

#13_Bluetooth_1Mbps_Left Cheek_Ch0

Communication System: Bluetooth; Frequency: 2402 MHz; Duty Cycle: 1:1.297

Medium: HSL_2450_170919 Medium parameters used: $f = 2402$ MHz; $\sigma = 1.715$ S/m; $\epsilon_r = 38.693$; $\rho = 1000$ kg/m³

Ambient Temperature : 23.2 °C; Liquid Temperature : 22.2 °C

DASY5 Configuration:

- Probe: ES3DV3 - SN3071; ConvF(4.18, 4.18, 4.18); Calibrated: 2016/12/8;
- Sensor-Surface: 3mm (Mechanical Surface Detection)
- Electronics: DAE4 Sn778; Calibrated: 2017/5/22
- Phantom: SAM-Left; Type: QD 000 P40 C; Serial: TP-1446
- Measurement SW: DASY52, Version 52.8 (8); SEMCAD X Version 14.6.10 (7331)

Area Scan (81x81x1): Interpolated grid: dx=1.200 mm, dy=1.200 mm

Maximum value of SAR (interpolated) = 0.148 W/kg

Zoom Scan (7x7x7)/Cube 0: Measurement grid: dx=5mm, dy=5mm, dz=5mm

Reference Value = 8.664 V/m; Power Drift = 0.12 dB

Peak SAR (extrapolated) = 0.378 W/kg

SAR(1 g) = 0.145 W/kg; SAR(10 g) = 0.065 W/kg

Maximum value of SAR (measured) = 0.213 W/kg

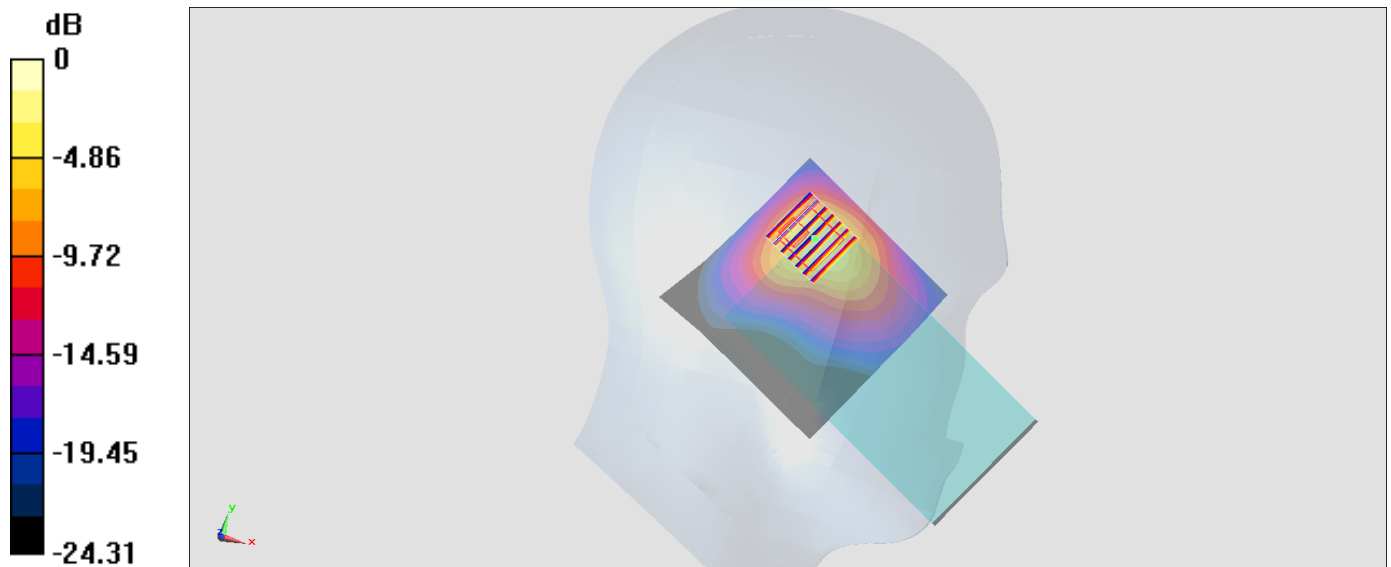

0 dB = 0.213 W/kg = -6.72 dBW/kg

#14_GSM850_GPRS (4 Tx slots)_Right Side_10mm_Ch128

Communication System: GSM850; Frequency: 824.2 MHz; Duty Cycle: 1:2.08

Medium: MSL_850_170911 Medium parameters used : $f = 824.2$ MHz; $\sigma = 0.988$ S/m; $\epsilon_r = 57.396$; $\rho = 1000$ kg/m³

Ambient Temperature : 23.1 °C; Liquid Temperature : 22.1 °C

DASY5 Configuration:

- Probe: ES3DV3 - SN3169; ConvF(6.05, 6.05, 6.05); Calibrated: 2017/5/11;
- Sensor-Surface: 3mm (Mechanical Surface Detection)
- Electronics: DAE4 Sn1399; Calibrated: 2016/11/17
- Phantom: SAM-Left; Type: QD 000 P40 C; Serial: TP-1446
- Measurement SW: DASY52, Version 52.8 (8); SEMCAD X Version 14.6.10 (7331)

Area Scan (41x121x1): Interpolated grid: dx=1.500 mm, dy=1.500 mm

Maximum value of SAR (interpolated) = 0.437 W/kg

Zoom Scan (5x5x7)/Cube 0: Measurement grid: dx=8mm, dy=8mm, dz=5mm

Reference Value = 22.11 V/m; Power Drift = 0.07 dB

Peak SAR (extrapolated) = 0.551 W/kg

SAR(1 g) = 0.397 W/kg; SAR(10 g) = 0.275 W/kg

Maximum value of SAR (measured) = 0.453 W/kg

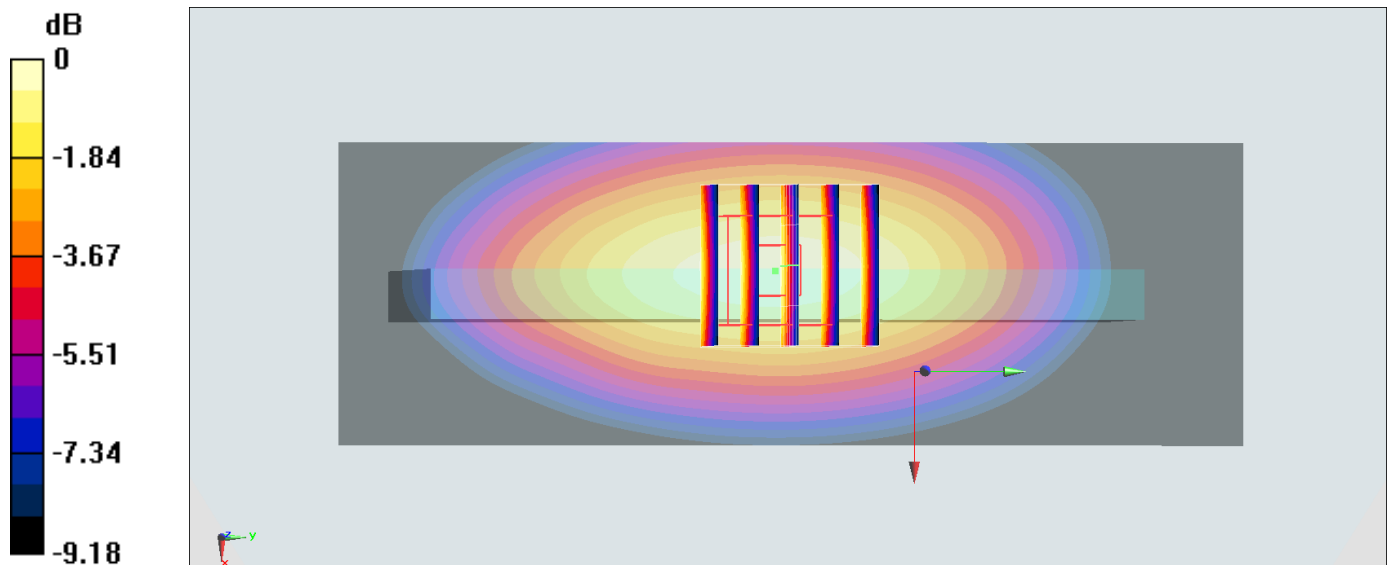

0 dB = 0.453 W/kg = -3.44 dBW/kg

#15_GSM1900_GPRS (4 Tx slots)_Bottom Side_10mm_Ch810

Communication System: PCS ; Frequency: 1909.8 MHz; Duty Cycle: 1:2.08

Medium: MSL_1900_170929 Medium parameters used: $f = 1910$ MHz; $\sigma = 1.576$ S/m; $\epsilon_r = 55.261$; $\rho = 1000$ kg/m³

Ambient Temperature : 23.4 °C; Liquid Temperature : 22.4 °C

DASY5 Configuration

- Probe: EX3DV4 - SN3976; ConvF(8.31, 8.31, 8.31); Calibrated: 2017/2/21;
- Sensor-Surface: 1.4mm (Mechanical Surface Detection)
- Electronics: DAE4 Sn1424; Calibrated: 2017/2/16
- Phantom: SAM_Right; Type: QD000P40CD; Serial: S/N:1801
- Measurement SW: DASY52, Version 52.8 (8); SEMCAD X Version 14.6.10 (7373)

Area Scan (41x81x1): Interpolated grid: dx=1.500 mm, dy=1.500 mm

Maximum value of SAR (interpolated) = 0.712 W/kg

Zoom Scan (5x5x7)/Cube 0: Measurement grid: dx=8mm, dy=8mm, dz=5mm

Reference Value = 22.00 V/m; Power Drift = -0.17 dB

Peak SAR (extrapolated) = 0.822 W/kg

SAR(1 g) = 0.482 W/kg; SAR(10 g) = 0.262 W/kg

Maximum value of SAR (measured) = 0.676 W/kg

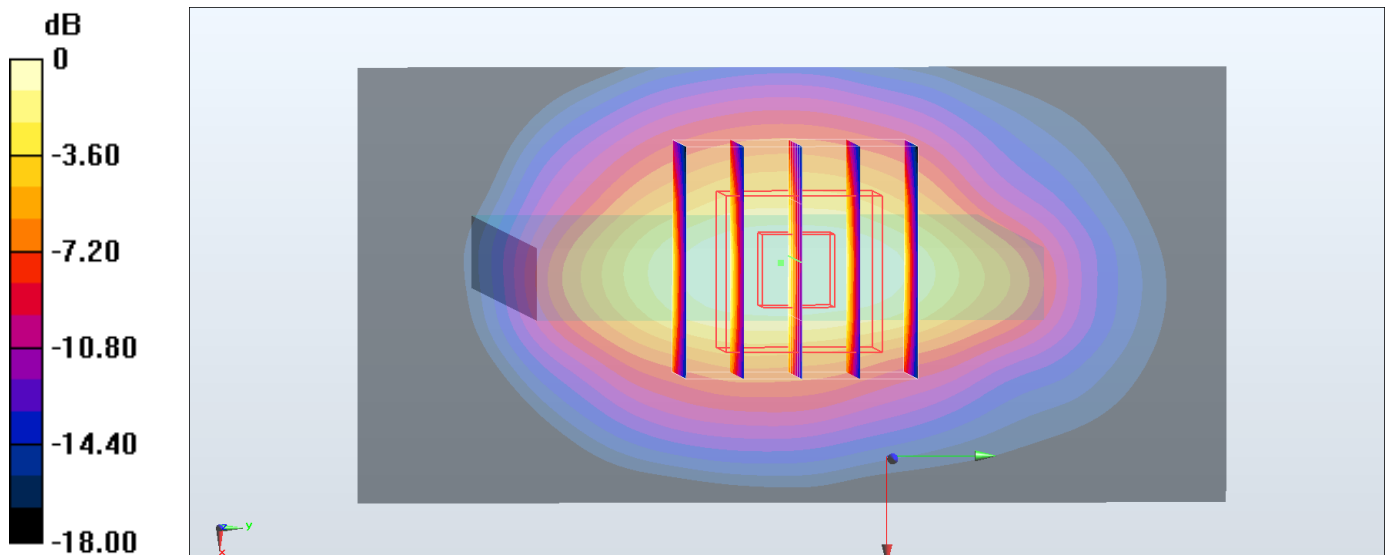

0 dB = 0.676 W/kg = -1.70 dBW/kg

#16_WCDMA II_RMC 12.2Kbps_Bottom Side_10mm_Ch9262

Communication System: WCDMA ; Frequency: 1852.4 MHz;Duty Cycle: 1:1

Medium: MSL_1900_170915 Medium parameters used: $f = 1852.4$ MHz; $\sigma = 1.511$ S/m; $\epsilon_r = 54.447$;

$\rho = 1000$ kg/m³

Ambient Temperature : 23.3 °C ; Liquid Temperature : 22.3 °C

DASY5 Configuration

- Probe: ES3DV3 - SN3071; ConvF(4.23, 4.23, 4.23); Calibrated: 2016/12/8;
- Sensor-Surface: 3mm (Mechanical Surface Detection)
- Electronics: DAE4 Sn778; Calibrated: 2017/5/22
- Phantom: SAM_Right; Type: QD000P40CD; Serial: S/N:1801
- Measurement SW: DASY52, Version 52.8 (8); SEMCAD X Version 14.6.10 (7373)

Area Scan (41x81x1): Interpolated grid: dx=1.500 mm, dy=1.500 mm

Maximum value of SAR (interpolated) = 1.20 W/kg

Zoom Scan (5x5x7)/Cube 0: Measurement grid: dx=8mm, dy=8mm, dz=5mm

Reference Value = 27.55 V/m; Power Drift = 0.08 dB

Peak SAR (extrapolated) = 1.55 W/kg

SAR(1 g) = 0.925 W/kg; SAR(10 g) = 0.501 W/kg

Maximum value of SAR (measured) = 1.13 W/kg

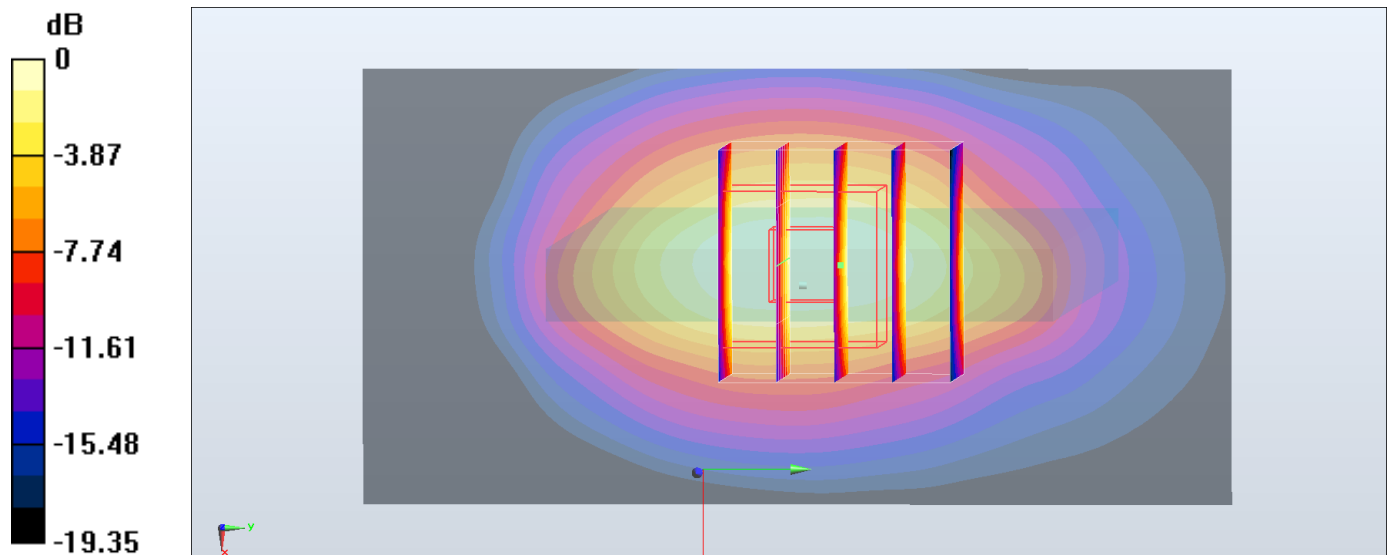

0 dB = 1.13 W/kg = 0.53 dBW/kg

#17_WCDMA V_RMC 12.2Kbps_Left Side_10mm_Ch4132

Communication System: WCDMA; Frequency: 826.4 MHz; Duty Cycle: 1:1

Medium: MSL_850_170911 Medium parameters used: $f = 826.4$ MHz; $\sigma = 0.99$ S/m; $\epsilon_r = 57.376$; $\rho = 1000$ kg/m³

Ambient Temperature : 23.1 °C; Liquid Temperature : 22.1 °C

DASY5 Configuration:

- Probe: ES3DV3 - SN3169; ConvF(6.05, 6.05, 6.05); Calibrated: 2017/5/11;
- Sensor-Surface: 3mm (Mechanical Surface Detection)
- Electronics: DAE4 Sn1399; Calibrated: 2016/11/17
- Phantom: SAM-Left; Type: QD 000 P40 C; Serial: TP-1446
- Measurement SW: DASY52, Version 52.8 (8); SEMCAD X Version 14.6.10 (7331)

Area Scan (41x121x1): Interpolated grid: dx=1.500 mm, dy=1.500 mm

Maximum value of SAR (interpolated) = 0.592 W/kg

Zoom Scan (5x5x7)/Cube 0: Measurement grid: dx=8mm, dy=8mm, dz=5mm

Reference Value = 25.64 V/m; Power Drift = -0.07 dB

Peak SAR (extrapolated) = 0.720 W/kg

SAR(1 g) = 0.522 W/kg; SAR(10 g) = 0.362 W/kg

Maximum value of SAR (measured) = 0.596 W/kg

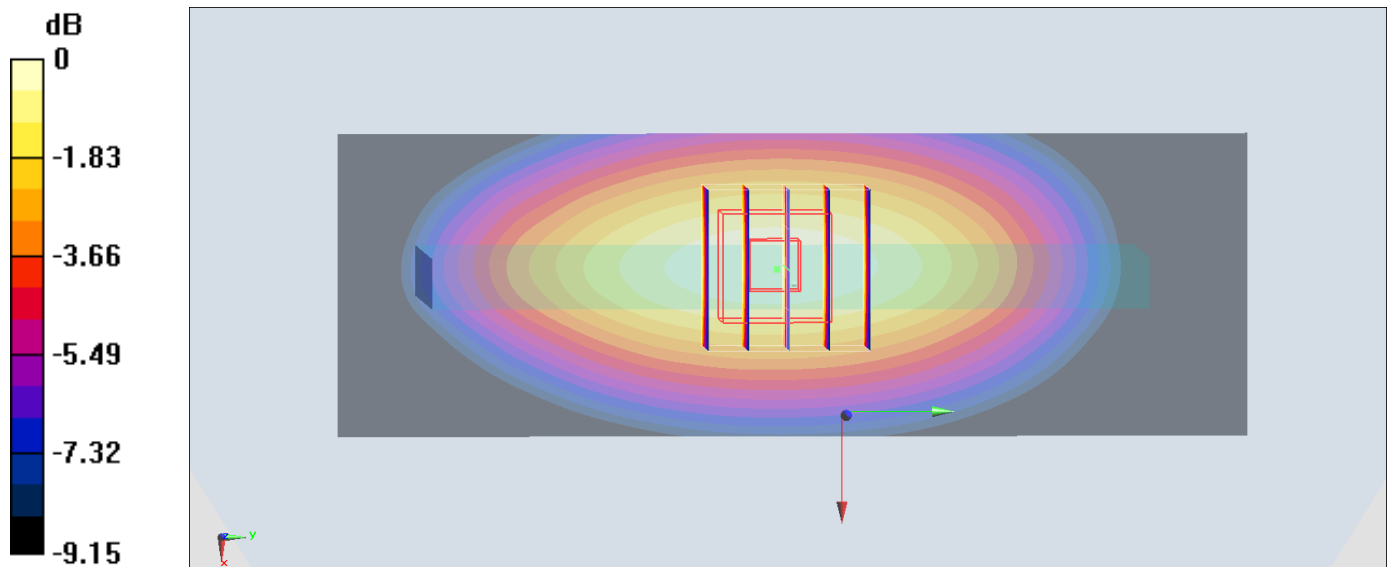

0 dB = 0.596 W/kg = -2.25 dBW/kg

#18_LTE Band 2_20M_QPSK_50_0_Bottom Side_10mm_Ch18700

Communication System: LTE ; Frequency: 1860 MHz;Duty Cycle: 1:1

Medium: MSL_1900_170915 Medium parameters used: $f = 1860$ MHz; $\sigma = 1.521$ S/m; $\epsilon_r = 54.444$; $\rho = 1000$ kg/m³

Ambient Temperature : 23.3 °C ; Liquid Temperature : 22.3 °C

DASY5 Configuration

- Probe: ES3DV3 - SN3071; ConvF(4.23, 4.23, 4.23); Calibrated: 2016/12/8;
- Sensor-Surface: 3mm (Mechanical Surface Detection)
- Electronics: DAE4 Sn778; Calibrated: 2017/5/22
- Phantom: SAM_Right; Type: QD000P40CD; Serial: S/N:1801
- Measurement SW: DASY52, Version 52.8 (8); SEMCAD X Version 14.6.10 (7373)

Area Scan (41x61x1): Interpolated grid: $dx=1.500$ mm, $dy=1.500$ mm

Maximum value of SAR (interpolated) = 1.20 W/kg

Zoom Scan (5x5x7)/Cube 0: Measurement grid: $dx=8$ mm, $dy=8$ mm, $dz=5$ mm

Reference Value = 27.11 V/m; Power Drift = 0.07 dB

Peak SAR (extrapolated) = 1.51 W/kg

SAR(1 g) = 0.896 W/kg; SAR(10 g) = 0.486 W/kg

Maximum value of SAR (measured) = 1.08 W/kg

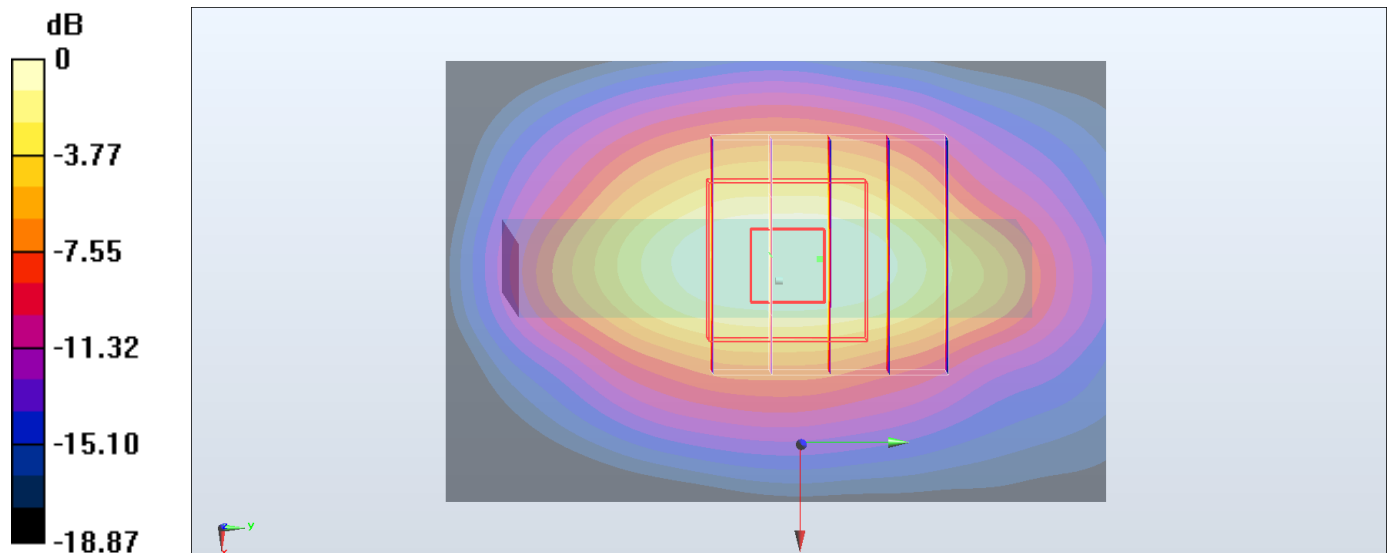

0 dB = 1.08 W/kg = 0.33 dBW/kg

#19_LTE Band 5_10M_QPSK_1_0_Right Side_10mm_Ch20525

Communication System: LTE ; Frequency: 836.5 MHz;Duty Cycle: 1:1

Medium: MSL_850_170911 Medium parameters used: $f = 836.5$ MHz; $\sigma = 1$ S/m; $\epsilon_r = 57.285$; $\rho = 1000$ kg/m³

Ambient Temperature : 23.1 °C ; Liquid Temperature : 22.1 °C

DASY5 Configuration:

- Probe: ES3DV3 - SN3169; ConvF(6.05, 6.05, 6.05); Calibrated: 2017/5/11;
- Sensor-Surface: 3mm (Mechanical Surface Detection)
- Electronics: DAE4 Sn1399; Calibrated: 2016/11/17
- Phantom: SAM-Left; Type: QD 000 P40 C; Serial: TP-1446
- Measurement SW: DASY52, Version 52.8 (8);SEMCAD X Version 14.6.10 (7331)

Area Scan (41x121x1): Interpolated grid: dx=1.500 mm, dy=1.500 mm

Maximum value of SAR (interpolated) = 0.478 W/kg

Zoom Scan (5x5x7)/Cube 0: Measurement grid: dx=8mm, dy=8mm, dz=5mm

Reference Value = 22.74 V/m; Power Drift = 0.02 dB

Peak SAR (extrapolated) = 0.582 W/kg

SAR(1 g) = 0.425 W/kg; SAR(10 g) = 0.334 W/kg

Maximum value of SAR (measured) = 0.486 W/kg

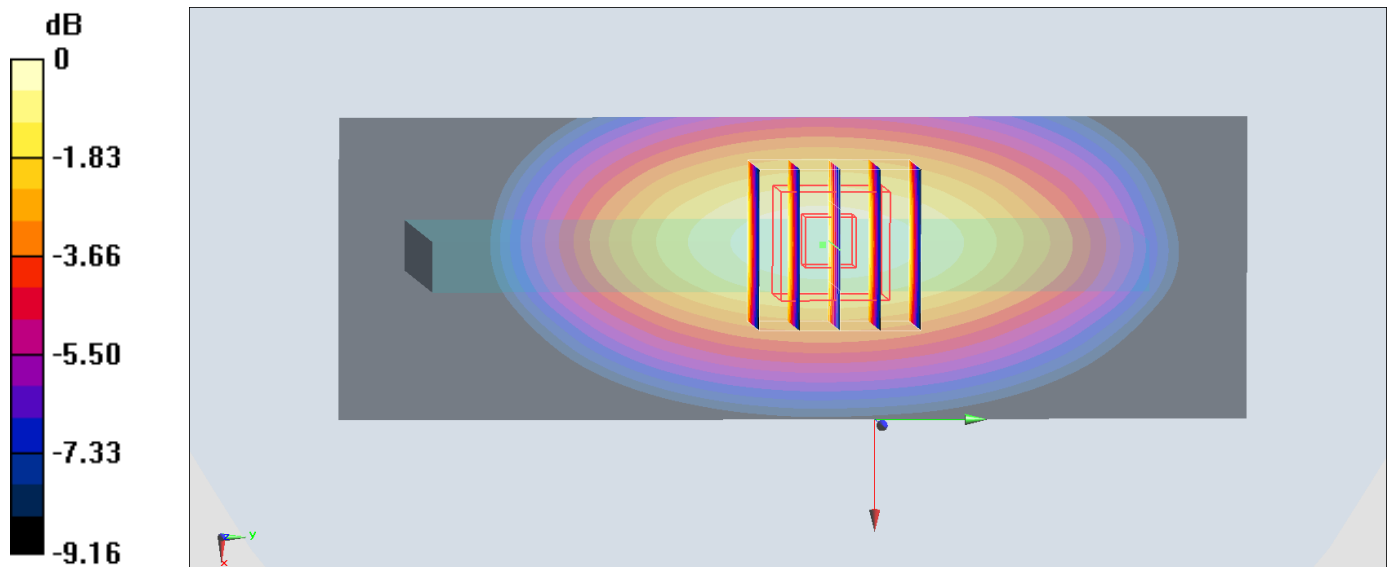

0 dB = 0.486 W/kg = -3.13 dBW/kg

#20_LTE Band 7_20M_QPSK_1_49_Back_10mm_Ch21100

Communication System: LTE; Frequency: 2535 MHz; Duty Cycle: 1:1

Medium: MSL_2600_170914 Medium parameters used: $f = 2535$ MHz; $\sigma = 2.116$ S/m; $\epsilon_r = 53.542$; $\rho = 1000$ kg/m³

Ambient Temperature : 23.5 °C; Liquid Temperature : 22.5 °C

DASY5 Configuration:

- Probe: ES3DV3 - SN3169; ConvF(4.17, 4.17, 4.17); Calibrated: 2017/5/11;
- Sensor-Surface: 3mm (Mechanical Surface Detection)
- Electronics: DAE4 Sn1399; Calibrated: 2016/11/17
- Phantom: SAM-Left; Type: QD 000 P40 C; Serial: TP-1446
- Measurement SW: DASY52, Version 52.8 (8); SEMCAD X Version 14.6.10 (7331)

Area Scan (91x91x1): Interpolated grid: dx=1.200 mm, dy=1.200 mm

Maximum value of SAR (interpolated) = 1.04 W/kg

Zoom Scan (7x7x7)/Cube 0: Measurement grid: dx=5mm, dy=5mm, dz=5mm

Reference Value = 19.48 V/m; Power Drift = 0.15 dB

Peak SAR (extrapolated) = 1.68 W/kg

SAR(1 g) = 0.859 W/kg; SAR(10 g) = 0.445 W/kg

Maximum value of SAR (measured) = 1.09 W/kg

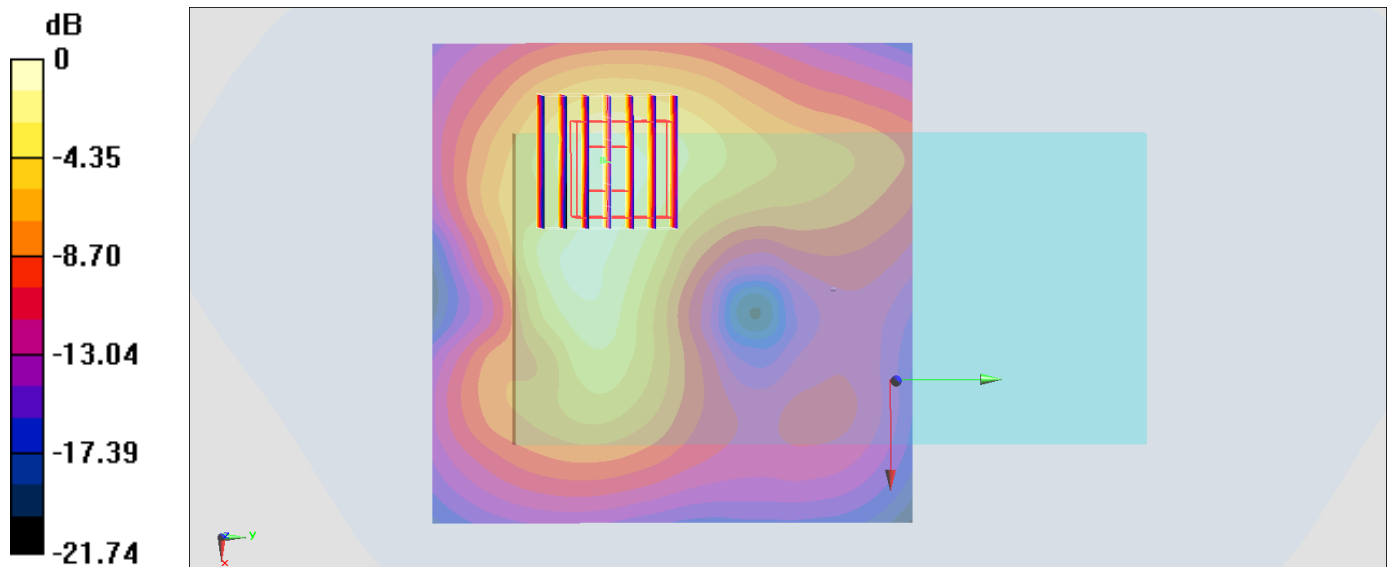

0 dB = 1.09 W/kg = 0.37 dBW/kg

#21_LTE Band 41_20M_QPSK_1_49_Back_10mm_Ch41140

Communication System: LTE; Frequency: 2645 MHz; Duty Cycle: 1:1.59

Medium: MSL_2600_170914 Medium parameters used : $f = 2645$ MHz; $\sigma = 2.268$ S/m; $\epsilon_r = 53.145$;

$\rho = 1000$ kg/m³

Ambient Temperature : 23.5 °C; Liquid Temperature : 22.5 °C

DASY5 Configuration:

- Probe: ES3DV3 - SN3169; ConvF(4.17, 4.17, 4.17); Calibrated: 2017/5/11;
- Sensor-Surface: 3mm (Mechanical Surface Detection)
- Electronics: DAE4 Sn1399; Calibrated: 2016/11/17
- Phantom: SAM-Left; Type: QD 000 P40 C; Serial: TP-1446
- Measurement SW: DASY52, Version 52.8 (8); SEMCAD X Version 14.6.10 (7331)

Area Scan (91x91x1): Interpolated grid: dx=1.200 mm, dy=1.200 mm

Maximum value of SAR (interpolated) = 0.610 W/kg

Zoom Scan (7x7x7)/Cube 0: Measurement grid: dx=5mm, dy=5mm, dz=5mm

Reference Value = 17.41 V/m; Power Drift = 0.01 dB

Peak SAR (extrapolated) = 1.01 W/kg

SAR(1 g) = 0.488 W/kg; SAR(10 g) = 0.235 W/kg

Maximum value of SAR (measured) = 0.633 W/kg

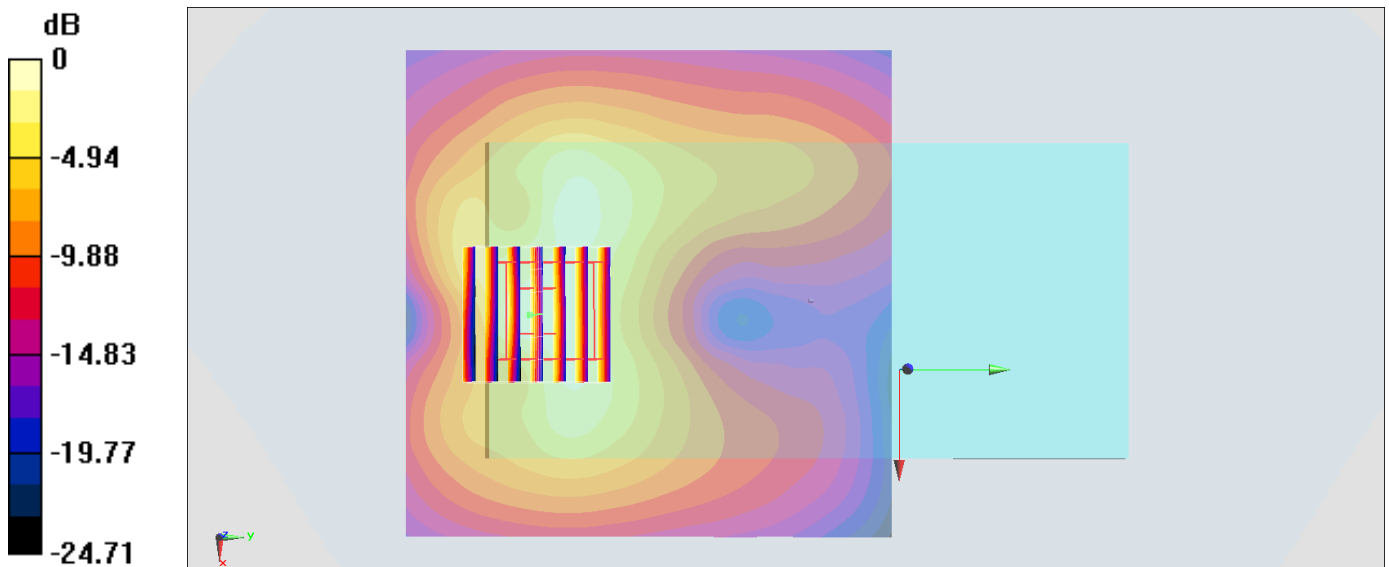

0 dB = 0.633 W/kg = -1.99 dBW/kg

#22_WLAN2.4GHz_802.11b 1Mbps_Back_10mm_Ch1

Communication System: 802.11b; Frequency: 2412 MHz; Duty Cycle: 1:1.015

Medium: MSL2450_170918 Medium parameters used: $f = 2412$ MHz; $\sigma = 1.939$ S/m; $\epsilon_r = 54.197$; $\rho = 1000$ kg/m³

Ambient Temperature : 23.9 °C; Liquid Temperature : 22.9 °C

DASY5 Configuration

- Probe: ES3DV3 - SN3169; ConvF(4.28, 4.28, 4.28); Calibrated: 2017/5/11;
- Sensor-Surface: 3mm (Mechanical Surface Detection)
- Electronics: DAE4 Sn1399; Calibrated: 2016/11/17
- Phantom: SAM_RIGHT; Type: QD000P40CD; Serial: 1719
- Measurement SW: DASY52, Version 52.8 (8); SEMCAD X Version 14.6.10 (7373)

Area Scan (91x91x1): Interpolated grid: dx=1.200 mm, dy=1.200 mm

Maximum value of SAR (interpolated) = 0.204 W/kg

Zoom Scan (7x7x7)/Cube 0: Measurement grid: dx=5mm, dy=5mm, dz=5mm

Reference Value = 9.505 V/m; Power Drift = 0.09 dB

Peak SAR (extrapolated) = 0.370 W/kg

SAR(1 g) = 0.168 W/kg; SAR(10 g) = 0.072 W/kg

Maximum value of SAR (measured) = 0.217 W/kg

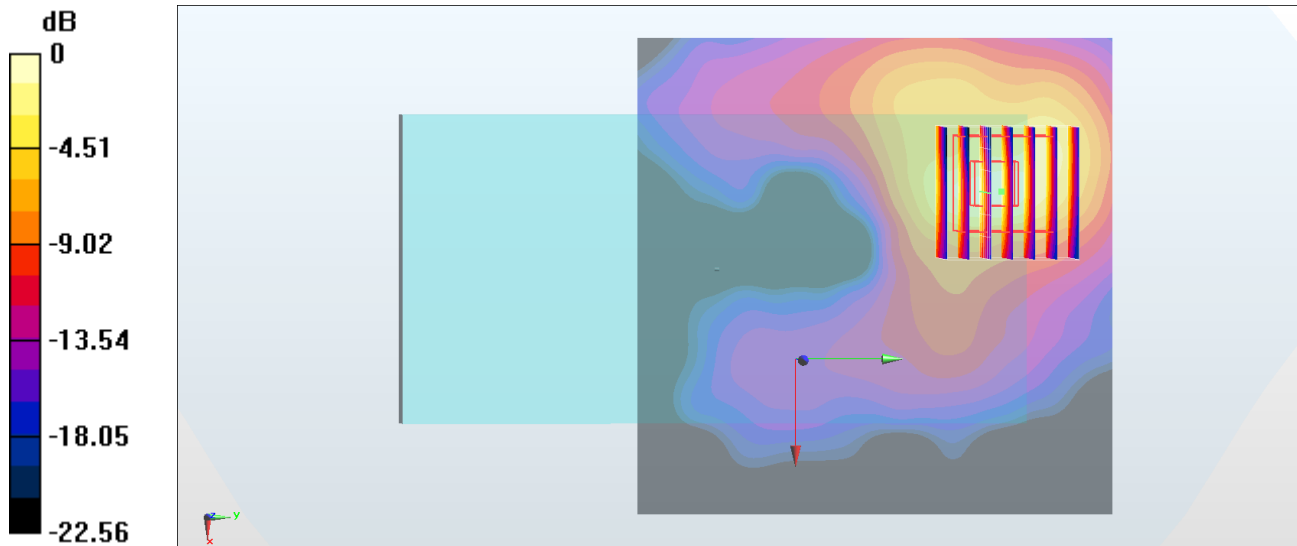

0 dB = 0.217 W/kg = -6.64 dBW/kg

#23_Bluetooth_1Mbps_Back_10mm_Ch0

Communication System: Bluetooth; Frequency: 2402 MHz; Duty Cycle: 1:1.297

Medium: MSL_2450_170919 Medium parameters used: $f = 2402$ MHz; $\sigma = 1.92$ S/m; $\epsilon_r = 54.116$; $\rho = 1000$ kg/m³

Ambient Temperature : 23.2 °C; Liquid Temperature : 22.2 °C

DASY5 Configuration:

- Probe: ES3DV3 - SN3071; ConvF(3.88, 3.88, 3.88); Calibrated: 2016/12/8;
- Sensor-Surface: 3mm (Mechanical Surface Detection)
- Electronics: DAE4 Sn778; Calibrated: 2017/5/22
- Phantom: SAM-Left; Type: QD 000 P40 C; Serial: TP-1446
- Measurement SW: DASY52, Version 52.8 (8); SEMCAD X Version 14.6.10 (7331)

Area Scan (91x91x1): Interpolated grid: dx=1.200 mm, dy=1.200 mm

Maximum value of SAR (interpolated) = 0.0360 W/kg

Zoom Scan (7x7x7)/Cube 0: Measurement grid: dx=5mm, dy=5mm, dz=5mm

Reference Value = 4.532 V/m; Power Drift = -0.01 dB

Peak SAR (extrapolated) = 0.0570 W/kg

SAR(1 g) = 0.027 W/kg; SAR(10 g) = 0.013 W/kg

Maximum value of SAR (measured) = 0.0350 W/kg

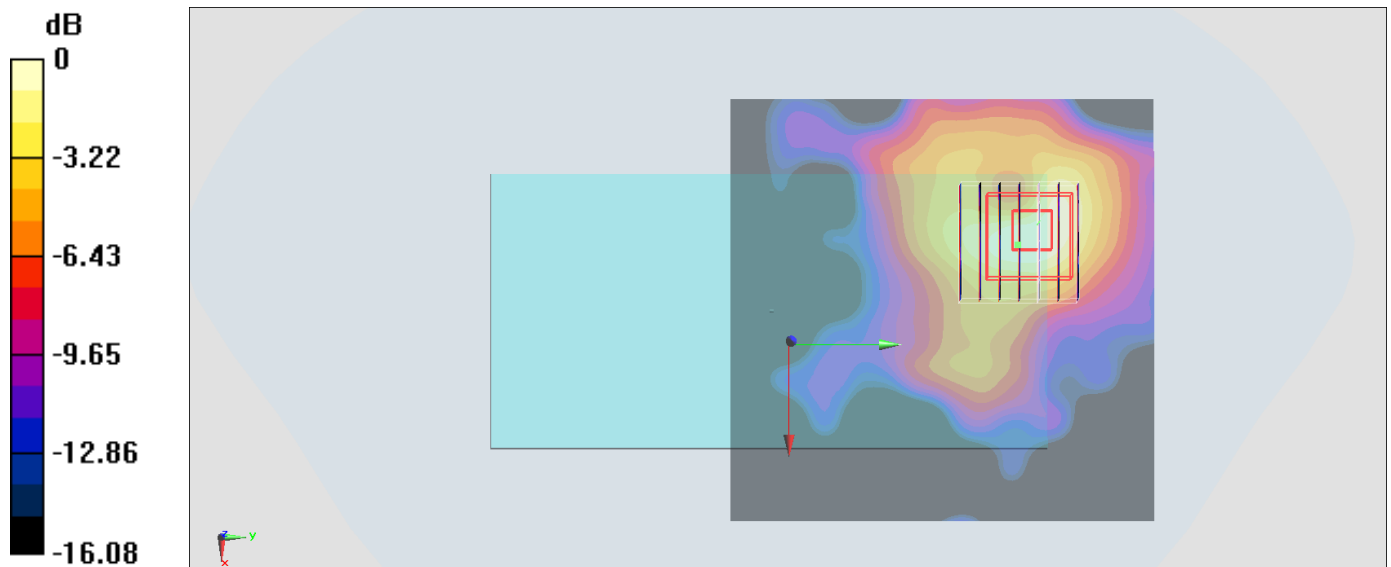

0 dB = 0.0350 W/kg = -14.56 dBW/kg

#24_GSM850_GPRS (4 Tx slots)_Front_15mm_Ch128

Communication System: GSM850; Frequency: 824.2 MHz; Duty Cycle: 1:2.08

Medium: MSL_850_170911 Medium parameters used : $f = 824.2$ MHz; $\sigma = 0.988$ S/m; $\epsilon_r = 57.396$; $\rho = 1000$ kg/m³

Ambient Temperature : 23.1 °C; Liquid Temperature : 22.1 °C

DASY5 Configuration:

- Probe: ES3DV3 - SN3169; ConvF(6.05, 6.05, 6.05); Calibrated: 2017/5/11;
- Sensor-Surface: 3mm (Mechanical Surface Detection)
- Electronics: DAE4 Sn1399; Calibrated: 2016/11/17
- Phantom: SAM-Left; Type: QD 000 P40 C; Serial: TP-1446
- Measurement SW: DASY52, Version 52.8 (8); SEMCAD X Version 14.6.10 (7331)

Area Scan (61x91x1): Interpolated grid: dx=1.500 mm, dy=1.500 mm

Maximum value of SAR (interpolated) = 0.317 W/kg

Zoom Scan (5x5x7)/Cube 0: Measurement grid: dx=8mm, dy=8mm, dz=5mm

Reference Value = 18.58 V/m; Power Drift = -0.10 dB

Peak SAR (extrapolated) = 0.336 W/kg

SAR(1 g) = 0.282 W/kg; SAR(10 g) = 0.220 W/kg

Maximum value of SAR (measured) = 0.306 W/kg

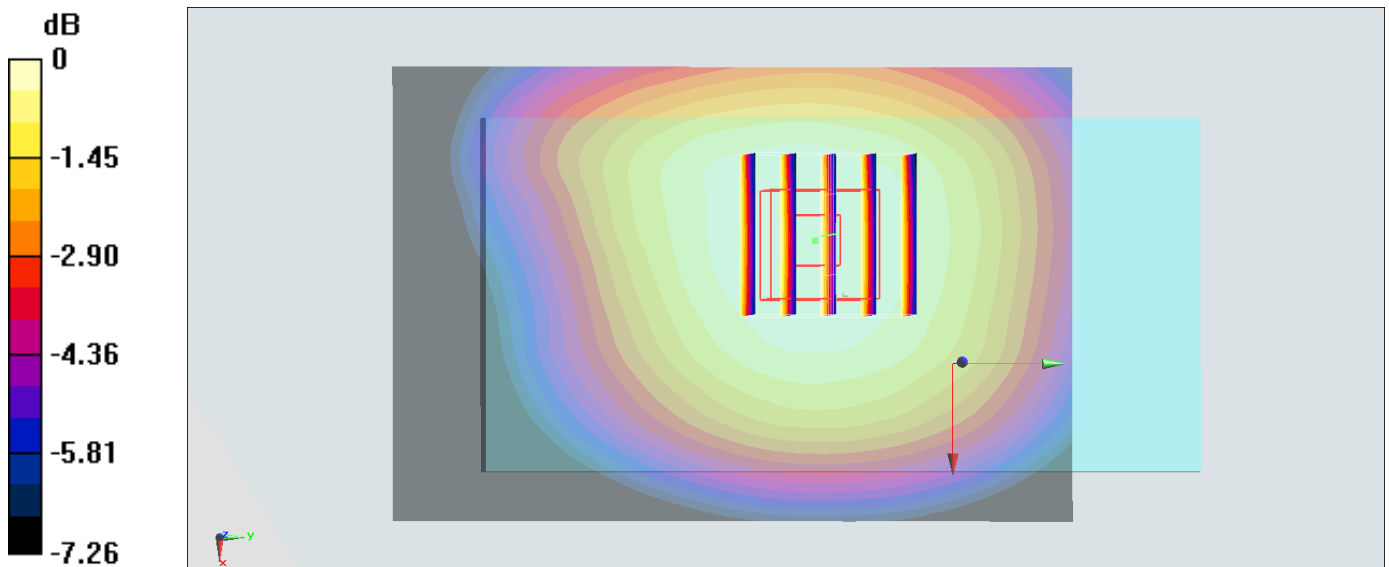

0 dB = 0.306 W/kg = -5.14 dBW/kg

#25_GSM1900_GPRS (4 Tx slots)_Back_15mm_Ch810

Communication System: PCS ; Frequency: 1909.8 MHz;Duty Cycle: 1:2.08

Medium: MSL_1900_170916 Medium parameters used: $f = 1910$ MHz; $\sigma = 1.571$ S/m; $\epsilon_r = 53.75$; $\rho = 1000$ kg/m³

Ambient Temperature : 23.7 °C ; Liquid Temperature : 22.7 °C

DASY5 Configuration

- Probe: ES3DV3 - SN3169; ConvF(4.72, 4.72, 4.72); Calibrated: 2017/5/11;
- Sensor-Surface: 3mm (Mechanical Surface Detection)
- Electronics: DAE4 Sn1399; Calibrated: 2016/11/17
- Phantom: SAM_RIGHT; Type: QD000P40CD; Serial: 1719
- Measurement SW: DASY52, Version 52.8 (8); SEMCAD X Version 14.6.10 (7373)

Area Scan (71x71x1): Interpolated grid: dx=1.500 mm, dy=1.500 mm

Maximum value of SAR (interpolated) = 0.432 W/kg

Zoom Scan (5x5x7)/Cube 0: Measurement grid: dx=8mm, dy=8mm, dz=5mm

Reference Value = 10.63 V/m; Power Drift = 0.19 dB

Peak SAR (extrapolated) = 0.629 W/kg

SAR(1 g) = 0.377 W/kg; SAR(10 g) = 0.218 W/kg

Maximum value of SAR (measured) = 0.447 W/kg

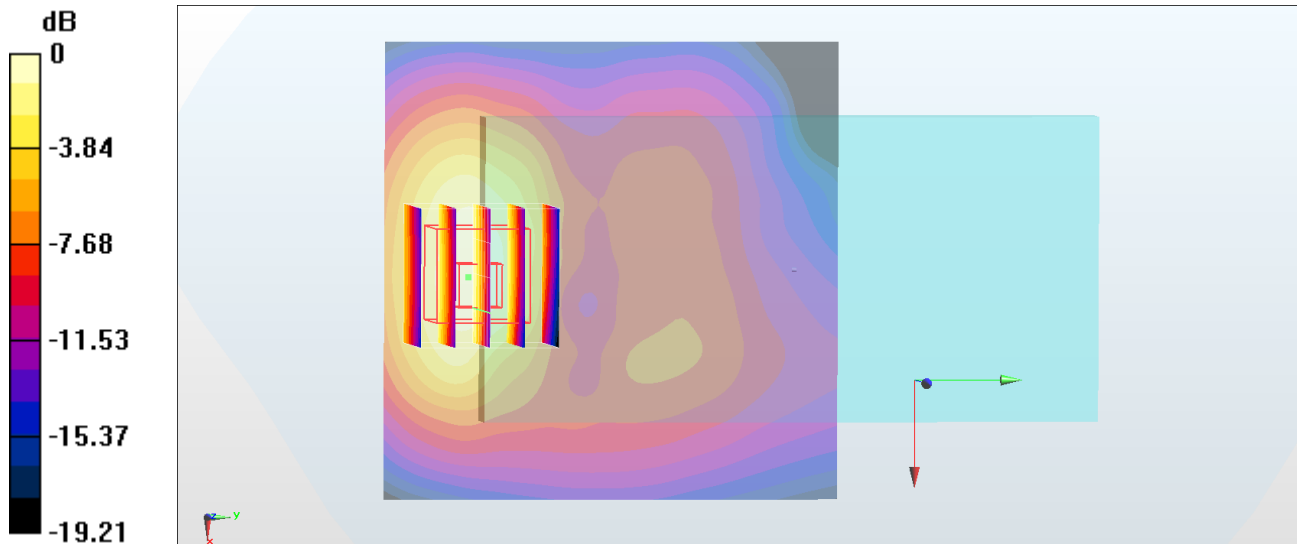

0 dB = 0.447 W/kg = -3.50 dBW/kg

#26_WCDMA II_RMC 12.2Kbps_Front_15mm_Ch9262

Communication System: WCDMA ; Frequency: 1852.4 MHz;Duty Cycle: 1:1

Medium: MSL_1900_170915 Medium parameters used: $f = 1852.4$ MHz; $\sigma = 1.511$ S/m; $\epsilon_r = 54.447$;

$\rho = 1000$ kg/m³

Ambient Temperature : 23.3 °C ; Liquid Temperature : 22.3 °C

DASY5 Configuration

- Probe: ES3DV3 - SN3071; ConvF(4.23, 4.23, 4.23); Calibrated: 2016/12/8;
- Sensor-Surface: 3mm (Mechanical Surface Detection)
- Electronics: DAE4 Sn778; Calibrated: 2017/5/22
- Phantom: SAM_Right; Type: QD000P40CD; Serial: S/N:1801
- Measurement SW: DASY52, Version 52.8 (8); SEMCAD X Version 14.6.10 (7373)

Area Scan (71x71x1): Interpolated grid: dx=1.500 mm, dy=1.500 mm

Maximum value of SAR (interpolated) = 0.974 W/kg

Zoom Scan (5x5x7)/Cube 0: Measurement grid: dx=8mm, dy=8mm, dz=5mm

Reference Value = 19.21 V/m; Power Drift = 0.09 dB

Peak SAR (extrapolated) = 1.32 W/kg

SAR(1 g) = 0.828 W/kg; SAR(10 g) = 0.479 W/kg

Maximum value of SAR (measured) = 0.980 W/kg

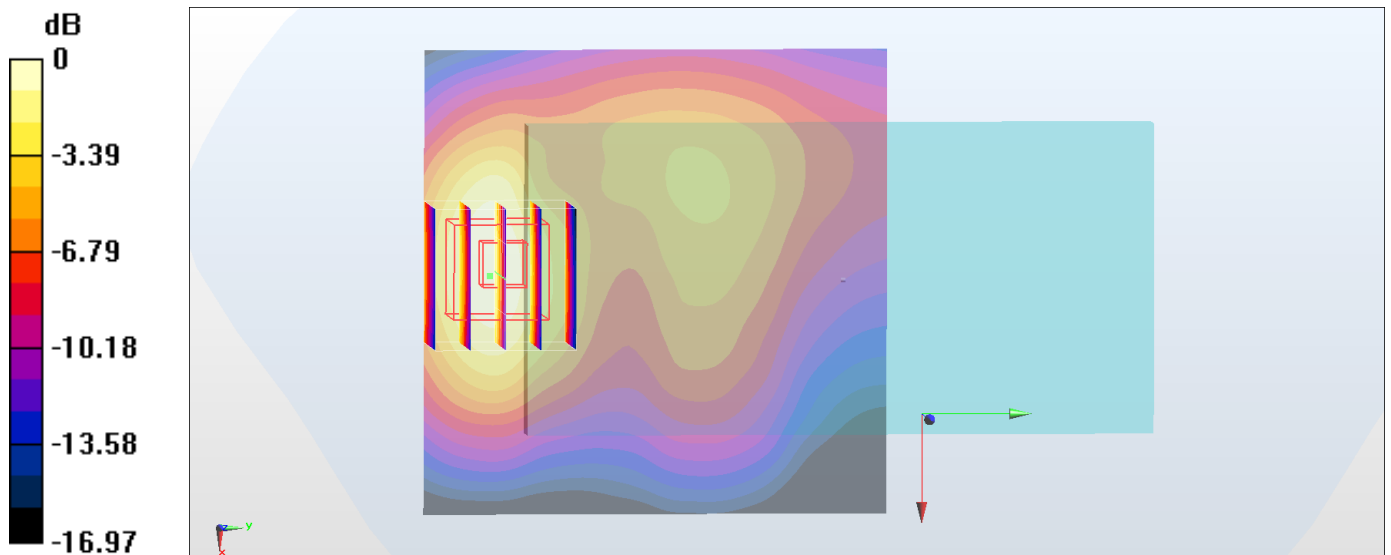

0 dB = 0.980 W/kg = -0.09 dBW/kg

#27_WCDMA V_RMC 12.2Kbps_Back_15mm_Ch4132

Communication System: WCDMA; Frequency: 826.4 MHz; Duty Cycle: 1:1

Medium: MSL_850_170911 Medium parameters used: $f = 826.4$ MHz; $\sigma = 0.99$ S/m; $\epsilon_r = 57.376$; $\rho = 1000$ kg/m³

Ambient Temperature : 23.1 °C; Liquid Temperature : 22.1 °C

DASY5 Configuration:

- Probe: ES3DV3 - SN3169; ConvF(6.05, 6.05, 6.05); Calibrated: 2017/5/11;
- Sensor-Surface: 3mm (Mechanical Surface Detection)
- Electronics: DAE4 Sn1399; Calibrated: 2016/11/17
- Phantom: SAM-Left; Type: QD 000 P40 C; Serial: TP-1446
- Measurement SW: DASY52, Version 52.8 (8); SEMCAD X Version 14.6.10 (7331)

Area Scan (71x101x1): Interpolated grid: dx=1.500 mm, dy=1.500 mm

Maximum value of SAR (interpolated) = 0.469 W/kg

Zoom Scan (5x5x7)/Cube 0: Measurement grid: dx=8mm, dy=8mm, dz=5mm

Reference Value = 22.37 V/m; Power Drift = 0.02 dB

Peak SAR (extrapolated) = 0.525 W/kg

SAR(1 g) = 0.431 W/kg; SAR(10 g) = 0.336 W/kg

Maximum value of SAR (measured) = 0.469 W/kg

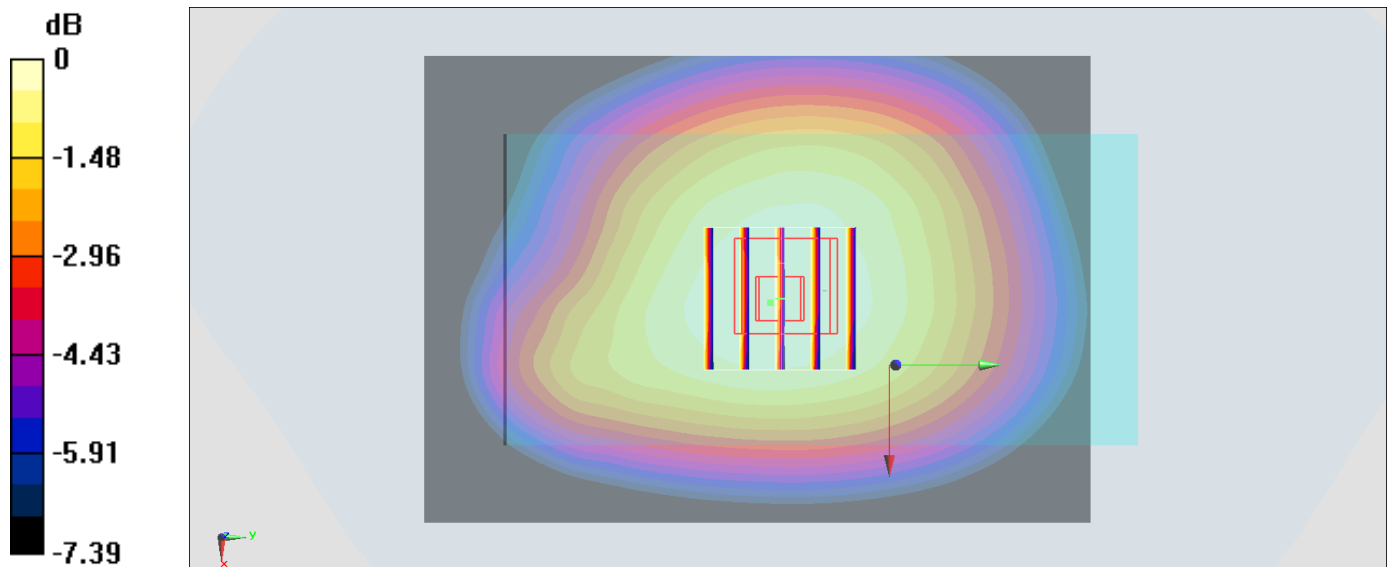

0 dB = 0.469 W/kg = -3.29 dBW/kg

#28_LTE Band 2_20M_QPSK_1_0_Back_15mm_Ch18700

Communication System: LTE ; Frequency: 1860 MHz;Duty Cycle: 1:1

Medium: MSL_1900_170915 Medium parameters used: $f = 1860$ MHz; $\sigma = 1.521$ S/m; $\epsilon_r = 54.444$; $\rho = 1000$ kg/m³

Ambient Temperature : 23.3 °C ; Liquid Temperature : 22.3 °C

DASY5 Configuration

- Probe: ES3DV3 - SN3071; ConvF(4.23, 4.23, 4.23); Calibrated: 2016/12/8;
- Sensor-Surface: 3mm (Mechanical Surface Detection)
- Electronics: DAE4 Sn778; Calibrated: 2017/5/22
- Phantom: SAM_Right; Type: QD000P40CD; Serial: S/N:1801
- Measurement SW: DASY52, Version 52.8 (8); SEMCAD X Version 14.6.10 (7373)

Area Scan (71x71x1): Interpolated grid: dx=1.500 mm, dy=1.500 mm

Maximum value of SAR (interpolated) = 0.844 W/kg

Zoom Scan (5x5x7)/Cube 0: Measurement grid: dx=8mm, dy=8mm, dz=5mm

Reference Value = 16.52 V/m; Power Drift = 0.15 dB

Peak SAR (extrapolated) = 1.13 W/kg

SAR(1 g) = 0.717 W/kg; SAR(10 g) = 0.425 W/kg

Maximum value of SAR (measured) = 0.854 W/kg

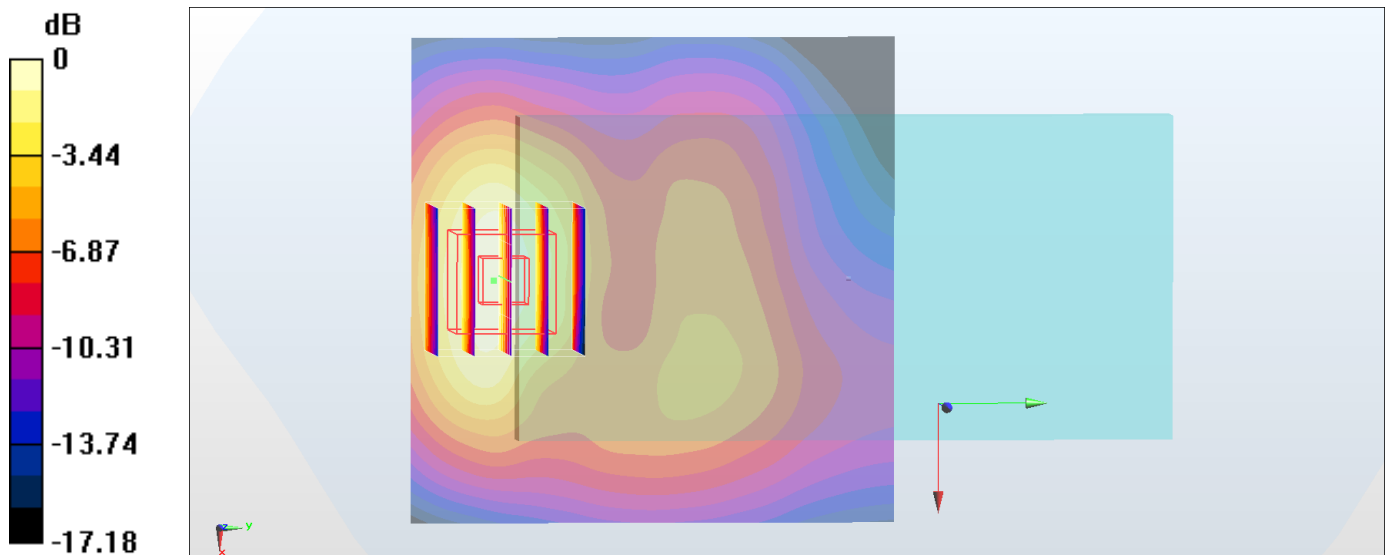

0 dB = 0.854 W/kg = -0.69 dBW/kg

#29_LTE Band 5_10M_QPSK_1_0_Back_15mm_Ch20525

Communication System: LTE ; Frequency: 836.5 MHz;Duty Cycle: 1:1

Medium: MSL_850_170911 Medium parameters used : $f = 836.5$ MHz; $\sigma = 1$ S/m; $\epsilon_r = 57.285$; $\rho = 1000$ kg/m³

Ambient Temperature : 23.1 °C ; Liquid Temperature : 22.1 °C

DASY5 Configuration:

- Probe: ES3DV3 - SN3169; ConvF(6.05, 6.05, 6.05); Calibrated: 2017/5/11;
- Sensor-Surface: 3mm (Mechanical Surface Detection)
- Electronics: DAE4 Sn1399; Calibrated: 2016/11/17
- Phantom: SAM-Left; Type: QD 000 P40 C; Serial: TP-1446
- Measurement SW: DASY52, Version 52.8 (8);SEMCAD X Version 14.6.10 (7331)

Area Scan (71x91x1): Interpolated grid: dx=1.500 mm, dy=1.500 mm

Maximum value of SAR (interpolated) = 0.433 W/kg

Zoom Scan (5x5x7)/Cube 0: Measurement grid: dx=8mm, dy=8mm, dz=5mm

Reference Value = 21.49 V/m; Power Drift = 0.00 dB

Peak SAR (extrapolated) = 0.485 W/kg

SAR(1 g) = 0.398 W/kg; SAR(10 g) = 0.310 W/kg

Maximum value of SAR (measured) = 0.434 W/kg

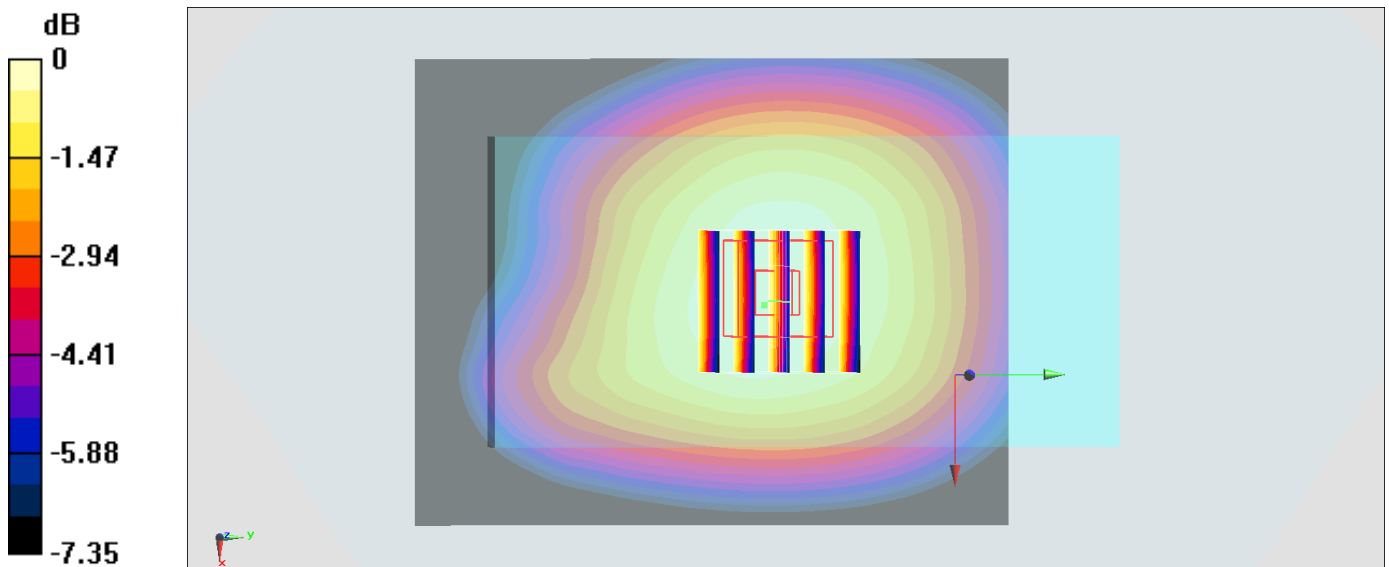

0 dB = 0.434 W/kg = -3.63 dBW/kg

#30_LTE Band 7_20M_QPSK_1_49_Back_15mm_Ch21350

Communication System: LTE; Frequency: 2560 MHz; Duty Cycle: 1:1

Medium: MSL_2600_170914 Medium parameters used: $f = 2560$ MHz; $\sigma = 2.15$ S/m; $\epsilon_r = 53.448$; $\rho = 1000$ kg/m³

Ambient Temperature : 23.5 °C ; Liquid Temperature : 22.5 °C

DASY5 Configuration:

- Probe: ES3DV3 - SN3169; ConvF(4.17, 4.17, 4.17); Calibrated: 2017/5/11;
- Sensor-Surface: 3mm (Mechanical Surface Detection)
- Electronics: DAE4 Sn1399; Calibrated: 2016/11/17
- Phantom: SAM-Left; Type: QD 000 P40 C; Serial: TP-1446
- Measurement SW: DASY52, Version 52.8 (8); SEMCAD X Version 14.6.10 (7331)

Area Scan (91x91x1): Interpolated grid: dx=1.200 mm, dy=1.200 mm

Maximum value of SAR (interpolated) = 0.504 W/kg

Zoom Scan (7x7x7)/Cube 0: Measurement grid: dx=5mm, dy=5mm, dz=5mm

Reference Value = 15.32 V/m; Power Drift = -0.01 dB

Peak SAR (extrapolated) = 0.745 W/kg

SAR(1 g) = 0.405 W/kg; SAR(10 g) = 0.216 W/kg

Maximum value of SAR (measured) = 0.502 W/kg

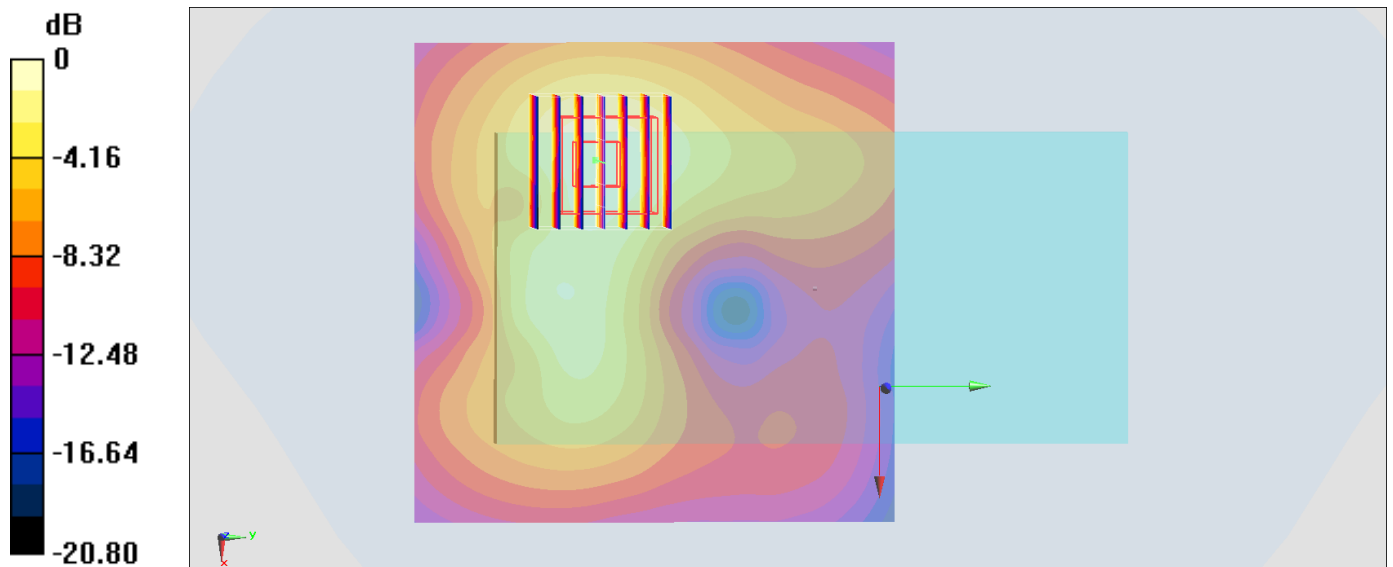

0 dB = 0.502 W/kg = -2.99 dBW/kg

#31_LTE Band 41_20M_QPSK_1_49_Back_15mm_Ch41140

Communication System: LTE; Frequency: 2645 MHz; Duty Cycle: 1:1.59

Medium: MSL_2600_170914 Medium parameters used : $f = 2645$ MHz; $\sigma = 2.268$ S/m; $\epsilon_r = 53.145$;

$\rho = 1000$ kg/m³

Ambient Temperature : 23.5 °C; Liquid Temperature : 22.5 °C

DASY5 Configuration:

- Probe: ES3DV3 - SN3169; ConvF(4.17, 4.17, 4.17); Calibrated: 2017/5/11;
- Sensor-Surface: 3mm (Mechanical Surface Detection)
- Electronics: DAE4 Sn1399; Calibrated: 2016/11/17
- Phantom: SAM-Left; Type: QD 000 P40 C; Serial: TP-1446
- Measurement SW: DASY52, Version 52.8 (8); SEMCAD X Version 14.6.10 (7331)

Area Scan (91x91x1): Interpolated grid: dx=1.200 mm, dy=1.200 mm

Maximum value of SAR (interpolated) = 0.236 W/kg

Zoom Scan (7x7x7)/Cube 0: Measurement grid: dx=5mm, dy=5mm, dz=5mm

Reference Value = 10.76 V/m; Power Drift = 0.04 dB

Peak SAR (extrapolated) = 0.371 W/kg

SAR(1 g) = 0.190 W/kg; SAR(10 g) = 0.098 W/kg

Maximum value of SAR (measured) = 0.240 W/kg

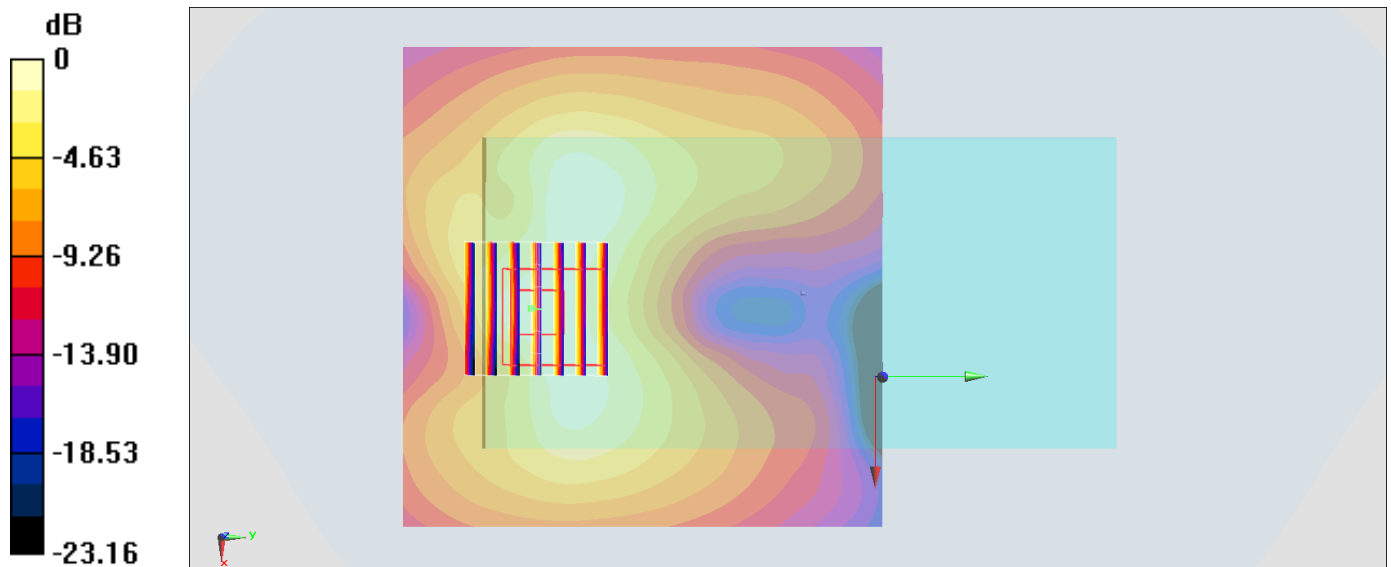

0 dB = 0.240 W/kg = -6.20 dBW/kg

#32_WLAN2.4GHz_802.11b 1Mbps_Back_15mm_Ch1

Communication System: 802.11b; Frequency: 2412 MHz; Duty Cycle: 1:1.015

Medium: MSL2450_170918 Medium parameters used: $f = 2412$ MHz; $\sigma = 1.939$ S/m; $\epsilon_r = 54.197$; $\rho = 1000$ kg/m³

Ambient Temperature : 23.9 °C; Liquid Temperature : 22.9 °C

DASY5 Configuration

- Probe: ES3DV3 - SN3169; ConvF(4.28, 4.28, 4.28); Calibrated: 2017/5/11;
- Sensor-Surface: 3mm (Mechanical Surface Detection)
- Electronics: DAE4 Sn1399; Calibrated: 2016/11/17
- Phantom: SAM_RIGHT; Type: QD000P40CD; Serial: 1719
- Measurement SW: DASY52, Version 52.8 (8); SEMCAD X Version 14.6.10 (7373)

Area Scan (91x91x1): Interpolated grid: dx=1.200 mm, dy=1.200 mm

Maximum value of SAR (interpolated) = 0.0723 W/kg

Zoom Scan (7x7x7)/Cube 0: Measurement grid: dx=5mm, dy=5mm, dz=5mm

Reference Value = 6.251 V/m; Power Drift = 0.07 dB

Peak SAR (extrapolated) = 0.117 W/kg

SAR(1 g) = 0.060 W/kg; SAR(10 g) = 0.029 W/kg

Maximum value of SAR (measured) = 0.0767 W/kg

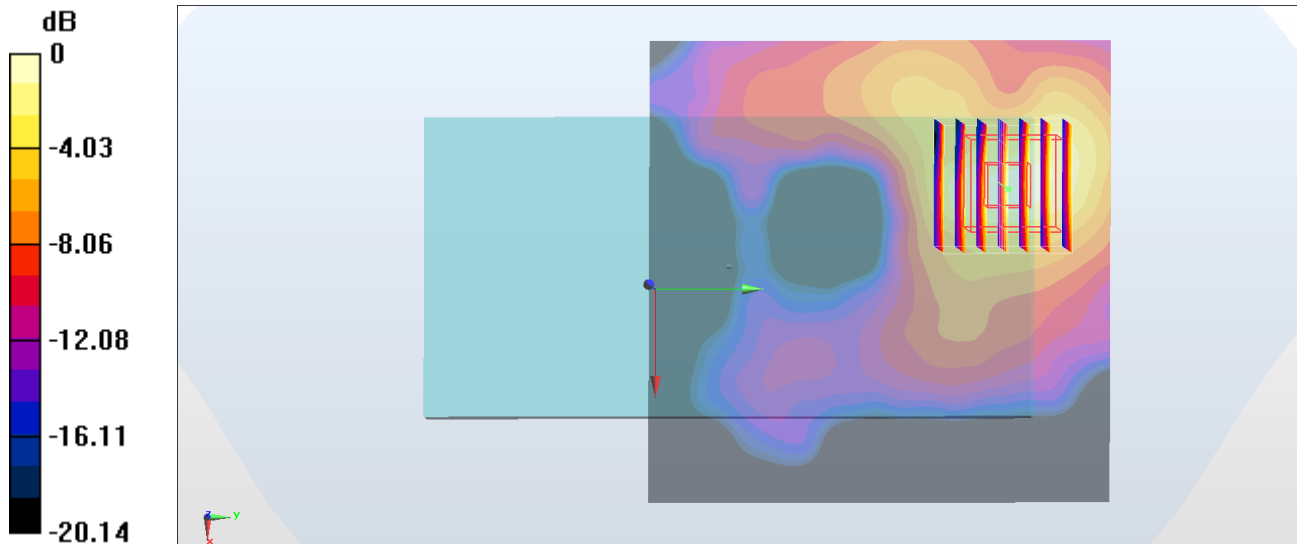

0 dB = 0.0767 W/kg = -11.15 dBW/kg

#33_WLAN5GHz_802.11a_6Mbps_Back_15mm_Ch64

Communication System: 802.11a; Frequency: 5320 MHz; Duty Cycle: 1:1.069

Medium: MSL_5G_170918 Medium parameters used: $f = 5320$ MHz; $\sigma = 5.391$ S/m; $\epsilon_r = 47.421$; $\rho = 1000$ kg/m³

Ambient Temperature : 23.5 °C; Liquid Temperature : 22.5 °C

DASY5 Configuration:

- Probe: EX3DV4 - SN3873; ConvF(4.61, 4.61, 4.61); Calibrated: 2017/8/25;
- Sensor-Surface: 1.4mm (Mechanical Surface Detection)
- Electronics: DAE4 Sn916; Calibrated: 2016/12/15
- Phantom: SAM-Left; Type: QD 000 P40 C; Serial: TP-1446
- Measurement SW: DASY52, Version 52.8 (8); SEMCAD X Version 14.6.10 (7331)

Area Scan (111x111x1): Interpolated grid: dx=1.000 mm, dy=1.000 mm

Maximum value of SAR (interpolated) = 0.194 W/kg

Zoom Scan (7x7x7)/Cube 0: Measurement grid: dx=4mm, dy=4mm, dz=1.4mm

Reference Value = 4.414 V/m; Power Drift = -0.14 dB

Peak SAR (extrapolated) = 0.328 W/kg

SAR(1 g) = 0.079 W/kg; SAR(10 g) = 0.027 W/kg

Maximum value of SAR (measured) = 0.193 W/kg

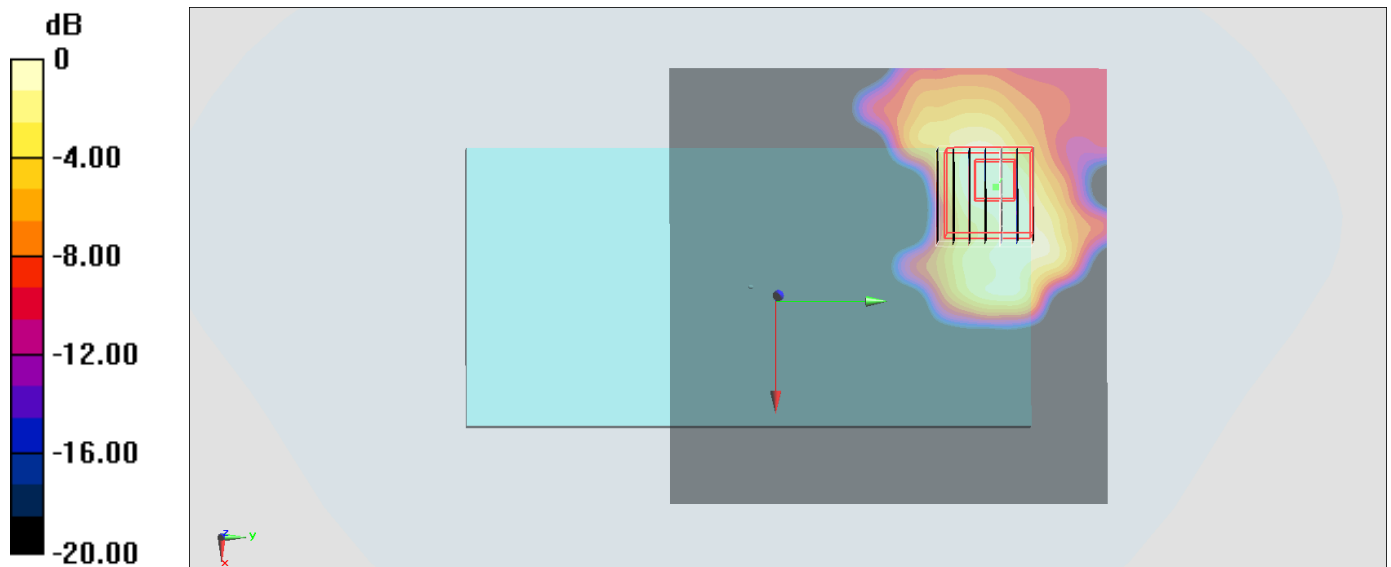

0 dB = 0.193 W/kg = -7.14 dBW/kg

#34_WLAN5GHz_802.11a 6Mbps_Back_15mm_Ch100

Communication System: 802.11a; Frequency: 5500 MHz; Duty Cycle: 1:1.069

Medium: MSL_5G_170918 Medium parameters used: $f = 5500$ MHz; $\sigma = 5.621$ S/m; $\epsilon_r = 47.123$; $\rho = 1000$ kg/m³

Ambient Temperature : 23.5 °C; Liquid Temperature : 22.5 °C

DASY5 Configuration:

- Probe: EX3DV4 - SN3873; ConvF(3.9, 3.9, 3.9); Calibrated: 2017/8/25;
- Sensor-Surface: 1.4mm (Mechanical Surface Detection)
- Electronics: DAE4 Sn916; Calibrated: 2016/12/15
- Phantom: SAM-Left; Type: QD 000 P40 C; Serial: TP-1446
- Measurement SW: DASY52, Version 52.8 (8); SEMCAD X Version 14.6.10 (7331)

Area Scan (111x111x1): Interpolated grid: dx=1.000 mm, dy=1.000 mm

Maximum value of SAR (interpolated) = 0.197 W/kg

Zoom Scan (7x7x7)/Cube 0: Measurement grid: dx=4mm, dy=4mm, dz=1.4mm

Reference Value = 4.151 V/m; Power Drift = -0.16 dB

Peak SAR (extrapolated) = 0.294 W/kg

SAR(1 g) = 0.069 W/kg; SAR(10 g) = 0.022 W/kg

Maximum value of SAR (measured) = 0.181 W/kg

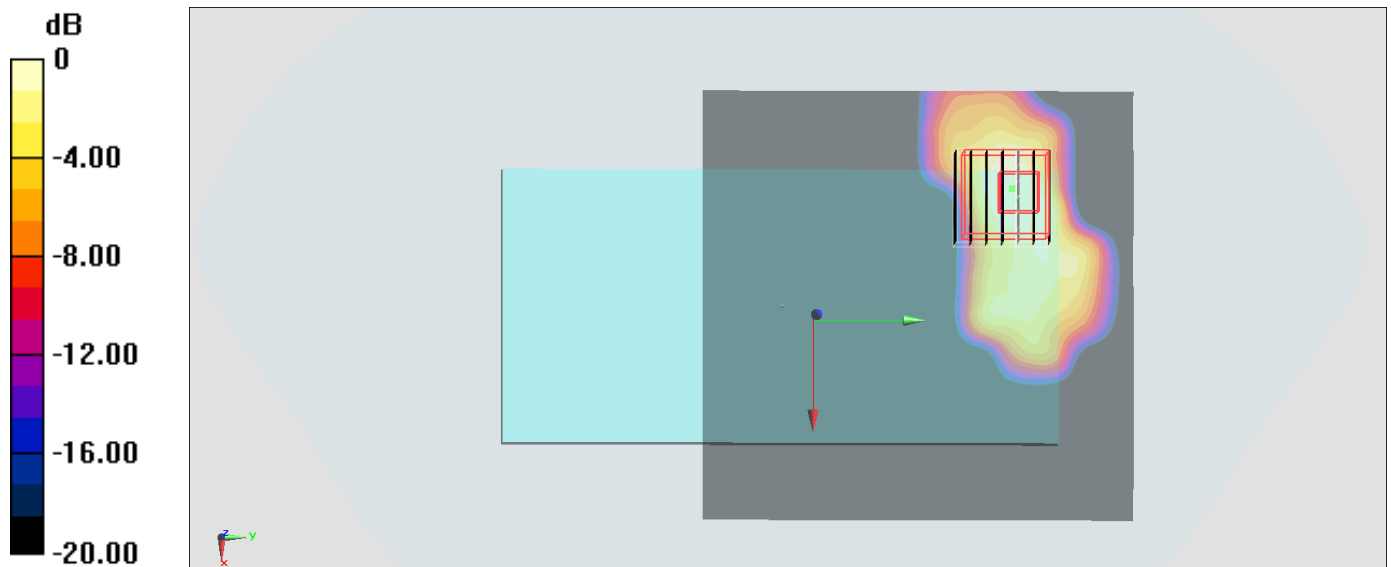

0 dB = 0.181 W/kg = -7.42 dBW/kg

#35_WLAN5GHz_802.11a_6Mbps_Back_15mm_Ch165

Communication System: 802.11a; Frequency: 5825 MHz; Duty Cycle: 1:1.069

Medium: MSL_5G_170918 Medium parameters used: $f = 5825$ MHz; $\sigma = 6.067$ S/m; $\epsilon_r = 46.596$; $\rho = 1000$ kg/m³

Ambient Temperature : 23.5 °C; Liquid Temperature : 22.5 °C

DASY5 Configuration:

- Probe: EX3DV4 - SN3873; ConvF(4.16, 4.16, 4.16); Calibrated: 2017/8/25;
- Sensor-Surface: 1.4mm (Mechanical Surface Detection)
- Electronics: DAE4 Sn916; Calibrated: 2016/12/15
- Phantom: SAM-Left; Type: QD 000 P40 C; Serial: TP-1446
- Measurement SW: DASY52, Version 52.8 (8); SEMCAD X Version 14.6.10 (7331)

Area Scan (111x111x1): Interpolated grid: dx=1.000 mm, dy=1.000 mm

Maximum value of SAR (interpolated) = 0.195 W/kg

Zoom Scan (7x7x7)/Cube 0: Measurement grid: dx=4mm, dy=4mm, dz=1.4mm

Reference Value = 6.322 V/m; Power Drift = -0.14 dB

Peak SAR (extrapolated) = 0.275 W/kg

SAR(1 g) = 0.066 W/kg; SAR(10 g) = 0.024 W/kg

Maximum value of SAR (measured) = 0.185 W/kg

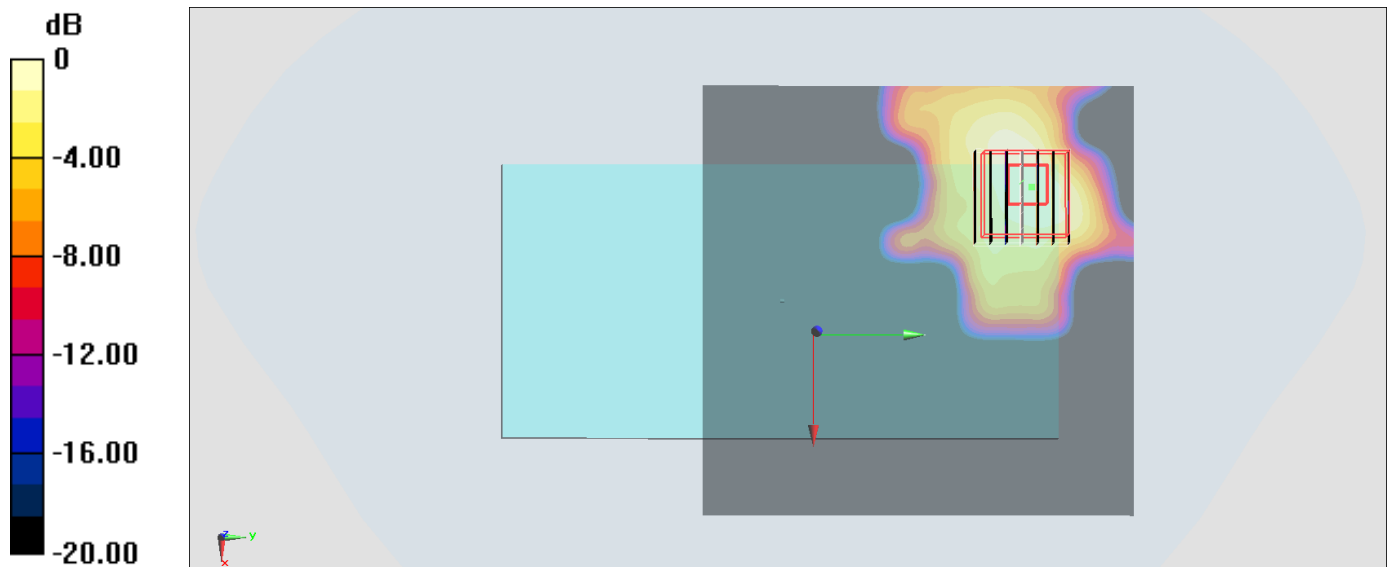

0 dB = 0.185 W/kg = -7.33 dBW/kg

#36_Bluetooth_1Mbps_Back_15mm_Ch0

Communication System: Bluetooth; Frequency: 2402 MHz; Duty Cycle: 1:1.297

Medium: MSL_2450_170919 Medium parameters used: $f = 2402$ MHz; $\sigma = 1.92$ S/m; $\epsilon_r = 54.116$; $\rho = 1000$ kg/m³

Ambient Temperature : 23.2 °C; Liquid Temperature : 22.2 °C

DASY5 Configuration:

- Probe: ES3DV3 - SN3071; ConvF(3.88, 3.88, 3.88); Calibrated: 2016/12/8;
- Sensor-Surface: 3mm (Mechanical Surface Detection)
- Electronics: DAE4 Sn778; Calibrated: 2017/5/22
- Phantom: SAM-Left; Type: QD 000 P40 C; Serial: TP-1446
- Measurement SW: DASY52, Version 52.8 (8); SEMCAD X Version 14.6.10 (7331)

Area Scan (91x91x1): Interpolated grid: dx=1.200 mm, dy=1.200 mm

Maximum value of SAR (interpolated) = 0.0143 W/kg

Zoom Scan (7x7x7)/Cube 0: Measurement grid: dx=5mm, dy=5mm, dz=5mm

Reference Value = 2.730 V/m; Power Drift = 0.10 dB

Peak SAR (extrapolated) = 0.0330 W/kg

SAR(1 g) = 0.012 W/kg; SAR(10 g) = 0.00588 W/kg

Maximum value of SAR (measured) = 0.0146 W/kg

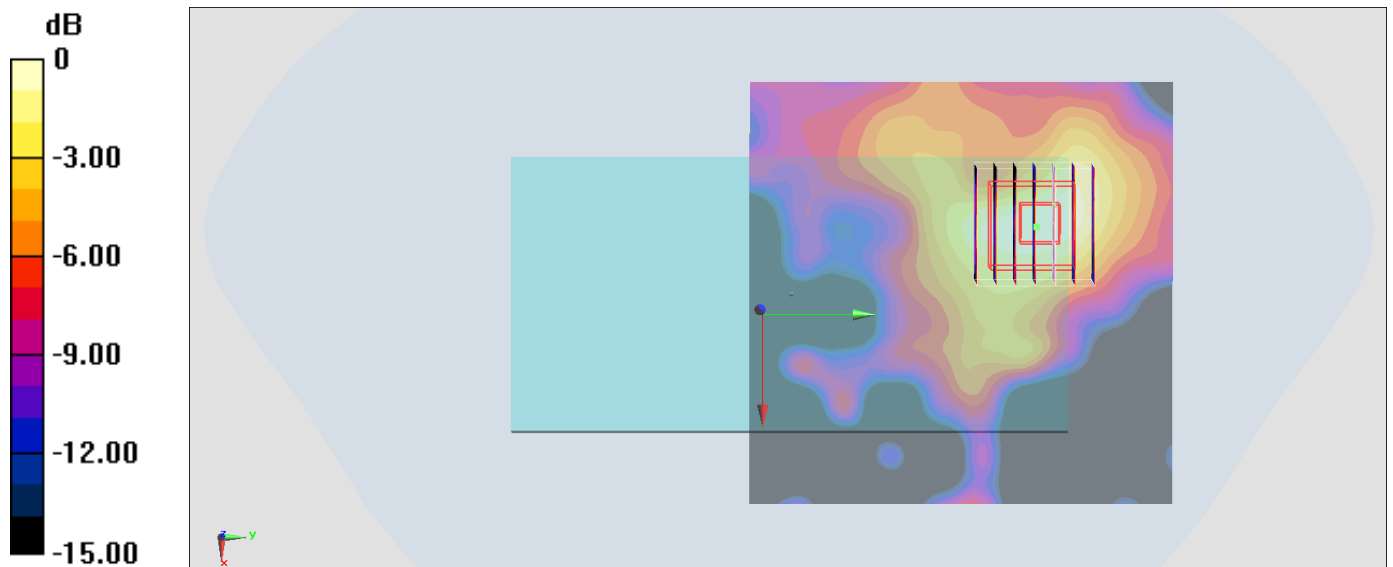

0 dB = 0.0146 W/kg = -18.36 dBW/kg