



FCC RF Test Report

APPLICANT : Sony Mobile Communications Inc.
EQUIPMENT : GSM/WCDMA/LTE Phone+Bluetooth,
DTS/UNII a/b/g/n/ac and NFC
BRAND NAME : Sony
FCC ID : PY7-08608T
STANDARD : FCC Part 15 Subpart C §15.247
CLASSIFICATION : (DSS) Spread Spectrum Transmitter

The product was received on Jun. 07, 2017 and testing was completed on Oct. 03, 2017. We, SPORTON INTERNATIONAL INC., would like to declare that the tested sample has been evaluated in accordance with the test procedures and has been in compliance with the applicable technical standards.

The test results in this report apply exclusively to the tested model / sample. Without written approval of SPORTON INTERNATIONAL INC., the test report shall not be reproduced except in full.

Reviewed by: Joseph Lin / Supervisor

Approved by: Jones Tsai / Manager



SPORTON INTERNATIONAL INC.

No. 52, Hwa Ya 1st Rd., Hwa Ya Technology Park, Kwei-Shan District, Tao Yuan City, Taiwan, R.O.C.

SPORTON INTERNATIONAL INC.

TEL : 886-3-327-3456

FAX : 886-3-328-4978

FCC ID : PY7-08608T

Page Number : 1 of 62

Report Issued Date : Oct. 26, 2017

Report Version : Rev. 02

Report Template No.: BU5-FR15CBT Version 2.0



TABLE OF CONTENTS

REVISION HISTORY..... 3

SUMMARY OF TEST RESULT 4

1 GENERAL INFORMATION 5

 1.1 Applicant 5

 1.2 Manufacturer 5

 1.3 Product Feature of Equipment Under Test..... 5

 1.4 Modification of EUT 6

 1.5 Testing Location 7

 1.6 Applicable Standards..... 7

2 TEST CONFIGURATION OF EQUIPMENT UNDER TEST..... 8

 2.1 Carrier Frequency Channel 8

 2.2 Descriptions of Test Mode 9

 2.3 Test Mode 10

 2.4 Connection Diagram of Test System 11

 2.5 Support Unit used in test configuration and system 12

 2.6 UT Operation Test Setup 12

 2.7 Measurement Results Explanation Example..... 12

3 TEST RESULT 13

 3.1 Number of Channel Measurement 13

 3.2 Hopping Channel Separation Measurement 15

 3.3 Dwell Time Measurement 21

 3.4 20dB and 99% Bandwidth Measurement 24

 3.5 Peak Output Power Measurement 35

 3.6 Conducted Band Edges Measurement..... 36

 3.7 Conducted Spurious Emission Measurement 43

 3.8 Radiated Band Edges and Spurious Emission Measurement 53

 3.9 AC Conducted Emission Measurement..... 57

 3.10 Antenna Requirements 59

4 LIST OF MEASURING EQUIPMENT 60

5 UNCERTAINTY OF EVALUATION..... 62

APPENDIX A. TEST RESULT OF CONDUCTED TEST ITEMS

APPENDIX B. AC CONDUCTED EMISSION TEST RESULT

APPENDIX C. RADIATED SPURIOUS EMISSION

APPENDIX D. RADIATED SPURIOUS EMISSION PLOTS

APPENDIX E. DUTY CYCLE PLOTS



SUMMARY OF TEST RESULT

| Report Section | FCC Rule | Description | Limit | Result | Remark |
|----------------|--------------------|--|----------------------------|--------|---|
| 3.1 | 15.247(a)(1) | Number of Channels | ≥ 15Chs | Pass | - |
| 3.2 | 15.247(a)(1) | Hopping Channel Separation | ≥ 2/3 of 20dB BW | Pass | - |
| 3.3 | 15.247(a)(1) | Dwell Time of Each Channel | ≤ 0.4sec in 31.6sec period | Pass | - |
| 3.4 | 15.247(a)(1) | 20dB Bandwidth | NA | Pass | - |
| 3.4 | - | 99% Bandwidth | - | Pass | - |
| 3.5 | 15.247(b)(1) | Peak Output Power | ≤ 125 mW | Pass | - |
| 3.6 | 15.247(d) | Conducted Band Edges | ≤ 20dBc | Pass | - |
| 3.7 | 15.247(d) | Conducted Spurious Emission | ≤ 20dBc | Pass | - |
| 3.8 | 15.247(d) | Radiated Band Edges and Radiated Spurious Emission | 15.209(a) & 15.247(d) | Pass | Under limit 3.98 dB at 71.310 MHz |
| 3.9 | 15.207 | AC Conducted Emission | 15.207(a) | Pass | Under limit 14.00 dB at 0.150 MHz |
| 3.10 | 15.203 & 15.247(b) | Antenna Requirement | N/A | Pass | - |



1 GENERAL INFORMATION

1.1 Applicant

Sony Mobile Communications Inc.

4-12-3 Higashi-Shinagawa, Shinagawa-ku, Tokyo, 140-0002, Japan

1.2 Manufacturer

Sony Mobile Communications Inc.

4-12-3 Higashi-Shinagawa, Shinagawa-ku, Tokyo, 140-0002, Japan

1.3 Product Feature of Equipment Under Test

GSM/WCDMA/LTE, Bluetooth, DTS/UNII a/b/g/n/ac, FM Receiver, NFC, and GPS.

| Standards-related Product Specification | |
|---|---------------------------------------|
| Antenna Type / Gain | PIFA Antenna type with gain -1.60 dBi |

| EUT Information List | | | |
|----------------------|------------|------------|----------------------------|
| HW Version | SW Version | S/N | Performed Test Item |
| A | 1.14 | RQ3005UYBC | RF conducted measurement |
| | | RQ3005VVKR | Radiated Spurious Emission |
| | | CQ300000EL | AC Conducted Emission |



| Accessory List | |
|----------------|--|
| AC Adapter 1 | Model Name: UCH12 |
| | S/N: |
| | VB17W34100012 (for radiated spurious emission) VB17W34100230 (for conducted emission) |
| Earphone 1 | Model Name: MH410c |
| | S/N: N/A |
| USB Cable | Model Name: UCB20 |
| | S/N: N/A |

Note:

1. Above EUT list and accessory list used are electrically identical per declared by manufacturer.
2. Above the accessories list are used to exercise the EUT during test.
3. For other wireless features of this EUT, test report will be issued separately.

1.4 Modification of EUT

No modifications are made to the EUT during all test items.



1.5 Testing Location

Sporton Lab is accredited to ISO 17025 by Taiwan Accreditation Foundation (TAF code : 1190) and the FCC designation No. TW1190 and TW0007 under the FCC 2.948(e) by Mutual Recognition Agreement (MRA) in FCC Test.

| | | |
|---------------------------|--|---------|
| Test Site | SPORTON INTERNATIONAL INC. | |
| Test Site Location | No. 52, Hwa Ya 1 st Rd., Hwa Ya Technology Park, Kwei-Shan District, Tao Yuan City, Taiwan, R.O.C. TEL: +886-3-327-3456 FAX: +886-3-328-4978 | |
| Test Site No. | Sporton Site No. | |
| | TH05-HY | CO05-HY |

Note: The test site complies with ANSI C63.4 2014 requirement.

| | | |
|---------------------------|--|--|
| Test Site | SPORTON INTERNATIONAL INC. | |
| Test Site Location | No.58, Aly. 75, Ln. 564, Wenhua 3rd Rd. Guishan Dist, Taoyuan City, Taiwan (R.O.C.) TEL: +886-3-327-0868 FAX: +886-3-327-0855 | |
| Test Site No. | Sporton Site No. | |
| | 03CH13-HY | |

Note: The test site complies with ANSI C63.4 2014 requirement.

1.6 Applicable Standards

According to the specifications of the manufacturer, the EUT must comply with the requirements of the following standards:

- ♦ FCC Part 15 Subpart C §15.247
- ♦ ANSI C63.10-2013

Remark:

1. All test items were verified and recorded according to the standards and without any deviation during the test.
2. This EUT has also been tested and complied with the requirements of FCC Part 15, Subpart B, recorded in a separate test report.



2 Test Configuration of Equipment Under Test

2.1 Carrier Frequency Channel

| Frequency Band | Channel | Freq. (MHz) | Channel | Freq. (MHz) | Channel | Freq. (MHz) |
|-----------------|---------|-------------|---------|-------------|---------|-------------|
| 2400-2483.5 MHz | 0 | 2402 | 27 | 2429 | 54 | 2456 |
| | 1 | 2403 | 28 | 2430 | 55 | 2457 |
| | 2 | 2404 | 29 | 2431 | 56 | 2458 |
| | 3 | 2405 | 30 | 2432 | 57 | 2459 |
| | 4 | 2406 | 31 | 2433 | 58 | 2460 |
| | 5 | 2407 | 32 | 2434 | 59 | 2461 |
| | 6 | 2408 | 33 | 2435 | 60 | 2462 |
| | 7 | 2409 | 34 | 2436 | 61 | 2463 |
| | 8 | 2410 | 35 | 2437 | 62 | 2464 |
| | 9 | 2411 | 36 | 2438 | 63 | 2465 |
| | 10 | 2412 | 37 | 2439 | 64 | 2466 |
| | 11 | 2413 | 38 | 2440 | 65 | 2467 |
| | 12 | 2414 | 39 | 2441 | 66 | 2468 |
| | 13 | 2415 | 40 | 2442 | 67 | 2469 |
| | 14 | 2416 | 41 | 2443 | 68 | 2470 |
| | 15 | 2417 | 42 | 2444 | 69 | 2471 |
| | 16 | 2418 | 43 | 2445 | 70 | 2472 |
| | 17 | 2419 | 44 | 2446 | 71 | 2473 |
| | 18 | 2420 | 45 | 2447 | 72 | 2474 |
| | 19 | 2421 | 46 | 2448 | 73 | 2475 |
| | 20 | 2422 | 47 | 2449 | 74 | 2476 |
| | 21 | 2423 | 48 | 2450 | 75 | 2477 |
| | 22 | 2424 | 49 | 2451 | 76 | 2478 |
| | 23 | 2425 | 50 | 2452 | 77 | 2479 |
| | 24 | 2426 | 51 | 2453 | 78 | 2480 |
| | 25 | 2427 | 52 | 2454 | - | - |
| | 26 | 2428 | 53 | 2455 | - | - |



2.2 Descriptions of Test Mode

Preliminary tests were performed in different data rates and recorded the RF output power in the following table:

| Channel | Frequency | Bluetooth RF Output Power | | |
|---------|-----------|---------------------------|----------------|----------|
| | | Data Rate / Modulation | | |
| | | GFSK | $\pi/4$ -DQPSK | 8-DPSK |
| | | 1Mbps | 2Mbps | 3Mbps |
| Ch00 | 2402MHz | 9.93 dBm | 8.88 dBm | 9.29 dBm |
| Ch39 | 2441MHz | 9.22 dBm | 8.21 dBm | 8.65 dBm |
| Ch78 | 2480MHz | 9.39 dBm | 8.09 dBm | 8.78 dBm |

- a. The EUT has been associated with peripherals and configuration operated in a manner tended to maximize its emission characteristics in a typical application. Frequency range investigated: conduction (150 kHz to 30 MHz), radiation (9 kHz to the 10th harmonic of the highest fundamental frequency or to 40 GHz, whichever is lower). Pre-scanned tests, X, Y, Z in three orthogonal panels, and different data rates were conducted to determine the final configuration (X plane as worst plane) from all possible combinations.

- b. AC power line Conducted Emission was tested under maximum output power.



2.3 Test Mode

The following summary table is showing all test modes to demonstrate in compliance with the standard.

| Summary table of Test Cases | | | |
|--|---|---|---|
| Test Item | Data Rate / Modulation | | |
| | Bluetooth BR 1Mbps GFSK | Bluetooth EDR 2Mbps $\pi/4$ -DQPSK | Bluetooth EDR 3Mbps 8-DPSK |
| Conducted Test Cases | Mode 1: CH00_2402 MHz Mode 2: CH39_2441 MHz Mode 3: CH78_2480 MHz | Mode 4: CH00_2402 MHz Mode 5: CH39_2441 MHz Mode 6: CH78_2480 MHz | Mode 7: CH00_2402 MHz Mode 8: CH39_2441 MHz Mode 9: CH78_2480 MHz |
| Radiated Test Cases | Bluetooth 1Mbps GFSK / EDR 2Mbps $\pi/4$-DQPSK / EDR 3Mbps 8-DPSK | | |
| | Mode 1: CH00_2402 MHz for 1Mbps Mode 2: CH39_2441 MHz for 1Mbps Mode 3: CH78_2480 MHz for 1Mbps Mode 4: CH00_2402 MHz for 2Mbps Mode 5: CH39_2441 MHz for 2Mbps Mode 6: CH78_2480 MHz for 2Mbps Mode 7: CH00_2402 MHz for 3Mbps Mode 8: CH39_2441 MHz for 3Mbps Mode 9: CH78_2480 MHz for 3Mbps | | |
| AC Conducted Emission | Mode 1 : Bluetooth Link + WLAN (2.4GHz) Link + Earphone 1 + Battery 1 + USB Cable (Charging from Adapter 1) | | |
| Remark: For Radiated Test Cases, The tests were performance with Battery 1. | | | |

2.4 Connection Diagram of Test System

<Bluetooth Tx Mode>

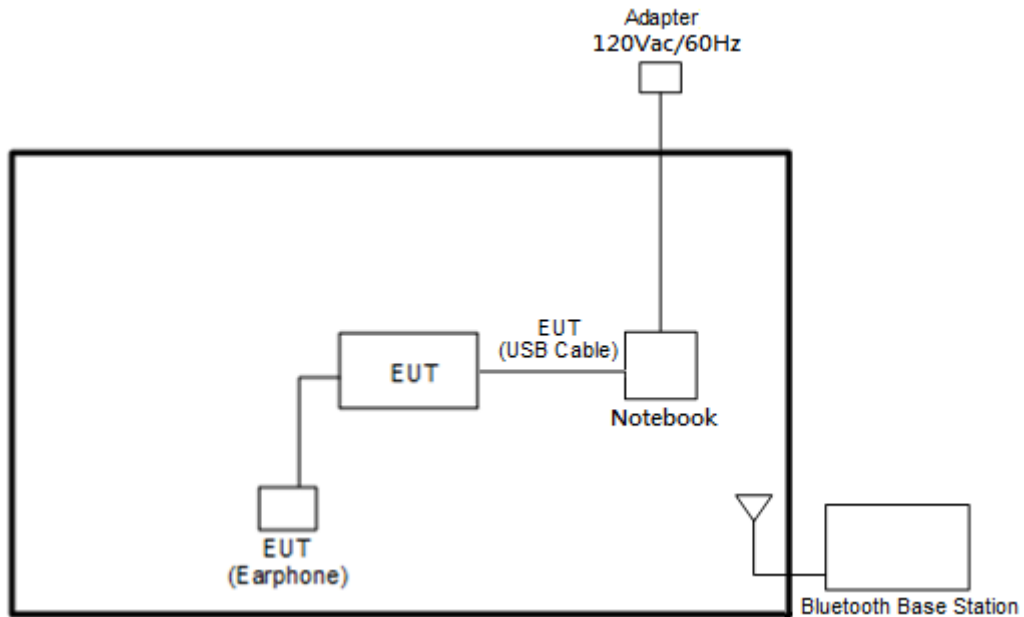

<AC Conducted Emission Mode>

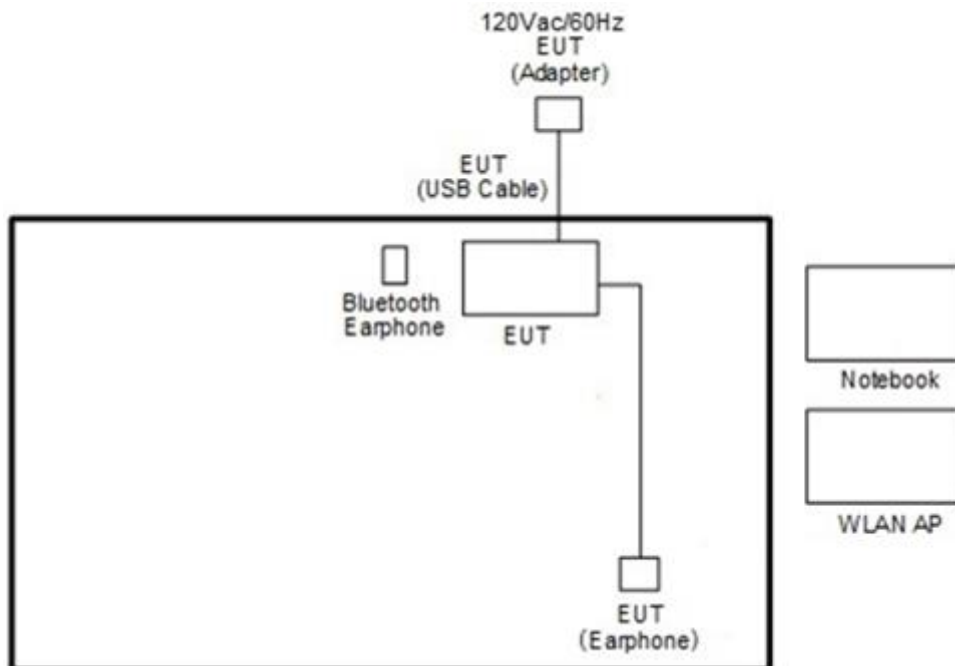



2.5 Support Unit used in test configuration and system

| Item | Equipment | Trade Name | Model Name | FCC ID | Data Cable | Power Cord |
|------|------------------------|------------|----------------|--|------------|--|
| 1. | Bluetooth Base Station | R&S | CBT32 | N/A | N/A | Unshielded, 1.8 m |
| 2. | Bluetooth Earphone | Sony | SBH20 | PY7-RD0010 | N/A | N/A |
| 3. | WLAN AP | ASUS | RT-AC66U | MSQ-RTAC66U | N/A | Unshielded,1.8m |
| 4. | Notebook | DELL | Latitude E6320 | FCC DoC/ Contains FCC ID: QDS-BRCM1054 | N/A | AC I/P: Unshielded, 1.2 m DC O/P: Shielded, 1.8 m |
| 5. | SD Card | SanDisk | MicroSD HC | FCC DoC | N/A | N/A |

2.6 UT Operation Test Setup

The RF test items utility, an engineering test program was programmed in order to make the EUT get into the engineering modes to contact with base station for continuous transmitting.

2.7 Measurement Results Explanation Example

For all conducted test items:

The offset level is set in the spectrum analyzer to compensate the RF cable loss and attenuator factor between EUT conducted output port and spectrum analyzer. With the offset compensation, the spectrum analyzer reading level is exactly the EUT RF output level.

Example:

The spectrum analyzer offset is derived from RF cable loss and attenuator factor.

Offset = RF cable loss + attenuator factor.

Following shows an offset computation example with cable loss 4.2 dB and 10dB attenuator.

$$\begin{aligned} \text{Offset(dB)} &= \text{RF cable loss(dB)} + \text{attenuator factor(dB)}. \\ &= 4.2 + 10 = 14.2 \text{ (dB)} \end{aligned}$$

3 Test Result

3.1 Number of Channel Measurement

3.1.1 Limits of Number of Hopping Frequency

Frequency hopping systems in the 2400-2483.5 MHz band shall use at least 15 channels.

3.1.2 Measuring Instruments

The measuring equipment is listed in the section 4 of this test report.

3.1.3 Test Procedure

1. The testing follows ANSI C63.10-2013 clause 7.8.3.
2. The RF output of EUT was connected to the spectrum analyzer by RF cable and attenuator. The path loss was compensated to the results for each measurement.
3. Set to the maximum power setting and enable the EUT transmit continuously.
4. Enable the EUT hopping function.
5. Use the following spectrum analyzer settings: Span = the frequency band of operation; RBW = 300kHz; VBW \geq RBW; Sweep = auto; Detector function = peak; Trace = max hold.
6. The number of hopping frequency used is defined as the number of total channel.
7. Record the measurement data derived from spectrum analyzer.

3.1.4 Test Setup

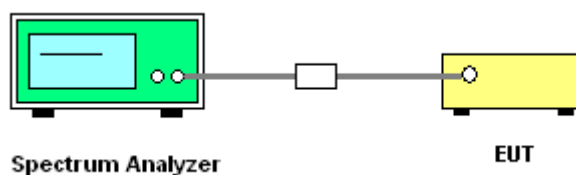

3.1.5 Test Result of Number of Hopping Frequency

Please refer to Appendix A.



Number of Hopping Channel Plot on Channel 00 - 78

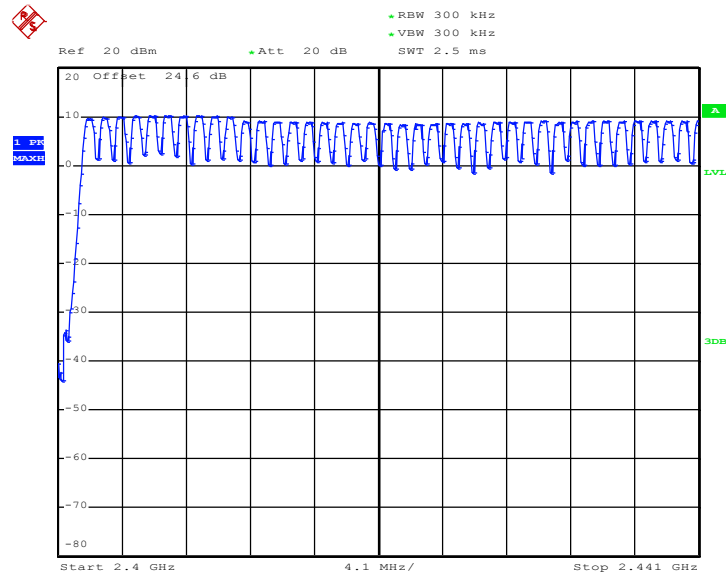

Date: 23.AUG.2017 01:24:20

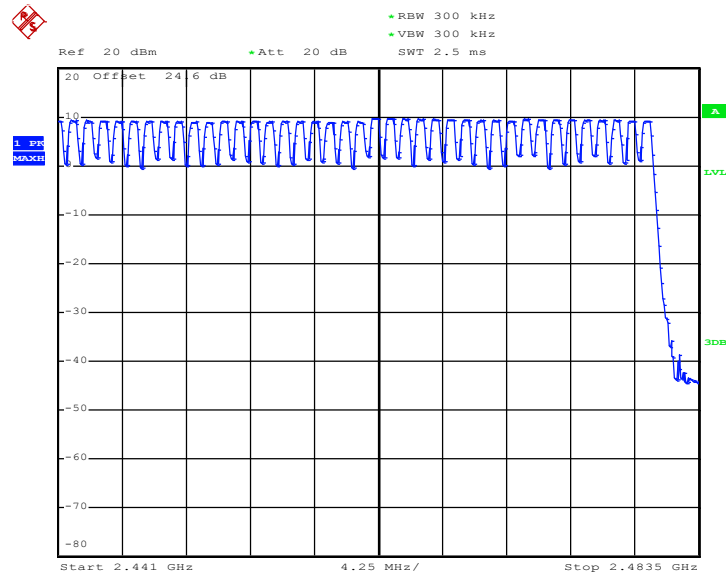

Date: 23.AUG.2017 01:27:28

3.2 Hopping Channel Separation Measurement

3.2.1 Limit of Hopping Channel Separation

Frequency hopping systems operating in the 2400-2483.5 MHz band may have hopping channel carrier frequencies that are separated by 25 kHz or two-thirds of the 20 dB bandwidth of the hopping channel, whichever is greater.

3.2.2 Measuring Instruments

The measuring equipment is listed in the section 4 of this test report.

3.2.3 Test Procedures

1. The testing follows ANSI C63.10-2013 clause 7.8.2.
2. The RF output of EUT was connected to the spectrum analyzer by RF cable and attenuator. The path loss was compensated to the results for each measurement.
3. Set to the maximum power setting and enable the EUT transmit continuously.
4. Enable the EUT hopping function.
5. Use the following spectrum analyzer settings:
Span = wide enough to capture the peaks of two adjacent channels;
RBW = 300kHz; VBW \geq RBW; Sweep = auto; Detector function = peak; Trace = max hold.
6. Measure and record the results in the test report.

3.2.4 Test Setup

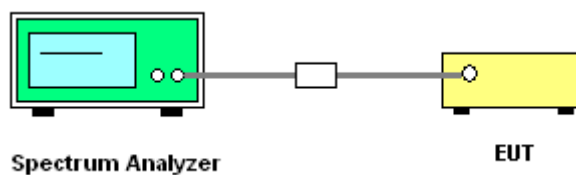



3.2.5 Test Result of Hopping Channel Separation

Please refer to Appendix A.

<1Mbps>

Channel Separation Plot on Channel 00 - 01

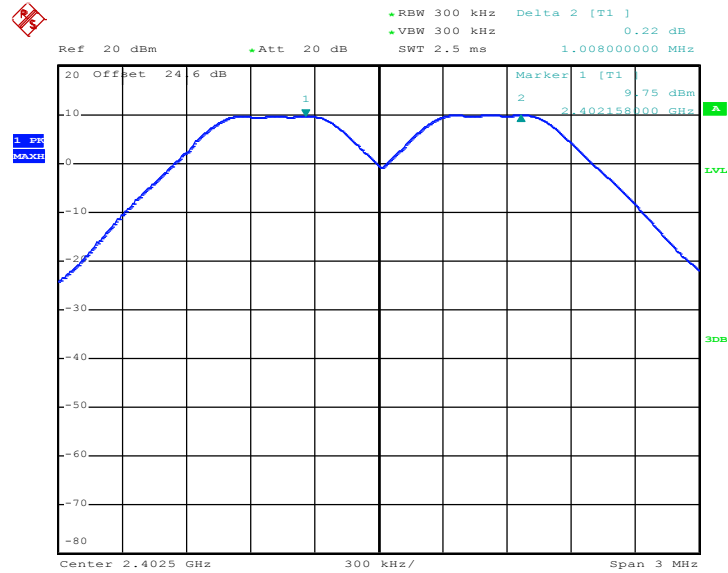

Date: 23.AUG.2017 01:34:39



Channel Separation Plot on Channel 39 - 40

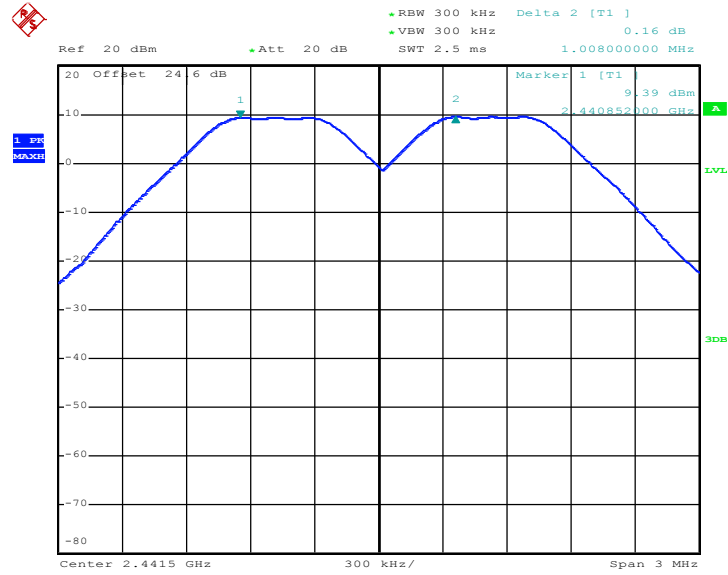

Date: 23.AUG.2017 03:49:46

Channel Separation Plot on Channel 77 - 78

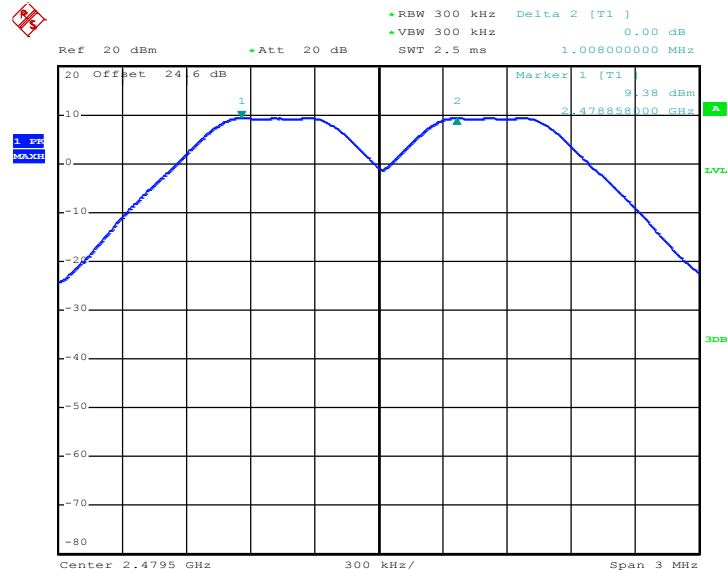

Date: 23.AUG.2017 05:03:35



<2Mbps>

Channel Separation Plot on Channel 00 - 01

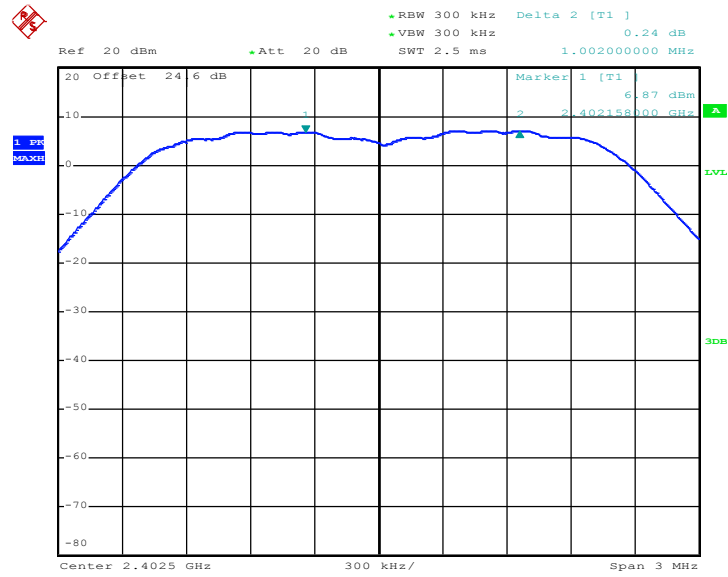

Date: 23.AUG.2017 05:19:44

Channel Separation Plot on Channel 39 - 40

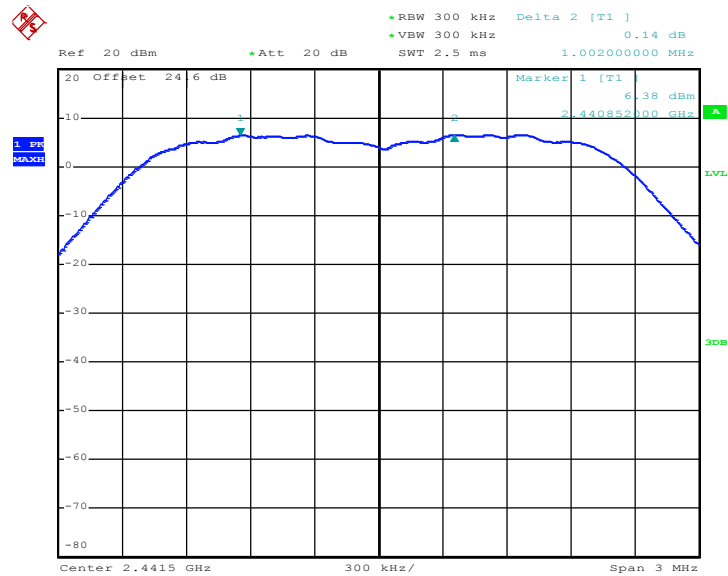

Date: 23.AUG.2017 05:28:45



Channel Separation Plot on Channel 77 - 78

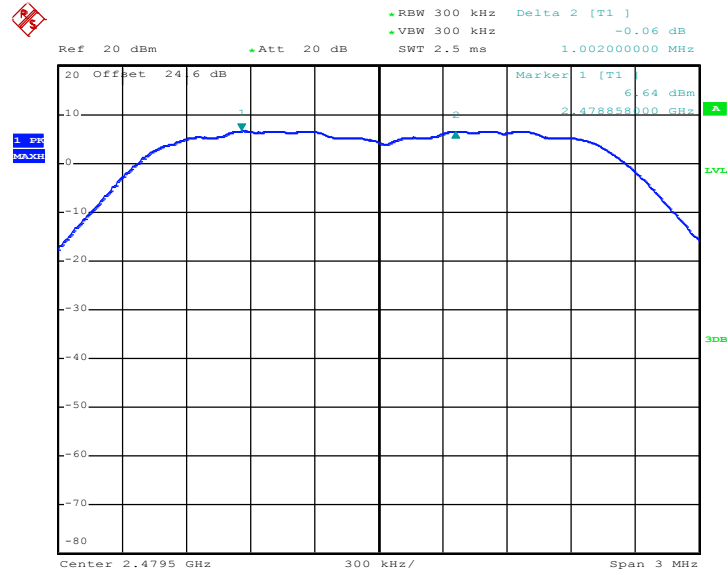

Date: 23.AUG.2017 05:39:36

<3Mbps>

Channel Separation Plot on Channel 00 - 01

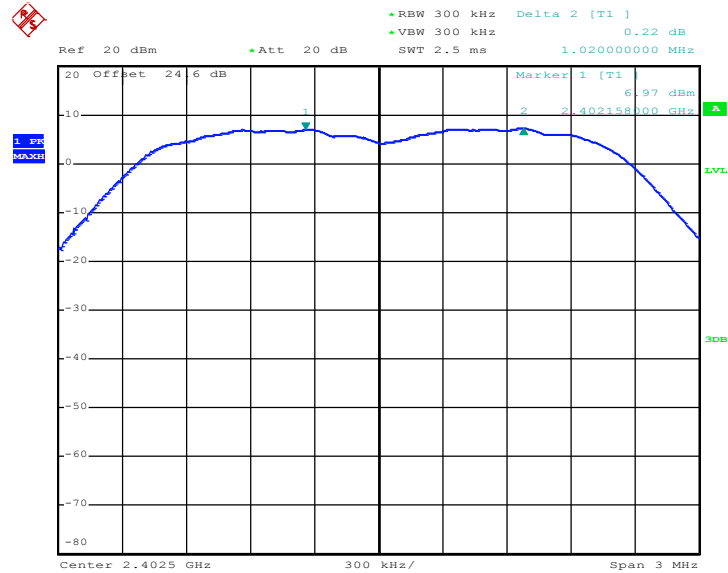

Date: 23.AUG.2017 05:58:04



Channel Separation Plot on Channel 39 - 40

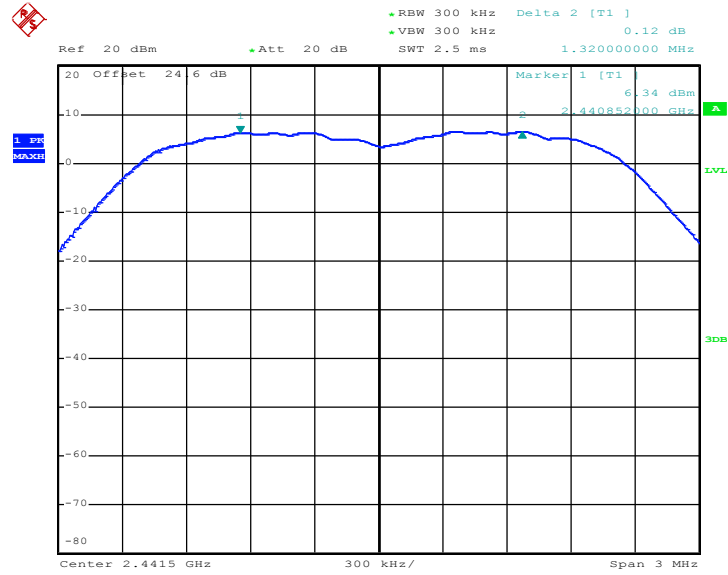

Date: 23.AUG.2017 06:12:49

Channel Separation Plot on Channel 77 - 78

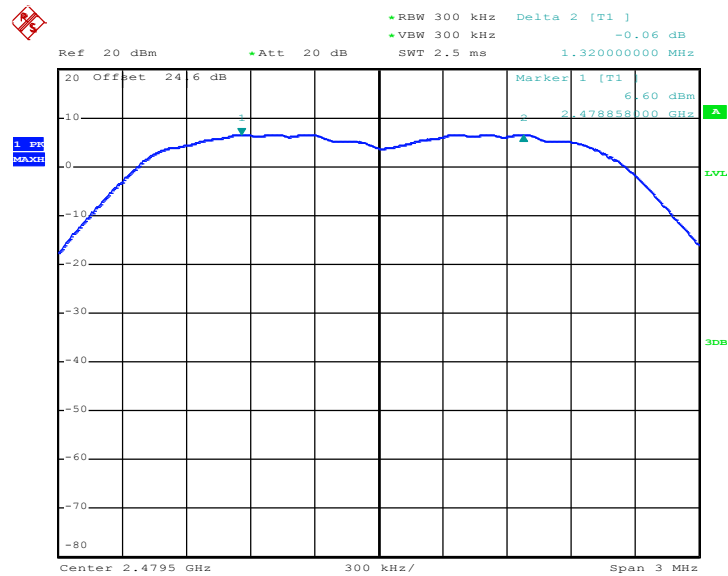

Date: 23.AUG.2017 06:27:02

3.3 Dwell Time Measurement

3.3.1 Limit of Dwell Time

The average time of occupancy on any channel shall not be greater than 0.4 seconds within a period of 0.4 seconds multiplied by the number of hopping channels employed.

3.3.2 Measuring Instruments

The measuring equipment is listed in the section 4 of this test report.

3.3.3 Test Procedures

1. The testing follows ANSI C63.10-2013 clause 7.8.4.
2. The RF output of EUT was connected to the spectrum analyzer by RF cable and attenuator. The path loss was compensated to the results for each measurement.
3. Set to the maximum power setting and enable the EUT transmit continuously.
4. Enable the EUT hopping function.
5. Use the following spectrum analyzer settings: Span = zero span, centered on a hopping channel; RBW = 1 MHz; VBW \geq RBW; Sweep = as necessary to capture the entire dwell time per hopping channel; Detector function = peak; Trace = max hold.
6. Measure and record the results in the test report.

3.3.4 Test Setup





3.3.5 Test Result of Dwell Time

Please refer to Appendix A.

Remark:

1. In normal mode, hopping rate is 1600 hops/s with 6 slots in 79 hopping channels.
With channel hopping rate (1600 / 6 / 79) in Occupancy Time Limit (0.4 x 79) (s),
Hops Over Occupancy Time comes to (1600 / 6 / 79) x (0.4 x 79) = 106.67 hops.
2. In AFH mode, hopping rate is 800 hops/s with 6 slots in 20 hopping channels.
With channel hopping rate (800 / 6 / 20) in Occupancy Time Limit (0.4 x 20) (s),
Hops Over Occupancy Time comes to (800 / 6 / 20) x (0.4 x 20) = 53.33 hops.
3. Dwell Time(s) = Hops Over Occupancy Time (hops) x Package Transfer Time

Package Transfer Time Plot

<1Mbps>

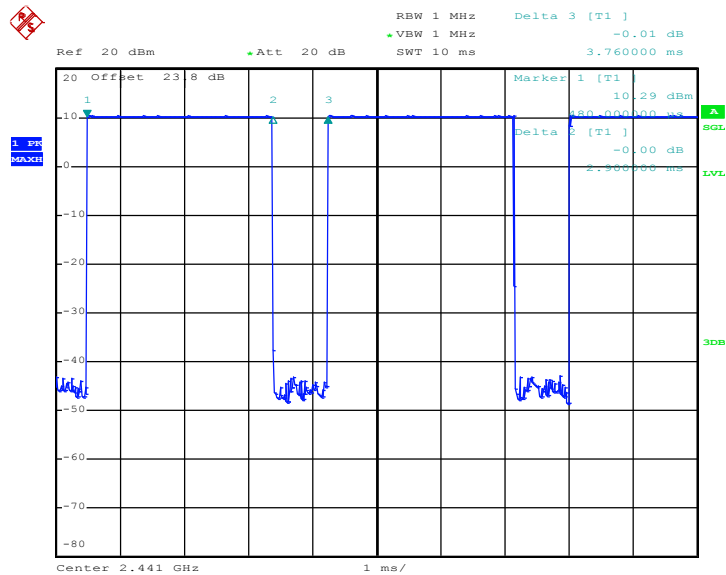

Date: 11.AUG.2017 16:45:42



<2Mbps>

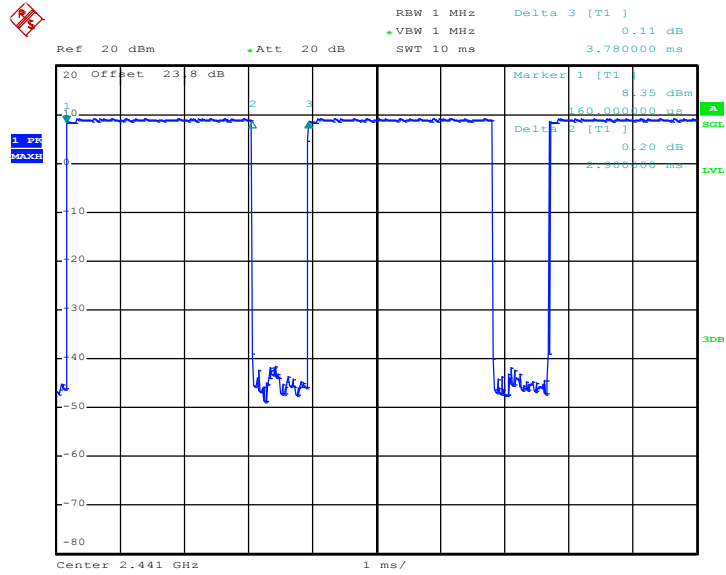

Date: 11.AUG.2017 16:49:44

<3Mbps>

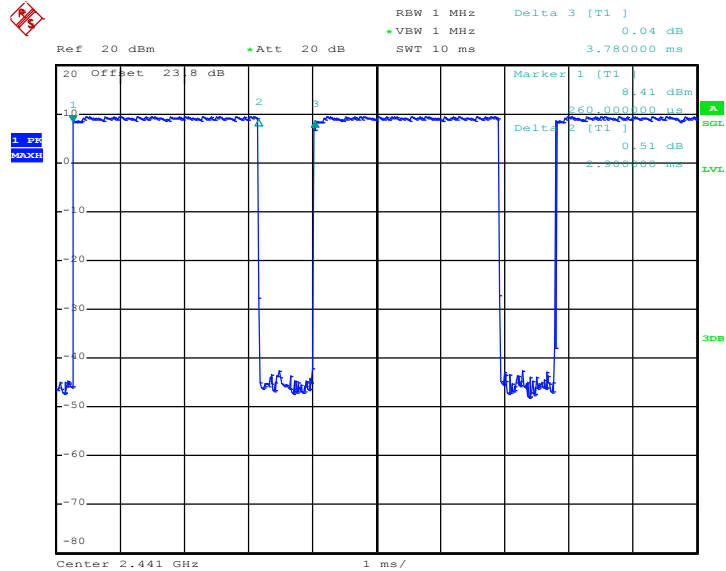

Date: 11.AUG.2017 16:53:22

3.4 20dB and 99% Bandwidth Measurement

3.4.1 Limit of 20dB and 99% Bandwidth

Reporting only

3.4.2 Measuring Instruments

The measuring equipment is listed in the section 4 of this test report.

3.4.3 Test Procedures

1. The testing follows ANSI C63.10-2013 clause 6.9.2 and 6.9.3.
2. The RF output of EUT was connected to the spectrum analyzer by RF cable and attenuator. The path loss was compensated to the results for each measurement.
3. Set to the maximum power setting and enable the EUT transmit continuously.
4. Use the following spectrum analyzer settings for 20dB Bandwidth measurement.
Span = approximately 2 to 5 times the 20 dB bandwidth, centered on a hopping channel;
RBW \geq 1% of the 20 dB bandwidth; VBW \geq RBW; Sweep = auto; Detector function = peak;
Trace = max hold.
5. Use the following spectrum analyzer settings for 99 % Bandwidth measurement.
Span = approximately 1.5 to 5 times the 99% bandwidth, centered on a hopping channel;
RBW \geq 1% of the 99% bandwidth; VBW \geq RBW; Sweep = auto; Detector function = peak;
Trace = max hold.
6. Measure and record the results in the test report.

3.4.4 Test Setup



3.4.5 Test Result of 20dB Bandwidth

Please refer to Appendix A.



<1Mbps>

20 dB Bandwidth Plot on Channel 00

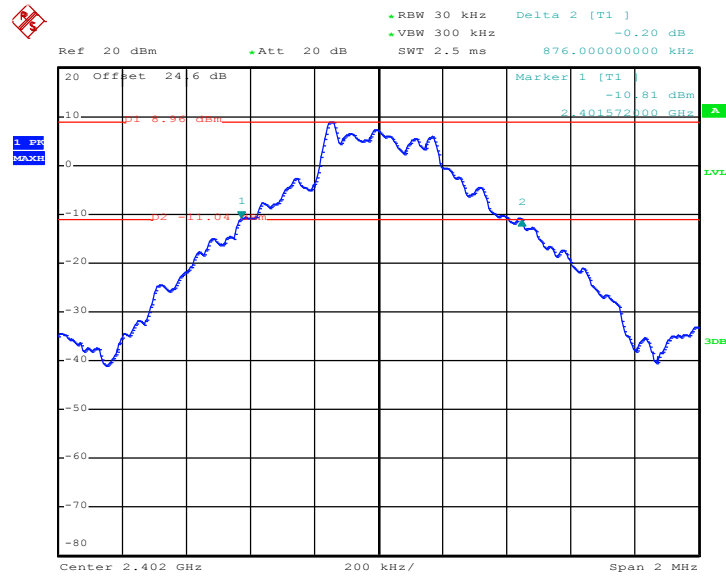

Date: 23.AUG.2017 01:07:32

20 dB Bandwidth Plot on Channel 39

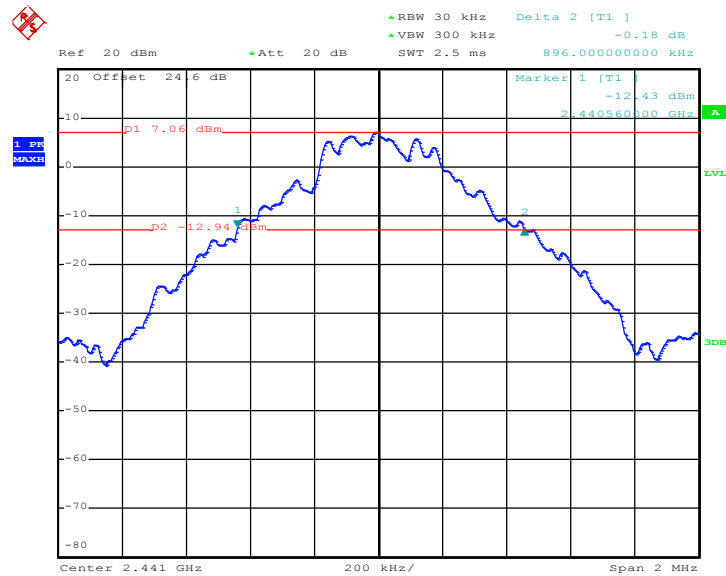

Date: 23.AUG.2017 03:44:05



20 dB Bandwidth Plot on Channel 78

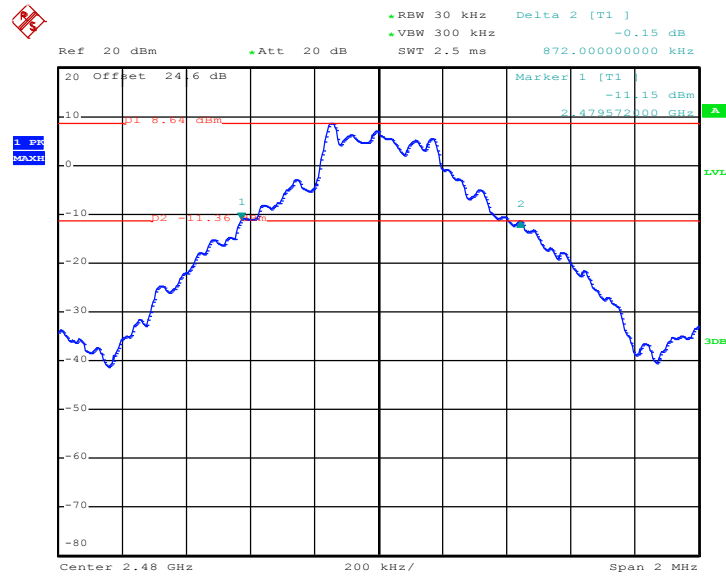

Date: 23.AUG.2017 04:27:59

<2Mbps>

20 dB Bandwidth Plot on Channel 00

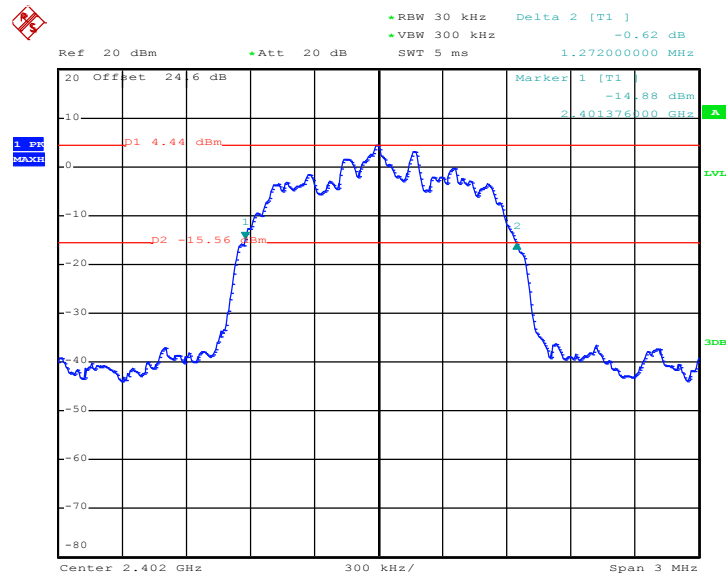

Date: 23.AUG.2017 05:11:55



20 dB Bandwidth Plot on Channel 39

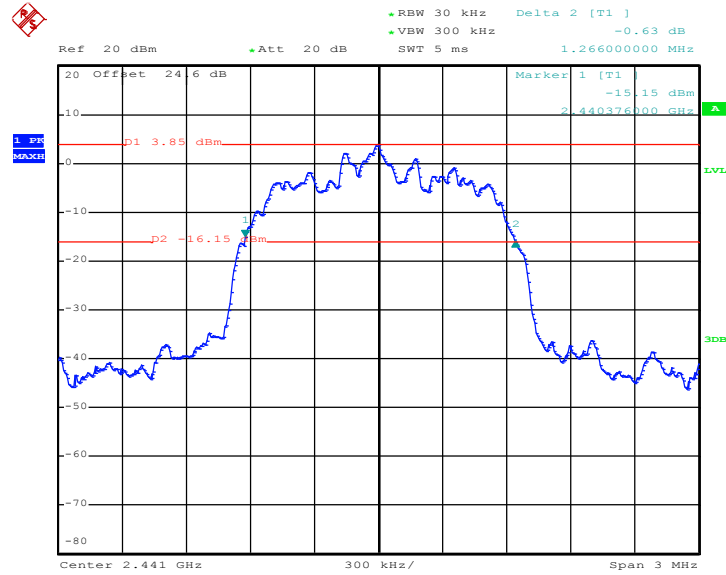

Date: 23.AUG.2017 05:24:20

20 dB Bandwidth Plot on Channel 78

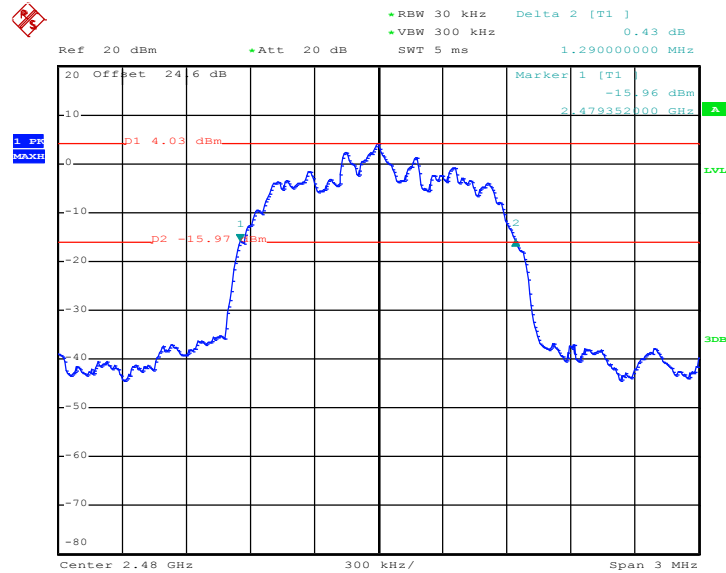

Date: 23.AUG.2017 05:35:27



<3Mbps>

20 dB Bandwidth Plot on Channel 00

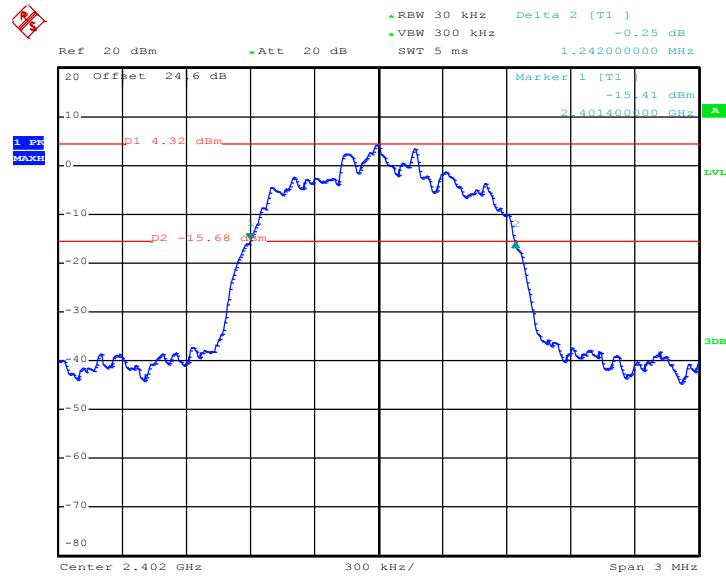

Date: 23.AUG.2017 05:44:19

20 dB Bandwidth Plot on Channel 39

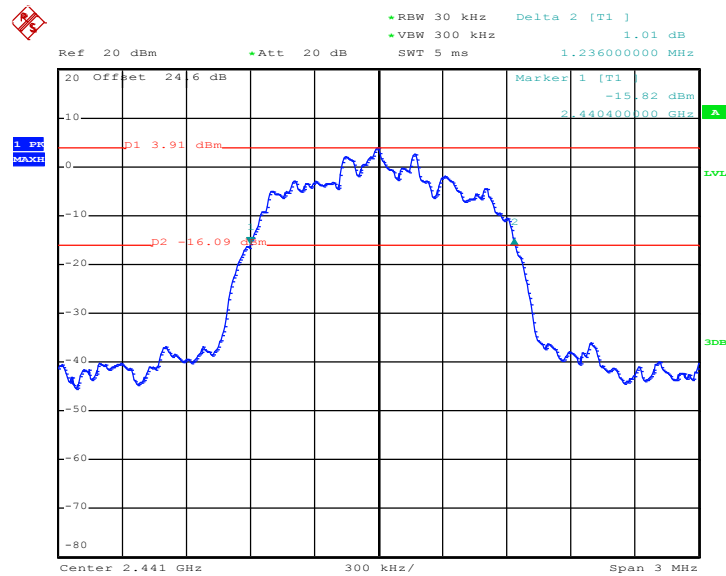

Date: 23.AUG.2017 06:04:56



20 dB Bandwidth Plot on Channel 78

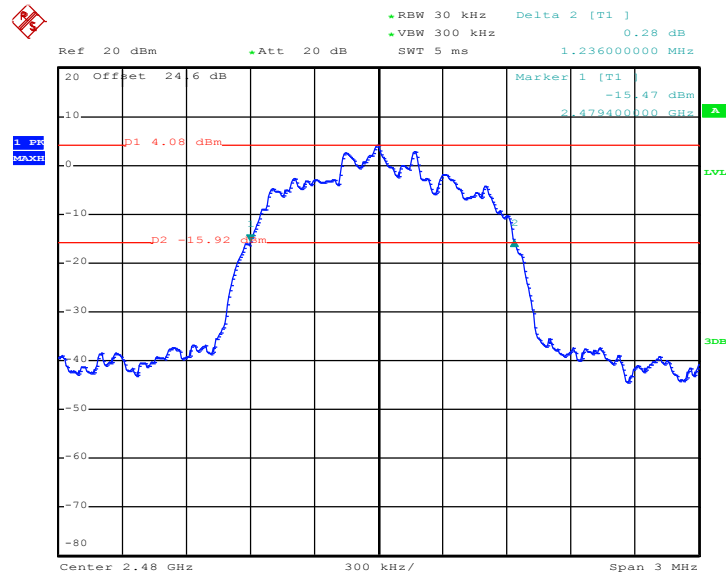

Date: 23.AUG.2017 06:22:10



3.4.6 Test Result of 99% Occupied Bandwidth

Please refer to Appendix A.

<1Mbps>

99% Occupied Bandwidth Plot on Channel 00

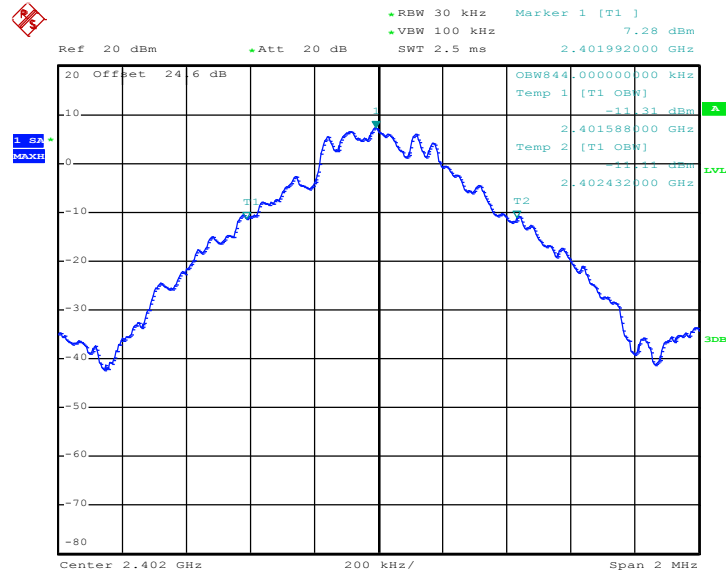

Date: 23.AUG.2017 01:35:38



99% Occupied Bandwidth Plot on Channel 39

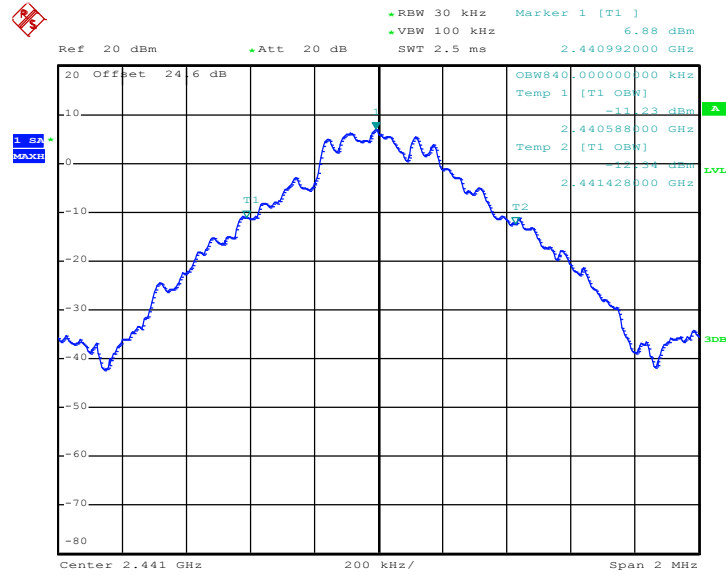

Date: 23.AUG.2017 03:51:29

99% Occupied Bandwidth Plot on Channel 78

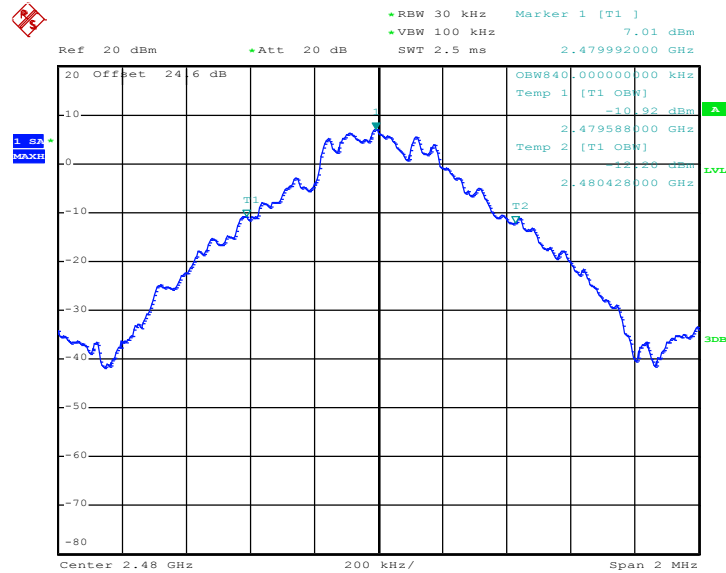

Date: 23.AUG.2017 05:06:16



<2Mbps>

99% Occupied Bandwidth Plot on Channel 00

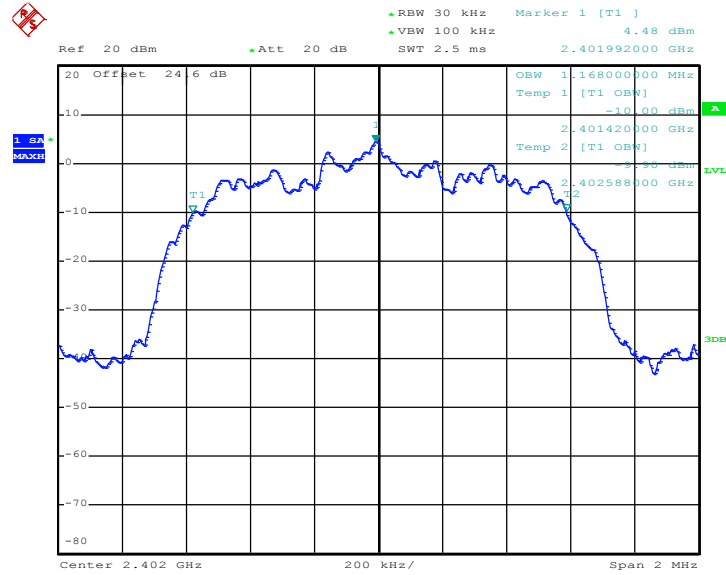

Date: 23.AUG.2017 05:20:25

99% Occupied Bandwidth Plot on Channel 39

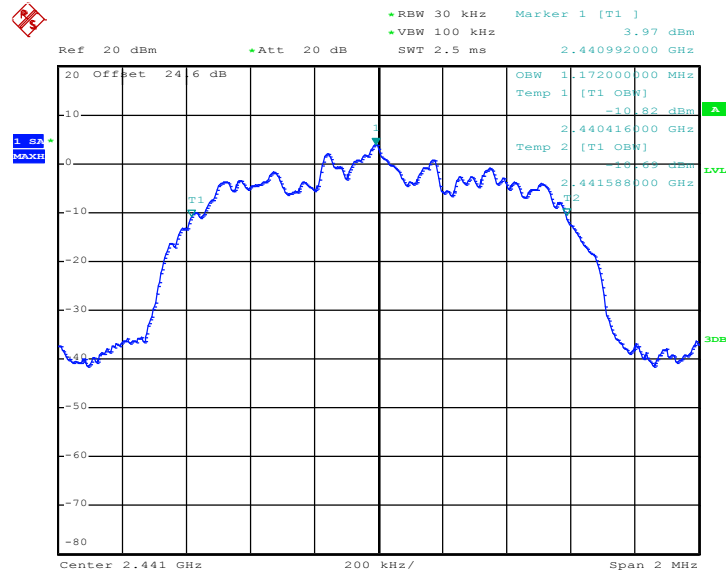

Date: 23.AUG.2017 05:29:28



99% Occupied Bandwidth Plot on Channel 78

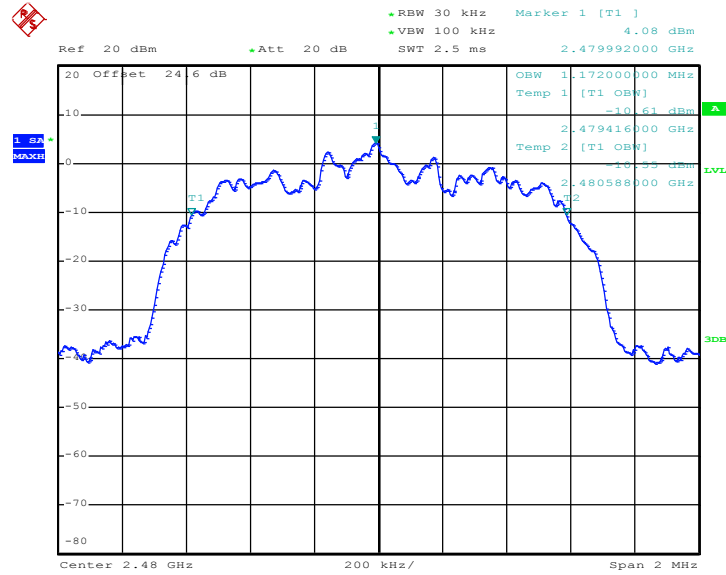

Date: 23.AUG.2017 05:40:17

<3Mbps>

99% Occupied Bandwidth Plot on Channel 00

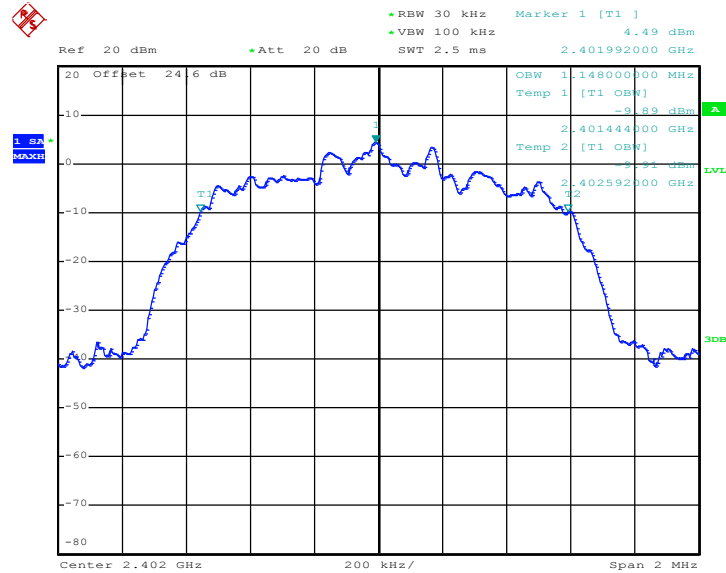

Date: 23.AUG.2017 05:58:52



99% Occupied Bandwidth Plot on Channel 39

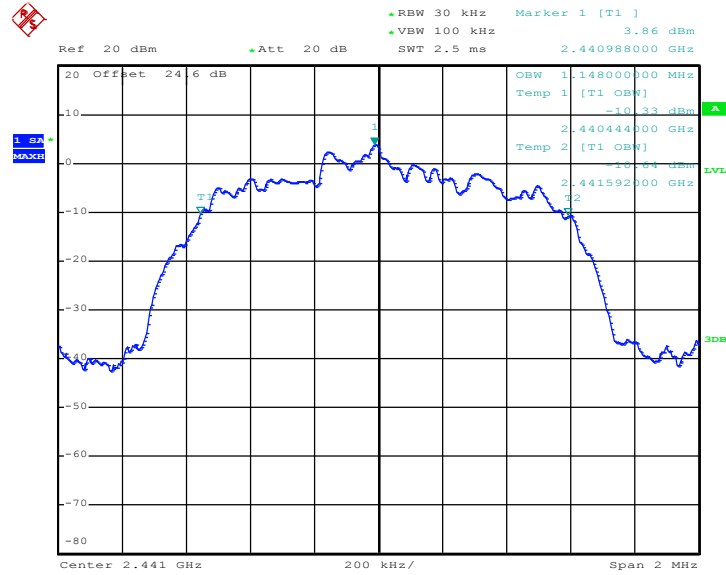

Date: 23.AUG.2017 06:13:28

99% Occupied Bandwidth Plot on Channel 78

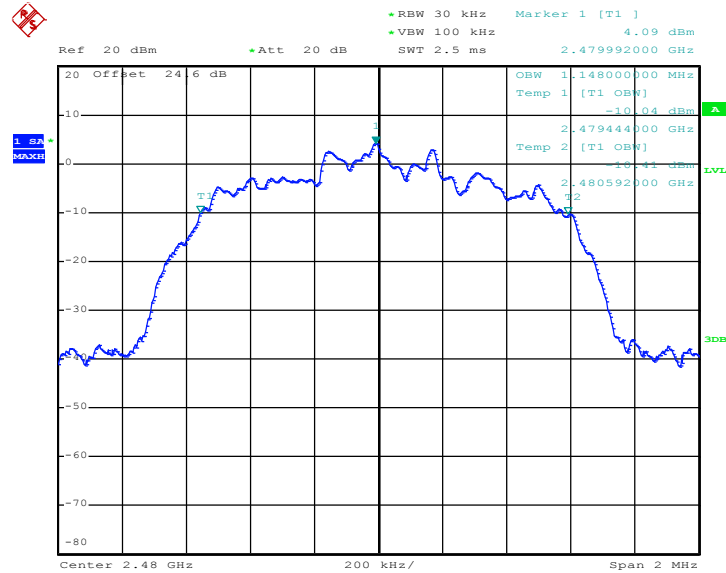

Date: 23.AUG.2017 06:27:41

Note : The occupied channel bandwidth is maintained within the band of operation for all of the modulations.

3.5 Peak Output Power Measurement

3.5.1 Limit of Peak Output Power

Section 15.247 (b) The maximum peak conducted output power of the intentional radiator shall not exceed the following: (1) For frequency hopping systems operating in the 2400-2483.5 MHz band employing at least 75 non-overlapping hopping channels, and all frequency hopping systems in the 5725-5850 MHz band: 1 watt. For all other frequency hopping systems in the 2400-2483.5 MHz band 0.125 watts. The power limit for 1Mbps, 2Mbps, 3Mbps and AFH modes are 0.125 watts.

3.5.2 Measuring Instruments

The measuring equipment is listed in the section 4 of this test report.

3.5.3 Test Procedures

1. The testing follows ANSI C63.10-2013 clause 7.8.5.
2. The RF output of EUT was connected to the power meter by RF cable and attenuator. The path loss was compensated to the results for each measurement.
3. Set to the maximum power setting and enable the EUT transmit continuously.
4. Measure the conducted output power with cable loss and record the results in the test report.
5. Measure and record the results in the test report.

3.5.4 Test Setup

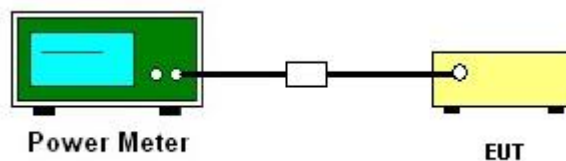

3.5.5 Test Result of Peak Output Power

Please refer to Appendix A.

3.6 Conducted Band Edges Measurement

3.6.1 Limit of Band Edges

In any 100 kHz bandwidth outside the intentional radiation frequency band, the radio frequency power shall be at least 20 dB below the highest level of the radiated power. In addition, radiated emissions which fall in the restricted bands must also comply with the radiated emission limits.

3.6.2 Measuring Instruments

The measuring equipment is listed in the section 4 of this test report.

3.6.3 Test Procedures

1. The testing follows ANSI C63.10-2013 clause 7.8.6.
2. Set to the maximum power setting and enable the EUT transmit continuously.
3. Set RBW = 100kHz, VBW = 300kHz. Band edge emissions must be at least 20 dB down from the highest emission level within the authorized band as measured with a 100kHz RBW. The attenuation shall be 30 dB instead of 20 dB when RMS conducted output power procedure is used.
4. Enable hopping function of the EUT and then repeat step 2. and 3.
5. Measure and record the results in the test report.

3.6.4 Test Setup

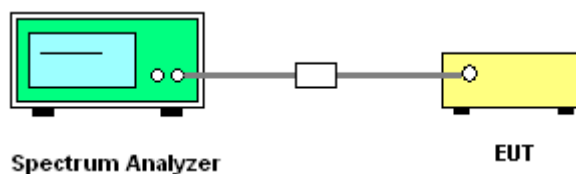



3.6.5 Test Result of Conducted Band Edges

<1Mbps>

Low Band Edge Plot on Channel 00

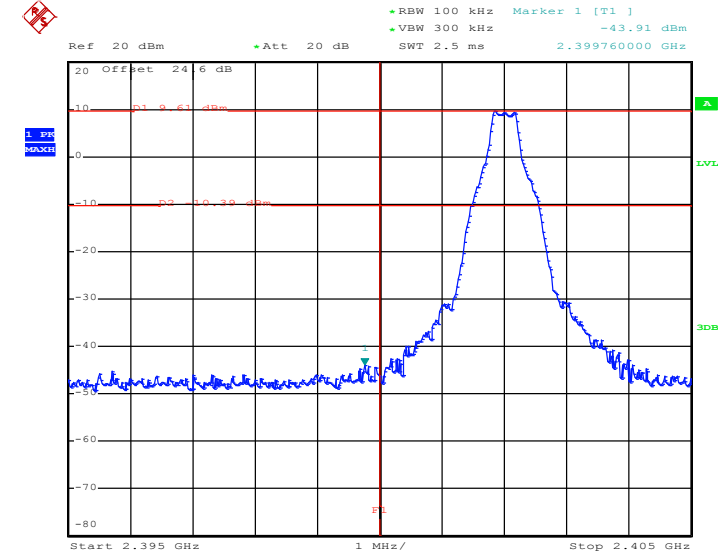

Date: 23.AUG.2017 01:11:34

High Band Edge Plot on Channel 78

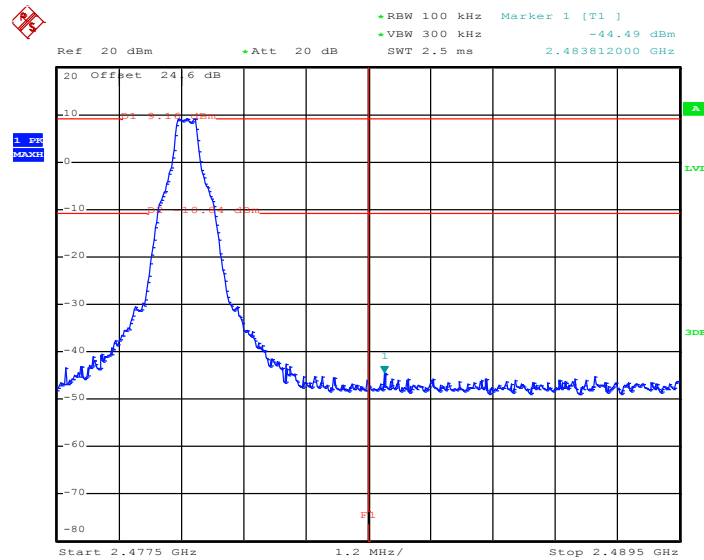

Date: 23.AUG.2017 04:39:40



<2Mbps>

Low Band Edge Plot on Channel 00

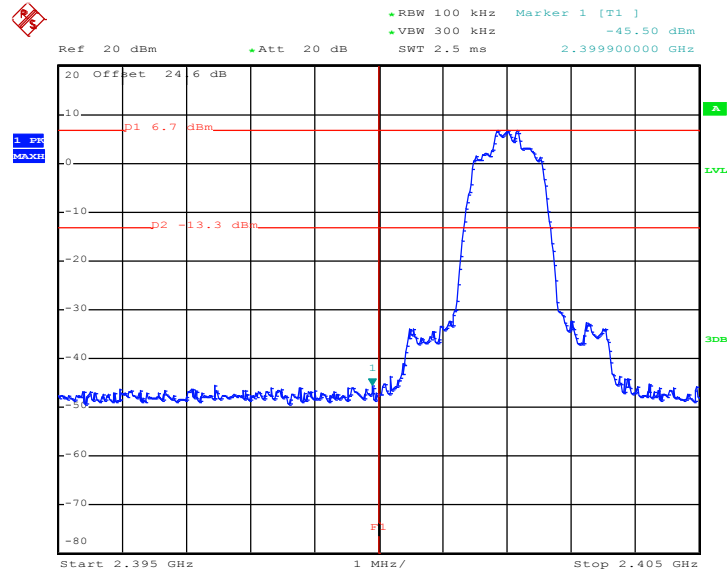

Date: 23.AUG.2017 05:13:59

High Band Edge Plot on Channel 78

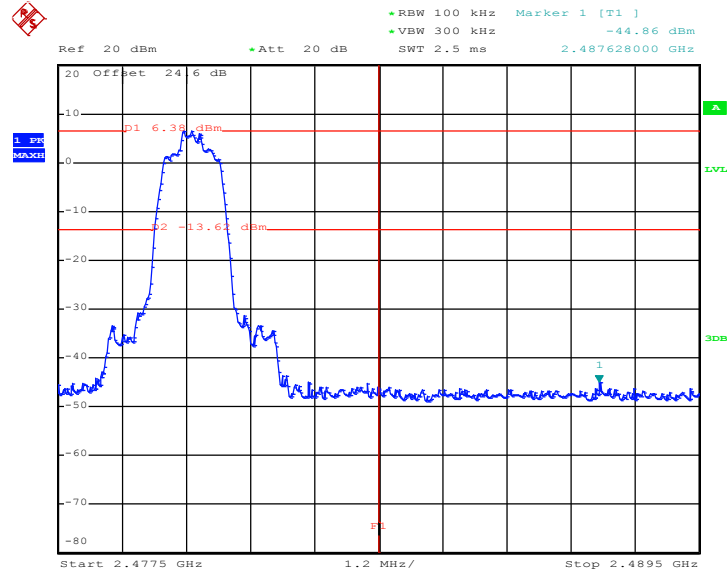

Date: 23.AUG.2017 05:36:47



<3Mbps>

Low Band Edge Plot on Channel 00

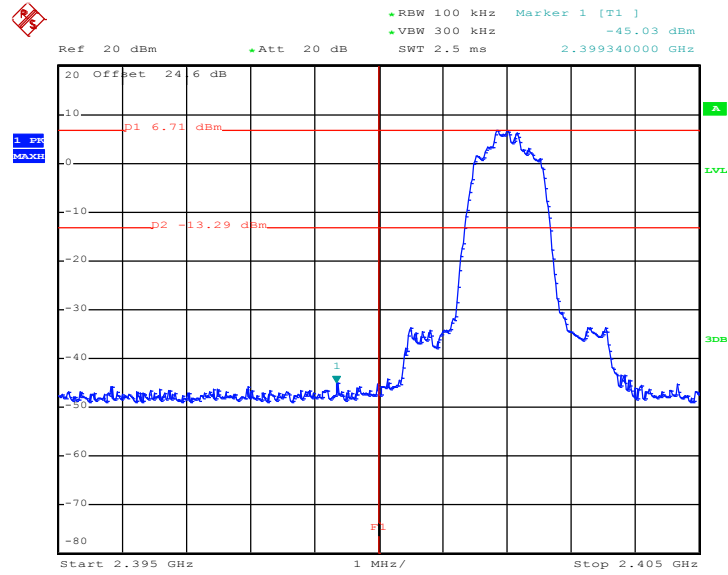

Date: 23.AUG.2017 05:45:52

High Band Edge Plot on Channel 78

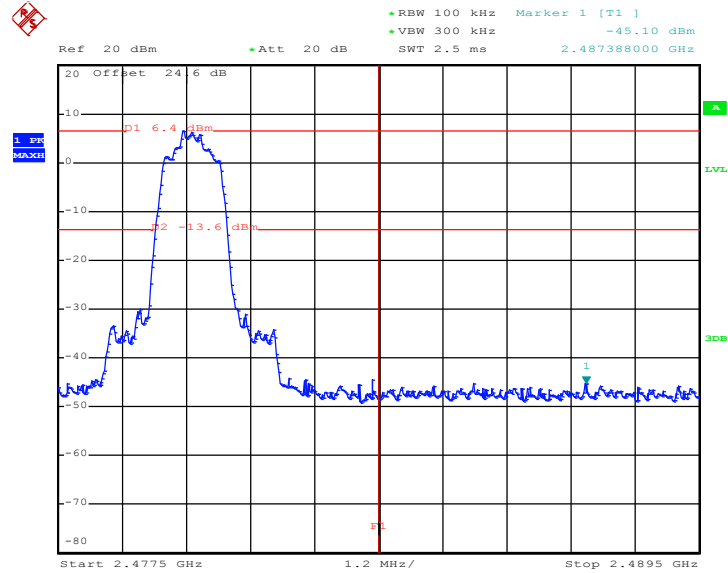

Date: 23.AUG.2017 06:24:36



3.6.6 Test Result of Conducted Hopping Mode Band Edges

1Mbps Hopping Mode Low Band Edge Plot

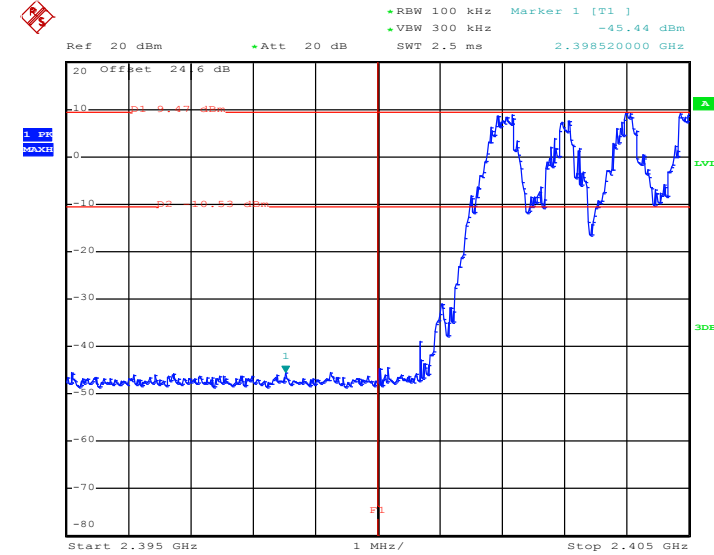

Date: 23.AUG.2017 01:14:09

1Mbps Hopping Mode High Band Edge Plot

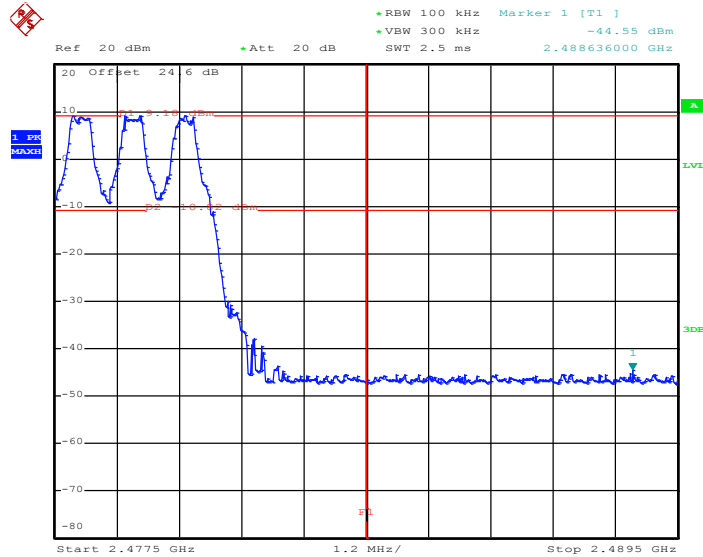

Date: 23.AUG.2017 04:38:48



2Mbps Hopping Mode Low Band Edge Plot

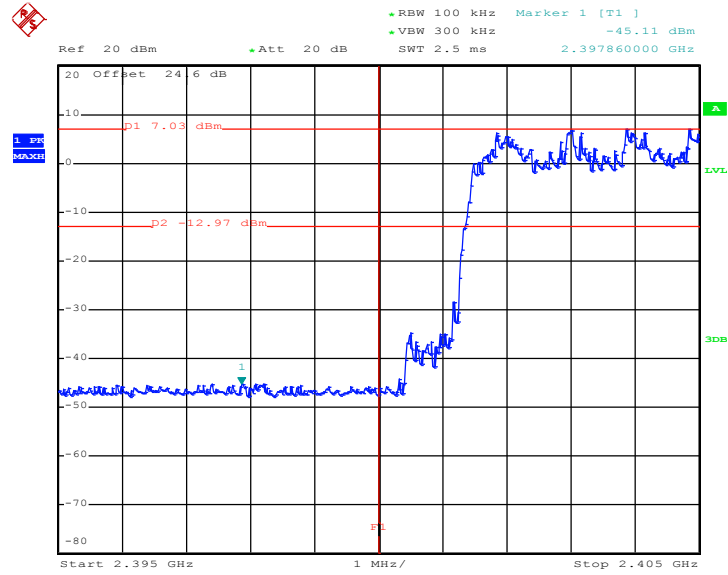

Date: 23.AUG.2017 05:17:55

2Mbps Hopping Mode High Band Edge Plot

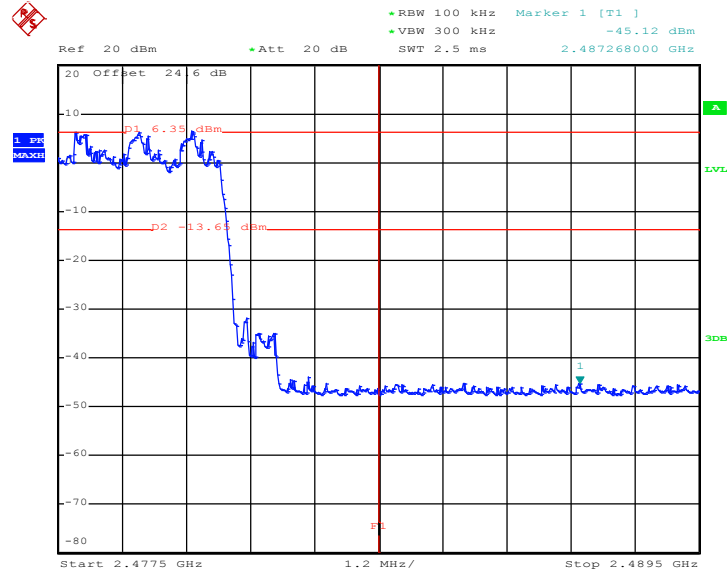

Date: 23.AUG.2017 05:38:36



3Mbps Hopping Mode Low Band Edge Plot

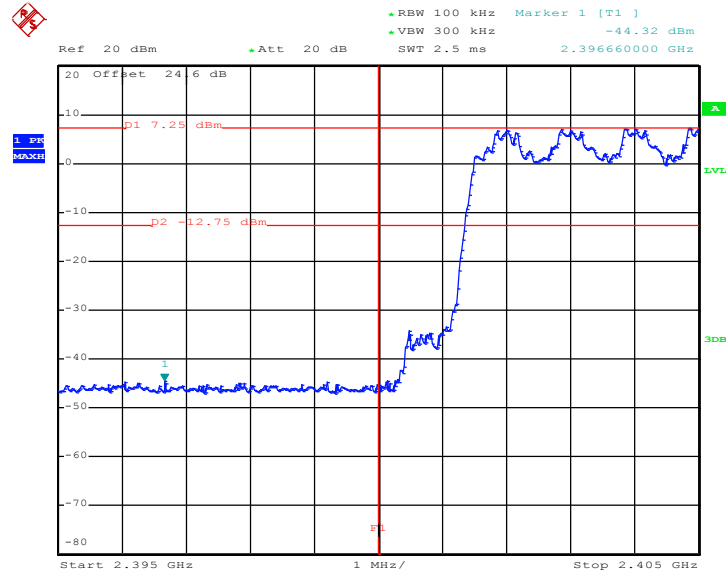

Date: 23.AUG.2017 05:56:18

3Mbps Hopping Mode High Band Edge Plot

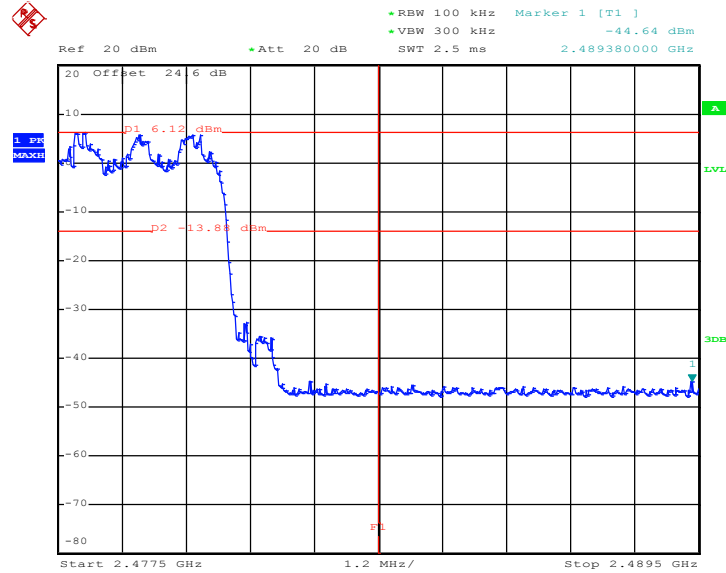

Date: 23.AUG.2017 06:26:04

3.7 Conducted Spurious Emission Measurement

3.7.1 Limit of Spurious Emission Measurement

In any 100 kHz bandwidth outside the intentional radiation frequency band, the radio frequency power shall be at least 20 dB below the highest level of the radiated power. In addition, radiated emissions which fall in the restricted bands must also comply with the radiated emission limits.

3.7.2 Measuring Instruments

The measuring equipment is listed in the section 4 of this test report.

3.7.3 Test Procedure

1. The testing follows ANSI C63.10-2013 clause 7.8.8.
2. The RF output of EUT was connected to the spectrum analyzer by RF cable and attenuator. The path loss was compensated to the results for each measurement.
3. Set to the maximum power setting and enable the EUT transmit continuously.
4. Set RBW = 100 kHz, VBW = 300kHz, scan up through 10th harmonic. All harmonics / spurs must be at least 20 dB down from the highest emission level within the authorized band as measured with a 100 kHz RBW.
5. Measure and record the results in the test report.
6. The RF fundamental frequency should be excluded against the limit line in the operating frequency band.

3.7.4 Test Setup

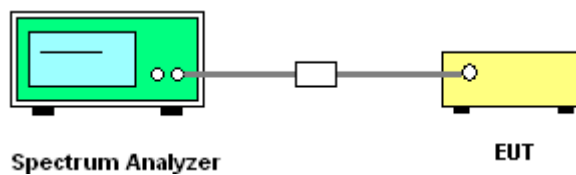



3.7.5 Test Result of Conducted Spurious Emission

1Mbps CSE Plot on Ch 00 between 30MHz ~ 3 GHz

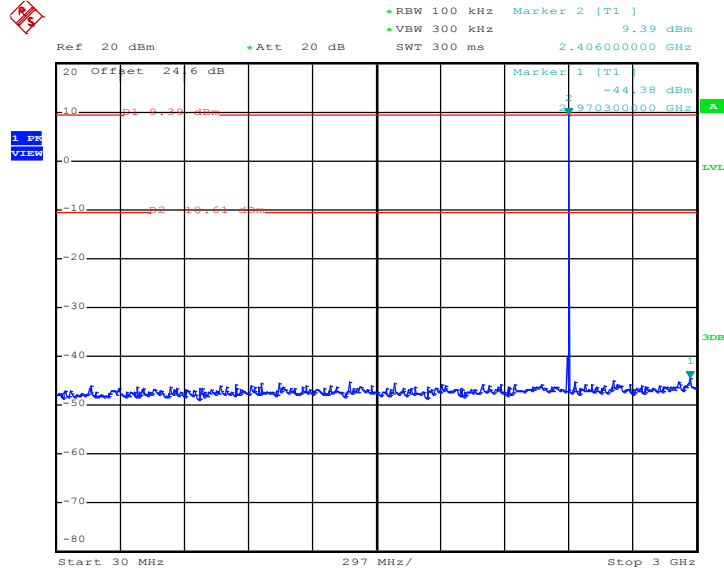

Date: 23.AUG.2017 01:37:11

1Mbps CSE Plot on Ch 00 between 2 GHz ~ 25 GHz

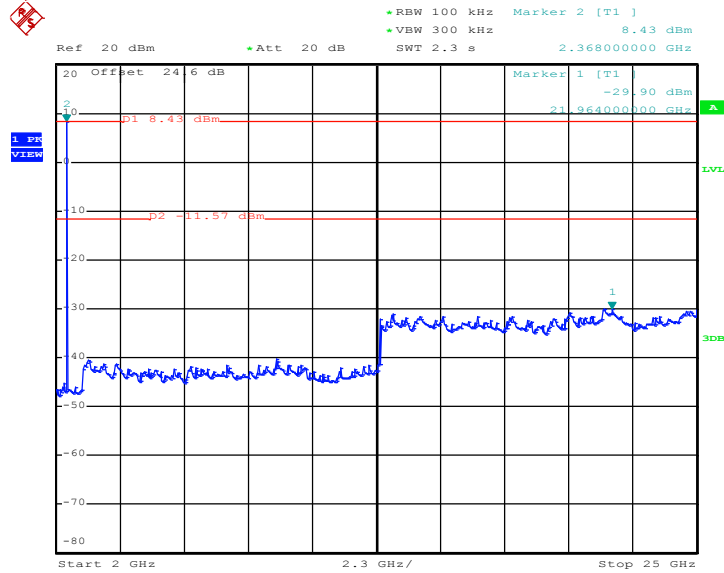

Date: 23.AUG.2017 01:37:33



1Mbps CSE Plot on Ch 39 between 30MHz ~ 3 GHz

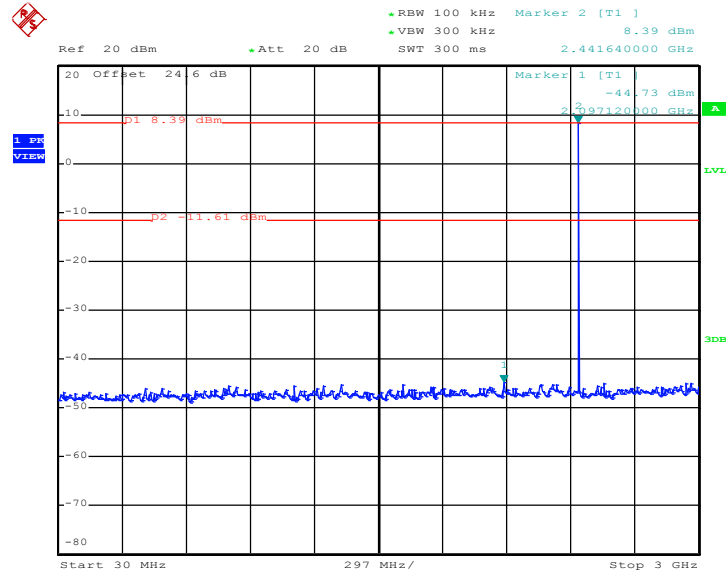

Date: 23.AUG.2017 03:58:15

1Mbps CSE Plot on Ch 39 between 2 GHz ~ 25 GHz

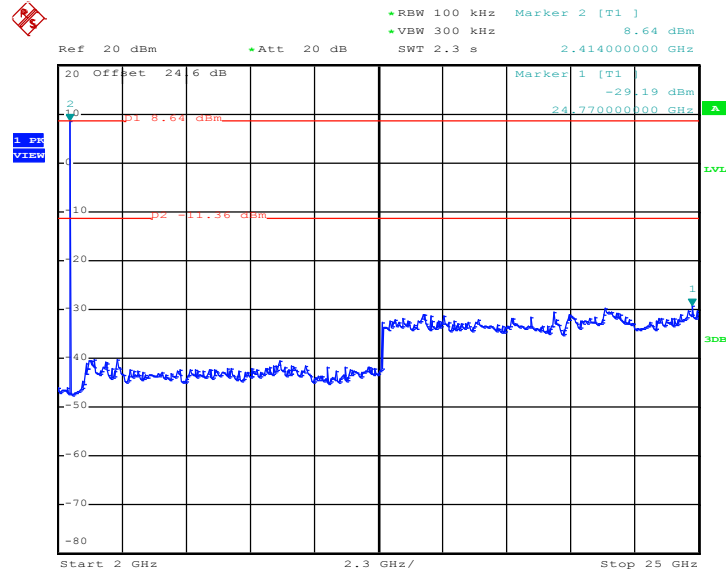

Date: 23.AUG.2017 03:58:37



1Mbps CSE Plot on Ch 78 between 30MHz ~ 3 GHz

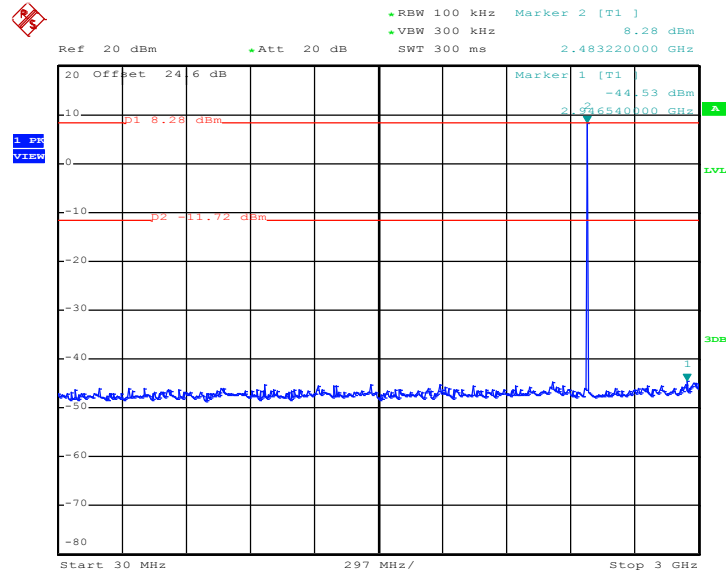

Date: 23.AUG.2017 05:06:41

1Mbps CSE Plot on Ch 78 between 2 GHz ~ 25 GHz

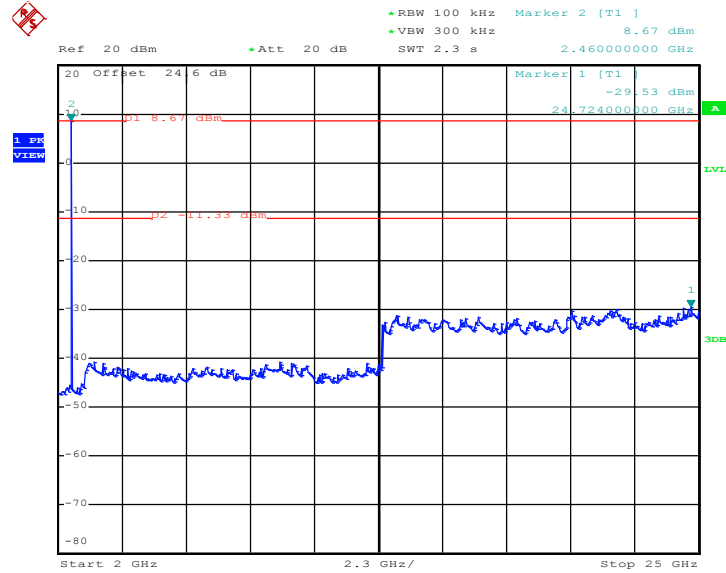

Date: 23.AUG.2017 05:07:03



2Mbps CSE Plot on Ch 00 between 30MHz ~ 3 GHz

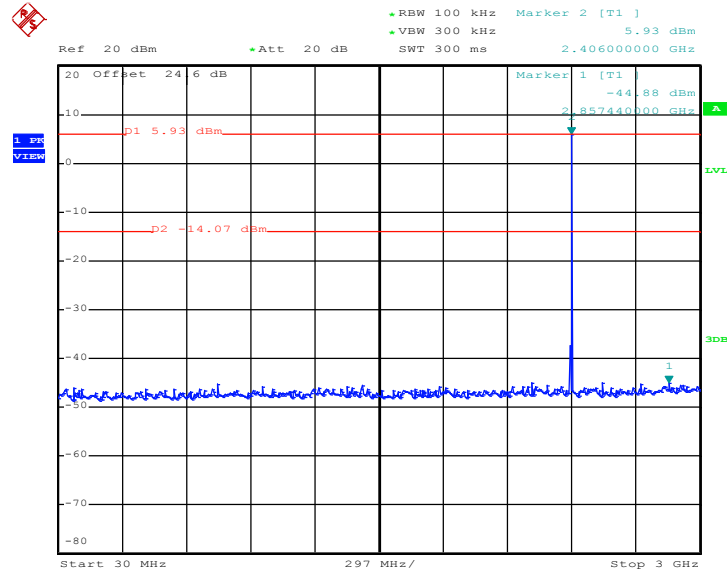

Date: 23.AUG.2017 05:20:50

2Mbps CSE Plot on Ch 00 between 2 GHz ~ 25 GHz

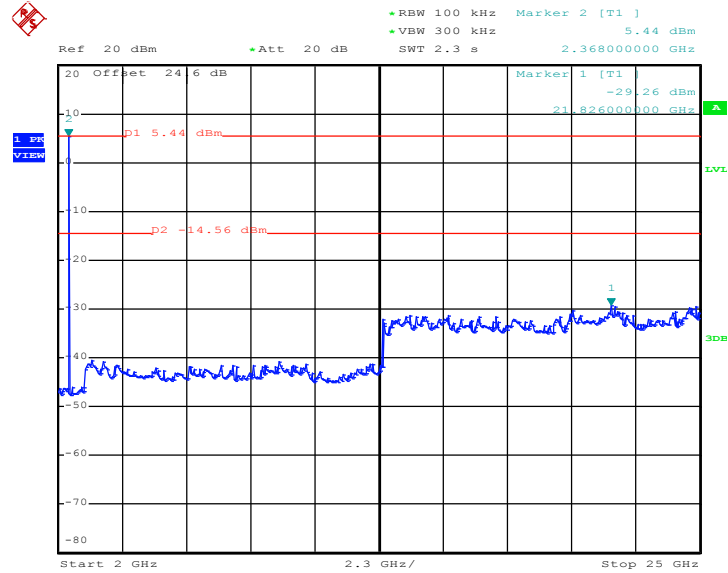

Date: 23.AUG.2017 05:21:12



2Mbps CSE Plot on Ch 39 between 30MHz ~ 3 GHz

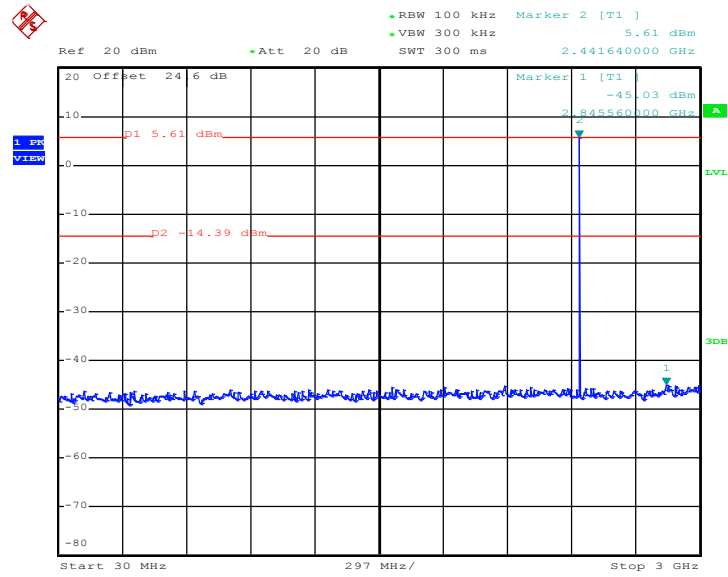

Date: 23.AUG.2017 05:29:59

2Mbps CSE Plot on Ch 39 between 2 GHz ~ 25 GHz

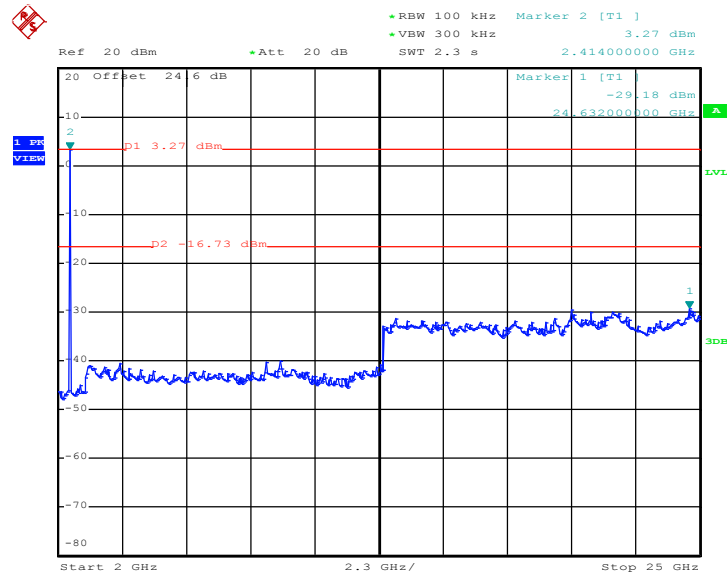

Date: 23.AUG.2017 05:30:20



2Mbps CSE Plot on Ch 78 between 30MHz ~ 3 GHz

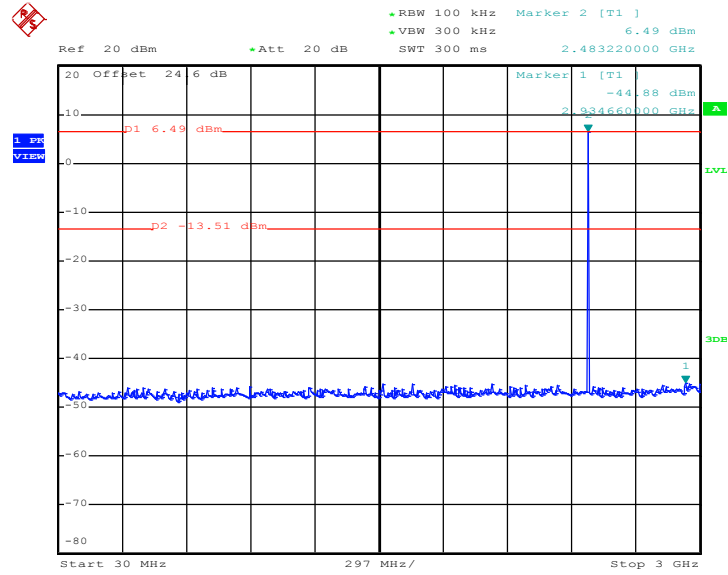

Date: 23.AUG.2017 05:40:42

2Mbps CSE Plot on Ch 78 between 2 GHz ~ 25 GHz

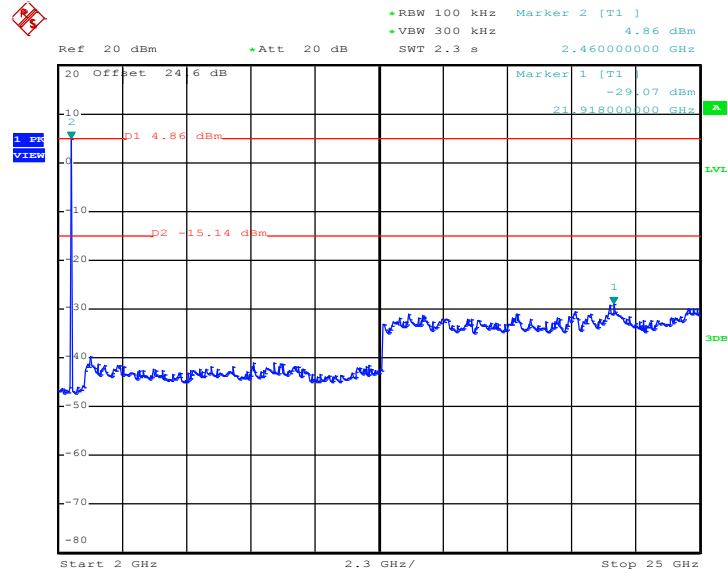

Date: 23.AUG.2017 05:41:04



3Mbps CSE Plot on Ch 00 between 30MHz ~ 3 GHz

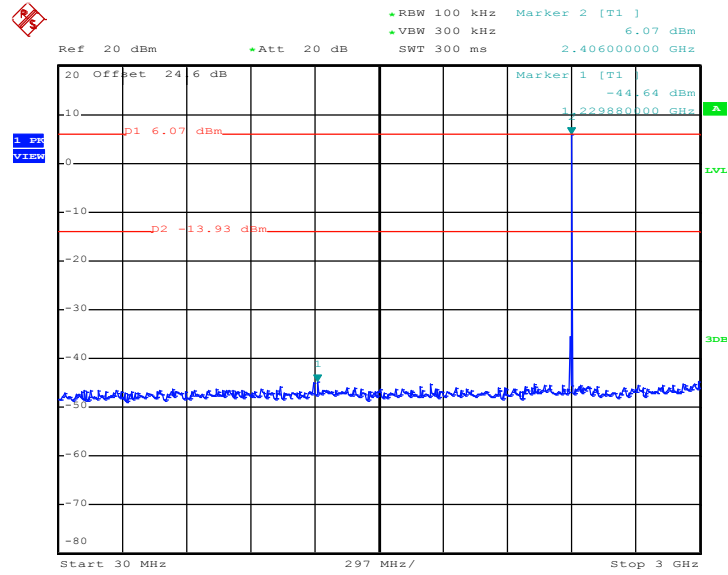

Date: 23.AUG.2017 05:59:17

3Mbps CSE Plot on Ch 00 between 2 GHz ~ 25 GHz

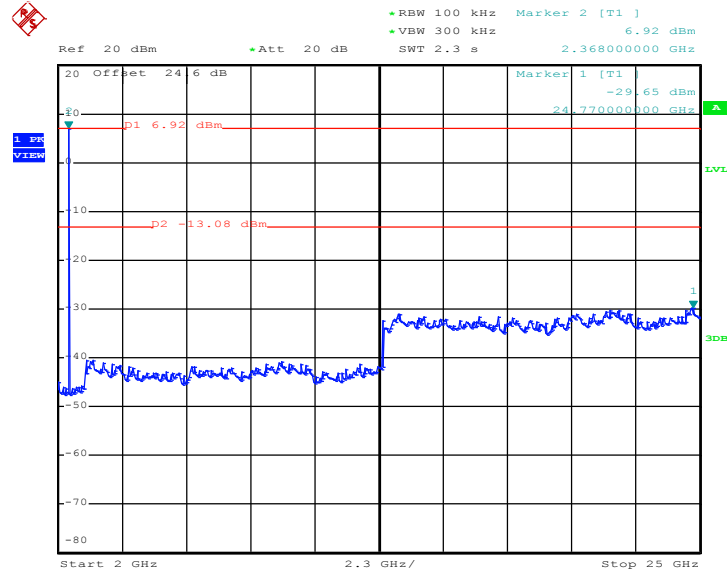

Date: 23.AUG.2017 05:59:39



3Mbps CSE Plot on Ch 39 between 30MHz ~ 3 GHz

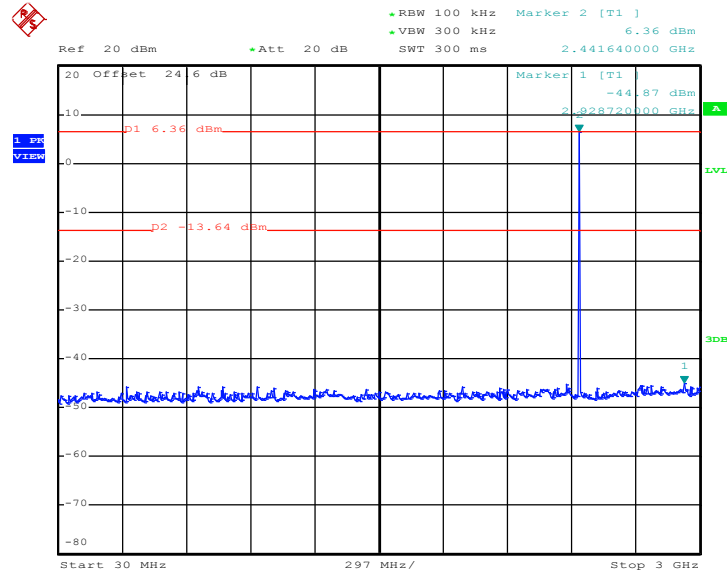

Date: 24.AUG.2017 21:46:56

3Mbps CSE Plot on Ch 39 between 2 GHz ~ 25 GHz

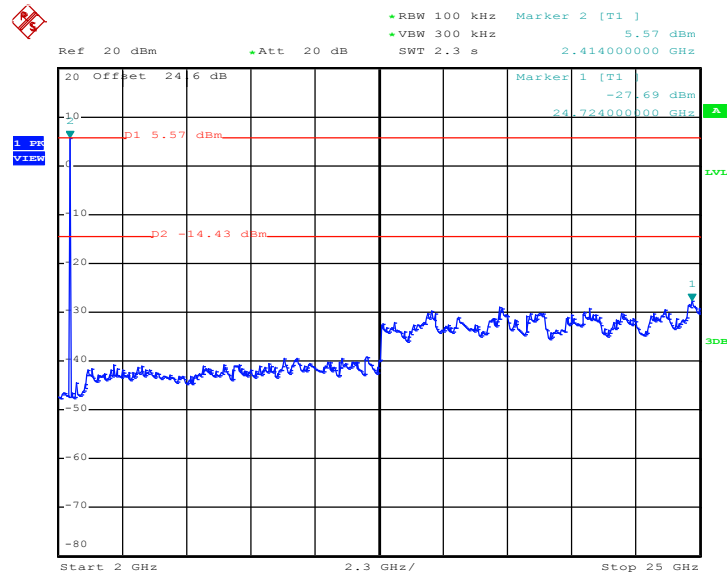

Date: 24.AUG.2017 21:47:17



3Mbps CSE Plot on Ch 78 between 30MHz ~ 3 GHz

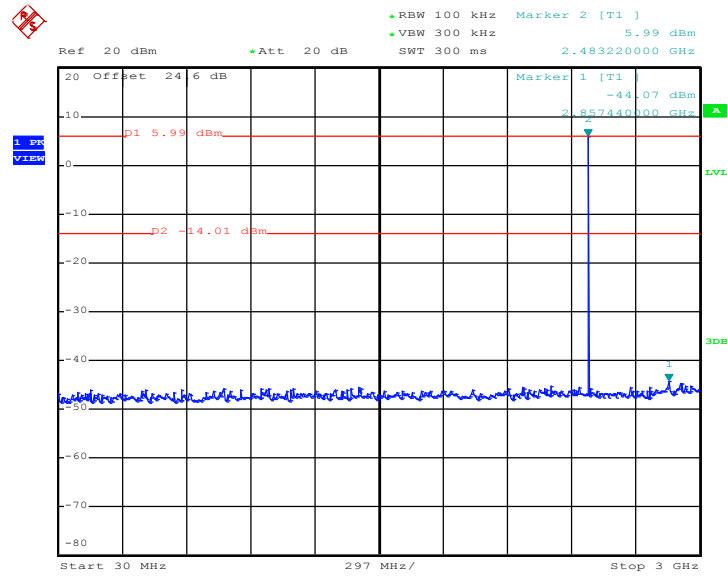

Date: 23.AUG.2017 06:28:06

3Mbps CSE Plot on Ch 78 between 2 GHz ~ 25 GHz

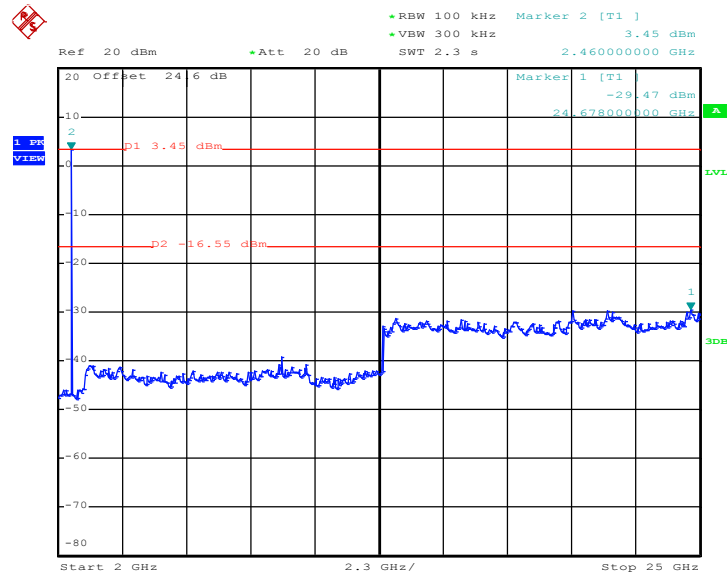

Date: 23.AUG.2017 06:28:27



3.8 Radiated Band Edges and Spurious Emission Measurement

3.8.1 Limit of Radiated Band Edges and Spurious Emission

In any 100 kHz bandwidth outside the intentional radiator frequency band, all harmonics/spurious must be at least 20 dB below the highest emission level within the authorized band. In addition, radiated emissions which fall in the restricted bands must also comply with the limits as below.

| Frequency (MHz) | Field Strength (microvolts/meter) | Measurement Distance (meters) |
|-----------------|-----------------------------------|-------------------------------|
| 0.009 – 0.490 | 2400/F(kHz) | 300 |
| 0.490 – 1.705 | 24000/F(kHz) | 30 |
| 1.705 – 30.0 | 30 | 30 |
| 30 – 88 | 100 | 3 |
| 88 – 216 | 150 | 3 |
| 216 - 960 | 200 | 3 |
| Above 960 | 500 | 3 |

3.8.2 Measuring Instruments

The measuring equipment is listed in the section 4 of this test report.



3.8.3 Test Procedures

1. The EUT was placed on a turntable with 0.8 meter for frequency below 1GHz and 1.5 meter for frequency above 1GHz respectively above ground.
2. The EUT was set 3 meters from the interference receiving antenna, which was mounted on the top of a variable height antenna tower.
3. For each suspected emission, the EUT was arranged to its worst case and then tune the Antenna tower (from 1 m to 4 m) and turntable (from 0 degree to 360 degrees) to find the maximum reading. A pre-amp and a high pass filter are used for the test in order to get better signal level to comply with the guidelines.
4. Set to the maximum power setting and enable the EUT transmit continuously.
5. Use the following spectrum analyzer settings:
 - (1) Span shall wide enough to fully capture the emission being measured;
 - (2) Set RBW=100 kHz for $f < 1 \text{ GHz}$, RBW=1MHz for $f > 1\text{GHz}$; VBW \geq RBW; Sweep = auto; Detector function = peak; Trace = max hold for peak
 - (3) For average measurement: use duty cycle correction factor method per 15.35(c).
Duty cycle = On time/100 milliseconds
On time = $N_1 * L_1 + N_2 * L_2 + \dots + N_{n-1} * L_{n-1} + N_n * L_n$
Where N_1 is number of type 1 pulses, L_1 is length of type 1 pulses, etc.
Average Emission Level = Peak Emission Level + $20 * \log(\text{Duty cycle})$
6. Corrected Reading: Antenna Factor + Cable Loss + Read Level - Preamp Factor = Level
7. For testing below 1GHz, if the emission level of the EUT in peak mode was 3 dB lower than the limit specified, then peak values of EUT will be reported, otherwise, the emissions will be repeated one by one using the CISPR quasi-peak method and reported.
8. For testing above 1GHz, the emission level of the EUT in peak mode was 20dB lower than average limit (that means the emission level in average mode also complies with the limit in average mode), then peak values of EUT will be reported, otherwise, the emissions will be measured in average mode again and reported.

Note: The average levels were calculated from the peak level corrected with duty cycle correction factor (-24.79dB) derived from $20 \log(\text{dwell time}/100\text{ms})$. This correction is only for signals that hop with the fundamental signal, such as band-edge and harmonic. Other spurious signals that are independent of the hopping signal would not use this correction.

3.8.4 Test Setup

For radiated emissions below 30MHz

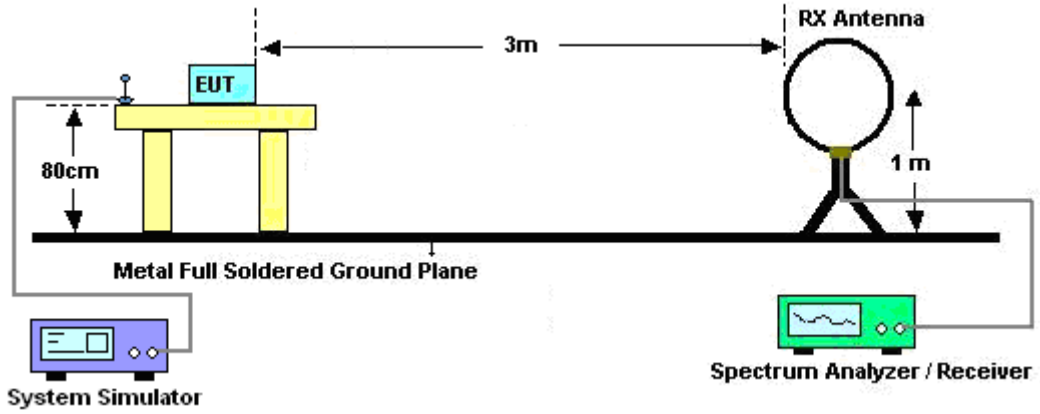

For radiated emissions from 30MHz to 1GHz

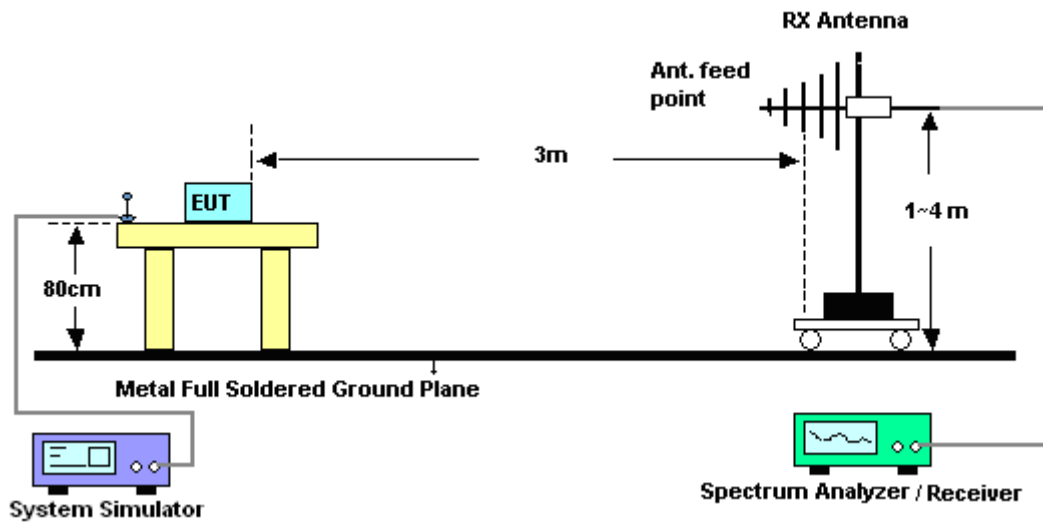

For radiated emissions above 1GHz

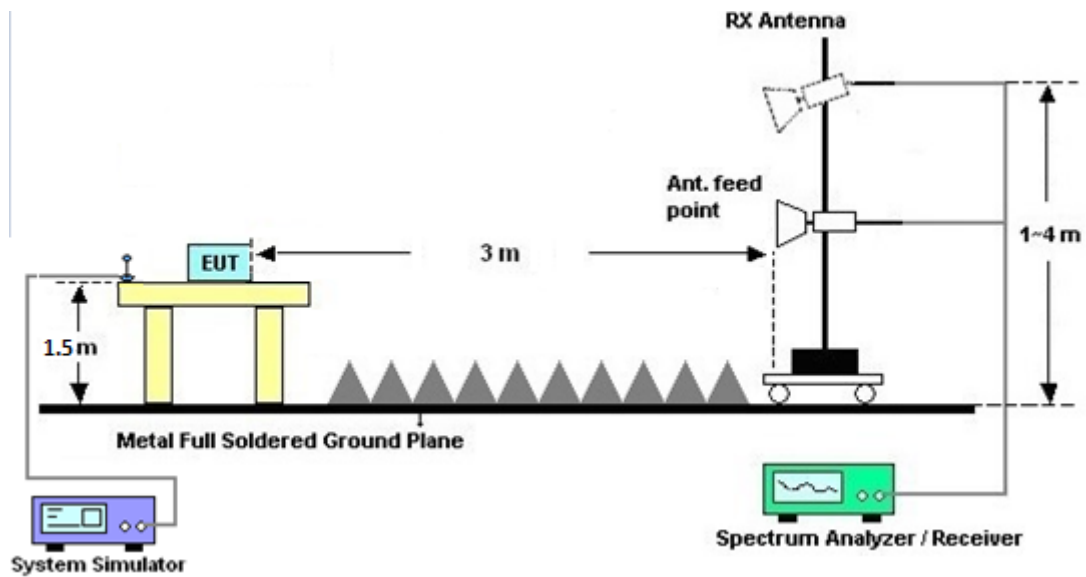

3.8.5 Test Results of Radiated Spurious Emissions (9 kHz ~ 30 MHz)

The low frequency, which started from 9 kHz to 30MHz, was pre-scanned and the result which was 20dB lower than the limit line was not reported.

There is a comparison data of both open-field test site and semi-Anechoic chamber, and the result came out very similar.

3.8.6 Test Result of Radiated Spurious at Band Edges

Please refer to Appendix C and D.

3.8.7 Duty Cycle

Please refer to Appendix E.

3.8.8 Test Result of Radiated Spurious Emission (30MHz ~ 10th Harmonic)

Please refer to Appendix C and D.



3.9 AC Conducted Emission Measurement

3.9.1 Limit of AC Conducted Emission

For equipment that is designed to be connected to the public utility (AC) power line, the radio frequency voltage that is conducted back onto the AC power line on any frequency or frequencies within the band 150 kHz to 30 MHz shall not exceed the limits in the following table.

| Frequency of emission (MHz) | Conducted limit (dBµV) | |
|-----------------------------|------------------------|-----------|
| | Quasi-peak | Average |
| 0.15-0.5 | 66 to 56* | 56 to 46* |
| 0.5-5 | 56 | 46 |
| 5-30 | 60 | 50 |

*Decreases with the logarithm of the frequency.

3.9.2 Measuring Instruments

The measuring equipment is listed in the section 4 of this test report.

3.9.3 Test Procedures

1. The EUT was placed 0.4 meter from the conducting wall of the shielding room was kept at least 80 centimeters from any other grounded conducting surface.
2. Connect EUT to the power mains through a line impedance stabilization network (LISN).
3. All the support units are connecting to the other LISN.
4. The LISN provides 50 ohm coupling impedance for the measuring instrument.
5. The FCC states that a 50 ohm, 50 microhenry LISN should be used.
6. Both sides of AC line were checked for maximum conducted interference.
7. The frequency range from 150 kHz to 30 MHz was searched.
8. Set the test-receiver system to Peak Detect Function and specified bandwidth (IF Bandwidth = 9kHz) with Maximum Hold Mode. Then measurement is also conducted by Average Detector and Quasi-Peak Detector Function respectively.

3.9.4 Test Setup

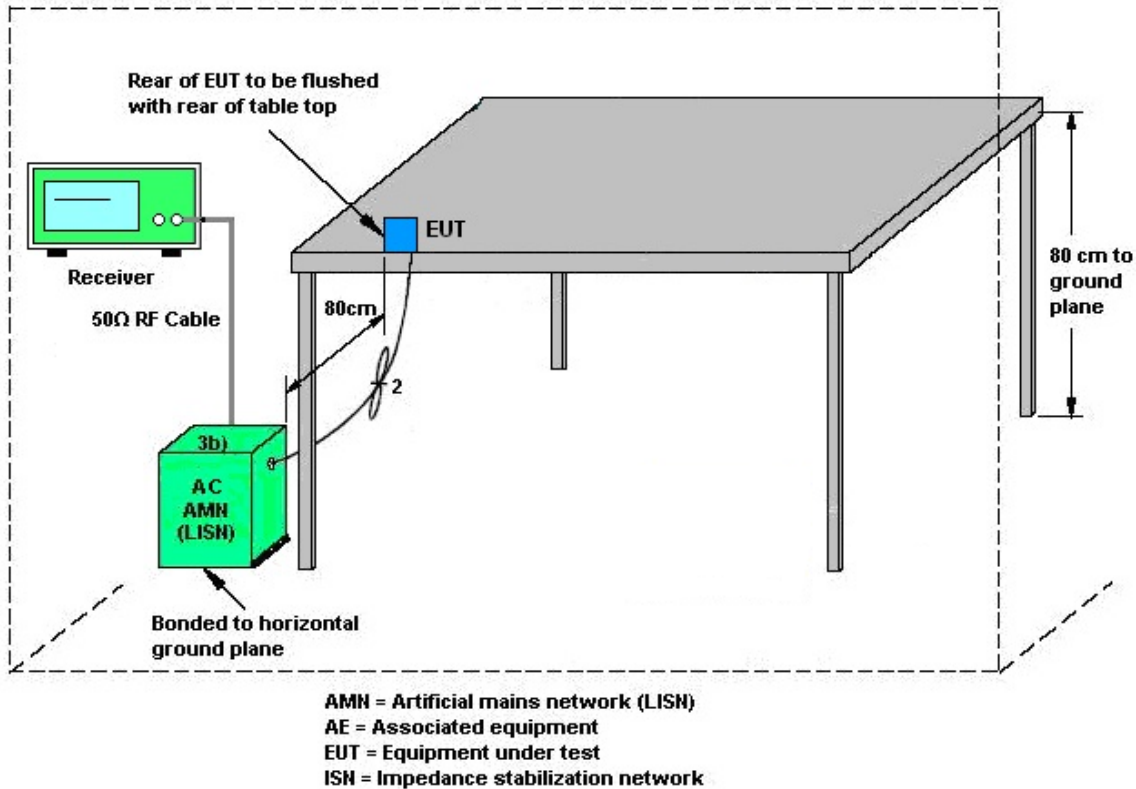

3.9.5 Test Result of AC Conducted Emission

Please refer to Appendix B.



3.10 Antenna Requirements

3.10.1 Standard Applicable

If directional gain of transmitting antennas is greater than 6dBi, the power shall be reduced by the same level in dB comparing to gain minus 6dBi. The use of a permanently attached antenna or of an antenna that uses a unique coupling to the intentional radiator shall be considered sufficient to comply with the rule.

3.10.2 Antenna Anti-Replacement Construction

An embedded-in antenna design is used.

3.10.3 Antenna Gain

The antenna peak gain of EUT is less than 6 dBi. Therefore, it is not necessary to reduce maximum peak output power limit.



4 List of Measuring Equipment

| Instrument | Manufacturer | Model No. | Serial No. | Characteristics | Calibration Date | Test Date | Due Date | Remark |
|----------------------|-------------------|---------------------------------|-------------|-----------------|------------------|---------------------------------|---------------|--------------------------|
| Power Meter | Anritsu | ML2495A | 0932001 | N/A | Sep. 29, 2016 | Aug. 10, 2017~ Aug. 24, 2017 | Sep. 28, 2017 | Conducted (TH05-HY) |
| Power Sensor | Anritsu | MA2411B | 0846202 | 300MHz~40GHz | Sep. 29, 2016 | Aug. 10, 2017~ Aug. 24, 2017 | Sep. 28, 2017 | Conducted (TH05-HY) |
| Spectrum Analyzer | Rohde & Schwarz | FSP40 | 100057 | 9kHz-40GHz | Nov. 25, 2016 | Aug. 10, 2017~ Aug. 24, 2017 | Nov. 24, 2017 | Conducted (TH05-HY) |
| Hygrometer | TECPEL | DTM-303B | TP157151 | N/A | Mar. 20, 2017 | Aug. 10, 2017~ Aug. 24, 2017 | Mar. 19, 2018 | Conducted (TH05-HY) |
| RF Cable | HUBER + SUHNER | SUCOFLEX 104 | MY84209521 | 1GHz~26GHz | Dec. 02, 2016 | Aug. 10, 2017~ Aug. 24, 2017 | Dec. 01, 2017 | Conducted (TH05-HY) |
| AC Power Source | ChainTek | APC-1000W | N/A | N/A | N/A | Oct. 02, 2017~ Oct. 03, 2017 | N/A | Conduction (CO05-HY) |
| EMI Test Receiver | Rohde & Schwarz | ESCI 7 | 100724 | 9kHz~7GHz | Sep. 20, 2017 | Oct. 02, 2017~ Oct. 03, 2017 | Sep. 19, 2018 | Conduction (CO05-HY) |
| Hygrometer | Testo | 608-H1 | 34913912 | N/A | May 02, 2017 | Oct. 02, 2017~ Oct. 03, 2017 | May 01, 2018 | Conduction (CO05-HY) |
| LISN | Rohde & Schwarz | ENV216 | 100080 | 9kHz~30MHz | Nov. 29, 2016 | Oct. 02, 2017~ Oct. 03, 2017 | Nov. 28, 2017 | Conduction (CO05-HY) |
| LF Cable | HUBER + SUHNER | RG-214/U | LF01 | N/A | Jan. 05, 2017 | Oct. 02, 2017~ Oct. 03, 2017 | Jan. 04, 2018 | Conduction (CO05-HY) |
| Test Software | N/A | EMC32 | 8.40.0 | N/A | N/A | Oct. 02, 2017~ Oct. 03, 2017 | N/A | Conduction (CO05-HY) |
| Loop Antenna | Rohde & Schwarz | HFH2-Z2 | 100315 | 9 kHz~30 MHz | May 15, 2017 | Sep. 11, 2017~ Sep. 16, 2017 | May 14, 2019 | Radiation (03CH13-HY) |
| Bilog Antenna | TESEQ | CBL 6111D&00800 N1D01N-06 | 40103&04 | 30MHz to 1GHz | Jan. 07, 2017 | Sep. 11, 2017~ Sep. 16, 2017 | Jan. 06, 2018 | Radiation (03CH13-HY) |
| Horn Antenna | SCHWARZBECK | BBHA 9120 D | 9120D-1241 | 1GHz ~ 18GHz | May 02, 2017 | Sep. 11, 2017~ Sep. 16, 2017 | May 01, 2018 | Radiation (03CH13-HY) |
| SHF-EHF Horn Antenna | SCHWARZBECK | BBHA 9170 | BBHA9170584 | 18GHz- 40GHz | Nov. 08, 2016 | Sep. 11, 2017~ Sep. 16, 2017 | Nov. 07, 2017 | Radiation (03CH13-HY) |
| Spectrum Analyzer | Keysight | N9010A | MY55370526 | N/A | Mar. 15, 2017 | Sep. 11, 2017~ Sep. 16, 2017 | Mar. 14, 2018 | Radiation (03CH13-HY) |
| EMI Test Receiver | Agilent | N9038A(MXE) | MY53290053 | 20Hz to 26.5GHz | Jan. 12, 2017 | Sep. 11, 2017~ Sep. 16, 2017 | Jan. 11, 2018 | Radiation (03CH13-HY) |
| Amplifier | Sonoma-Instrument | 310 N | 187282 | 9KHz~1GHz | Dec. 21, 2016 | Sep. 11, 2017~ Sep. 16, 2017 | Dec. 20, 2017 | Radiation (03CH13-HY) |
| Preamplifier | MITEQ | AMF-7D-0010 1800-30-10P | 1590074 | 1GHz~18GHz | May 22, 2017 | Sep. 11, 2017~ Sep. 16, 2017 | May 21, 2018 | Radiation (03CH13-HY) |
| Preamplifier | Keysight | 83017A | MY53270147 | 1GHz~26.5GHz | Jan. 09, 2017 | Sep. 11, 2017~ Sep. 16, 2017 | Jan. 08, 2018 | Radiation (03CH13-HY) |
| Preamplifier | MITEQ | TTA 1840-35-HG | 1887435 | 18GHz ~ 40GHz | Oct. 13, 2016 | Sep. 11, 2017~ Sep. 16, 2017 | Oct. 12, 2017 | Radiation (03CH13-HY) |



| Instrument | Manufacturer | Model No. | Serial No. | Characteristics | Calibration Date | Test Date | Due Date | Remark |
|---------------|-------------------|-------------------------------------|------------------------------------|----------------------------------|------------------|---------------------------------|---------------|--------------------------|
| Hygrometer | TECEP | DTM-303B | TP140320 | N/A | Nov. 14, 2016 | Sep. 11, 2017~ Sep. 16, 2017 | Nov. 13, 2017 | Radiation (03CH13-HY) |
| RF Cable | HUBER + SUHNER | SUCOFLEX 104 | MY335041/4M Y9840/4 MY9838/4 | 26GHz~40GHz | Mar. 27, 2017 | Sep. 11, 2017~ Sep. 16, 2017 | Mar. 26, 2018 | Radiation (03CH13-HY) |
| RF Cable | HUBER + SUHNER | SUCOFLEX 104 | MY335041/4M Y9840/4 MY9838/4 | 30MHz~1GHz | Jan. 27, 2017 | Sep. 11, 2017~ Sep. 16, 2017 | Jan. 26, 2018 | Radiation (03CH13-HY) |
| RF Cable | HUBER + SUHNER | SUCOFLEX 104 | MY335041/4M Y9840/4 MY9838/4 | 1GHz~26GHz | Jan. 27, 2017 | Sep. 11, 2017~ Sep. 16, 2017 | Jan. 26, 2018 | Radiation (03CH13-HY) |
| Controller | EMEC | EM1000 | N/A | Control Turn table & Ant Mast | N/A | Sep. 11, 2017~ Sep. 16, 2017 | N/A | Radiation (03CH13-HY) |
| Antenna Mast | EMEC | AM-BS-4500-B | N/A | 1m~4m | N/A | Sep. 11, 2017~ Sep. 16, 2017 | N/A | Radiation (03CH13-HY) |
| Turn Table | EMEC | TT2000 | N/A | 0~360 Degree | N/A | Sep. 11, 2017~ Sep. 16, 2017 | N/A | Radiation (03CH13-HY) |
| Test Software | Audix | E3 | 6.2009-8-24 | N/A | N/A | Sep. 11, 2017~ Sep. 16, 2017 | N/A | Radiation (03CH13-HY) |
| Filter | Wainwright | WLKS1200-12 SS | SN2 | 1.2G Low Pass | Sep. 19, 2016 | Sep. 11, 2017~ Sep. 16, 2017 | Sep. 18, 2017 | Radiation (03CH13-HY) |
| Filter | Wainwright | WHKX12-2700 -3000-18000-6 0SS | SN2 | 3G High Pass | Sep. 20, 2016 | Sep. 11, 2017~ Sep. 16, 2017 | Sep. 19, 2017 | Radiation (03CH13-HY) |



5 Uncertainty of Evaluation

Uncertainty of Conducted Emission Measurement (150 kHz ~ 30 MHz)

| | |
|---|------|
| Measuring Uncertainty for a Level of Confidence of 95% ($U = 2Uc(y)$) | 2.70 |
|---|------|

Uncertainty of Radiated Emission Measurement (30 MHz ~ 1000 MHz)

| | |
|---|------|
| Measuring Uncertainty for a Level of Confidence of 95% ($U = 2Uc(y)$) | 4.90 |
|---|------|

Uncertainty of Radiated Emission Measurement (1000 MHz ~ 18000 MHz)

| | |
|---|------|
| Measuring Uncertainty for a Level of Confidence of 95% ($U = 2Uc(y)$) | 5.40 |
|---|------|

Uncertainty of Radiated Emission Measurement (18000 MHz ~ 40000 MHz)

| | |
|---|------|
| Measuring Uncertainty for a Level of Confidence of 95% ($U = 2Uc(y)$) | 4.30 |
|---|------|

Appendix A. Test Result of Conducted Test Items

| | | | | |
|----------------|---------------------|--------------------|-------|----|
| Test Engineer: | Reece Lin | Temperature: | 21~25 | °C |
| Test Date: | 2017/8/10~2017/8/24 | Relative Humidity: | 51~54 | % |

TEST RESULTS DATA

20dB and 99% Occupied Bandwidth and Hopping Channel Separation

| Mod. | Data Rate | NTX | CH. | Freq. (MHz) | 20db BW (MHz) | 99% Bandwidth (MHz) | Hopping Channel Separation Measurement (MHz) | Hopping Channel Separation Measurement Limit (MHz) | Pass/Fail |
|------|-----------|-----|-----|-------------|---------------|---------------------|--|--|-----------|
| DH | 1Mbps | 1 | 0 | 2402 | 0.876 | 0.844 | 1.008 | 0.5840 | Pass |
| DH | 1Mbps | 1 | 39 | 2441 | 0.896 | 0.840 | 1.008 | 0.5973 | Pass |
| DH | 1Mbps | 1 | 78 | 2480 | 0.872 | 0.840 | 1.008 | 0.5813 | Pass |
| 2DH | 2Mbps | 1 | 0 | 2402 | 1.272 | 1.168 | 1.002 | 0.8480 | Pass |
| 2DH | 2Mbps | 1 | 39 | 2441 | 1.266 | 1.172 | 1.002 | 0.8440 | Pass |
| 2DH | 2Mbps | 1 | 78 | 2480 | 1.290 | 1.172 | 1.002 | 0.8600 | Pass |
| 3DH | 3Mbps | 1 | 0 | 2402 | 1.242 | 1.148 | 1.020 | 0.8280 | Pass |
| 3DH | 3Mbps | 1 | 39 | 2441 | 1.236 | 1.148 | 1.320 | 0.8240 | Pass |
| 3DH | 3Mbps | 1 | 78 | 2480 | 1.236 | 1.148 | 1.320 | 0.8240 | Pass |

TEST RESULTS DATA

Dwell Time

| Mod. | Hopping Channel Number Rate | Hops Over Occupancy Time(hops) | Package Transfer Time (msec) | Dwell Time (sec) | Limits (sec) | Pass/Fail |
|-------|-----------------------------|--------------------------------|------------------------------|------------------|--------------|-----------|
| Nomal | 79 | 106.67 | 2.90 | 0.31 | 0.4 | Pass |
| AFH | 20 | 53.33 | 2.90 | 0.15 | 0.4 | Pass |

TEST RESULTS DATA

Peak Power Table

| DH | CH. | NTX | Peak Power (dBm) | Power Limit (dBm) | Test Result |
|-----|-----|-----|------------------|-------------------|-------------|
| DH1 | 0 | 1 | 9.93 | 20.97 | Pass |
| | 39 | 1 | 9.22 | 20.97 | Pass |
| | 78 | 1 | 9.39 | 20.97 | Pass |

| 2DH | CH. | NTX | Peak Power (dBm) | Power Limit (dBm) | Test Result |
|------|-----|-----|------------------|-------------------|-------------|
| 2DH1 | 0 | 1 | 8.88 | 20.97 | Pass |
| | 39 | 1 | 8.21 | 20.97 | Pass |
| | 78 | 1 | 8.09 | 20.97 | Pass |

| 3DH | CH. | NTX | Peak Power (dBm) | Power Limit (dBm) | Test Result |
|------|-----|-----|------------------|-------------------|-------------|
| 3DH1 | 0 | 1 | 9.29 | 20.97 | Pass |
| | 39 | 1 | 8.65 | 20.97 | Pass |
| | 78 | 1 | 8.78 | 20.97 | Pass |

TEST RESULTS DATA

Number of Hopping Frequency

| Number of Hopping (Channel) | Adaptive Frequency Hopping (Channel) | Limits (Channel) | Pass/Fail |
|-----------------------------|--------------------------------------|------------------|-----------|
| 79 | 20 | > 15 | Pass |



Appendix B. AC Conducted Emission Test Results

| | | | |
|-----------------|----------|---------------------|---------|
| Test Engineer : | Blue Lan | Temperature : | 26~27°C |
| | | Relative Humidity : | 51~52% |

EUT Information

Report NO : 760710-01
 Test Mode : Mode 1
 Test Voltage : 120Vac/60Hz
 Phase : Line

ENV216 Auto Test FCC Power Bar - L

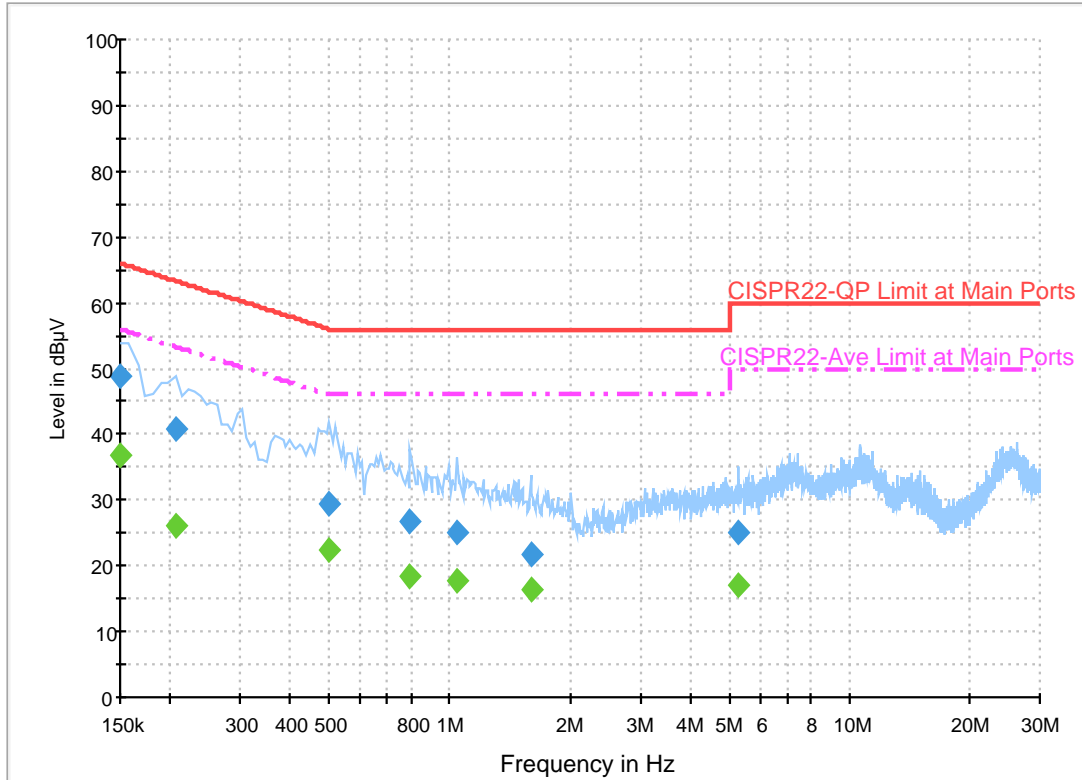

Final Result 1

| Frequency (MHz) | QuasiPeak (dBµV) | Filter | Line | Corr. (dB) | Margin (dB) | Limit (dBµV) |
|-----------------|------------------|--------|------|------------|-------------|--------------|
| 0.150000 | 48.8 | Off | L1 | 19.6 | 17.2 | 66.0 |
| 0.206000 | 40.7 | Off | L1 | 19.6 | 22.7 | 63.4 |
| 0.502000 | 29.3 | Off | L1 | 19.6 | 26.7 | 56.0 |
| 0.798000 | 26.6 | Off | L1 | 19.6 | 29.4 | 56.0 |
| 1.046000 | 25.1 | Off | L1 | 19.6 | 30.9 | 56.0 |
| 1.598000 | 21.7 | Off | L1 | 19.6 | 34.3 | 56.0 |
| 5.270000 | 25.2 | Off | L1 | 19.8 | 34.8 | 60.0 |

Final Result 2

| Frequency (MHz) | Average (dBµV) | Filter | Line | Corr. (dB) | Margin (dB) | Limit (dBµV) |
|-----------------|----------------|--------|------|------------|-------------|--------------|
| 0.150000 | 36.8 | Off | L1 | 19.6 | 19.2 | 56.0 |
| 0.206000 | 26.1 | Off | L1 | 19.6 | 27.3 | 53.4 |
| 0.502000 | 22.3 | Off | L1 | 19.6 | 23.7 | 46.0 |
| 0.798000 | 18.3 | Off | L1 | 19.6 | 27.7 | 46.0 |
| 1.046000 | 17.7 | Off | L1 | 19.6 | 28.3 | 46.0 |
| 1.598000 | 16.3 | Off | L1 | 19.6 | 29.7 | 46.0 |
| 5.270000 | 17.0 | Off | L1 | 19.8 | 33.0 | 50.0 |

EUT Information

Report NO : 760710-01
 Test Mode : Mode 1
 Test Voltage : 120Vac/60Hz
 Phase : Neutral

ENV216 Auto Test FCC Power Bar - N

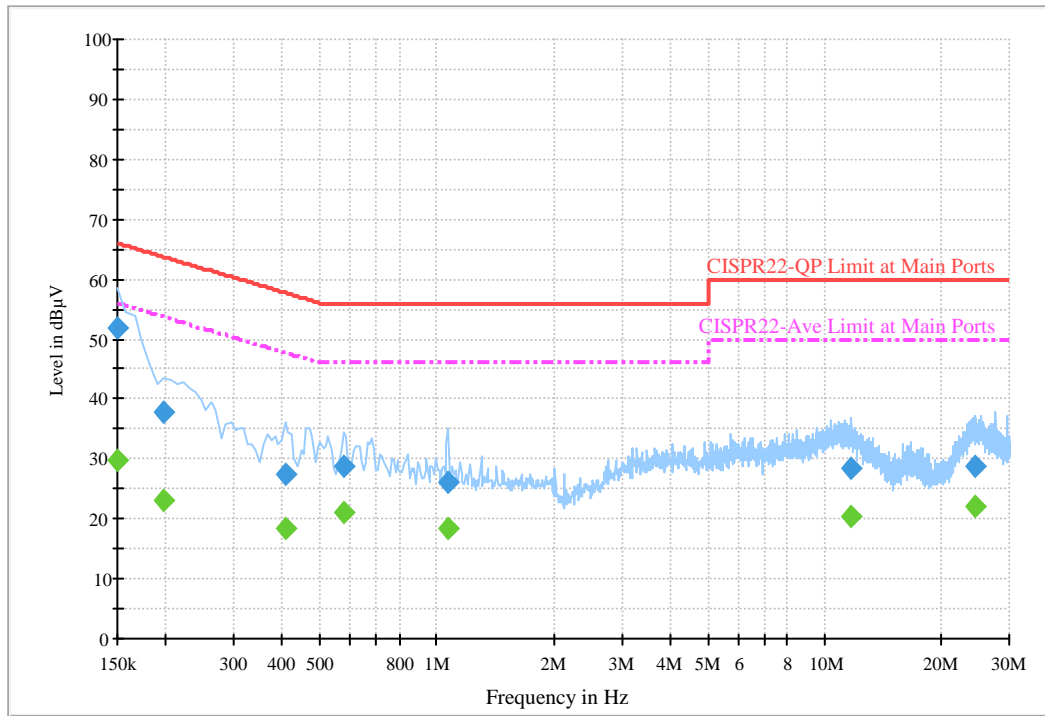

Final Result 1

| Frequency (MHz) | QuasiPeak (dBµV) | Filter | Line | Corr. (dB) | Margin (dB) | Limit (dBµV) |
|-----------------|------------------|--------|------|------------|-------------|--------------|
| 0.150000 | 52.0 | Off | N | 19.5 | 14.0 | 66.0 |
| 0.198000 | 37.8 | Off | N | 19.5 | 25.9 | 63.7 |
| 0.406000 | 27.4 | Off | N | 19.5 | 30.3 | 57.7 |
| 0.574000 | 28.8 | Off | N | 19.5 | 27.2 | 56.0 |
| 1.070000 | 26.0 | Off | N | 19.6 | 30.0 | 56.0 |
| 11.774000 | 28.4 | Off | N | 20.2 | 31.6 | 60.0 |
| 24.510000 | 28.9 | Off | N | 20.9 | 31.1 | 60.0 |

Final Result 2

| Frequency (MHz) | Average (dBµV) | Filter | Line | Corr. (dB) | Margin (dB) | Limit (dBµV) |
|-----------------|----------------|--------|------|------------|-------------|--------------|
| 0.150000 | 29.6 | Off | N | 19.5 | 26.4 | 56.0 |
| 0.198000 | 23.2 | Off | N | 19.5 | 30.5 | 53.7 |
| 0.406000 | 18.5 | Off | N | 19.5 | 29.2 | 47.7 |
| 0.574000 | 21.2 | Off | N | 19.5 | 24.8 | 46.0 |
| 1.070000 | 18.3 | Off | N | 19.6 | 27.7 | 46.0 |
| 11.774000 | 20.4 | Off | N | 20.2 | 29.6 | 50.0 |
| 24.510000 | 22.0 | Off | N | 20.9 | 28.0 | 50.0 |



Appendix C. Radiated Spurious Emission

| | | | |
|-----------------|-------------------------------------|---------------------|-------------|
| Test Engineer : | Alex Jheng / Bill Chang / Wilson Wu | Temperature : | 24.5~25.3°C |
| | | Relative Humidity : | 49~54% |

2.4GHz 2400~2483.5MHz

BT (1M) (Band Edge @ 3m)

| BT | Note | Frequency | Level | Over | Limit | Read | Antenna | Cable | Preamp | Ant | Table | Peak | Pol. | |
|------------------------|------|-----------|------------|--------|------------|----------|----------|--------|--------|--------|---------|---------|---------|---|
| | | (MHz) | (dBμV/m) | (dB) | Limit | Line | Level | Factor | Loss | Factor | Pos | Pos | Avg. | |
| | | | | | (dBμV/m) | (dBμV) | (dB/m) | (dB) | (dB) | (cm) | (deg) | (P/A) | (H/V) | |
| BT CH00 2402MHz | | 2359.98 | 41.53 | -32.47 | 74 | 40.94 | 26.79 | 4.8 | 31 | 215 | 214 | P | H | |
| | | 2359.98 | 16.74 | -37.26 | 54 | - | - | - | - | - | - | A | H | |
| | * | 2402 | 95.75 | - | - | 95 | 26.89 | 4.85 | 30.99 | 215 | 214 | P | H | |
| | * | 2402 | 70.96 | - | - | - | - | - | - | - | - | A | H | |
| | | | | | | | | | | | | | H | |
| | | | | | | | | | | | | | | H |
| | | | 2386.02 | 42.14 | -31.86 | 74 | 41.41 | 26.89 | 4.83 | 30.99 | 286 | 270 | P | V |
| | | | 2386.02 | 17.35 | -36.65 | 54 | - | - | - | - | - | - | A | V |
| | * | | 2402 | 97.47 | - | - | 96.72 | 26.89 | 4.85 | 30.99 | 286 | 270 | P | V |
| | * | | 2402 | 72.68 | - | - | - | - | - | - | - | - | A | V |
| | | | | | | | | | | | | | | V |
| | | | | | | | | | | | | | | V |
| BT CH 39 2441MHz | | 2375.24 | 41.86 | -32.14 | 74 | 41.18 | 26.84 | 4.83 | 30.99 | 212 | 217 | P | H | |
| | | 2375.24 | 17.07 | -36.93 | 54 | - | - | - | - | - | - | A | H | |
| | * | 2441 | 95.7 | - | - | 94.75 | 27.04 | 4.88 | 30.97 | 212 | 217 | P | H | |
| | * | 2441 | 70.91 | - | - | - | - | - | - | - | - | A | H | |
| | | | 2494.26 | 41.47 | -32.53 | 74 | 40.3 | 27.2 | 4.93 | 30.96 | 212 | 217 | P | H |
| | | | 2494.26 | 16.68 | -37.32 | 54 | - | - | - | - | - | - | A | H |
| | | | 2389.52 | 41.57 | -32.43 | 74 | 40.84 | 26.89 | 4.83 | 30.99 | 246 | 268 | P | V |
| | | | 2389.52 | 16.78 | -37.22 | 54 | - | - | - | - | - | - | A | V |
| | * | | 2441 | 96.59 | - | - | 95.64 | 27.04 | 4.88 | 30.97 | 246 | 268 | P | V |
| | * | | 2441 | 71.8 | - | - | - | - | - | - | - | - | A | V |
| | | | 2491.53 | 41.88 | -32.12 | 74 | 40.71 | 27.2 | 4.93 | 30.96 | 246 | 268 | P | V |
| | | | 2491.53 | 17.09 | -36.91 | 54 | - | - | - | - | - | - | A | V |



| | | | | | | | | | | | | | |
|---------------------------------|---|--------|-------|--------|----|-------|-------|------|-------|-----|-----|---|---|
| BT CH 78 2480MHz | * | 2480 | 93.39 | - | - | 92.29 | 27.15 | 4.92 | 30.97 | 370 | 164 | P | H |
| | * | 2480 | 68.6 | - | - | - | - | - | - | - | - | A | H |
| | | 2483.8 | 43.63 | -30.37 | 74 | 42.52 | 27.15 | 4.93 | 30.97 | 370 | 164 | P | H |
| | | 2483.8 | 18.84 | -35.16 | 54 | - | - | - | - | - | - | A | H |
| | | | | | | | | | | | | | H |
| | | | | | | | | | | | | | H |
| | * | 2480 | 95.59 | - | - | 94.49 | 27.15 | 4.92 | 30.97 | 268 | 270 | P | V |
| | * | 2480 | 70.8 | - | - | - | - | - | - | - | - | A | V |
| | | 2483.6 | 44.28 | -29.72 | 74 | 43.17 | 27.15 | 4.93 | 30.97 | 268 | 270 | P | V |
| | | 2483.6 | 19.49 | -34.51 | 54 | - | - | - | - | - | - | A | V |
| | | | | | | | | | | | | | V |
| | | | | | | | | | | | | | V |
| Remark | 1. No other spurious found. 2. All results are PASS against Peak and Average limit line. | | | | | | | | | | | | |



2.4GHz 2400~2483.5MHz

BT (1M) (Harmonic @ 3m)

| BT | Note | Frequency (MHz) | Level (dBμV/m) | Over Limit (dB) | Limit Line (dBμV/m) | Read Level (dBμV) | Antenna Factor (dB/m) | Cable Loss (dB) | Preamp Factor (dB) | Ant Pos (cm) | Table Pos (deg) | Peak Avg. (P/A) | Pol. (H/V) | |
|------------------------|---|----------------------|---------------------|-------------------------|-----------------------------|---------------------------|-------------------------------|-------------------------|----------------------------|----------------------|-------------------------|-------------------------|-----------------|---|
| BT CH 00 2402MHz | | 4804 | 38.86 | -35.14 | 74 | 56.78 | 31.53 | 7.3 | 57.27 | 100 | 0 | P | H | |
| | | 4804 | 14.07 | -39.93 | 54 | - | - | - | - | - | - | A | H | |
| | | | | | | | | | | | | | H | |
| | | | | | | | | | | | | | H | |
| | | 4804 | 39.17 | -34.83 | 74 | 57.09 | 31.53 | 7.3 | 57.27 | 100 | 0 | P | V | |
| | | 4804 | 14.38 | -39.62 | 54 | - | - | - | - | - | - | - | A | V |
| | | | | | | | | | | | | | | V |
| | | | | | | | | | | | | | | V |
| BT CH 39 2441MHz | | 4882 | 38.5 | -35.5 | 74 | 56.1 | 31.63 | 7.44 | 57.17 | 100 | 0 | P | H | |
| | | 4882 | 13.71 | -40.29 | 54 | - | - | - | - | - | - | A | H | |
| | | 7323 | 43.14 | -30.86 | 74 | 54.64 | 36.19 | 9.14 | 57.29 | 100 | 0 | P | H | |
| | | 7323 | 18.35 | -35.65 | 54 | - | - | - | - | - | - | A | H | |
| | | 4882 | 38.17 | -35.83 | 74 | 55.77 | 31.63 | 7.44 | 57.17 | 100 | 0 | P | V | |
| | | 4882 | 13.38 | -40.62 | 54 | - | - | - | - | - | - | - | A | V |
| | | 7323 | 43.42 | -30.58 | 74 | 54.92 | 36.19 | 9.14 | 57.29 | 100 | 0 | P | V | |
| | | 7323 | 18.63 | -35.37 | 54 | - | - | - | - | - | - | - | A | V |
| BT CH 78 2480MHz | | 4960 | 39.76 | -34.24 | 74 | 56.98 | 31.75 | 7.59 | 57.05 | 100 | 0 | P | H | |
| | | 4960 | 14.97 | -39.03 | 54 | - | - | - | - | - | - | A | H | |
| | | 7440 | 44.06 | -29.94 | 74 | 55.42 | 36.41 | 9.21 | 57.44 | 100 | 0 | P | H | |
| | | 7440 | 19.27 | -34.73 | 54 | - | - | - | - | - | - | A | H | |
| | | 4960 | 40.17 | -33.83 | 74 | 57.39 | 31.75 | 7.59 | 57.05 | 100 | 0 | P | V | |
| | | 4960 | 15.38 | -38.62 | 54 | - | - | - | - | - | - | A | V | |
| | | 7440 | 42.8 | -31.2 | 74 | 54.16 | 36.41 | 9.21 | 57.44 | 100 | 0 | P | V | |
| | | 7440 | 18.01 | -35.99 | 54 | - | - | - | - | - | - | - | A | V |
| Remark | 1. No other spurious found. 2. All results are PASS against Peak and Average limit line. | | | | | | | | | | | | | |



2.4GHz 2400~2483.5MHz

BT (2M) (Band Edge @ 3m)

| BT | Note | Frequency | Level | Over | Limit | Read | Antenna | Cable | Preamp | Ant | Table | Peak | Pol. | |
|------------------------|------|-----------|------------|--------|------------|----------|----------|--------|--------|--------|---------|---------|---------|---|
| | | (MHz) | (dBµV/m) | (dB) | (dBµV/m) | (dBµV) | (dB/m) | (dB) | (dB) | (cm) | (deg) | (P/A) | (H/V) | |
| BT CH00 2402MHz | | 2337.825 | 41.03 | -32.97 | 74 | 40.54 | 26.73 | 4.76 | 31 | 226 | 217 | P | H | |
| | | 2337.825 | 16.27 | -37.73 | 54 | - | - | - | - | - | - | A | H | |
| | * | 2402 | 93.67 | - | - | 92.92 | 26.89 | 4.85 | 30.99 | 226 | 217 | P | H | |
| | * | 2402 | 68.91 | - | - | - | - | - | - | - | - | A | H | |
| | | | | | | | | | | | | | H | |
| | | | | | | | | | | | | | | H |
| | | | 2376.99 | 41.53 | -32.47 | 74 | 40.85 | 26.84 | 4.83 | 30.99 | 281 | 268 | P | V |
| | | | 2376.99 | 16.77 | -37.23 | 54 | - | - | - | - | - | - | A | V |
| | * | 2402 | 96.63 | - | - | 95.88 | 26.89 | 4.85 | 30.99 | 281 | 268 | P | V | |
| | * | 2402 | 71.87 | - | - | - | - | - | - | - | - | - | A | V |
| | | | | | | | | | | | | | | V |
| | | | | | | | | | | | | | | V |
| BT CH 39 2441MHz | | 2374.4 | 41.1 | -32.9 | 74 | 40.45 | 26.84 | 4.8 | 30.99 | 212 | 229 | P | H | |
| | | 2374.4 | 16.34 | -37.66 | 54 | - | - | - | - | - | - | A | H | |
| | * | 2441 | 91.88 | - | - | 90.93 | 27.04 | 4.88 | 30.97 | 212 | 229 | P | H | |
| | * | 2441 | 67.12 | - | - | - | - | - | - | - | - | A | H | |
| | | | 2486.56 | 41.65 | -32.35 | 74 | 40.54 | 27.15 | 4.93 | 30.97 | 212 | 229 | P | H |
| | | | 2486.56 | 16.89 | -37.11 | 54 | - | - | - | - | - | - | A | H |
| | | | 2374.12 | 41.13 | -32.87 | 74 | 40.48 | 26.84 | 4.8 | 30.99 | 272 | 269 | P | V |
| | | | 2374.12 | 16.37 | -37.63 | 54 | - | - | - | - | - | - | A | V |
| | * | 2441 | 95.71 | - | - | 94.76 | 27.04 | 4.88 | 30.97 | 272 | 269 | P | V | |
| | * | 2441 | 70.95 | - | - | - | - | - | - | - | - | - | A | V |
| | | | 2494.33 | 41.12 | -32.88 | 74 | 39.95 | 27.2 | 4.93 | 30.96 | 272 | 269 | P | V |
| | | | 2494.33 | 16.36 | -37.64 | 54 | - | - | - | - | - | - | A | V |



| | | | | | | | | | | | | | |
|---------------------------------|---|---------|-------|--------|----|-------|-------|------|-------|-----|-----|---|---|
| BT CH 78 2480MHz | * | 2480 | 91.25 | - | - | 90.15 | 27.15 | 4.92 | 30.97 | 212 | 232 | P | H |
| | * | 2480 | 66.49 | - | - | - | - | - | - | - | - | A | H |
| | | 2484.44 | 42.18 | -31.82 | 74 | 41.07 | 27.15 | 4.93 | 30.97 | 212 | 232 | P | H |
| | | 2484.44 | 17.42 | -36.58 | 54 | - | - | - | - | - | - | A | H |
| | | | | | | | | | | | | | H |
| | | | | | | | | | | | | | H |
| | * | 2480 | 95.22 | - | - | 94.12 | 27.15 | 4.92 | 30.97 | 268 | 269 | P | V |
| | * | 2480 | 70.46 | - | - | - | - | - | - | - | - | A | V |
| | | 2483.68 | 45.04 | -28.96 | 74 | 43.93 | 27.15 | 4.93 | 30.97 | 268 | 269 | P | V |
| | | 2483.68 | 20.28 | -33.72 | 54 | - | - | - | - | - | - | A | V |
| | | | | | | | | | | | | | V |
| | | | | | | | | | | | | | V |
| Remark | 1. No other spurious found. 2. All results are PASS against Peak and Average limit line. | | | | | | | | | | | | |



2.4GHz 2400~2483.5MHz

BT (2M) (Harmonic @ 3m)

| BT | Note | Frequency (MHz) | Level (dBμV/m) | Over Limit (dB) | Limit Line (dBμV/m) | Read Level (dBμV) | Antenna Factor (dB/m) | Cable Loss (dB) | Preamp Factor (dB) | Ant Pos (cm) | Table Pos (deg) | Peak Avg. (P/A) | Pol. (H/V) | |
|------------------------|---|----------------------|---------------------|-------------------------|-----------------------------|---------------------------|-------------------------------|-------------------------|----------------------------|----------------------|-------------------------|-------------------------|-----------------|---|
| BT CH 00 2402MHz | | 4804 | 38.44 | -35.56 | 74 | 56.36 | 31.53 | 7.3 | 57.27 | 100 | 0 | P | H | |
| | | 4804 | 13.68 | -40.32 | 54 | - | - | - | - | - | - | A | H | |
| | | | | | | | | | | | | | H | |
| | | | | | | | | | | | | | H | |
| | | 4804 | 39.05 | -34.95 | 74 | 56.97 | 31.53 | 7.3 | 57.27 | 100 | 0 | P | V | |
| | | 4804 | 14.29 | -39.71 | 54 | - | - | - | - | - | - | - | A | V |
| | | | | | | | | | | | | | | V |
| | | | | | | | | | | | | | | V |
| BT CH 39 2441MHz | | 4882 | 38.29 | -35.71 | 74 | 55.89 | 31.63 | 7.44 | 57.17 | 100 | 0 | P | H | |
| | | 4882 | 13.53 | -40.47 | 54 | - | - | - | - | - | - | A | H | |
| | | 7323 | 43.67 | -30.33 | 74 | 55.17 | 36.19 | 9.14 | 57.29 | 100 | 0 | P | H | |
| | | 7323 | 18.91 | -35.09 | 54 | - | - | - | - | - | - | A | H | |
| | | 4882 | 38.88 | -35.12 | 74 | 56.48 | 31.63 | 7.44 | 57.17 | 100 | 0 | P | V | |
| | | 4882 | 14.12 | -39.88 | 54 | - | - | - | - | - | - | A | V | |
| | | 7323 | 43.52 | -30.48 | 74 | 55.02 | 36.19 | 9.14 | 57.29 | 100 | 0 | P | V | |
| | | 7323 | 18.76 | -35.24 | 54 | - | - | - | - | - | - | A | V | |
| BT CH 78 2480MHz | | 4960 | 38.88 | -35.12 | 74 | 56.1 | 31.75 | 7.59 | 57.05 | 100 | 0 | P | H | |
| | | 4960 | 14.12 | -39.88 | 54 | - | - | - | - | - | - | A | H | |
| | | 7440 | 43.34 | -30.66 | 74 | 54.7 | 36.41 | 9.21 | 57.44 | 100 | 0 | P | H | |
| | | 7440 | 18.58 | -35.42 | 54 | - | - | - | - | - | - | A | H | |
| | | 4960 | 38.88 | -35.12 | 74 | 56.1 | 31.75 | 7.59 | 57.05 | 100 | 0 | P | V | |
| | | 4960 | 14.12 | -39.88 | 54 | - | - | - | - | - | - | A | V | |
| | | 7440 | 42.89 | -31.11 | 74 | 54.25 | 36.41 | 9.21 | 57.44 | 100 | 0 | P | V | |
| | | 7440 | 18.13 | -35.87 | 54 | - | - | - | - | - | - | A | V | |
| Remark | 1. No other spurious found. 2. All results are PASS against Peak and Average limit line. | | | | | | | | | | | | | |



2.4GHz 2400~2483.5MHz

BT (3M) (Band Edge @ 3m)

| BT | Note | Frequency | Level | Over | Limit | Read | Antenna | Cable | Preamp | Ant | Table | Peak | Pol. | |
|------------------------|------|-----------|------------|--------|------------|----------|----------|--------|--------|--------|---------|---------|---------|---|
| | | (MHz) | (dBμV/m) | (dB) | (dBμV/m) | (dBμV) | (dB/m) | (dB) | (dB) | (cm) | (deg) | (P/A) | (H/V) | |
| BT CH00 2402MHz | | 2347.17 | 41.4 | -32.6 | 74 | 40.89 | 26.73 | 4.78 | 31 | 226 | 216 | P | H | |
| | | 2347.17 | 16.64 | -37.36 | 54 | - | - | - | - | - | - | A | H | |
| | * | 2402 | 93.72 | - | - | 92.97 | 26.89 | 4.85 | 30.99 | 226 | 216 | P | H | |
| | * | 2402 | 68.96 | - | - | - | - | - | - | - | - | A | H | |
| | | | | | | | | | | | | | H | |
| | | | | | | | | | | | | | | H |
| | | | 2363.55 | 42.21 | -31.79 | 74 | 41.61 | 26.79 | 4.8 | 30.99 | 286 | 278 | P | V |
| | | | 2363.55 | 17.45 | -36.55 | 54 | - | - | - | - | - | - | A | V |
| | * | 2402 | 95.94 | - | - | 95.19 | 26.89 | 4.85 | 30.99 | 286 | 278 | P | V | |
| | * | 2402 | 71.18 | - | - | - | - | - | - | - | - | - | A | V |
| | | | | | | | | | | | | | | V |
| | | | | | | | | | | | | | | V |
| BT CH 39 2441MHz | | 2384.34 | 41.89 | -32.11 | 74 | 41.21 | 26.84 | 4.83 | 30.99 | 212 | 219 | P | H | |
| | | 2384.34 | 17.13 | -36.87 | 54 | - | - | - | - | - | - | A | H | |
| | * | 2441 | 93.38 | - | - | 92.43 | 27.04 | 4.88 | 30.97 | 212 | 219 | P | H | |
| | * | 2441 | 68.62 | - | - | - | - | - | - | - | - | A | H | |
| | | | 2493.56 | 41.11 | -32.89 | 74 | 39.94 | 27.2 | 4.93 | 30.96 | 212 | 219 | P | H |
| | | | 2493.56 | 16.35 | -37.65 | 54 | - | - | - | - | - | - | A | H |
| | | | 2358.72 | 40.8 | -33.2 | 74 | 40.21 | 26.79 | 4.8 | 31 | 270 | 275 | P | V |
| | | | 2358.72 | 16.04 | -37.96 | 54 | - | - | - | - | - | - | A | V |
| | * | 2441 | 94.36 | - | - | 93.41 | 27.04 | 4.88 | 30.97 | 270 | 275 | P | V | |
| | * | 2441 | 69.6 | - | - | - | - | - | - | - | - | - | A | V |
| | | | 2490.06 | 41.31 | -32.69 | 74 | 40.14 | 27.2 | 4.93 | 30.96 | 270 | 275 | P | V |
| | | | 2490.06 | 16.55 | -37.45 | 54 | - | - | - | - | - | - | A | V |



| | | | | | | | | | | | | | |
|---------------------------------|---|---------|-------|--------|----|-------|-------|------|-------|-----|-----|---|---|
| BT CH 78 2480MHz | * | 2480 | 92.39 | - | - | 91.29 | 27.15 | 4.92 | 30.97 | 194 | 220 | P | H |
| | * | 2480 | 67.63 | - | - | - | - | - | - | - | - | A | H |
| | | 2496.6 | 42.11 | -31.89 | 74 | 40.94 | 27.2 | 4.93 | 30.96 | 194 | 220 | P | H |
| | | 2496.6 | 17.35 | -36.65 | 54 | - | - | - | - | - | - | A | H |
| | | | | | | | | | | | | | H |
| | | | | | | | | | | | | | H |
| | * | 2480 | 92.5 | - | - | 91.4 | 27.15 | 4.92 | 30.97 | 269 | 280 | P | V |
| | * | 2480 | 67.74 | - | - | - | - | - | - | - | - | A | V |
| | | 2498.76 | 41.95 | -32.05 | 74 | 40.78 | 27.2 | 4.93 | 30.96 | 269 | 280 | P | V |
| | | 2498.76 | 17.19 | -36.81 | 54 | - | - | - | - | - | - | A | V |
| | | | | | | | | | | | | | V |
| | | | | | | | | | | | | | V |
| Remark | <ol style="list-style-type: none"> 1. No other spurious found. 2. All results are PASS against Peak and Average limit line. | | | | | | | | | | | | |



2.4GHz 2400~2483.5MHz

BT (3M) (Harmonic @ 3m)

| BT | Note | Frequency (MHz) | Level (dBμV/m) | Over Limit (dB) | Limit Line (dBμV/m) | Read Level (dBμV) | Antenna Factor (dB/m) | Cable Loss (dB) | Preamp Factor (dB) | Ant Pos (cm) | Table Pos (deg) | Peak Avg. (P/A) | Pol. (H/V) | |
|------------------------|---|----------------------|---------------------|-------------------------|-----------------------------|---------------------------|-------------------------------|-------------------------|----------------------------|----------------------|-------------------------|-------------------------|-----------------|---|
| BT CH 00 2402MHz | | 4804 | 38.37 | -35.63 | 74 | 56.29 | 31.53 | 7.3 | 57.27 | 100 | 0 | P | H | |
| | | 4804 | 13.61 | -40.39 | 54 | - | - | - | - | - | - | A | H | |
| | | | | | | | | | | | | | H | |
| | | | | | | | | | | | | | H | |
| | | 4804 | 39.11 | -34.89 | 74 | 57.03 | 31.53 | 7.3 | 57.27 | 100 | 0 | P | V | |
| | | 4804 | 14.35 | -39.65 | 54 | - | - | - | - | - | - | - | A | V |
| | | | | | | | | | | | | | | V |
| | | | | | | | | | | | | | | V |
| BT CH 39 2441MHz | | 4882 | 38.54 | -35.46 | 74 | 56.14 | 31.63 | 7.44 | 57.17 | 100 | 0 | P | H | |
| | | 4882 | 13.78 | -40.22 | 54 | - | - | - | - | - | - | A | H | |
| | | 7323 | 43.68 | -30.32 | 74 | 55.18 | 36.19 | 9.14 | 57.29 | 100 | 0 | P | H | |
| | | 7323 | 18.92 | -35.08 | 54 | - | - | - | - | - | - | A | H | |
| | | 4882 | 38.5 | -35.5 | 74 | 56.1 | 31.63 | 7.44 | 57.17 | 100 | 0 | P | V | |
| | | 4882 | 13.74 | -40.26 | 54 | - | - | - | - | - | - | A | V | |
| | | 7323 | 43.56 | -30.44 | 74 | 55.06 | 36.19 | 9.14 | 57.29 | 100 | 0 | P | V | |
| | | 7323 | 18.8 | -35.2 | 54 | - | - | - | - | - | - | A | V | |
| BT CH 78 2480MHz | | 4960 | 39.05 | -34.95 | 74 | 56.27 | 31.75 | 7.59 | 57.05 | 100 | 0 | P | H | |
| | | 4960 | 14.29 | -39.71 | 54 | - | - | - | - | - | - | A | H | |
| | | 7440 | 43.32 | -30.68 | 74 | 54.68 | 36.41 | 9.21 | 57.44 | 100 | 0 | P | H | |
| | | 7440 | 18.56 | -35.44 | 54 | - | - | - | - | - | - | A | H | |
| | | 4960 | 38.9 | -35.1 | 74 | 56.12 | 31.75 | 7.59 | 57.05 | 100 | 0 | P | V | |
| | | 4960 | 14.14 | -39.86 | 54 | - | - | - | - | - | - | A | V | |
| | | 7440 | 43.18 | -30.82 | 74 | 54.54 | 36.41 | 9.21 | 57.44 | 100 | 0 | P | V | |
| | | 7440 | 18.42 | -35.58 | 54 | - | - | - | - | - | - | A | V | |
| Remark | 1. No other spurious found. 2. All results are PASS against Peak and Average limit line. | | | | | | | | | | | | | |



Emission below 1GHz

2.4GHz BT (LF)

| BT | Note | Frequency | Level | Over | Limit | Read | Antenna | Cable | Preamp | Ant | Table | Peak | Pol. | |
|--------------------|--|-----------|------------|--------|------------|----------|----------|--------|--------|--------|---------|---------|---------|---|
| | | (MHz) | (dBμV/m) | (dB) | (dBμV/m) | (dBμV) | (dB/m) | (dB) | (dB) | (cm) | (deg) | (P/A) | (H/V) | |
| 2.4GHz BT LF | | 71.31 | 36.02 | -3.98 | 40 | 58.16 | 9.23 | 0.84 | 32.31 | 100 | 0 | P | H | |
| | | 274.35 | 37.68 | -8.32 | 46 | 52.28 | 15.82 | 1.68 | 32.17 | | | P | H | |
| | | 282.18 | 38.82 | -7.18 | 46 | 53.78 | 15.45 | 1.68 | 32.16 | | | P | H | |
| | | 305.6 | 38.3 | -7.7 | 46 | 52.89 | 15.76 | 1.72 | 32.13 | | | P | H | |
| | | 664 | 34.47 | -11.53 | 46 | 40.68 | 23.35 | 2.51 | 32.18 | | | P | H | |
| | | 851.6 | 33 | -13 | 46 | 35.48 | 26.26 | 2.87 | 31.74 | | | P | H | |
| | | | | | | | | | | | | | H | |
| | | | | | | | | | | | | | H | |
| | | | | | | | | | | | | | H | |
| | | | | | | | | | | | | | H | |
| | | | | | | | | | | | | | H | |
| | | | | | | | | | | | | | H | |
| | | | 32.16 | 29.29 | -10.71 | 40 | 40.09 | 20.97 | 0.59 | 32.34 | | | P | V |
| | | | 42.42 | 31.41 | -8.59 | 40 | 50.37 | 12.62 | 0.74 | 32.33 | | | P | V |
| | | | 70.77 | 34.46 | -5.54 | 40 | 56.84 | 8.99 | 0.84 | 32.31 | 100 | 0 | P | V |
| | | | 332.9 | 31.33 | -14.67 | 46 | 44.94 | 16.65 | 1.81 | 32.14 | | | P | V |
| | | | 666.1 | 33.76 | -12.24 | 46 | 39.97 | 23.35 | 2.51 | 32.18 | | | P | V |
| | | | 869.1 | 34.39 | -11.61 | 46 | 36.87 | 26.16 | 2.9 | 31.66 | | | P | V |
| | | | | | | | | | | | | | | V |
| | | | | | | | | | | | | | | V |
| | | | | | | | | | | | | | V | |
| | | | | | | | | | | | | | V | |
| | | | | | | | | | | | | | V | |
| | | | | | | | | | | | | | V | |
| Remark | 1. No other spurious found. 2. All results are PASS against limit line. | | | | | | | | | | | | | |



Note symbol

| | |
|-----|--|
| * | Fundamental Frequency which can be ignored. However, the level of any unwanted emissions shall not exceed the level of the fundamental frequency. |
| ! | Test result is over limit line. |
| P/A | Peak or Average |
| H/V | Horizontal or Vertical |



A calculation example for radiated spurious emission is shown as below:

| WIFI | Note | Frequency | Level | Over | Limit | Read | Antenna | Cable | Preamp | Ant | Table | Peak | Pol. |
|---------|------|-----------|------------|--------|------------|----------|----------|--------|--------|--------|---------|---------|---------|
| Ant. | | | | Limit | Line | Level | Factor | Loss | Factor | Pos | Pos | Avg. | |
| 1+2 | | (MHz) | (dBμV/m) | (dB) | (dBμV/m) | (dBμV) | (dB/m) | (dB) | (dB) | (cm) | (deg) | (P/A) | (H/V) |
| 802.11b | | 2390 | 55.45 | -18.55 | 74 | 54.51 | 32.22 | 4.58 | 35.86 | 103 | 308 | P | H |
| CH 01 | | | | | | | | | | | | | |
| 2412MHz | | 2390 | 43.54 | -10.46 | 54 | 42.6 | 32.22 | 4.58 | 35.86 | 103 | 308 | A | H |

- Level(dBμV/m) =
Antenna Factor(dB/m) + Cable Loss(dB) + Read Level(dBμV) - Preamp Factor(dB)
- Over Limit(dB) = Level(dBμV/m) – Limit Line(dBμV/m)

For Peak Limit @ 2390MHz:

- Level(dBμV/m)
= Antenna Factor(dB/m) + Cable Loss(dB) + Read Level(dBμV) - Preamp Factor(dB)
= 32.22(dB/m) + 4.58(dB) + 54.51(dBμV) – 35.86 (dB)
= 55.45 (dBμV/m)
- Over Limit(dB)
= Level(dBμV/m) – Limit Line(dBμV/m)
= 55.45(dBμV/m) – 74(dBμV/m)
= -18.55(dB)

For Average Limit @ 2390MHz:

- Level(dBμV/m)
= Antenna Factor(dB/m) + Cable Loss(dB) + Read Level(dBμV) - Preamp Factor(dB)
= 32.22(dB/m) + 4.58(dB) + 42.6(dBμV) – 35.86 (dB)
= 43.54 (dBμV/m)
- Over Limit(dB)
= Level(dBμV/m) – Limit Line(dBμV/m)
= 43.54(dBμV/m) – 54(dBμV/m)
= -10.46(dB)

Both peak and average measured complies with the limit line, so test result is “PASS”.



Appendix D. Radiated Spurious Emission Plots

| | | | |
|-----------------|-------------------------------------|---------------------|-------------|
| Test Engineer : | Alex Jheng / Bill Chang / Wilson Wu | Temperature : | 24.5~25.3°C |
| | | Relative Humidity : | 49~54% |

Note symbol

| | |
|----|-----------------------|
| -L | Low channel location |
| -R | High channel location |



2.4GHz 2400~2483.5MHz
BT (1M) (Band Edge @ 3m)

| BT | 2.4GHz 2400~2483.5MHz Band Edge @ 3m | |
|------|---|--|
| ANT | BT (1M) CH00 2402MHz | |
| 1 | Horizontal | Fundamental |
| Peak | <p>Site : 03CH13-I-Y Condition : PEAK BE 74 3m HORN 9120D 1241 HORIZONTAL</p> | <p>Site : 03CH13-I-Y Condition : PEAK 74 3m HORN 9120D 1241 HORIZONTAL</p> |

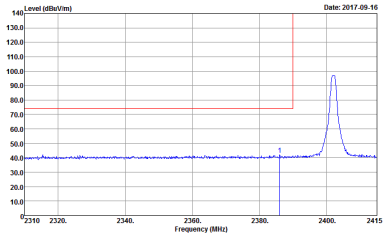
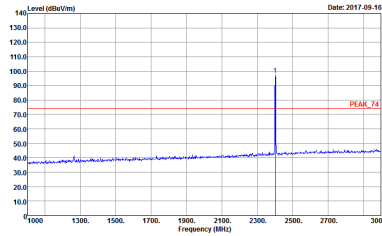

| BT | 2.4GHz 2400~2483.5MHz Band Edge @ 3m | |
|------|--|--|
| ANT | BT (1M) CH00 2402MHz | |
| 1 | Vertical | Fundamental |
| Peak |  <p>Site : 03CH13-HY Condition : PEAK BE 74 3m HORN 9120D 1241 VERTICAL</p> |  <p>Site : 03CH13-HY Condition : PEAK 74 3m HORN 9120D 1241 VERTICAL</p> |



| BT | 2.4GHz 2400~2483.5MHz Band Edge @ 3m | |
|--------------------|--|---|
| ANT | BT (1M) CH39 2441MHz | |
| 1 | Horizontal | Fundamental |
| <p>Peak</p> | <p>Site : 03CH13-HY Condition : PEAK BE 74 3m HORN 9120D 1241 HORIZONTAL</p> | <p>Site : 03CH13-HY Condition : PEAK 74 3m HORN 9120D 1241 HORIZONTAL</p> |
| <p>Peak</p> | <p>Site : 03CH13-HY Condition : PEAK BE 74 3m HORN 9120D 1241 HORIZONTAL</p> | <p>Left blank</p> |



| BT | 2.4GHz 2400~2483.5MHz Band Edge @ 3m | |
|--------------------|--|---|
| ANT | BT (1M) CH39 2441MHz | |
| 1 | Vertical | Fundamental |
| <p>Peak</p> | <p>Site : 03CH13-HY Condition : PEAK BE 74 3m HORN 9120D 1241 VERTICAL</p> | <p>Site : 03CH13-HY Condition : PEAK 74 3m HORN 9120D 1241 VERTICAL</p> |
| <p>Peak</p> | <p>Site : 03CH13-HY Condition : PEAK BE 74 3m HORN 9120D 1241 VERTICAL</p> | <p>Left blank</p> |



| | | |
|-------------|--|---|
| BT | 2.4GHz 2400~2483.5MHz Band Edge @ 3m | |
| ANT | BT (1M) CH78 2480MHz | |
| 1 | Horizontal | Fundamental |
| Peak | <p>Site : 03CH13-HY Condition : PEAK_BE_74 3m HORN 9120D 1241 HORIZONTAL</p> | <p>Site : 03CH13-HY Condition : PEAK_74 3m HORN 9120D 1241 HORIZONTAL</p> |

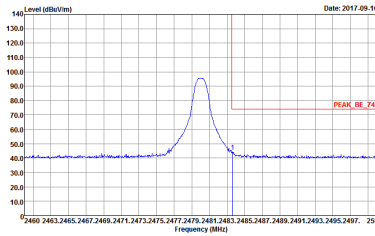
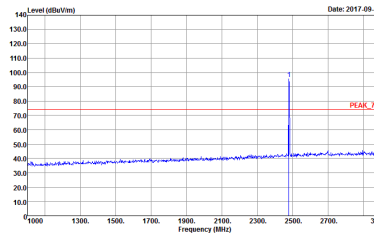

| BT | 2.4GHz 2400~2483.5MHz Band Edge @ 3m | |
|-------------|--|--|
| ANT | BT (1M) CH78 2480MHz | |
| 1 | Vertical | Fundamental |
| Peak |  <p>Site : 03CH13-HY Condition : PEAK_BE_74 3m HORN 9120D 1241 VERTICAL</p> |  <p>Site : 03CH13-HY Condition : PEAK_74 3m HORN 9120D 1241 VERTICAL</p> |



2.4GHz 2400~2483.5MHz
BT (1M) (Harmonic @ 3m)

| BT | 2.4GHz 2400~2483.5MHz Harmonic @ 3m | |
|--------------|--|--|
| ANT | BT (1M) CH00 2402MHz | |
| 1 | Horizontal | Vertical |
| Peak Avg. | <p>Horizontal spectrum plot showing a peak at 2402 MHz. The y-axis is Level (dBuV/m) from 0 to 140. The x-axis is Frequency (MHz) from 1000 to 25000. A peak is labeled '1' at approximately 45 dBuV/m. Two horizontal red lines indicate levels: 'PEAK 74' at approximately 74 dBuV/m and 'AVG 54' at approximately 54 dBuV/m. The plot title is 'Date: 2017-09-16'. Site: :03CH13-11Y. Condition: :PEAK 74 3m SHF HORN 584 HORIZONTAL.</p> | <p>Vertical spectrum plot showing a peak at 2402 MHz. The y-axis is Level (dBuV/m) from 0 to 140. The x-axis is Frequency (MHz) from 1000 to 25000. A peak is labeled '1' at approximately 45 dBuV/m. Two horizontal red lines indicate levels: 'PEAK 74' at approximately 74 dBuV/m and 'AVG 54' at approximately 54 dBuV/m. The plot title is 'Date: 2017-09-16'. Site: :03CH13-11Y. Condition: :PEAK 74 3m SHF HORN 584 VERTICAL.</p> |



| | | |
|----------------------|--|--|
| BT | 2.4GHz 2400~2483.5MHz Harmonic @ 3m | |
| ANT | BT (1M) CH39 2441MHz | |
| 1 | Horizontal | Vertical |
| Peak Avg. | <p>Site : 03CH13-1Y Condition : PEAK 74 3m SHF HORN 584 HORIZONTAL</p> | <p>Site : 03CH13-1Y Condition : PEAK 74 3m SHF HORN 584 VERTICAL</p> |



| | | |
|----------------------|--|--|
| BT | 2.4GHz 2400~2483.5MHz Harmonic @ 3m | |
| ANT | BT (1M) CH78 2480MHz | |
| 1 | Horizontal | Vertical |
| Peak Avg. | <p>Site : 03CH13-HY Condition : PEAK 74 3m SHF HORN 584 HORIZONTAL</p> | <p>Site : 03CH13-HY Condition : PEAK 74 3m SHF HORN 584 VERTICAL</p> |



2.4GHz 2400~2483.5MHz
BT (2M) (Band Edge @ 3m)

| BT | 2.4GHz 2400~2483.5MHz Band Edge @ 3m | |
|------|--|---|
| ANT | BT (2M) CH00 2402MHz | |
| 1 | Horizontal | Fundamental |
| Peak | <p>Site : 03CH13-HY Condition : PEAK BE 74 3m HORN 9120D 1241 HORIZONTAL</p> | <p>Site : 03CH13-HY Condition : PEAK 74 3m HORN 9120D 1241 HORIZONTAL</p> |

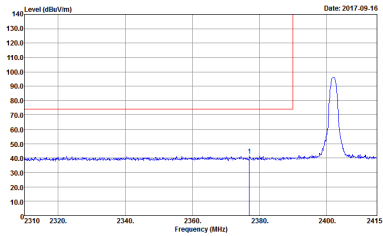
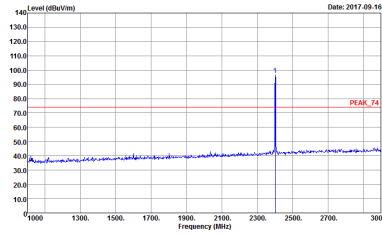

| BT | 2.4GHz 2400~2483.5MHz Band Edge @ 3m | |
|------|---|---|
| ANT | BT (2M) CH00 2402MHz | |
| 1 | Vertical | Fundamental |
| Peak |  <p>Site : 03CH13-1HY Condition : PEAK BE 74 3m HORN 9120D 1241 VERTICAL</p> |  <p>Site : 03CH13-1HY Condition : PEAK 74 3m HORN 9120D 1241 VERTICAL</p> |



| BT | 2.4GHz 2400~2483.5MHz Band Edge @ 3m | |
|------|--|---|
| ANT | BT (2M) CH39 2441MHz | |
| 1 | Horizontal | Fundamental |
| Peak | <p>Site : 03CH13-HY Condition : PEAK_BE_74 3m HORN 9120D 1241 HORIZONTAL</p> | <p>Site : 03CH13-HY Condition : PEAK_74 3m HORN 9120D 1241 HORIZONTAL</p> |
| Peak | <p>Site : 03CH13-HY Condition : PEAK_BE_74 3m HORN 9120D 1241 HORIZONTAL</p> | Left blank |



| BT | 2.4GHz 2400~2483.5MHz Band Edge @ 3m | |
|------|--|---|
| ANT | BT (2M) CH39 2441MHz | |
| 1 | Vertical | Fundamental |
| Peak | <p>Site : 03CH13-HY Condition : PEAK_BE_74 3m HORN 9120D 1241 VERTICAL</p> | <p>Site : 03CH13-HY Condition : PEAK_74 3m HORN 9120D 1241 VERTICAL</p> |
| Peak | <p>Site : 03CH13-HY Condition : PEAK_BE_74 3m HORN 9120D 1241 VERTICAL</p> | Left blank |

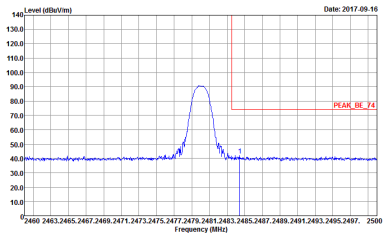
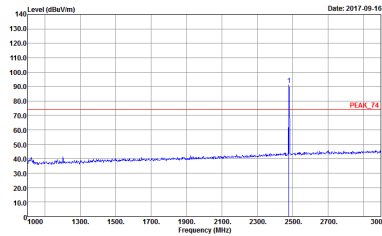

| BT | 2.4GHz 2400~2483.5MHz Band Edge @ 3m | |
|------|---|---|
| ANT | BT (2M) CH78 2480MHz | |
| 1 | Horizontal | Fundamental |
| Peak |  <p>Site : 03CH13-11Y Condition : PEAK BE 74 3m HORN 9120D 1241 HORIZONTAL</p> |  <p>Site : 03CH13-11Y Condition : PEAK 74 3m HORN 9120D 1241 HORIZONTAL</p> |

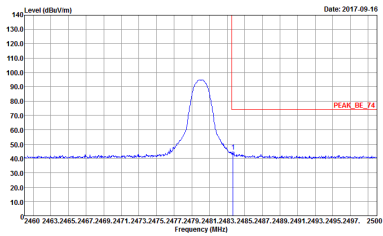
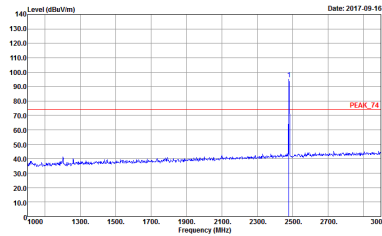

| BT | 2.4GHz 2400~2483.5MHz Band Edge @ 3m | |
|------|---|---|
| ANT | BT (2M) CH78 2480MHz | |
| 1 | Vertical | Fundamental |
| Peak |  <p>Site : 03CH13-11Y Condition : PEAK_BE 74 3m HORN 9120D 1241 VERTICAL</p> |  <p>Site : 03CH13-11Y Condition : PEAK 74 3m HORN 9120D 1241 VERTICAL</p> |



2.4GHz 2400~2483.5MHz
BT (2M) (Harmonic @ 3m)

| BT | 2.4GHz 2400~2483.5MHz Harmonic @ 3m | |
|--------------|---|---|
| ANT | BT (2M) CH00 2402MHz | |
| 1 | Horizontal | Vertical |
| Peak Avg. | <p>Site : 03CH13-11Y Condition : PEAK 74 3m SHF HORN 584 HORIZONTAL</p> | <p>Site : 03CH13-11Y Condition : PEAK 74 3m SHF HORN 584 VERTICAL</p> |



| | | |
|----------------------|--|--|
| BT | 2.4GHz 2400~2483.5MHz Harmonic @ 3m | |
| ANT | BT (2M) CH39 2441MHz | |
| 1 | Horizontal | Vertical |
| Peak Avg. | <p>Site : 03CH13-HY Condition : PEAK 74 3m SHF HORN 584 HORIZONTAL</p> | <p>Site : 03CH13-HY Condition : PEAK 74 3m SHF HORN 584 VERTICAL</p> |



| | | |
|----------------------|--|--|
| BT | 2.4GHz 2400~2483.5MHz Harmonic @ 3m | |
| ANT | BT (2M) CH78 2480MHz | |
| 1 | Horizontal | Vertical |
| Peak Avg. | <p>Site : 03CH13-HY Condition : PEAK 74 3m SHF HORN 584 HORIZONTAL</p> | <p>Site : 03CH13-HY Condition : PEAK 74 3m SHF HORN 584 VERTICAL</p> |



2.4GHz 2400~2483.5MHz
BT (3M) (Band Edge @ 3m)

| BT | 2.4GHz 2400~2483.5MHz Band Edge @ 3m | |
|------|--|---|
| ANT | BT (3M) CH00 2402MHz | |
| 1 | Horizontal | Fundamental |
| Peak | <p>Site : 03CH13-HY Condition : PEAK BE 74 3m HORN 9120D 1241 HORIZONTAL</p> | <p>Site : 03CH13-HY Condition : PEAK 74 3m HORN 9120D 1241 HORIZONTAL</p> |

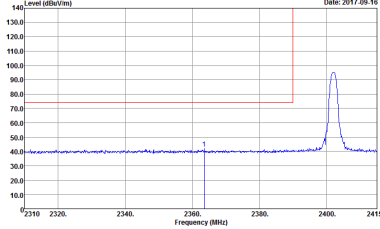
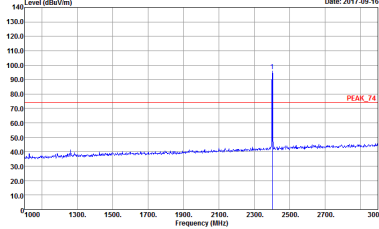

| BT | 2.4GHz 2400~2483.5MHz Band Edge @ 3m | |
|------|---|---|
| ANT | BT (3M) CH00 2402MHz | |
| 1 | Vertical | Fundamental |
| Peak |  <p>Site : 03CH13-11Y Condition : PEAK BE 74 3m HORN 9120D 1241 VERTICAL</p> |  <p>Site : 03CH13-11Y Condition : PEAK 74 3m HORN 9120D 1241 VERTICAL</p> |

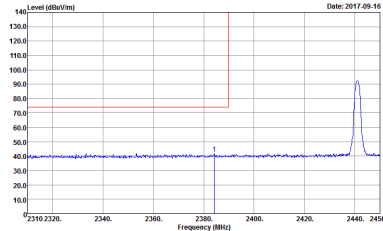
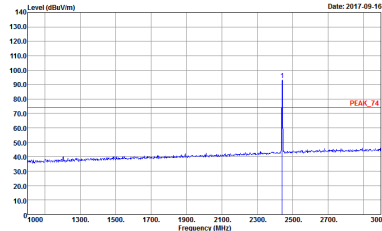
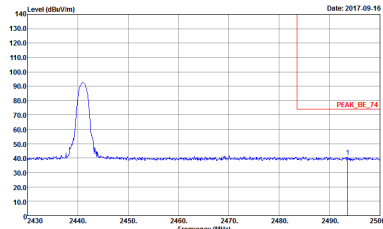

| BT | 2.4GHz 2400~2483.5MHz Band Edge @ 3m | |
|------|--|--|
| ANT | BT (3M) CH39 2441MHz | |
| 1 | Horizontal | Fundamental |
| Peak |  <p>Site : 03CH13-HY Condition : PEAK BE 74 3m HORN 9120D 1241 HORIZONTAL</p> |  <p>Site : 03CH13-HY Condition : PEAK 74 3m HORN 9120D 1241 HORIZONTAL</p> |
| Peak |  <p>Site : 03CH13-HY Condition : PEAK BE 74 3m HORN 9120D 1241 HORIZONTAL</p> | Left blank |



| BT | 2.4GHz 2400~2483.5MHz Band Edge @ 3m | |
|--------------------|--|---|
| ANT | BT (3M) CH39 2441MHz | |
| 1 | Vertical | Fundamental |
| <p>Peak</p> | <p>Site : 03CH13-HY Condition : PEAK BE 74 3m HORN 9120D 1241 VERTICAL</p> | <p>Site : 03CH13-HY Condition : PEAK 74 3m HORN 9120D 1241 VERTICAL</p> |
| <p>Peak</p> | <p>Site : 03CH13-HY Condition : PEAK BE 74 3m HORN 9120D 1241 VERTICAL</p> | <p>Left blank</p> |

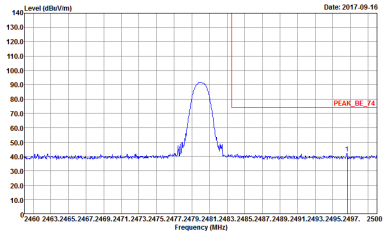
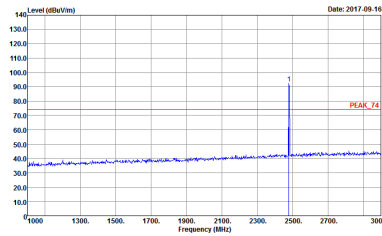

| BT | 2.4GHz 2400~2483.5MHz Band Edge @ 3m | |
|------|--|--|
| ANT | BT (3M) CH78 2480MHz | |
| 1 | Horizontal | Fundamental |
| Peak |  <p>Site : 03CH13-HY Condition : PEAK BE 74 3m HORN 9120D 1241 HORIZONTAL</p> |  <p>Site : 03CH13-HY Condition : PEAK 74 3m HORN 9120D 1241 HORIZONTAL</p> |

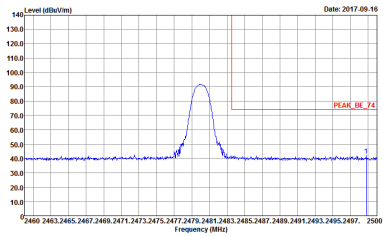
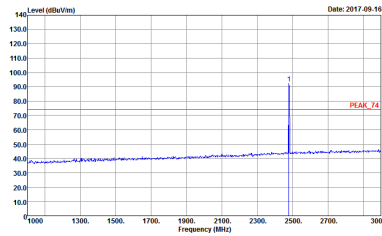

| BT | 2.4GHz 2400~2483.5MHz Band Edge @ 3m | |
|------|--|--|
| ANT | BT (3M) CH78 2480MHz | |
| 1 | Vertical | Fundamental |
| Peak |  <p>Site : 03CH13-HY Condition : PEAK_BE 74 3m HORN 9120D 1241 VERTICAL</p> |  <p>Site : 03CH13-HY Condition : PEAK 74 3m HORN 9120D 1241 VERTICAL</p> |



2.4GHz 2400~2483.5MHz
BT (3M) (Harmonic @ 3m)

| BT | 2.4GHz 2400~2483.5MHz Harmonic @ 3m | |
|--------------|---|---|
| ANT | BT (3M) CH00 2402MHz | |
| 1 | Horizontal | Vertical |
| Peak Avg. | <p>Horizontal spectrum plot showing a peak at 2402 MHz. The y-axis is Level (dBuV/m) from 0 to 140. The x-axis is Frequency (MHz) from 1000 to 25000. A peak is labeled 'PEAK 74' at approximately 75 dBuV/m. An average level is labeled 'AVG 54' at approximately 55 dBuV/m. The plot title is 'Date: 2017-09-16'. Site: :03CH13-11Y. Condition: :PEAK 74 3m SHF HORN 584 HORIZONTAL.</p> | <p>Vertical spectrum plot showing a peak at 2402 MHz. The y-axis is Level (dBuV/m) from 0 to 140. The x-axis is Frequency (MHz) from 1000 to 25000. A peak is labeled 'PEAK 74' at approximately 75 dBuV/m. An average level is labeled 'AVG 54' at approximately 55 dBuV/m. The plot title is 'Date: 2017-09-16'. Site: :03CH13-11Y. Condition: :PEAK 74 3m SHF HORN 584 VERTICAL.</p> |



| | | |
|----------------------|--|--|
| BT | 2.4GHz 2400~2483.5MHz Harmonic @ 3m | |
| ANT | BT (3M) CH39 2441MHz | |
| 1 | Horizontal | Vertical |
| Peak Avg. | <p>Site : 03CH13-HY Condition : PEAK 74 3m SHF HORN 584 HORIZONTAL</p> | <p>Site : 03CH13-HY Condition : PEAK 74 3m SHF HORN 584 VERTICAL</p> |

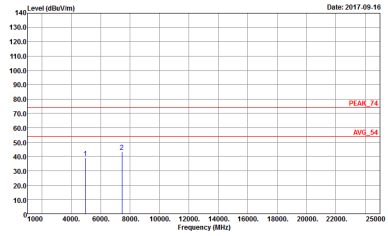
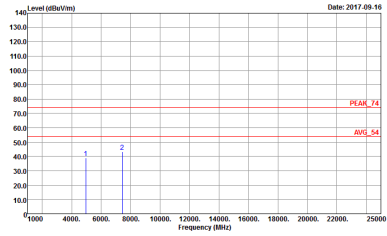

| | | |
|----------------------|--|---|
| BT | 2.4GHz 2400~2483.5MHz Harmonic @ 3m | |
| ANT | BT (3M) CH78 2480MHz | |
| 1 | Horizontal | Vertical |
| Peak Avg. |  <p>Site : 03CH13-HY Condition : PEAK 74 3m SHF HORN 584 HORIZONTAL</p> |  <p>Site : 03CH13-HY Condition : PEAK 74 3m SHF HORN 584 VERTICAL</p> |



Emission below 1GHz
2.4GHz BT (LF)

| BT | 2.4GHz 2400~2483.5MHz | |
|----------------------|-----------------------|----------|
| ANT | BT LF | |
| 1 | Horizontal | Vertical |
| <p>QP / Peak</p> | | |

Appendix E. Duty Cycle Plots

<1Mbps>

DH5 on time (One Pulse) Plot on Channel 39

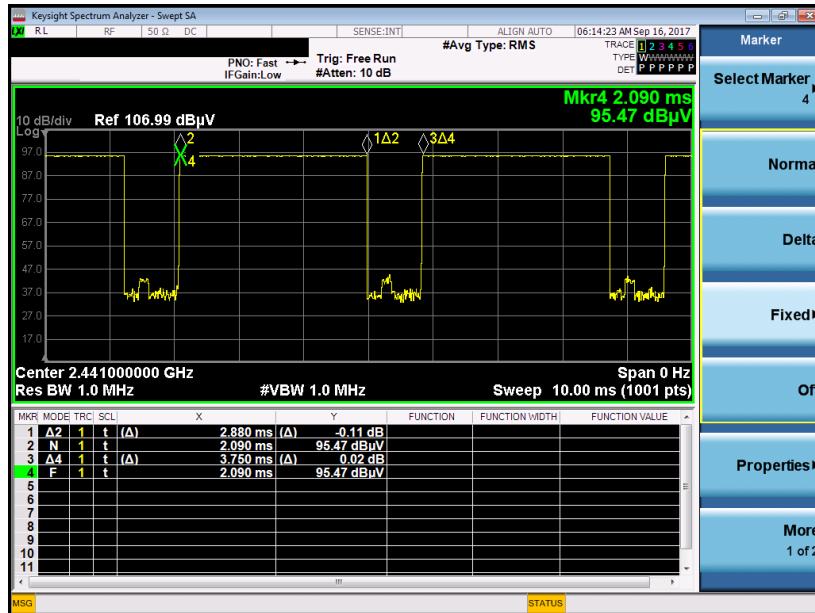

on time (Count Pulses) Plot on Channel 39

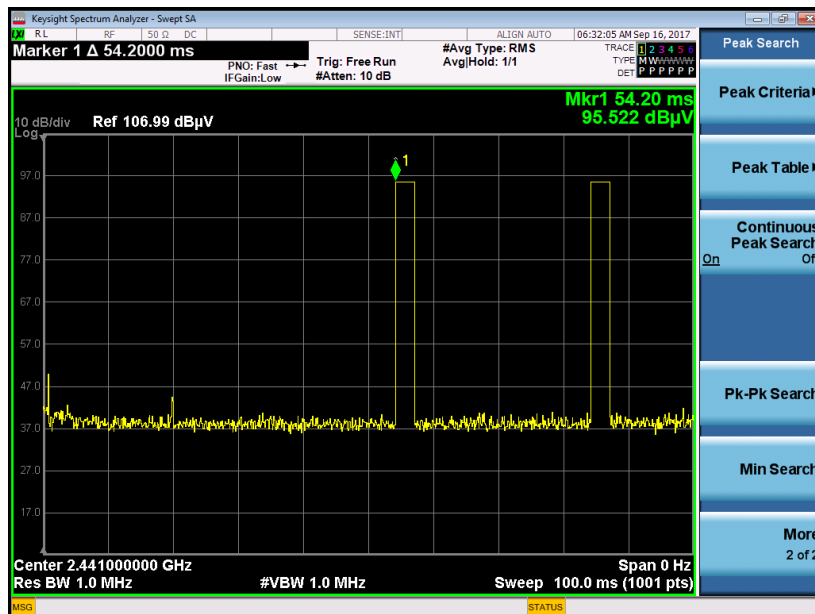

Note:

1. Worst case Duty cycle = on time/100 milliseconds = 2 * 2.88 / 100 = 5.76 %
2. Worst case Duty cycle correction factor = 20*log(Duty cycle) = -24.79 dB
3. DH5 has the highest duty cycle worst case and is reported.

<2Mbps>

2DH5 on time (One Pulse) Plot on Channel 39

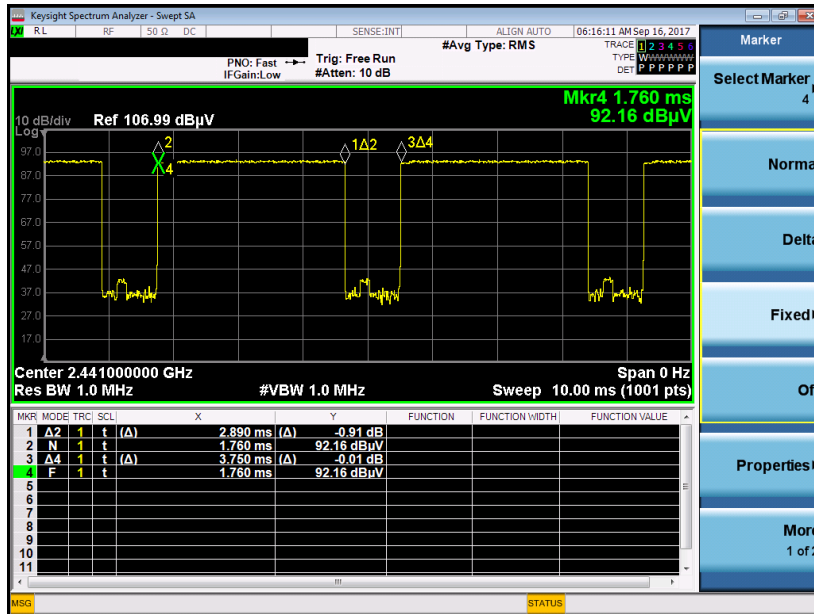

on time (Count Pulses) Plot on Channel 39

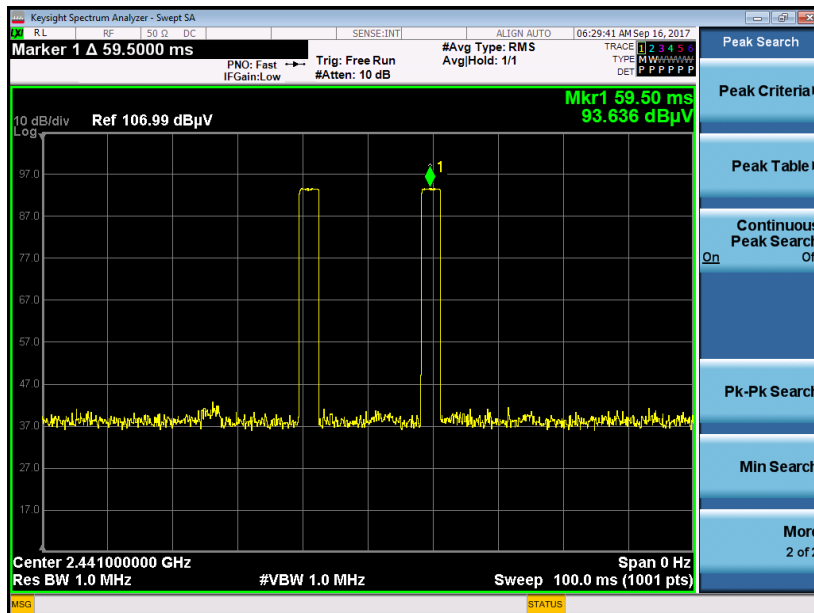

Note:

1. Worst case Duty cycle = on time/100 milliseconds = $2 * 2.89 / 100 = 5.78\%$
2. Worst case Duty cycle correction factor = $20 * \log(\text{Duty cycle}) = -24.76 \text{ dB}$
3. 2DH5 has the highest duty cycle worst case and is reported.

<3Mbps>

3DH5 on time (One Pulse) Plot on Channel 39

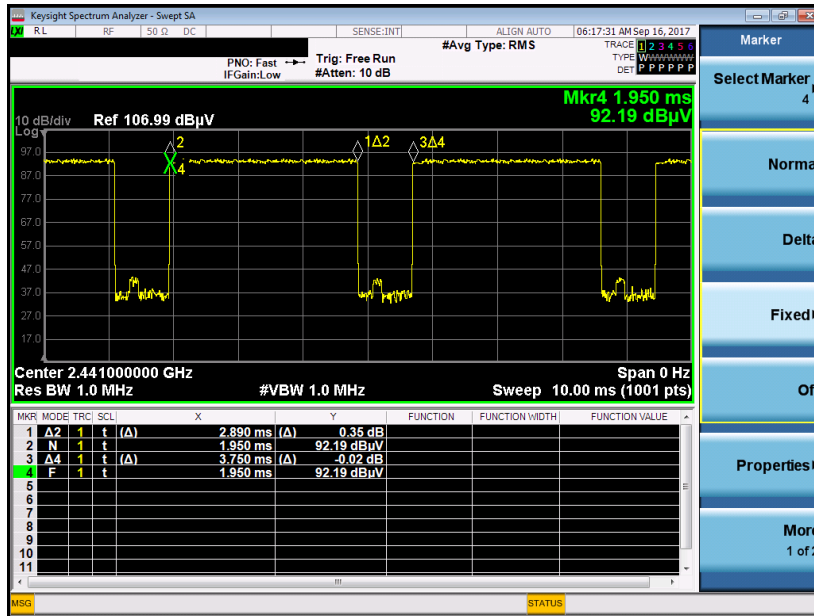

on time (Count Pulses) Plot on Channel 39

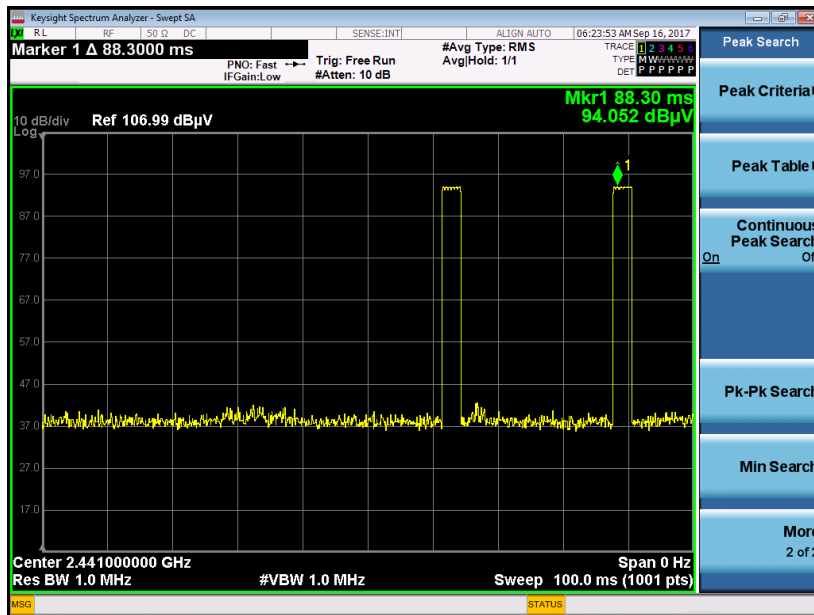

Note:

1. Worst case Duty cycle = on time/100 milliseconds = $2 * 2.89 / 100 = 5.768 \%$
2. Worst case Duty cycle correction factor = $20 * \log(\text{Duty cycle}) = -24.76 \text{ dB}$
3. 3DH5 has the highest duty cycle worst case and is reported.



Duty Cycle Correction Factor Consideration for AFH mode:

Bluetooth normal hopping rate is 1600Hz and reduced to 800Hz in AFH mode; due to the reduced number of hopping frequencies, with the same packet configuration the dwell time in each channel frequency within 100msec period is longer in AFH mode than normal mode.

In AFH mode, the minimum hopping frequencies are 20, to get the longest dwell time DH5 packet is observed; the period to have DH5 packet completing one hopping sequence is

$$2.88 \text{ ms} \times 20 \text{ channels} = 57.6 \text{ ms}$$

There cannot be 2 complete hopping sequences within 100ms period, considering the random hopping behavior, maximum 2 hops can be possibly observed within the period. $[100\text{ms} / 57.6\text{ms}] = 2$ hops

Thus, the maximum possible ON time:

$$2.88 \text{ ms} \times 2 = 5.76 \text{ ms}$$

Worst case Duty Cycle Correction factor, which is derived from the maximum possible ON time,

$$20 \times \log(5.76 \text{ ms}/100\text{ms}) = -24.79 \text{ dB}$$