



# FCC RADIO TEST REPORT

**FCC ID** : PY7-04706A  
**Equipment** : GSM/WCDMA/LTE Phone+Bluetooth,  
DTS/UNII a/b/g/n/ac and NFC  
**Brand Name** : Sony  
**Applicant** : Sony Mobile Communications Inc.  
4-12-3 Higashi-Shinagawa,  
Shinagawa-ku, Tokyo, 140-0002, Japan  
**Manufacturer** : Sony Mobile Communications Inc.  
4-12-3 Higashi-Shinagawa,  
Shinagawa-ku, Tokyo, 140-0002, Japan  
**Standard** : FCC Part 15 Subpart E §15.407

The product was received on Aug. 14, 2018 and testing was started from Sep. 04, 2018 and completed on Nov. 23, 2018. We, SPORTON INTERNATIONAL INC., would like to declare that the tested sample has been evaluated in accordance with the test procedures and has been in compliance with the applicable technical standards.

The report must not be used by the client to claim product certification, approval, or endorsement by TAF or any agency of government.

The test results in this report apply exclusively to the tested model / sample. Without written approval of SPORTON INTERNATIONAL INC. EMC & Wireless Communications Laboratory, the test report shall not be reproduced except in full.

Approved by: Jones Tsai

**SPORTON INTERNATIONAL INC. EMC & Wireless Communications Laboratory**

No. 52, Huaya 1st Rd., Guishan Dist., Taoyuan City, Taiwan (R.O.C.)



## Table of Contents

History of this test report.....	3
Summary of Test Result.....	4
<b>1 General Description .....</b>	<b>5</b>
1.1 Product Feature of Equipment Under Test.....	5
1.2 Modification of EUT .....	5
1.3 Testing Location .....	6
1.4 Applicable Standards.....	6
<b>2 Test Configuration of Equipment Under Test .....</b>	<b>7</b>
2.1 Carrier Frequency and Channel .....	7
2.2 Test Mode.....	8
2.3 Connection Diagram of Test System.....	9
2.4 Support Unit used in test configuration and system .....	10
2.5 EUT Operation Test Setup .....	10
2.6 Measurement Results Explanation Example.....	10
<b>3 Test Result .....</b>	<b>11</b>
3.1 6dB and 26dB and 99% Occupied Bandwidth Measurement .....	11
3.2 Maximum Conducted Output Power Measurement .....	14
3.3 Power Spectral Density Measurement .....	15
3.4 Unwanted Emissions Measurement.....	17
3.5 AC Conducted Emission Measurement.....	22
3.6 Automatically Discontinue Transmission .....	24
3.7 Antenna Requirements.....	25
<b>4 List of Measuring Equipment.....</b>	<b>26</b>
<b>5 Uncertainty of Evaluation.....</b>	<b>28</b>
<b>Appendix A. Conducted Test Results</b>	
<b>Appendix B. AC Conducted Emission Test Result</b>	
<b>Appendix C. Radiated Spurious Emission</b>	
<b>Appendix D. Radiated Spurious Emission Plots</b>	
<b>Appendix E. Duty Cycle Plots</b>	



### History of this test report

Report No.	Version	Description	Issued Date
FR881333-01F	01	Initial issue of report	Dec. 10, 2018



## Summary of Test Result

Report Clause	Ref Std. Clause	Test Items	Result (PASS/FAIL)	Remark
3.1	15.403 (i)	6dB & 26dB Bandwidth	Pass	-
3.1	2.1049	99% Occupied Bandwidth	Reporting only	-
3.2	15.407 (a)	Maximum Conducted Output Power	Pass	-
3.3	15.407 (a)	Power Spectral Density	Pass	-
3.4	15.407(b)	Unwanted Emissions	Pass	Under limit 8.00 dB at 30.000 MHz
3.5	15.207	AC Conducted Emission	Pass	Under limit 7.47 dB at 1.066 MHz
3.6	15.407 (c)	Automatically Discontinue Transmission	Pass	-
3.7	15.203 & 15.407 (a)	Antenna Requirement	Pass	-

Reviewed by: **Wii Chang**

Report Producer: **Natasha Hsieh**



# 1 General Description

## 1.1 Product Feature of Equipment Under Test

GSM/WCDMA/LTE, Bluetooth, DTS/UNII a/b/g/n/ac, FM Receiver, NFC, and GNSS.

Standards-related Product Specification	
Antenna Type / Gain	Coupling Antenna with gain -1.50 dBi

EUT Information List			
HW Version	SW Version	S/N	Performed Test Item
A	1.156	CQ30013GV5	RF conducted measurement
		CQ30019G11	Radiated Spurious Emission
		CQ30019FT5	AC Conducted Emission

Accessory List	
AC Adapter	Model Name: UCH32
	S/N: 6218W30200215 (for radiated emission) 6218W30200140 (for conducted emission)
Earphone	Model Name: MH410c
	S/N: N/A
USB Cable	Model Name: UCB24
	S/N: N/A

**Note:**

1. Above EUT list used are electrically identical per declared by manufacturer.
2. Above the accessories list are used to exercise the EUT during test, and the serial number of each type of accessories is listed in each section of this report. .
3. For other wireless features of this EUT, test report will be issued separately.

## 1.2 Modification of EUT

No modifications are made to the EUT during all test items.



### 1.3 Testing Location

Sporton Lab is accredited to ISO 17025 by Taiwan Accreditation Foundation (TAF code : 1190) and the FCC designation No. TW1190 under the FCC 2.948(e) by Mutual Recognition Agreement (MRA) in FCC Test.

<b>Test Site</b>	SPORTON INTERNATIONAL INC.		
<b>Test Site Location</b>	No.52, Huaya 1st Rd., Guishan Dist., Taoyuan City, Taiwan (R.O.C.) TEL: +886-3-327-3456 FAX: +886-3-328-4978		
<b>Test Site No.</b>	<b>Sporton Site No.</b>		
	TH05-HY	CO05-HY	03CH07-HY

**Note:** The test site complies with ANSI C63.4 2014 requirement.

### 1.4 Applicable Standards

According to the specifications of the manufacturer, the EUT must comply with the requirements of the following standards:

- ♦ FCC Part 15 Subpart E
- ♦ FCC KDB 789033 D02 General UNII Test Procedures New Rules v02r01.
- ♦ FCC KDB 414788 D01 Radiated Test Site v01r01.
- ♦ ANSI C63.10-2013

**Remark:**

1. All test items were verified and recorded according to the standards and without any deviation during the test.
2. This EUT has also been tested and complied with the requirements of FCC Part 15, Subpart B, recorded in a separate test report.



## 2 Test Configuration of Equipment Under Test

- a. The EUT has been associated with peripherals and configuration operated in a manner tended to maximize its emission characteristics in a typical application. Frequency range investigated: conduction emission (150 kHz to 30 MHz), radiation emission (9 kHz to the 10th harmonic of the highest fundamental frequency or to 40 GHz, whichever is lower). For radiated measurement, pre-scanned in three orthogonal panels, X, Y, Z. The worst cases (X plane) were recorded in this report.
  
- b. AC power line Conducted Emission was tested under maximum output power.

### 2.1 Carrier Frequency and Channel

Frequency Band	Channel	Freq. (MHz)	Channel	Freq. (MHz)
5725-5850 MHz Band 4 (U-NII-3)	149	5745	157	5785
	151*	5755	159*	5795
	153	5765	161	5805
	155 <sup>#</sup>	5775	165	5825

**Note:**

- 1. The above Frequency and Channel in "\*" were 802.11n HT40 and 802.11ac VHT40.
- 2. The above Frequency and Channel in "<sup>#</sup>" were 802.11ac VHT80.



## 2.2 Test Mode

Final test modes are considering the modulation and worse data rates as below table.

Modulation	Data Rate
802.11a	6 Mbps
802.11n HT20	MCS0
802.11n HT40	MCS0
802.11ac VHT20 (Covered by HT20)	MCS0
802.11ac VHT40	MCS0
802.11ac VHT80	MCS0

Test Cases	
AC Conducted Emission	Mode 1 : Bluetooth Link + WLAN (5GHz) Link + Earphone + Battery + USB Cable (Charging from Adapter)

Ch. #		Band IV : 5725-5850 MHz		
		802.11a	802.11n HT20	802.11n HT40
L	Low	149	149	151
M	Middle	157	157	-
H	High	165	165	159

Ch. #		Band IV : 5725-5850 MHz	
		802.11ac VHT40	802.11ac VHT80
L	Low	151	-
M	Middle	-	155
H	High	159	-



## 2.3 Connection Diagram of Test System

<WLAN Tx Mode>

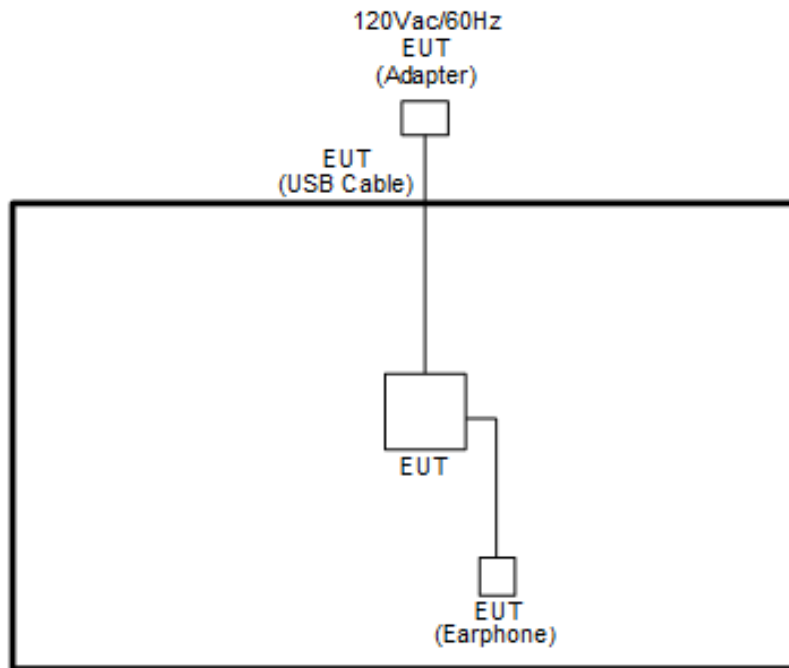

<AC Conducted Emissions Mode>

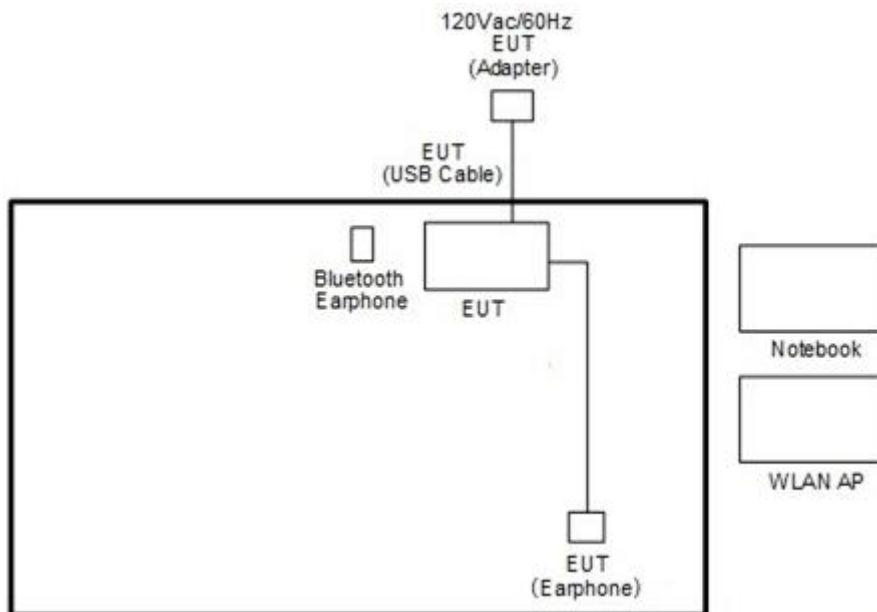



## 2.4 Support Unit used in test configuration and system

Item	Equipment	Trade Name	Model Name	FCC ID	Data Cable	Power Cord
1.	WLAN AP	ASUS	RT-AC66U	MSQ-RTAC66U	N/A	Unshielded, 1.8 m
2.	Bluetooth Earphone	Sony	SBH20	PY7-RD0010	N/A	N/A
3.	Notebook	DELL	P20G	FCC DoC/ Contains FCC ID: QDS-BRCM1051	N/A	AC I/P: Unshielded, 1.2 m DC O/P: Shielded, 1.8 m
4.	SD Card	SanDisk	MicroSD HC	FCC DoC	N/A	N/A

## 2.5 EUT Operation Test Setup

The RF test items, utility “QRCT” was installed in Notebook which was programmed in order to make the EUT get into the engineering modes to provide channel selection, power level, data rate and the application type and for continuous transmitting signals.

## 2.6 Measurement Results Explanation Example

**For all conducted test items:**

The offset level is set in the spectrum analyzer to compensate the RF cable loss and attenuator factor between EUT conducted output port and spectrum analyzer. With the offset compensation, the spectrum analyzer reading level is exactly the EUT RF output level.

Example :

The spectrum analyzer offset is derived from RF cable loss and attenuator factor.

*Offset = RF cable loss + attenuator factor.*

Following shows an offset computation example with cable loss 4.2 dB and 10dB attenuator.

$$\begin{aligned} \text{Offset(dB)} &= \text{RF cable loss(dB)} + \text{attenuator factor(dB)} \\ &= 4.2 + 10 = 14.2 \text{ (dB)} \end{aligned}$$

### 3 Test Result

#### 3.1 6dB and 26dB and 99% Occupied Bandwidth Measurement

##### 3.1.1 Description of 6dB and 26dB and 99% Occupied Bandwidth

The minimum 6 dB bandwidth shall be at least 500 kHz.

26dB and 99% Occupied bandwidth are reporting only.

##### 3.1.2 Measuring Instruments

See list of measuring equipment of this test report.

##### 3.1.3 Test Procedures

1. The testing follows FCC KDB 789033 D02 General UNII Test Procedures New Rules v02r01. Section C) Emission bandwidth for the band 5.725-5.85GHz
2. Set RBW = 100kHz.
3. Set the VBW  $\geq 3 \times$  RBW.
4. Detector = Peak.
5. Trace mode = max hold
6. Measure the maximum width of the emission that is 6 dB down from the peak of the emission.
7. Measure and record the results in the test report.

##### 3.1.4 Test Setup



##### 3.1.5 Test Result of 6dB Bandwidth

Please refer to Appendix A.

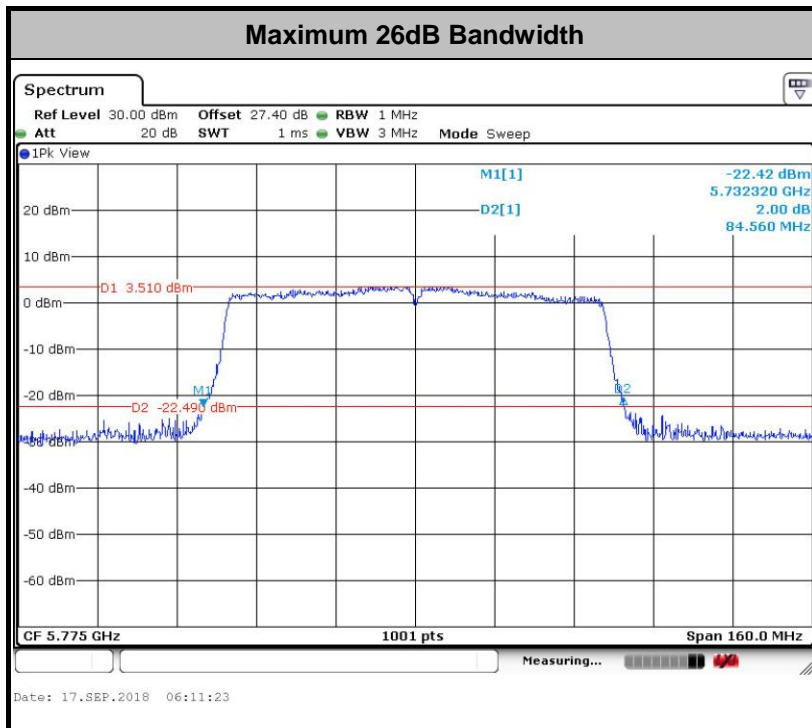
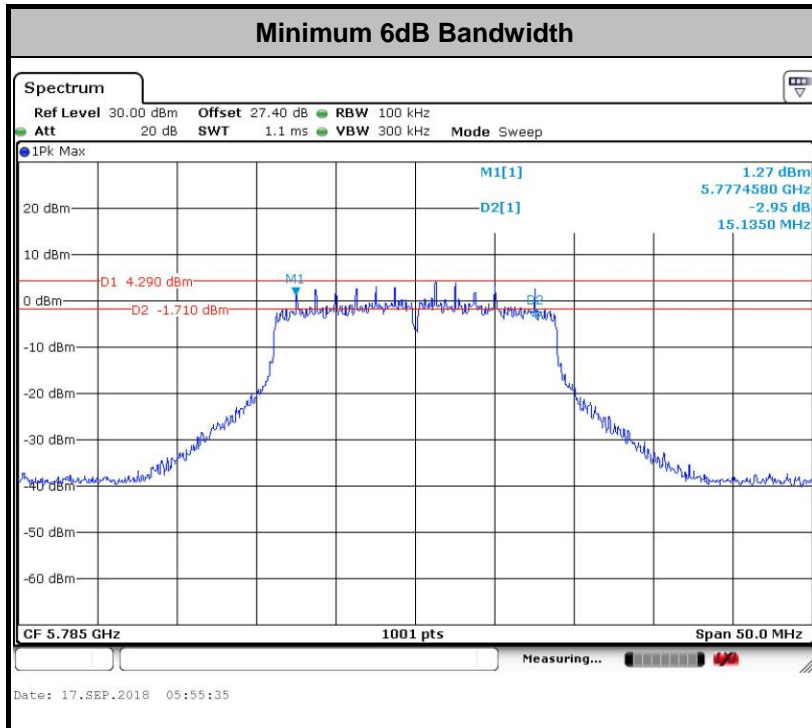

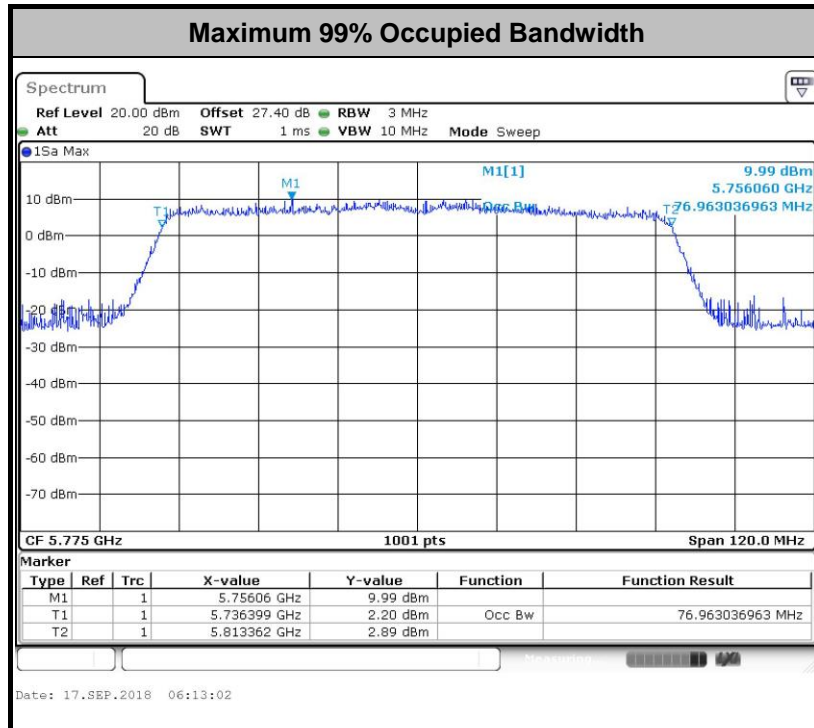

**Note:** The occupied channel bandwidth is maintained within the band of operation for all of the modulations.

## 3.2 Maximum Conducted Output Power Measurement

### 3.2.1 Limit of Maximum Conducted Output Power

For the band 5.725–5.85 GHz, the maximum conducted output power over the frequency band of operation shall not exceed 1 W.

If transmitting antennas of directional gain greater than 6 dBi are used, the peak output power shall be reduced by the amount in dB that the directional gain of the antenna exceeds 6 dBi.

### 3.2.2 Measuring Instruments

See list of measuring equipment of this test report.

### 3.2.3 Test Procedures

The testing follows Method PM of FCC KDB 789033 D02 General UNII Test Procedures New Rules v02r01.

Method PM (Measurement using an RF average power meter):

1. Measurement is performed using a wideband RF power meter.
2. The EUT is configured to transmit continuously with a consistent duty cycle at its maximum power control level.
3. Measure the average power of the transmitter, and the average power is corrected with duty factor,  $10 \log(1/x)$ , where  $x$  is the duty cycle.

### 3.2.4 Test Setup

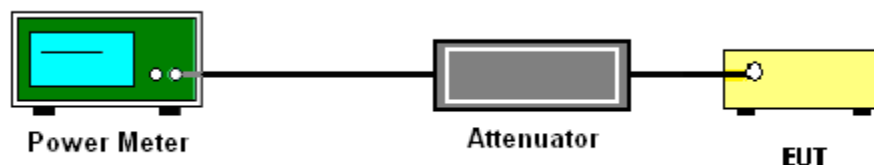

### 3.2.5 Test Result of Maximum Conducted Output Power

Please refer to Appendix A.



### 3.3 Power Spectral Density Measurement

#### 3.3.1 Limit of Power Spectral Density

For the band 5.725–5.85 GHz, the maximum power spectral density shall not exceed 30 dBm in any 500-kHz band.

If transmitting antennas of directional gain greater than 6 dBi are used, the peak output power shall be reduced by the amount in dB that the directional gain of the antenna exceeds 6 dBi.

#### 3.3.2 Measuring Instruments

See list of measuring equipment of this test report.

#### 3.3.3 Test Procedures

The testing follows FCC KDB 789033 D02 General UNII Test Procedures New Rules v02r01. Section F) Maximum power spectral density.

##### # Method SA-2 #

(trace averaging across on and off times of the EUT transmissions, followed by duty cycle correction).

- Measure the duty cycle.
  - Set span to encompass the entire emission bandwidth (EBW) of the signal.
  - Set RBW = 300 kHz.
  - Set VBW  $\geq$  1 MHz.
  - Number of points in sweep  $\geq$  2 Span / RBW.
  - Sweep time = auto.
  - Detector = RMS
  - Trace average at least 100 traces in power averaging mode.
  - Add  $10 \log(500\text{kHz}/\text{RBW})$  to the test result.
  - Add  $10 \log(1/x)$ , where x is the duty cycle, to the measured power in order to compute the average power during the actual transmission times. For example, add  $10 \log(1/0.25) = 6$  dB if the duty cycle is 25 percent.
1. The RF output of EUT was connected to the spectrum analyzer by a low loss cable.
  2. Each plot has already offset with cable loss, and attenuator loss. Measure the PPSD and record it.

### 3.3.4 Test Setup

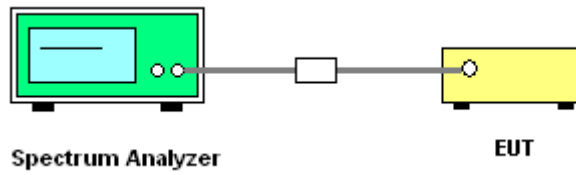

### 3.3.5 Test Result of Power Spectral Density

Please refer to Appendix A.

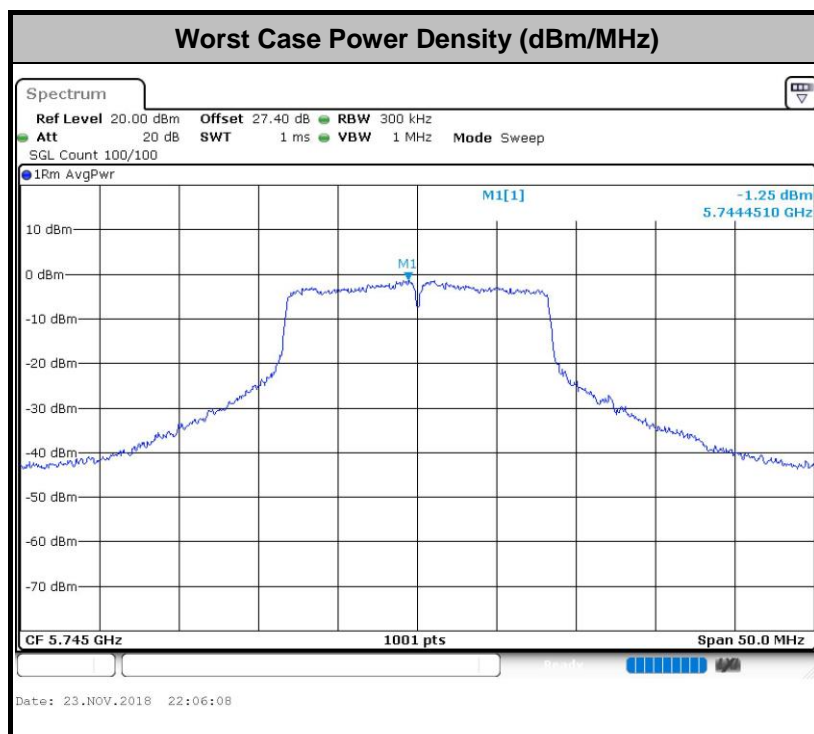





### 3.4 Unwanted Emissions Measurement

This section is to measure unwanted emissions through radiated measurement for band edge spurious emissions and out of band emissions measurement.

#### 3.4.1 Limit of Unwanted Emissions

- (1) For transmitters operating in the 5.725-5.85 GHz band:  
 15.407(b)(4)(i) All emissions shall be limited to a level of -27 dBm/MHz at 75 MHz or more above or below the band edge increasing linearly to 10 dBm/MHz at 25 MHz above or below the band edge, and from 25 MHz above or below the band edge increasing linearly to a level of 15.6 dBm/MHz at 5 MHz above or below the band edge, and from 5 MHz above or below the band edge increasing linearly to a level of 27 dBm/MHz at the band edge.
- (2) Unwanted spurious emissions fallen in restricted bands shall comply with the general field strength limits as below table,

Frequency (MHz)	Field Strength (microvolts/meter)	Measurement Distance (meters)
0.009 – 0.490	2400/F(kHz)	300
0.490 – 1.705	24000/F(kHz)	30
1.705 – 30.0	30	30
30 – 88	100	3
88 – 216	150	3
216 - 960	200	3
Above 960	500	3

**Note:** The following formula is used to convert the EIRP to field strength.

$$E = \frac{1000000\sqrt{30P}}{3} \text{ } \mu\text{V/m, where P is the eirp (Watts)}$$



EIRP (dBm)	Field Strength at 3m (dBµV/m)
- 27	68.3

(3) KDB789033 D02 v02r01 G)2)c)

- (i) Section 15.407(b)(1) to (b)(3) specify the unwanted emission limits for the U-NII-1 and U-NII-2 bands. As specified, emissions above 1000 MHz that are outside of the restricted bands are subject to a peak emission limit of -27 dBm/MHz.<sup>3</sup>
- (ii) Section 15.407(b)(4) specifies the unwanted emission limit for the U-NII-3 band. A band emissions mask is specified in Section 15.407(b)(4)(i). The emission limits are in terms of a Peak detector. An alternative to the band emissions mask is specified in Section 15.407(b)(4)(ii). The alternative limits are based on the highest antenna gain specified in the filing. There are also marketing and importation restrictions for the devices using the alternative limit.<sup>4</sup>

**Note 3:** An out-of-band emission that complies with both the average and peak limits of Section 15.209 is not required to satisfy the -27 dBm/MHz peak emission limit.

**Note 4:** Only devices with antenna gains of 10 dBi or less may be approved using the emission limits specified in Section 15.247(d) till March 2, 2018; all other devices operating in this band must use the mask specified in Section 15.407(b)(4)(i).

### 3.4.2 Measuring Instruments

See list of measuring equipment of this test report.

### 3.4.3 Test Procedures

1. The testing follows FCC KDB 789033 D02 General UNII Test Procedures New Rules v02r01. Section G) Unwanted emissions measurement.
  - (1) Procedure for Unwanted Emissions Measurements Below 1000MHz
    - RBW = 120 kHz
    - VBW = 300 kHz
    - Detector = Peak
    - Trace mode = max hold
  - (2) Procedure for Peak Unwanted Emissions Measurements Above 1000 MHz
    - RBW = 1 MHz
    - VBW ≥ 3 MHz
    - Detector = Peak
    - Sweep time = auto
    - Trace mode = max hold



(3) Procedures for Average Unwanted Emissions Measurements Above 1000MHz

- RBW = 1 MHz
  - VBW = 10 Hz, when duty cycle is no less than 98 percent.
  - $VBW \geq 1/T$ , when duty cycle is less than 98 percent where T is the minimum transmission duration over which the transmitter is on and is transmitting at its maximum power control level for the tested mode of operation.
2. The EUT was placed on a turntable with 0.8 meter for frequency below 1GHz and 1.5 meter for frequency above 1GHz respectively above ground.
  3. The EUT was set 3 meters from the interference receiving antenna which was mounted on the top of a variable height antenna tower.
  4. The antenna is a broadband antenna and its height is adjusted between one meter and four meters above ground to find the maximum value of the field strength for both horizontal polarization and vertical polarization of the antenna.
  5. For each suspected emission, the EUT was arranged to its worst case and then adjust the antenna tower (from 1 m to 4 m) and turntable (from 0 degree to 360 degrees) to find the maximum reading.
  6. For testing below 1GHz, if the emission level of the EUT in peak mode was 3 dB lower than the limit specified, then peak values of EUT will be reported, otherwise, the emissions will be repeated one by one using the CISPR quasi-peak method and reported.
  7. For testing above 1GHz, the emission level of the EUT in peak mode was 20dB lower than average limit (that means the emission level in average mode also complies with the limit in average mode), then peak values of EUT will be reported, otherwise, the emissions will be measured in average mode again and reported.

### 3.4.4 Test Setup

For radiated emissions below 30MHz

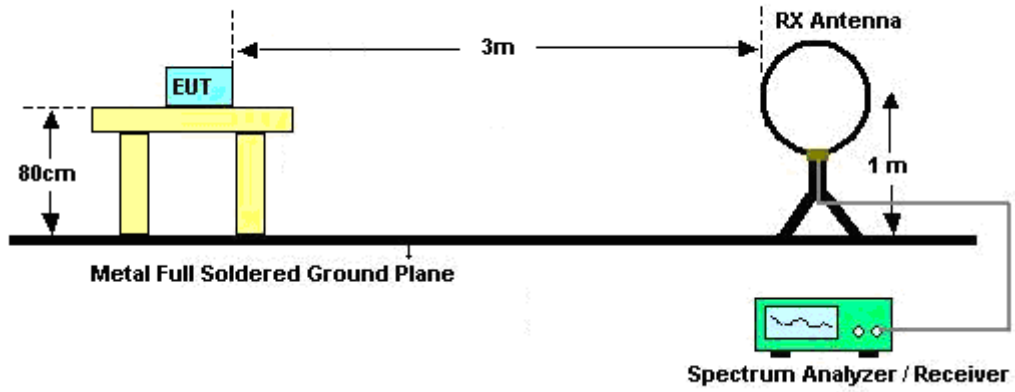

For radiated emissions from 30MHz to 1GHz

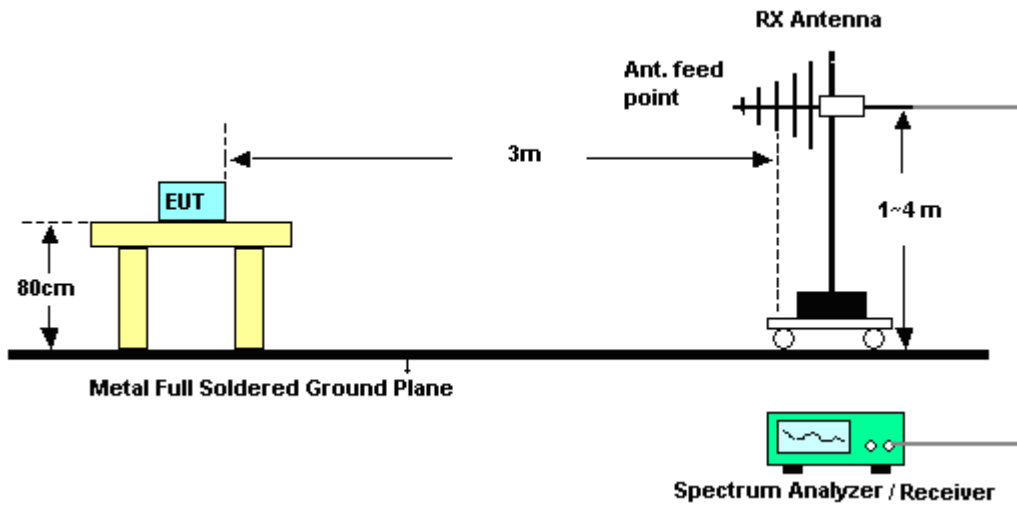

For radiated emissions above 1GHz

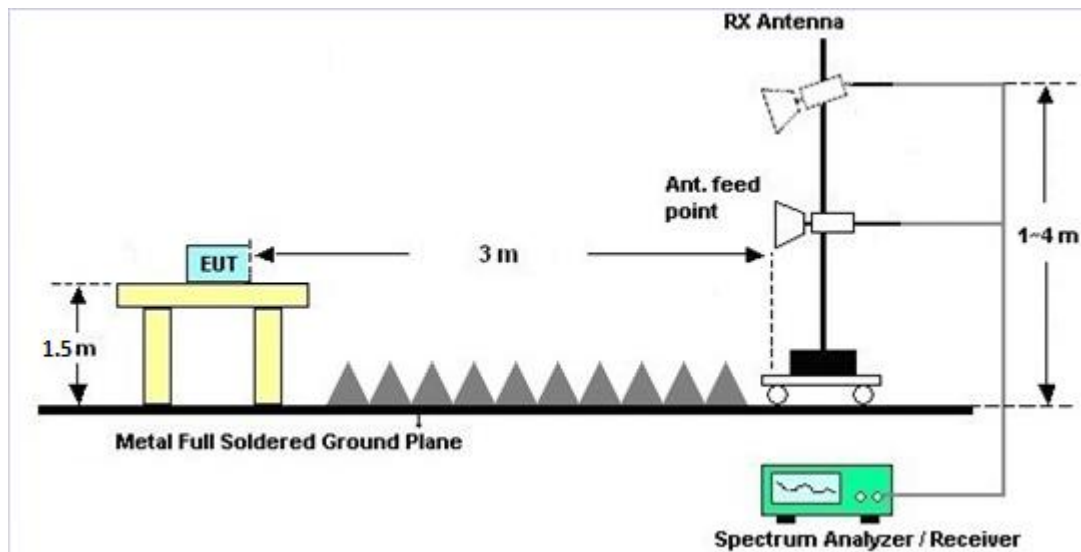

### 3.4.5 Test Results of Radiated Emissions (9 kHz ~ 30 MHz)

The low frequency, which started from 9 kHz to 30MHz, was pre-scanned and the result which was 20dB lower than the limit line was not reported.

There is a comparison data of both open-field test site and alternative test site - semi-Anechoic chamber according to 414788 D01 Radiated Test Site v01r01, and the result came out very similar.

### 3.4.6 Test Result of Radiated Band Edges

Please refer to Appendix C and D.

### 3.4.7 Duty Cycle

Please refer to Appendix E.

### 3.4.8 Test Result of Unwanted Radiated Emission (30MHz ~ 10th Harmonic)

Please refer to Appendix C and D.



### 3.5 AC Conducted Emission Measurement

#### 3.5.1 Limit of AC Conducted Emission

For equipment that is designed to be connected to the public utility (AC) power line, the radio frequency voltage that is conducted back onto the AC power line on any frequency or frequencies within the band 150 kHz to 30 MHz shall not exceed the limits in the following table.

Frequency of emission (MHz)	Conducted limit (dB $\mu$ V)	
	Quasi-peak	Average
0.15-0.5	66 to 56*	56 to 46*
0.5-5	56	46
5-30	60	50

\*Decreases with the logarithm of the frequency.

#### 3.5.2 Measuring Instruments

See list of measuring equipment of this test report.

#### 3.5.3 Test Procedures

1. The EUT was placed 0.4 meter from the conducting wall of the shielding room was kept at least 80 centimeters from any other grounded conducting surface.
2. Connect EUT to the power mains through a line impedance stabilization network (LISN).
3. All the support units are connecting to the other LISN.
4. The LISN provides 50 ohm coupling impedance for the measuring instrument.
5. The FCC states that a 50 ohm, 50 microhenry LISN should be used.
6. Both sides of AC line were checked for maximum conducted interference.
7. The frequency range from 150 kHz to 30 MHz was searched.
8. Set the test-receiver system to Peak Detect Function and specified bandwidth with Maximum Hold Mode.

### 3.5.4 Test Setup

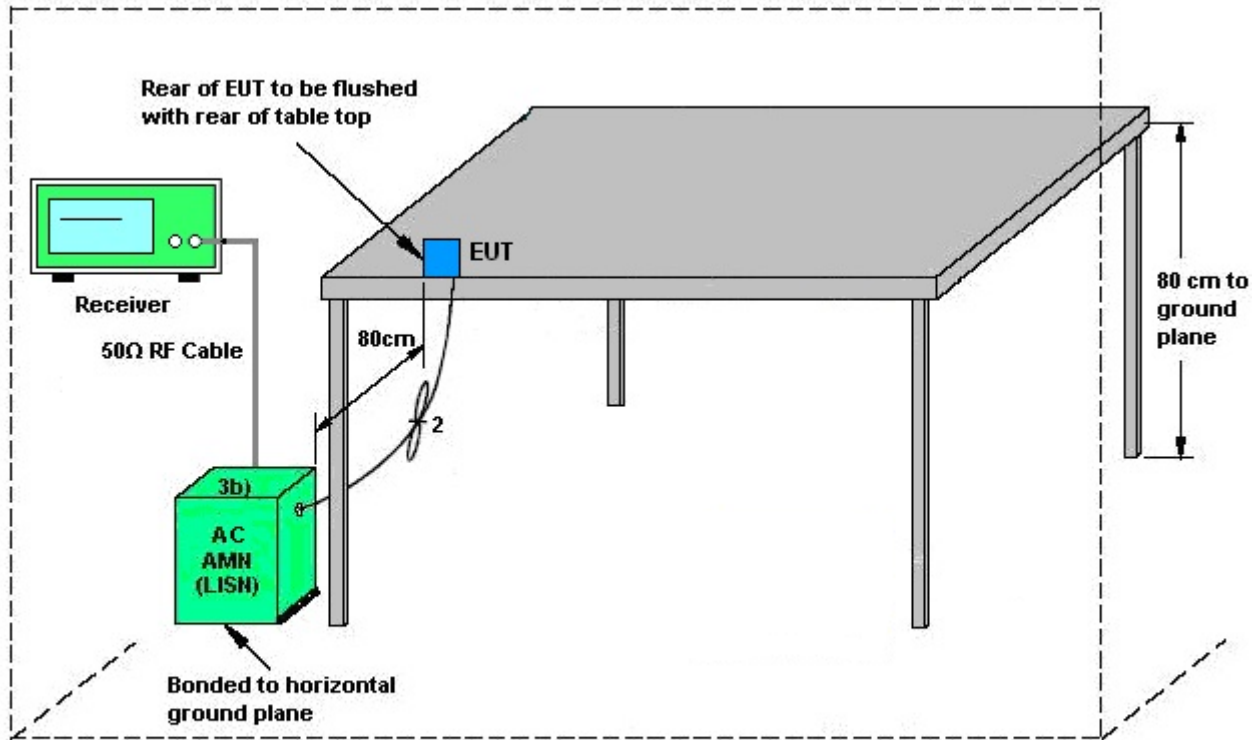

AMN = Artificial mains network (LISN)  
 AE = Associated equipment  
 EUT = Equipment under test  
 ISN = Impedance stabilization network

### 3.5.5 Test Result of AC Conducted Emission

Please refer to Appendix B.



## **3.6 Automatically Discontinue Transmission**

### **3.6.1 Limit of Automatically Discontinue Transmission**

The device shall automatically discontinue transmission in case of either absence of information to transmit or operational failure. These provisions are not intended to preclude the transmission of control or signaling information or the use of repetitive codes used by certain digital technologies to complete frame or burst intervals. Applicants shall include in their application for equipment authorization to describe how this requirement is met.

### **3.6.2 Measuring Instruments**

See list of measuring equipment of this test report.

### **3.6.3 Test Result of Automatically Discontinue Transmission**

While the EUT is not transmitting any information, the EUT can automatically discontinue transmission and become standby mode for power saving. The EUT can detect the controlling signal of ACK message transmitting from remote device and verify whether it shall resend or discontinue transmission.





## **3.7 Antenna Requirements**

### **3.7.1 Standard Applicable**

If transmitting antenna directional gain is greater than 6 dBi, both the peak transmit power and the peak power spectral density shall be reduced by the amount in dB that the directional gain of the antenna exceeds 6 dBi.

### **3.7.2 Antenna Anti-Replacement Construction**

An embedded-in antenna design is used.

### **3.7.3 Antenna Gain**

The antenna peak gain of EUT is less than 6 dBi. Therefore, it is not necessary to reduce maximum peak output power limit.



## 4 List of Measuring Equipment

Instrument	Manufacturer	Model No.	Serial No.	Characteristics	Calibration Date	Test Date	Due Date	Remark
Hygrometer	Testo	608-H1	34893241	N/A	Mar. 06, 2018	Sep. 04, 2018~ Nov. 23, 2018	Mar. 05, 2019	Conducted (TH05-HY)
Power Meter	Anritsu	ML2495A	1132003	N/A	Aug. 16, 2018	Sep. 04, 2018~ Nov. 23, 2018	Aug. 15, 2019	Conducted (TH05-HY)
Power Sensor	Anritsu	MA2411B	1126017	300MHz~40GHz	Aug. 16, 2018	Sep. 04, 2018~ Nov. 23, 2018	Aug. 15, 2019	Conducted (TH05-HY)
Signal Analyzer	Rohde & Schwarz	FSV30	100895	10Hz~30GHz	Apr. 20, 2018	Sep. 04, 2018~ Nov. 23, 2018	Apr. 19, 2019	Conducted (TH05-HY)
Signal Analyzer	Rohde & Schwarz	FSP40	100055	9kHz~40GHz	Jun. 14, 2018	Sep. 04, 2018~ Nov. 23, 2018	Jun. 13, 2019	Conducted (TH05-HY)
Switch Box & RF Cable	Burgeon	ETF-058	EC1300484	N/A	Mar. 01, 2018	Sep. 04, 2018~ Nov. 23, 2018	Feb. 28, 2019	Conducted (TH05-HY)
AC Power Source	ChainTek	APC-1000W	N/A	N/A	N/A	Sep. 10, 2018	N/A	Conduction (CO05-HY)
EMI Test Receiver	Rohde & Schwarz	ESR3	102388	9KHz~3.6GHz	Dec. 08, 2017	Sep. 10, 2018	Dec. 07, 2018	Conduction (CO05-HY)
Hygrometer	Testo	608-H1	34913912	N/A	Mar. 06, 2018	Sep. 10, 2018	Mar. 05, 2019	Conduction (CO05-HY)
LISN	Rohde & Schwarz	ENV216	100080	9kHz~30MHz	Nov. 30, 2017	Sep. 10, 2018	Nov. 29, 2018	Conduction (CO05-HY)
Software	Rohde & Schwarz	EMC32 V10.30	N/A	N/A	N/A	Sep. 10, 2018	N/A	Conduction (CO05-HY)
LF Cable	HUBER + SUHNER	RG-214/U	LF01	N/A	Jan. 03, 2018	Sep. 10, 2018	Jan. 02, 2019	Conduction (CO05-HY)
Pulse Limiter	Rohde & Schwarz	ESH3-Z2	100851	N/A	Jan. 03, 2018	Sep. 10, 2018	Jan. 02, 2019	Conduction (CO05-HY)
Loop Antenna	Rohde & Schwarz	HFH2-Z2	100488	9 kHz~30 MHz	Nov. 23, 2017	Nov. 16, 2018~ Nov. 19, 2018	Nov. 22, 2018	Radiation (03CH07-HY)
Bilog Antenna	TESEQ	CBL 6111D&0080 ON1D01N-06	35419&03	30MHz to 1GHz	Dec. 18, 2017	Nov. 16, 2018~ Nov. 19, 2018	Dec. 17, 2018	Radiation (03CH07-HY)
Horn Antenna	ESCO	3117	00211469	1GHz~18GHz	Aug. 06, 2018	Nov. 16, 2018~ Nov. 19, 2018	Aug. 05, 2019	Radiation (03CH07-HY)
Hygrometer	TECPEL	HTC-2	1	N/A	May 12, 2018	Nov. 16, 2018~ Nov. 19, 2018	May 11, 2019	Radiation (03CH07-HY)
EMI Test Receiver	Agilent	N9038A(MX E)	MY5329005 3	20Hz to 26.5GHz	Jan. 16, 2018	Nov. 16, 2018~ Nov. 19, 2018	Jan. 15, 2019	Radiation (03CH07-HY)
Spectrum Analyzer	Agilent	N9010A	MY5347011 8	10Hz~44GHz	Apr. 17, 2018	Nov. 16, 2018~ Nov. 19, 2018	Apr. 16, 2019	Radiation (03CH07-HY)
Controller	ChainTek	Chaintek 3000	N/A	Control Turn table	N/A	Nov. 16, 2018~ Nov. 19, 2018	N/A	Radiation (03CH07-HY)
Controller	Max-Full	MF7802	MF7802083 68	Control Ant Mast	N/A	Nov. 16, 2018~ Nov. 19, 2018	N/A	Radiation (03CH07-HY)
Antenna Mast	Max-Full	MFA520BS	N/A	1m~4m	N/A	Nov. 16, 2018~ Nov. 19, 2018	N/A	Radiation (03CH07-HY)
Turn Table	ChainTek	Chaintek 3000	N/A	0~360 Degree	N/A	Nov. 16, 2018~ Nov. 19, 2018	N/A	Radiation (03CH07-HY)



Instrument	Manufacturer	Model No.	Serial No.	Characteristics	Calibration Date	Test Date	Due Date	Remark
Amplifier	MITEQ	TTA1840-35-HG	1871923	18GHz~40GHz, VSWR : 2.5:1 max	Jul. 16, 2018	Nov. 16, 2018~ Nov. 19, 2018	Jul. 15, 2019	Radiation (03CH07-HY)
Preamplifier	MITEQ	AMF-7D-001 01800-30-10 P	1590075	1GHz ~ 18GHz	Apr. 25, 2018	Nov. 16, 2018~ Nov. 19, 2018	Apr. 24, 2019	Radiation (03CH07-HY)
Preamplifier	COM-POWER	PA-103A	161241	10MHz-1GHz	May 21, 2018	Nov. 16, 2018~ Nov. 19, 2018	May 20, 2019	Radiation (03CH07-HY)
Preamplifier	Agilent	8449B	3008A02362	1GHz~ 26.5GHz	Nov. 02, 2018	Nov. 16, 2018~ Nov. 19, 2018	Nov. 01, 2019	Radiation (03CH07-HY)
SHF-EHF Horn Antenna	SCHWARZBE CK	BBHA 9170	BBHA91705 76	18GHz ~ 40GHz	May 08, 2018	Nov. 16, 2018~ Nov. 19, 2018	May 07, 2019	Radiation (03CH07-HY)
Software	Audix	E3 6.2009-8-24	N/A	N/A	N/A	Nov. 16, 2018~ Nov. 19, 2018	N/A	Radiation (03CH07-HY)
RF Cable	HUBER + SUHNER	SUCOFLEX 104	MY24971/4, MY28655/4	9KHz~30MHz	Jan. 02, 2018	Nov. 16, 2018~ Nov. 19, 2018	Jan. 01, 2019	Radiation (03CH07-HY)
RF Cable	HUBER + SUHNER	SUCOFLEX 104	MY28655/4, MY24971/4, MY15682/4	30MHz~1GHz	Feb. 27, 2018	Nov. 16, 2018~ Nov. 19, 2018	Feb. 26, 2019	Radiation (03CH07-HY)
RF Cable	HUBER + SUHNER	SUCOFLEX 104	MY28655/4, MY24971/4, MY15682/4	1GHz~18GHz	Feb. 27, 2018	Nov. 16, 2018~ Nov. 19, 2018	Feb. 26, 2019	Radiation (03CH07-HY)
RF Cable	HUBER + SUHNER	SUCOFLEX 104	MY28655/4, MY24971/4, MY15682/4	1GHz~18GHz	Feb. 27, 2018	Nov. 16, 2018~ Nov. 19, 2018	Feb. 26, 2019	Radiation (03CH07-HY)
Filter	Wainwright	WLKS1200- 8SS	SN3	1.2G Low Pass	Nov. 21, 2017	Nov. 16, 2018~ Nov. 19, 2018	Nov. 20, 2018	Radiation (03CH07-HY)
Filter	Microwave	H3G018G1	SN477220	3.0G High Pass	Nov. 21, 2017	Nov. 16, 2018~ Nov. 19, 2018	Nov. 20, 2018	Radiation (03CH07-HY)
Filter	Microwave	WHKX7.0/26 .5G-6SS	SN4	7G High Pass	Nov. 21, 2017	Nov. 16, 2018~ Nov. 19, 2018	Nov. 20, 2018	Radiation (03CH07-HY)



## 5 Uncertainty of Evaluation

### Uncertainty of Conducted Emission Measurement (150kHz ~ 30MHz)

Measuring Uncertainty for a Level of Confidence of 95% ( $U = 2Uc(y)$ )	2.20
---	------

### Uncertainty of Radiated Emission Measurement (30 MHz ~ 1000 MHz)

Measuring Uncertainty for a Level of Confidence of 95% ( $U = 2Uc(y)$ )	5.70
---	------

### Uncertainty of Radiated Emission Measurement (1000 MHz ~ 18000 MHz)

Measuring Uncertainty for a Level of Confidence of 95% ( $U = 2Uc(y)$ )	5.50
---	------

### Uncertainty of Radiated Emission Measurement (18000 MHz ~ 40000 MHz)

Measuring Uncertainty for a Level of Confidence of 95% ( $U = 2Uc(y)$ )	5.20
---	------

**Appendix A. Test Result of Conducted Test Items**

Test Engineer:	Allen Lin / Luffy Lin / Kai Liao/Shiming Liu	Temperature:	21~25	°C
Test Date:	2018/9/4 ~ 2018/11/23	Relative Humidity:	51~54	%

**TEST RESULTS DATA**  
**6dB and 26dB EBW and 99% OBW**

Band IV												
Mod.	Data Rate	NTX	CH.	Freq. (MHz)	99% Bandwidth (MHz)		26dB Bandwidth (MHz)		6 dB Bandwidth (MHz)		6 dB Bandwidth Min. Limit (MHz)	Pass/Fail
					Ant 1	Ant 2	Ant 1	Ant 2	Ant 1	Ant 2		
11a	6Mbps	1	149	5745	16.83	-	25.57	-	15.48	-	0.5	Pass
11a	6Mbps	1	157	5785	16.93	-	26.17	-	15.33	-	0.5	Pass
11a	6Mbps	1	165	5825	16.98	-	26.02	-	15.43	-	0.5	Pass
HT20	MCS0	1	149	5745	17.93	-	25.72	-	15.98	-	0.5	Pass
HT20	MCS0	1	157	5785	17.98	-	25.82	-	15.14	-	0.5	Pass
HT20	MCS0	1	165	5825	17.98	-	25.48	-	15.68	-	0.5	Pass
HT40	MCS0	1	151	5755	36.66	-	42.17	-	35.25	-	0.5	Pass
HT40	MCS0	1	159	5795	36.66	-	42.44	-	35.07	-	0.5	Pass
VHT40	MCS0	1	151	5755	37.06	-	42.44	-	35.60	-	0.5	Pass
VHT40	MCS0	1	159	5795	36.86	-	42.62	-	35.51	-	0.5	Pass
VHT80	MCS0	1	155	5775	76.96	-	84.56	-	75.12	-	0.5	Pass

**TEST RESULTS DATA**  
**Average Power Table**

Band IV														
Mod.	Data Rate	NTX	CH.	Freq. (MHz)	Duty Factor (dB)		Average Conducted Power (dBm)			FCC Conducted Power Limit (dBm)		DG (dBi)		Pass/Fail
					Ant 1	Ant 2	Ant 1	Ant 2	SUM	Ant 1	Ant 2	Ant 1	Ant 2	
11a	6Mbps	1	149	5745	0.23	-	14.98	-		30.00	-	-1.50	-	Pass
11a	6Mbps	1	157	5785	0.23	-	14.95	-		30.00	-	-1.50	-	Pass
11a	6Mbps	1	165	5825	0.23	-	14.78	-		30.00	-	-1.50	-	Pass
HT20	MCS0	1	149	5745	0.24	-	13.68	-		30.00	-	-1.50	-	Pass
HT20	MCS0	1	157	5785	0.24	-	13.66	-		30.00	-	-1.50	-	Pass
HT20	MCS0	1	165	5825	0.24	-	13.83	-		30.00	-	-1.50	-	Pass
HT40	MCS0	1	151	5755	0.50	-	12.78	-		30.00	-	-1.50	-	Pass
HT40	MCS0	1	159	5795	0.50	-	12.76	-		30.00	-	-1.50	-	Pass
VHT20	MCS0	1	149	5745	0.22	-	13.67	-		30.00	-	-1.50	-	Pass
VHT20	MCS0	1	157	5785	0.22	-	13.64	-		30.00	-	-1.50	-	Pass
VHT20	MCS0	1	165	5825	0.22	-	13.80	-		30.00	-	-1.50	-	Pass
VHT40	MCS0	1	151	5755	0.45	-	12.76	-		30.00	-	-1.50	-	Pass
VHT40	MCS0	1	159	5795	0.45	-	12.72	-		30.00	-	-1.50	-	Pass
VHT80	MCS0	1	155	5775	0.52	-	11.59	-		30.00	-	-1.50	-	Pass

**TEST RESULTS DATA**  
**Power Spectral Density**

Band IV																
Mod.	Data Rate	NTX	CH.	Freq. (MHz)	Duty Factor (dB)		10log (500kHz /RBW) Factor (dB)		Average Power Density (dBm/500kHz)			Average PSD Limit (dBm/500kHz)		DG (dBi)		Pass /Fail
					Ant 1	Ant 2	Ant 1	Ant 2	Ant 1	Ant 2	SUM	Ant 1	Ant 2	Ant 1	Ant 2	
11a	6Mbps	1	149	5745	0.23	-	2.22	-	1.20	-		30.00	-	-1.50	-	Pass
11a	6Mbps	1	157	5785	0.23	-	2.22	-	1.09	-		30.00	-	-1.50	-	Pass
11a	6Mbps	1	165	5825	0.23	-	2.22	-	0.71	-		30.00	-	-1.50	-	Pass
HT20	MCS0	1	149	5745	0.24	-	2.22	-	-3.91	-		30.00	-	-1.50	-	Pass
HT20	MCS0	1	157	5785	0.24	-	2.22	-	-3.93	-		30.00	-	-1.50	-	Pass
HT20	MCS0	1	165	5825	0.24	-	2.22	-	-4.10	-		30.00	-	-1.50	-	Pass
HT40	MCS0	1	151	5755	0.50	-	2.22	-	-8.06	-		30.00	-	-1.50	-	Pass
HT40	MCS0	1	159	5795	0.50	-	2.22	-	-7.79	-		30.00	-	-1.50	-	Pass
VHT40	MCS0	1	151	5755	0.45	-	2.22	-	-7.45	-		30.00	-	-1.50	-	Pass
VHT40	MCS0	1	159	5795	0.45	-	2.22	-	-7.64	-		30.00	-	-1.50	-	Pass
VHT80	MCS0	1	155	5775	0.52	-	2.22	-	-10.89	-		30.00	-	-1.50	-	Pass

Note: PSD Sum = Max PSD(Ant. 1, Ant. 2) + 10 log (n)





## Appendix B. AC Conducted Emission Test Results

Test Engineer :	Jimmy Chang	Temperature :	22~23°C
		Relative Humidity :	58~60%

# EUT Information

Report NO : 881333-01  
 Test Mode : Mode 1  
 Test Voltage : 120Vac/60Hz  
 Phase : Line

Full Spectrum

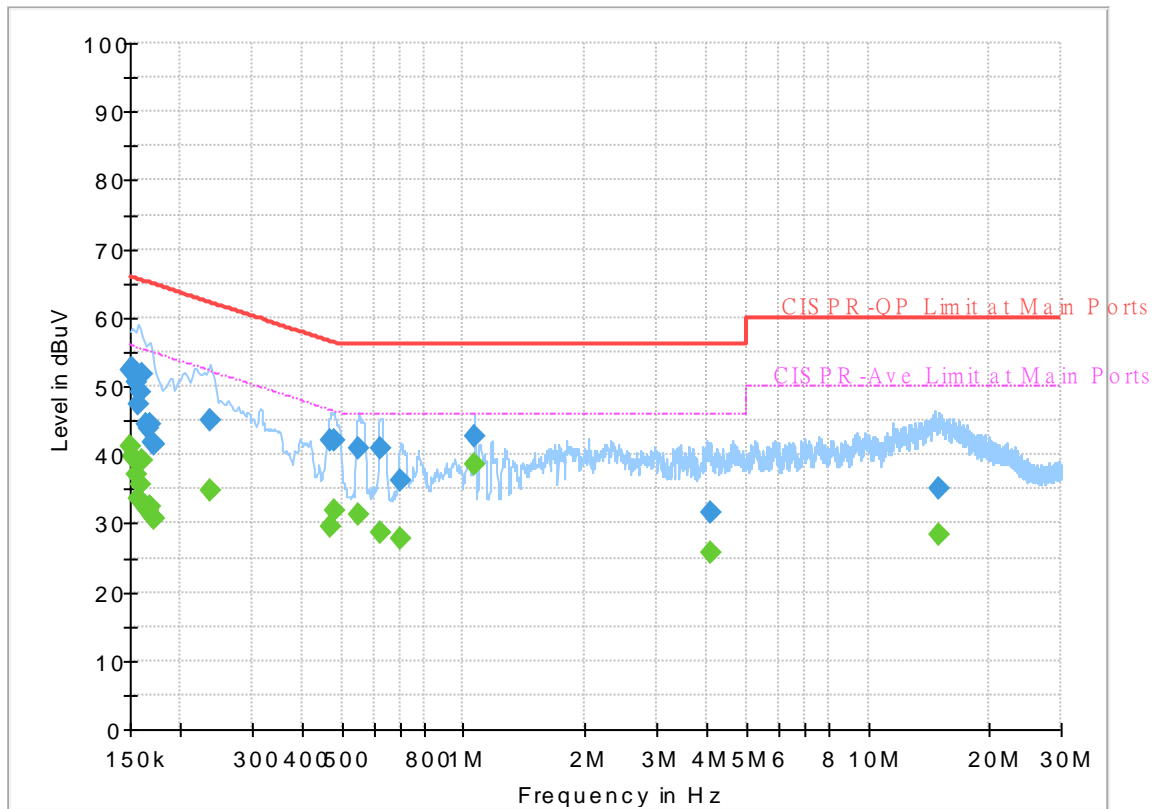

## Final\_Result

Frequency (MHz)	QuasiPeak (dBuV)	CAverage (dBuV)	Limit (dBuV)	Margin (dB)	Line	Filter	Corr. (dB)
0.150000	---	41.19	56.00	14.81	L1	OFF	19.5
0.150000	52.45	---	66.00	13.55	L1	OFF	19.5
0.152250	---	39.65	55.88	16.23	L1	OFF	19.5
0.152250	52.70	---	65.88	13.18	L1	OFF	19.5
0.154500	---	37.21	55.75	18.54	L1	OFF	19.5
0.154500	50.65	---	65.75	15.10	L1	OFF	19.5
0.156750	---	33.69	55.63	21.94	L1	OFF	19.5
0.156750	47.46	---	65.63	18.17	L1	OFF	19.5
0.159000	---	35.53	55.52	19.99	L1	OFF	19.5
0.159000	49.08	---	65.52	16.44	L1	OFF	19.5
0.161250	---	39.09	55.40	16.31	L1	OFF	19.5
0.161250	51.79	---	65.40	13.61	L1	OFF	19.5
0.163500	---	32.30	55.28	22.98	L1	OFF	19.5
0.163500	44.35	---	65.28	20.93	L1	OFF	19.5
0.165750	---	31.96	55.17	23.21	L1	OFF	19.5
0.165750	43.77	---	65.17	21.40	L1	OFF	19.5
0.168000	---	32.58	55.06	22.48	L1	OFF	19.5
0.168000	44.40	---	65.06	20.66	L1	OFF	19.5
0.170250	---	31.08	54.95	23.87	L1	OFF	19.5
0.170250	41.93	---	64.95	23.02	L1	OFF	19.5
0.172500	---	30.84	54.84	24.00	L1	OFF	19.5

0.172500	41.54	---	64.84	23.30	L1	OFF	19.5
0.237750	---	34.71	52.17	17.46	L1	OFF	19.5
0.237750	44.95	---	62.17	17.22	L1	OFF	19.5
0.469500	---	29.48	46.52	17.04	L1	OFF	19.5
0.469500	41.98	---	56.52	14.54	L1	OFF	19.5
0.478500	---	31.76	46.37	14.61	L1	OFF	19.5
0.478500	42.02	---	56.37	14.35	L1	OFF	19.5
0.552750	---	31.39	46.00	14.61	L1	OFF	19.5
0.552750	40.99	---	56.00	15.01	L1	OFF	19.5
0.620250	---	28.64	46.00	17.36	L1	OFF	19.6
0.620250	40.91	---	56.00	15.09	L1	OFF	19.6
0.701250	---	27.73	46.00	18.27	L1	OFF	19.6
0.701250	36.15	---	56.00	19.85	L1	OFF	19.6
1.065750	---	38.53	46.00	7.47	L1	OFF	19.6
1.065750	42.70	---	56.00	13.30	L1	OFF	19.6
4.074000	---	25.66	46.00	20.34	L1	OFF	19.7
4.074000	31.72	---	56.00	24.28	L1	OFF	19.7
15.022500	---	28.41	50.00	21.59	L1	OFF	20.1
15.022500	35.01	---	60.00	24.99	L1	OFF	20.1

# EUT Information

Report NO : 881333-01  
 Test Mode : Mode 1  
 Test Voltage : 120Vac/60Hz  
 Phase : Neutral

Full Spectrum

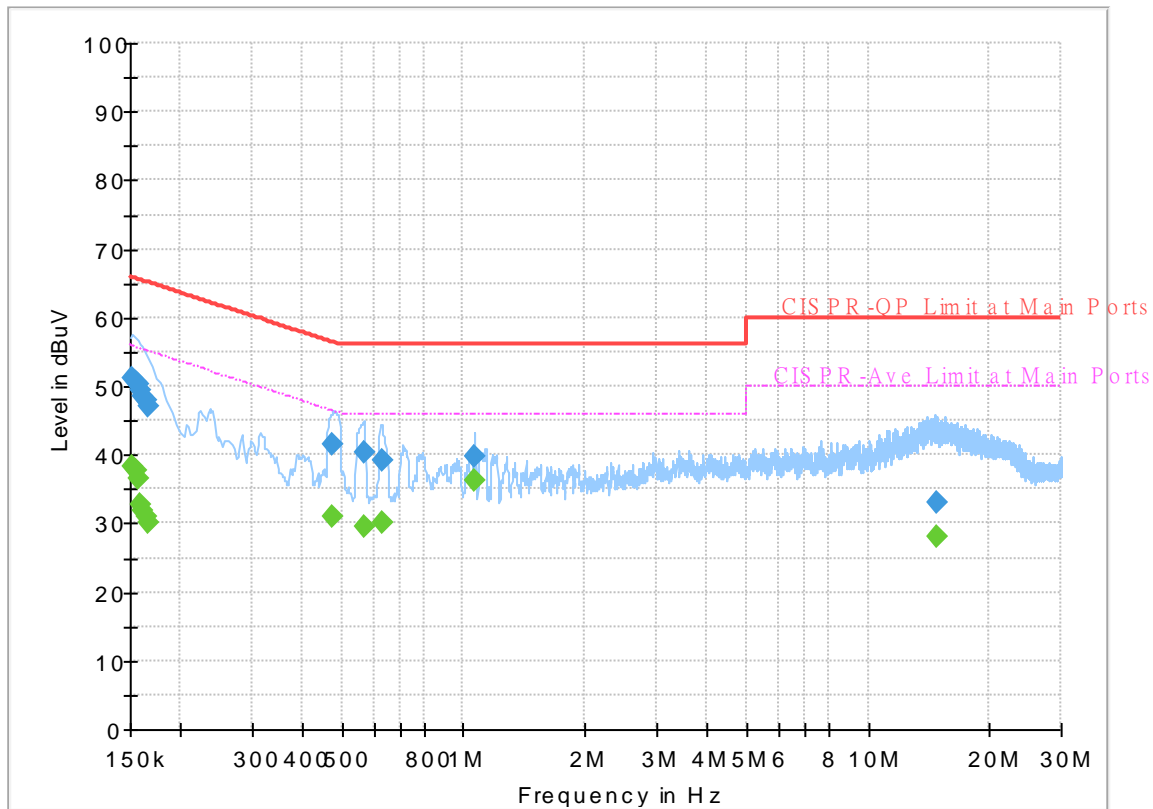

## Final\_Result

Frequency (MHz)	QuasiPeak (dBuV)	CAverage (dBuV)	Limit (dBuV)	Margin (dB)	Line	Filter	Corr. (dB)
0.152250	---	38.18	55.88	17.70	N	OFF	19.5
0.152250	51.30	---	65.88	14.58	N	OFF	19.5
0.154500	---	37.71	55.75	18.04	N	OFF	19.5
0.154500	50.69	---	65.75	15.06	N	OFF	19.5
0.156750	---	36.68	55.63	18.95	N	OFF	19.5
0.156750	50.18	---	65.63	15.45	N	OFF	19.5
0.159000	---	32.75	55.52	22.77	N	OFF	19.5
0.159000	49.37	---	65.52	16.15	N	OFF	19.5
0.161250	---	32.00	55.40	23.40	N	OFF	19.5
0.161250	48.66	---	65.40	16.74	N	OFF	19.5
0.163500	---	31.01	55.28	24.27	N	OFF	19.5
0.163500	47.93	---	65.28	17.35	N	OFF	19.5
0.165750	---	30.26	55.17	24.91	N	OFF	19.5
0.165750	47.05	---	65.17	18.12	N	OFF	19.5
0.474000	---	30.87	46.44	15.57	N	OFF	19.5
0.474000	41.49	---	56.44	14.95	N	OFF	19.5
0.566250	---	29.44	46.00	16.56	N	OFF	19.5
0.566250	40.44	---	56.00	15.56	N	OFF	19.5
0.629250	---	29.98	46.00	16.02	N	OFF	19.6
0.629250	39.05	---	56.00	16.95	N	OFF	19.6
1.065750	---	36.40	46.00	9.60	N	OFF	19.6

<b>1.065750</b>	<b>39.68</b>	<b>---</b>	<b>56.00</b>	<b>16.32</b>	<b>N</b>	<b>OFF</b>	<b>19.6</b>
<b>14.804250</b>	<b>---</b>	<b>28.17</b>	<b>50.00</b>	<b>21.83</b>	<b>N</b>	<b>OFF</b>	<b>20.1</b>
<b>14.804250</b>	<b>33.12</b>	<b>---</b>	<b>60.00</b>	<b>26.88</b>	<b>N</b>	<b>OFF</b>	<b>20.1</b>



### Appendix C. Radiated Spurious Emission

Test Engineer :	Jesse Wang, Stan Hsieh, Nick Yu, and Troye	Temperature :	24~26°C
	Hsieh	Relative Humidity :	54~56%

Band 4 - 5725~5850MHz

WIFI 802.11a (Band Edge @ 3m)

WIFI	Note	Frequency	Level	Over	Limit	Read	Antenna	Path	Preamp	Ant	Table	Peak	Pol.	
Ant.				Limit	Line	Level	Factor	Loss	Factor	Pos	Pos	Avg.		
1		( MHz )	( dBµV/m )	( dB )	( dBµV/m )	( dBµV )	( dB/m )	( dB )	( dB )	( cm )	( deg )	( P/A )	( H/V )	
802.11a CH 149 5745MHz		5612.8	50.15	-18.05	68.2	39.33	34.5	11.4	35.08	100	326	P	H	
		5686.2	51.39	-43.63	95.02	40.52	34.5	11.46	35.09	100	326	P	H	
		5717.4	57.84	-52.23	110.07	46.91	34.53	11.5	35.1	100	326	P	H	
		5724.6	66.09	-55.2	121.29	55.12	34.57	11.5	35.1	100	326	P	H	
	*	5745	108.44	-	-	97.41	34.6	11.53	35.1	100	326	P	H	
	*	5745	101.03	-	-	90	34.6	11.53	35.1	100	326	A	H	
														H
														H
			5640.8	50.09	-18.11	68.2	39.24	34.5	11.43	35.08	338	330	P	V
			5694.6	50.1	-51.12	101.22	39.23	34.5	11.46	35.09	338	330	P	V
			5715.6	53.09	-56.48	109.57	42.16	34.53	11.5	35.1	338	330	P	V
			5723.8	61.22	-58.24	119.46	50.25	34.57	11.5	35.1	338	330	P	V
	*		5745	104.31	-	-	93.28	34.6	11.53	35.1	338	330	P	V
	*		5745	96.67	-	-	85.64	34.6	11.53	35.1	338	330	A	V
													V	
													V	



WIFI Ant. 1	Note	Frequency ( MHz )	Level ( dBμV/m )	Over Limit ( dB )	Limit Line ( dBμV/m )	Read Level ( dBμV )	Antenna Factor ( dB/m )	Path Loss ( dB )	Preamp Factor ( dB )	Ant Pos ( cm )	Table Pos ( deg )	Peak Avg. ( P/A )	Pol. ( H/V )
		5638.8	50.29	-17.91	68.2	39.44	34.5	11.43	35.08	100	325	P	H
		5687.4	50.3	-45.61	95.91	39.43	34.5	11.46	35.09	100	325	P	H
		5712.2	51.67	-56.95	108.62	40.74	34.53	11.5	35.1	100	325	P	H
		5723	50.84	-66.8	117.64	39.87	34.57	11.5	35.1	100	325	P	H
	*	5785	108.15	-	-	96.97	34.73	11.56	35.11	100	325	P	H
	*	5785	100.63	-	-	89.45	34.73	11.56	35.11	100	325	A	H
		5851.2	48.65	-70.81	119.46	37.37	34.8	11.6	35.12	100	325	P	H
		5864.6	48.59	-59.52	108.11	37.26	34.8	11.65	35.12	100	325	P	H
		5906	48.71	-33.51	82.22	37.31	34.83	11.69	35.12	100	325	P	H
		5925.8	48.68	-19.52	68.2	37.25	34.87	11.69	35.13	100	325	P	H
													H
													H
802.11a													
CH 157													
5785MHz		5620.6	49.92	-18.28	68.2	39.07	34.5	11.43	35.08	327	329	P	V
		5658.2	50.34	-23.95	74.29	39.5	34.5	11.43	35.09	327	329	P	V
		5710.4	50.08	-58.03	108.11	39.15	34.53	11.5	35.1	327	329	P	V
		5721.4	49.8	-64.19	113.99	38.83	34.57	11.5	35.1	327	329	P	V
	*	5785	104.18	-	-	93	34.73	11.56	35.11	327	329	P	V
	*	5785	96.89	-	-	85.71	34.73	11.56	35.11	327	329	A	V
		5850.01	48.15	-74.03	122.18	36.87	34.8	11.6	35.12	327	329	P	V
		5870.6	48.56	-57.87	106.43	37.23	34.8	11.65	35.12	327	329	P	V
		5880	48.93	-52.56	101.49	37.6	34.8	11.65	35.12	327	329	P	V
		5939.8	48.36	-19.84	68.2	36.9	34.9	11.69	35.13	327	329	P	V
													V
													V



WIFI Ant. 1	Note	Frequency ( MHz )	Level ( dBμV/m )	Over Limit ( dB )	Limit Line ( dBμV/m )	Read Level ( dBμV )	Antenna Factor ( dB/m )	Path Loss ( dB )	Preamp Factor ( dB )	Ant Pos ( cm )	Table Pos ( deg )	Peak Avg. ( P/A )	Pol. ( H/V )	
802.11a CH 165 5825MHz	*	5825	107.53	-	-	96.24	34.8	11.6	35.11	104	327	P	H	
	*	5825	100.02	-	-	88.73	34.8	11.6	35.11	104	327	A	H	
		5850.2	53.09	-68.65	121.74	41.81	34.8	11.6	35.12	104	327	P	H	
		5858	50.96	-59	109.96	39.68	34.8	11.6	35.12	104	327	P	H	
		5903	49.29	-35.15	84.44	37.92	34.8	11.69	35.12	104	327	P	H	
		5942.2	49.73	-18.47	68.2	38.22	34.9	11.74	35.13	104	327	P	H	
														H
														H
	*	5825	103.79	-	-	92.5	34.8	11.6	35.11	326	330	P	V	
	*	5825	96.17	-	-	84.88	34.8	11.6	35.11	326	330	A	V	
		5850.8	50.07	-70.31	120.38	38.79	34.8	11.6	35.12	326	330	P	V	
		5857.6	49.66	-60.41	110.07	38.38	34.8	11.6	35.12	326	330	P	V	
		5882.6	48.89	-50.67	99.56	37.56	34.8	11.65	35.12	326	330	P	V	
		5930	48.67	-19.53	68.2	37.24	34.87	11.69	35.13	326	330	P	V	
														V
														V
													V	
<b>Remark</b>	1. No other spurious found. 2. All results are PASS against Peak and Average limit line.													





**Band 4 5725~5850MHz**

**WIFI 802.11a (Harmonic @ 3m)**

WIFI Ant. 1	Note	Frequency ( MHz )	Level ( dBμV/m )	Over Limit ( dB )	Limit Line ( dBμV/m )	Read Level ( dBμV )	Antenna Factor ( dB/m )	Path Loss ( dB )	Preamp Factor ( dB )	Ant Pos ( cm )	Table Pos ( deg )	Peak Avg. ( P/A )	Pol. ( H/V )
802.11a CH 149 5745MHz		11490	48.58	-25.42	74	49.5	37.98	18.44	57.34	100	0	P	H
		17235	51.03	-17.17	68.2	43.98	41	21.8	55.75	100	0	P	H
													H
													H
		11490	48.86	-25.14	74	49.78	37.98	18.44	57.34	100	0	P	V
		17235	51.41	-16.79	68.2	44.36	41	21.8	55.75	100	0	P	V
													V
													V
802.11a CH 157 5785MHz		11570	47.01	-26.99	74	47.6	38.07	18.54	57.2	100	0	P	H
		17355	53.08	-15.12	68.2	46	40.9	21.91	55.73	100	0	P	H
													H
													H
		11570	46.9	-27.1	74	47.49	38.07	18.54	57.2	100	0	P	V
		17355	52.13	-16.07	68.2	45.05	40.9	21.91	55.73	100	0	P	V
													V
													V
802.11a CH 165 5825MHz		11650	47.76	-26.24	74	48.05	38.18	18.64	57.11	100	0	P	H
		17475	51.93	-16.27	68.2	44.96	40.67	22.01	55.71	100	0	P	H
													H
													H
		11650	47.78	-26.22	74	48.07	38.18	18.64	57.11	100	0	P	V
		17475	51.5	-16.7	68.2	44.53	40.67	22.01	55.71	100	0	P	V
													V
													V
Remark	1. No other spurious found. 2. All results are PASS against Peak and Average limit line.												



**Band 4 5725~5850MHz**

**WIFI 802.11n HT20 (Band Edge @ 3m)**

WIFI Ant. 1	Note	Frequency ( MHz )	Level ( dBμV/m )	Over Limit ( dB )	Limit Line ( dBμV/m )	Read Level ( dBμV )	Antenna Factor ( dB/m )	Path Loss ( dB )	Preamp Factor ( dB )	Ant Pos ( cm )	Table Pos ( deg )	Peak Avg. ( P/A )	Pol. ( H/V )	
802.11n HT20 CH 149 5745MHz		5635.4	50.39	-17.81	68.2	39.54	34.5	11.43	35.08	100	324	P	H	
		5682.8	51.99	-40.52	92.51	41.12	34.5	11.46	35.09	100	324	P	H	
		5720	53.55	-57.25	110.8	42.58	34.57	11.5	35.1	100	324	P	H	
		5724.6	60.15	-61.14	121.29	49.18	34.57	11.5	35.1	100	324	P	H	
	*	5745	105.41	-	-	94.38	34.6	11.53	35.1	100	324	P	H	
	*	5745	97.4	-	-	86.37	34.6	11.53	35.1	100	324	A	H	
														H
														H
			5629	50.17	-18.03	68.2	39.32	34.5	11.43	35.08	338	328	P	V
			5677.4	50.15	-38.37	88.52	39.28	34.5	11.46	35.09	338	328	P	V
			5716.2	50.48	-59.26	109.74	39.55	34.53	11.5	35.1	338	328	P	V
			5723.8	54.4	-65.06	119.46	43.43	34.57	11.5	35.1	338	328	P	V
	*		5745	101.12	-	-	90.09	34.6	11.53	35.1	338	328	P	V
	*		5745	93.47	-	-	82.44	34.6	11.53	35.1	338	328	A	V
													V	
													V	



WIFI Ant. 1	Note	Frequency ( MHz )	Level ( dBµV/m )	Over Limit ( dB )	Limit Line ( dBµV/m )	Read Level ( dBµV )	Antenna Factor ( dB/m )	Path Loss ( dB )	Preamp Factor ( dB )	Ant Pos ( cm )	Table Pos ( deg )	Peak Avg. (P/A)	Pol. (H/V)
		5612.6	49.96	-18.24	68.2	39.14	34.5	11.4	35.08	100	327	P	H
		5682.6	50.12	-42.24	92.36	39.25	34.5	11.46	35.09	100	327	P	H
		5713.8	49.98	-59.09	109.07	39.05	34.53	11.5	35.1	100	327	P	H
		5722.4	50.4	-65.87	116.27	39.43	34.57	11.5	35.1	100	327	P	H
	*	5785	104.77	-	-	93.59	34.73	11.56	35.11	100	327	P	H
	*	5785	97.22	-	-	86.04	34.73	11.56	35.11	100	327	A	H
		5850.4	49.39	-71.9	121.29	38.11	34.8	11.6	35.12	100	327	P	H
		5865.4	49.95	-57.94	107.89	38.62	34.8	11.65	35.12	100	327	P	H
		5900.2	48.47	-38.04	86.51	37.1	34.8	11.69	35.12	100	327	P	H
		5925.8	48.51	-19.69	68.2	37.08	34.87	11.69	35.13	100	327	P	H
802.11n													H
HT20													H
CH 157		5609.4	50.39	-17.81	68.2	39.57	34.5	11.4	35.08	327	330	P	V
5785MHz		5680	50.94	-39.5	90.44	40.07	34.5	11.46	35.09	327	330	P	V
		5706.6	49.68	-57.37	107.05	38.75	34.53	11.5	35.1	327	330	P	V
		5721	49.05	-64.03	113.08	38.08	34.57	11.5	35.1	327	330	P	V
	*	5785	101.06	-	-	89.88	34.73	11.56	35.11	327	330	P	V
	*	5785	93.45	-	-	82.27	34.73	11.56	35.11	327	330	A	V
		5854.8	48.89	-62.37	111.26	37.61	34.8	11.6	35.12	327	330	P	V
		5864.8	49.83	-58.22	108.05	38.5	34.8	11.65	35.12	327	330	P	V
		5879.6	49.44	-52.34	101.78	38.11	34.8	11.65	35.12	327	330	P	V
		5936.4	48.17	-20.03	68.2	36.74	34.87	11.69	35.13	327	330	P	V
													V
													V



WIFI Ant. 1	Note	Frequency ( MHz )	Level ( dBμV/m )	Over Limit ( dB )	Limit Line ( dBμV/m )	Read Level ( dBμV )	Antenna Factor ( dB/m )	Path Loss ( dB )	Preamp Factor ( dB )	Ant Pos ( cm )	Table Pos ( deg )	Peak Avg. ( P/A )	Pol. ( H/V )	
802.11n HT20 CH 165 5825MHz	*	5825	104.6	-	-	93.31	34.8	11.6	35.11	114	327	P	H	
	*	5825	96.5	-	-	85.21	34.8	11.6	35.11	114	327	A	H	
		5850.2	51.73	-70.01	121.74	40.45	34.8	11.6	35.12	114	327	P	H	
		5858	50.81	-59.15	109.96	39.53	34.8	11.6	35.12	114	327	P	H	
		5878.4	49.29	-53.38	102.67	37.96	34.8	11.65	35.12	114	327	P	H	
		5947	48.2	-20	68.2	36.69	34.9	11.74	35.13	114	327	P	H	
														H
														H
	*	5825	100.35	-	-	89.06	34.8	11.6	35.11	328	329	P	V	
	*	5825	92.62	-	-	81.33	34.8	11.6	35.11	328	329	A	V	
		5853.6	49.7	-64.29	113.99	38.42	34.8	11.6	35.12	328	329	P	V	
		5866.4	50.51	-57.1	107.61	39.18	34.8	11.65	35.12	328	329	P	V	
		5887.4	48.79	-47.2	95.99	37.46	34.8	11.65	35.12	328	329	P	V	
		5937.8	48.43	-19.77	68.2	37	34.87	11.69	35.13	328	329	P	V	
														V
														V
<b>Remark</b>	1. No other spurious found. 2. All results are PASS against Peak and Average limit line.													



**Band 4 5725~5850MHz**

**WIFI 802.11n HT20 (Harmonic @ 3m)**

WIFI Ant. 1	Note	Frequency ( MHz )	Level ( dBμV/m )	Over Limit ( dB )	Limit Line ( dBμV/m )	Read Level ( dBμV )	Antenna Factor ( dB/m )	Path Loss ( dB )	Preamp Factor ( dB )	Ant Pos ( cm )	Table Pos ( deg )	Peak Avg. ( P/A )	Pol. ( H/V )
802.11n HT20 CH 149 5745MHz		11490	47.77	-26.23	74	48.69	37.98	18.44	57.34	100	0	P	H
		17235	51.03	-17.17	68.2	43.98	41	21.8	55.75	100	0	P	H
													H
													H
		11490	48.16	-25.84	74	49.08	37.98	18.44	57.34	100	0	P	V
		17235	50.67	-17.53	68.2	43.62	41	21.8	55.75	100	0	P	V
													V
													V
802.11n HT20 CH 157 5785MHz		11570	47.7	-26.3	74	48.29	38.07	18.54	57.2	100	0	P	H
		17355	52.55	-15.65	68.2	45.47	40.9	21.91	55.73	100	0	P	H
													H
													H
		11570	47.92	-26.08	74	48.51	38.07	18.54	57.2	100	0	P	V
		17355	53.19	-15.01	68.2	46.11	40.9	21.91	55.73	100	0	P	V
													V
													V
802.11n HT20 CH 165 5825MHz		11650	47.99	-26.01	74	48.28	38.18	18.64	57.11	100	0	P	H
		17475	52.38	-15.82	68.2	45.41	40.67	22.01	55.71	100	0	P	H
													H
													H
		11650	48.82	-25.18	74	49.11	38.18	18.64	57.11	100	0	P	V
		17475	52.97	-15.23	68.2	46	40.67	22.01	55.71	100	0	P	V
													V
													V
Remark	1. No other spurious found. 2. All results are PASS against Peak and Average limit line.												



Band 4 5725~5850MHz

WIFI 802.11ac VHT40 (Band Edge @ 3m)

WIFI Ant. 1	Note	Frequency ( MHz )	Level ( dBμV/m )	Over Limit ( dB )	Limit Line ( dBμV/m )	Read Level ( dBμV )	Antenna Factor ( dB/m )	Path Loss ( dB )	Preamp Factor ( dB )	Ant Pos ( cm )	Table Pos ( deg )	Peak Avg. ( P/A )	Pol. ( H/V )
		5622	50.51	-17.69	68.2	39.66	34.5	11.43	35.08	100	326	P	H
		5696.8	51.53	-51.31	102.84	40.66	34.5	11.46	35.09	100	326	P	H
		5717.2	57.44	-52.58	110.02	46.51	34.53	11.5	35.1	100	326	P	H
		5724.6	58.99	-62.3	121.29	48.02	34.57	11.5	35.1	100	326	P	H
	*	5755	101.55	-	-	90.45	34.67	11.53	35.1	100	326	P	H
	*	5755	93.83	-	-	82.73	34.67	11.53	35.1	100	326	A	H
		5852.2	48.04	-69.14	117.18	36.76	34.8	11.6	35.12	100	326	P	H
		5867.2	49.41	-57.97	107.38	38.08	34.8	11.65	35.12	100	326	P	H
		5912.8	48.79	-28.41	77.2	37.4	34.83	11.69	35.13	100	326	P	H
		5929	49.14	-19.06	68.2	37.71	34.87	11.69	35.13	100	326	P	H
													H
													H
<b>802.11ac</b>													
<b>VHT40</b>													
<b>CH 151</b>		5600.4	49.97	-18.23	68.2	39.15	34.5	11.4	35.08	335	330	P	V
<b>5755MHz</b>		5691.2	50.81	-47.9	98.71	39.94	34.5	11.46	35.09	335	330	P	V
		5718.4	54.43	-55.92	110.35	43.46	34.57	11.5	35.1	335	330	P	V
		5723.2	55.45	-62.65	118.1	44.48	34.57	11.5	35.1	335	330	P	V
	*	5755	96.9	-	-	85.8	34.67	11.53	35.1	335	330	P	V
	*	5755	89.48	-	-	78.38	34.67	11.53	35.1	335	330	A	V
		5851.6	48.19	-70.36	118.55	36.91	34.8	11.6	35.12	335	330	P	V
		5855.6	48.96	-61.67	110.63	37.68	34.8	11.6	35.12	335	330	P	V
		5876.6	49.16	-54.85	104.01	37.83	34.8	11.65	35.12	335	330	P	V
		5937.2	48.83	-19.37	68.2	37.4	34.87	11.69	35.13	335	330	P	V
													V
													V



WIFI Ant. 1	Note	Frequency ( MHz )	Level ( dBμV/m )	Over Limit ( dB )	Limit Line ( dBμV/m )	Read Level ( dBμV )	Antenna Factor ( dB/m )	Path Loss ( dB )	Preamp Factor ( dB )	Ant Pos ( cm )	Table Pos ( deg )	Peak Avg. ( P/A )	Pol. ( H/V )
		5624.6	49.93	-18.27	68.2	39.08	34.5	11.43	35.08	100	325	P	H
		5696.4	51.26	-51.29	102.55	40.39	34.5	11.46	35.09	100	325	P	H
		5718.6	51.81	-58.6	110.41	40.84	34.57	11.5	35.1	100	325	P	H
		5722.2	50.75	-65.07	115.82	39.78	34.57	11.5	35.1	100	325	P	H
	*	5795	101.04	-	-	89.79	34.8	11.56	35.11	100	325	P	H
	*	5795	93.28	-	-	82.03	34.8	11.56	35.11	100	325	A	H
		5852.2	49.63	-67.55	117.18	38.35	34.8	11.6	35.12	100	325	P	H
		5860.2	49.99	-59.35	109.34	38.66	34.8	11.65	35.12	100	325	P	H
		5876.6	49.16	-54.85	104.01	37.83	34.8	11.65	35.12	100	325	P	H
		5936	49.24	-18.96	68.2	37.81	34.87	11.69	35.13	100	325	P	H
802.11ac													H
VHT40													H
CH 159		5631	49.23	-18.97	68.2	38.38	34.5	11.43	35.08	326	330	P	V
5795MHz		5652.6	49.99	-20.14	70.13	39.14	34.5	11.43	35.08	326	330	P	V
		5708	50.04	-57.4	107.44	39.11	34.53	11.5	35.1	326	330	P	V
		5722.6	49.31	-67.42	116.73	38.34	34.57	11.5	35.1	326	330	P	V
	*	5795	96.62	-	-	85.37	34.8	11.56	35.11	326	330	P	V
	*	5795	89.26	-	-	78.01	34.8	11.56	35.11	326	330	A	V
		5850.4	48.76	-72.53	121.29	37.48	34.8	11.6	35.12	326	330	P	V
		5868.6	49.6	-57.39	106.99	38.27	34.8	11.65	35.12	326	330	P	V
		5916.8	49.05	-25.2	74.25	37.66	34.83	11.69	35.13	326	330	P	V
		5925.6	49.38	-18.82	68.2	37.95	34.87	11.69	35.13	326	330	P	V
													V
													V
Remark	1. No other spurious found. 2. All results are PASS against Peak and Average limit line.												



**Band 4 5725~5850MHz**

**WIFI 802.11ac VHT40 (Harmonic @ 3m)**

WIFI Ant. 1	Note	Frequency ( MHz )	Level ( dBμV/m )	Over Limit ( dB )	Limit Line ( dBμV/m )	Read Level ( dBμV )	Antenna Factor ( dB/m )	Path Loss ( dB )	Preamp Factor ( dB )	Ant Pos ( cm )	Table Pos ( deg )	Peak Avg. ( P/A )	Pol. ( H/V )
802.11ac VHT40 CH 151 5755MHz		11510	48.41	-25.59	74	49.22	38	18.49	57.3	400	0	P	H
		17265	51.28	-16.92	68.2	44.2	41	21.83	55.75	400	0	P	H
													H
													H
		11510	48.3	-25.7	74	49.11	38	18.49	57.3	100	0	P	V
		17265	52.29	-15.91	68.2	45.21	41	21.83	55.75	100	0	P	V
													V
													V
802.11ac VHT40 CH 159 5795MHz		11590	47.75	-26.25	74	48.26	38.08	18.59	57.18	100	0	P	H
		17385	53.38	-14.82	68.2	46.33	40.83	21.94	55.72	100	0	P	H
													H
													H
		11590	47.36	-26.64	74	47.87	38.08	18.59	57.18	100	0	P	V
		17385	52.31	-15.89	68.2	45.26	40.83	21.94	55.72	100	0	P	V
													V
													V
<b>Remark</b>	1. No other spurious found. 2. All results are PASS against Peak and Average limit line.												





Band 4 5725~5850MHz

WIFI 802.11ac VHT80 (Band Edge @ 3m)

WIFI Ant. 1	Note	Frequency ( MHz )	Level ( dBμV/m )	Over Limit ( dB )	Limit Line ( dBμV/m )	Read Level ( dBμV )	Antenna Factor ( dB/m )	Path Loss ( dB )	Preamp Factor ( dB )	Ant Pos ( cm )	Table Pos ( deg )	Peak Avg. ( P/A )	Pol. ( H/V )
		5648.8	50.7	-17.5	68.2	39.85	34.5	11.43	35.08	100	327	P	H
		5692.6	58.44	-41.3	99.74	47.57	34.5	11.46	35.09	100	327	P	H
		5715.8	61.49	-48.14	109.63	50.56	34.53	11.5	35.1	100	327	P	H
		5724.6	63.38	-57.91	121.29	52.41	34.57	11.5	35.1	100	327	P	H
	*	5775	97.24	-	-	86.08	34.73	11.53	35.1	100	327	P	H
	*	5775	89.53	-	-	78.37	34.73	11.53	35.1	100	327	A	H
		5851.6	53.42	-65.13	118.55	42.14	34.8	11.6	35.12	100	327	P	H
		5859.6	51.17	-58.34	109.51	39.89	34.8	11.6	35.12	100	327	P	H
		5876.4	50.15	-54.01	104.16	38.82	34.8	11.65	35.12	100	327	P	H
		5941.2	50.07	-18.13	68.2	38.56	34.9	11.74	35.13	100	327	P	H
802.11ac													H
VHT80													H
CH 155		5607.8	49.74	-18.46	68.2	38.92	34.5	11.4	35.08	328	329	P	V
5775MHz		5687.6	54.9	-41.15	96.05	44.03	34.5	11.46	35.09	328	329	P	V
		5712.2	57.44	-51.18	108.62	46.51	34.53	11.5	35.1	328	329	P	V
		5721	56.51	-56.57	113.08	45.54	34.57	11.5	35.1	328	329	P	V
	*	5775	93.22	-	-	82.06	34.73	11.53	35.1	328	329	P	V
	*	5775	85.57	-	-	74.41	34.73	11.53	35.1	328	329	A	V
		5850.01	50.53	-71.65	122.18	39.25	34.8	11.6	35.12	328	329	P	V
		5873.8	49.19	-56.35	105.54	37.86	34.8	11.65	35.12	328	329	P	V
		5901.2	48.37	-37.4	85.77	37	34.8	11.69	35.12	328	329	P	V
		5949.2	48.47	-19.73	68.2	36.96	34.9	11.74	35.13	328	329	P	V
													V
													V
Remark	1. No other spurious found. 2. All results are PASS against Peak and Average limit line.												



**Band 4 5725~5850MHz**

**WIFI 802.11ac VHT80 (Harmonic @ 3m)**

WIFI Ant. 1	Note	Frequency ( MHz )	Level ( dBμV/m )	Over Limit ( dB )	Limit Line ( dBμV/m )	Read Level ( dBμV )	Antenna Factor ( dB/m )	Path Loss ( dB )	Preamp Factor ( dB )	Ant Pos ( cm )	Table Pos ( deg )	Peak Avg. (P/A)	Pol. (H/V)	
802.11ac VHT80 CH 155 5775MHz		11550	48.21	-25.79	74	48.85	38.05	18.54	57.23	400	0	P	H	
		17325	53.27	-14.93	68.2	46.16	40.97	21.88	55.74	400	0	P	H	
													H	
													H	
			11550	47.84	-26.16	74	48.48	38.05	18.54	57.23	100	0	P	V
			17325	52.59	-15.61	68.2	45.48	40.97	21.88	55.74	100	0	P	V
														V
Remark	1. No other spurious found. 2. All results are PASS against Peak and Average limit line.													



Emission below 1GHz

5GHz WIFI 802.11ac VHT40 (LF @ 3m)

WIFI	Note	Frequency	Level	Over	Limit	Read	Antenna	Path	Preamp	Ant	Table	Peak	Pol.	
Ant.				Limit	Line	Level	Factor	Loss	Factor	Pos	Pos	Avg.		
1		( MHz )	( dBμV/m )	( dB )	( dBμV/m )	( dBμV )	( dB/m )	( dB )	( dB )	( cm )	( deg )	( P/A )	( H/V )	
5GHz 802.11ac VHT40 LF		30	22.59	-17.41	40	26.84	24.6	1.33	30.18	-	-	P	H	
		147.45	28.33	-15.17	43.5	38.96	17.15	2.24	30.02	-	-	P	H	
		190.38	24.98	-18.52	43.5	37.82	14.75	2.38	29.97	-	-	P	H	
		878.9	32.03	-13.97	46	27.22	28.91	4.89	28.99	-	-	P	H	
		931.4	32.72	-13.28	46	26.9	29.53	4.97	28.68	-	-	P	H	
		941.2	33.82	-12.18	46	27.52	29.87	5.05	28.62	100	0	P	H	
													H	
													H	
													H	
													H	
													H	
													H	
													H	
													H	
													H	
													H	
			30	32	-8	40	36.25	24.6	1.33	30.18	100	0	P	V
			38.37	27.78	-12.22	40	36.73	19.88	1.34	30.17	-	-	P	V
		154.47	21.22	-22.28	43.5	32.13	16.85	2.25	30.01	-	-	P	V	
		862.1	32.09	-13.91	46	27.26	29.02	4.88	29.07	-	-	P	V	
		920.9	33.1	-12.9	46	27.72	29.17	4.97	28.76	-	-	P	V	
		956.6	33.89	-12.11	46	26.67	30.69	5.05	28.52	-	-	P	V	
													V	
													V	
													V	
													V	
													V	
													V	
													V	
Remark	1. No other spurious found. 2. All results are PASS against limit line.													



**Note symbol**

*	<b>Fundamental Frequency</b> which can be ignored. However, the level of any unwanted emissions shall not exceed the level of the fundamental frequency.
!	Test result is <b>over limit</b> line.
P/A	<b>Peak</b> or <b>Average</b>
H/V	<b>Horizontal</b> or <b>Vertical</b>



A calculation example for radiated spurious emission is shown as below:

WIFI	Note	Frequency	Level	Over	Limit	Read	Antenna	Path	Preamp	Ant	Table	Peak	Pol.
Ant.				Limit	Line	Level	Factor	Loss	Factor	Pos	Pos	Avg.	
1		( MHz )	( dBμV/m )	( dB )	( dBμV/m )	( dBμV )	( dB/m )	( dB )	( dB )	( cm )	( deg )	( P/A )	( H/V )
802.11b		2390	55.45	-18.55	74	54.51	32.22	4.58	35.86	103	308	P	H
CH 01													
2412MHz		2390	43.54	-10.46	54	42.6	32.22	4.58	35.86	103	308	A	H

1. Path Loss(dB) = Cable loss(dB) + Filter loss(dB) + Attenuator loss(dB)
2. Level(dBμV/m) = Antenna Factor(dB/m) + Path Loss(dB) + Read Level(dBμV) - Preamp Factor(dB)
3. Over Limit(dB) = Level(dBμV/m) – Limit Line(dBμV/m)

**For Peak Limit @ 2390MHz:**

1. Level(dBμV/m)  
= Antenna Factor(dB/m) + Path Loss(dB) + Read Level(dBμV) - Preamp Factor(dB)  
= 32.22(dB/m) + 4.58(dB) + 54.51(dBμV) – 35.86 (dB)  
= 55.45 (dBμV/m)
2. Over Limit(dB)  
= Level(dBμV/m) – Limit Line(dBμV/m)  
= 55.45(dBμV/m) – 74(dBμV/m)  
= -18.55(dB)

**For Average Limit @ 2390MHz:**

1. Level(dBμV/m)  
= Antenna Factor(dB/m) + Path Loss(dB) + Read Level(dBμV) - Preamp Factor(dB)  
= 32.22(dB/m) + 4.58(dB) + 42.6(dBμV) – 35.86 (dB)  
= 43.54 (dBμV/m)
2. Over Limit(dB) = Level(dBμV/m) – Limit Line(dBμV/m)  
= 43.54(dBμV/m) – 54(dBμV/m)  
= -10.46(dB)

**Both peak and average measured complies with the limit line, so test result is “PASS”.**



## Appendix D. Radiated Spurious Emission Plots

Test Engineer :	Jesse Wang, Stan Hsieh, Nick Yu, and	Temperature :	24~26°C
	Troye Hsieh	Relative Humidity :	54~56%

### Note symbol

-L	Low channel location
-R	High channel location



**Band 4 - 5725~5850MHz**  
**WIFI 802.11a (Band Edge @ 3m)**

WIFI	Band 4 5725~5850MHz Band Edge @ 3m	
ANT	802.11a CH149 5745MHz	
1	Horizontal	Fundamental
<b>Peak</b>	<p>Site : 09CH07-HY            Condition : PEAK_01(04)_16-24 3m HF_ANT_00211469 HORIZONTAL            Detector : Peak            Project : 881333-01            Mode : 35</p>	<p>Site : 09CH07-HY            Condition : PEAK_01(01) 3m HF_ANT_00211469 HORIZONTAL            Detector : Peak            Project : 881333-01            Mode : 35</p>

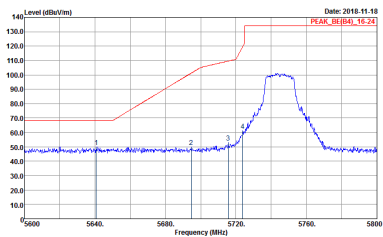
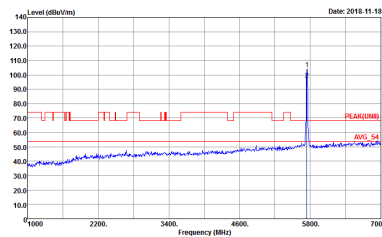

WIFI	Band 4 5725~5850MHz Band Edge @ 3m	
ANT	802.11a CH149 5745MHz	
1	Vertical	Fundamental
Peak	 <p>Site : 03C007-HY          Condition : PEAK_BE(04)_16-24 3m HF ANT 00211469 VERTICAL          RBW:1000.000kHz VBW:3000.000kHz SMT:Auto          Detector : Peak          Project : 881333-01          Mode : 35</p>	 <p>Site : 03C007-HY          Condition : PEAK(UNLI) 3m HF ANT 00211469 VERTICAL          RBW:1000.000kHz VBW:3000.000kHz SMT:Auto          Detector : Peak          Project : 881333-01          Mode : 35</p>





WIFI	Band 4 5725~5850MHz Band Edge @ 3m	
ANT	802.11a CH157 5785MHz	
1	Horizontal	Fundamental
<p><b>Peak</b></p>	<p>Site : 03CH07-HY            Condition : PEAK_BE(B4)_16-24 3m HF_ANT_00211469 HORIZONTAL            Detector : Peak            Project : 881333-01            Mode : 36</p>	<p>Site : 03CH07-HY            Condition : PEAK(UNLI)_3m HF_ANT_00211469 HORIZONTAL            Detector : Peak            Project : 881333-01            Mode : 36</p>
<p><b>Peak</b></p>	<p>Site : 03CH07-HY            Condition : PEAK_BE(B4)_16-24 3m HF_ANT_00211469 HORIZONTAL            Detector : Peak            Project : 881333-01            Mode : 36</p>	<p>Left blank</p>



WIFI	Band 4 5725~5850MHz Band Edge @ 3m	
ANT	802.11a CH157 5785MHz	
1	Vertical	Fundamental
<p><b>Peak</b></p>	<p>Site : 03CH07-HY            Condition : PEAK_BE(B4)_16-24 3m HF_ANT_00211469 VERTICAL            Detector : Peak            Project : 881333-01            Mode : 36</p>	<p>Site : 03CH07-HY            Condition : PEAK(UNII) 3m HF_ANT_00211469 VERTICAL            Detector : Peak            Project : 881333-01            Mode : 36</p>
<p><b>Peak</b></p>	<p>Site : 03CH07-HY            Condition : PEAK_BE(B4)_16-24 3m HF_ANT_00211469 VERTICAL            Detector : Peak            Project : 881333-01            Mode : 36</p>	<p>Left blank</p>



WIFI	Band 4 5725~5850MHz Band Edge @ 3m	
ANT	802.11a CH165 5825MHz	
1	Horizontal	Fundamental
Peak	<p>Site : 03C007-HY Condition : PEAK_BE(B4)_16-24 3m HF ANT 00211469 HORIZONTAL RBW:1000.000kHz VBW:3000.000kHz SMT:Auto Detector : Peak Project : 881333-01 Mode : 37</p>	<p>Site : 03C007-HY Condition : PEAK(UNLI) 3m HF ANT 00211469 HORIZONTAL RBW:1000.000kHz VBW:3000.000kHz SMT:Auto Detector : Peak Project : 881333-01 Mode : 37</p>



WIFI	Band 4 5725~5850MHz Band Edge @ 3m	
ANT	802.11a CH165 5825MHz	
1	Vertical	Fundamental
<p><b>Peak</b></p>	<p>Site : 03C007-HY            Condition : PEAK_BE(84)_16-24 3m HF_ANT_00211469 VERTICAL            Detector : Peak            Project : 881333-01            Mode : 37</p>	<p>Site : 03C007-HY            Condition : PEAK(UNLI) 3m HF_ANT_00211469 VERTICAL            Detector : Peak            Project : 881333-01            Mode : 37</p>



Band 4 5725~5850MHz
WIFI 802.11n HT20 (Band Edge @ 3m)

Table with 2 columns: Horizontal and Fundamental. It contains two spectral plots showing Level (dBm/100) vs Frequency (MHz) with associated metadata like Site, Condition, Detector, Project, and Mode.



WIFI	Band 4 5725~5850MHz Band Edge @ 3m	
ANT	802.11n HT20 CH149 5745MHz	
1	Vertical	Fundamental
Peak	<p>Site : 03C007-HY Condition : PEAK_BE(B4)_16-24 3m HF_ANT_00211469 VERTICAL RBW:1000.000kHz VBW:3000.000kHz SMT:Auto Detector : Peak Project : 881333-01 Mode : 38</p>	<p>Site : 03C007-HY Condition : PEAK(UNLI) 3m HF_ANT_00211469 VERTICAL RBW:1000.000kHz VBW:3000.000kHz SMT:Auto Detector : Peak Project : 881333-01 Mode : 38</p>



WIFI	Band 4 5725-5850MHz Band Edge @ 3m	
ANT	802.11n HT20 CH157 5785MHz	
1	Horizontal	Fundamental
<p><b>Peak</b></p>	<p>Date: 2018-11-18 PEAK_BE(B4)_16-24</p> <p>Site : 03CH07-HY Condition : PEAK_BE(B4)_16-24 3m HF_ANT_00211469 HORIZONTAL Detector : Peak Project : 881333-01 Mode : 39</p>	<p>Date: 2018-11-18 PEAK_UNLI</p> <p>Site : 03CH07-HY Condition : PEAK_UNLI 3m HF_ANT_00211469 HORIZONTAL Detector : Peak Project : 881333-01 Mode : 39</p>
<p><b>Peak</b></p>	<p>Date: 2018-11-18 PEAK_BE(B4)_16-24</p> <p>Site : 03CH07-HY Condition : PEAK_BE(B4)_16-24 3m HF_ANT_00211469 HORIZONTAL Detector : Peak Project : 881333-01 Mode : 39</p>	<p>Left blank</p>

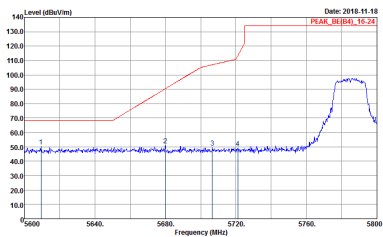
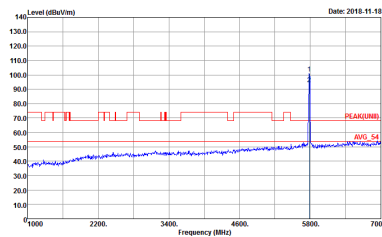
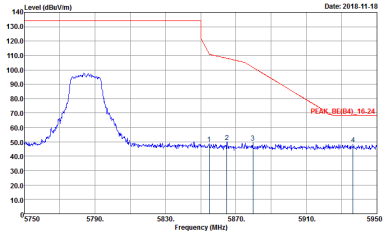

WIFI	Band 4 5725~5850MHz Band Edge @ 3m	
ANT	802.11n HT20 CH157 5785MHz	
1	Vertical	Fundamental
<p><b>Peak</b></p>	 <p>Date: 2018-11-18 PEAK_BE(B4)_16-24</p> <p>Site : 03CH07-HY Condition : PEAK_BE(B4)_16-24 3m HF_ANT_00211469 VERTICAL Detector : Peak Project : 881333-01 Mode : 39</p>	 <p>Date: 2018-11-18 PEAK_UNII AVG_57</p> <p>Site : 03CH07-HY Condition : PEAK_UNII 3m HF_ANT_00211469 VERTICAL Detector : Peak Project : 881333-01 Mode : 39</p>
<p><b>Peak</b></p>	 <p>Date: 2018-11-18 PEAK_BE(B4)_16-24</p> <p>Site : 03CH07-HY Condition : PEAK_BE(B4)_16-24 3m HF_ANT_00211469 VERTICAL Detector : Peak Project : 881333-01 Mode : 39</p>	<p>Left blank</p>





WIFI	Band 4 5725~5850MHz Band Edge @ 3m	
ANT	802.11n HT20 CH165 5825MHz	
1	Horizontal	Fundamental
<b>Peak</b>	<p>Site : 03C007-HY Condition : PEAK_BE(84)_16-24 3m HF ANT 00211469 HORIZONTAL RBW:1000.000kHz VBW:3000.000kHz SMT:Auto Detector : Peak Project : 881333-01 Mode : 40</p>	<p>Site : 03C007-HY Condition : PEAK(UNLI) 3m HF ANT 00211469 HORIZONTAL RBW:1000.000kHz VBW:3000.000kHz SMT:Auto Detector : Peak Project : 881333-01 Mode : 40</p>



WIFI	Band 4 5725~5850MHz Band Edge @ 3m	
ANT	802.11n HT20 CH165 5825MHz	
1	Vertical	Fundamental
<b>Peak</b>	<p>Site : 03C007-HY Condition : PEAK_BE(B4)_16-24 3m HF ANT 00211469 VERTICAL RBW:1000.000kHz VBW:3000.000kHz SMT:Auto Detector : Peak Project : 881333-01 Mode : 40</p>	<p>Site : 03C007-HY Condition : PEAK(UNLI) 3m HF ANT 00211469 VERTICAL RBW:1000.000kHz VBW:3000.000kHz SMT:Auto Detector : Peak Project : 881333-01 Mode : 40</p>



**Band 4 5725~5850MHz**  
**WIFI 802.11ac VHT40 (Band Edge @ 3m)**

WIFI	Band 4 5725~5850MHz Band Edge @ 3m	
ANT	802.11ac VHT40 CH151 5755MHz	
1	Horizontal	Fundamental
<b>Peak</b>	<p>Site : 03CH07-HY            Condition : PEAK_BE(B4)_16-24 3m HF_ANT_00211469 HORIZONTAL            Detector : Peak            Project : 881333-01            Mode : 41</p>	<p>Site : 03CH07-HY            Condition : PEAK(UNI1) 3m HF_ANT_00211469 HORIZONTAL            Detector : Peak            Project : 881333-01            Mode : 41</p>
<b>Peak</b>	<p>Site : 03CH07-HY            Condition : PEAK_BE(B4)_16-24 3m HF_ANT_00211469 HORIZONTAL            Detector : Peak            Project : 881333-01            Mode : 41</p>	<b>Left blank</b>

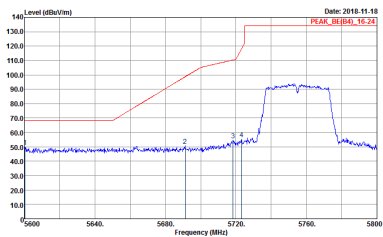
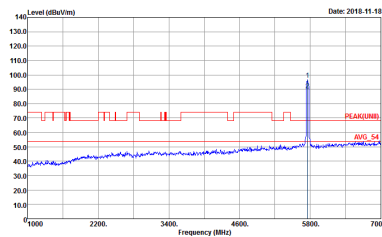
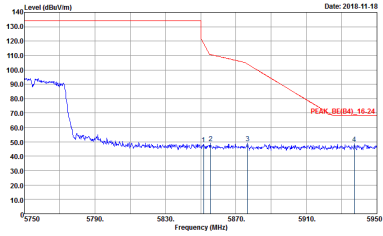

WIFI	Band 4 5725~5850MHz Band Edge @ 3m	
ANT	802.11ac VHT40 CH151 5755MHz	
1	Vertical	Fundamental
<p><b>Peak</b></p>	 <p>Site : 03CH07-HY            Condition : PEAK_BE(B4)_16-24 3m HF_ANT_00211469 VERTICAL            Detector : Peak            Project : 881333-01            Mode : 41</p>	 <p>Site : 03CH07-HY            Condition : PEAK(UNLI) 3m HF_ANT_00211469 VERTICAL            Detector : Peak            Project : 881333-01            Mode : 41</p>
<p><b>Peak</b></p>	 <p>Site : 03CH07-HY            Condition : PEAK_BE(B4)_16-24 3m HF_ANT_00211469 VERTICAL            Detector : Peak            Project : 881333-01            Mode : 41</p>	<p>Left blank</p>

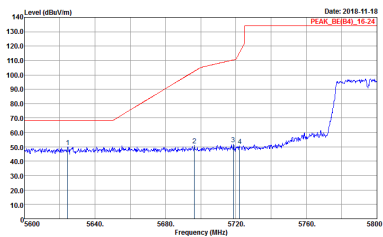
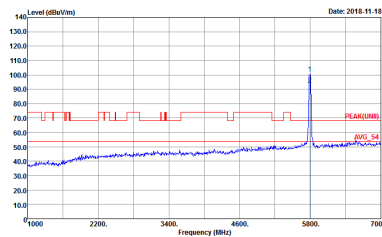
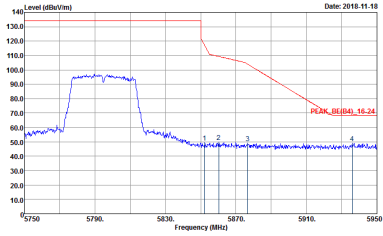

WIFI	Band 4 5725~5850MHz Band Edge @ 3m	
ANT	802.11ac VHT40 CH159 5795MHz	
1	Horizontal	Fundamental
<p><b>Peak</b></p>	 <p>Date: 2018-11-18 PEAK_BE(B4)_16-24</p> <p>Site : 03CH07-HY Condition : PEAK_BE(B4)_16-24 3m HF_ANT_00211469 HORIZONTAL Detector : Peak Project : 881333-01 Mode : 42</p>	 <p>Date: 2018-11-18 PEAK_UNLI</p> <p>Site : 03CH07-HY Condition : PEAK_UNLI 3m HF_ANT_00211469 HORIZONTAL Detector : Peak Project : 881333-01 Mode : 42</p>
<p><b>Peak</b></p>	 <p>Date: 2018-11-18 PEAK_BE(B4)_16-24</p> <p>Site : 03CH07-HY Condition : PEAK_BE(B4)_16-24 3m HF_ANT_00211469 HORIZONTAL Detector : Peak Project : 881333-01 Mode : 42</p>	<p>Left blank</p>

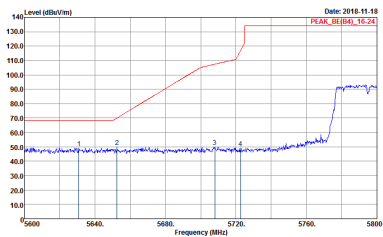
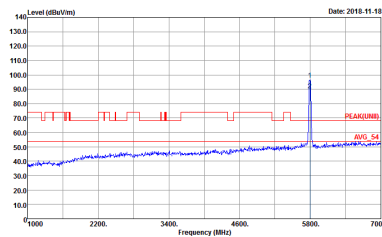
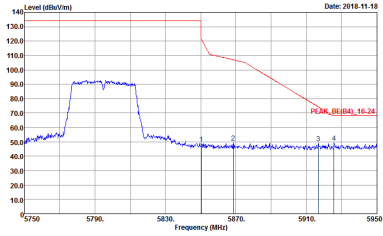

WIFI	Band 4 5725~5850MHz Band Edge @ 3m	
ANT	802.11ac VHT40 CH159 5795MHz	
1	Vertical	Fundamental
<p><b>Peak</b></p>	 <p>Site : 03CH07-HY            Condition : PEAK_BE(B4)_16-24 3m HF_ANT_00211469 VERTICAL            Detector : Peak            Project : 881333-01            Mode : 42</p>	 <p>Site : 03CH07-HY            Condition : PEAK(UNLI) 3m HF_ANT_00211469 VERTICAL            Detector : Peak            Project : 881333-01            Mode : 42</p>
<p><b>Peak</b></p>	 <p>Site : 03CH07-HY            Condition : PEAK_BE(B4)_16-24 3m HF_ANT_00211469 VERTICAL            Detector : Peak            Project : 881333-01            Mode : 42</p>	<p>Left blank</p>



**Band 4 5725~5850MHz**  
**WIFI 802.11ac VHT80 (Band Edge @ 3m)**

WIFI	Band 4 5725~5850MHz Band Edge @ 3m	
ANT	802.11ac VHT80 CH155 5775MHz	
1	Horizontal	Fundamental
<b>Peak</b>	<p>Site : 03CH07-HY            Condition : PEAK_BE(B4)_16-24 3m HF_ANT_00211469 HORIZONTAL            Detector : Peak            Project : 881333-01            Mode : 43</p>	<p>Site : 03CH07-HY            Condition : PEAK(UWB) 3m HF_ANT_00211469 HORIZONTAL            Detector : Peak            Project : 881333-01            Mode : 43</p>
<b>Peak</b>	<p>Site : 03CH07-HY            Condition : PEAK_BE(B4)_16-24 3m HF_ANT_00211469 HORIZONTAL            Detector : Peak            Project : 881333-01            Mode : 43</p>	<b>Left blank</b>

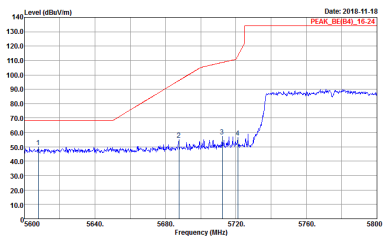
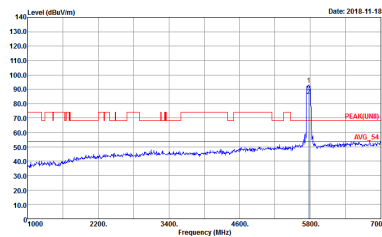
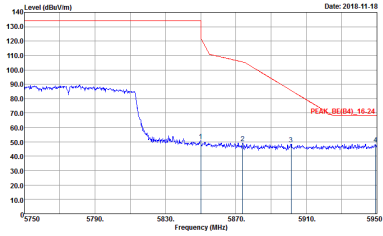

WIFI	Band 4 5725-5850MHz Band Edge @ 3m	
ANT	802.11ac VHT80 CH155 5775MHz	
1	Vertical	Fundamental
<p><b>Peak</b></p>	 <p>Date: 2018-11-18 PEAK_BE(B4)_16-24</p> <p>Site : 03CH07-HY Condition : PEAK_BE(B4)_16-24 3m HF_ANT_00211469 VERTICAL Detector : Peak Project : 881333-01 Mode : 43</p>	 <p>Date: 2018-11-18 PEAK_UNLI</p> <p>Site : 03CH07-HY Condition : PEAK_UNLI 3m HF_ANT_00211469 VERTICAL Detector : Peak Project : 881333-01 Mode : 43</p>
<p><b>Peak</b></p>	 <p>Date: 2018-11-18 PEAK_BE(B4)_16-24</p> <p>Site : 03CH07-HY Condition : PEAK_BE(B4)_16-24 3m HF_ANT_00211469 VERTICAL Detector : Peak Project : 881333-01 Mode : 43</p>	<p><b>Left blank</b></p>





Band 4 - 5725~5850MHz
WIFI 802.11a (Harmonic @ 3m)

Table with 2 columns: WIFI (Band 4 5725~5850MHz Harmonic @ 3m), ANT (802.11a CH149 5745MHz). Row 1: 1, Horizontal, Vertical. Each plot shows Level (dBuV/m) vs Frequency (MHz) with Peak and Avg markers.

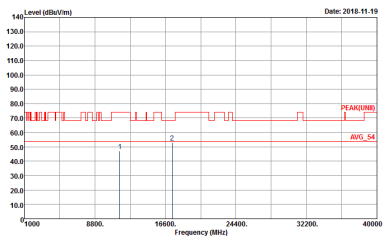
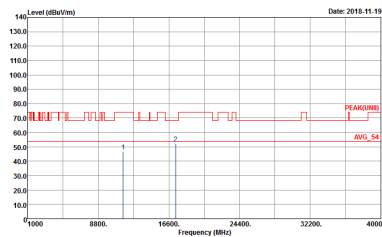

WIFI	Band 4 5725~5850MHz Harmonic @ 3m	
ANT	802.11a CH157 5785MHz	
1	Horizontal	Vertical
<p>Peak</p> <p>Avg.</p>	 <p>Site : 03C007-HY  Condition : PEAK(UNI) 3m SHF-EHF_131029 HORIZONTAL  Detector : Peak  Project : 881333-01  Mode : 3G</p>	 <p>Site : 03C007-HY  Condition : PEAK(UNI) 3m SHF-EHF_131029 VERTICAL  Detector : Peak  Project : 881333-01  Mode : 3G</p>

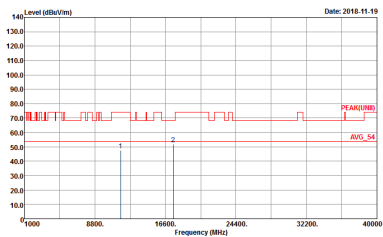
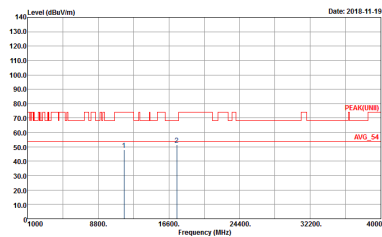

WIFI	Band 4 5725~5850MHz Harmonic @ 3m	
ANT	802.11a CH165 5825MHz	
1	Horizontal	Vertical
<p>Peak</p> <p>Avg.</p>	 <p>Site : 03C007-HY          Condition : PEAK(UNII) 3m SHF-EHF_131029 HORIZONTAL          Detector : Peak          Project : 881333-01          Mode : 37</p>	 <p>Site : 03C007-HY          Condition : PEAK(UNII) 3m SHF-EHF_131029 VERTICAL          Detector : Peak          Project : 881333-01          Mode : 37</p>



**Band 4 5725~5850MHz  
WIFI 802.11n HT20 (Harmonic @ 3m)**

WIFI	Band 4 5725~5850MHz Harmonic @ 3m	
ANT	802.11n HT20 CH149 5745MHz	
1	Horizontal	Vertical
<p><b>Peak</b></p> <p><b>Avg.</b></p>	<p>Site : 03CH07-HY Condition : PEAK(UNII) 3m SHF-EHF_131029 HORIZONTAL Detection : Peak Project : 881333-01 Mode : 38</p>	<p>Site : 03CH07-HY Condition : PEAK(UNII) 3m SHF-EHF_131029 VERTICAL Detection : Peak Project : 881333-01 Mode : 38</p>

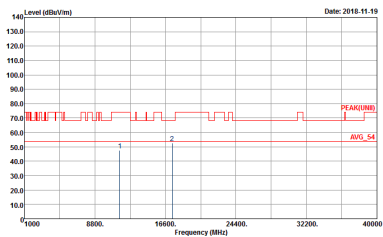
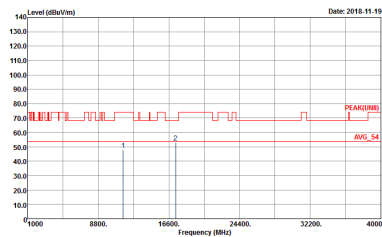

WIFI	Band 4 5725~5850MHz Harmonic @ 3m	
ANT	802.11n HT20 CH157 5785MHz	
1	Horizontal	Vertical
<p>Peak</p> <p>Avg.</p>	 <p>Site : 03C007-HY          Condition : PEAK(UNI) 3m SHF-EHF_131029 HORIZONTAL          Detector : Peak          Project : 881333-01          Mode : 39</p>	 <p>Site : 03C007-HY          Condition : PEAK(UNI) 3m SHF-EHF_131029 VERTICAL          Detector : Peak          Project : 881333-01          Mode : 39</p>

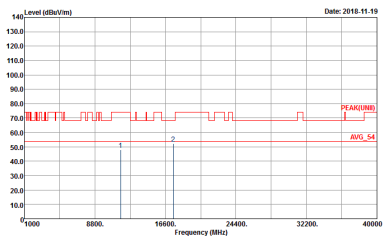
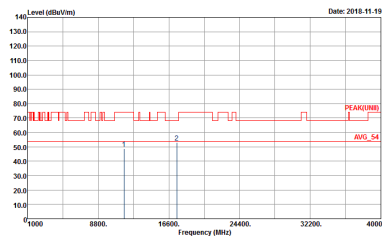

WIFI	Band 4 5725~5850MHz Harmonic @ 3m	
ANT	802.11n HT20 CH165 5825MHz	
1	Horizontal	Vertical
<p>Peak</p> <p>Avg.</p>	 <p>Site : 03C007-HY          Condition : PEAK(UNII) 3m SHF-EHF_131029 HORIZONTAL          Detector : Peak          Project : 881333-01          Mode : 40</p>	 <p>Site : 03C007-HY          Condition : PEAK(UNII) 3m SHF-EHF_131029 VERTICAL          Detector : Peak          Project : 881333-01          Mode : 40</p>



**Band 4 5725~5850MHz  
WIFI 802.11ac VHT40 (Harmonic @ 3m)**

WIFI	Band 4 5725~5850MHz Harmonic @ 3m	
ANT	802.11ac VHT40 CH151 5755MHz	
1	Horizontal	Vertical
<b>Peak</b>  <b>Avg.</b>	<p>Site : 03CH07-HY            Condition : PEAK(UNII) 3m SHF-EHF_131029 HORIZONTAL            Detection : Peak            Project : 881333-01            Mode : 41</p>	<p>Site : 03CH07-HY            Condition : PEAK(UNII) 3m SHF-EHF_131029 VERTICAL            Detection : Peak            Project : 881333-01            Mode : 41</p>



WIFI	Band 4 5725~5850MHz Harmonic @ 3m	
ANT	802.11ac VHT40 CH159 5795MHz	
1	Horizontal	Vertical
Peak Avg.	<p>Site : 03C007-HY Condition : PEAK(UNI) 3m SHF-EHF_131029 HORIZONTAL Detector : Peak Project : 881333-01 Mode : 42</p>	<p>Site : 03C007-HY Condition : PEAK(UNI) 3m SHF-EHF_131029 VERTICAL Detector : Peak Project : 881333-01 Mode : 42</p>





**Band 4 5725~5850MHz  
WIFI 802.11ac VHT80 (Harmonic @ 3m)**

WIFI	Band 4 5725~5850MHz Harmonic @ 3m	
ANT	802.11ac VHT80 CH155 5775MHz	
1	Horizontal	Vertical
<p><b>Peak</b></p> <p><b>Avg.</b></p>	<p>Site : 03CH07-HY Condition : PEAK(UNII) 3m SHF-EHF_131029 HORIZONTAL Detection : Peak Project : 881333-01 Mode : 43</p>	<p>Site : 03CH07-HY Condition : PEAK(UNII) 3m SHF-EHF_131029 VERTICAL Detection : Peak Project : 881333-01 Mode : 43</p>



Emission below 1GHz  
5GHz WIFI 802.11ac VHT40 (LF)

WIFI	5GHz 5725~5850MHz	
ANT	802.11ac VHT40 LF	
1	Horizontal	Vertical
QP / Peak	<p>Site : 03CH07-HY Condition : QP 3m LF-ANT-35419(G) HORIZONTAL Detector : Peak Project : 881333-01 Mode : 34</p>	<p>Site : 03CH07-HY Condition : QP 3m LF-ANT-35419(G) VERTICAL Detector : Peak Project : 881333-01 Mode : 34</p>



## Appendix E. Duty Cycle Plots

Band	Duty Cycle(%)	T(us)	1/T(kHz)	VBW Setting	Duty Factor(dB)
802.11a	94.93	2060	0.49	1kHz	0.23
5GHz 802.11n HT20	94.58	1920	0.52	1kHz	0.24
5GHz 802.11n HT40	89.10	940	1.06	3kHz	0.50
5GHz 802.11ac VHT20	95.10	1940	0.52	1kHz	0.22
5GHz 802.11ac VHT40	90.09	955	1.05	3kHz	0.45
5GHz 802.11ac VHT80	88.70	738	1.36	3kHz	0.52



**802.11a**

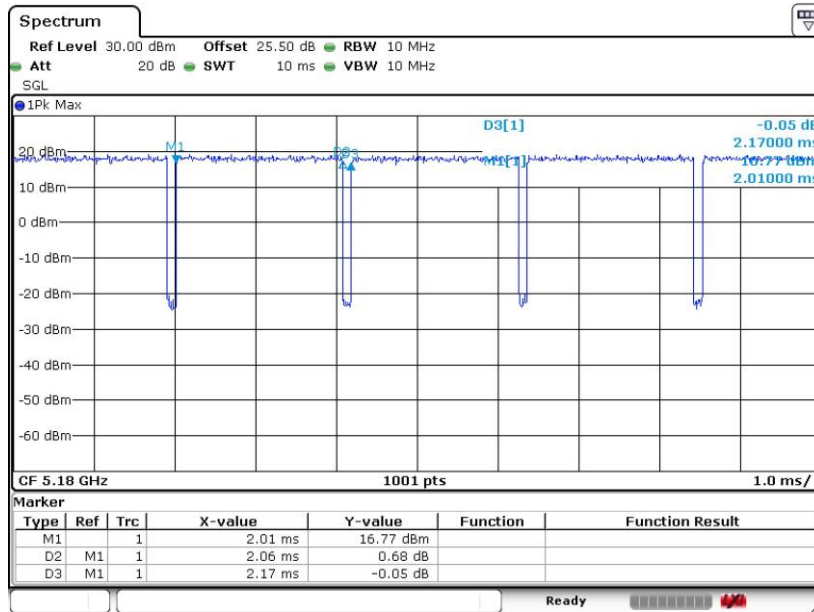

Date: 4.SEP.2018 09:45:10

**802.11n HT20**

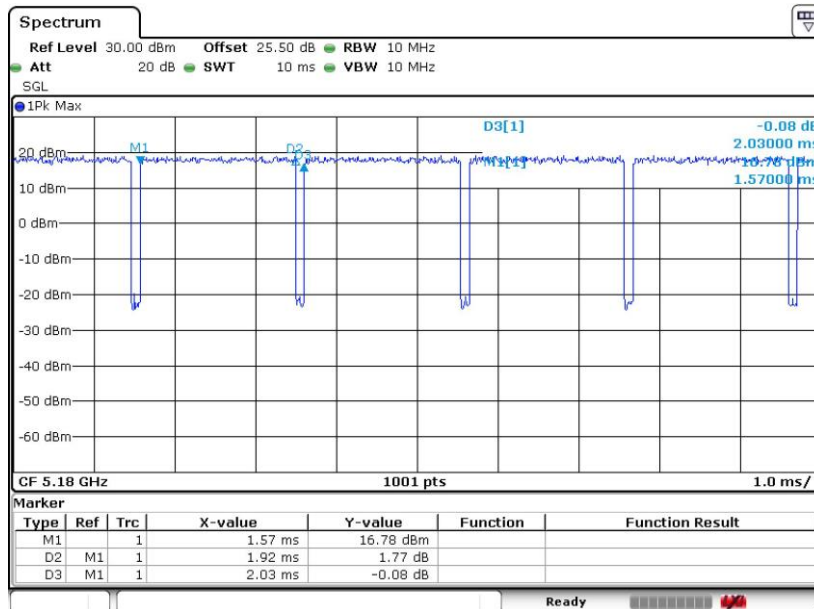

Date: 4.SEP.2018 09:46:51



**802.11n HT40**

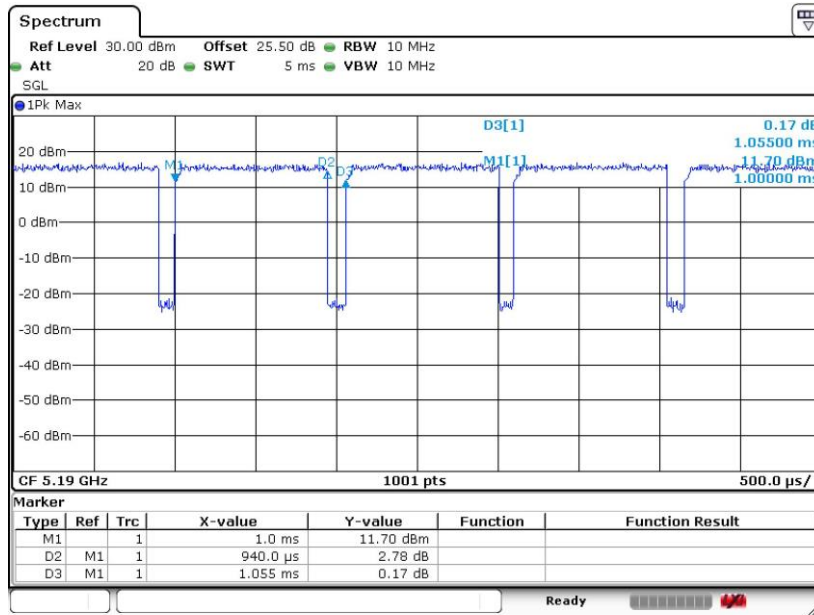

Date: 4.SEP.2018 09:47:52

**802.11ac VHT20**

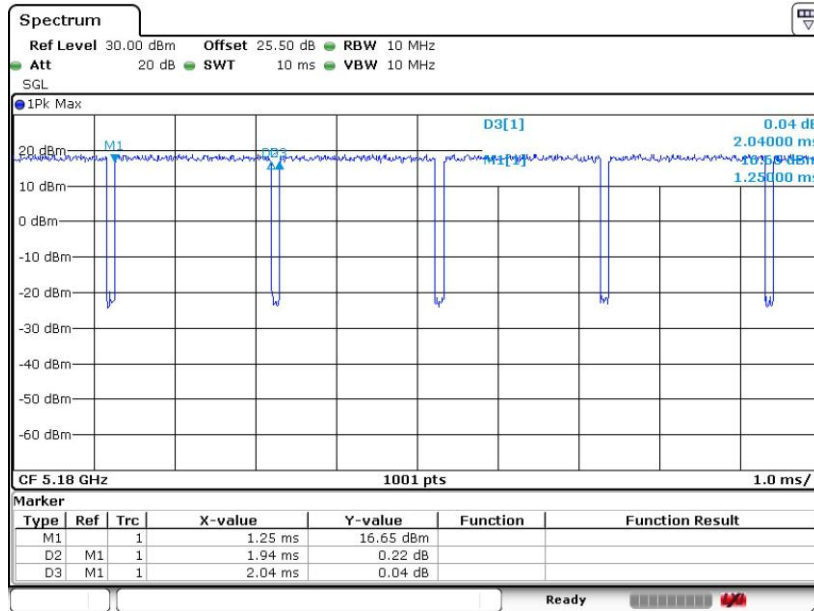

Date: 4.SEP.2018 09:49:10



802.11ac VHT40

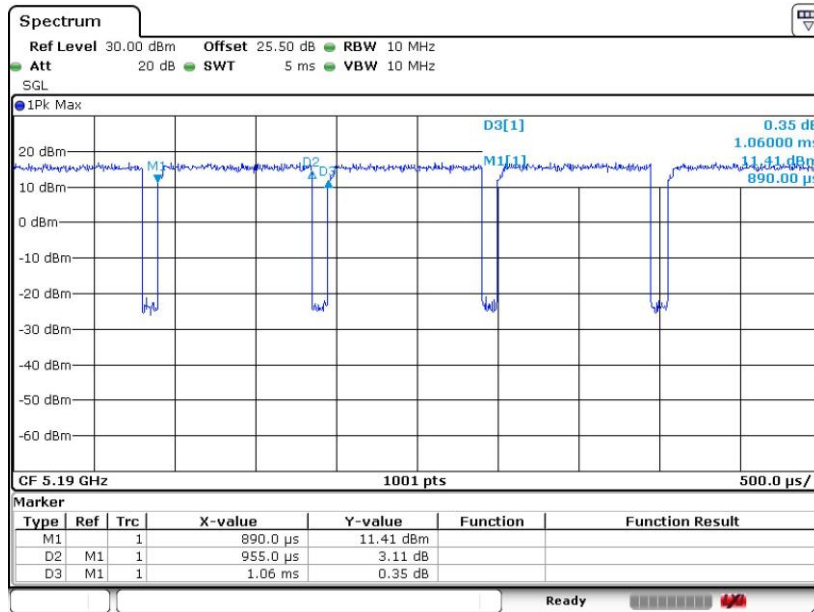

Date: 4.SEP.2018 09:50:17

802.11ac VHT80

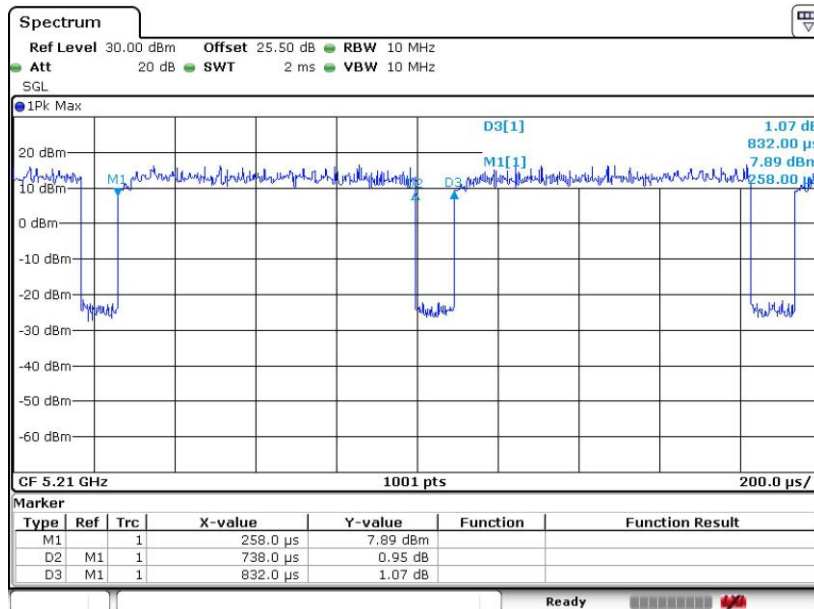

Date: 4.SEP.2018 09:52:08

—————THE END—————