



CERTIFICATION TEST REPORT

Report Number. : 12380932-E3V1

Applicant : SONY MOBILE COMMUNICATIONS, INC.
4-12-3 HIGASHI-SHINAGAWA
SHINAGAWA-KU, TOKYO, 140-0002, JAPAN

FCC ID : PY7-12644J

EUT Description : GSM/WCDMA/LTE Phone with BT, DTS/UNII a/b/g/n/ac &
NFC

Test Standard(s) : FCC 47 CFR PART 15 SUBPART C

Date Of Issue:

July 20, 2018

Prepared by:

UL Verification Services Inc.
47173 Benicia Street
Fremont, CA 94538 U.S.A.
TEL: (510) 771-1000
FAX: (510) 661-0888



REPORT REVISION HISTORY

Rev.	Issue Date	Revisions	Revised By
V1	07/20/18	Initial Issue	

TABLE OF CONTENTS

REPORT REVISION HISTORY	2
TABLE OF CONTENTS	3
1. ATTESTATION OF TEST RESULTS	5
2. TEST METHODOLOGY	6
3. FACILITIES AND ACCREDITATION	6
4. CALIBRATION AND UNCERTAINTY	7
4.1. <i>MEASURING INSTRUMENT CALIBRATION</i>	<i>7</i>
4.2. <i>SAMPLE CALCULATION</i>	<i>7</i>
4.3. <i>MEASUREMENT UNCERTAINTY.....</i>	<i>7</i>
5. EQUIPMENT UNDER TEST.....	8
5.1. <i>EUT DESCRIPTION.....</i>	<i>8</i>
5.2. <i>MAXIMUM OUTPUT POWER.....</i>	<i>8</i>
5.3. <i>DESCRIPTION OF AVAILABLE ANTENNAS.....</i>	<i>8</i>
5.4. <i>SOFTWARE AND FIRMWARE.....</i>	<i>8</i>
5.5. <i>WORST-CASE CONFIGURATION AND MODE.....</i>	<i>8</i>
5.6. <i>DESCRIPTION OF TEST SETUP.....</i>	<i>9</i>
6. MEASUREMENT METHOD.....	12
7. TEST AND MEASUREMENT EQUIPMENT	13
8. ANTENNA PORT TEST RESULTS	14
8.1. <i>ON TIME AND DUTY CYCLE.....</i>	<i>14</i>
8.2. <i>99% BANDWIDTH.....</i>	<i>16</i>
8.2.1. <i>BLE (1Mbps).....</i>	<i>17</i>
8.2.2. <i>BLE (2Mbps).....</i>	<i>18</i>
8.3. <i>6 dB BANDWIDTH.....</i>	<i>19</i>
8.3.1. <i>BLE (1Mbps).....</i>	<i>20</i>
8.3.2. <i>BLE (2Mbps).....</i>	<i>21</i>
8.4. <i>OUTPUT POWER.....</i>	<i>22</i>
8.4.1. <i>BLE (1Mbps).....</i>	<i>23</i>
8.4.2. <i>BLE (2Mbps).....</i>	<i>24</i>
8.5. <i>AVERAGE POWER.....</i>	<i>25</i>
8.5.1. <i>BLE (1Mbps).....</i>	<i>26</i>
8.5.2. <i>BLE (2Mbps).....</i>	<i>27</i>
8.6. <i>POWER SPECTRAL DENSITY.....</i>	<i>28</i>
8.6.1. <i>BLE (1Mbps).....</i>	<i>29</i>

8.6.2.	BLE (2Mbps).....	30
8.7.	<i>CONDUCTED SPURIOUS EMISSIONS</i>	31
8.7.1.	BLE (1Mbps).....	32
8.7.2.	BLE (2Mbps).....	33
9.	RADIATED TEST RESULTS	34
9.1.	<i>LIMITS AND PROCEDURE</i>	34
9.2.	<i>TRANSMITTER ABOVE 1 GHz</i>	35
9.2.1.	BLE (1Mbps).....	35
9.2.2.	BLE (2Mbps).....	45
9.3.	<i>Worst Case Below 30 MHz</i>	55
9.4.	<i>Worst Case Below 1 GHz</i>	56
9.5.	<i>Worst Case 18-26 GHz</i>	58
10.	AC POWER LINE CONDUCTED EMISSIONS	60
10.1.1.	AC Power Line Norm.....	61
11.	SETUP PHOTOS	63

1. ATTESTATION OF TEST RESULTS

COMPANY NAME: SONY MOBILE COMMUNICATIONS, INC.
4-12-3 HIGASHI-SHINAGAWA,
SHINAGAWA-KU, TOKYO, 140-0002, JAPAN

EUT DESCRIPTION: GSM/WCDMA/LTE Phone with BT, DTS/UNII a/b/g/n/ac & NFC

SERIAL NUMBER: BH93004ADB, BH93000ADB (Conducted),
BH930027D8, BH93004RD8, BH93004ND8 (Radiated)

DATE TESTED: JULY 7 – JULY 16, 2018

APPLICABLE STANDARDS	
STANDARD	TEST RESULTS
CFR 47 Part 15 Subpart C	Complies

UL Verification Services Inc. tested the above equipment in accordance with the requirements set forth in the above standards. All indications of Pass/Fail in this report are opinions expressed by UL Verification Services Inc. based on interpretations and/or observations of test results. Measurement Uncertainties were not taken into account and are published for informational purposes only. The test results show that the equipment tested is capable of demonstrating compliance with the requirements as documented in this report.

Note: The results documented in this report apply only to the tested sample, under the conditions and modes of operation as described herein. This document may not be altered or revised in any way unless done so by UL Verification Services Inc. and all revisions are duly noted in the revisions section. Any alteration of this document not carried out by UL Verification Services Inc. will constitute fraud and shall nullify the document. This report must not be used by the client to claim product certification, approval, or endorsement by NVLAP, NIST, any agency of the Federal Government, or any agency of the U.S. government.

Approved & Released For
UL Verification Services Inc. By:

Reviewed By:



Dan Corona
CONSUMER TECHNOLOGY DIVISION
Operations Leader
UL Verification Services Inc.

Kiya Kedida
CONSUMER TECHNOLOGY DIVISION
Project Engineer
UL Verification Services Inc

2. TEST METHODOLOGY

The tests documented in this report were performed in accordance with FCC CFR 47 Part 2, FCC CFR 47 Part 15, KDB 558074 D01 v4, and ANSI C63.10-2013.

3. FACILITIES AND ACCREDITATION

The test sites and measurement facilities used to collect data are located at 47173 and 47266 Benicia Street, and 47658 Kato Road, Fremont, California, USA. Line conducted emissions are measured only at the 47173 address. The following table identifies which facilities were utilized for radiated emission measurements documented in this report. Specific facilities are also identified in the test results sections.

47173 Benicia Street	47266 Benicia Street	47658 Kato Rd.
<input checked="" type="checkbox"/> Chamber A (ISED:2324B-1)	<input type="checkbox"/> Chamber D (ISED:22541-1)	<input type="checkbox"/> Chamber K (ISED: 2324A-1)
<input type="checkbox"/> Chamber B (ISED:2324B-2)	<input type="checkbox"/> Chamber E (ISED:22541-2)	<input type="checkbox"/> Chamber L (ISED: 2324A-3)
<input type="checkbox"/> Chamber C (ISED:2324B-3)	<input type="checkbox"/> Chamber F (ISED:22541-3)	
	<input type="checkbox"/> Chamber G (ISED:22541-4)	
	<input type="checkbox"/> Chamber H (ISED:22541-5)	

The above test sites and facilities are covered under FCC Test Firm Registration # 208313. Chambers A through C are covered under ISED company address code 2324B with site numbers 2324B -1 through 2324B-3, respectively. Chambers D through H are covered under ISED company address code 22541 with site numbers 22541 -1 through 22541-5, respectively. Chambers K and L are covered under ISED company address code 2324A with site numbers 2324A-1 and 2324A-3, respectively.

UL Verification Services Inc. is accredited by NVLAP, Laboratory Code 200065-0

4. CALIBRATION AND UNCERTAINTY

4.1. MEASURING INSTRUMENT CALIBRATION

The measuring equipment utilized to perform the tests documented in this report has been calibrated in accordance with the manufacturer's recommendations, and is traceable to recognized national standards.

4.2. SAMPLE CALCULATION

Where relevant, the following sample calculation is provided:

$$\begin{aligned} \text{Field Strength (dBuV/m)} &= \text{Measured Voltage (dBuV)} + \text{Antenna Factor (dB/m)} + \\ &\text{Cable Loss (dB)} - \text{Preamp Gain (dB)} \\ 36.5 \text{ dBuV} + 18.7 \text{ dB/m} + 0.6 \text{ dB} - 26.9 \text{ dB} &= 28.9 \text{ dBuV/m} \end{aligned}$$

4.3. MEASUREMENT UNCERTAINTY

Where relevant, the following measurement uncertainty levels have been estimated for tests performed on the apparatus:

PARAMETER	UNCERTAINTY
Worst Case Conducted Disturbance, 9KHz to 0.15 MHz	3.84 dB
Worst Case Conducted Disturbance, 0.15 to 30 MHz	3.65 dB
Worst Case Radiated Disturbance, 9KHz to 30 MHz	3.15 dB
Worst Case Radiated Disturbance, 30 to 1000 MHz	5.36 dB
Worst Case Radiated Disturbance, 1000 to 18000 MHz	4.32 dB
Worst Case Radiated Disturbance, 18000 to 26000 MHz	4.45 dB
Worst Case Radiated Disturbance, 26000 to 40000 MHz	5.24 dB

Uncertainty figures are valid to a confidence level of 95%.

5. EQUIPMENT UNDER TEST

5.1. EUT DESCRIPTION

The EUT is a GSM/WCDMA/LTE Phone with BT, DTS/UNII a/b/g/n/ac & NFC.

5.2. MAXIMUM OUTPUT POWER

The transmitter has a maximum peak conducted output power as follows:

Frequency Range (MHz)	Mode	Output Power (dBm)	Output Power (mW)
2402 - 2480	BLE (1Mbps)	5.46	3.52
2402 - 2480	BLE (2Mbps)	5.68	3.70

5.3. DESCRIPTION OF AVAILABLE ANTENNAS

The radio utilizes a loop antenna for chain 0 with maximum gain of -1.5dBi.

5.4. SOFTWARE AND FIRMWARE

The firmware installed in the EUT during testing was s_atp_0_00436_A_12_16.
The test utility software used during testing was Tera Term Ver 4.79

5.5. WORST-CASE CONFIGURATION AND MODE

Radiated emissions below 1GHz, above 18GHz, and power line conducted emission were performed with the EUT set to transmit at the channel with highest output power as worst-case scenario.

Band edge and radiated emissions between 1GHz and 18GHz were performed with the EUT set to transmit at the highest power on low, middle and high channels.

The fundamental of the EUT was investigated in three orthogonal orientations X,Y,Z, it was determined that X orientation was worst-case orientation; therefore, all final radiated testing was performed with the EUT in X orientation.

5.6. DESCRIPTION OF TEST SETUP

SUPPORT EQUIPMENT

Support Equipment List				
Description	Manufacturer	Model	Serial Number	FCC ID
Laptop	Lenovo	20B7S0A200	PC015REW	N/A
Desktop	Lenovo	ThinkCentre	MJ00QA59	N/A
AC Adapter	SONY	UCH20	3416W45305784	N/A
DC Power Supply	Ametek	XT 15-4	T463	N/A

I/O CABLES (CONDUCTED TEST)

I/O Cable List						
Cable No	Port	# of identical ports	Connector Type	Cable Type	Cable Length (m)	Remarks
1	Antenna	1	RF	Shielded	0.2	To spectrum Analyzer
2	USB	1	USB Type C	Shielded	1	N/A
3	DC	1	DC	Shielded	0.3	N/A

I/O CABLES (RADIATED AND CONDUCTED EMISSIONS)

I/O Cable List						
Cable No	Port	# of identical ports	Connector Type	Cable Type	Cable Length (m)	Remarks
1	USB	1	USB Type C	Shielded	3	N/A

TEST SETUP

The EUT is connected to a test laptop during the tests. Test software exercised the radio card.

CONDCUTED TEST SETUP DIAGRAM

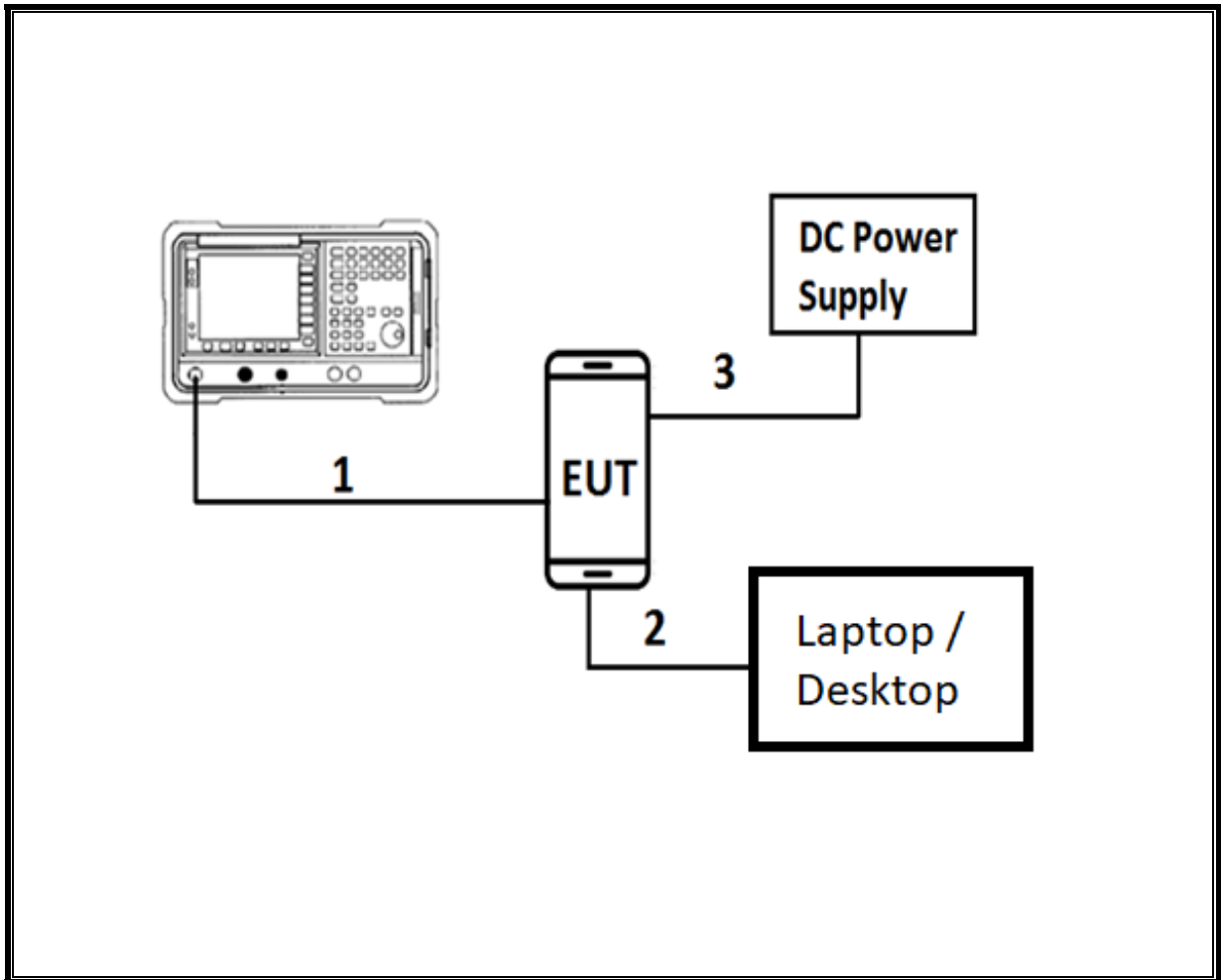

TEST SETUP

For conducted tests: the EUT was connected to a host laptop via an USB cable for parameter setting purpose such as channel, output power...etc. The test software exercises the radio.

RADIATED AND AC LINE CONDUCTED EMISSIONS SETUP DIAGRAM

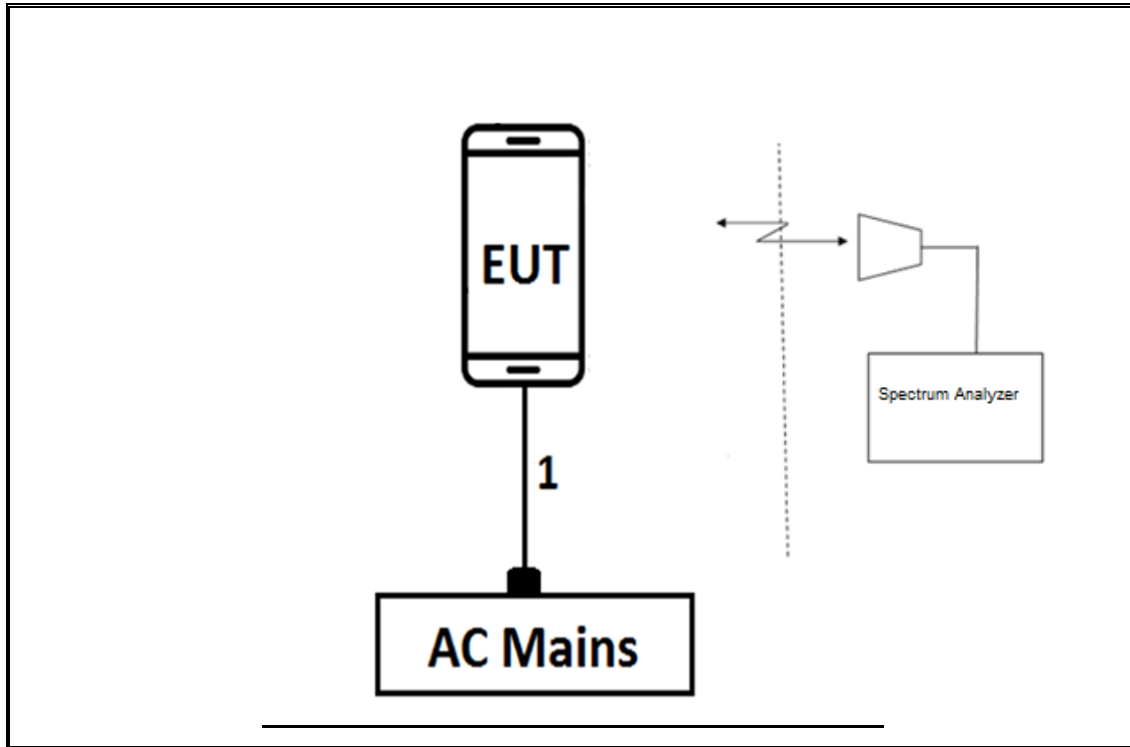

TEST SETUP

For radiated tests: All support equipment were removed after the EUT programmed. The test software exercises the radio.

6. MEASUREMENT METHOD

On Time and Duty Cycle: KDB 558074 D01 v04, Section 6.

6 dB BW: KDB 558074 D01 v04, Section 8.1.

Output Power: KDB 558074 D01 v04, Section 9.1.3.

Power Spectral Density: KDB 558074 D01 v04, Section 10.2.

Out-of-band emissions in non-restricted bands: KDB 558074 D01 v04, Section 11.0.

Out-of-band emissions in restricted bands: KDB 558074 D01 v04, Section 12.1.

Band-edge: KDB 558074 D01 v04, Section 12.1.

AC Power Line Conducted Emissions: ANSI C63.10-2013, Section 6.2.

7. TEST AND MEASUREMENT EQUIPMENT

The following test and measurement equipment was utilized for the tests documented in this report:

TEST EQUIPMENT LIST				
Description	Manufacturer	Model	ID Num	Cal Due
Amplifier, 100kHz to 1GHz, 32dB	Hewlet Packard	8447D	T15	08/14/2018
Antenna, Broadband Hybrid, 30MHz to 2000MHz	Sunol Sciences Corp.	JB1	T130	10/16/2018
Antenna, Horn 1-18GHz	ETS-Lindgren	3117	T345	04/25/2019
RF Amplifier	MITEQ	AFS42-00101800-25-S-42	T1165	04/23/2019
Amplifier, 1 to 8GHz, 35dB	Miteq Inc.	AMF-4D-01000800-30-29P	T1573	04/03/2019
Spectrum Analyzer, PXA, 3Hz to 44GHz	Agilent (Keysight) Technologies	N9030A	T1450	02/05/2019
Spectrum Analyzer, PXA, 3Hz to 44GHz	Agilent (Keysight) Technologies	N9030A	T1113	12/21/2018
Spectrum Analyzer, PSA, 3Hz to 44GHz	Agilent (Keysight) Technologies	N9030A	T1466	04/16/2019
Spectrum Analyzer, PSA, 3Hz to 44GHz	Agilent (Keysight) Technologies	N9030A	T1454	01/08/2019
Power Meter, P-series single channel	Agilent (Keysight) Technologies	N1911A	T1271	07/17/2018
Power Sensor, P-series, 50MHz to 18GHz, Wideband	Agilent (Keysight) Technologies	N1921A	T1225	04/10/2019
Filter, HPF 3.0GHz	MICRO-TRONICS	HPM17543	T486	04/03/2019
Antenna, Active Loop 9kHz-30MHz	Com-Power Corp.	AL-130R	T1866	10/10/2018
18 - 26.5 GHz Horn Antenna	Seavey Division	MWH-1826/B	T89	01/18/2019
Pre-Amp 1-26.5 GHz	Agilent	8449B	T404	03/09/2019
EMI Receiver	Rohde & Schwarz	ESR	T1436	02/21/2019
L.I.S.N.	FCC INC.	FCC LISN 50/250	T1310	06/15/2019
L.I.S.N.	FCC INC.	FCC LISN 50/250	T24	03/06/2019
Thermometer - Digital	Control Company	14-650-118	PRE0177862	02/22/2019

Test Software List			
Description	Manufacturer	Model	Version
Radiated Software	UL	UL EMC	Ver 9.5, June 22, 2018
Antenna Port Software	UL	UL RF	Ver 8.4, June 12, 2018

8. ANTENNA PORT TEST RESULTS

8.1. ON TIME AND DUTY CYCLE

LIMITS

None; for reporting purposes only.

PROCEDURE

ON TIME AND DUTY CYCLE RESULTS

Mode	ON Time B (msec)	Period (msec)	Duty Cycle x (linear)	Duty Cycle (%)	Duty Cycle Correction Factor (dB)	1/B Minimum VBW (kHz)
2.4GHz Band						
BLE (1Mbps)	2.138	2.502	0.855	85.45%	0.68	0.468
BLE (2Mbps)	1.076	1.872	0.575	57.48%	2.40	0.929

DUTY CYCLE PLOTS

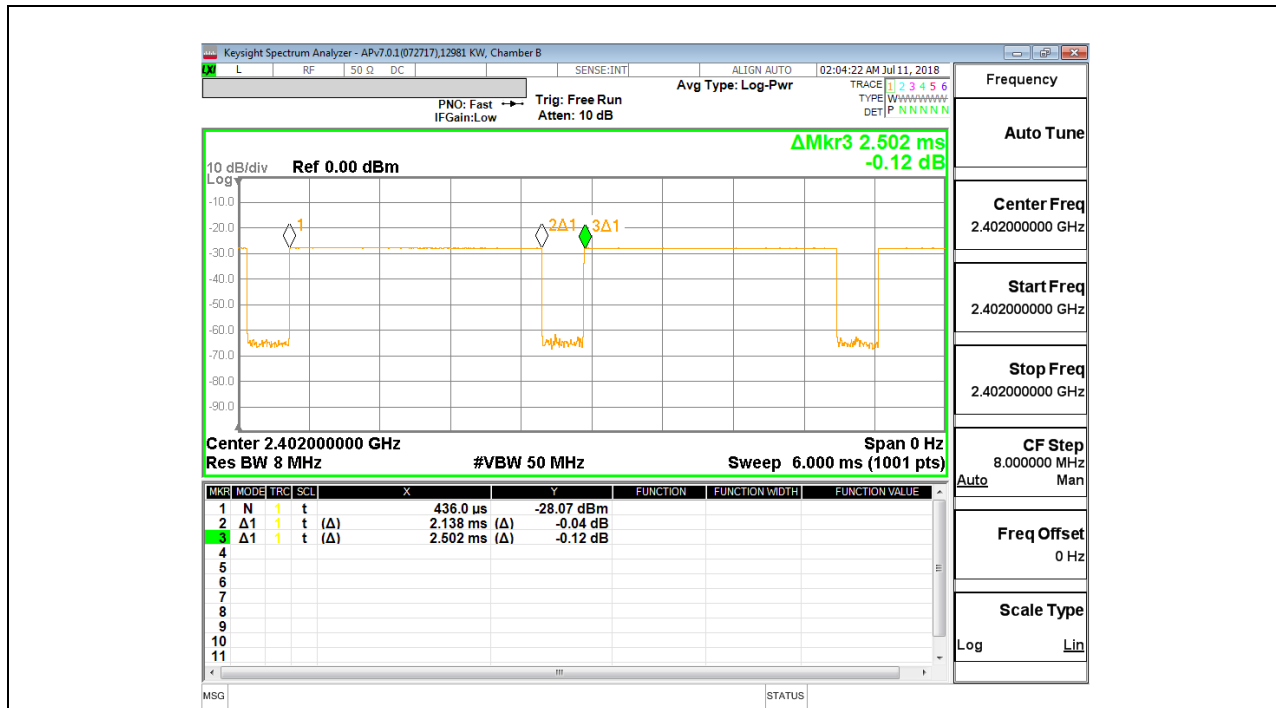

BLE (1Mbps)



BLE (2Mbps)

8.2. 99% BANDWIDTH

LIMITS

None; for reporting purposes only.

RESULTS

8.2.1. BLE (1Mbps)

Channel	Frequency (MHz)	99% Bandwidth (MHz)
Low	2402	1.0337
Middle	2440	1.0359
High	2480	1.0317

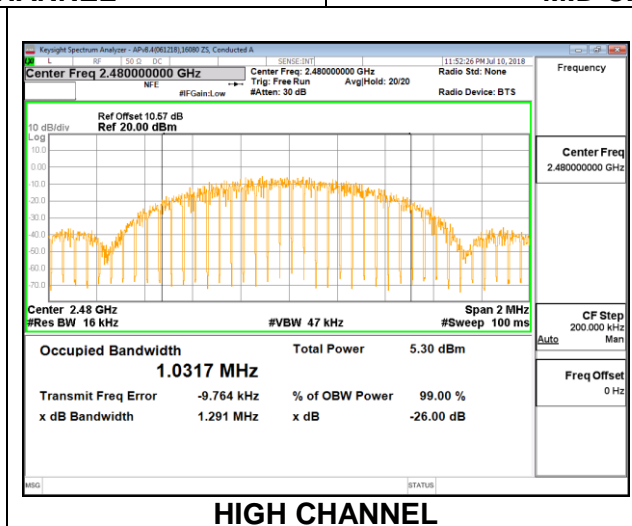
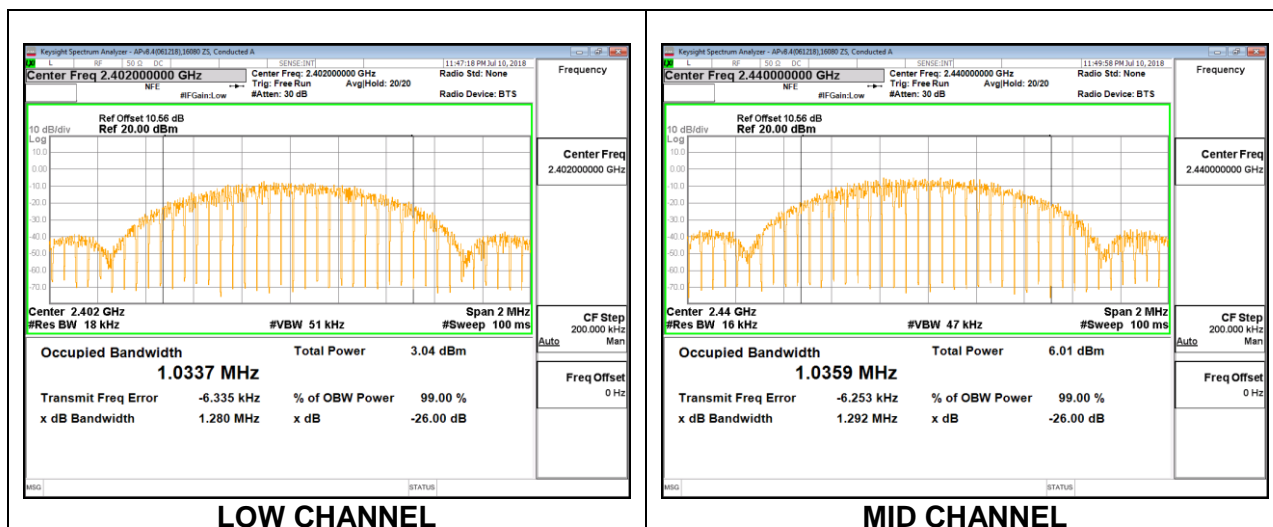

8.2.2. BLE (2Mbps)

Channel	Frequency (MHz)	99% Bandwidth (MHz)
Low	2402	2.0608
Middle	2440	2.0585
High	2480	2.0638

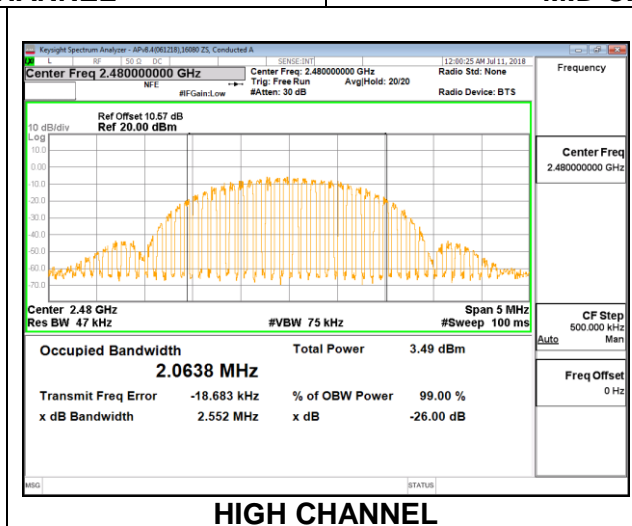
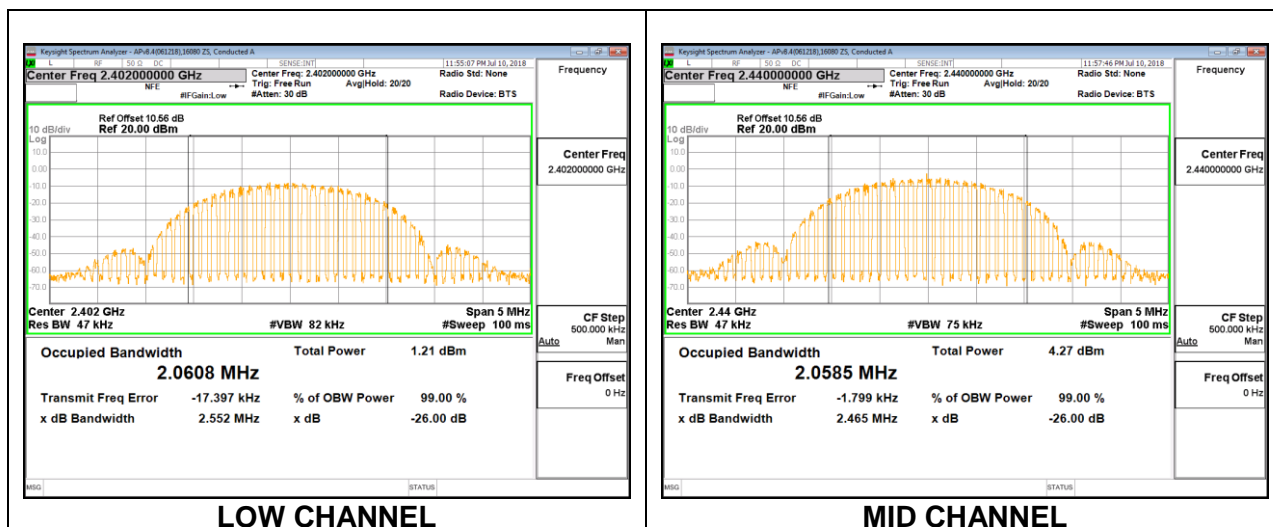

8.3. 6 dB BANDWIDTH

LIMITS

FCC §15.407 (e)

The minimum 6 dB bandwidth shall be at least 500 kHz.

RESULTS

8.3.1. BLE (1Mbps)

Channel	Frequency (MHz)	6 dB Bandwidth (MHz)	Minimum Limit (MHz)
Low	2402	0.714	0.5
Middle	2440	0.711	0.5
High	2480	0.702	0.5

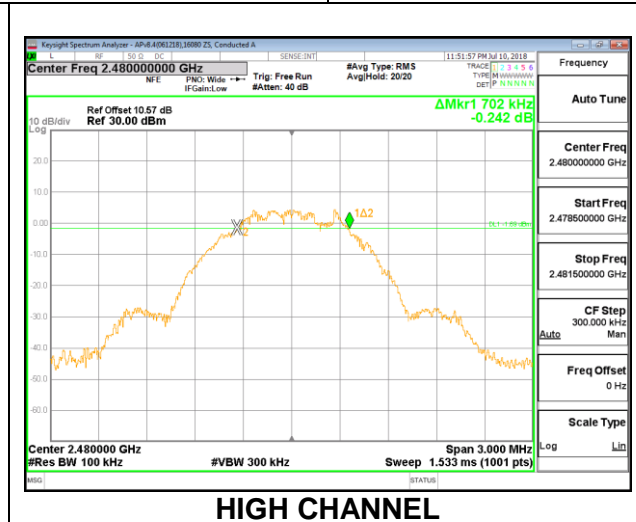
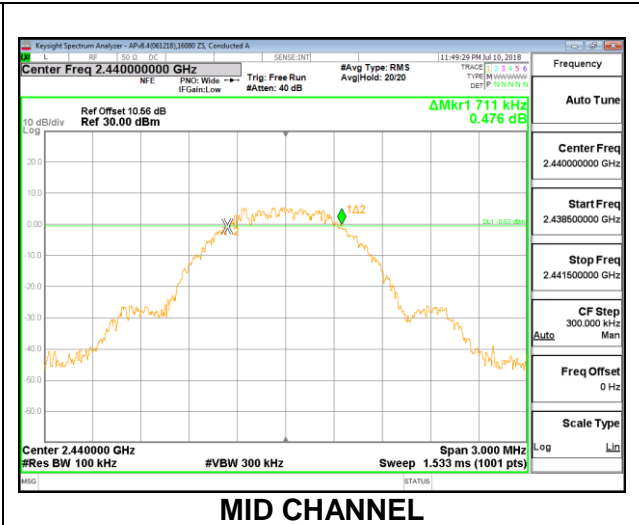
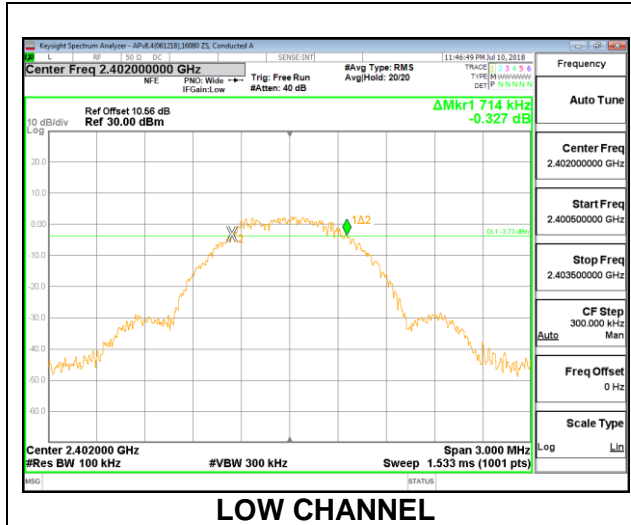

8.3.2. BLE (2Mbps)

Channel	Frequency (MHz)	6 dB Bandwidth (MHz)	Minimum Limit (MHz)
Low	2402	1.275	0.5
Middle	2440	1.209	0.5
High	2480	1.197	0.5

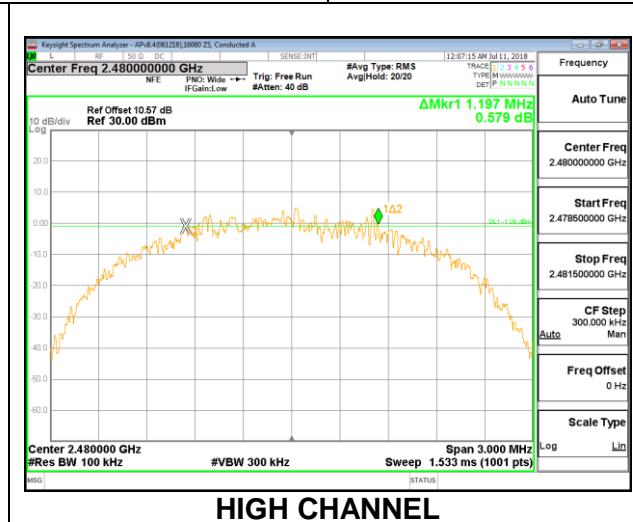
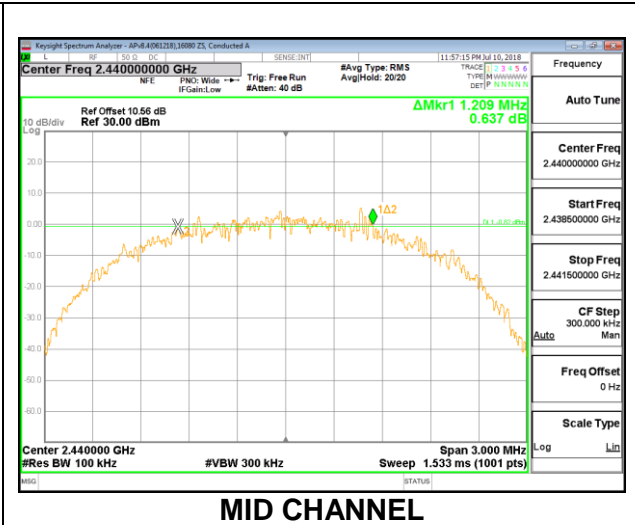
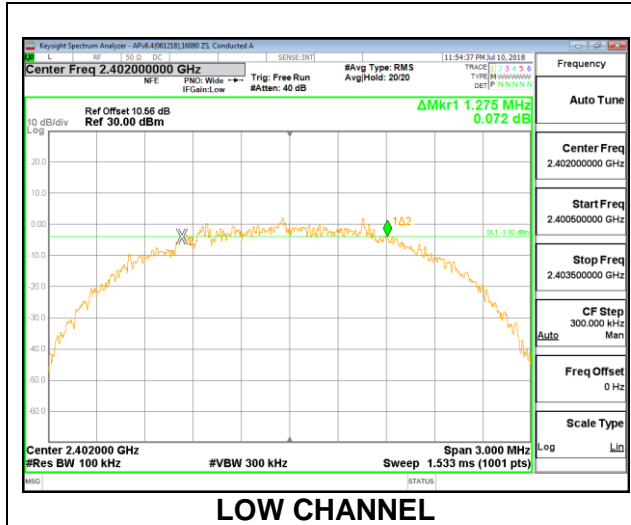

8.4. OUTPUT POWER

LIMITS

FCC §15.247 (b) (3)

The maximum antenna gain is less than or equal to 6 dBi, therefore the limit is 30 dBm.

TEST PROCEDURE

The transmitter output is connected to a power meter. The cable assembly insertion loss was entered as an offset in the power meter to allow for a gated peak reading of power.

RESULTS

8.4.1. BLE (1Mbps)

Tested By:	GE43578
Date:	7/7/2018

Channel	Frequency (MHz)	Peak Power Reading (dBm)	Limit (dBm)	Margin (dB)
Low	2402	4.18	30	-25.820
Middle	2440	5.46	30	-24.540
High	2480	5.13	30	-24.870

8.4.2. BLE (2Mbps)

Tested By:	GE43578
Date:	7/7/2018

Channel	Frequency (MHz)	Peak Power Reading (dBm)	Limit (dBm)	Margin (dB)
Low	2402	4.41	30	-25.590
Middle	2440	5.68	30	-24.320
High	2480	5.46	30	-24.540

8.5. AVERAGE POWER

LIMITS

None; for reporting purposes only.

TEST PROCEDURE

The transmitter output is connected to a power meter. The cable assembly insertion loss was entered as an offset in the power meter to allow for a gated average reading of power.

RESULTS

8.5.1. BLE (1Mbps)

Tested By:	GE43578
Date:	7/7/2018

Channel	Frequency (MHz)	AV power (dBm)
Low	2402	3.95
Middle	2440	5.20
High	2480	4.94

8.5.2. BLE (2Mbps)

Tested By:	GE43578
Date:	7/7/2018

Channel	Frequency (MHz)	AV power (dBm)
Low	2402	3.92
Middle	2440	5.18
High	2480	4.94

8.6. POWER SPECTRAL DENSITY

LIMITS

FCC §15.247 (e)

The power spectral density conducted from the transmitter to the antenna shall not be greater than 8 dBm in any 3 kHz band during any time interval of continuous transmission.

RESULTS

8.6.1. BLE (1Mbps)

Channel	Frequency (MHz)	PSD (dBm/3kHz)	Limit (dBm/3kHz)	Margin (dB)
Low	2402	-12.578	8	-20.578
Middle	2440	-9.619	8	-17.619
High	2480	-10.310	8	-18.310

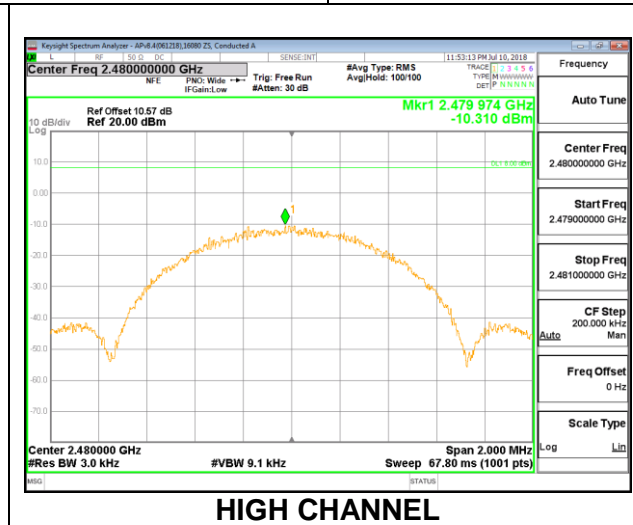
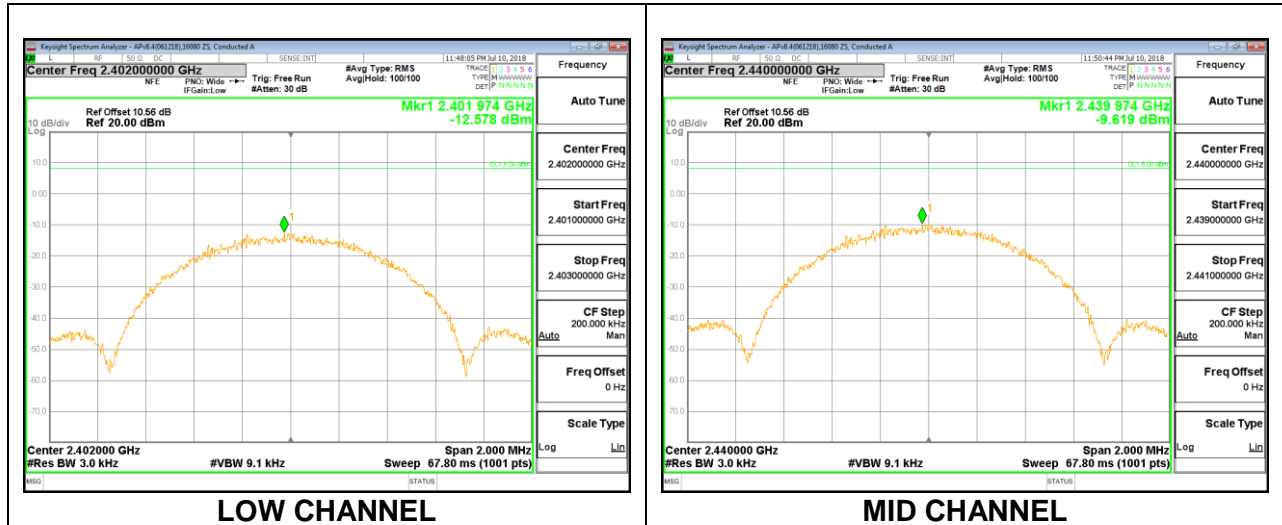

8.6.2. BLE (2Mbps)

Channel	Frequency (MHz)	PSD (dBm/3kHz)	Limit (dBm/3kHz)	Margin (dB)
Low	2402	-15.301	8	-23.301
Middle	2440	-12.114	8	-20.114
High	2480	-12.898	8	-20.898

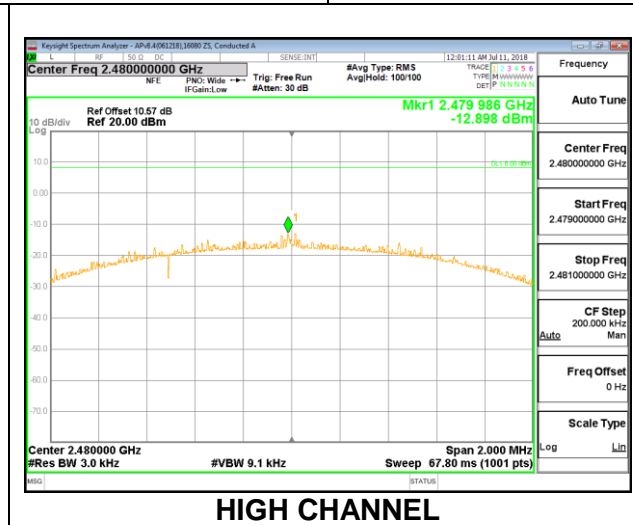
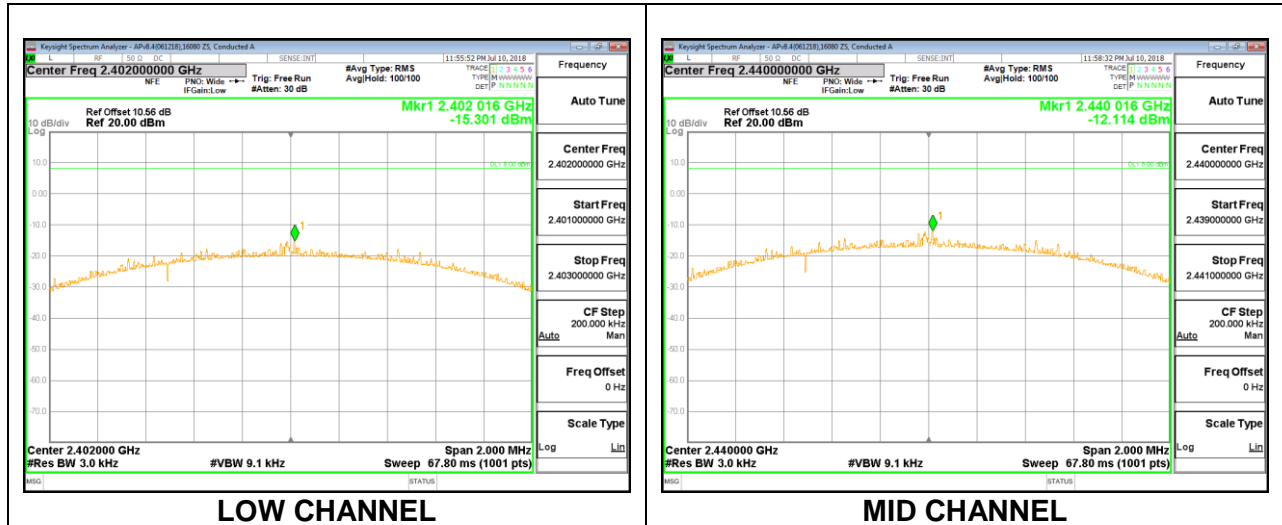

8.7. CONDUCTED SPURIOUS EMISSIONS

LIMITS

FCC §15.247 (d)

Output power was measured based on the use of a peak measurement, therefore the required attenuation is 20 dB.

RESULTS

8.7.1. BLE (1Mbps)

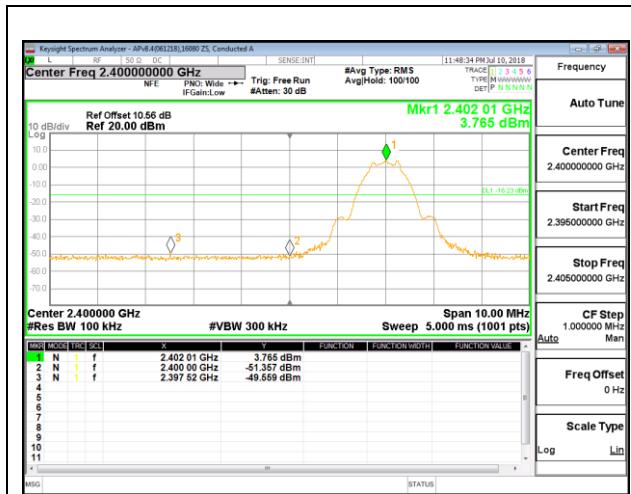

LOW CHANNEL BANDEDGE

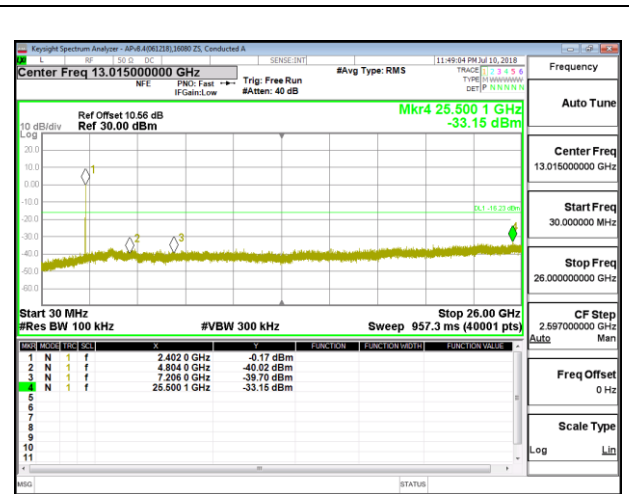

OUT-OF-BAND LOW CHANNEL

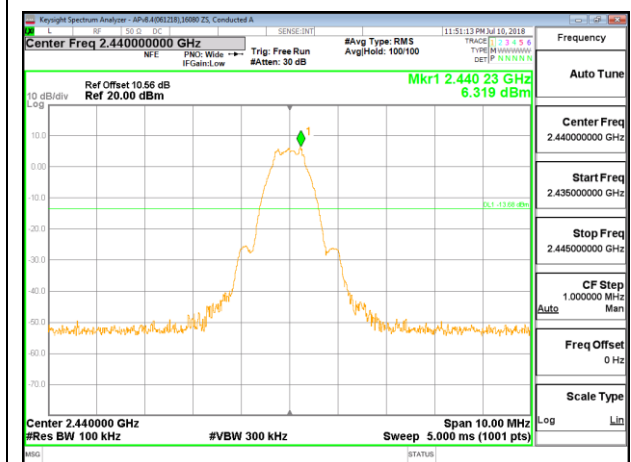

IN-BAND REFERENCE LEVEL

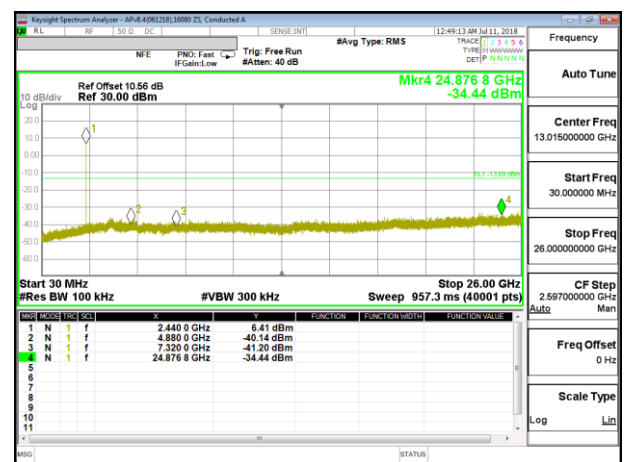

OUT-OF-BAND MID CHANNEL

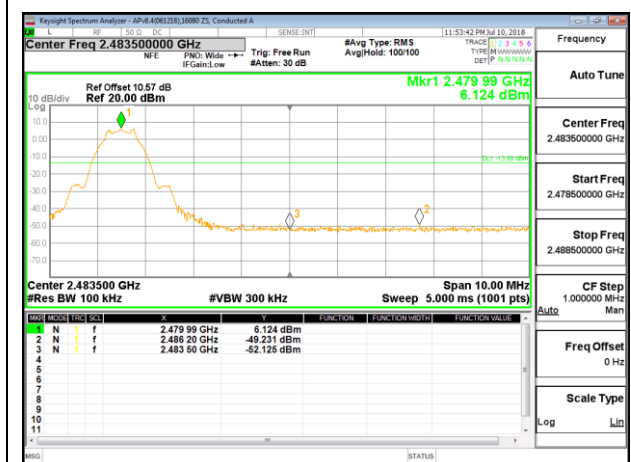

HIGH CHANNEL BANDEDGE

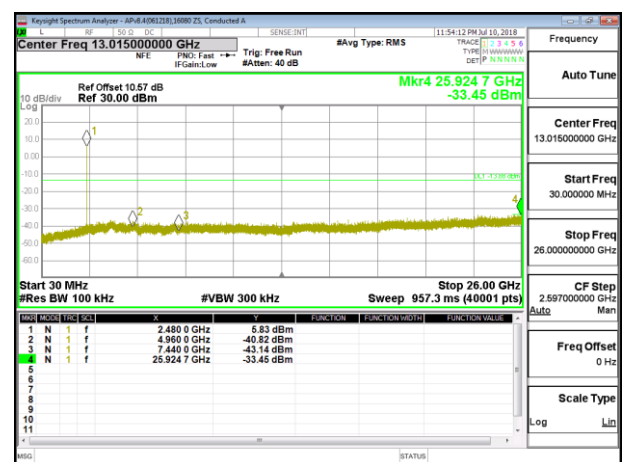

OUT-OF-BAND HIGH CHANNEL

8.7.2. BLE (2Mbps)

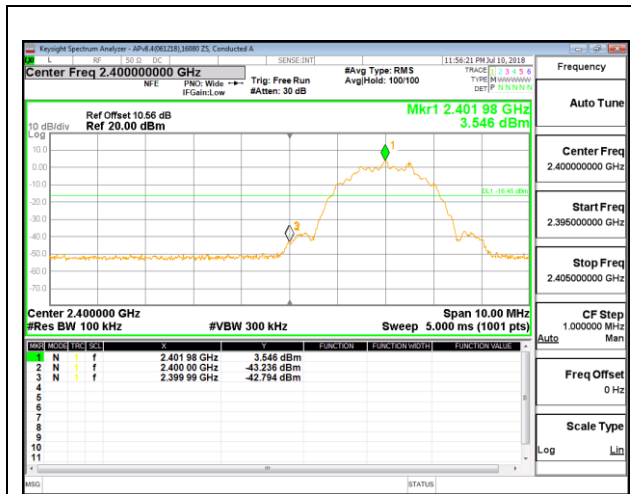

LOW CHANNEL BANDEDGE

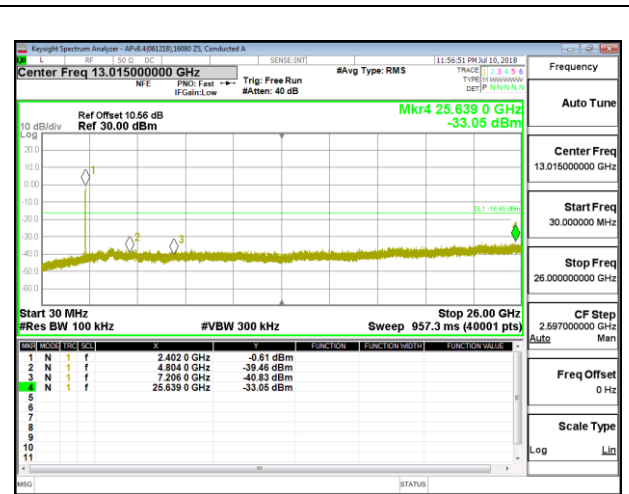

OUT-OF-BAND LOW CHANNEL

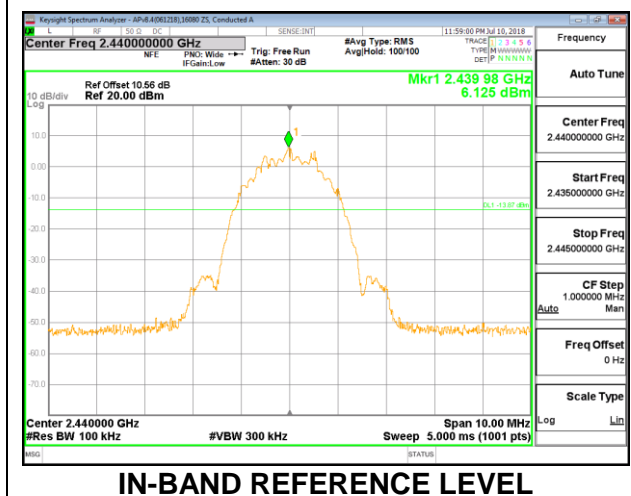

IN-BAND REFERENCE LEVEL

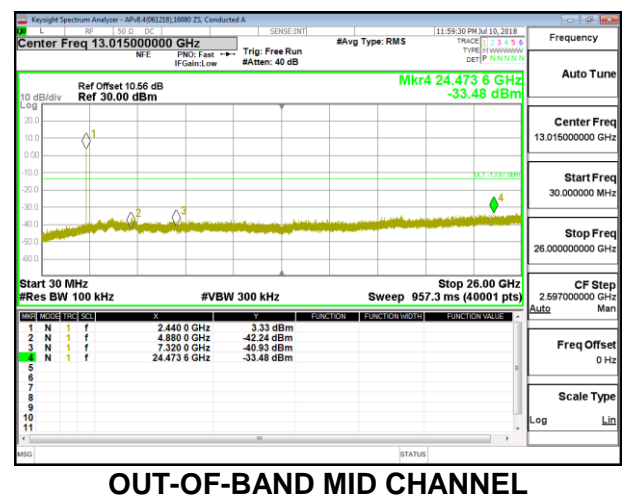

OUT-OF-BAND MID CHANNEL

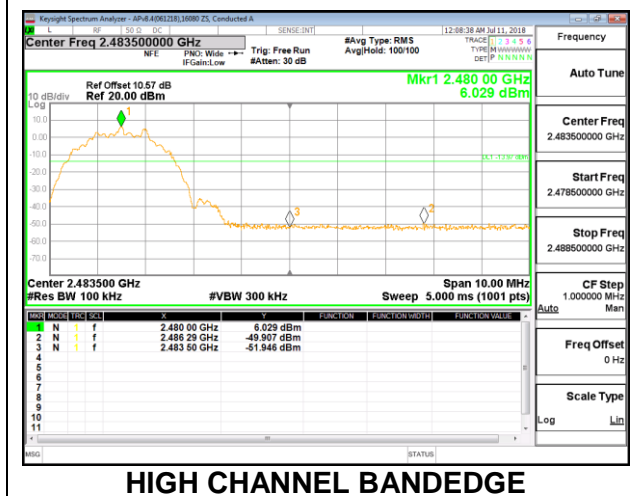

HIGH CHANNEL BANDEDGE

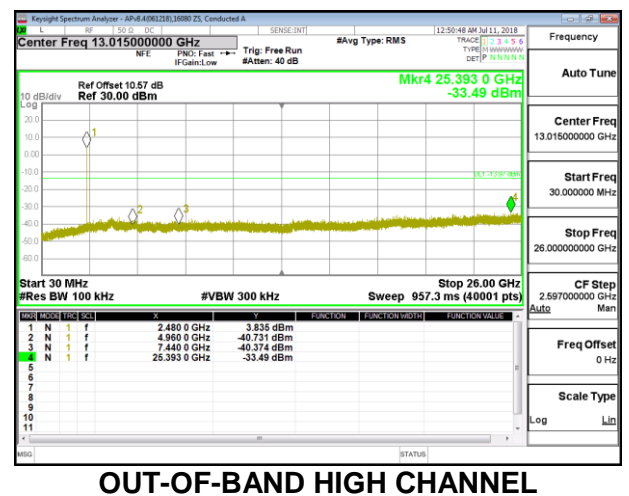

OUT-OF-BAND HIGH CHANNEL

9. RADIATED TEST RESULTS

9.1. LIMITS AND PROCEDURE

LIMITS

FCC §15.205 and §15.209

Frequency Range (MHz)	Field Strength Limit (uV/m) at 3 m	Field Strength Limit (dBuV/m) at 3 m
0.009-0.490	2400/F(kHz) @ 300 m	-
0.490-1.705	24000/F(kHz) @ 30 m	-
1.705 - 30	30 @ 30m	-
30 - 88	100	40
88 - 216	150	43.5
216 - 960	200	46
Above 960	500	54

TEST PROCEDURE

The EUT is placed on a non-conducting table 80 cm above the ground plane for measurement below 1GHz; 1.5 m above the ground plane for measurement above 1GHz. The antenna to EUT distance is 3 meters. The EUT is configured in accordance with ANSI C63.10. The EUT is set to transmit in a continuous mode.

For measurements below 1 GHz the resolution bandwidth is set to 100 kHz for peak detection measurements or 120 kHz for quasi-peak detection measurements. Peak detection is used unless otherwise noted as quasi-peak.

For pre-scans above 1 GHz the resolution bandwidth is set to 1 MHz; the video bandwidth is set to 30 KHz for peak measurements.

For final measurements above 1 GHz the resolution bandwidth is set to 1 MHz; the video bandwidth is set to 3 MHz for peak measurements and as applicable for average measurements.

The spectrum from 1 GHz to 18 GHz is investigated with the transmitter set to the lowest, middle, and highest channels in each applicable band. Below 1GHz and above 18GHz emissions, the channel with the highest output power was tested.

The frequency range of interest is monitored at a fixed antenna height and EUT azimuth. The EUT is rotated through 360 degrees to maximize emissions received. The antenna is scanned from 1 to 4 meters above the ground plane to further maximize the emission. Measurements are made with the antenna polarized in both the vertical and the horizontal positions.

9.2. TRANSMITTER ABOVE 1 GHz

9.2.1. BLE (1Mbps)

BANDEDGE (LOW CHANNEL)

HORIZONTAL RESULT

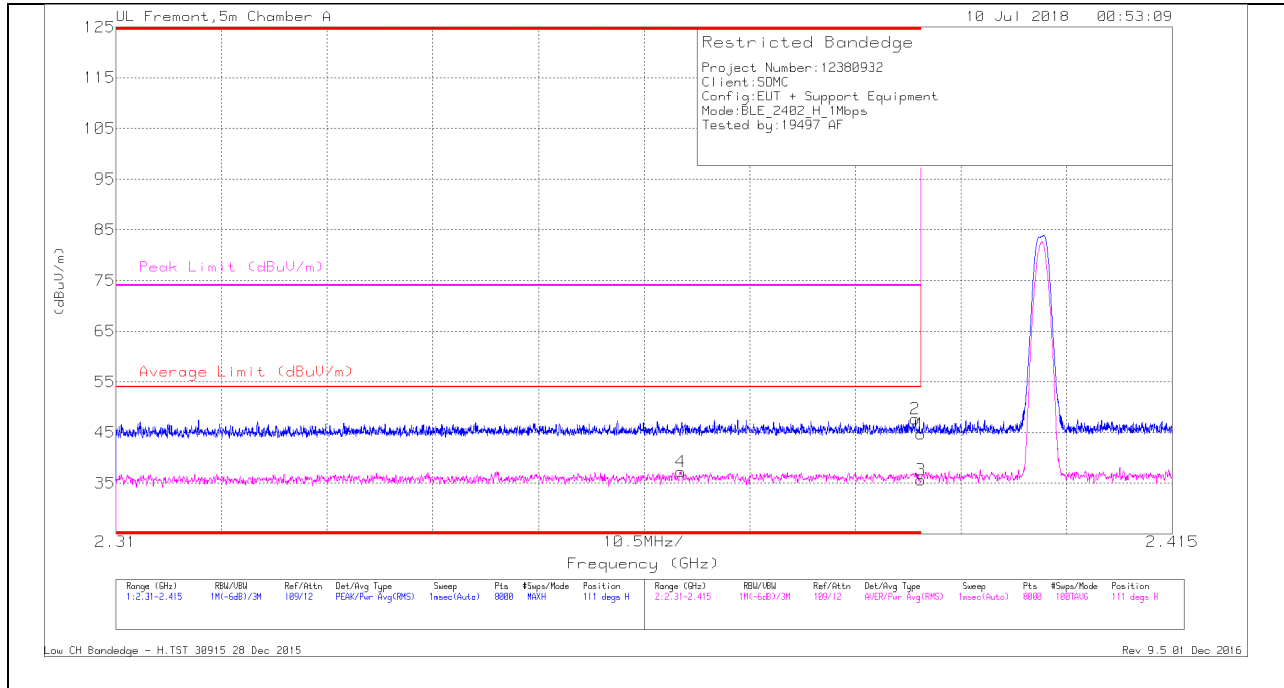

Trace Markers

Marker	Frequency (GHz)	Meter Reading (dBuV)	Det	AF T345 (dB/m)	Amp/Cbl/Filtr/Pad (dB)	DC Corr (dB)	Corrected Reading (dBuV/m)	Average Limit (dBuV/m)	Margin (dB)	Peak Limit (dBuV/m)	PK Margin (dB)	Azimuth (Degs)	Height (cm)	Polarity
1	* 2.39	35.9	Pk	31.8	-23	0	44.7	-	-	74	-29.3	111	153	H
2	* 2.389	38.85	Pk	31.8	-23	0	47.65	-	-	74	-26.35	111	153	H
3	* 2.39	26.11	RMS	31.8	-23	.68	35.59	54	-18.41	-	-	111	153	H
4	* 2.366	28.02	RMS	31.6	-23	.68	37.3	54	-16.7	-	-	111	153	H

* - indicates frequency in CFR47 Pt 15 Restricted Band

Pk - Peak detector

RMS - RMS detection

VERTICAL RESULT

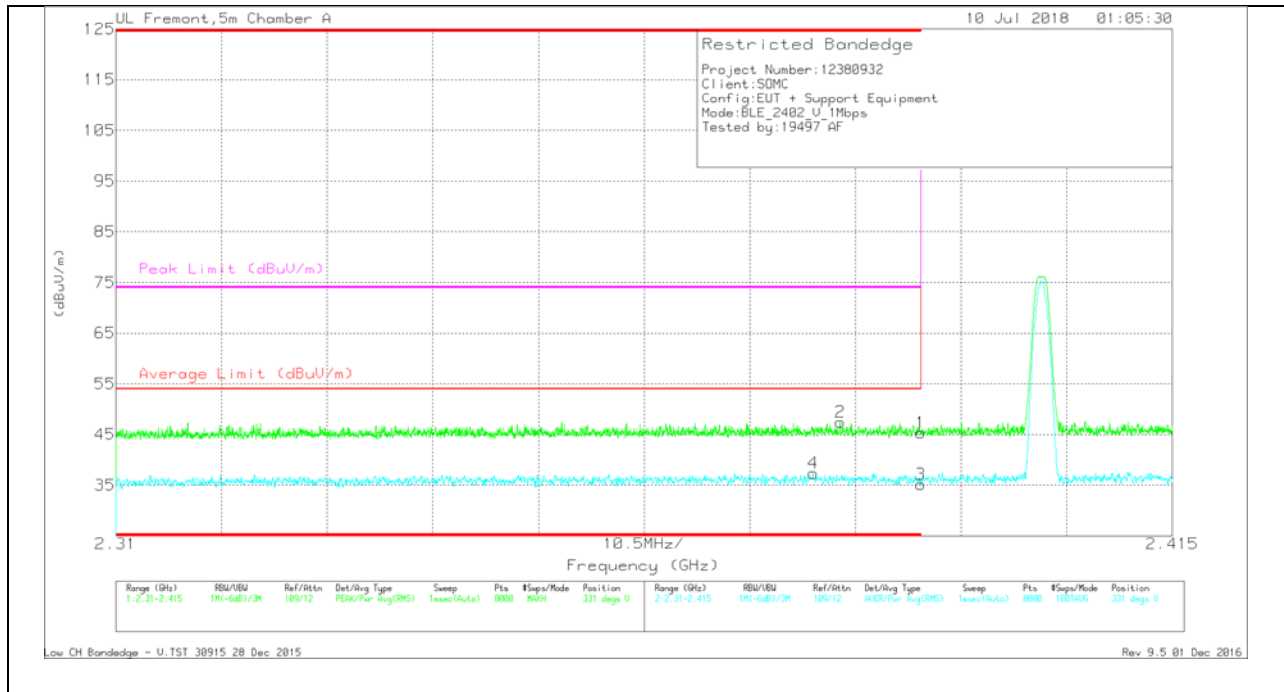

Trace Markers

Marker	Frequency (GHz)	Meter Reading (dBuV)	Det	AF T345 (dB/m)	Amp/Cbl/Filtr/Pad (dB)	DC Corr (dB)	Corrected Reading (dBuV/m)	Average Limit (dBuV/m)	Margin (dB)	Peak Limit (dBuV/m)	PK Margin (dB)	Azimuth (Degs)	Height (cm)	Polarity
1	* 2.39	36.47	Pk	31.8	-23	0	45.27	-	-	74	-28.73	331	173	V
2	* 2.382	38.75	Pk	31.7	-23	0	47.45	-	-	74	-26.55	331	173	V
3	* 2.39	25.68	RMS	31.8	-23	.68	35.16	54	-18.84	-	-	331	173	V
4	* 2.379	27.94	RMS	31.7	-23	.68	37.32	54	-16.68	-	-	331	173	V

* - indicates frequency in CFR47 Pt 15 Restricted Band

Pk - Peak detector

RMS - RMS detection

BANDEDGE (HIGH CHANNEL)

HORIZONTAL RESULT

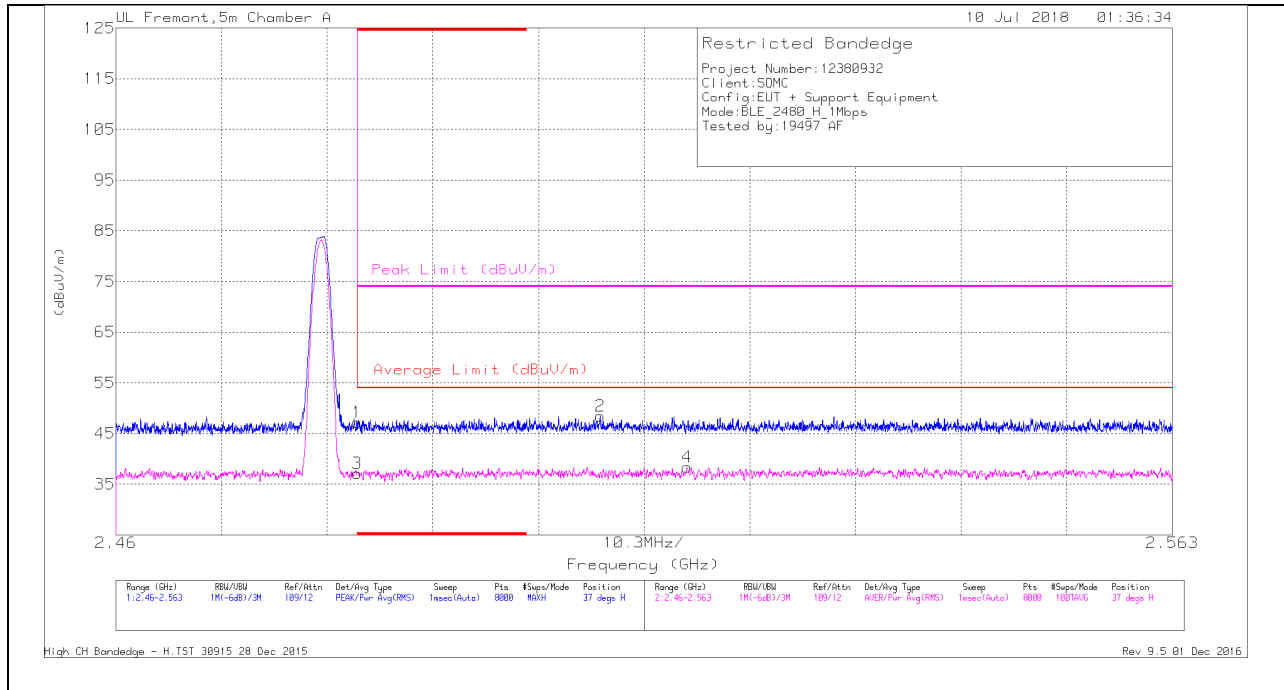

Trace Markers

Marker	Frequency (GHz)	Meter Reading (dBuV)	Det	AFT345 (dB/m)	Amp/Cbl/Filtr/Pad (dB)	DC Corr (dB)	Corrected Reading (dBuV/m)	Average Limit (dBuV/m)	Margin (dB)	Peak Limit (dBuV/m)	PK Margin (dB)	Azimuth (Degs)	Height (cm)	Polarity
1	* 2.484	37.82	Pk	32.3	-22.9	0	47.22	-	-	74	-26.78	37	189	H
3	* 2.484	27	RMS	32.3	-22.9	.68	37.08	54	-16.92	-	-	37	189	H
2	2.507	38.91	Pk	32.4	-22.9	0	48.41	-	-	74	-25.59	37	189	H
4	2.516	28.24	RMS	32.4	-22.9	.68	38.42	54	-15.58	-	-	37	189	H

* - indicates frequency in CFR47 Pt 15 Restricted Band

Pk - Peak detector

RMS - RMS detection

VERTICAL RESULT

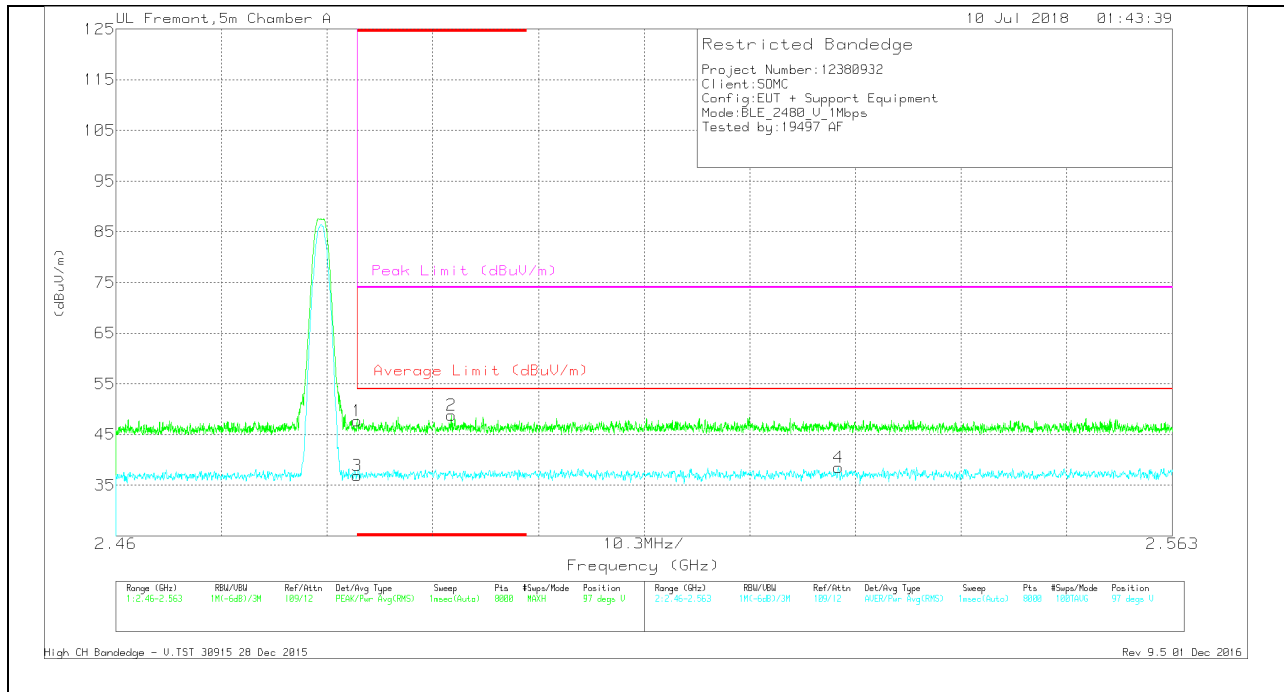

Trace Markers

Marker	Frequency (GHz)	Meter Reading (dBuV)	Det	AF T345 (dB/m)	Amp/Cbl/Filtr/Pad (dB)	DC Corr (dB)	Corrected Reading (dBuV/m)	Average Limit (dBuV/m)	Margin (dB)	Peak Limit (dBuV/m)	PK Margin (dB)	Azimuth (Degs)	Height (cm)	Polarity
1	* 2.484	38.25	Pk	32.3	-22.9	0	47.65	-	-	74	-26.35	97	259	V
2	* 2.493	39.34	Pk	32.4	-22.9	0	48.84	-	-	74	-25.16	97	259	V
3	* 2.484	26.84	RMS	32.3	-22.9	.68	36.92	54	-17.08	-	-	97	259	V
4	2.53	28.22	RMS	32.4	-22.8	.68	38.5	54	-15.5	-	-	97	259	V

* - indicates frequency in CFR47 Pt 15 Restricted Band

Pk - Peak detector

RMS - RMS detection

HARMONICS AND SPURIOUS EMISSIONS

LOW CHANNEL RESULTS

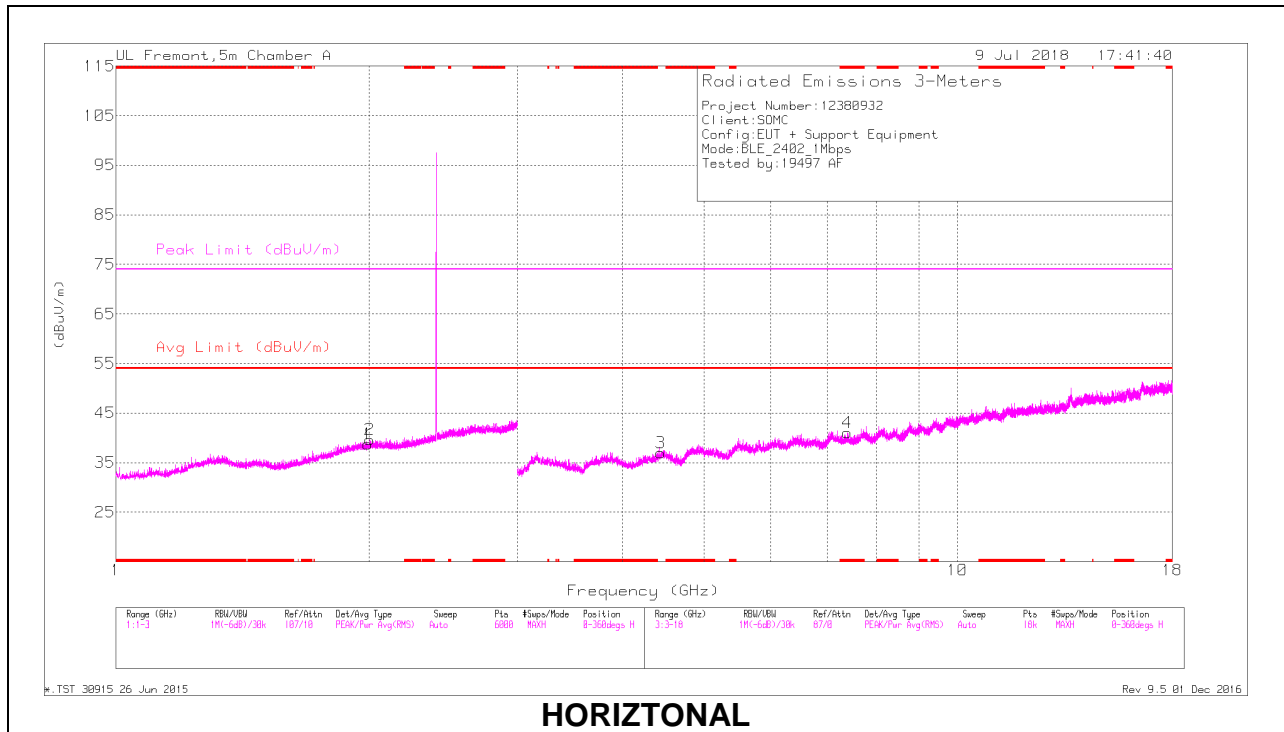

HORIZONTAL

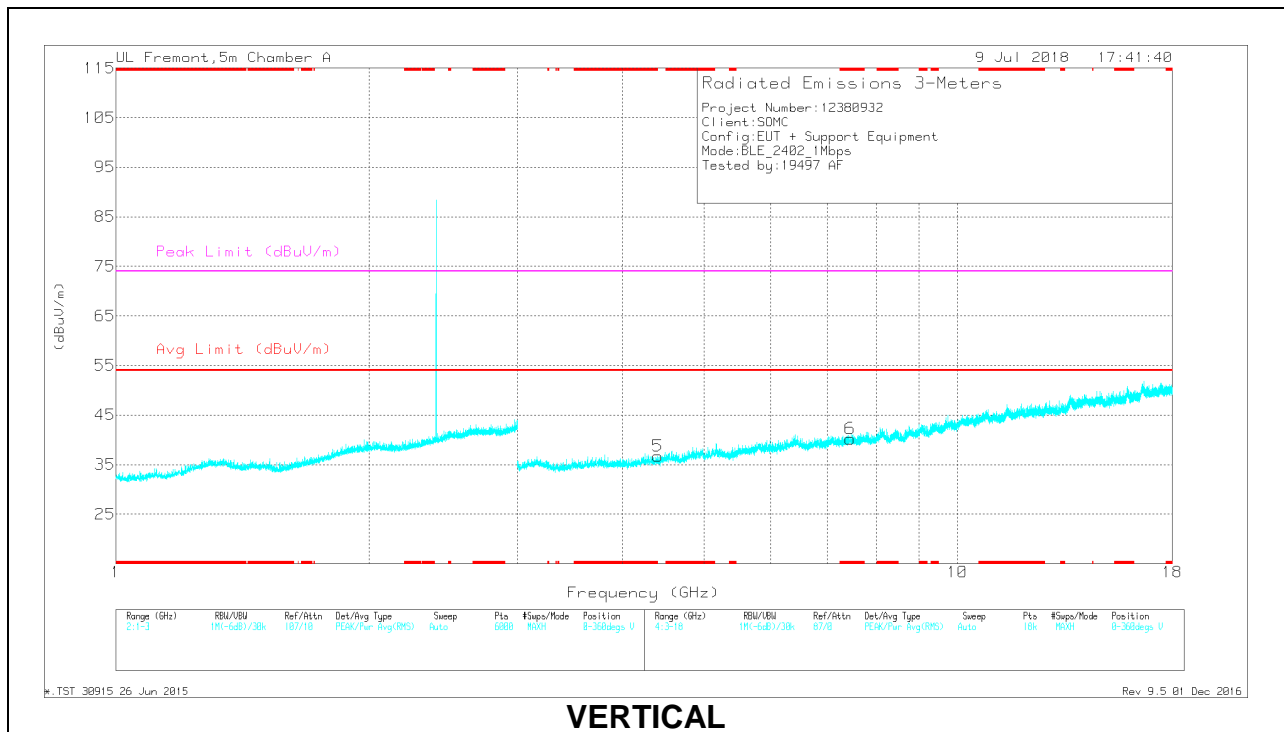

VERTICAL

RADIATED EMISSIONS

Radiated Emissions

Marker	Frequency (GHz)	Meter Reading (dBuV)	Det	AF T345 (dB/m)	Amp/Cbl/Filtr/Pad (dB)	DC Corr (dB)	Corrected Reading (dBuV/m)	Avg Limit (dBuV/m)	Margin (dB)	Peak Limit (dBuV/m)	PK Margin (dB)	Azimuth (Degs)	Height (cm)	Polarity
4	* 7.404	33.01	PK2	35.6	-21.9	0	46.71	-	-	74	-27.29	5	292	H
	* 7.404	21.05	MAv1	35.6	-21.9	.68	35.43	54	-18.57	-	-	5	292	H
6	* 7.456	32.95	PK2	35.6	-21.8	0	46.75	-	-	74	-27.25	355	274	V
	* 7.454	20.94	MAv1	35.6	-21.8	.68	35.42	54	-18.58	-	-	355	274	V
1	1.992	36.56	PK2	31.4	-23	0	44.96	-	-	-	-	96	190	H
2	2.004	36.93	PK2	31.4	-23	0	45.33	-	-	-	-	53	265	H
5	4.407	36.93	PK2	33.7	-27.7	0	42.93	-	-	-	-	72	223	V
3	4.438	36.55	PK2	33.7	-27.4	0	42.85	-	-	-	-	328	215	H

* - indicates frequency in CFR47 Pt 15 Restricted Band

PK2 - KDB558074 Method: Maximum Peak

MAv1 - KDB558074 Option 1 Maximum RMS Average

MID CHANNEL RESULTS

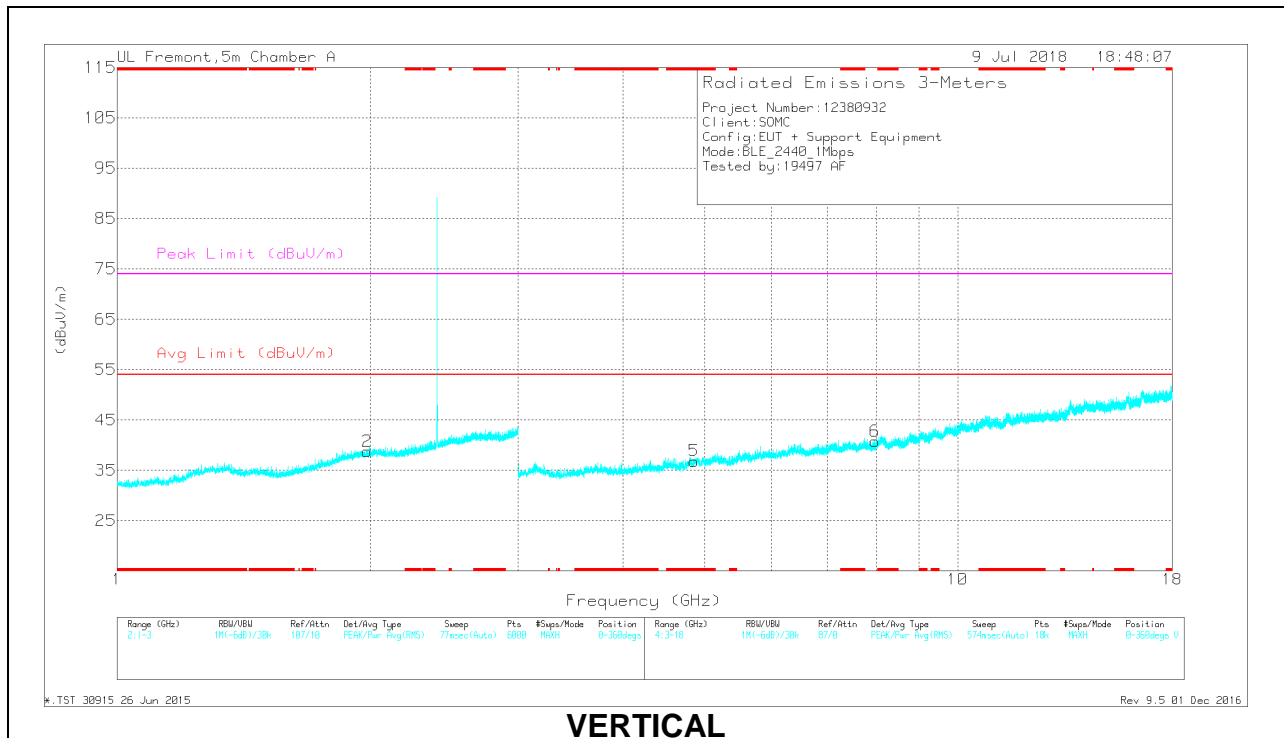
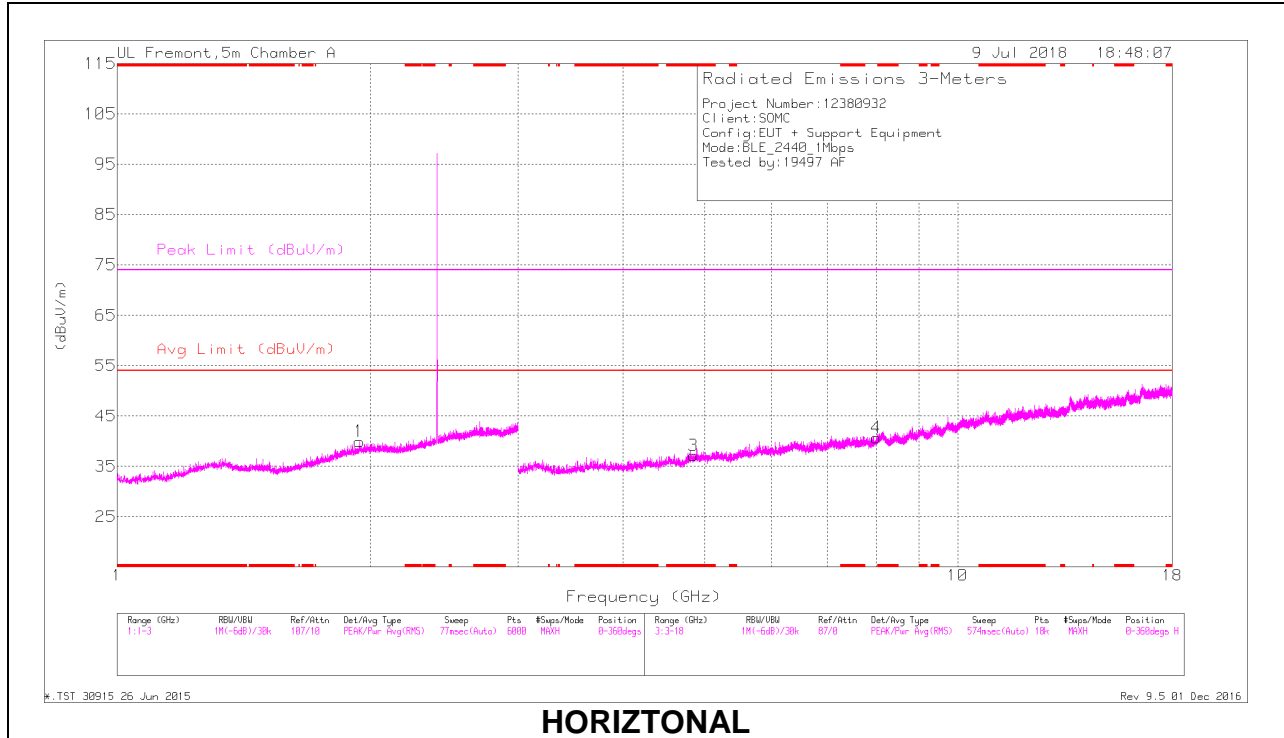

RADIATED EMISSIONS

Radiated Emissions

Marker	Frequency (GHz)	Meter Reading (dBuV)	Det	AF T345 (dB/m)	Amp/Cbl/Filtr/Pad (dB)	DC Corr (dB)	Corrected Reading (dBuV/m)	Avg Limit (dBuV/m)	Margin (dB)	Peak Limit (dBuV/m)	PK Margin (dB)	Azimuth (Degs)	Height (cm)	Polarity
3	* 4.846	35.38	PK2	34.2	-25.6	0	43.98	-	-	74	-30.02	44	155	H
	* 4.848	23.75	MAv1	34.2	-25.6	.68	33.03	54	-20.97	-	-	44	155	H
5	* 4.854	35.13	PK2	34.1	-25.7	0	43.53	-	-	74	-30.47	84	231	V
	* 4.855	23.92	MAv1	34.1	-25.7	.68	33	54	-21	-	-	84	231	V
1	1.942	36.04	PK2	31.3	-22.9	0	44.44	-	-	-	-	5	154	H
2	1.983	36.27	PK2	31.4	-23	0	44.67	-	-	-	-	140	264	V
6	7.969	32.77	PK2	35.8	-22.4	0	46.17	-	-	-	-	355	181	V
4	8.005	33.05	PK2	35.8	-22.1	0	46.75	-	-	-	-	280	145	H

* - indicates frequency in CFR47 Pt 15 Restricted Band

PK2 - KDB558074 Method: Maximum Peak

MAv1 - KDB558074 Option 1 Maximum RMS Average

HIGH CHANNEL RESULTS

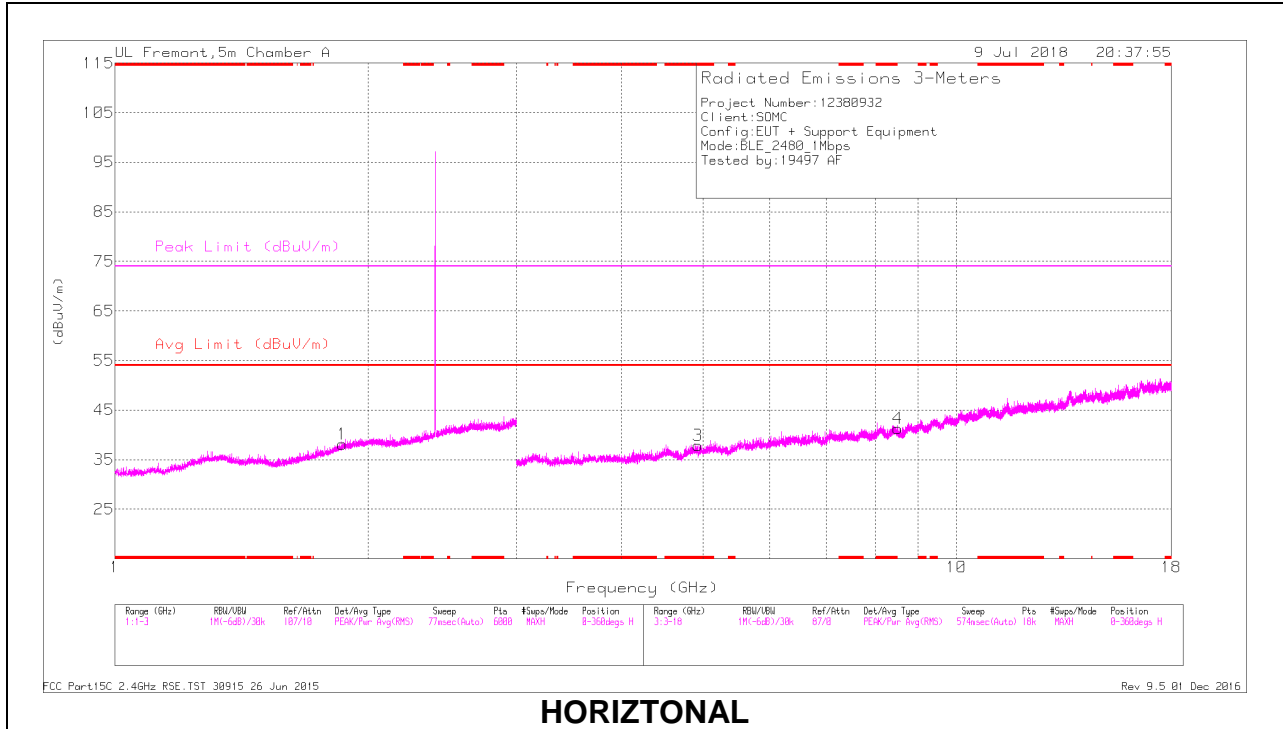

HORIZONTAL

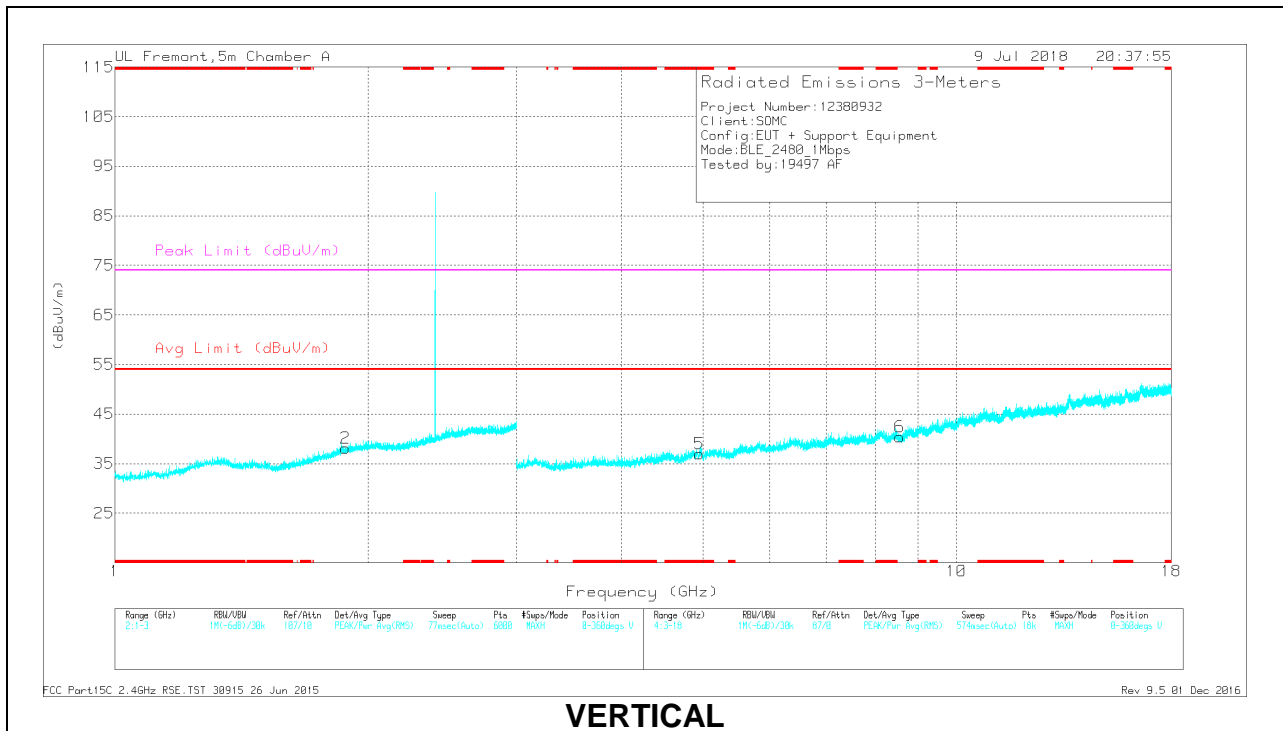

VERTICAL

RADIATED EMISSIONS

Radiated Emissions

Marker	Frequency (GHz)	Meter Reading (dBuV)	Det	AF T345 (dB/m)	Amp/Cbl/Filtr/Pad (dB)	DC Corr (dB)	Corrected Reading (dBuV/m)	Avg Limit (dBuV/m)	Margin (dB)	Peak Limit (dBuV/m)	PK Margin (dB)	Azimuth (Degs)	Height (cm)	Polarity
3	* 4.925	35.81	PK2	34.2	-26.4	0	43.61	-	-	74	-30.39	181	236	H
	* 4.927	24.43	MAv1	34.2	-26.5	.68	32.81	54	-21.19	-	-	181	236	H
5	* 4.943	35.98	PK2	34.2	-26.5	0	43.68	-	-	74	-30.32	133	140	V
	* 4.945	24.66	MAv1	34.2	-26.5	.68	33.04	54	-20.96	-	-	133	140	V
1	1.862	36.19	PK2	30.9	-22.9	0	44.19	-	-	-	-	145	211	H
2	1.88	36.05	PK2	31	-22.9	0	44.15	-	-	-	-	291	280	V
4	8.514	33.22	PK2	35.8	-21.3	0	47.72	-	-	-	-	330	389	H
6	8.564	33.32	PK2	35.8	-21.7	0	47.42	-	-	-	-	89	207	V

* - indicates frequency in CFR47 Pt 15 Restricted Band

PK2 - KDB558074 Method: Maximum Peak

MAv1 - KDB558074 Option 1 Maximum RMS Average

9.2.2. BLE (2Mbps)

**BANDEDGE (LOW CHANNEL)
 HORIZONTAL RESULT**

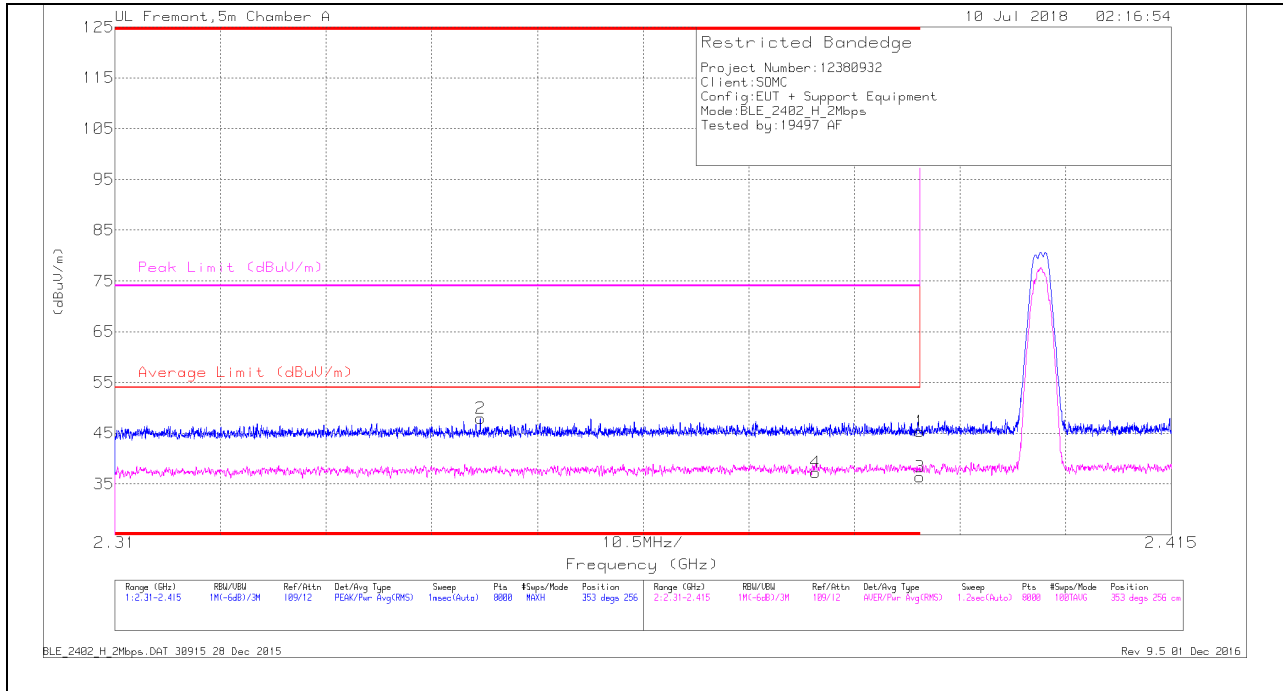

Trace Markers

Marker	Frequency (GHz)	Meter Reading (dBuV)	Det	AF T345 (dB/m)	Amp/Cbl/Filtr/Pad (dB)	DC Corr (dB)	Corrected Reading (dBuV/m)	Average Limit (dBuV/m)	Margin (dB)	Peak Limit (dBuV/m)	PK Margin (dB)	Azimuth (Degs)	Height (cm)	Polarity
1	* 2.39	36.53	Pk	31.8	-23	0	45.33	-	-	74	-28.67	353	256	H
2	* 2.346	39.32	Pk	31.6	-23	0	47.92	-	-	74	-26.08	353	256	H
3	* 2.39	26.93	RMS	31.8	-23	2.4	38.13	54	-15.87	-	-	353	256	H
4	* 2.38	27.84	RMS	31.7	-23	2.4	38.94	54	-15.06	-	-	353	256	H

* - indicates frequency in CFR47 Pt 15 Restricted Band

Pk - Peak detector

RMS - RMS detection

VERTICAL RESULT

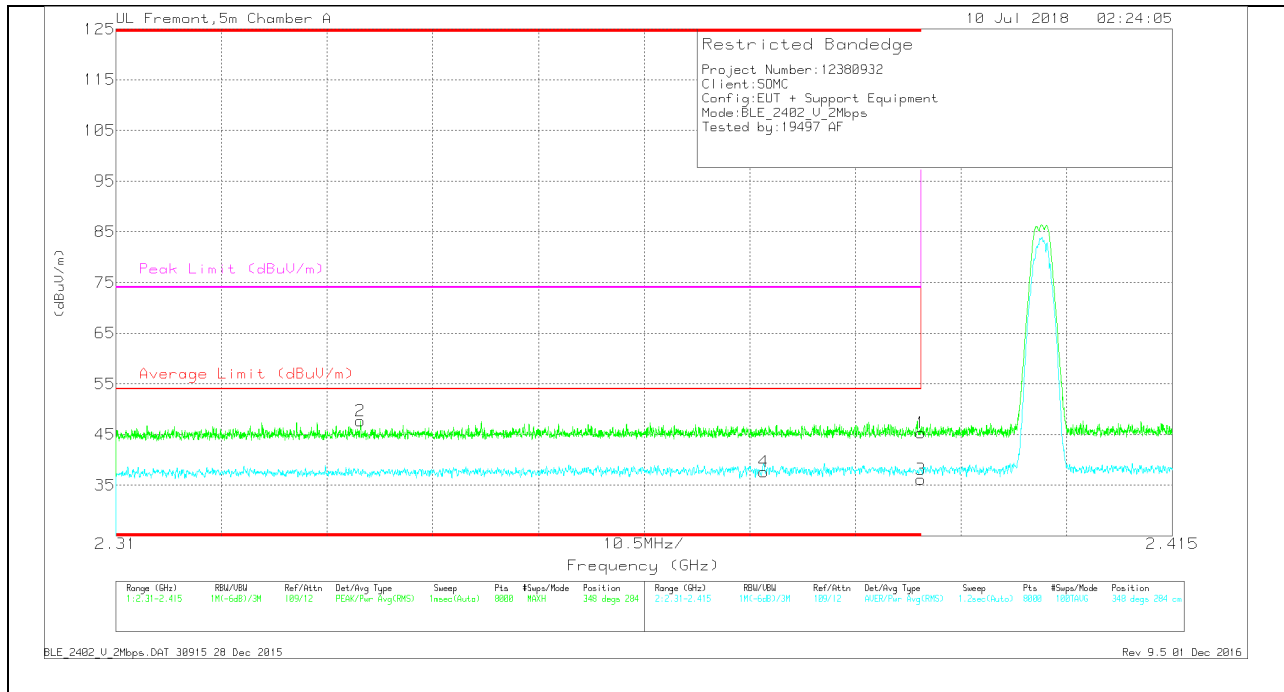

Trace Markers

Marker	Frequency (GHz)	Meter Reading (dBuV)	Det	AF T345 (dB/m)	Amp/Cbl/Filtr/Pad (dB)	DC Corr (dB)	Corrected Reading (dBuV/m)	Average Limit (dBuV/m)	Margin (dB)	Peak Limit (dBuV/m)	PK Margin (dB)	Azimuth (Degs)	Height (cm)	Polarity
1	* 2.39	36.49	Pk	31.8	-23	0	45.29	-	-	74	-28.71	348	284	V
2	* 2.334	39.14	Pk	31.6	-23	0	47.74	-	-	74	-26.26	348	284	V
3	* 2.39	26.65	RMS	31.8	-23	2.4	37.85	54	-16.15	-	-	348	284	V
4	* 2.374	28.25	RMS	31.7	-23	2.4	39.35	54	-14.65	-	-	348	284	V

* - indicates frequency in CFR47 Pt 15 Restricted Band

Pk - Peak detector

RMS - RMS detection

BANDEDGE (HIGH CHANNEL)

HORIZONTAL RESULT

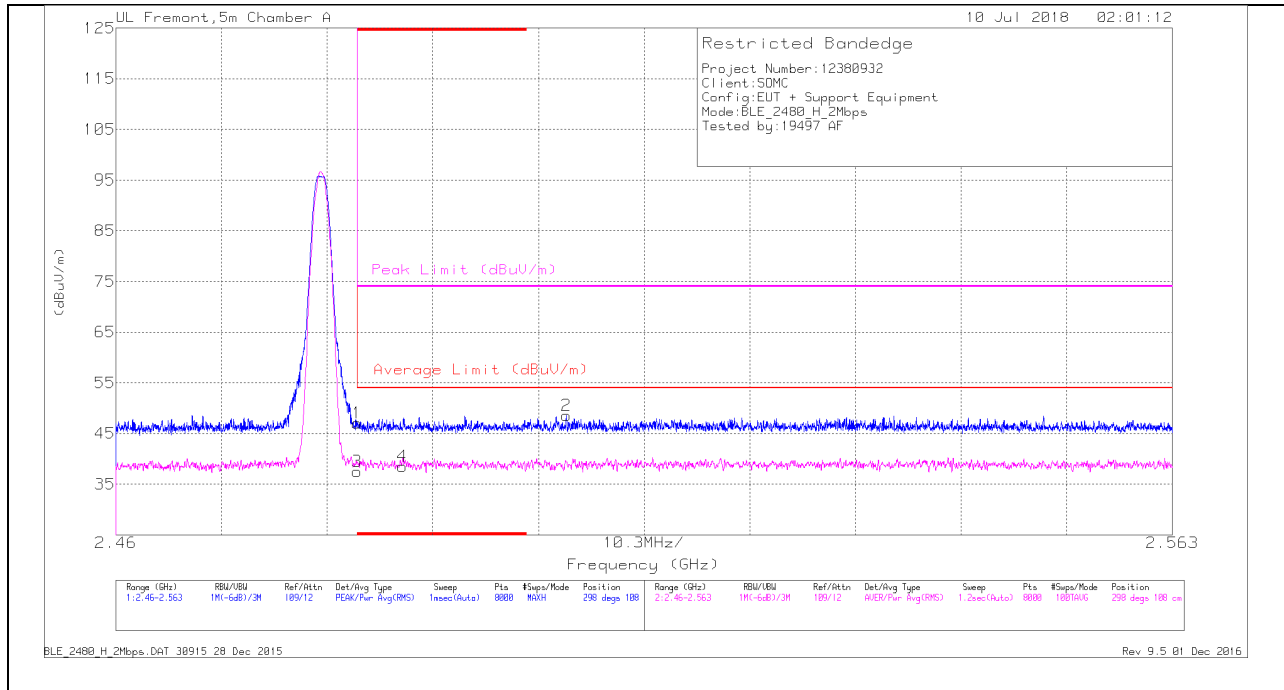

Trace Markers

Marker	Frequency (GHz)	Meter Reading (dBuV)	Det	AFT345 (dB/m)	Amp/Cbl/Filtr/Pad (dB)	DC Corr (dB)	Corrected Reading (dBuV/m)	Average Limit (dBuV/m)	Margin (dB)	Peak Limit (dBuV/m)	PK Margin (dB)	Azimuth (Degs)	Height (cm)	Polarity
1	* 2.484	37.64	Pk	32.3	-22.9	0	47.04	-	-	74	-26.96	298	108	H
3	* 2.484	27.46	RMS	32.3	-22.9	2.4	39.26	54	-14.74	-	-	298	108	H
4	* 2.488	28.41	RMS	32.3	-22.9	2.4	40.21	54	-13.79	-	-	298	108	H
2	2.504	39.01	Pk	32.4	-22.8	0	48.61	-	-	74	-25.39	298	108	H

* - indicates frequency in CFR47 Pt 15 Restricted Band

Pk - Peak detector

RMS - RMS detection

VERTICAL RESULT

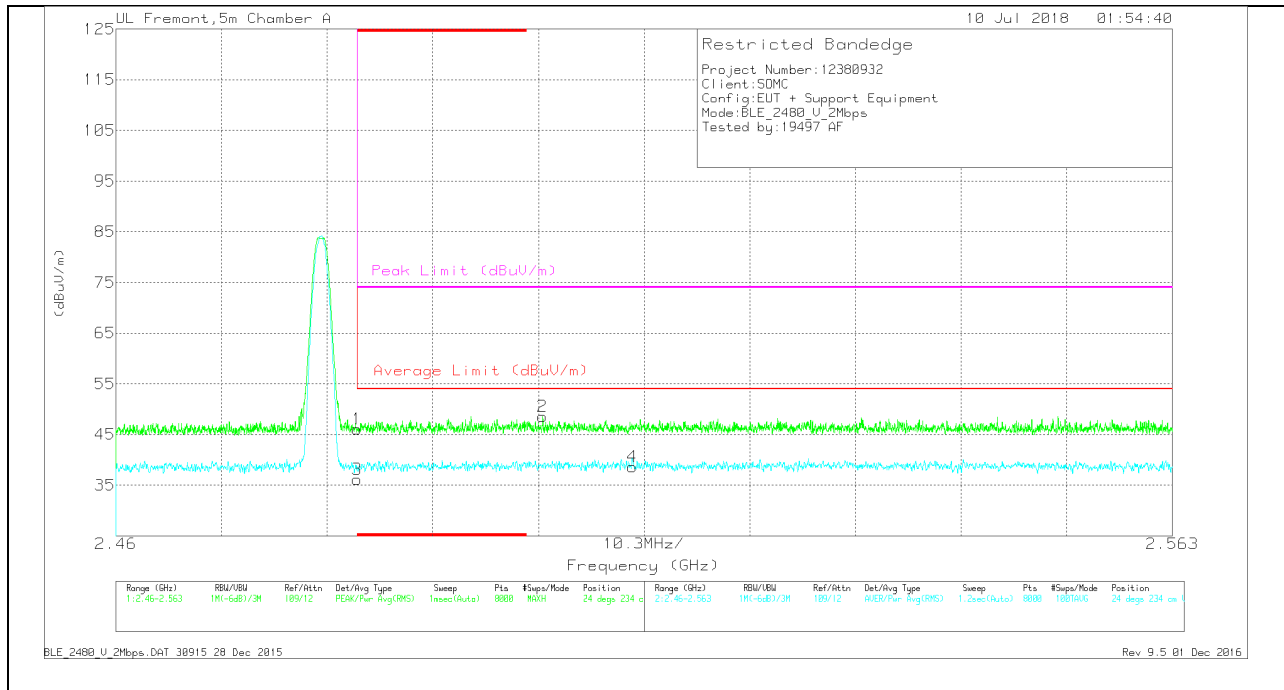

Trace Markers

Marker	Frequency (GHz)	Meter Reading (dBuV)	Det	AF T345 (dB/m)	Amp/Cbl/Filtr/Pad (dB)	DC Corr (dB)	Corrected Reading (dBuV/m)	Average Limit (dBuV/m)	Margin (dB)	Peak Limit (dBuV/m)	PK Margin (dB)	Azimuth (Degs)	Height (cm)	Polarity
1	* 2.484	36.66	Pk	32.3	-22.9	0	46.06	-	-	74	-27.94	24	234	V
3	* 2.484	26.03	RMS	32.3	-22.9	2.4	37.83	54	-16.17	-	-	24	234	V
2	2.502	39.1	Pk	32.4	-22.9	0	48.6	-	-	74	-25.4	24	234	V
4	2.51	28.47	RMS	32.4	-22.9	2.4	40.37	54	-13.63	-	-	24	234	V

* - indicates frequency in CFR47 Pt 15 Restricted Band

Pk - Peak detector

RMS - RMS detection

HARMONICS AND SPURIOUS EMISSIONS

LOW CHANNEL RESULTS

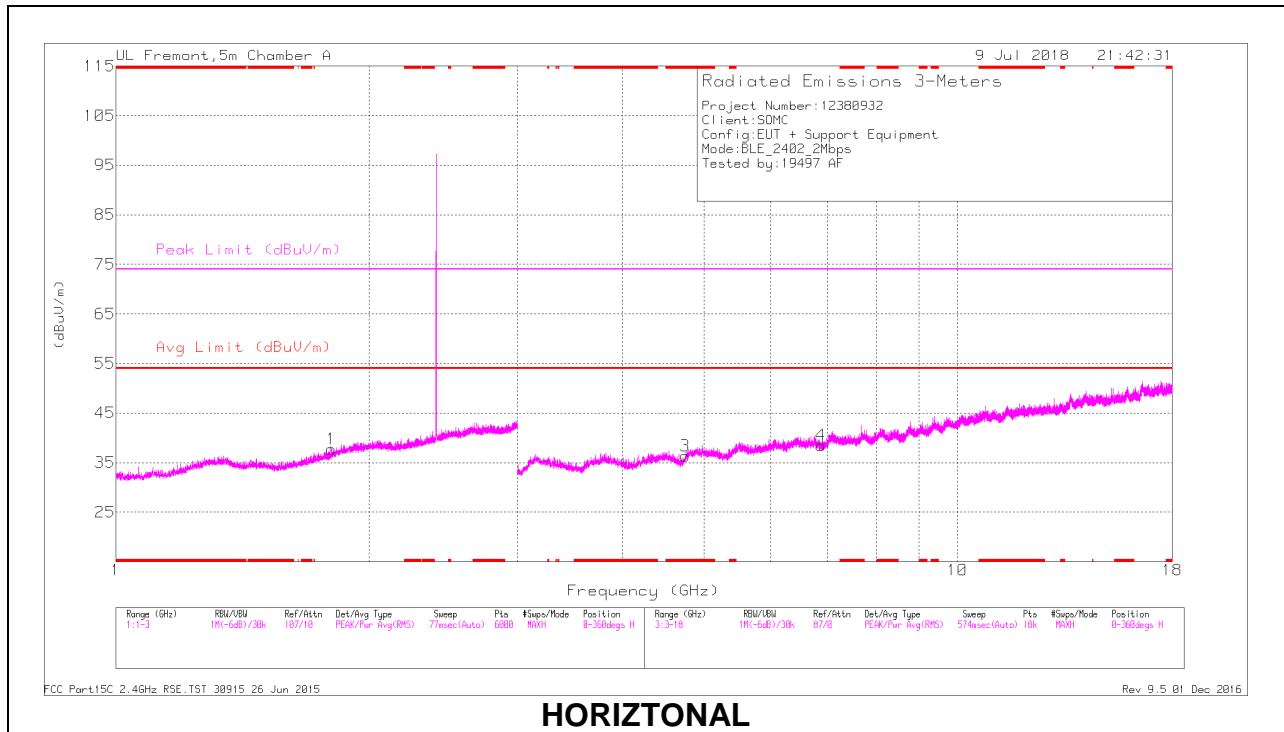

HORIZONTAL

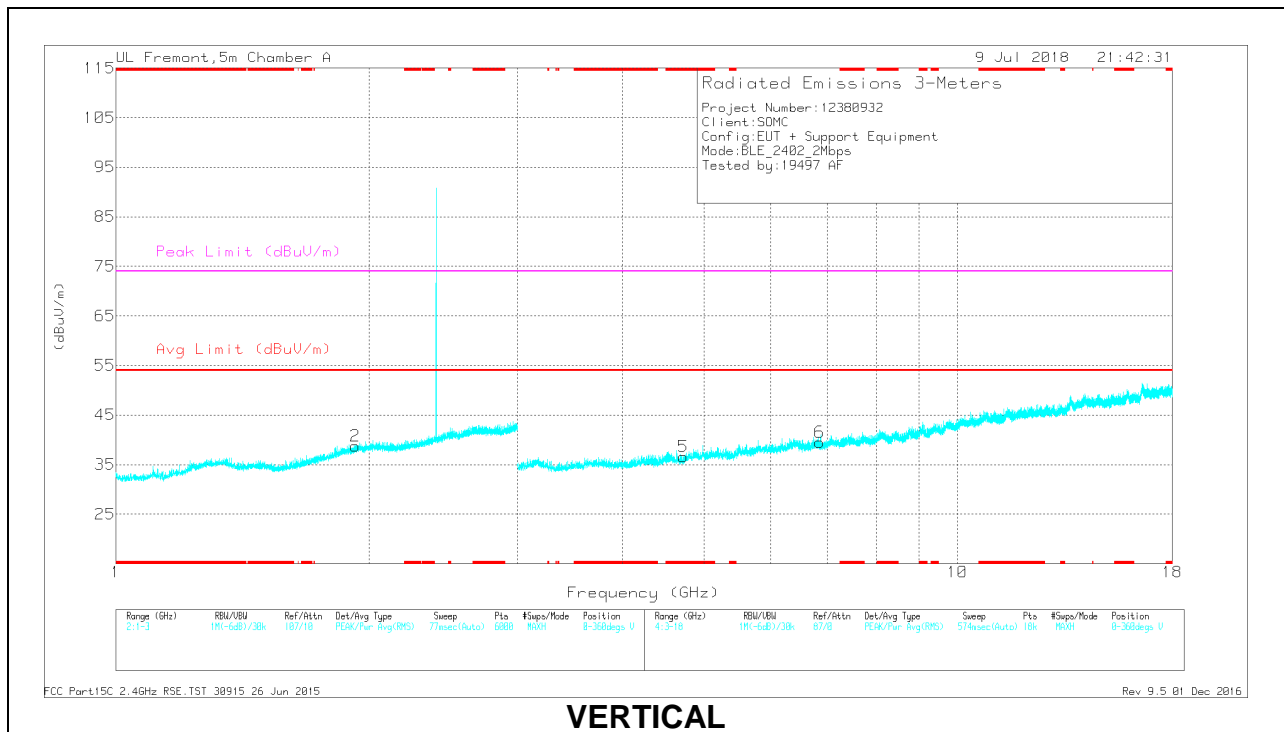

VERTICAL

RADIATED EMISSIONS

Radiated Emissions

Marker	Frequency (GHz)	Meter Reading (dBuV)	Det	AF T345 (dB/m)	Amp/Cbl/Filtr/Pad (dB)	DC Corr (dB)	Corrected Reading (dBuV/m)	Avg Limit (dBuV/m)	Margin (dB)	Peak Limit (dBuV/m)	PK Margin (dB)	Azimuth (Degs)	Height (cm)	Polarity
3	* 4.746	36.04	PK2	34	-27.1	0	42.94	-	-	74	-31.06	194	200	H
	* 4.745	24.31	MAv1	34	-27.1	2.4	33.61	54	-20.39	-	-	194	200	H
5	* 4.721	36.36	PK2	34	-27.3	0	43.06	-	-	74	-30.94	292	334	V
	* 4.721	24.75	MAv1	34	-27.3	2.4	33.85	54	-20.15	-	-	292	334	V
1	1.803	37.02	PK2	30.2	-23	0	44.22	-	-	-	-	226	172	H
2	1.926	36.55	PK2	31.2	-22.8	0	44.95	-	-	-	-	348	259	V
6	6.857	32.88	PK2	35.6	-23.1	0	45.38	-	-	-	-	64	112	V
4	6.882	33.25	PK2	35.6	-23.2	0	45.65	-	-	-	-	64	333	H

* - indicates frequency in CFR47 Pt 15 Restricted Band

PK2 - KDB558074 Method: Maximum Peak

MAv1 - KDB558074 Option 1 Maximum RMS Average

MID CHANNEL RESULTS

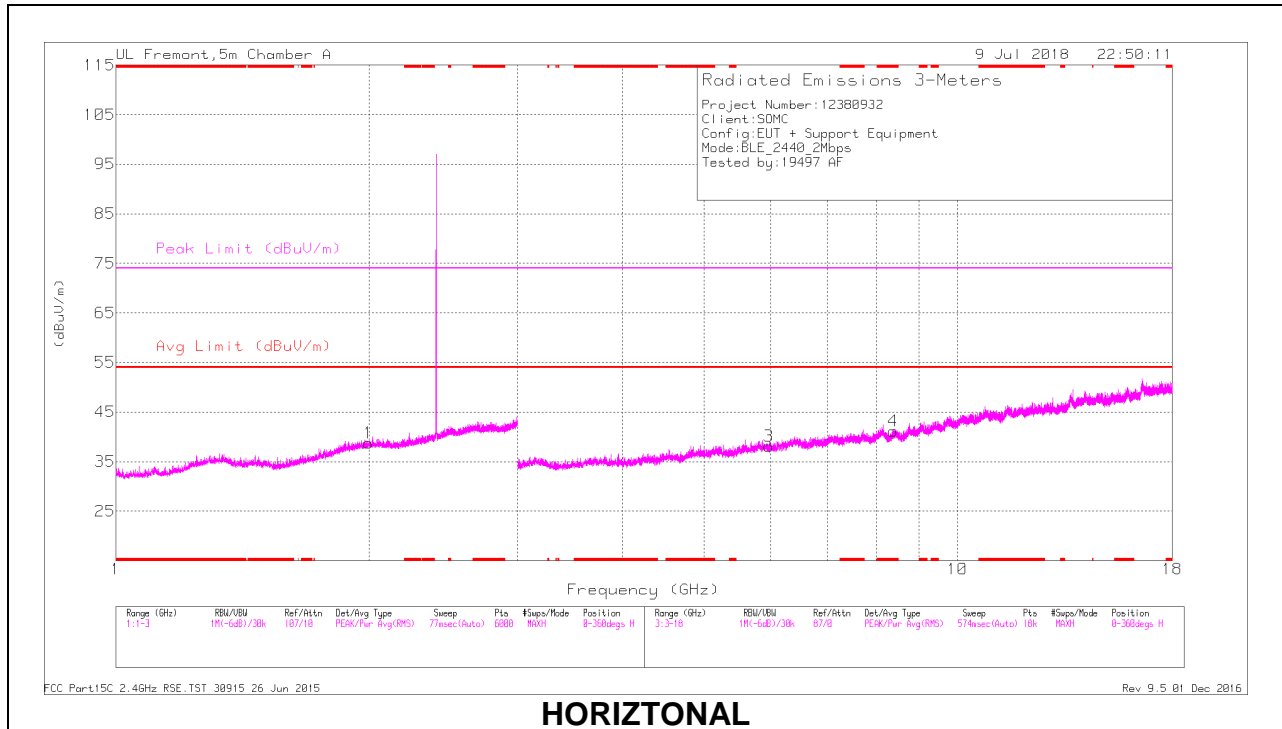

HORIZONTAL

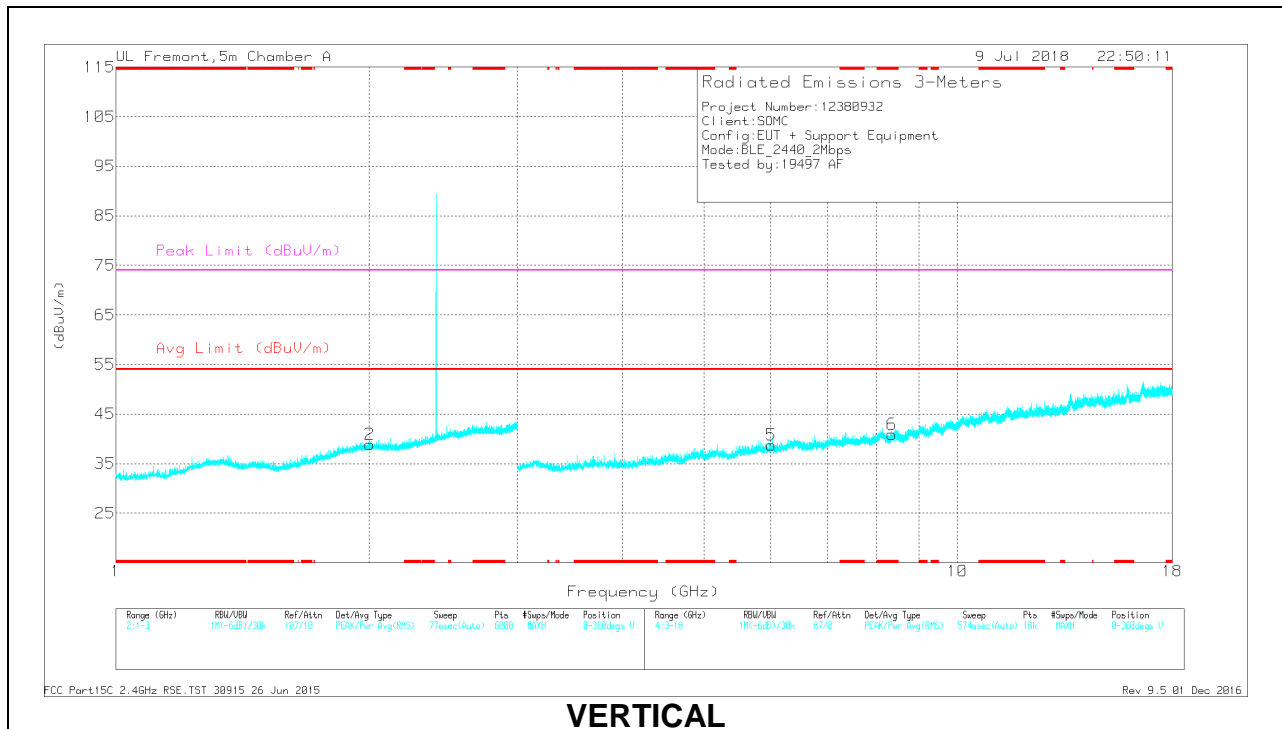

VERTICAL

RADIATED EMISSIONS

Radiated Emissions

Marker	Frequency (GHz)	Meter Reading (dBuV)	Det	AF T345 (dB/m)	Amp/Cb/Filtr/Pad (dB)	DC Corr (dB)	Corrected Reading (dBuV/m)	Avg Limit (dBuV/m)	Margin (dB)	Peak Limit (dBuV/m)	PK Margin (dB)	Azimuth (Degs)	Height (cm)	Polarity
4	* 8.383	33.2	PK2	35.8	-21.5	0	47.5	-	-	74	-26.5	352	356	H
	* 8.382	21.46	MAv1	35.8	-21.5	2.4	38.16	54	-15.84	-	-	352	356	H
6	* 8.356	33.03	PK2	35.8	-21.8	0	47.03	-	-	74	-26.97	103	124	V
	* 8.356	21.42	MAv1	35.8	-21.8	2.4	37.82	54	-16.18	-	-	103	124	V
1	1.997	36.82	PK2	31.4	-23	0	45.22	-	-	-	-	307	310	H
2	2.005	37.03	PK2	31.4	-23	0	45.43	-	-	-	-	346	280	V
3	5.968	35.26	PK2	35.3	-25.5	0	45.06	-	-	-	-	319	161	H
5	6.007	34.85	PK2	35.3	-25.5	0	44.65	-	-	-	-	328	274	V

* - indicates frequency in CFR47 Pt 15 Restricted Band

PK2 - KDB558074 Method: Maximum Peak

MAv1 - KDB558074 Option 1 Maximum RMS Average

HIGH CHANNEL RESULTS

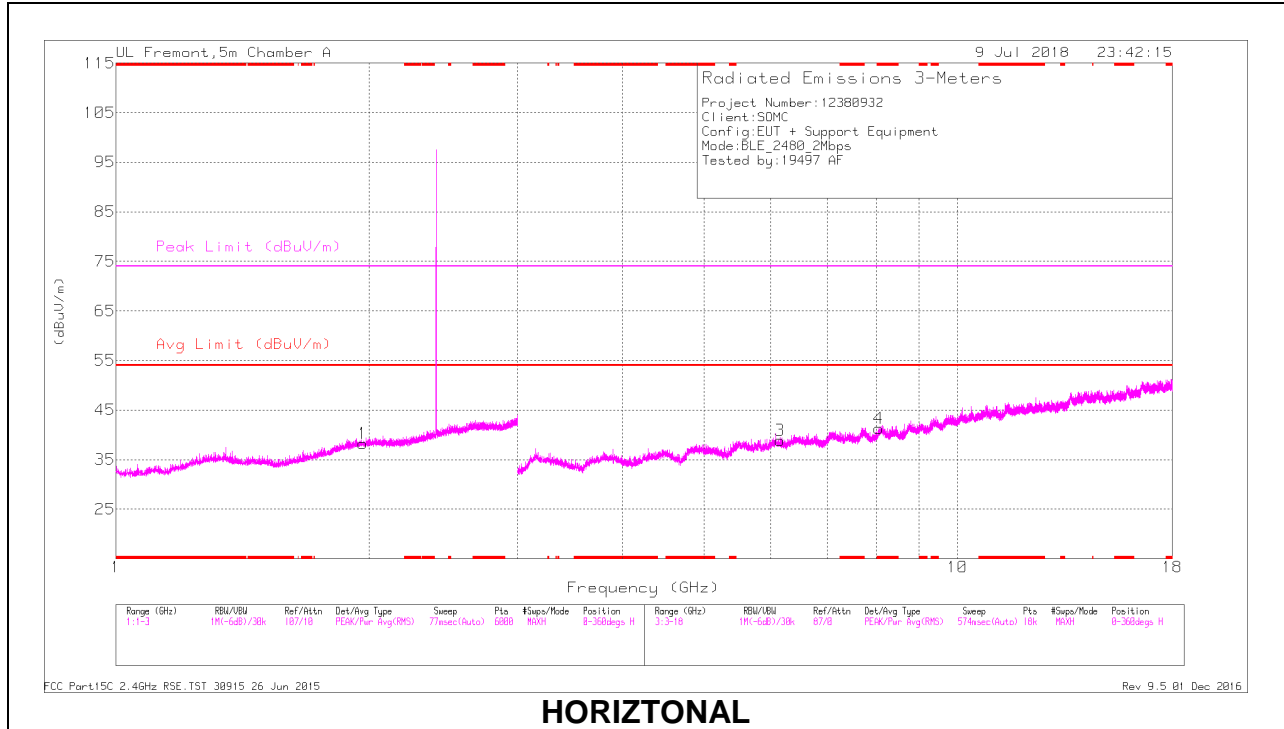

HORIZONTAL

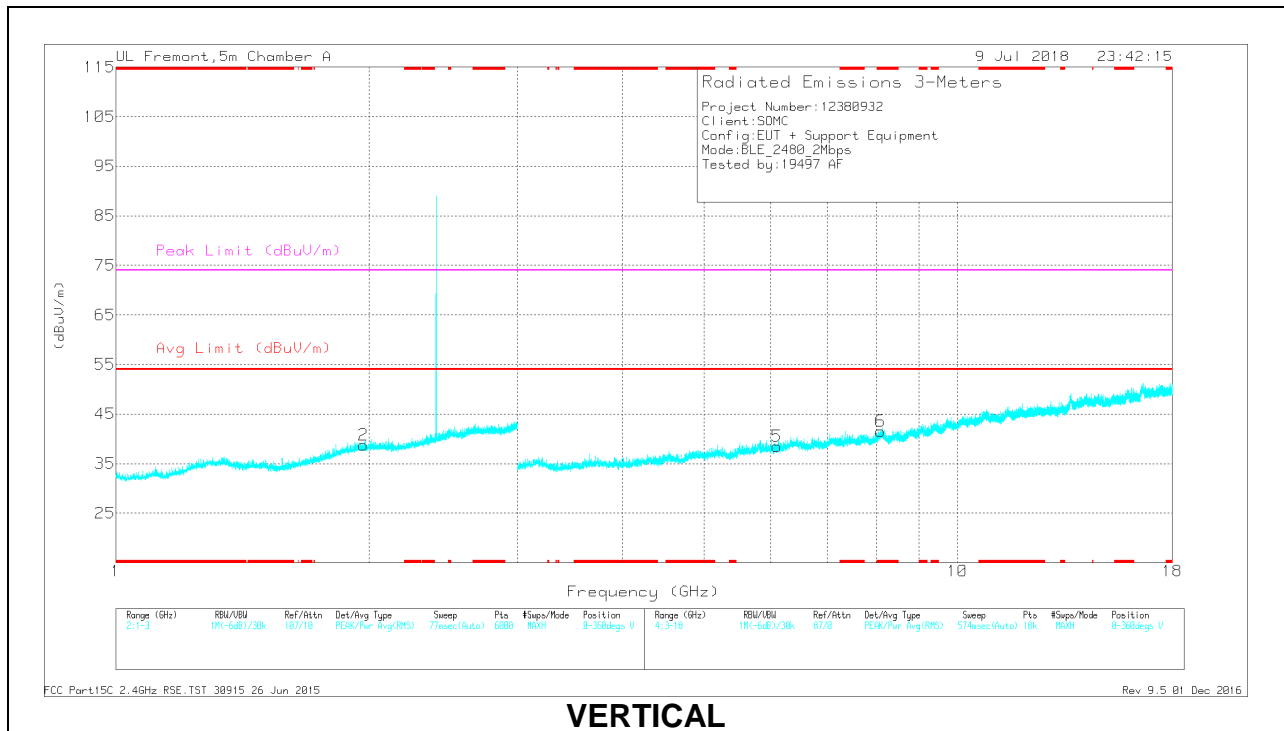

VERTICAL

RADIATED EMISSIONS

Radiated Emissions

Marker	Frequency (GHz)	Meter Reading (dBuV)	Det	AF T345 (dB/m)	Amp/Cb/Filtr/Pad (dB)	DC Corr (dB)	Corrected Reading (dBuV/m)	Avg Limit (dBuV/m)	Margin (dB)	Peak Limit (dBuV/m)	PK Margin (dB)	Azimuth (Degs)	Height (cm)	Polarity
4	* 8.067	32.78	PK2	35.8	-21.3	0	47.28	-	-	74	-26.72	137	328	H
	* 8.066	21.34	MAv1	35.9	-21.4	2.4	38.24	54	-15.76	-	-	137	328	H
6	* 8.106	33.14	PK2	35.8	-21	0	47.94	-	-	74	-26.06	73	315	V
	* 8.104	21.09	MAv1	35.8	-21	2.4	38.29	54	-15.71	-	-	73	315	V
1	1.963	36.66	PK2	31.4	-23	0	45.06	-	-	-	-	135	185	H
2	1.969	36.77	PK2	31.4	-23	0	45.17	-	-	-	-	182	138	V
5	6.101	33.97	PK2	35.5	-24.8	0	44.67	-	-	-	-	345	166	V
3	6.158	33.66	PK2	35.6	-24.4	0	44.86	-	-	-	-	186	387	H

* - indicates frequency in CFR47 Pt 15 Restricted Band

PK2 - KDB558074 Method: Maximum Peak

MAv1 - KDB558074 Option 1 Maximum RMS Average

9.3. Worst Case Below 30 MHz

SPURIOUS EMISSIONS 9 kHz TO 30 MHz (WORST-CASE CONFIGURATION)

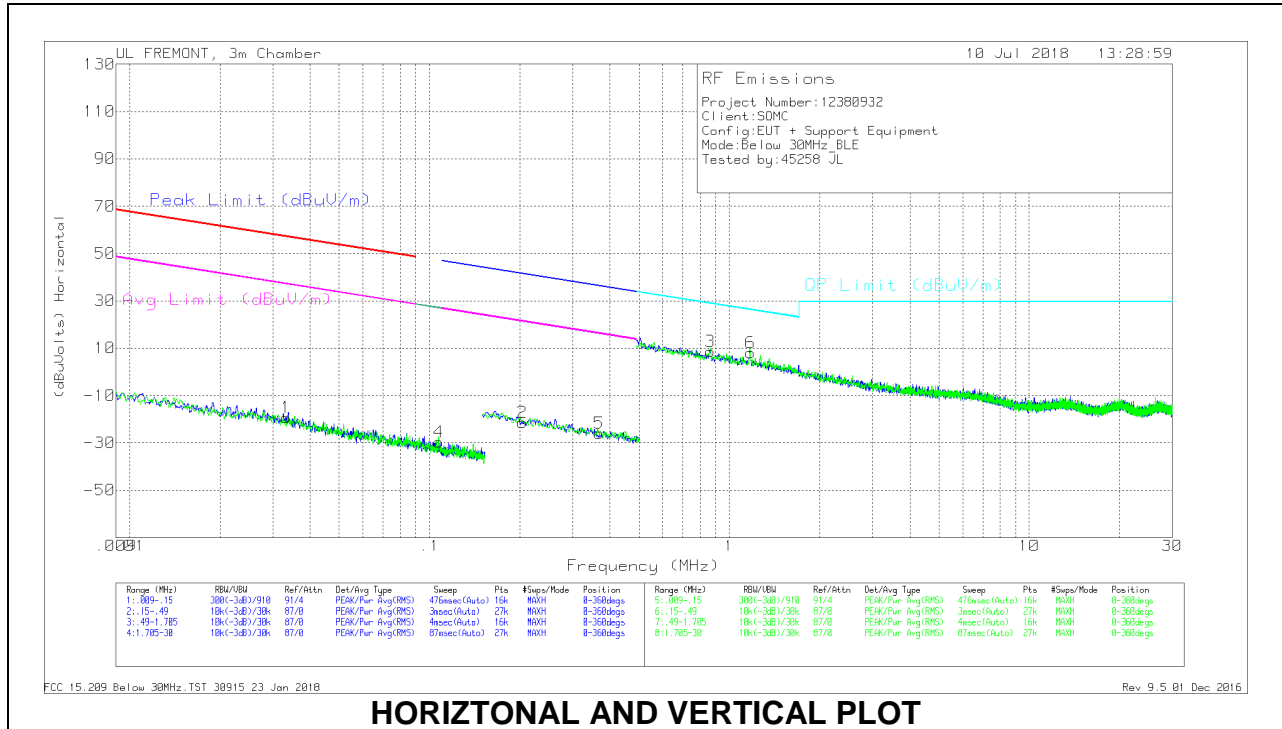

HORIZONTAL AND VERTICAL PLOT

Below 30 MHz Data

Trace Markers

Marker	Frequency (MHz)	Meter Reading (dBuV)	Det	Loop Antenna (dB/m)	Cbl (dB)	Dist Corr 300m	Corrected Reading (dBuVolts)	QP Limit (dBuV/m)	Margin (dB)	Peak Limit (dBuV/m)	Margin (dB)	Avg Limit (dBuV/m)	Margin (dB)	Azimuth (Degs)
1	.03331	44.18	Pk	15.1	1.4	-80	-19.32	-	-	57.13	-76.45	37.13	-56.45	0-360
4	.10749	35.03	Pk	13.8	1.4	-80	-29.77	27	-56.77	-	-	-	-	0-360
2	.2042	43.27	Pk	13.8	1.5	-80	-21.43	-	-	41.42	-62.85	21.42	-42.85	0-360
5	.36733	38.94	Pk	13.7	1.5	-80	-25.86	-	-	36.31	-62.17	16.31	-42.17	0-360

Pk - Peak detector

Marker	Frequency (MHz)	Meter Reading (dBuV)	Det	Loop Antenna (dB/m)	Cbl (dB)	Dist Corr 30m	Corrected Reading (dBuVolts)	QP Limit (dBuV/m)	Margin (dB)	Peak Limit (dBuV/m)	Margin (dB)	Avg Limit (dBuV/m)	Margin (dB)	Azimuth (Degs)
3	.86362	33.03	Pk	14	1.5	-40	8.53	28.89	-20.36	-	-	-	-	0-360
6	1.17484	32.47	Pk	14.2	1.5	-40	8.17	26.23	-18.06	-	-	-	-	0-360

Pk - Peak detector

9.4. Worst Case Below 1 GHz

SPURIOUS EMISSIONS 30 TO 1000 MHz (WORST-CASE CONFIGURATION)

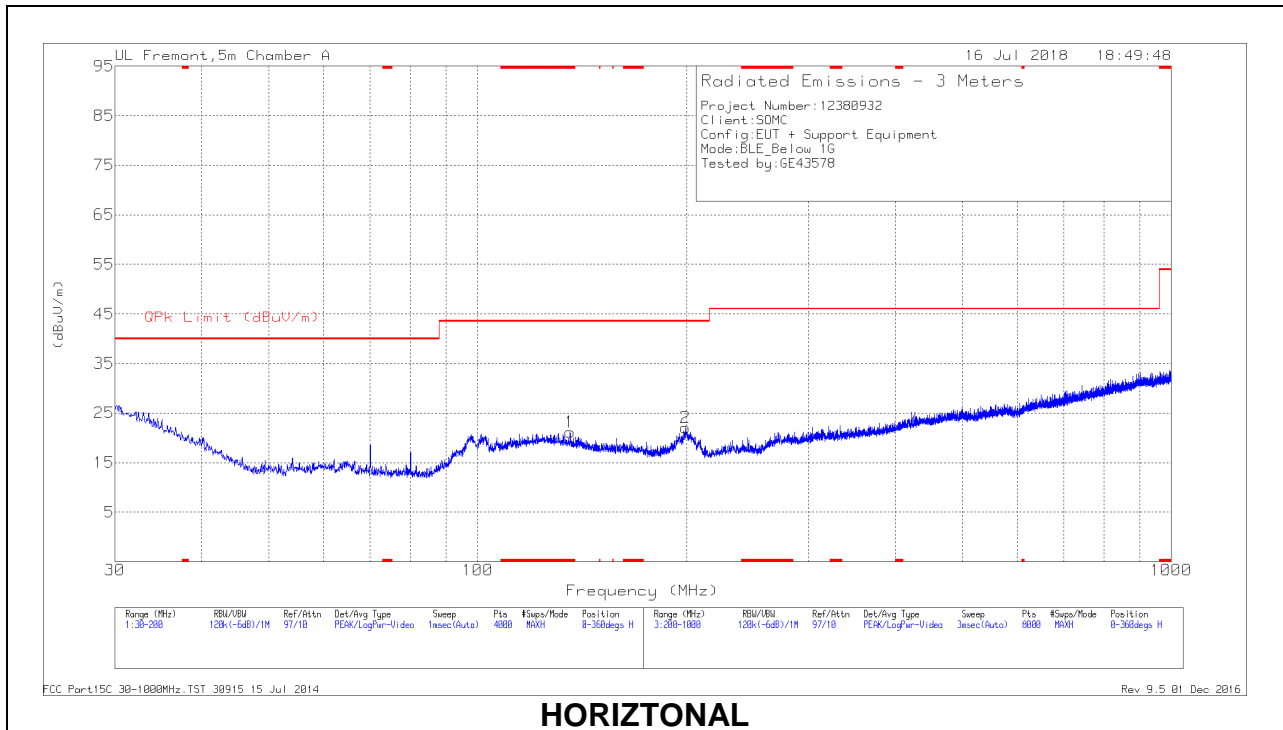

HORIZONTAL

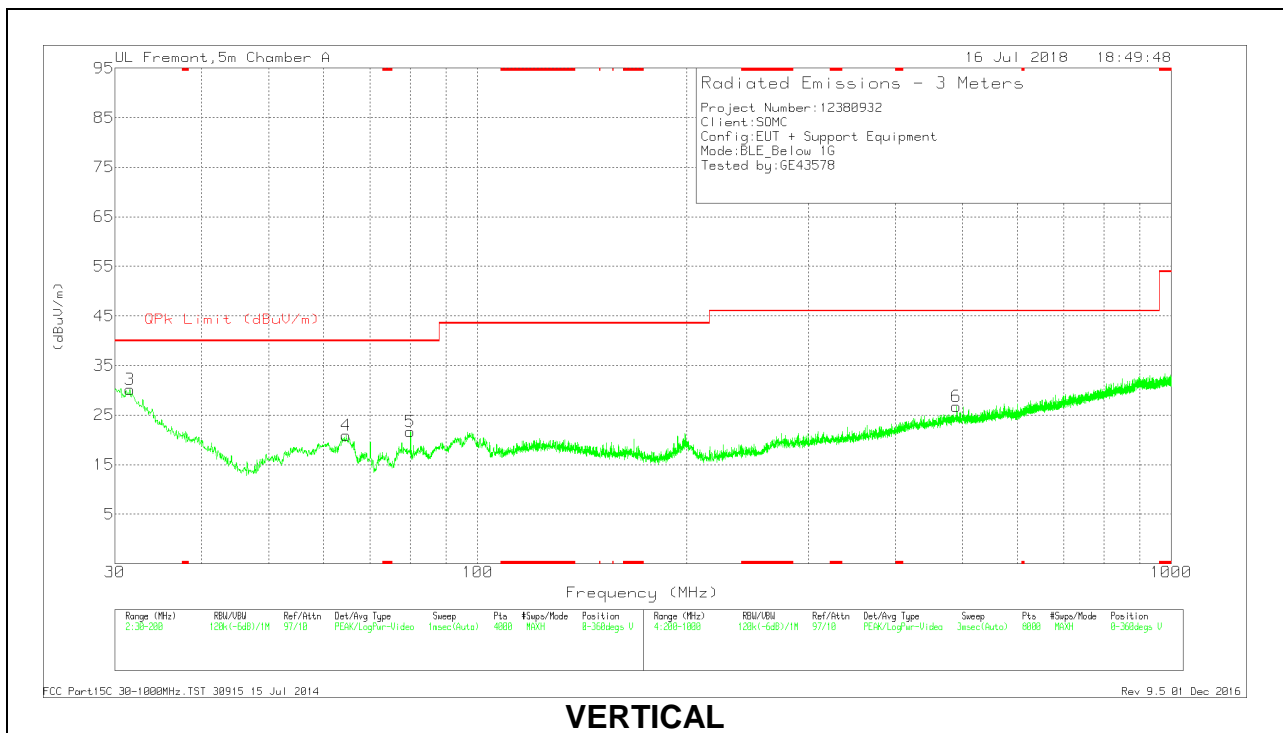

VERTICAL

Below 1GHz Data

Trace Markers

Marker	Frequency (MHz)	Meter Reading (dBuV)	Det	AF T130 (dB/m)	Amp/Cbl (dB/m)	Corrected Reading (dBuV/m)	QPk Limit (dBuV/m)	Margin (dB)	Azimuth (Degs)	Height (cm)	Polarity
1	* 135.9374	29.69	Pk	17.5	-26	21.19	43.52	-22.33	0-360	100	H
3	31.5304	33.42	Pk	24.1	-27.3	30.22	40	-9.78	0-360	100	V
4	64.6465	35.61	Pk	12.1	-26.8	20.91	40	-19.09	0-360	100	V
5	79.9929	36.77	Pk	11.5	-26.6	21.67	40	-18.33	0-360	100	V
2	199.3638	30.84	Pk	16.5	-25.3	22.04	43.52	-21.48	0-360	200	H
6	489.9377	30.35	Pk	21.7	-25.3	26.75	46.02	-19.27	0-360	200	V

* - indicates frequency in CFR47 Pt 15 Restricted Band

Pk - Peak detector

9.5. Worst Case 18-26 GHz

SPURIOUS EMISSIONS 18-26 GHz (WORST-CASE CONFIGURATION)

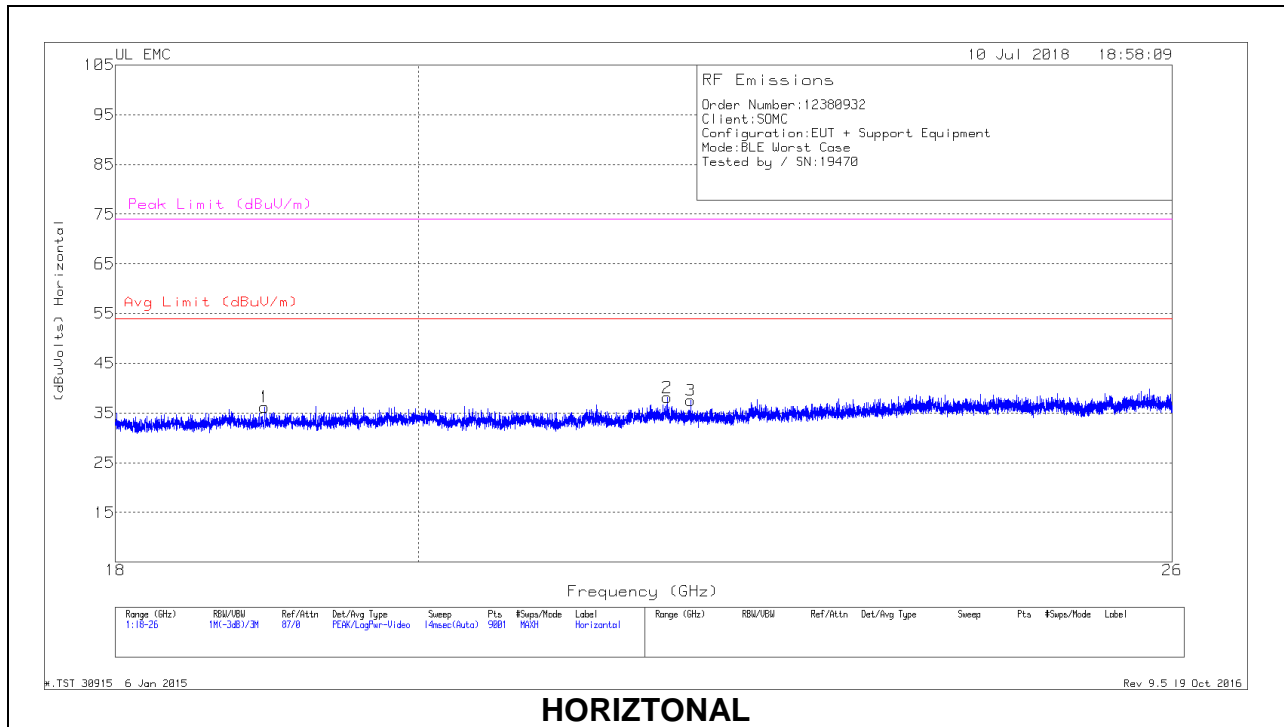

HORIZONTAL

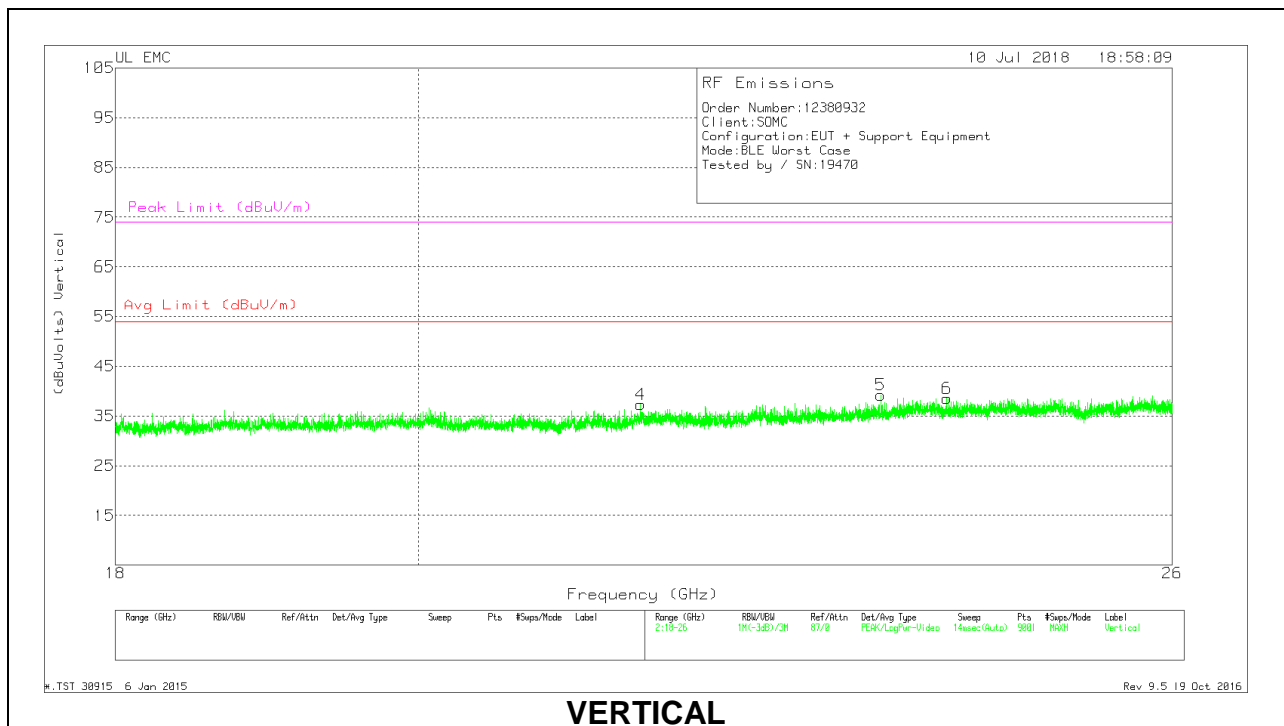

VERTICAL

18 – 26GHz DATA

Trace Markers

Marker	Frequency (GHz)	Meter Reading (dBuV)	Det	T89 AF (dB/m)	Amp/Cbl (dB)	Dist Corr (dB)	Corrected Reading (dBuVolts)	Avg Limit (dBuV/m)	Margin (dB)	Peak Limit (dBuV/m)	PK Margin (dB)
1	18.959	38.48	Pk	32.2	-25	-9.5	36.18	54	-17.82	74	-37.82
2	21.809	38.73	Pk	33.3	-24.4	-9.5	38.13	54	-15.87	74	-35.87
3	21.987	38.93	Pk	33.2	-25.1	-9.5	37.53	54	-16.47	74	-36.47
4	21.608	39.04	Pk	33.1	-25.3	-9.5	37.34	54	-16.66	74	-36.66
5	23.492	39.92	Pk	33.2	-24.4	-9.5	39.22	54	-14.78	74	-34.78
6	24.037	39.18	Pk	33.3	-24.4	-9.5	38.58	54	-15.42	74	-35.42

Pk - Peak detector

10. AC POWER LINE CONDUCTED EMISSIONS

LIMITS

FCC §15.207 (a)

Frequency of Emission (MHz)	Conducted Limit (dBuV)	
	Quasi-peak	Average
0.15-0.5	66 to 56*	56 to 46*
0.5-5	56	46
5-30	60	50

*Decreases with the logarithm of the frequency.

RESULTS

10.1.1. AC Power Line Norm

LINE 1 RESULTS

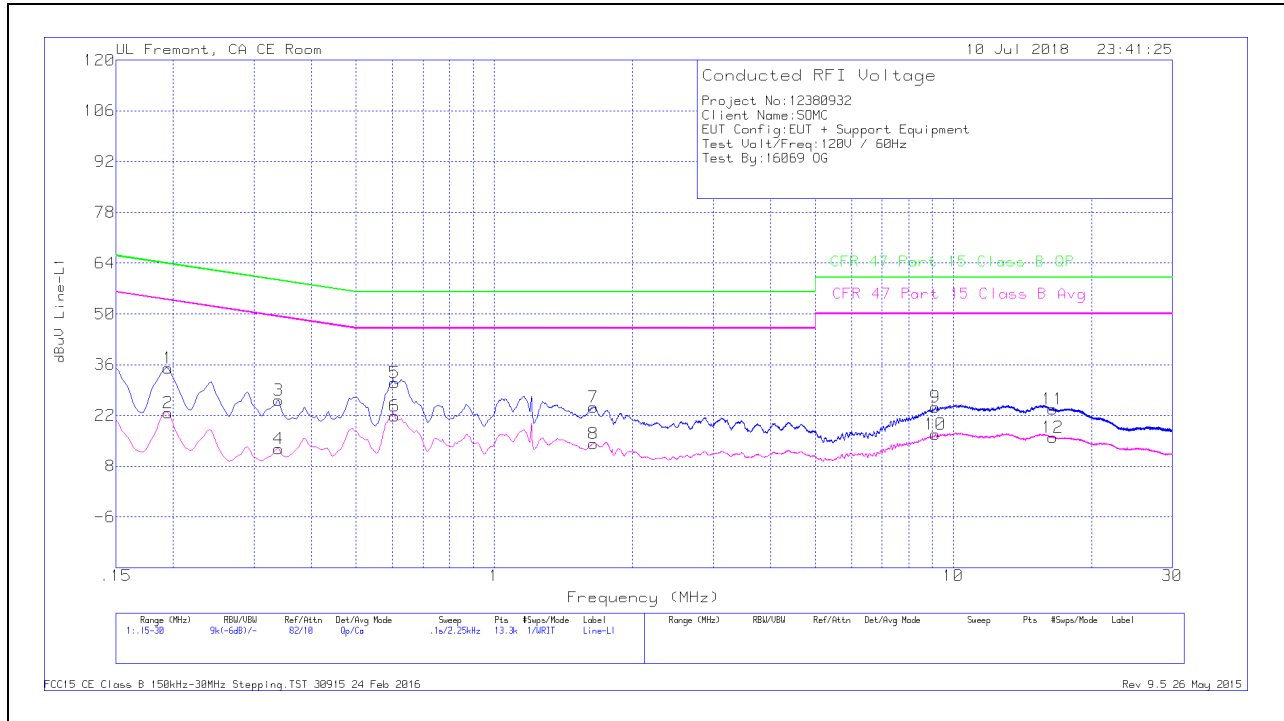

Trace Markers

Range 1: Line-L1 .15 - 30MHz											
Marker	Frequency (MHz)	Meter Reading (dBuV)	Det	LISN L1	LC Cables C1&C3	Limiter (dB)	Corrected Reading dBuV	CFR 47 Part 15 Class B QP	QP Margin (dB)	CFR 47 Part 15 Class B Avg	Av(CISPR) Margin (dB)
1	.195	24.97	Qp	0	0	10.1	35.07	63.82	-28.75	-	-
2	.195	12.67	Ca	0	0	10.1	22.77	-	-	53.82	-31.05
3	.339	16.02	Qp	0	0	10.1	26.12	59.23	-33.11	-	-
4	.339	2.73	Ca	0	0	10.1	12.83	-	-	49.23	-36.4
5	.60675	20.97	Qp	0	0	10.1	31.07	56	-24.93	-	-
6	.60675	11.7	Ca	0	0	10.1	21.8	-	-	46	-24.2
7	1.64625	14.04	Qp	0	.1	10.1	24.24	56	-31.76	-	-
8	1.64625	4	Ca	0	.1	10.1	14.2	-	-	46	-31.8
9	9.13875	13.84	Qp	0	.2	10.2	24.24	60	-35.76	-	-
10	9.13875	6.33	Ca	0	.2	10.2	16.73	-	-	50	-33.27
11	16.476	13.08	Qp	.1	.3	10.3	23.78	60	-36.22	-	-
12	16.476	5.28	Ca	.1	.3	10.3	15.98	-	-	50	-34.02

Qp - Quasi-Peak detector
 Ca - CISPR average detection

LINE 2 RESULTS

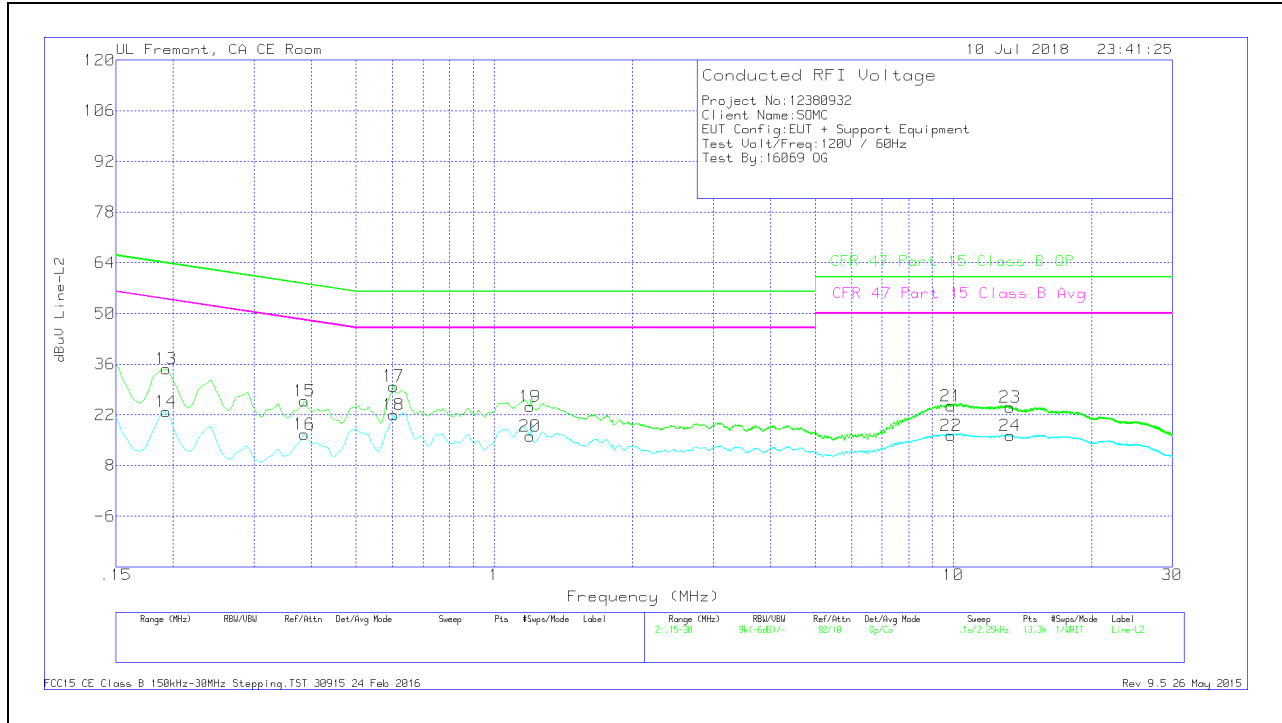

Trace Markers

Range 2: Line-L2 .15 - 30MHz											
Marker	Frequency (MHz)	Meter Reading (dBuV)	Det	LISN L2	LC Cables C2&C3	Limiter (dB)	Corrected Reading dBuV	CFR 47 Part 15 Class B QP	QP Margin (dB)	CFR 47 Part 15 Class B Avg	Av(CISPR) Margin (dB)
13	.19275	24.61	Qp	0	0	10.1	34.71	63.92	-29.21	-	-
14	.19275	12.74	Ca	0	0	10.1	22.84	-	-	53.92	-31.08
15	.38625	15.66	Qp	0	0	10.1	25.76	58.14	-32.38	-	-
16	.38625	6.46	Ca	0	0	10.1	16.56	-	-	48.14	-31.58
17	.6045	19.82	Qp	0	0	10.1	29.92	56	-26.08	-	-
18	.6045	11.86	Ca	0	0	10.1	21.96	-	-	46	-24.04
19	1.19625	14.03	Qp	0	.1	10.1	24.23	56	-31.77	-	-
20	1.19625	5.93	Ca	0	.1	10.1	16.13	-	-	46	-29.87
21	9.888	14.06	Qp	0	.2	10.2	24.46	60	-35.54	-	-
22	9.888	5.89	Ca	0	.2	10.2	16.29	-	-	50	-33.71
23	13.29675	13.65	Qp	.1	.2	10.2	24.15	60	-35.85	-	-
24	13.29675	5.73	Ca	.1	.2	10.2	16.23	-	-	50	-33.77

Qp - Quasi-Peak detector
 Ca - CISPR average detection