



FCC RADIO TEST REPORT

FCC ID : PY7-04606A
Equipment : GSM/WCDMA/LTE Phone+Bluetooth,
DTS/UNII a/b/g/n/ac and NFC
Brand Name : Sony
Applicant : Sony Mobile Communications Inc.
4-12-3 Higashi-Shinagawa, Shinagawa-ku,
Tokyo, 140-0002, Japan
Manufacturer : Sony Mobile Communications Inc.
4-12-3 Higashi-Shinagawa, Shinagawa-ku,
Tokyo, 140-0002, Japan
Standard : FCC Part 15 Subpart E §15.407

The product was received on Mar. 25, 2018 and testing was started from Apr. 03, 2018 and completed on Apr. 26, 2018~. We, SPORTON INTERNATIONAL INC., would like to declare that the tested sample has been evaluated in accordance with the test procedures and has been in compliance with the applicable technical standards.

The report must not be used by the client to claim product certification, approval, or endorsement by TAF or any agency of government.

The test results in this report apply exclusively to the tested model / sample. Without written approval of SPORTON INTERNATIONAL INC. EMC & Wireless Communications Laboratory, the test report shall not be reproduced except in full.

Approved by: Jones Tsai

SPORTON INTERNATIONAL INC. EMC & Wireless Communications Laboratory

No. 52, Huaya 1st Rd., Guishan Dist., Taoyuan City, Taiwan (R.O.C.)



Table of Contents

History of this test report	3
Summary of Test Result	4
1 General Description	5
1.1 Product Feature of Equipment Under Test.....	5
1.2 Modification of EUT.....	5
1.3 Testing Location.....	6
1.4 Applicable Standards	6
2 Test Configuration of Equipment Under Test	7
2.1 Carrier Frequency and Channel	7
2.2 Test Mode	8
2.3 Connection Diagram of Test System.....	9
2.4 Support Unit used in test configuration and system	10
2.5 EUT Operation Test Setup	10
2.6 Measurement Results Explanation Example.....	10
3 Test Result.....	11
3.1 6dB and 26dB and 99% Occupied Bandwidth Measurement	11
3.2 Maximum Conducted Output Power Measurement	14
3.3 Power Spectral Density Measurement	15
3.4 Unwanted Emissions Measurement	17
3.5 AC Conducted Emission Measurement.....	22
3.6 Automatically Discontinue Transmission	24
3.7 Antenna Requirements	25
4 List of Measuring Equipment	26
5 Uncertainty of Evaluation	28
Appendix A. Conducted Test Results	
Appendix B. AC Conducted Emission Test Result	
Appendix C. Radiated Spurious Emission	
Appendix D. Radiated Spurious Emission Plots	
Appendix E. Duty Cycle Plots	



History of this test report

Report No.	Version	Description	Issued Date
FR832501-01F	01	Initial issue of report	May 29, 2018



Summary of Test Result

Report Clause	Ref Std. Clause	Test Items	Result (PASS/FAIL)	Remark
3.1	15.403 (i)	6dB & 26dB Bandwidth	Pass	-
3.1	2.1049	99% Occupied Bandwidth	Reporting only	-
3.2	15.407 (a)	Maximum Conducted Output Power	Pass	-
3.3	15.407 (a)	Power Spectral Density	Pass	-
3.4	15.407(b)	Unwanted Emissions	Pass	Under limit 9.52 dB at 63.210 MHz
3.5	15.207	AC Conducted Emission	Pass	Under limit 18.05 dB at 0.647 MHz
3.6	15.407 (c)	Automatically Discontinue Transmission	Pass	-
3.7	15.203 & 15.407 (a)	Antenna Requirement	Pass	-

Reviewed by: Louis Wu

Report Producer: Natasha Hsieh



1 General Description

1.1 Product Feature of Equipment Under Test

GSM/WCDMA/LTE, Bluetooth, DTS/UNII a/b/g/n/ac, FM Receiver, NFC, and GNSS

Standards-related Product Specification	
Antenna Type / Gain	C-feed Antenna type with gain -1.00 dBi

EUT Information List			
HW Version	SW Version	S/N	Performed Test Item
A	9.29	CQ3000NYWW	RF conducted measurement
		CQ3000NYWV	Radiated Spurious Emission
		CQ3000PSRK	Conducted Emission

Accessory List	
AC Adapter	Model No. : UCH20
	S/N : 3515W45302499 (for radiated spurious emission) 3515W45302520 (for conducted emission)
Earphone	Model No. : MH410c
	S/N: N/A
USB Cable	Model No. : UCB20
	S/N : N/A

Note:

1. Above EUT list used are electrically identical per declared by manufacturer.
2. Above the accessories list are used to exercise the EUT during test, and the serial number of each type of accessories is listed in each section of this report. .
3. For other wireless features of this EUT, test report will be issued separately.

1.2 Modification of EUT

No modifications are made to the EUT during all test items.



1.3 Testing Location

Sporton Lab is accredited to ISO 17025 by Taiwan Accreditation Foundation (TAF code : 1190) and the FCC designation No. TW1190 and TW0007 under the FCC 2.948(e) by Mutual Recognition Agreement (MRA) in FCC Test.

Test Site	SPORTON INTERNATIONAL INC.	
Test Site Location	No.52, Huaya 1st Rd., Guishan Dist., Taoyuan City, Taiwan (R.O.C.) TEL: +886-3-327-3456 FAX: +886-3-328-4978	
Test Site No.	Sporton Site No.	
	TH05-HY	CO05-HY

Note: The test site complies with ANSI C63.4 2014 requirement.

Test Site	SPORTON INTERNATIONAL INC.	
Test Site Location	No.58, Aly. 75, Ln. 564, Wenhua 3rd, Rd., Guishan Dist., Taoyuan City, Taiwan (R.O.C.) TEL: +886-3-327-0868 FAX: +886-3-327-0855	
Test Site No.	Sporton Site No.	
	03CH12-HY	

Note: The test site complies with ANSI C63.4 2014 requirement.

1.4 Applicable Standards

According to the specifications of the manufacturer, the EUT must comply with the requirements of the following standards:

- ♦ FCC Part 15 Subpart E
- ♦ FCC KDB 789033 D02 General UNII Test Procedures New Rules v02r01.
- ♦ ANSI C63.10-2013

Remark:

1. All test items were verified and recorded according to the standards and without any deviation during the test.
2. This EUT has also been tested and complied with the requirements of FCC Part 15, Subpart B, recorded in a separate test report.



2 Test Configuration of Equipment Under Test

- a. The EUT has been associated with peripherals and configuration operated in a manner tended to maximize its emission characteristics in a typical application. Frequency range investigated: conduction emission (150 kHz to 30 MHz), radiation emission (9 kHz to the 10th harmonic of the highest fundamental frequency or to 40 GHz, whichever is lower). For radiated measurement, pre-scanned in three orthogonal panels, X, Y, Z. The worst cases (Z plane) were recorded in this report.

- b. AC power line Conducted Emission was tested under maximum output power.

2.1 Carrier Frequency and Channel

Frequency Band	Channel	Freq. (MHz)	Channel	Freq. (MHz)
5725-5850 MHz Band 4 (U-NII-3)	149	5745	157	5785
	151*	5755	159*	5795
	153	5765	161	5805
	155 [#]	5775	165	5825

Note:

- 1. The above Frequency and Channel in "*" were 802.11n HT40 and 802.11ac VHT40.
- 2. The above Frequency and Channel in "[#]" were 802.11ac VHT80.



2.2 Test Mode

Final test modes are considering the modulation and worse data rates as below table.

Modulation	Data Rate
802.11a	6 Mbps
802.11n HT20	MCS0
802.11n HT40	MCS0
802.11ac VHT20 (Covered by HT20)	MCS0
802.11ac VHT40 (Covered by HT40)	MCS0
802.11ac VHT80	MCS0

Test Cases	
AC Conducted Emission	Mode 1 : Bluetooth Link + WLAN (5GHz) Link + Earphone + Battery + USB Cable (Charging from Adapter)

Ch. #	Band IV : 5725-5850 MHz			
	802.11a	802.11n HT20	802.11n HT40	802.11ac VHT80
L Low	149	149	151	-
M Middle	157	157	-	155
H High	165	165	159	-

2.3 Connection Diagram of Test System

<WLAN Tx Mode>

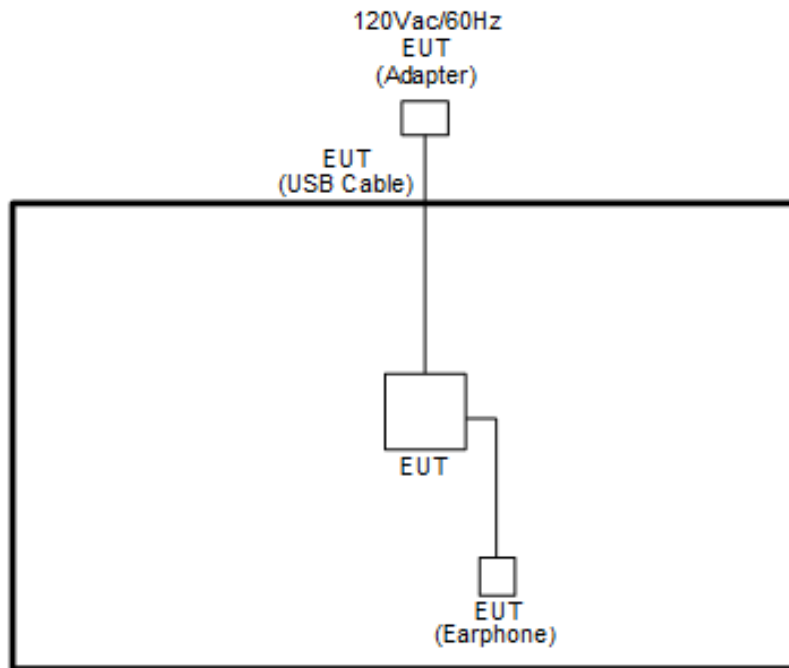

<AC Conducted Emissions Mode>

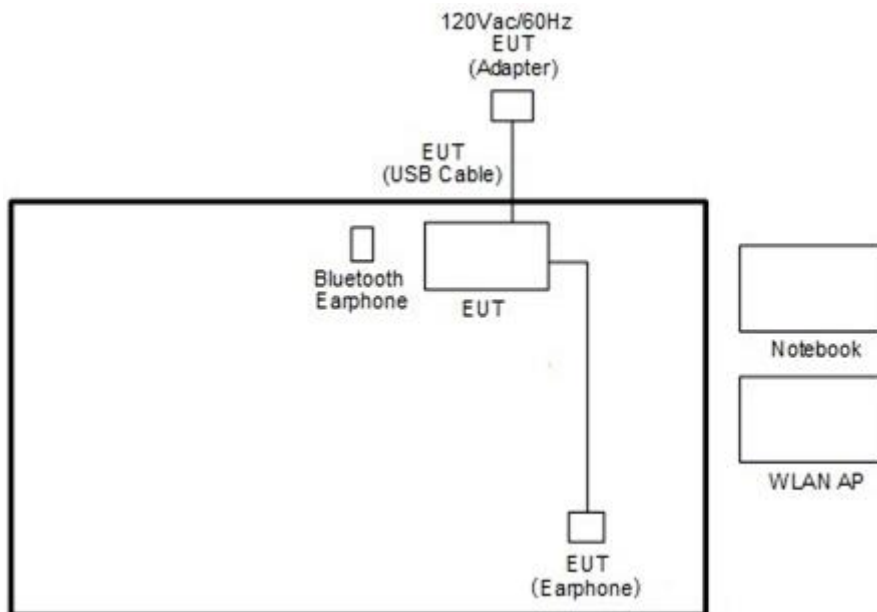



2.4 Support Unit used in test configuration and system

Item	Equipment	Trade Name	Model Name	FCC ID	Data Cable	Power Cord
1.	Bluetooth Earphone	Sony	SBH20	PY7-RD0010	N/A	N/A
2.	WLAN AP	ASUS	RT-AC66U	MSQ-RTAC66U	N/A	Unshielded, 1.8m
3.	Notebook	DELL	Latitude E6320	FCC DoC/ Contains FCC ID: QDS-BRCM1054	N/A	AC I/P: Unshielded, 1.2 m DC O/P: Shielded, 1.8 m
4.	SD Card	SanDisk	MicroSD HC	FCC DoC	N/A	N/A

2.5 EUT Operation Test Setup

For RF test items, an engineering test program was provided and enabled to make EUT transmitting signals.

2.6 Measurement Results Explanation Example

For all conducted test items:

The offset level is set in the spectrum analyzer to compensate the RF cable loss and attenuator factor between EUT conducted output port and spectrum analyzer. With the offset compensation, the spectrum analyzer reading level is exactly the EUT RF output level.

Example :

The spectrum analyzer offset is derived from RF cable loss and attenuator factor.

Offset = RF cable loss + attenuator factor.

Following shows an offset computation example with cable loss 4.2 dB and 10dB attenuator.

$$\begin{aligned} \text{Offset(dB)} &= \text{RF cable loss(dB)} + \text{attenuator factor(dB)}. \\ &= 4.2 + 10 = 14.2 \text{ (dB)} \end{aligned}$$

3 Test Result

3.1 6dB and 26dB and 99% Occupied Bandwidth Measurement

3.1.1 Description of 6dB and 26dB and 99% Occupied Bandwidth

The minimum 6 dB bandwidth shall be at least 500 kHz.

26dB and 99% Occupied bandwidth are reporting only.

3.1.2 Measuring Instruments

See list of measuring equipment of this test report.

3.1.3 Test Procedures

1. The testing follows FCC KDB 789033 D02 General UNII Test Procedures New Rules v02r01. Section C) Emission bandwidth for the band 5.725-5.85GHz
2. Set RBW = 100kHz.
3. Set the VBW $\geq 3 \times$ RBW.
4. Detector = Peak.
5. Trace mode = max hold
6. Measure the maximum width of the emission that is 6 dB down from the peak of the emission.
7. Measure and record the results in the test report.

3.1.4 Test Setup

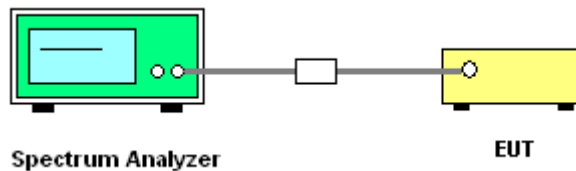

3.1.5 Test Result of 6dB Bandwidth

Please refer to Appendix A.

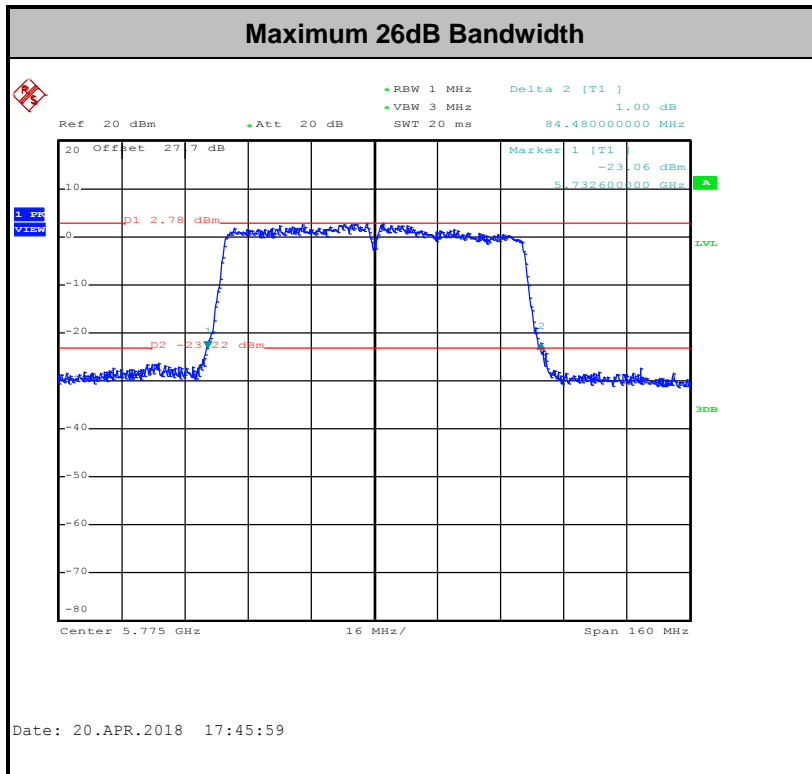
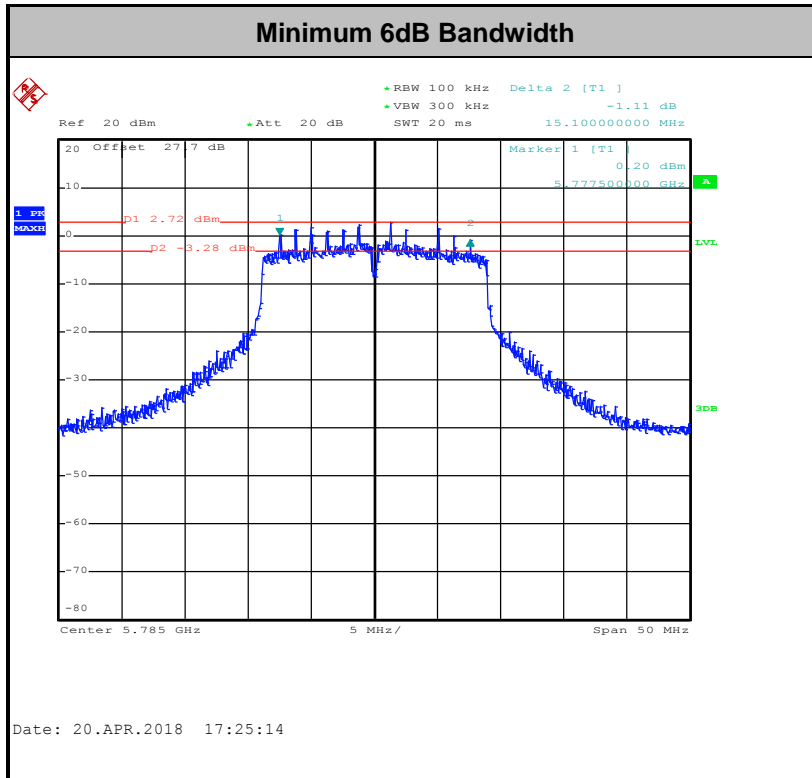

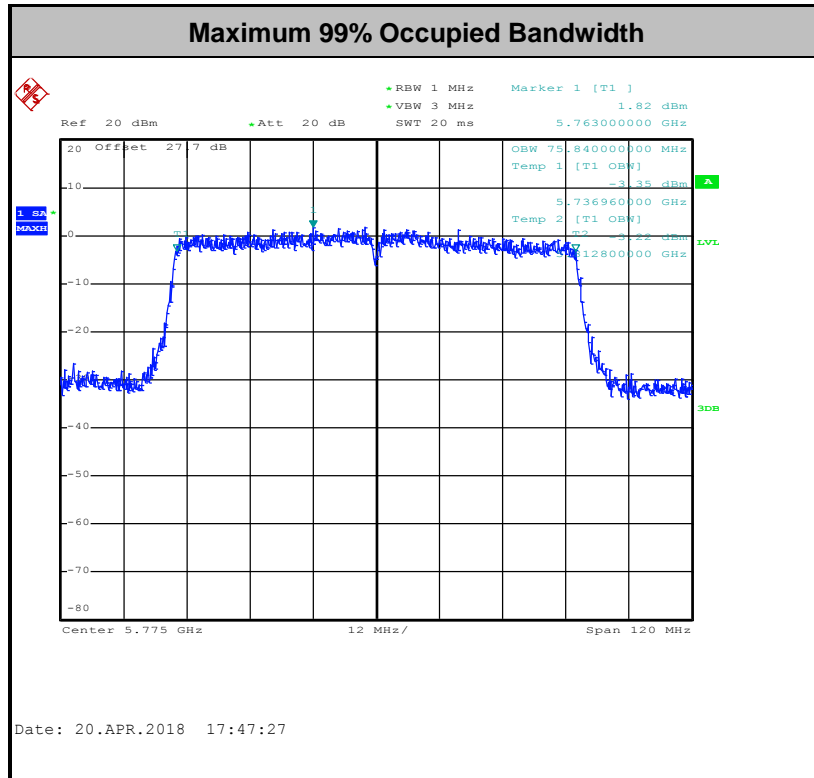

Note: The occupied channel bandwidth is maintained within the band of operation for all of the modulations.

3.2 Maximum Conducted Output Power Measurement

3.2.1 Limit of Maximum Conducted Output Power

For the band 5.725–5.85 GHz, the maximum conducted output power over the frequency band of operation shall not exceed 1 W.

If transmitting antennas of directional gain greater than 6 dBi are used, the peak output power shall be reduced by the amount in dB that the directional gain of the antenna exceeds 6 dBi.

3.2.2 Measuring Instruments

See list of measuring equipment of this test report.

3.2.3 Test Procedures

The testing follows Method PM of FCC KDB 789033 D02 General UNII Test Procedures New Rules v02r01.

Method PM (Measurement using an RF average power meter):

1. Measurement is performed using a wideband RF power meter.
2. The EUT is configured to transmit continuously with a consistent duty cycle at its maximum power control level.
3. Measure the average power of the transmitter, and the average power is corrected with duty factor, $10 \log(1/x)$, where x is the duty cycle.

3.2.4 Test Setup

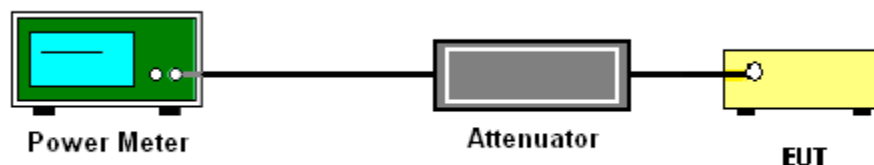

3.2.5 Test Result of Maximum Conducted Output Power

Please refer to Appendix A.



3.3 Power Spectral Density Measurement

3.3.1 Limit of Power Spectral Density

For the band 5.725–5.85 GHz, the maximum power spectral density shall not exceed 30 dBm in any 500-kHz band.

If transmitting antennas of directional gain greater than 6 dBi are used, the peak output power shall be reduced by the amount in dB that the directional gain of the antenna exceeds 6 dBi.

3.3.2 Measuring Instruments

See list of measuring equipment of this test report.

3.3.3 Test Procedures

The testing follows FCC KDB 789033 D02 General UNII Test Procedures New Rules v02r01. Section F) Maximum power spectral density.

Method SA-2

(trace averaging across on and off times of the EUT transmissions, followed by duty cycle correction).

- Measure the duty cycle.
 - Set span to encompass the entire emission bandwidth (EBW) of the signal.
 - Set RBW = 300 kHz.
 - Set VBW \geq 1 MHz.
 - Number of points in sweep \geq 2 Span / RBW.
 - Sweep time = auto.
 - Detector = RMS
 - Trace average at least 100 traces in power averaging mode.
 - Add $10 \log(500\text{kHz}/\text{RBW})$ to the test result.
 - Add $10 \log(1/x)$, where x is the duty cycle, to the measured power in order to compute the average power during the actual transmission times. For example, add $10 \log(1/0.25) = 6$ dB if the duty cycle is 25 percent.
1. The RF output of EUT was connected to the spectrum analyzer by a low loss cable.
 2. Each plot has already offset with cable loss, and attenuator loss. Measure the PPSD and record it.

3.3.4 Test Setup

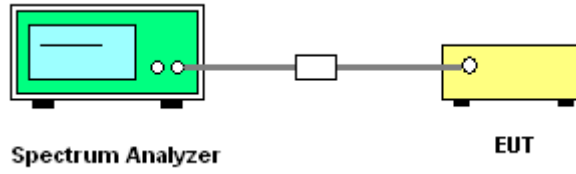

3.3.5 Test Result of Power Spectral Density

Please refer to Appendix A.

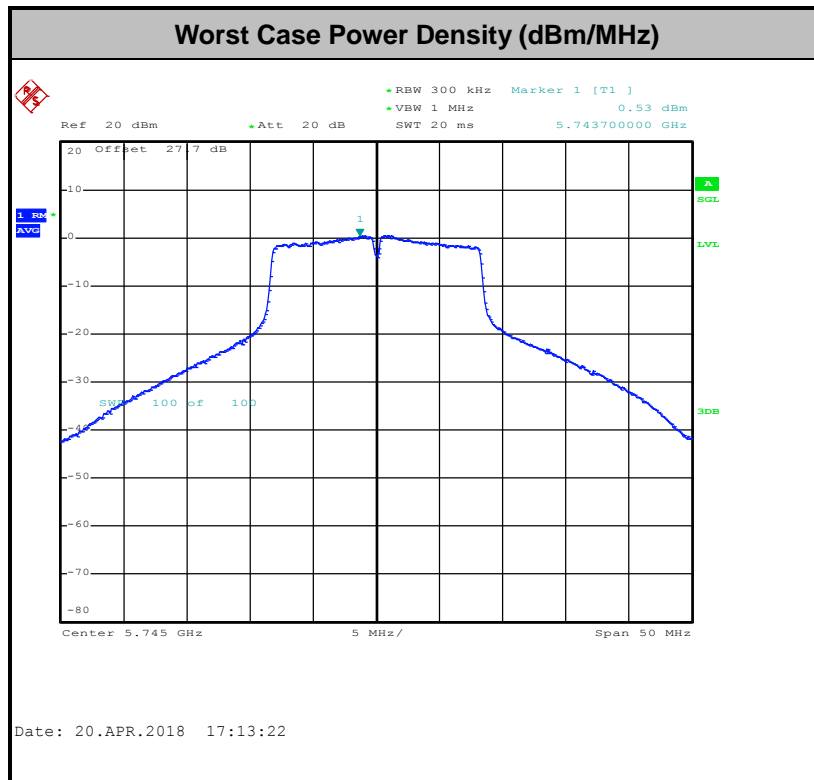



3.4 Unwanted Emissions Measurement

This section is to measure unwanted emissions through radiated measurement for band edge spurious emissions and out of band emissions measurement.

3.4.1 Limit of Unwanted Emissions

- (1) For transmitters operating in the 5.725-5.85 GHz band:
 15.407(b)(4)(i) All emissions shall be limited to a level of -27 dBm/MHz at 75 MHz or more above or below the band edge increasing linearly to 10 dBm/MHz at 25 MHz above or below the band edge, and from 25 MHz above or below the band edge increasing linearly to a level of 15.6 dBm/MHz at 5 MHz above or below the band edge, and from 5 MHz above or below the band edge increasing linearly to a level of 27 dBm/MHz at the band edge.
- (2) Unwanted spurious emissions fallen in restricted bands shall comply with the general field strength limits as below table,

Frequency (MHz)	Field Strength (microvolts/meter)	Measurement Distance (meters)
0.009 – 0.490	2400/F(kHz)	300
0.490 – 1.705	24000/F(kHz)	30
1.705 – 30.0	30	30
30 – 88	100	3
88 – 216	150	3
216 - 960	200	3
Above 960	500	3

Note: The following formula is used to convert the EIRP to field strength.

$$E = \frac{1000000\sqrt{30P}}{3} \mu V/m, \text{ where } P \text{ is the eirp (Watts)}$$

EIRP (dBm)	Field Strength at 3m (dBµV/m)
- 27	68.3



(3) KDB789033 D02 v02r01 G)2)c)

- (i) Section 15.407(b)(1) to (b)(3) specify the unwanted emission limits for the U-NII-1 and U-NII-2 bands. As specified, emissions above 1000 MHz that are outside of the restricted bands are subject to a peak emission limit of -27 dBm/MHz.³
- (ii) Section 15.407(b)(4) specifies the unwanted emission limit for the U-NII-3 band. A band emissions mask is specified in Section 15.407(b)(4)(i). The emission limits are in terms of a Peak detector. An alternative to the band emissions mask is specified in Section 15.407(b)(4)(ii). The alternative limits are based on the highest antenna gain specified in the filing. There are also marketing and importation restrictions for the devices using the alternative limit.⁴

Note 3: An out-of-band emission that complies with both the average and peak limits of Section 15.209 is not required to satisfy the -27 dBm/MHz peak emission limit.

Note 4: Only devices with antenna gains of 10 dBi or less may be approved using the emission limits specified in Section 15.247(d) till March 2, 2018; all other devices operating in this band must use the mask specified in Section 15.407(b)(4)(i).

3.4.2 Measuring Instruments

See list of measuring equipment of this test report.

3.4.3 Test Procedures

1. The testing follows FCC KDB 789033 D02 General UNII Test Procedures New Rules v02r01. Section G) Unwanted emissions measurement.

(1) Procedure for Unwanted Emissions Measurements Below 1000MHz

- RBW = 120 kHz
- VBW = 300 kHz
- Detector = Peak
- Trace mode = max hold

(2) Procedure for Peak Unwanted Emissions Measurements Above 1000 MHz

- RBW = 1 MHz
- VBW ≥ 3 MHz
- Detector = Peak
- Sweep time = auto
- Trace mode = max hold

(3) Procedures for Average Unwanted Emissions Measurements Above 1000MHz

- RBW = 1 MHz
- VBW = 10 Hz, when duty cycle is no less than 98 percent.
- VBW ≥ 1/T, when duty cycle is less than 98 percent where T is the minimum transmission duration over which the transmitter is on and is transmitting at its maximum power control level for the tested mode of operation.



2. The EUT was placed on a turntable with 0.8 meter for frequency below 1GHz and 1.5 meter for frequency above 1GHz respectively above ground.
3. The EUT was set 3 meters from the interference receiving antenna which was mounted on the top of a variable height antenna tower.
4. The antenna is a broadband antenna and its height is adjusted between one meter and four meters above ground to find the maximum value of the field strength for both horizontal polarization and vertical polarization of the antenna.
5. For each suspected emission, the EUT was arranged to its worst case and then adjust the antenna tower (from 1 m to 4 m) and turntable (from 0 degree to 360 degrees) to find the maximum reading.
6. For testing below 1GHz, if the emission level of the EUT in peak mode was 3 dB lower than the limit specified, then peak values of EUT will be reported, otherwise, the emissions will be repeated one by one using the CISPR quasi-peak method and reported.
7. For testing above 1GHz, the emission level of the EUT in peak mode was 20dB lower than average limit (that means the emission level in average mode also complies with the limit in average mode), then peak values of EUT will be reported, otherwise, the emissions will be measured in average mode again and reported.

3.4.4 Test Setup

For radiated emissions below 30MHz

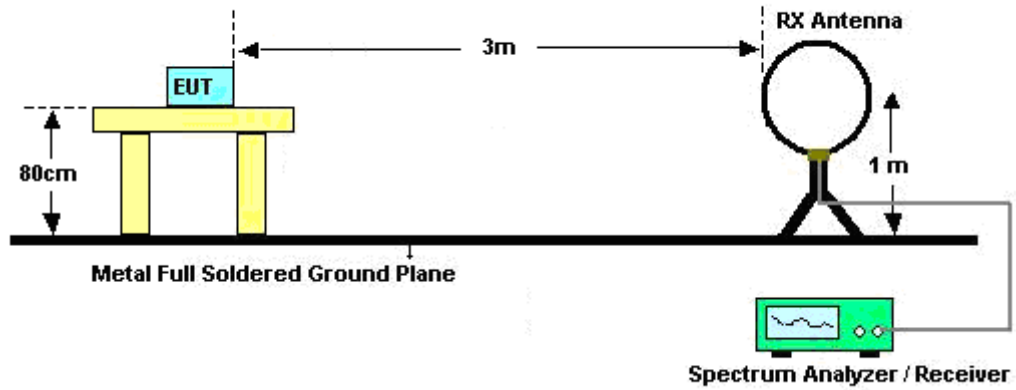

For radiated emissions from 30MHz to 1GHz

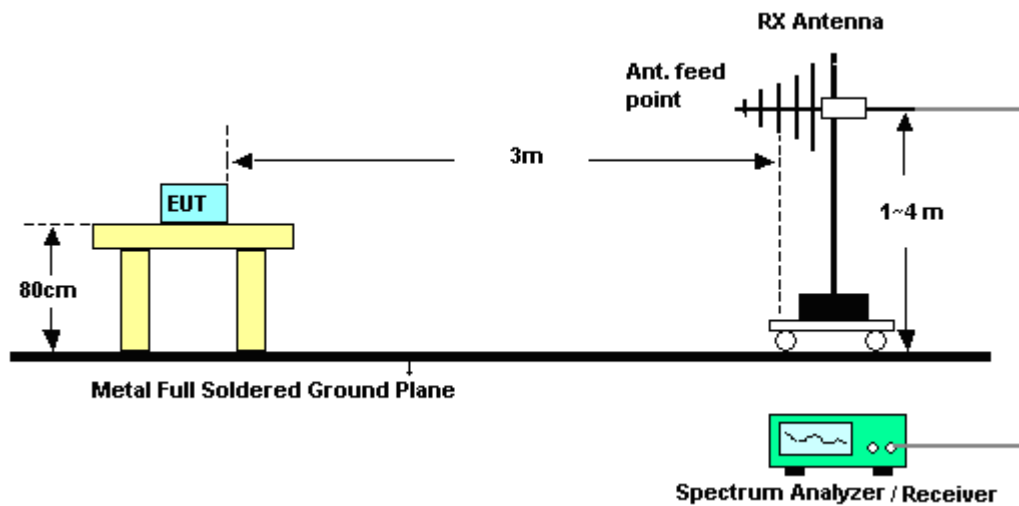

For radiated emissions above 1GHz

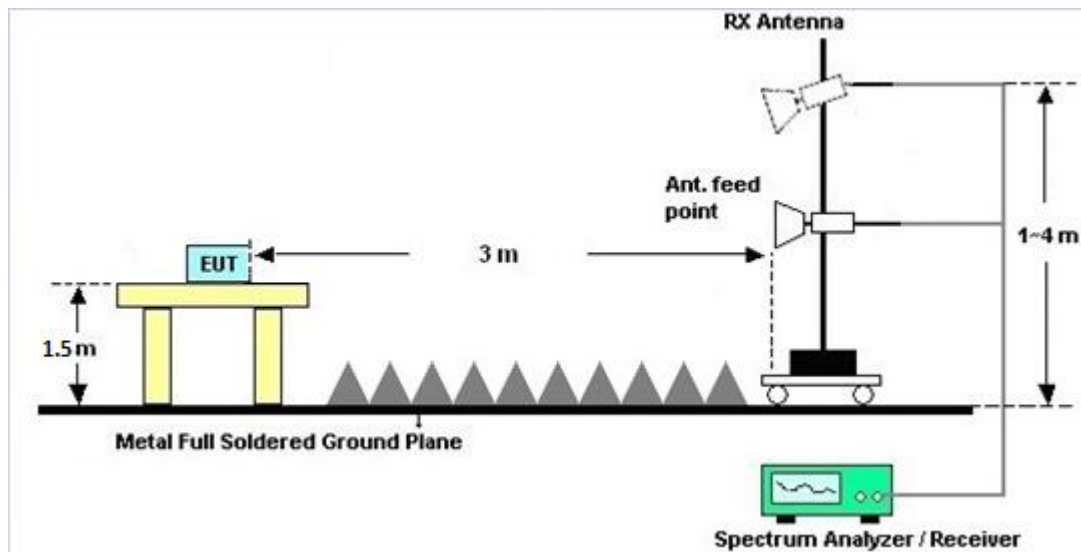

3.4.5 Test Results of Radiated Emissions (9 kHz ~ 30 MHz)

The low frequency, which started from 9 kHz to 30MHz, was pre-scanned and the result which was 20dB lower than the limit line was not reported.

There is a comparison data of both open-field test site and semi-Anechoic chamber, and the result came out very similar.

3.4.6 Test Result of Radiated Band Edges

Please refer to Appendix C and D.

3.4.7 Duty Cycle

Please refer to Appendix E.

3.4.8 Test Result of Unwanted Radiated Emission (30MHz ~ 10th Harmonic)

Please refer to Appendix C and D.



3.5 AC Conducted Emission Measurement

3.5.1 Limit of AC Conducted Emission

For equipment that is designed to be connected to the public utility (AC) power line, the radio frequency voltage that is conducted back onto the AC power line on any frequency or frequencies within the band 150 kHz to 30 MHz shall not exceed the limits in the following table.

Frequency of emission (MHz)	Conducted limit (dB μ V)	
	Quasi-peak	Average
0.15-0.5	66 to 56*	56 to 46*
0.5-5	56	46
5-30	60	50

*Decreases with the logarithm of the frequency.

3.5.2 Measuring Instruments

See list of measuring equipment of this test report.

3.5.3 Test Procedures

1. The EUT was placed 0.4 meter from the conducting wall of the shielding room was kept at least 80 centimeters from any other grounded conducting surface.
2. Connect EUT to the power mains through a line impedance stabilization network (LISN).
3. All the support units are connecting to the other LISN.
4. The LISN provides 50 ohm coupling impedance for the measuring instrument.
5. The FCC states that a 50 ohm, 50 microhenry LISN should be used.
6. Both sides of AC line were checked for maximum conducted interference.
7. The frequency range from 150 kHz to 30 MHz was searched.
8. Set the test-receiver system to Peak Detect Function and specified bandwidth with Maximum Hold Mode.

3.5.4 Test Setup

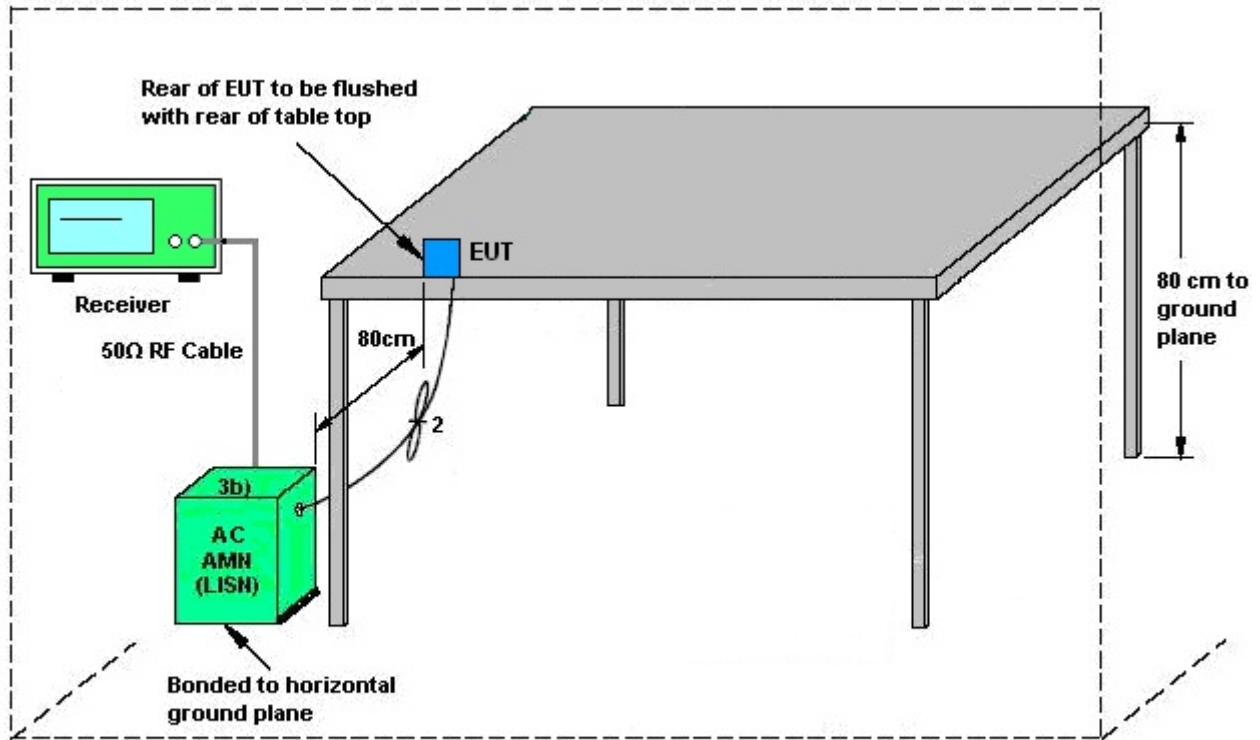

AMN = Artificial mains network (LISN)
 AE = Associated equipment
 EUT = Equipment under test
 ISN = Impedance stabilization network

3.5.5 Test Result of AC Conducted Emission

Please refer to Appendix B.



3.6 Automatically Discontinue Transmission

3.6.1 Limit of Automatically Discontinue Transmission

The device shall automatically discontinue transmission in case of either absence of information to transmit or operational failure. These provisions are not intended to preclude the transmission of control or signaling information or the use of repetitive codes used by certain digital technologies to complete frame or burst intervals. Applicants shall include in their application for equipment authorization to describe how this requirement is met.

3.6.2 Measuring Instruments

See list of measuring equipment of this test report.

3.6.3 Test Result of Automatically Discontinue Transmission

While the EUT is not transmitting any information, the EUT can automatically discontinue transmission and become standby mode for power saving. The EUT can detect the controlling signal of ACK message transmitting from remote device and verify whether it shall resend or discontinue transmission.



3.7 Antenna Requirements

3.7.1 Standard Applicable

If transmitting antenna directional gain is greater than 6 dBi, both the peak transmit power and the peak power spectral density shall be reduced by the amount in dB that the directional gain of the antenna exceeds 6 dBi.

3.7.2 Antenna Anti-Replacement Construction

An embedded-in antenna design is used.

3.7.3 Antenna Gain

The antenna peak gain of EUT is less than 6 dBi. Therefore, it is not necessary to reduce maximum peak output power limit.



4 List of Measuring Equipment

Instrument	Manufacturer	Model No.	Serial No.	Characteristics	Calibration Date	Test Date	Due Date	Remark
Power Meter	Anritsu	ML2495A	1240001	N/A	Sep. 07, 2017	Apr. 03, 2018~ Apr. 20, 2018	Sep. 06, 2018	Conducted (TH05-HY)
Power Sensor	Anritsu	MA2411B	1207349	300MHz~40GHz	Sep. 07, 2017	Apr. 03, 2018~ Apr. 20, 2018	Sep. 06, 2018	Conducted (TH05-HY)
Spectrum Analyzer	Rohde & Schwarz	FSP40	100055	9kHz~40GHz	Jun. 20, 2017	Apr. 03, 2018~ Apr. 20, 2018	Jun. 19, 2018	Conducted (TH05-HY)
Switch Box & RF Cable	Burgeon	ETF-058	EC1300484	N/A	Mar. 01, 2018	Apr. 03, 2018~ Apr. 20, 2018	Feb. 28, 2019	Conducted (TH05-HY)
Hygrometer	TECEPEL	HTC-1	2	N/A	Mar. 06, 2018	Apr. 03, 2018~ Apr. 20, 2018	Mar. 05, 2019	Conducted (TH05-HY)
RF Cable	HUBER + SUHNER	SUCOFLEX 104	MY84209521	1GHz~26GHz	Dec. 01, 2017	Apr. 03, 2018~ Apr. 20, 2018	Nov. 30, 2018	Conducted (TH05-HY)
AC Power Source	ChainTek	APC-1000W	N/A	N/A	N/A	Apr. 17, 2018	N/A	Conduction (CO05-HY)
EMI Test Receiver	Rohde & Schwarz	ESR3	102388	3.6GHz	Dec. 08, 2017	Apr. 17, 2018	Dec. 07, 2018	Conduction (CO05-HY)
Hygrometer	Testo	608-H1	34913912	N/A	May 02, 2017	Apr. 17, 2018	May 01, 2018	Conduction (CO05-HY)
LISN	Rohde & Schwarz	ENV216	100080	9kHz~30MHz	Nov. 30, 2017	Apr. 17, 2018	Nov. 29, 2018	Conduction (CO05-HY)
LF Cable	HUBER + SUHNER	RG-214/U	LF01	N/A	Jan. 03, 2018	Apr. 17, 2018	Jan. 02, 2019	Conduction (CO05-HY)
Test Software	Rohde & Schwarz	EMC32 V10.30	N/A	N/A	N/A	Apr. 17, 2018	N/A	Conduction (CO05-HY)
Pulse Limiter	Rohde & Schwarz	ESH3-Z2	100851	N/A	Jan. 03, 2018	Apr. 17, 2018	Jan. 02, 2019	Conduction (CO05-HY)
Loop Antenna	Rohde & Schwarz	HFH2-Z2	100488	9 kHz~30 MHz	Nov. 23, 2017	Apr. 24, 2018 ~ Apr. 26, 2018	Nov. 22, 2018	Radiation (03CH12-HY)
Bilog Antenna	TESEQ	CBL 6111D&N-6-06	35414&AT-N0 602	30MHz~1GHz	Oct. 14, 2017	Apr. 24, 2018 ~ Apr. 26, 2018	Oct. 13, 2018	Radiation (03CH12-HY)
Horn Antenna	SCHWARZBECK	BBHA 9120D	9120D-1328	1GHz ~ 18GHz	Oct. 20, 2017	Apr. 24, 2018 ~ Apr. 26, 2018	Oct. 19, 2018	Radiation (03CH12-HY)
SHF-EHF Horn Antenna	SCHWARZBECK	BBHA 9170	BBHA9170584	18GHz ~ 40GHz	Nov. 27, 2017	Apr. 24, 2018 ~ Apr. 26, 2018	Nov. 26, 2018	Radiation (03CH12-HY)
Spectrum Analyzer	Keysight	N9010A	MY54200485	10Hz ~ 44GHz	Oct. 31, 2017	Apr. 24, 2018 ~ Apr. 26, 2018	Oct. 30, 2018	Radiation (03CH12-HY)
EMI Test Receiver	Rohde & Schwarz	ESU26	100390	20Hz~26.5GHz	Dec. 25, 2017	Apr. 24, 2018 ~ Apr. 26, 2018	Dec. 24, 2018	Radiation (03CH12-HY)
Preamplifier	COM-POWER	PA-103	161075	10MHz~1GHz	Mar. 26, 2018	Apr. 24, 2018 ~ Apr. 26, 2018	Mar. 25, 2019	Radiation (03CH12-HY)
Preamplifier	Jet-Power	JPA0118-55-303K	1710001800054002	1GHz~18GHz	Apr. 17, 2018	Apr. 24, 2018 ~ Apr. 26, 2018	Apr. 16, 2019	Radiation (03CH12-HY)
Preamplifier	Keysight	83017A	MY53270148	1GHz~26.5GHz	Jan. 15, 2018	Apr. 24, 2018 ~ Apr. 26, 2018	Jan. 14, 2019	Radiation (03CH12-HY)
Amplifier	MITEQ	TTA1840-35-HG	1871923	18GHz~40GHz, VSWR : 2.5:1 max	Jul. 18, 2017	Apr. 24, 2018 ~ Apr. 26, 2018	Jul. 17, 2018	Radiation (03CH12-HY)



Instrument	Manufacturer	Model No.	Serial No.	Characteristics	Calibration Date	Test Date	Due Date	Remark
Hygrometer	TECEPEL	DTM-303B	TP140320	N/A	Nov. 13, 2017	Apr. 24, 2018 ~ Apr. 26, 2018	Nov. 12, 2018	Radiation (03CH12-HY)
RF Cable	HUBER + SUHNER	SUCOFLEX 126E	0058/126E	30M-18G	Mar. 14, 2018	Apr. 24, 2018 ~ Apr. 26, 2018	Mar. 13, 2019	Radiation (03CH12-HY)
RF Cable	HUBER + SUHNER	SUCOFLEX 104	MY15539/4	30M-18G	Mar. 14, 2018	Apr. 24, 2018 ~ Apr. 26, 2018	Mar. 13, 2019	Radiation (03CH12-HY)
RF Cable	HUBER + SUHNER	SUCOFLEX 104	MY36979/4	30M-18G	Mar. 14, 2018	Apr. 24, 2018 ~ Apr. 26, 2018	Mar. 13, 2019	Radiation (03CH12-HY)
RF Cable	HUBER + SUHNER	SUCOFLEX 102	505134/2	30M~40GHz	Oct. 17, 2017	Apr. 24, 2018 ~ Apr. 26, 2018	Oct. 16, 2018	Radiation (03CH12-HY)
RF Cable	HUBER + SUHNER	SUCOFLEX 102	800740/2	30M~40GHz	Oct. 17, 2017	Apr. 24, 2018 ~ Apr. 26, 2018	Oct. 16, 2018	Radiation (03CH12-HY)
Filter	Wainwright	WLKS1200-12 SS	SN2	1.2G Low Pass	Jul. 17, 2017	Apr. 24, 2018 ~ Apr. 26, 2018	Jul. 16, 2018	Radiation (03CH12-HY)
Filter	Wainwright	WHKX12-2700 -3000-18000-6 0SS	SN2	3G High Pass	Sep. 18, 2017	Apr. 24, 2018 ~ Apr. 26, 2018	Sep. 17, 2018	Radiation (03CH12-HY)
Filter	Woken	WHKX8-5272. 5-6750-18000- 40ST	SN2	6.75G Highpass	Jul. 17, 2017	Apr. 24, 2018 ~ Apr. 26, 2018	Jul. 16, 2018	Radiation (03CH12-HY)
Antenna Mast	EMEC	AM-BS-4500-B	N/A	1m~4m	N/A	Apr. 24, 2018 ~ Apr. 26, 2018	N/A	Radiation (03CH12-HY)
Turn Table	EMEC	TT2000	N/A	0~360 Degree	N/A	Apr. 24, 2018 ~ Apr. 26, 2018	N/A	Radiation (03CH12-HY)
Test Software	Audix	E3 6.2009-8-24	RK-000989	N/A	N/A	Apr. 24, 2018 ~ Apr. 26, 2018	N/A	Radiation (03CH12-HY)



5 Uncertainty of Evaluation

Uncertainty of Conducted Emission Measurement (150kHz ~ 30MHz)

Measuring Uncertainty for a Level of Confidence of 95% ($U = 2Uc(y)$)	2.70
---	------

Uncertainty of Radiated Emission Measurement (30 MHz ~ 1000 MHz)

Measuring Uncertainty for a Level of Confidence of 95% ($U = 2Uc(y)$)	5.10
---	------

Uncertainty of Radiated Emission Measurement (1000 MHz ~ 18000 MHz)

Measuring Uncertainty for a Level of Confidence of 95% ($U = 2Uc(y)$)	5.20
---	------

Uncertainty of Radiated Emission Measurement (18000 MHz ~ 40000 MHz)

Measuring Uncertainty for a Level of Confidence of 95% ($U = 2Uc(y)$)	4.70
---	------

Appendix A. Test Result of Conducted Test Items

Test Engineer:	Shiang Wang/Lena Lo	Temperature:	21~25	°C
Test Date:	2018/4/3~2018/4/20	Relative Humidity:	51~54	%

TEST RESULTS DATA
6dB and 26dB EBW and 99% OBW

Band IV													
Mod.	Data Rate	NTX	CH.	Freq. (MHz)	99% Bandwidth (MHz)		26dB Bandwidth (MHz)		6 dB Bandwidth (MHz)		6 dB Bandwidth Min. Limit (MHz)		Pass/Fail
					Ant 1	Ant 2	Ant 1	Ant 2	Ant 1	Ant 2	Ant 1	Ant 2	
11a	6Mbps	1	149	5745	19.10	-	34.60	-	15.70	-	0.5	-	Pass
11a	6Mbps	1	157	5785	18.95	-	35.65	-	15.85	-	0.5	-	Pass
11a	6Mbps	1	165	5825	19.10	-	35.65	-	15.65	-	0.5	-	Pass
HT20	MCS0	1	149	5745	18.75	-	26.50	-	17.00	-	0.5	-	Pass
HT20	MCS0	1	157	5785	18.80	-	27.20	-	15.10	-	0.5	-	Pass
HT20	MCS0	1	165	5825	18.70	-	26.65	-	15.10	-	0.5	-	Pass
HT40	MCS0	1	151	5755	36.70	-	42.12	-	35.28	-	0.5	-	Pass
HT40	MCS0	1	159	5795	36.60	-	42.30	-	36.00	-	0.5	-	Pass
VHT80	MCS0	1	155	5775	75.84	-	84.48	-	75.10	-	0.5	-	Pass

TEST RESULTS DATA
Average Power Table

Band IV														
Mod.	Data Rate	NTX	CH.	Freq. (MHz)	Duty Factor (dB)		Average Conducted Power (dBm)			FCC Conducted Power Limit (dBm)		DG (dBi)		Pass/Fail
					Ant 1	Ant 2	Ant 1	Ant 2	SUM	Ant 1	Ant 2	Ant 1	Ant 2	
11a	6Mbps	1	149	5745	0.23	-	16.98	-		30.00	-	-1.00	-	Pass
11a	6Mbps	1	157	5785	0.23	-	16.95	-		30.00	-	-1.00	-	Pass
11a	6Mbps	1	165	5825	0.23	-	16.94	-		30.00	-	-1.00	-	Pass
HT20	MCS0	1	149	5745	0.25	-	13.87	-		30.00	-	-1.00	-	Pass
HT20	MCS0	1	157	5785	0.25	-	13.76	-		30.00	-	-1.00	-	Pass
HT20	MCS0	1	165	5825	0.25	-	13.65	-		30.00	-	-1.00	-	Pass
HT40	MCS0	1	151	5755	0.50	-	12.77	-		30.00	-	-1.00	-	Pass
HT40	MCS0	1	159	5795	0.50	-	12.84	-		30.00	-	-1.00	-	Pass
VHT20	MCS0	1	149	5745	0.25	-	13.89	-		30.00	-	-1.00	-	Pass
VHT20	MCS0	1	157	5785	0.25	-	13.76	-		30.00	-	-1.00	-	Pass
VHT20	MCS0	1	165	5825	0.25	-	13.73	-		30.00	-	-1.00	-	Pass
VHT40	MCS0	1	151	5755	0.44	-	12.89	-		30.00	-	-1.00	-	Pass
VHT40	MCS0	1	159	5795	0.44	-	12.93	-		30.00	-	-1.00	-	Pass
VHT80	MCS0	1	155	5775	0.57	-	11.81	-		30.00	-	-1.00	-	Pass

TEST RESULTS DATA
Power Spectral Density

Band IV																
Mod.	Data Rate	NTX	CH.	Freq. (MHz)	Duty Factor (dB)		10log (500kHz /RBW) Factor (dB)		Average Power Density (dBm/500kHz)			Average PSD Limit (dBm/500kHz)		DG (dBi)		Pass /Fail
					Ant 1	Ant 2	Ant 1	Ant 2	Ant 1	Ant 2	SUM	Ant 1	Ant 2	Ant 1	Ant 2	
11a	6Mbps	1	149	5745	0.23	-	2.22	-	2.98	-		30.00	-	-1.00	-	Pass
11a	6Mbps	1	157	5785	0.23	-	2.22	-	2.75	-		30.00	-	-1.00	-	Pass
11a	6Mbps	1	165	5825	0.23	-	2.22	-	2.83	-		30.00	-	-1.00	-	Pass
HT20	MCS0	1	149	5745	0.25	-	2.22	-	-0.66	-		30.00	-	-1.00	-	Pass
HT20	MCS0	1	157	5785	0.25	-	2.22	-	-1.23	-		30.00	-	-1.00	-	Pass
HT20	MCS0	1	165	5825	0.25	-	2.22	-	-0.91	-		30.00	-	-1.00	-	Pass
HT40	MCS0	1	151	5755	0.50	-	2.22	-	-4.95	-		30.00	-	-1.00	-	Pass
HT40	MCS0	1	159	5795	0.50	-	2.22	-	-5.01	-		30.00	-	-1.00	-	Pass
VHT80	MCS0	1	155	5775	0.57	-	2.22	-	-8.63	-		30.00	-	-1.00	-	Pass



Appendix B. AC Conducted Emission Test Results

Test Engineer :	Blue Lan	Temperature :	25~26°C
		Relative Humidity :	55~58%

EUT Information

Report NO : 832501-01
 Test Mode : Mode 1
 Test Voltage : 120Vac/60Hz
 Phase : Line

Full Spectrum

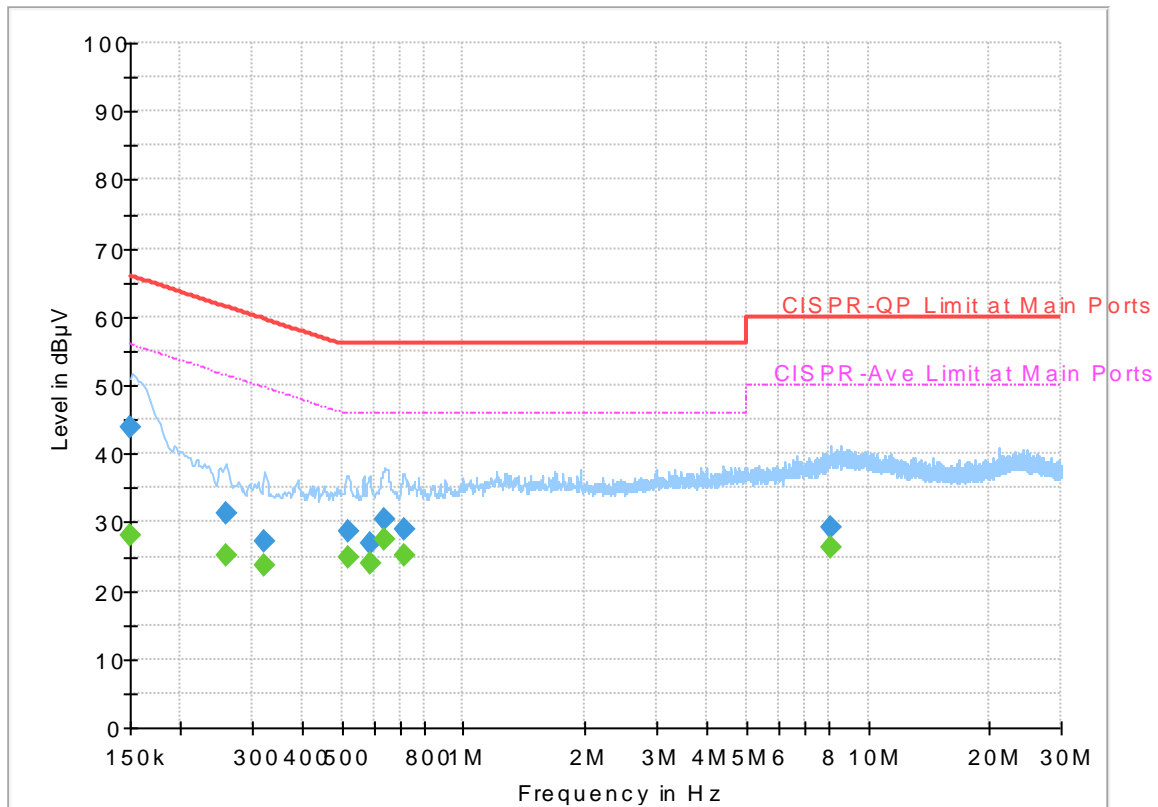

Final_Result

Frequency (MHz)	QuasiPeak (dBµV)	CAverage (dBµV)	Limit (dBµV)	Margin (dB)	Line	Filter	Corr. (dB)
0.150000	---	28.18	56.00	27.82	L1	OFF	19.5
0.150000	43.91	---	66.00	22.09	L1	OFF	19.5
0.258000	---	25.02	51.50	26.48	L1	OFF	19.5
0.258000	31.43	---	61.50	30.07	L1	OFF	19.5
0.323250	---	23.61	49.62	26.01	L1	OFF	19.5
0.323250	27.15	---	59.62	32.47	L1	OFF	19.5
0.516750	---	24.94	46.00	21.06	L1	OFF	19.5
0.516750	28.77	---	56.00	27.23	L1	OFF	19.5
0.586500	---	23.99	46.00	22.01	L1	OFF	19.5
0.586500	26.80	---	56.00	29.20	L1	OFF	19.5
0.640500	---	27.57	46.00	18.43	L1	OFF	19.5
0.640500	30.50	---	56.00	25.50	L1	OFF	19.5
0.714750	---	25.12	46.00	20.88	L1	OFF	19.5
0.714750	29.03	---	56.00	26.97	L1	OFF	19.5
8.070000	---	26.35	50.00	23.65	L1	OFF	19.7
8.070000	29.33	---	60.00	30.67	L1	OFF	19.7

EUT Information

Report NO : 832501-01
 Test Mode : Mode 1
 Test Voltage : 120Vac/60Hz
 Phase : Neutral

Full Spectrum

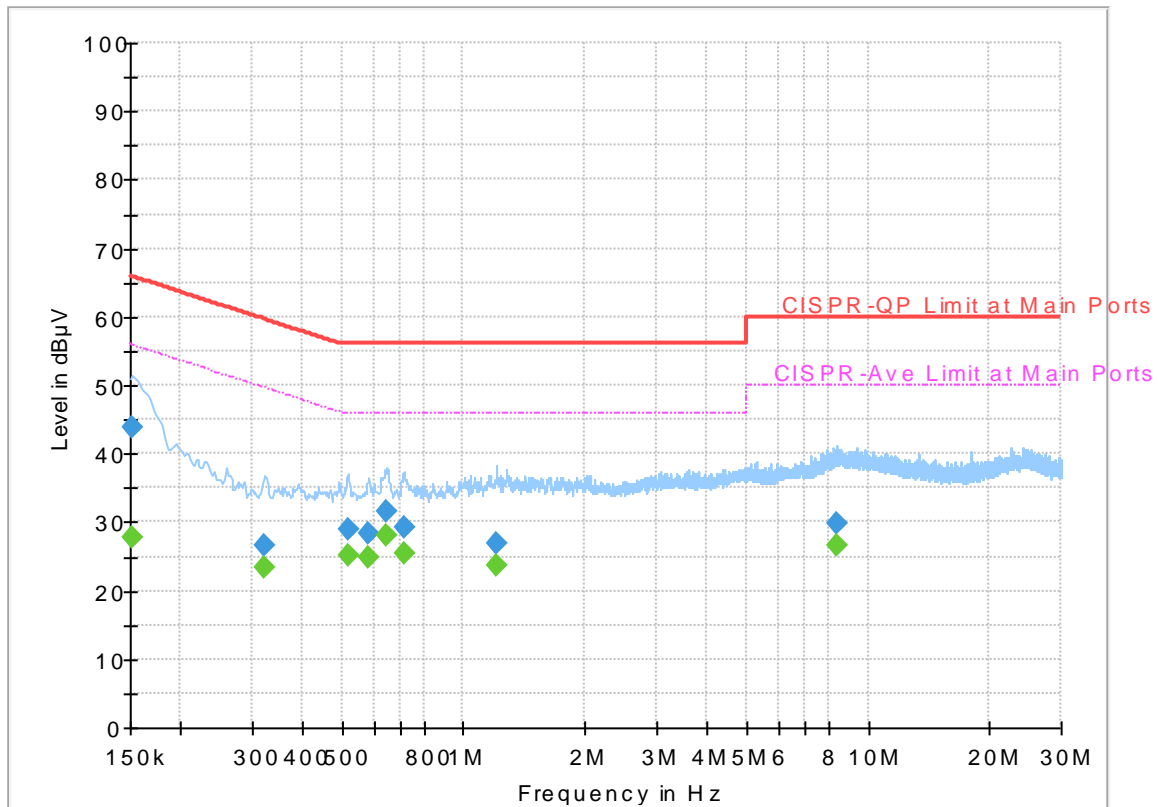

Final_Result

Frequency (MHz)	QuasiPeak (dBµV)	CAverage (dBµV)	Limit (dBµV)	Margin (dB)	Line	Filter	Corr. (dB)
0.152250	---	27.76	55.88	28.12	N	OFF	19.5
0.152250	44.00	---	65.88	21.88	N	OFF	19.5
0.323250	---	23.47	49.62	26.15	N	OFF	19.5
0.323250	26.68	---	59.62	32.94	N	OFF	19.5
0.519000	---	25.25	46.00	20.75	N	OFF	19.5
0.519000	28.96	---	56.00	27.04	N	OFF	19.5
0.584250	---	24.97	46.00	21.03	N	OFF	19.5
0.584250	28.31	---	56.00	27.69	N	OFF	19.5
0.647250	---	27.95	46.00	18.05	N	OFF	19.5
0.647250	31.68	---	56.00	24.32	N	OFF	19.5
0.714750	---	25.34	46.00	20.66	N	OFF	19.5
0.714750	29.27	---	56.00	26.73	N	OFF	19.5
1.205250	---	23.73	46.00	22.27	N	OFF	19.5
1.205250	26.93	---	56.00	29.07	N	OFF	19.5
8.369250	---	26.64	50.00	23.36	N	OFF	19.7
8.369250	29.89	---	60.00	30.11	N	OFF	19.7



Appendix C. Radiated Spurious Emission

Test Engineer :	Watt Tseng, Karl Hou, and Nick Yu	Temperature :	21~23°C
		Relative Humidity :	57~60%

Band 4 - 5725~5850MHz
WIFI 802.11a (Band Edge @ 3m)

WIFI Ant.	Note	Frequency (MHz)	Level (dBμV/m)	Over Limit (dB)	Limit Line (dBμV/m)	Read Level (dBμV)	Antenna Factor (dB/m)	Path Loss (dB)	Preamp Factor (dB)	Ant Pos (cm)	Table Pos (deg)	Peak Avg. (P/A)	Pol. (H/V)	
802.11a CH 149 5745MHz		5641.4	49.26	-18.94	68.2	41.94	32.19	6.35	31.22	114	360	P	H	
		5699.8	56.29	-48.76	105.05	48.91	32.27	6.36	31.25	114	360	P	H	
		5717.4	61.87	-48.2	110.07	54.48	32.29	6.36	31.26	114	360	P	H	
		5724.8	68.81	-52.93	121.74	61.39	32.31	6.37	31.26	114	360	P	H	
	*	5745	105.82	-	-	98.38	32.34	6.37	31.27	114	360	P	H	
	*	5745	94.69	-	-	87.25	32.34	6.37	31.27	114	360	A	H	
														H
														H
			5638.6	48.89	-19.31	68.2	41.57	32.19	6.35	31.22	100	308	P	V
			5699.8	50.5	-54.55	105.05	43.12	32.27	6.36	31.25	100	308	P	V
			5719.6	57.7	-52.99	110.69	50.28	32.31	6.37	31.26	100	308	P	V
			5725	64.07	-58.13	122.2	56.65	32.31	6.37	31.26	100	308	P	V
	*		5745	100.26	-	-	92.82	32.34	6.37	31.27	100	308	P	V
	*		5745	89.05	-	-	81.61	32.34	6.37	31.27	100	308	A	V
													V	
													V	



WIFI Ant. 1	Note	Frequency (MHz)	Level (dBµV/m)	Over Limit (dB)	Limit Line (dBµV/m)	Read Level (dBµV)	Antenna Factor (dB/m)	Path Loss (dB)	Preamp Factor (dB)	Ant Pos (cm)	Table Pos (deg)	Peak Avg. (P/A)	Pol. (H/V)
		5645.8	49.34	-18.86	68.2	42.02	32.19	6.35	31.22	100	359	P	H
		5654.4	49.64	-21.83	71.47	42.3	32.22	6.35	31.23	100	359	P	H
		5718.6	52.05	-58.36	110.41	44.63	32.31	6.37	31.26	100	359	P	H
		5723.6	52.35	-66.66	119.01	44.93	32.31	6.37	31.26	100	359	P	H
	*	5785	105.63	-	-	98.15	32.39	6.38	31.29	100	359	P	H
	*	5785	94.49	-	-	87.01	32.39	6.38	31.29	100	359	A	H
		5852	49.78	-67.86	117.64	42.2	32.48	6.42	31.32	100	359	P	H
		5858.6	50	-59.79	109.79	42.4	32.51	6.42	31.33	100	359	P	H
		5912.6	50.21	-27.14	77.35	42.52	32.58	6.46	31.35	100	359	P	H
		5947.6	49.43	-18.77	68.2	41.69	32.63	6.48	31.37	100	359	P	H
													H
													H
802.11a													
CH 157													
5785MHz		5618.4	49.8	-18.4	68.2	42.5	32.17	6.34	31.21	102	305	P	V
		5698.6	49.78	-54.39	104.17	42.4	32.27	6.36	31.25	102	305	P	V
		5719	49.24	-61.28	110.52	41.82	32.31	6.37	31.26	102	305	P	V
		5723.8	49	-70.46	119.46	41.58	32.31	6.37	31.26	102	305	P	V
	*	5785	101.11	-	-	93.63	32.39	6.38	31.29	102	305	P	V
	*	5785	89.81	-	-	82.33	32.39	6.38	31.29	102	305	A	V
		5852	49.47	-68.17	117.64	41.89	32.48	6.42	31.32	102	305	P	V
		5860.2	49.53	-59.81	109.34	41.93	32.51	6.42	31.33	102	305	P	V
		5918.2	49.39	-23.82	73.21	41.69	32.58	6.47	31.35	102	305	P	V
		5940	49.1	-19.1	68.2	41.36	32.63	6.48	31.37	102	305	P	V
													V
													V



WIFI Ant. 1	Note	Frequency (MHz)	Level (dBµV/m)	Over Limit (dB)	Limit Line (dBµV/m)	Read Level (dBµV)	Antenna Factor (dB/m)	Path Loss (dB)	Preamp Factor (dB)	Ant Pos (cm)	Table Pos (deg)	Peak Avg. (P/A)	Pol. (H/V)	
802.11a CH 165 5825MHz	*	5825	106.7	-	-	99.16	32.46	6.39	31.31	100	350	P	H	
	*	5825	95.35	-	-	87.81	32.46	6.39	31.31	100	350	A	H	
		5851.8	61.36	-56.74	118.1	53.78	32.48	6.42	31.32	100	350	P	H	
		5855.2	60.51	-50.23	110.74	52.9	32.51	6.42	31.32	100	350	P	H	
		5876.6	52.79	-51.22	104.01	45.16	32.53	6.43	31.33	100	350	P	H	
		5926.6	49.82	-18.38	68.2	42.1	32.6	6.47	31.35	100	350	P	H	
														H
														H
	*	5825	100.65	-	-	93.11	32.46	6.39	31.31	110	304	P	V	
	*	5825	89.44	-	-	81.9	32.46	6.39	31.31	110	304	A	V	
		5851.6	55.14	-63.41	118.55	47.56	32.48	6.42	31.32	110	304	P	V	
		5855.2	53.67	-57.07	110.74	46.06	32.51	6.42	31.32	110	304	P	V	
		5924.2	49.87	-18.92	68.79	42.15	32.6	6.47	31.35	110	304	P	V	
		5949.8	48.69	-19.51	68.2	40.95	32.63	6.48	31.37	110	304	P	V	
														V
														V
													V	
Remark	1. No other spurious found. 2. All results are PASS against Peak and Average limit line.													



Band 4 5725~5850MHz
WIFI 802.11a (Harmonic @ 3m)

WIFI Ant. 1	Note	Frequency (MHz)	Level (dBμV/m)	Over Limit (dB)	Limit Line (dBμV/m)	Read Level (dBμV)	Antenna Factor (dB/m)	Path Loss (dB)	Preamp Factor (dB)	Ant Pos (cm)	Table Pos (deg)	Peak Avg. (P/A)	Pol. (H/V)
802.11a CH 149 5745MHz		11490	46.87	-27.13	74	58.03	40.11	10.33	61.6	100	0	P	H
		17235	52.75	-15.45	68.2	54.26	41.54	12.73	55.78	100	0	P	H
													H
													H
		11490	48.05	-25.95	74	59.21	40.11	10.33	61.6	100	0	P	V
		17235	53.35	-14.85	68.2	54.86	41.54	12.73	55.78	100	0	P	V
													V
													V
802.11a CH 157 5785MHz		11570	48.05	-25.95	74	59.5	39.93	10.37	61.75	100	0	P	H
		17355	53.24	-14.96	68.2	53.98	41.96	12.82	55.52	100	0	P	H
													H
													H
		11570	47.42	-26.58	74	58.87	39.93	10.37	61.75	100	0	P	V
		17355	53.86	-14.34	68.2	54.6	41.96	12.82	55.52	100	0	P	V
													V
													V
802.11a CH 165 5825MHz		11650	48.88	-25.12	74	60.63	39.77	10.41	61.93	100	0	P	H
		17475	54.95	-13.25	68.2	54.92	42.38	12.91	55.26	100	0	P	H
													H
													H
		11650	48.15	-25.85	74	59.9	39.77	10.41	61.93	100	0	P	V
		17475	55.3	-12.9	68.2	55.27	42.38	12.91	55.26	100	0	P	V
													V
													V
Remark	1. No other spurious found. 2. All results are PASS against Peak and Average limit line.												



Band 4 5725~5850MHz
WIFI 802.11n HT20 (Band Edge @ 3m)

WIFI Ant. 1	Note	Frequency (MHz)	Level (dBμV/m)	Over Limit (dB)	Limit Line (dBμV/m)	Read Level (dBμV)	Antenna Factor (dB/m)	Path Loss (dB)	Preamp Factor (dB)	Ant Pos (cm)	Table Pos (deg)	Peak Avg. (P/A)	Pol. (H/V)	
802.11n HT20 CH 149 5745MHz		5608.4	49.98	-18.22	68.2	42.71	32.14	6.34	31.21	100	346	P	H	
		5698	50.83	-52.9	103.73	43.45	32.27	6.36	31.25	100	346	P	H	
		5716.8	55.32	-54.59	109.91	47.93	32.29	6.36	31.26	100	346	P	H	
		5723.8	58.4	-61.06	119.46	50.98	32.31	6.37	31.26	100	346	P	H	
	*	5745	102.44	-	-	95	32.34	6.37	31.27	100	346	P	H	
	*	5745	90.94	-	-	83.5	32.34	6.37	31.27	100	346	A	H	
														H
														H
			5600.4	49.4	-18.8	68.2	42.12	32.14	6.34	31.2	100	292	P	V
			5675.4	49.66	-37.38	87.04	42.3	32.24	6.35	31.23	100	292	P	V
			5715.2	52.16	-57.3	109.46	44.77	32.29	6.36	31.26	100	292	P	V
			5725	54.68	-67.52	122.2	47.26	32.31	6.37	31.26	100	292	P	V
	*		5745	100.25	-	-	92.81	32.34	6.37	31.27	100	292	P	V
	*		5745	88.78	-	-	81.34	32.34	6.37	31.27	100	292	A	V
													V	
													V	



WIFI Ant. 1	Note	Frequency (MHz)	Level (dBμV/m)	Over Limit (dB)	Limit Line (dBμV/m)	Read Level (dBμV)	Antenna Factor (dB/m)	Path Loss (dB)	Preamp Factor (dB)	Ant Pos (cm)	Table Pos (deg)	Peak Avg. (P/A)	Pol. (H/V)
		5602.4	49.41	-18.79	68.2	42.13	32.14	6.34	31.2	101	344	P	H
		5692.8	49.59	-50.3	99.89	42.21	32.27	6.36	31.25	101	344	P	H
		5710.6	49.56	-58.61	108.17	42.17	32.29	6.36	31.26	101	344	P	H
		5724.6	49.51	-71.78	121.29	42.09	32.31	6.37	31.26	101	344	P	H
	*	5785	102.12	-	-	94.64	32.39	6.38	31.29	101	344	P	H
	*	5785	90.67	-	-	83.19	32.39	6.38	31.29	101	344	A	H
		5852.4	49.79	-66.94	116.73	42.21	32.48	6.42	31.32	101	344	P	H
		5856.6	49.41	-60.94	110.35	41.8	32.51	6.42	31.32	101	344	P	H
		5924.2	49.53	-19.26	68.79	41.81	32.6	6.47	31.35	101	344	P	H
		5933	49.42	-18.78	68.2	41.7	32.6	6.47	31.35	101	344	P	H
802.11n													H
HT20													H
CH 157		5633.4	50.11	-18.09	68.2	42.79	32.19	6.35	31.22	100	291	P	V
5785MHz		5670	49.38	-33.66	83.04	42.02	32.24	6.35	31.23	100	291	P	V
		5709.2	50.41	-57.37	107.78	43.02	32.29	6.36	31.26	100	291	P	V
		5724.6	49.99	-71.3	121.29	42.57	32.31	6.37	31.26	100	291	P	V
	*	5785	100.53	-	-	93.05	32.39	6.38	31.29	100	291	P	V
	*	5785	88.96	-	-	81.48	32.39	6.38	31.29	100	291	A	V
		5854	48.47	-64.61	113.08	40.86	32.51	6.42	31.32	100	291	P	V
		5867	49.64	-57.8	107.44	42.03	32.51	6.43	31.33	100	291	P	V
		5913.2	49.41	-27.49	76.9	41.72	32.58	6.46	31.35	100	291	P	V
		5932.4	49.2	-19	68.2	41.48	32.6	6.47	31.35	100	291	P	V
													V
													V



WIFI Ant. 1	Note	Frequency (MHz)	Level (dBµV/m)	Over Limit (dB)	Limit Line (dBµV/m)	Read Level (dBµV)	Antenna Factor (dB/m)	Path Loss (dB)	Preamp Factor (dB)	Ant Pos (cm)	Table Pos (deg)	Peak Avg. (P/A)	Pol. (H/V)	
802.11n HT20 CH 165 5825MHz	*	5825	102.62	-	-	95.08	32.46	6.39	31.31	100	52	P	H	
	*	5825	90.97	-	-	83.43	32.46	6.39	31.31	100	52	A	H	
		5851.2	51.74	-67.72	119.46	44.16	32.48	6.42	31.32	100	52	P	H	
		5857.6	52.01	-58.06	110.07	44.4	32.51	6.42	31.32	100	52	P	H	
		5876.6	50.68	-53.33	104.01	43.05	32.53	6.43	31.33	100	52	P	H	
		5932.8	49.57	-18.63	68.2	41.85	32.6	6.47	31.35	100	52	P	H	
														H
														H
	*	5825	100.74	-	-	93.2	32.46	6.39	31.31	100	293	P	V	
	*	5825	89.26	-	-	81.72	32.46	6.39	31.31	100	293	A	V	
		5853	50.23	-65.13	115.36	42.65	32.48	6.42	31.32	100	293	P	V	
		5861.8	49.96	-58.93	108.89	42.35	32.51	6.43	31.33	100	293	P	V	
		5886.2	49.91	-46.97	96.88	42.28	32.53	6.44	31.34	100	293	P	V	
		5932.6	48.36	-19.84	68.2	40.64	32.6	6.47	31.35	100	293	P	V	
													V	
													V	
Remark	1. No other spurious found. 2. All results are PASS against Peak and Average limit line.													



Band 4 5725~5850MHz
WIFI 802.11n HT20 (Harmonic @ 3m)

WIFI Ant. 1	Note	Frequency (MHz)	Level (dBμV/m)	Over Limit (dB)	Limit Line (dBμV/m)	Read Level (dBμV)	Antenna Factor (dB/m)	Path Loss (dB)	Preamp Factor (dB)	Ant Pos (cm)	Table Pos (deg)	Peak Avg. (P/A)	Pol. (H/V)
802.11n HT20 CH 149 5745MHz		11490	46.21	-27.79	74	57.37	40.11	10.33	61.6	100	0	P	H
		17235	47.79	-20.41	68.2	49.3	41.54	12.73	55.78	100	0	P	H
													H
													H
		11490	47.23	-26.77	74	58.39	40.11	10.33	61.6	100	0	P	V
		17235	47.56	-20.64	68.2	49.07	41.54	12.73	55.78	100	0	P	V
													V
													V
802.11n HT20 CH 157 5785MHz		11570	47.02	-26.98	74	58.47	39.93	10.37	61.75	100	0	P	H
		17355	48.67	-19.53	68.2	49.41	41.96	12.82	55.52	100	0	P	H
													H
													H
		11570	45.88	-28.12	74	57.33	39.93	10.37	61.75	100	0	P	V
		17355	49.08	-19.12	68.2	49.82	41.96	12.82	55.52	100	0	P	V
													V
													V
802.11n HT20 CH 165 5825MHz		11650	47.1	-26.9	74	58.85	39.77	10.41	61.93	100	0	P	H
		17475	47.96	-20.24	68.2	47.93	42.38	12.91	55.26	100	0	P	H
													H
													H
		11650	47.19	-26.81	74	58.94	39.77	10.41	61.93	100	0	P	V
		17475	47.75	-20.45	68.2	47.72	42.38	12.91	55.26	100	0	P	V
													V
													V
Remark	1. No other spurious found. 2. All results are PASS against Peak and Average limit line.												



Band 4 5725~5850MHz
WIFI 802.11n HT40 (Band Edge @ 3m)

WIFI Ant. 1	Note	Frequency (MHz)	Level (dBμV/m)	Over Limit (dB)	Limit Line (dBμV/m)	Read Level (dBμV)	Antenna Factor (dB/m)	Path Loss (dB)	Preamp Factor (dB)	Ant Pos (cm)	Table Pos (deg)	Peak Avg. (P/A)	Pol. (H/V)
		5646.4	49.77	-18.43	68.2	42.45	32.19	6.35	31.22	100	345	P	H
		5697.2	51.47	-51.67	103.14	44.09	32.27	6.36	31.25	100	345	P	H
		5718.2	56.88	-53.42	110.3	49.46	32.31	6.37	31.26	100	345	P	H
		5725	57.4	-64.8	122.2	49.98	32.31	6.37	31.26	100	345	P	H
	*	5755	97.75	-	-	90.29	32.36	6.37	31.27	100	345	P	H
	*	5755	86.96	-	-	79.5	32.36	6.37	31.27	100	345	A	H
		5854.2	48.79	-63.83	112.62	41.18	32.51	6.42	31.32	100	345	P	H
		5865.8	49.08	-58.69	107.77	41.47	32.51	6.43	31.33	100	345	P	H
		5882	49.12	-50.88	100	41.48	32.53	6.44	31.33	100	345	P	H
		5949.6	49.46	-18.74	68.2	41.72	32.63	6.48	31.37	100	345	P	H
													H
													H
802.11n													
HT40													
CH 151		5626.2	49.39	-18.81	68.2	42.09	32.17	6.34	31.21	100	292	P	V
5755MHz		5699.8	49.95	-55.1	105.05	42.57	32.27	6.36	31.25	100	292	P	V
		5719.4	54.06	-56.57	110.63	46.64	32.31	6.37	31.26	100	292	P	V
		5724	55.03	-64.89	119.92	47.61	32.31	6.37	31.26	100	292	P	V
	*	5755	95.63	-	-	88.17	32.36	6.37	31.27	100	292	P	V
	*	5755	84.97	-	-	77.51	32.36	6.37	31.27	100	292	A	V
		5851.8	49.4	-68.7	118.1	41.82	32.48	6.42	31.32	100	292	P	V
		5872.4	49.2	-56.73	105.93	41.57	32.53	6.43	31.33	100	292	P	V
		5892.2	49.75	-42.69	92.44	42.09	32.56	6.44	31.34	100	292	P	V
		5941	48.93	-19.27	68.2	41.19	32.63	6.48	31.37	100	292	P	V
													V
													V



WIFI Ant. 1	Note	Frequency (MHz)	Level (dBµV/m)	Over Limit (dB)	Limit Line (dBµV/m)	Read Level (dBµV)	Antenna Factor (dB/m)	Path Loss (dB)	Preamp Factor (dB)	Ant Pos (cm)	Table Pos (deg)	Peak Avg. (P/A)	Pol. (H/V)
		5638.8	49.16	-19.04	68.2	41.84	32.19	6.35	31.22	100	53	P	H
		5680	49.51	-40.93	90.44	42.17	32.24	6.35	31.25	100	53	P	H
		5715.8	49.09	-60.54	109.63	41.7	32.29	6.36	31.26	100	53	P	H
		5720.8	49.8	-62.82	112.62	42.38	32.31	6.37	31.26	100	53	P	H
	*	5795	97.55	-	-	90.05	32.41	6.38	31.29	100	53	P	H
	*	5795	86.81	-	-	79.31	32.41	6.38	31.29	100	53	A	H
		5853.8	53.42	-60.12	113.54	45.81	32.51	6.42	31.32	100	53	P	H
		5860.6	54.48	-54.75	109.23	46.88	32.51	6.42	31.33	100	53	P	H
		5877.4	50.34	-53.08	103.42	42.71	32.53	6.43	31.33	100	53	P	H
		5931.4	49.63	-18.57	68.2	41.91	32.6	6.47	31.35	100	53	P	H
													H
													H
802.11n													
HT40													
CH 159		5618.6	48.86	-19.34	68.2	41.56	32.17	6.34	31.21	100	306	P	V
5795MHz		5660.4	48.54	-27.38	75.92	41.2	32.22	6.35	31.23	100	306	P	V
		5713.4	48.8	-60.15	108.95	41.41	32.29	6.36	31.26	100	306	P	V
		5720.8	48.85	-63.77	112.62	41.43	32.31	6.37	31.26	100	306	P	V
	*	5795	95.36	-	-	87.86	32.41	6.38	31.29	100	306	P	V
	*	5795	84.54	-	-	77.04	32.41	6.38	31.29	100	306	A	V
		5853.8	51.28	-62.26	113.54	43.67	32.51	6.42	31.32	100	306	P	V
		5863.8	50.36	-57.97	108.33	42.75	32.51	6.43	31.33	100	306	P	V
		5914.4	49.47	-26.55	76.02	41.78	32.58	6.46	31.35	100	306	P	V
		5933.6	49.52	-18.68	68.2	41.79	32.6	6.48	31.35	100	306	P	V
													V
													V
Remark	1. No other spurious found. 2. All results are PASS against Peak and Average limit line.												



Band 4 5725~5850MHz
WIFI 802.11n HT40 (Harmonic @ 3m)

WIFI Ant. 1	Note	Frequency (MHz)	Level (dBμV/m)	Over Limit (dB)	Limit Line (dBμV/m)	Read Level (dBμV)	Antenna Factor (dB/m)	Path Loss (dB)	Preamp Factor (dB)	Ant Pos (cm)	Table Pos (deg)	Peak Avg. (P/A)	Pol. (H/V)
802.11n HT40 CH 151 5755MHz		11510	46.78	-27.22	74	57.96	40.1	10.34	61.62	100	0	P	H
		17265	47.26	-20.94	68.2	48.57	41.66	12.75	55.72	100	0	P	H
													H
													H
		11510	46.14	-27.86	74	57.32	40.1	10.34	61.62	100	0	P	V
		17265	46.88	-21.32	68.2	48.19	41.66	12.75	55.72	100	0	P	V
													V
													V
802.11n HT40 CH 159 5795MHz		11590	45.49	-28.51	74	57.02	39.89	10.38	61.8	100	0	P	H
		17385	47.14	-21.06	68.2	47.67	42.08	12.84	55.45	100	0	P	H
													H
													H
		11590	45.53	-28.47	74	57.06	39.89	10.38	61.8	100	0	P	V
		17385	46.72	-21.48	68.2	47.25	42.08	12.84	55.45	100	0	P	V
													V
													V
Remark	1. No other spurious found. 2. All results are PASS against Peak and Average limit line.												



Band 4 5725~5850MHz
WIFI 802.11ac VHT80 (Band Edge @ 3m)

WIFI Ant. 1	Note	Frequency (MHz)	Level (dBμV/m)	Over Limit (dB)	Limit Line (dBμV/m)	Read Level (dBμV)	Antenna Factor (dB/m)	Path Loss (dB)	Preamp Factor (dB)	Ant Pos (cm)	Table Pos (deg)	Peak Avg. (P/A)	Pol. (H/V)	
		5620.4	49.61	-18.59	68.2	42.31	32.17	6.34	31.21	100	346	P	H	
		5700	54.57	-50.63	105.2	47.19	32.27	6.36	31.25	100	346	P	H	
		5719.2	57.8	-52.78	110.58	50.38	32.31	6.37	31.26	100	346	P	H	
		5720.4	58	-53.71	111.71	50.58	32.31	6.37	31.26	100	346	P	H	
	*	5775	93.98	-	-	86.49	32.39	6.38	31.28	100	346	P	H	
	*	5775	83.42	-	-	75.93	32.39	6.38	31.28	100	346	A	H	
		5850.8	53.01	-67.37	120.38	45.43	32.48	6.42	31.32	100	346	P	H	
		5855.2	51.05	-59.69	110.74	43.44	32.51	6.42	31.32	100	346	P	H	
		5875.2	49.52	-55.53	105.05	41.89	32.53	6.43	31.33	100	346	P	H	
		5935.4	49.37	-18.83	68.2	41.66	32.6	6.48	31.37	100	346	P	H	
802.11ac VHT80 CH 155 5775MHz													H	
													H	
			5631.6	49.27	-18.93	68.2	41.97	32.17	6.35	31.22	100	290	P	V
			5696	52.2	-50.05	102.25	44.82	32.27	6.36	31.25	100	290	P	V
			5719.8	55.75	-54.99	110.74	48.33	32.31	6.37	31.26	100	290	P	V
			5720.6	54.75	-57.42	112.17	47.33	32.31	6.37	31.26	100	290	P	V
		*	5775	91.75	-	-	84.26	32.39	6.38	31.28	100	290	P	V
		*	5775	80.96	-	-	73.47	32.39	6.38	31.28	100	290	A	V
			5853.4	50.81	-63.64	114.45	43.23	32.48	6.42	31.32	100	290	P	V
			5855.8	50.85	-59.73	110.58	43.24	32.51	6.42	31.32	100	290	P	V
			5923.8	49.81	-19.27	69.08	42.09	32.6	6.47	31.35	100	290	P	V
			5934.6	50.05	-18.15	68.2	42.34	32.6	6.48	31.37	100	290	P	V
														V
														V
	Remark	1. No other spurious found. 2. All results are PASS against Peak and Average limit line.												



Band 4 5725~5850MHz

WIFI 802.11ac VHT80 (Harmonic @ 3m)

WIFI Ant. 1	Note	Frequency (MHz)	Level (dBμV/m)	Over Limit (dB)	Limit Line (dBμV/m)	Read Level (dBμV)	Antenna Factor (dB/m)	Path Loss (dB)	Preamp Factor (dB)	Ant Pos (cm)	Table Pos (deg)	Peak Avg. (P/A)	Pol. (H/V)	
802.11ac VHT80 CH 155 5775MHz		11550	45.74	-28.26	74	57.11	39.98	10.36	61.71	100	0	P	H	
		17325	47.3	-20.9	68.2	48.25	41.84	12.79	55.58	100	0	P	H	
													H	
													H	
			11550	46.52	-27.48	74	57.89	39.98	10.36	61.71	100	0	P	V
			17325	47.35	-20.85	68.2	48.3	41.84	12.79	55.58	100	0	P	V
														V
														V
Remark	1. No other spurious found. 2. All results are PASS against Peak and Average limit line.													



Note symbol

*	Fundamental Frequency which can be ignored. However, the level of any unwanted emissions shall not exceed the level of the fundamental frequency.
!	Test result is over limit line.
P/A	Peak or Average
H/V	Horizontal or Vertical



A calculation example for radiated spurious emission is shown as below:

WIFI	Note	Frequency	Level	Over	Limit	Read	Antenna	Path	Preamp	Ant	Table	Peak	Pol.
Ant.				Limit	Line	Level	Factor	Loss	Factor	Pos	Pos	Avg.	
1		(MHz)	(dBμV/m)	(dB)	(dBμV/m)	(dBμV)	(dB/m)	(dB)	(dB)	(cm)	(deg)	(P/A)	(H/V)
802.11b		2390	55.45	-18.55	74	54.51	32.22	4.58	35.86	103	308	P	H
CH 01													
2412MHz		2390	43.54	-10.46	54	42.6	32.22	4.58	35.86	103	308	A	H

1. Path Loss(dB) = Cable loss(dB) + Filter loss(dB) + Attenuator loss(dB)
2. Level(dBμV/m) = Antenna Factor(dB/m) + Path Loss(dB) + Read Level(dBμV) - Preamp Factor(dB)
3. Over Limit(dB) = Level(dBμV/m) – Limit Line(dBμV/m)

For Peak Limit @ 2390MHz:

1. Level(dBμV/m)
= Antenna Factor(dB/m) + Path Loss(dB) + Read Level(dBμV) - Preamp Factor(dB)
= 32.22(dB/m) + 4.58(dB) + 54.51(dBμV) – 35.86 (dB)
= 55.45 (dBμV/m)
2. Over Limit(dB)
= Level(dBμV/m) – Limit Line(dBμV/m)
= 55.45(dBμV/m) – 74(dBμV/m)
= -18.55(dB)

For Average Limit @ 2390MHz:

1. Level(dBμV/m)
= Antenna Factor(dB/m) + Path Loss(dB) + Read Level(dBμV) - Preamp Factor(dB)
= 32.22(dB/m) + 4.58(dB) + 42.6(dBμV) – 35.86 (dB)
= 43.54 (dBμV/m)
2. Over Limit(dB) = Level(dBμV/m) – Limit Line(dBμV/m)
= 43.54(dBμV/m) – 54(dBμV/m)
= -10.46(dB)

Both peak and average measured complies with the limit line, so test result is “PASS”.



Appendix D. Radiated Spurious Emission Plots

Test Engineer :	Watt Tseng, Karl Hou, and Nick Yu	Temperature :	21~23°C
		Relative Humidity :	57~60%

Note symbol

-L	Low channel location
-R	High channel location



Band 4 - 5725~5850MHz
WIFI 802.11a (Band Edge @ 3m)

WIFI	Band 4 5725~5850MHz Band Edge @ 3m	
ANT	802.11a CH149 5745MHz	
1	Horizontal	Fundamental
Peak	<p>Site : 03CH12-HY Condition : PEAK_BE(94)_16-24 3m HORN_912D0_1328 HORIZONTAL RBW:3000.000kHz VBW:3000.000kHz SWT:Auto</p>	<p>Site : 03CH12-HY Condition : PEAK(FUN1) 3m HORN_912D0_1328 HORIZONTAL RBW:3000.000kHz VBW:3000.000kHz SWT:Auto</p>



WIFI	Band 4 5725~5850MHz Band Edge @ 3m	
ANT	802.11a CH149 5745MHz	
1	Vertical	Fundamental
Peak	<p>Site : 03CH12-HY Condition : PEAK_18(0.1, 12.24) : RBW:3000.000kHz VBW:3000.000kHz SWT:Auto</p>	<p>Site : 03CH12-HY Condition : PEAK(0.00) : RBW:3000.000kHz VBW:3000.000kHz SWT:Auto</p>

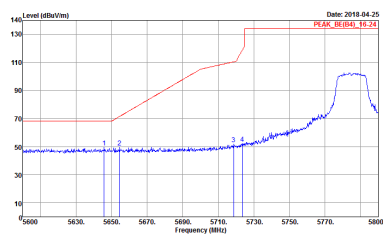
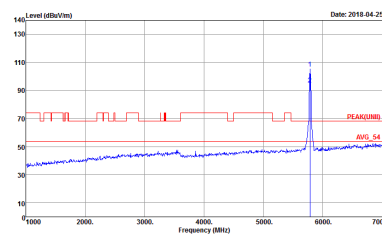
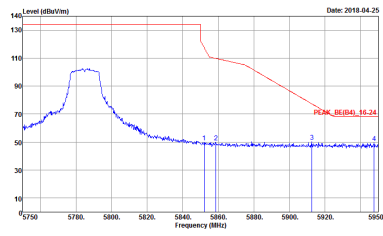

WIFI	Band 4 5725~5850MHz Band Edge @ 3m	
ANT	802.11a CH157 5785MHz	
1	Horizontal	Fundamental
<p>Peak</p>	 <p>Site : 03CH12-HY Condition : PEAK_BE(B4)_16-24 3m HORN_9120D_1328 HORIZONTAL : RBW:1000.000KHz VBW:3000.000KHz SWT:Auto</p>	 <p>Site : 03CH12-HY Condition : PEAK(FUNTI) 3m HORN_9120D_1328 HORIZONTAL : RBW:1000.000KHz VBW:3000.000KHz SWT:Auto</p>
<p>Peak</p>	 <p>Site : 03CH12-HY Condition : PEAK_BE(B4)_16-24 3m HORN_9120D_1328 HORIZONTAL : RBW:1000.000KHz VBW:3000.000KHz SWT:Auto</p>	<p>Left blank</p>



WIFI	Band 4 5725~5850MHz Band Edge @ 3m	
ANT	802.11a CH157 5785MHz	
1	Vertical	Fundamental
<p>Peak</p>		
<p>Peak</p>		<p>Left blank</p>



WIFI	Band 4 5725~5850MHz Band Edge @ 3m	
ANT	802.11a CH165 5825MHz	
1	Horizontal	Fundamental
Peak	<p>Site : 03CH12-HV Condition : PEAK_BE(B4)_16-24 3m HORN_91200_1328 HORIZONTAL : RBW:1000.000kHz VBW:3000.000kHz SWT:Auto</p>	<p>Site : 03CH12-HV Condition : PEAK(FUN1) 3m HORN_91200_1328 HORIZONTAL : RBW:1000.000kHz VBW:3000.000kHz SWT:Auto</p>



WIFI	Band 4 5725~5850MHz Band Edge @ 3m	
ANT	802.11a CH165 5825MHz	
1	Vertical	Fundamental
Peak	<p>Site : 03CH12-HY Condition : PEAK_BE(B4)_16-24 3m HORN_91200_1328 VERTICAL : RBW:1000.000kHz VBW:3000.000kHz SWT:Auto</p>	<p>Site : 03CH12-HY Condition : PEAK(FUNB) 3m HORN_91200_1328 VERTICAL : RBW:1000.000kHz VBW:3000.000kHz SWT:Auto</p>



Band 4 5725~5850MHz
WIFI 802.11n HT20 (Band Edge @ 3m)

WIFI	Band 4 5725~5850MHz Band Edge @ 3m	
ANT	802.11n HT20 CH149 5745MHz	
1	Horizontal	Fundamental
Peak	<p>Site Condition : 03CH12-44Y : PEAK_BE(B4)_16-24 3m HORN_9120D_1328 HORIZONTAL : RBW:1000.000KHz VBW:3000.000KHz SWT:Auto</p>	<p>Site Condition : 03CH12-44Y : PEAK(UNIT) 3m HORN_9120D_1328 HORIZONTAL : RBW:1000.000KHz VBW:3000.000KHz SWT:Auto</p>

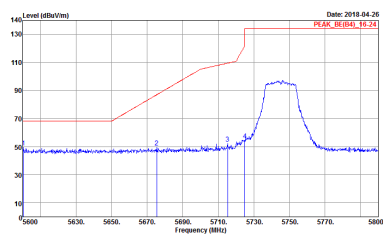
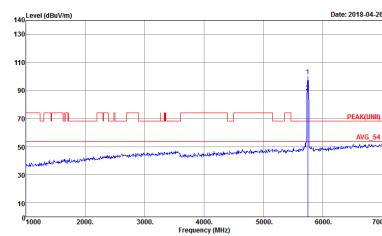

WIFI	Band 4 5725~5850MHz Band Edge @ 3m	
ANT	802.11n HT20 CH149 5745MHz	
1	Vertical	Fundamental
<p>Peak</p>	 <p>Site : 03CH12-HY Condition : PEAK_18(04_12_24) 16-24 3m 14ORN_91200_1328 VERTICAL : RBW:1000.000kHz VBW:3000.000kHz SWT:Auto</p>	 <p>Site : 03CH12-HY Condition : PEAK(04) 3m 14ORN_91200_1328 VERTICAL : RBW:1000.000kHz VBW:3000.000kHz SWT:Auto</p>



WIFI	Band 4 5725~5850MHz Band Edge @ 3m	
ANT	802.11n HT20 CH157 5785MHz	
1	Horizontal	Fundamental
<p>Peak</p>		
<p>Peak</p>		<p>Left blank</p>



WIFI	Band 4 5725~5850MHz Band Edge @ 3m	
ANT	802.11n HT20 CH157 5785MHz	
1	Vertical	Fundamental
<p>Peak</p>		
<p>Peak</p>		<p>Left blank</p>



WIFI	Band 4 5725~5850MHz Band Edge @ 3m	
ANT	802.11n HT20 CH165 5825MHz	
1	Horizontal	Fundamental
Peak	<p>Site : 03CH12-HY Condition : PEAK_BE(B4)_16-24 3m HORN_91200_1328 HORIZONTAL : RBW:1000.000kHz VBW:3000.000kHz SWT:Auto</p>	<p>Site : 03CH12-HY Condition : PEAK(FUNTI) 3m HORN_91200_1328 HORIZONTAL : RBW:1000.000kHz VBW:3000.000kHz SWT:Auto</p>



WIFI	Band 4 5725~5850MHz Band Edge @ 3m	
ANT	802.11n HT20 CH165 5825MHz	
1	Vertical	Fundamental
Peak	<p>Site : 03CH12-HY Condition : PEAK_BE(B4)_16-24 3m HORN_91200_1328 VERTICAL : RBW:1000.000kHz VBW:3000.000kHz SWT:Auto</p>	<p>Site : 03CH12-HY Condition : PEAK(UNIT) 3m HORN_91200_1328 VERTICAL : RBW:1000.000kHz VBW:3000.000kHz SWT:Auto</p>



Band 4 5725~5850MHz
WIFI 802.11n HT40 (Band Edge @ 3m)

WIFI	Band 4 5725~5850MHz Band Edge @ 3m	
ANT	802.11n HT40 CH151 5755MHz	
1	Horizontal	Fundamental
Peak	<p>Site : 03CH12-HY Condition : PEAK_BE(B4)_16-24 3m HORN_9120D_1328 HORIZONTAL : RBW:1000.000KHz VBW:3000.000KHz SWT:Auto</p>	<p>Site : 03CH12-HY Condition : PEAK(UNIT) 3m HORN_9120D_1328 HORIZONTAL : RBW:1000.000KHz VBW:3000.000KHz SWT:Auto</p>
Peak	<p>Site : 03CH12-HY Condition : PEAK_BE(B4)_16-24 3m HORN_9120D_1328 HORIZONTAL : RBW:1000.000KHz VBW:3000.000KHz SWT:Auto</p>	Left blank



WIFI	Band 4 5725~5850MHz Band Edge @ 3m	
ANT	802.11n HT40 CH151 5755MHz	
1	Vertical	Fundamental
<p>Peak</p>	<p>Site : 03CH12-HY Condition : PEAK_BE(04)_16-24 3m HORN_9120D_1328 VERTICAL : RBW:1000.000KHz VBW:3000.000KHz SWT:Auto</p>	<p>Site : 03CH12-HY Condition : PEAK(UN1) 3m HORN_9120D_1328 VERTICAL : RBW:1000.000KHz VBW:3000.000KHz SWT:Auto</p>
<p>Peak</p>	<p>Site : 03CH12-HY Condition : PEAK_BE(04)_16-24 3m HORN_9120D_1328 VERTICAL : RBW:1000.000KHz VBW:3000.000KHz SWT:Auto</p>	<p>Left blank</p>



WIFI	Band 4 5725~5850MHz Band Edge @ 3m	
ANT	802.11n HT40 CH159 5795MHz	
1	Horizontal	Fundamental
<p>Peak</p>		
<p>Peak</p>		<p>Left blank</p>



WIFI	Band 4 5725~5850MHz Band Edge @ 3m	
ANT	802.11n HT40 CH159 5795MHz	
1	Vertical	Fundamental
<p>Peak</p>	<p>Site : 03CH12-HY Condition : PEAK_BE(B4)_16-24 3m HORN_91200_1328 VERTICAL : RBW:1000.000kHz VBW:3000.000kHz SWT:Auto</p>	<p>Site : 03CH12-HY Condition : PEAK(FUNTI) 3m HORN_91200_1328 VERTICAL : RBW:1000.000kHz VBW:3000.000kHz SWT:Auto</p>
<p>Peak</p>	<p>Site : 03CH12-HY Condition : PEAK_BE(B4)_16-24 3m HORN_91200_1328 VERTICAL : RBW:1000.000kHz VBW:3000.000kHz SWT:Auto</p>	<p>Left blank</p>



Band 4 5725~5850MHz
WIFI 802.11ac VHT80 (Band Edge @ 3m)

WIFI	Band 4 5725~5850MHz Band Edge @ 3m	
ANT	802.11ac VHT80 CH155 5775MHz	
1	Horizontal	Fundamental
Peak	<p>Site Condition : 03CH12-HY : PEAK_BE(B4)_16-24 3m HORN_9120D_1328 HORIZONTAL : RBW:1000.000kHz VBW:3000.000kHz SWT:Auto</p>	<p>Site Condition : 03CH12-HY : PEAK(UNIT) 3m HORN_9120D_1328 HORIZONTAL : RBW:1000.000kHz VBW:3000.000kHz SWT:Auto</p>
Peak	<p>Site Condition : 03CH12-HY : PEAK_BE(B4)_16-24 3m HORN_9120D_1328 HORIZONTAL : RBW:1000.000kHz VBW:3000.000kHz SWT:Auto</p>	Left blank



WIFI	Band 4 5725~5850MHz Band Edge @ 3m	
ANT	802.11ac VHT80 CH155 5775MHz	
1	Vertical	Fundamental
Peak	<p>Site : 03CH12-HY Condition : PEAK_BE(B4)_16-24 3m HORN_9120D_1328 VERTICAL : RBW:1000.000KHz VBW:3000.000KHz SWT:Auto</p>	<p>Site : 03CH12-HY Condition : PEAK(FUNTI) 3m HORN_9120D_1328 VERTICAL : RBW:1000.000KHz VBW:3000.000KHz SWT:Auto</p>
Peak	<p>Site : 03CH12-HY Condition : PEAK_BE(B4)_16-24 3m HORN_9120D_1328 VERTICAL : RBW:1000.000KHz VBW:3000.000KHz SWT:Auto</p>	Left blank



Band 4 - 5725~5850MHz
WIFI 802.11a (Harmonic @ 3m)

WIFI	Band 4 5725~5850MHz Harmonic @ 3m	
ANT	802.11a CH149 5745MHz	
1	Horizontal	Vertical
Peak	<p>Site : 03CH12-HY Condition : PEAK(UNIT) 3m HORN_9120D_1328 HORIZONTAL Detector : Peak</p>	<p>Site : 03CH12-HY Condition : PEAK(UNIT) 3m HORN_9120D_1328 VERTICAL Detector : Peak</p>

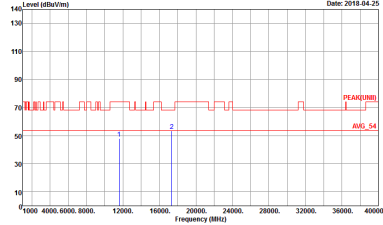
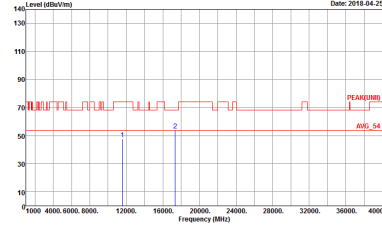

WIFI	Band 4 5725~5850MHz Harmonic @ 3m	
ANT	802.11a CH157 5785MHz	
1	Horizontal	Vertical
Peak	 <p>Site : 03CH12-HY Condition : PEAK(UNIT) 3m HORN_9120D_1328 HORIZONTAL Detector : Peak</p>	 <p>Site : 03CH12-HY Condition : PEAK(UNIT) 3m HORN_9120D_1328 VERTICAL Detector : Peak</p>



WIFI	Band 4 5725~5850MHz Harmonic @ 3m	
ANT	802.11a CH165 5825MHz	
1	Horizontal	Vertical
Peak	<p>Site : 03CH12-HY Condition : PEAK(UNIT) 3m HORN_9120D_1328 HORIZONTAL Detector : Peak</p>	<p>Site : 03CH12-HY Condition : PEAK(UNIT) 3m HORN_9120D_1328 VERTICAL Detector : Peak</p>



**Band 4 5725~5850MHz
WIFI 802.11n HT20 (Harmonic @ 3m)**

WIFI	Band 4 5725~5850MHz Harmonic @ 3m	
ANT	802.11n HT20 CH149 5745MHz	
1	Horizontal	Vertical
Peak	<p>Site : 03CH12-HY Condition : PEAK(UNIT) 3m HORN_9120D_1328 HORIZONTAL Detector : Peak</p>	<p>Site : 03CH12-HY Condition : PEAK(UNIT) 3m HORN_9120D_1328 VERTICAL Detector : Peak</p>

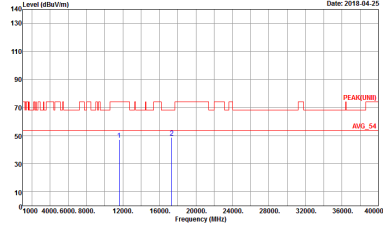
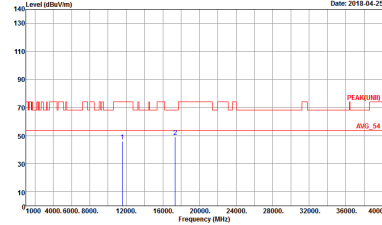

WIFI	Band 4 5725~5850MHz Harmonic @ 3m	
ANT	802.11n HT20 CH157 5785MHz	
1	Horizontal	Vertical
Peak	 <p>Site : 03CH12-HY Condition : PEAK(UNIT) 3m HORN_9120D_1328 HORIZONTAL Detector : Peak</p>	 <p>Site : 03CH12-HY Condition : PEAK(UNIT) 3m HORN_9120D_1328 VERTICAL Detector : Peak</p>



WIFI	Band 4 5725~5850MHz Harmonic @ 3m	
ANT	802.11n HT20 CH165 5825MHz	
1	Horizontal	Vertical
Peak	<p>Site : 03CH12-HY Condition : PEAK(UNIT) 3m HORN_9120D_1328 HORIZONTAL Detector : Peak</p>	<p>Site : 03CH12-HY Condition : PEAK(UNIT) 3m HORN_9120D_1328 VERTICAL Detector : Peak</p>



Band 4 5725~5850MHz
WIFI 802.11n HT40 (Harmonic @ 3m)

WIFI	Band 4 5725~5850MHz Harmonic @ 3m	
ANT	802.11n HT40 CH151 5755MHz	
1	Horizontal	Vertical
Peak	<p>Site : 03CH12-HY Condition : PEAK(UNIT) 3m HORN_9120D_1328 HORIZONTAL Detector : Peak</p>	<p>Site : 03CH12-HY Condition : PEAK(UNIT) 3m HORN_9120D_1328 VERTICAL Detector : Peak</p>



WIFI	Band 4 5725~5850MHz Harmonic @ 3m	
ANT	802.11n HT40 CH159 5795MHz	
1	Horizontal	Vertical
Peak	<p>Site : 03CH12-HY Condition : PEAK(UNIT) 3m HORN_9120D_1328 HORIZONTAL Detector : Peak</p>	<p>Site : 03CH12-HY Condition : PEAK(UNIT) 3m HORN_9120D_1328 VERTICAL Detector : Peak</p>

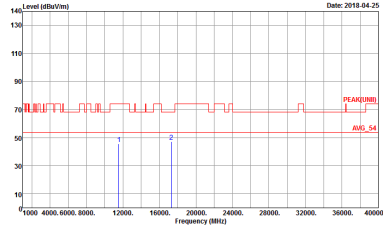
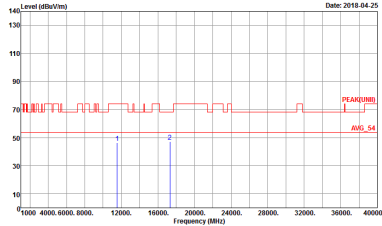

Band 4 5725~5850MHz
WIFI 802.11ac VHT80 (Harmonic @ 3m)

WIFI	Band 4 5725~5850MHz Harmonic @ 3m	
ANT	802.11ac VHT80 CH155 5775MHz	
1	Horizontal	Vertical
Peak	 <p>Site : 03CH12-HY Condition : PEAK(UNIT) 3m HORN_9120D_1328 HORIZONTAL Detector : Peak</p>	 <p>Site : 03CH12-HY Condition : PEAK(UNIT) 3m HORN_9120D_1328 VERTICAL Detector : Peak</p>



Emission below 1GHz
5GHz WIFI 802.11a (LF)

WIFI	5GHz 5725~5850MHz	
ANT	802.11a LF	
1	Horizontal	Vertical
QP / Peak	<p>Site : 03CH12-HY Condition : QP 3m BIL06_6111D_35414 HORIZONTAL Detector : Peak</p>	<p>Site : 03CH12-HY Condition : QP 3m BIL06_6111D_35414 VERTICAL Detector : Peak</p>



Appendix E. Duty Cycle Plots

Band	Duty Cycle(%)	T(us)	1/T(kHz)	VBW Setting	Duty Factor(dB)
802.11a	94.78	2032	0.49	1kHz	0.23
5GHz 802.11n HT20	94.41	1890	0.53	1kHz	0.25
5GHz 802.11n HT40	89.15	920	1.09	3kHz	0.50
5GHz 802.11ac VHT20	94.44	1904	0.53	1kHz	0.25
5GHz 802.11ac VHT40	90.34	935	1.07	3kHz	0.44
5GHz 802.11ac VHT80	87.77	732	1.37	3kHz	0.57



802.11a

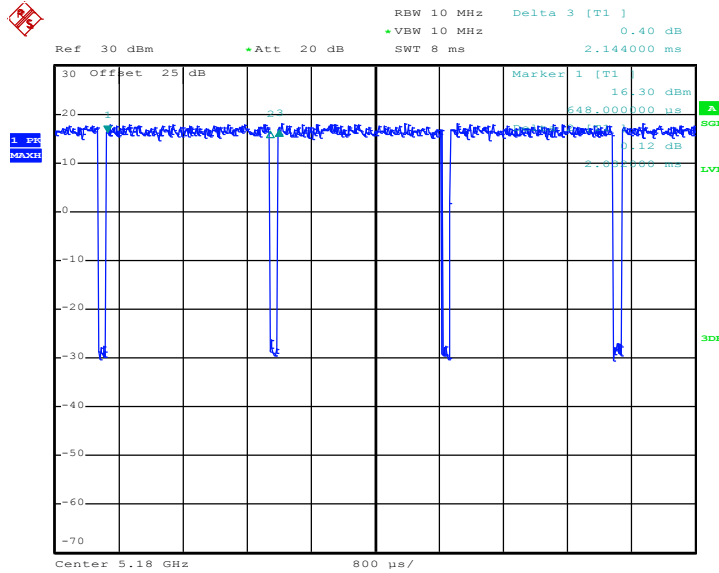

Date: 3.APR.2018 02:56:47

802.11n HT20

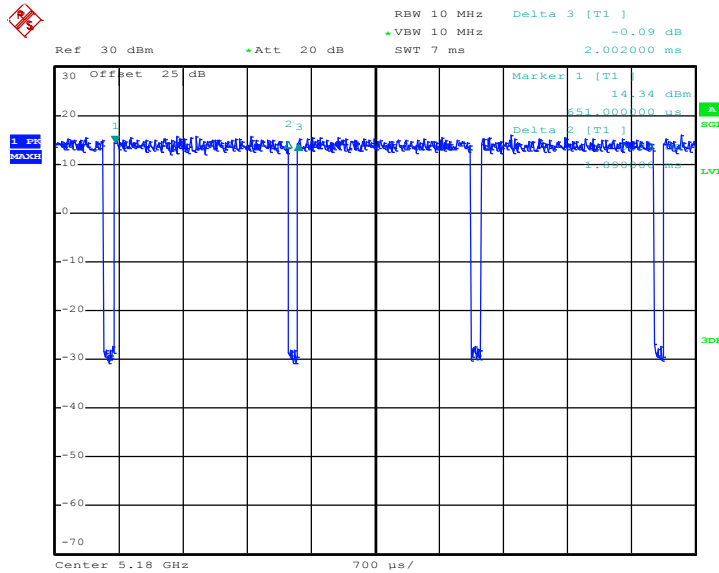

Date: 3.APR.2018 03:18:53



802.11n HT40

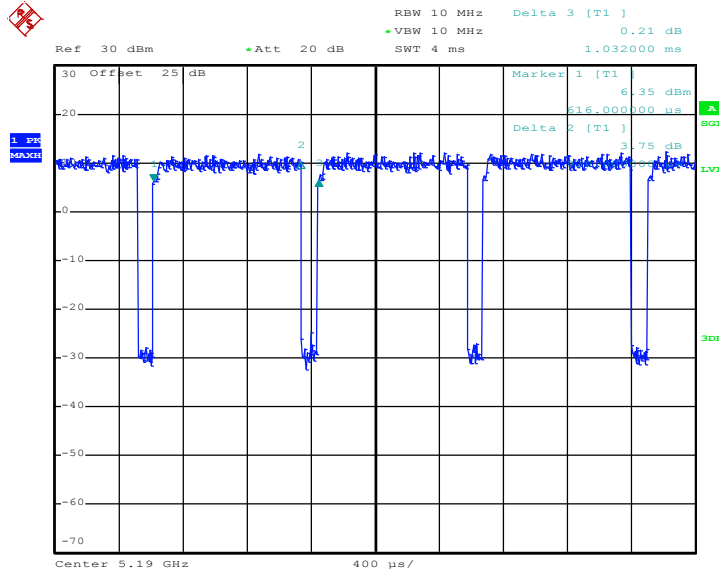

Date: 3.APR.2018 03:31:05

802.11ac VHT20

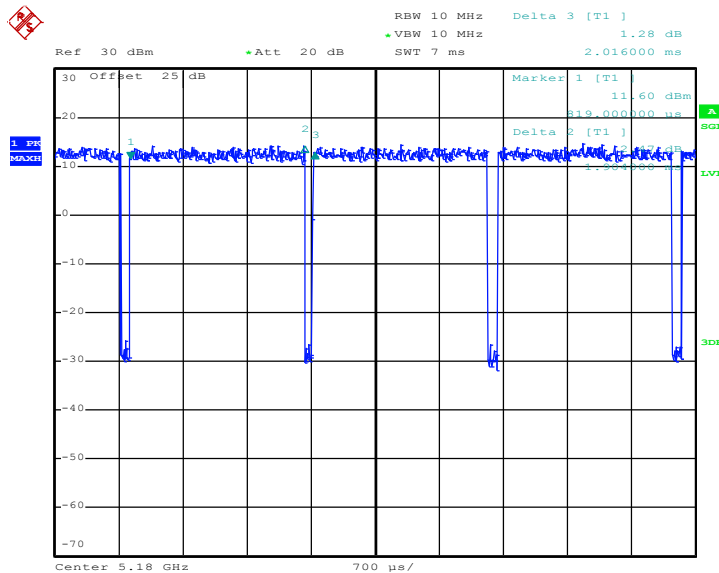

Date: 3.APR.2018 03:53:16



802.11ac VHT40

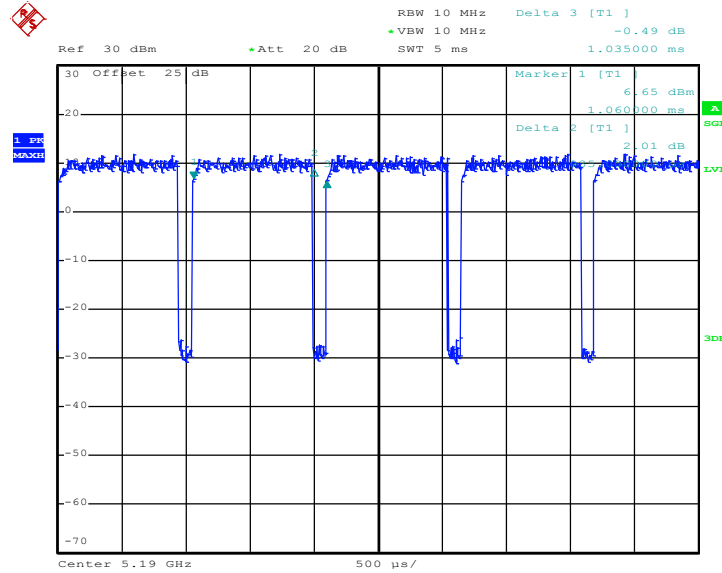

Date: 3.APR.2018 04:07:30

802.11ac VHT80

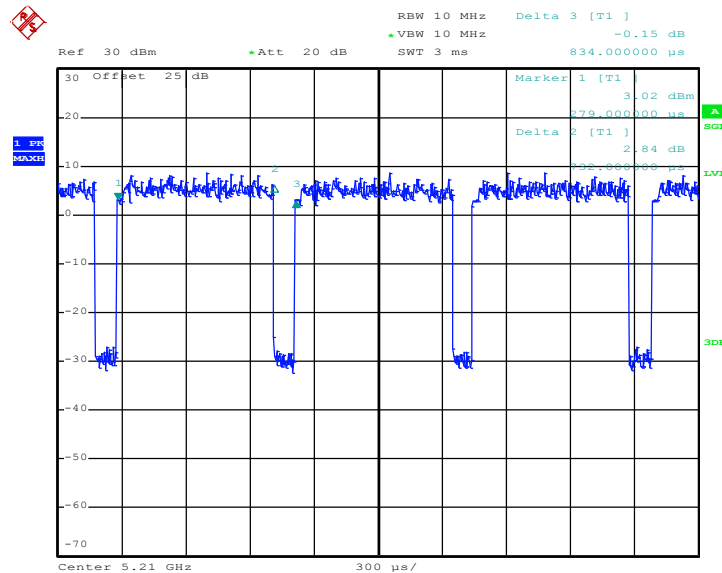

Date: 3.APR.2018 04:34:55

THE END