



FCC RADIO TEST REPORT

FCC ID : PY7-04606A
Equipment : GSM/WCDMA/LTE Phone+Bluetooth,
DTS/UNII a/b/g/n/ac and NFC
Brand Name : Sony
Applicant : Sony Mobile Communications Inc.
4-12-3 Higashi-Shinagawa, Shinagawa-ku,
Tokyo, 140-0002, Japan
Manufacturer : Sony Mobile Communications Inc.
4-12-3 Higashi-Shinagawa, Shinagawa-ku,
Tokyo, 140-0002, Japan
Standard : FCC Part 15 Subpart C §15.247

The product was received on Mar. 25, 2018 and testing was started from Apr. 03, 2018 and completed on Apr. 26, 2018. We, SPORTON INTERNATIONAL INC., would like to declare that the tested sample has been evaluated in accordance with the test procedures and has been in compliance with the applicable technical standards.

The report must not be used by the client to claim product certification, approval, or endorsement by TAF or any agency of government.

The test results in this report apply exclusively to the tested model / sample. Without written approval of SPORTON INTERNATIONAL INC. EMC & Wireless Communications Laboratory, the test report shall not be reproduced except in full.

Reviewed by: Jones Tsai

SPORTON INTERNATIONAL INC. EMC & Wireless Communications Laboratory

No. 52, Huaya 1st Rd., Guishan Dist., Taoyuan City, Taiwan (R.O.C.)



Table of Contents

History of this test report	3
Summary of Test Result.....	4
1 General Description	5
1.1 Product Feature of Equipment Under Test	5
1.2 Modification of EUT.....	5
1.3 Testing Location.....	6
1.4 Applicable Standards	6
2 Test Configuration of Equipment Under Test.....	7
2.1 Carrier Frequency Channel	7
2.2 Test Mode.....	8
2.3 Connection Diagram of Test System	9
2.4 Support Unit used in test configuration and system	10
2.5 EUT Operation Test Setup	10
2.6 Measurement Results Explanation Example.....	10
3 Test Result	11
3.1 Number of Channel Measurement.....	11
3.2 Hopping Channel Separation Measurement	13
3.3 Dwell Time Measurement.....	19
3.4 20dB and 99% Bandwidth Measurement.....	22
3.5 Output Power Measurement.....	33
3.6 Conducted Band Edges Measurement	34
3.7 Conducted Spurious Emission Measurement	41
3.8 Radiated Band Edges and Spurious Emission Measurement	51
3.9 AC Conducted Emission Measurement	55
3.10 Antenna Requirements.....	57
4 List of Measuring Equipment	58
5 Uncertainty of Evaluation	60
Appendix A. Conducted Test Results	
Appendix B. AC Conducted Emission Test Result	
Appendix C. Radiated Spurious Emission	
Appendix D. Radiated Spurious Emission Plots	
Appendix E. Duty Cycle Plots	



Summary of Test Result

Report Clause	Ref Std. Clause	Test Items	Result (PASS/FAIL)	Remark
3.1	15.247(a)(1)	Number of Channels	Pass	-
3.2	15.247(a)(1)	Hopping Channel Separation	Pass	-
3.3	15.247(a)(1)	Dwell Time of Each Channel	Pass	-
3.4	15.247(a)(1)	20dB Bandwidth	Pass	-
3.4	2.0149	99% Bandwidth	Reporting only	-
3.5	15.247(b)(1)	Peak Output Power	Pass	-
3.6	15.247(d)	Conducted Band Edges	Pass	-
3.7	15.247(d)	Conducted Spurious Emission	Pass	-
3.8	15.247(d)	Radiated Band Edges and Radiated Spurious Emission	Pass	Under limit 6.88 dB at 81.570 MHz
3.9	15.207	AC Conducted Emission	Pass	Under limit 19.09 dB at 0.643 MHz
3.10	15.203 & 15.247(b)	Antenna Requirement	Pass	-

Reviewed by: Joseph Lin

Report Producer: Polly Tsai



1 General Description

1.1 Product Feature of Equipment Under Test

GSM/WCDMA/LTE, Bluetooth, DTS/UNII a/b/g/n/ac, FM Receiver, NFC, and GNSS.

Standards-related Product Specification	
Antenna Type / Gain	C-feed Antenna type with gain -4.60 dBi

EUT Information List			
HW Version	SW Version	S/N	Performed Test Item
A	9.29	CQ3000NYWW	RF conducted measurement
		CQ3000NYWV	Radiated Spurious Emission
		CQ3000PSRK	AC Conducted Emission

Accessory List	
AC Adapter	Model Name: UCH20
	S/N: 3515W45302499 (for radiated emission) 3515W45302520 (for conducted emission)
Earphone	Model Name: MH410c
	S/N: N/A
USB Cable	Model Name: UCB20
	S/N: N/A

Note:

1. Above EUT list used are electrically identical per declared by manufacturer.
2. Above the accessories list are used to exercise the EUT during test, and the serial number of each type of accessories is listed in each section of this report. .
3. For other wireless features of this EUT, test report will be issued separately.

1.2 Modification of EUT

No modifications are made to the EUT during all test items.



1.3 Testing Location

Sporton Lab is accredited to ISO 17025 by Taiwan Accreditation Foundation (TAF code : 1190) and the FCC designation No. TW1190 and TW0007 under the FCC 2.948(e) by Mutual Recognition Agreement (MRA) in FCC Test.

Test Site	SPORTON INTERNATIONAL INC.	
Test Site Location	No.52, Huaya 1st Rd., Guishan Dist., Taoyuan City, Taiwan (R.O.C.) TEL: +886-3-327-3456 FAX: +886-3-328-4978	
Test Site No.	Sporton Site No.	
	TH05-HY	CO05-HY

Note: The test site complies with ANSI C63.4 2014 requirement.

Test Site	SPORTON INTERNATIONAL INC.	
Test Site Location	No.58, Aly. 75, Ln. 564, Wenhua 3rd, Rd., Guishan Dist., Taoyuan City, Taiwan (R.O.C.) TEL: +886-3-327-0868 FAX: +886-3-327-0855	
Test Site No.	Sporton Site No.	
	03CH12-HY	

Note: The test site complies with ANSI C63.4 2014 requirement.

1.4 Applicable Standards

According to the specifications of the manufacturer, the EUT must comply with the requirements of the following standards:

- ♦ FCC Part 15 Subpart C §15.247
- ♦ ANSI C63.10-2013

Remark:

1. All test items were verified and recorded according to the standards and without any deviation during the test.
2. This EUT has also been tested and complied with the requirements of FCC Part 15, Subpart B, recorded in a separate test report.



2 Test Configuration of Equipment Under Test

2.1 Carrier Frequency Channel

Frequency Band	Channel	Freq. (MHz)	Channel	Freq. (MHz)	Channel	Freq. (MHz)
2400-2483.5 MHz	0	2402	27	2429	54	2456
	1	2403	28	2430	55	2457
	2	2404	29	2431	56	2458
	3	2405	30	2432	57	2459
	4	2406	31	2433	58	2460
	5	2407	32	2434	59	2461
	6	2408	33	2435	60	2462
	7	2409	34	2436	61	2463
	8	2410	35	2437	62	2464
	9	2411	36	2438	63	2465
	10	2412	37	2439	64	2466
	11	2413	38	2440	65	2467
	12	2414	39	2441	66	2468
	13	2415	40	2442	67	2469
	14	2416	41	2443	68	2470
	15	2417	42	2444	69	2471
	16	2418	43	2445	70	2472
	17	2419	44	2446	71	2473
	18	2420	45	2447	72	2474
	19	2421	46	2448	73	2475
	20	2422	47	2449	74	2476
	21	2423	48	2450	75	2477
	22	2424	49	2451	76	2478
	23	2425	50	2452	77	2479
	24	2426	51	2453	78	2480
	25	2427	52	2454	-	-
	26	2428	53	2455	-	-

2.2 Test Mode

- a. The EUT has been associated with peripherals and configuration operated in a manner tended to maximize its emission characteristics in a typical application. Frequency range investigated: conduction emission (150 kHz to 30 MHz), radiation emission (9 kHz to the 10th harmonic of the highest fundamental frequency or to 40 GHz, whichever is lower). For radiated measurement, pre-scanned in three orthogonal panels, X, Y, Z. The worst cases (Y plane) were recorded in this report.

- b. AC power line Conducted Emission was tested under maximum output power.

The following summary table is showing all test modes to demonstrate in compliance with the standard.

Summary table of Test Cases			
Test Item	Data Rate / Modulation		
	Bluetooth BR 1Mbps GFSK	Bluetooth EDR 2Mbps $\pi/4$-DQPSK	Bluetooth EDR 3Mbps 8-DPSK
Conducted Test Cases	Mode 1: CH00_2402 MHz Mode 2: CH39_2441 MHz Mode 3: CH78_2480 MHz	Mode 4: CH00_2402 MHz Mode 5: CH39_2441 MHz Mode 6: CH78_2480 MHz	Mode 7: CH00_2402 MHz Mode 8: CH39_2441 MHz Mode 9: CH78_2480 MHz
Radiated Test Cases	Bluetooth 1Mbps GFSK / EDR 2Mbps $\pi/4$-DQPSK / EDR 3Mbps 8-DPSK		
	Mode 1: CH00_2402 MHz for 1Mbps Mode 2: CH39_2441 MHz for 1Mbps Mode 3: CH78_2480 MHz for 1Mbps Mode 4: CH00_2402 MHz for 2Mbps Mode 5: CH39_2441 MHz for 2Mbps Mode 6: CH78_2480 MHz for 2Mbps Mode 7: CH00_2402 MHz for 3Mbps Mode 8: CH39_2441 MHz for 3Mbps Mode 9: CH78_2480 MHz for 3Mbps		
AC Conducted Emission	Mode 1: Bluetooth Link + WLAN (2.4GHz) Link + Earphone + Battery + USB Cable (Charging from Adapter)		

2.3 Connection Diagram of Test System

<Bluetooth Tx Mode>

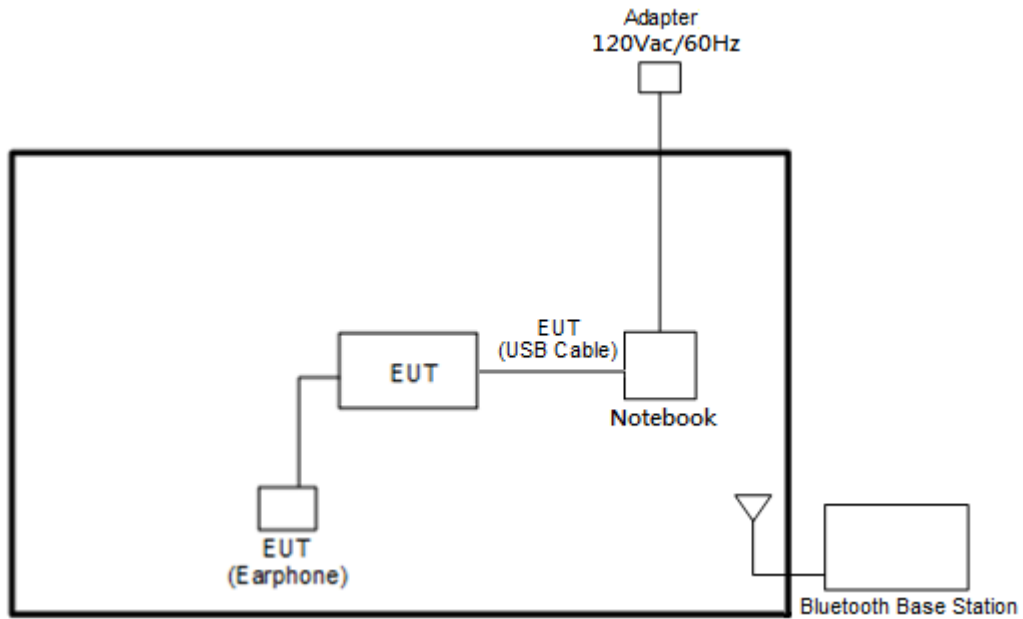

<AC Conducted Emission Mode>

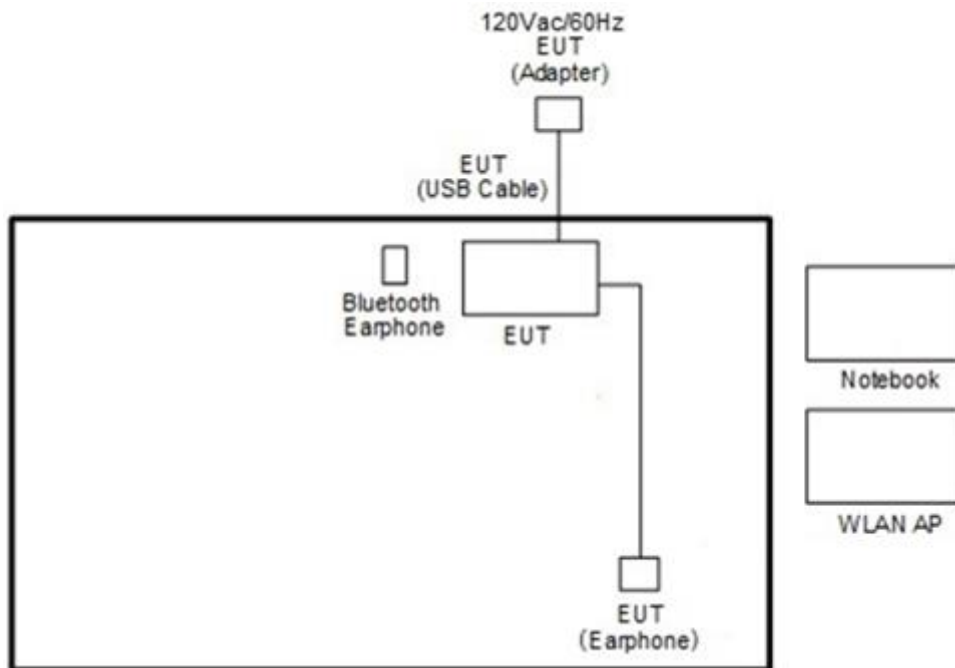



2.4 Support Unit used in test configuration and system

Item	Equipment	Trade Name	Model Name	FCC ID	Data Cable	Power Cord
1.	Bluetooth Base Station	R&S	CBT32	N/A	N/A	Unshielded, 1.8 m
2.	WLAN AP	ASUS	RT-AC66U	MSQ-RTAC66U	N/A	Unshielded, 1.8 m
3.	Bluetooth Earphone	Sony	SBH20	PY7-RD0010	N/A	N/A
4.	Notebook	DELL	Latitude E6320	FCC DoC/ Contains FCC ID: QDS-BRCM1054	N/A	AC I/P: Unshielded, 1.2 m DC O/P: Shielded, 1.8 m
5.	Notebook	Lenovo	E335	N/A	N/A	AC I/P: Unshielded, 1.2 m DC O/P: Shielded, 1.8 m
6.	SD Card	SanDisk	MicroSD HC	FCC DoC	N/A	N/A

2.5 EUT Operation Test Setup

The RF test items utility, an engineering test program was programmed in order to make the EUT get into the engineering modes to contact with base station for continuous transmitting.

2.6 Measurement Results Explanation Example

For all conducted test items:

The offset level is set in the spectrum analyzer to compensate the RF cable loss and attenuator factor between EUT conducted output port and spectrum analyzer. With the offset compensation, the spectrum analyzer reading level is exactly the EUT RF output level.

Example:

The spectrum analyzer offset is derived from RF cable loss and attenuator factor.

$$\text{Offset} = \text{RF cable loss} + \text{attenuator factor}.$$

Following shows an offset computation example with cable loss 4.2 dB and 10dB attenuator.

$$\begin{aligned} \text{Offset(dB)} &= \text{RF cable loss(dB)} + \text{attenuator factor(dB)}. \\ &= 4.2 + 10 = 14.2 \text{ (dB)} \end{aligned}$$

3 Test Result

3.1 Number of Channel Measurement

3.1.1 Limits of Number of Hopping Frequency

Frequency hopping systems in the 2400-2483.5 MHz band shall use at least 15 channels.

3.1.2 Measuring Instruments

See list of measuring equipment of this test report.

3.1.3 Test Procedure

1. The testing follows ANSI C63.10-2013 clause 7.8.3.
2. The RF output of EUT was connected to the spectrum analyzer by RF cable and attenuator. The path loss was compensated to the results for each measurement.
3. Set to the maximum power setting and enable the EUT transmit continuously.
4. Enable the EUT hopping function.
5. Use the following spectrum analyzer settings: Span = the frequency band of operation; RBW = 300kHz; VBW \geq RBW; Sweep = auto; Detector function = peak; Trace = max hold.
6. The number of hopping frequency used is defined as the number of total channel.
7. Record the measurement data derived from spectrum analyzer.

3.1.4 Test Setup

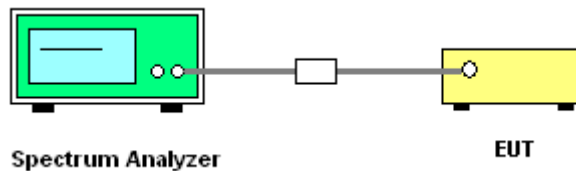



3.1.5 Test Result of Number of Hopping Frequency

Please refer to Appendix A.

Number of Hopping Channel Plot on Channel 00 - 78

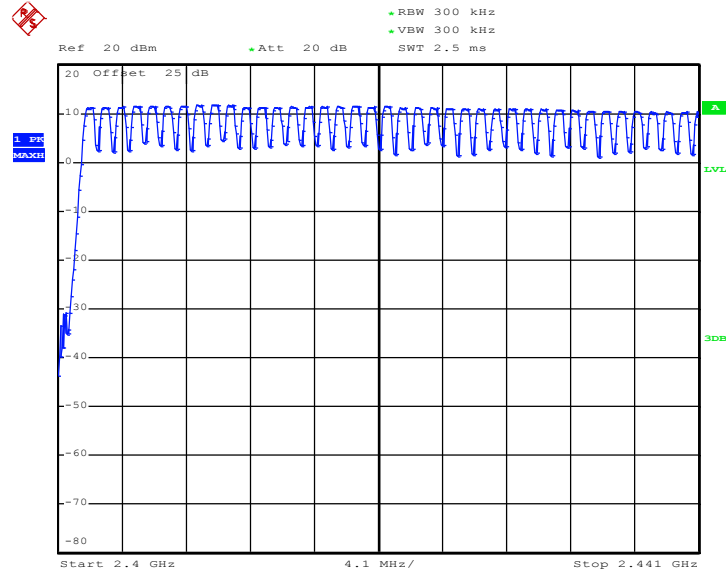

Date: 10.APR.2018 17:07:53

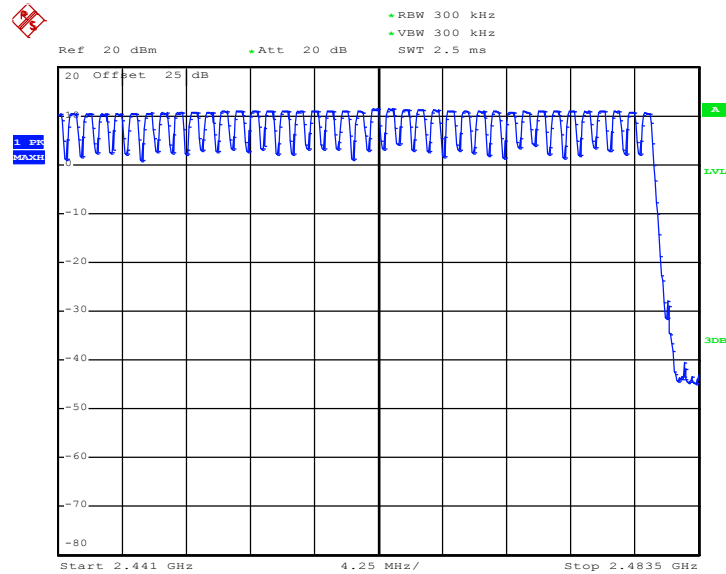

Date: 10.APR.2018 17:09:44

3.2 Hopping Channel Separation Measurement

3.2.1 Limit of Hopping Channel Separation

Frequency hopping systems operating in the 2400-2483.5 MHz band may have hopping channel carrier frequencies that are separated by 25 kHz or two-thirds of the 20 dB bandwidth of the hopping channel, whichever is greater.

3.2.2 Measuring Instruments

See list of measuring equipment of this test report.

3.2.3 Test Procedures

1. The testing follows ANSI C63.10-2013 clause 7.8.2.
2. The RF output of EUT was connected to the spectrum analyzer by RF cable and attenuator. The path loss was compensated to the results for each measurement.
3. Set to the maximum power setting and enable the EUT transmit continuously.
4. Enable the EUT hopping function.
5. Use the following spectrum analyzer settings:
Span = wide enough to capture the peaks of two adjacent channels;
RBW = 300kHz; VBW \geq RBW; Sweep = auto; Detector function = peak; Trace = max hold.
6. Measure and record the results in the test report.

3.2.4 Test Setup



3.2.5 Test Result of Hopping Channel Separation

Please refer to Appendix A.



<1Mbps>

Channel Separation Plot on Channel 00 - 01

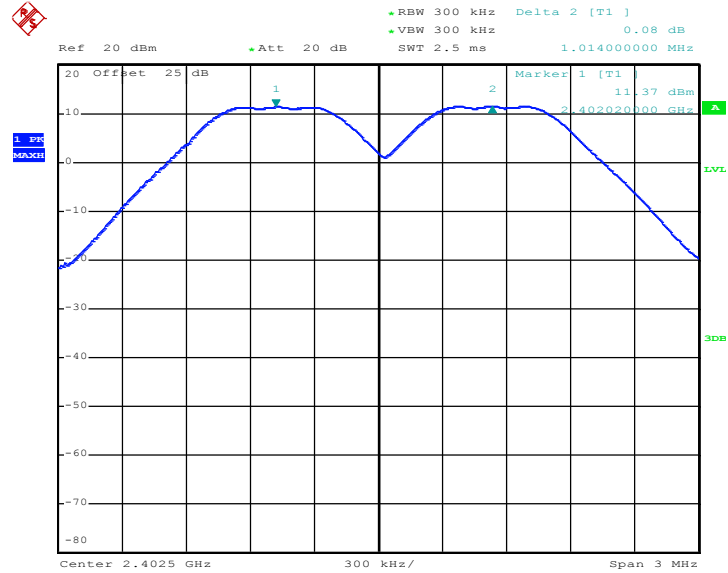

Date: 10.APR.2018 16:34:32

Channel Separation Plot on Channel 39 - 40

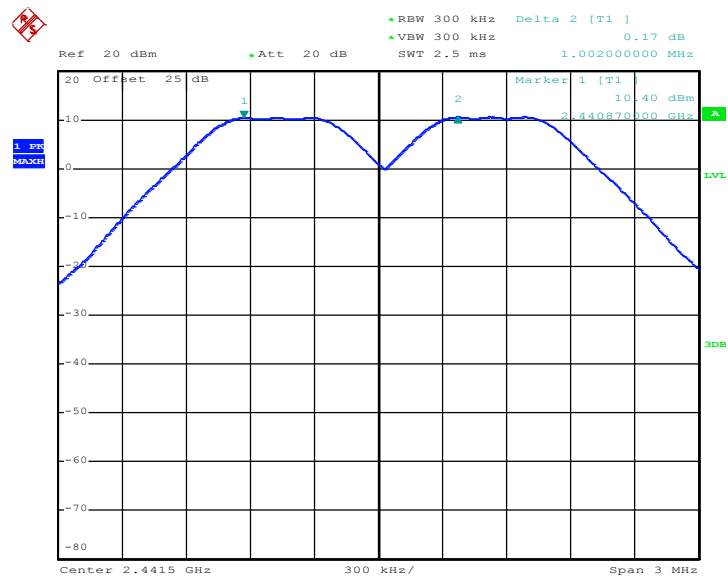

Date: 10.APR.2018 16:36:30



Channel Separation Plot on Channel 77 - 78

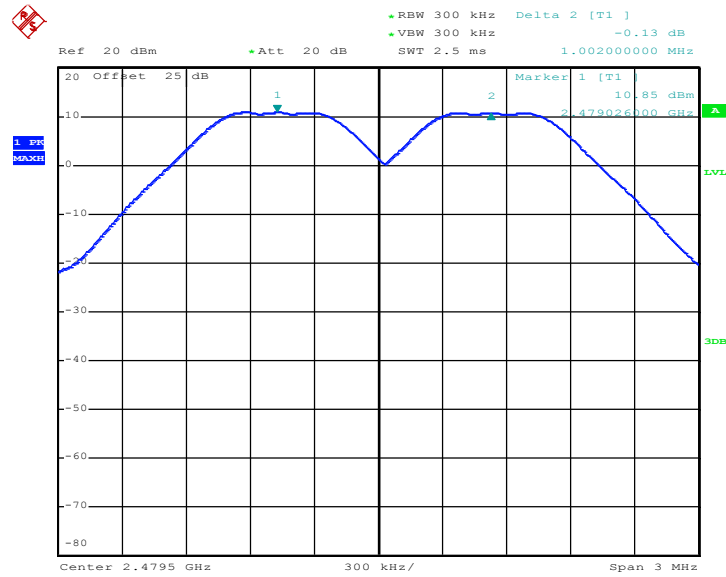

Date: 10.APR.2018 16:40:41

<2Mbps>

Channel Separation Plot on Channel 00 - 01

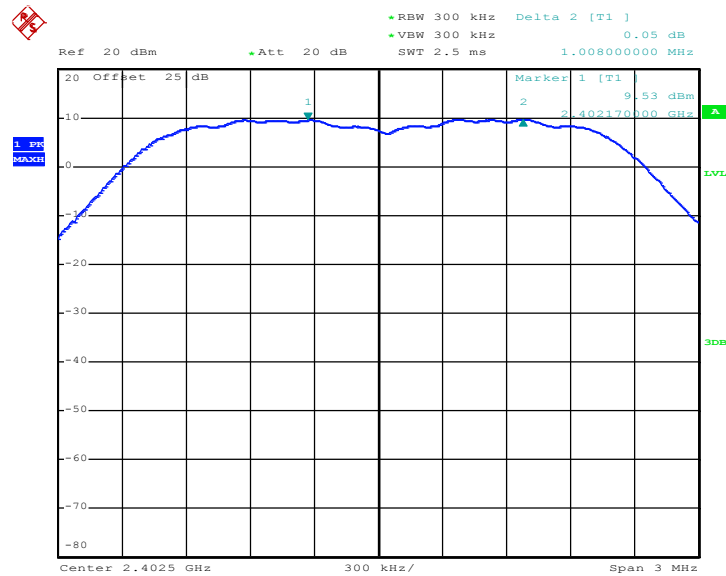

Date: 10.APR.2018 16:43:25



Channel Separation Plot on Channel 39 - 40

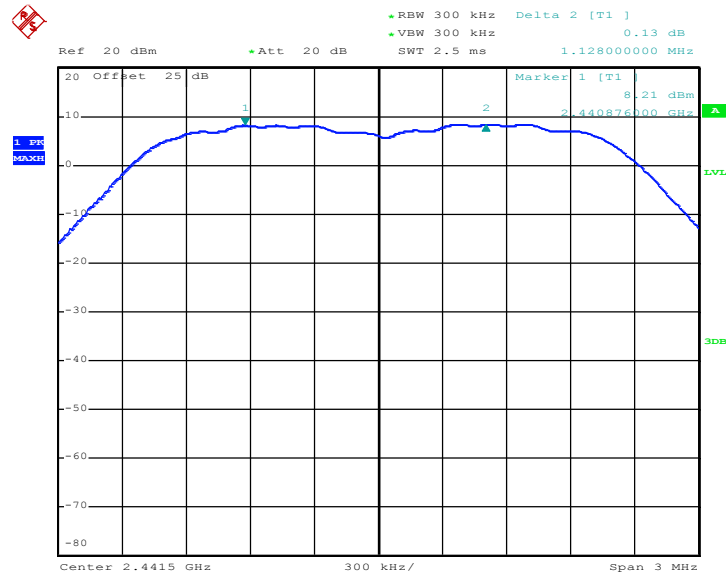

Date: 10.APR.2018 16:45:17

Channel Separation Plot on Channel 77 - 78

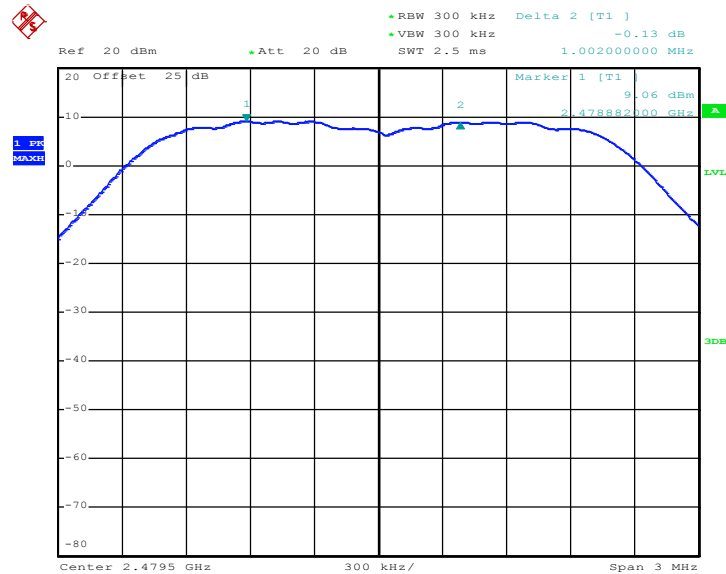

Date: 10.APR.2018 16:48:43



<3Mbps>

Channel Separation Plot on Channel 00 - 01

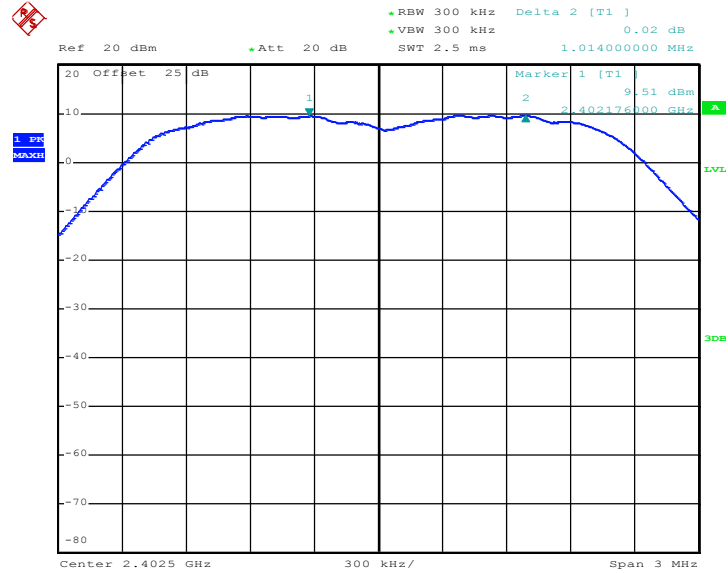

Date: 10.APR.2018 16:50:05

Channel Separation Plot on Channel 39 - 40

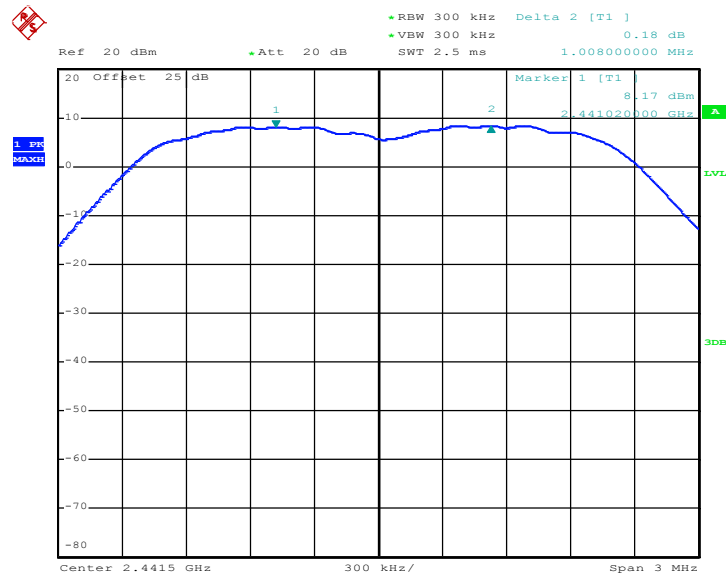

Date: 10.APR.2018 16:51:31



Channel Separation Plot on Channel 77 - 78

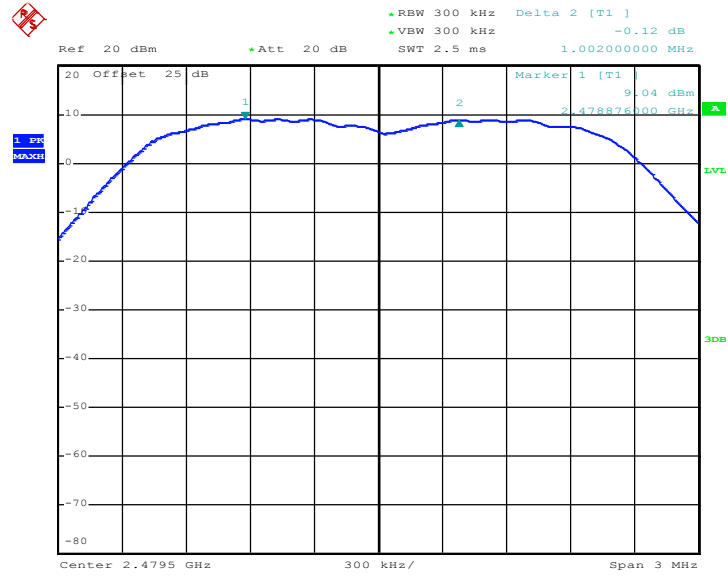

Date: 10.APR.2018 16:52:42

3.3 Dwell Time Measurement

3.3.1 Limit of Dwell Time

The average time of occupancy on any channel shall not be greater than 0.4 seconds within a period of 0.4 seconds multiplied by the number of hopping channels employed.

3.3.2 Measuring Instruments

See list of measuring equipment of this test report.

3.3.3 Test Procedures

1. The testing follows ANSI C63.10-2013 clause 7.8.4.
2. The RF output of EUT was connected to the spectrum analyzer by RF cable and attenuator. The path loss was compensated to the results for each measurement.
3. Set to the maximum power setting and enable the EUT transmit continuously.
4. Enable the EUT hopping function.
5. Use the following spectrum analyzer settings: Span = zero span, centered on a hopping channel; RBW = 1 MHz; VBW \geq RBW; Sweep = as necessary to capture the entire dwell time per hopping channel; Detector function = peak; Trace = max hold.
6. Measure and record the results in the test report.

3.3.4 Test Setup





3.3.5 Test Result of Dwell Time

Please refer to Appendix A.

Remark:

1. In normal mode, hopping rate is 1600 hops/s with 6 slots in 79 hopping channels. With channel hopping rate (1600 / 6 / 79) in Occupancy Time Limit (0.4 x 79) (s), Hops Over Occupancy Time comes to (1600 / 6 / 79) x (0.4 x 79) = 106.67 hops.
2. In AFH mode, hopping rate is 800 hops/s with 6 slots in 20 hopping channels. With channel hopping rate (800 / 6 / 20) in Occupancy Time Limit (0.4 x 20) (s), Hops Over Occupancy Time comes to (800 / 6 / 20) x (0.4 x 20) = 53.33 hops.
3. Dwell Time(s) = Hops Over Occupancy Time (hops) x Package Transfer Time

Package Transfer Time Plot

<1Mbps>

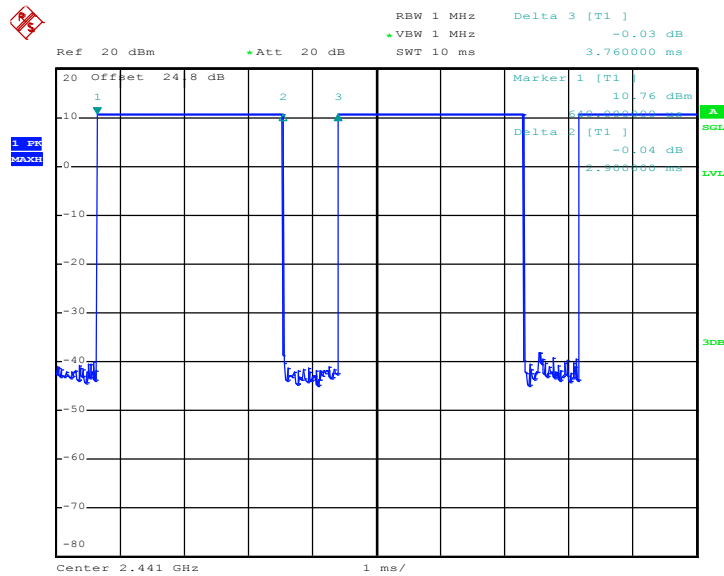

Date: 3.APR.2018 19:17:12



<2Mbps>

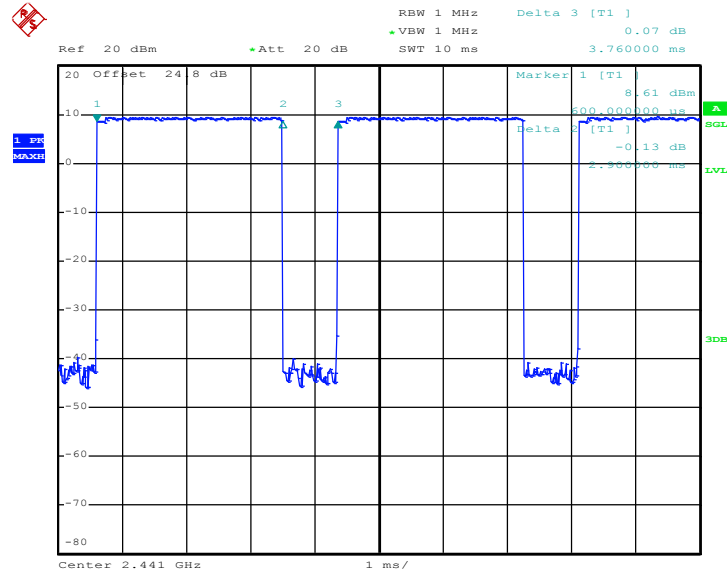

Date: 3.APR.2018 19:21:21

<3Mbps>

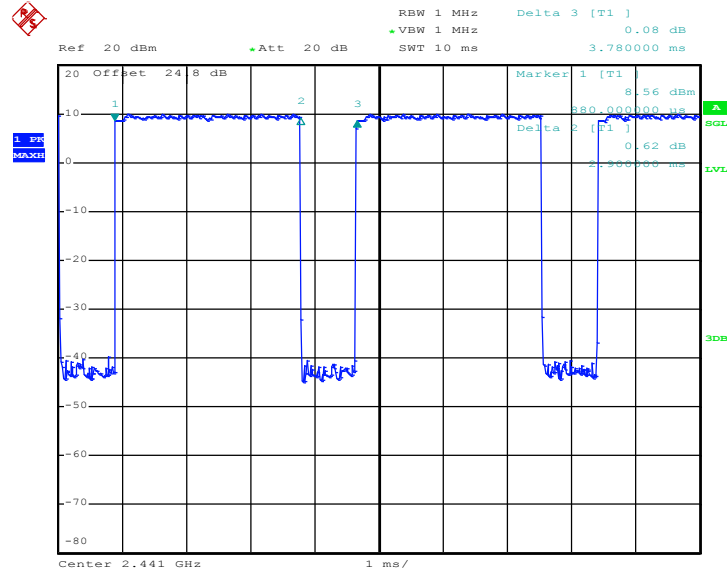

Date: 3.APR.2018 19:23:25

3.4 20dB and 99% Bandwidth Measurement

3.4.1 Limit of 20dB and 99% Bandwidth

Reporting only

3.4.2 Measuring Instruments

See list of measuring equipment of this test report.

3.4.3 Test Procedures

1. The testing follows ANSI C63.10-2013 clause 6.9.2 and 6.9.3.
2. The RF output of EUT was connected to the spectrum analyzer by RF cable and attenuator. The path loss was compensated to the results for each measurement.
3. Set to the maximum power setting and enable the EUT transmit continuously.
4. Use the following spectrum analyzer settings for 20dB Bandwidth measurement.
Span = approximately 2 to 5 times the 20 dB bandwidth, centered on a hopping channel;
RBW \geq 1% of the 20 dB bandwidth; VBW \geq RBW; Sweep = auto; Detector function = peak;
Trace = max hold.
5. Use the following spectrum analyzer settings for 99 % Bandwidth measurement.
Span = approximately 1.5 to 5 times the 99% bandwidth, centered on a hopping channel;
RBW \geq 1% of the 99% bandwidth; VBW \geq RBW; Sweep = auto; Detector function = peak;
Trace = max hold.
6. Measure and record the results in the test report.

3.4.4 Test Setup



3.4.5 Test Result of 20dB Bandwidth

Please refer to Appendix A.



<1Mbps>

20 dB Bandwidth Plot on Channel 00

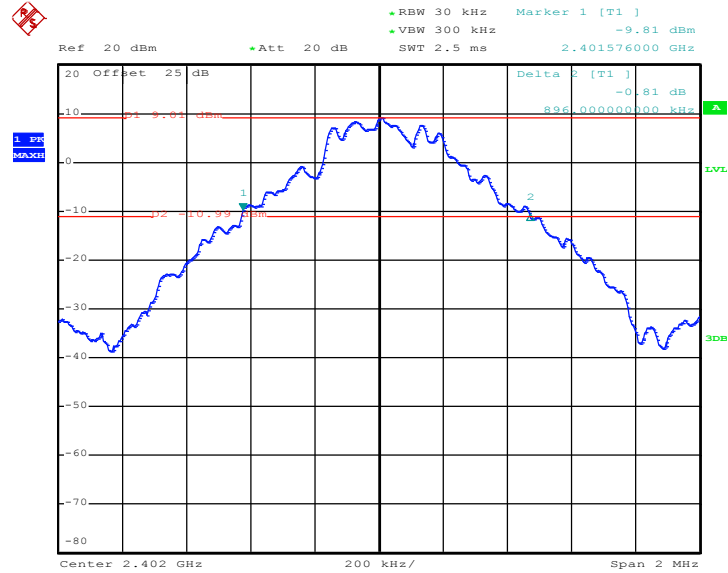

Date: 10.APR.2018 17:19:16

20 dB Bandwidth Plot on Channel 39

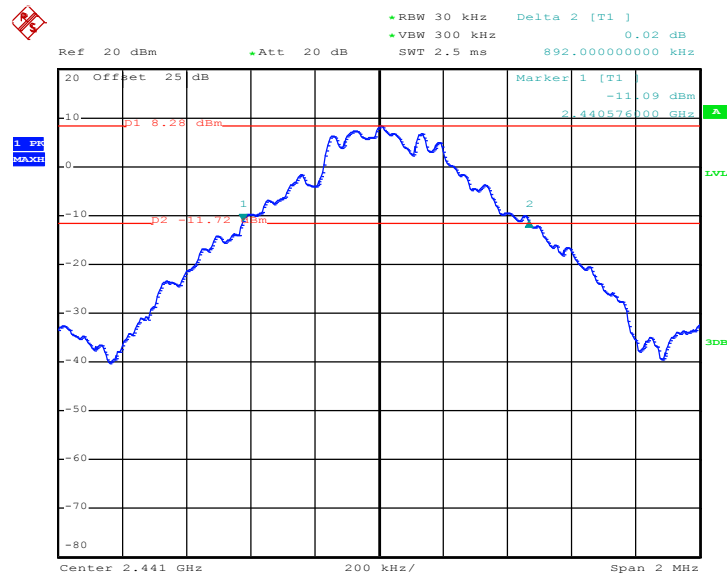

Date: 10.APR.2018 17:47:56



20 dB Bandwidth Plot on Channel 78

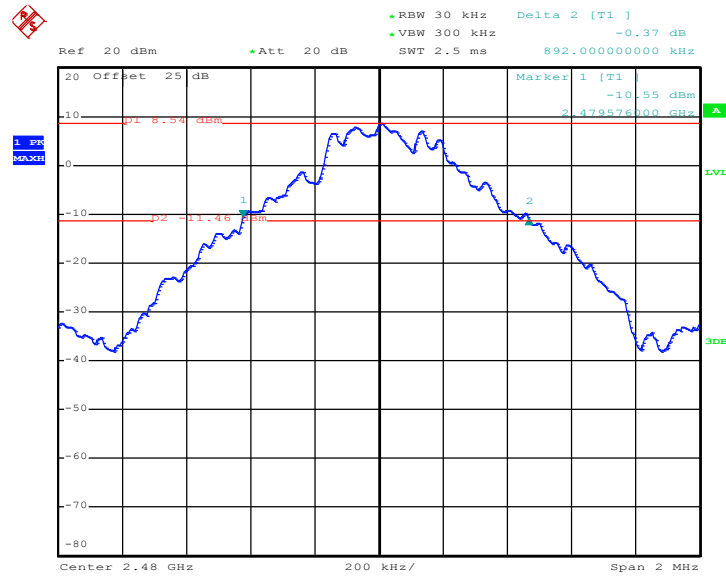

Date: 10.APR.2018 17:53:28

<2Mbps>

20 dB Bandwidth Plot on Channel 00

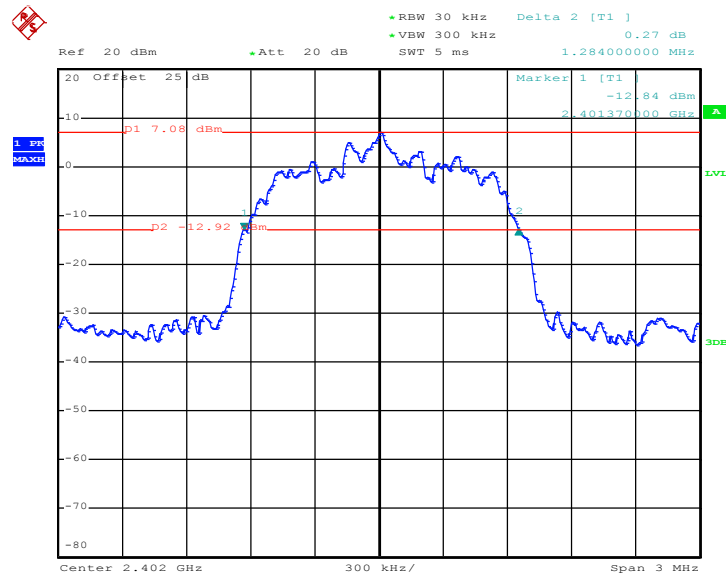

Date: 10.APR.2018 18:33:33



20 dB Bandwidth Plot on Channel 39

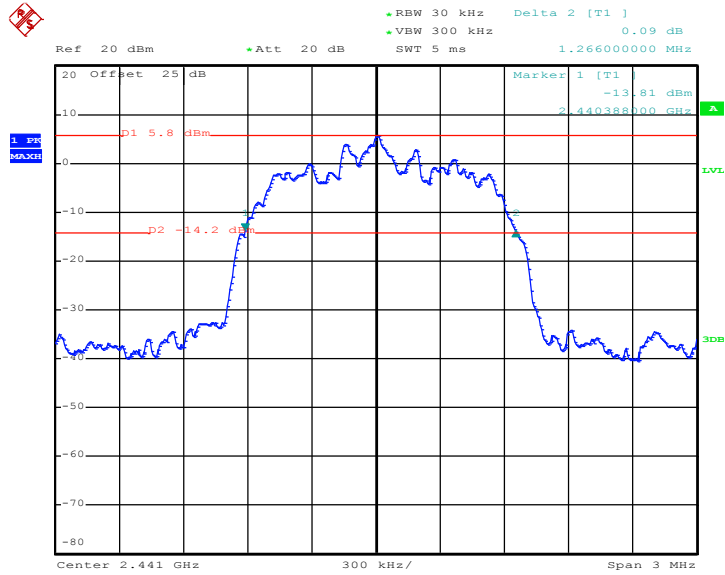

Date: 10.APR.2018 18:32:22

20 dB Bandwidth Plot on Channel 78

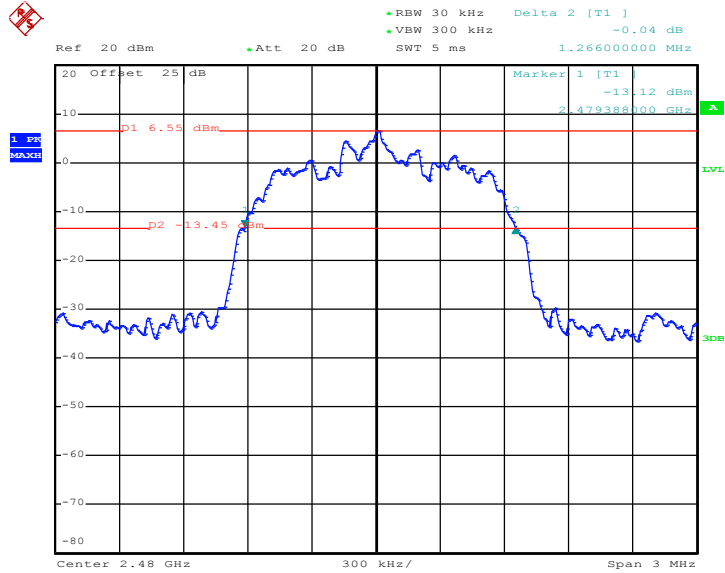

Date: 10.APR.2018 18:31:17



<3Mbps>

20 dB Bandwidth Plot on Channel 00

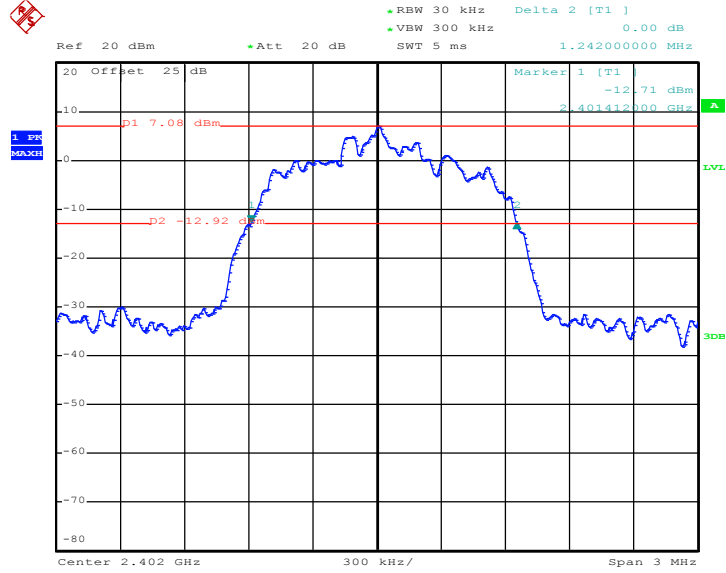

Date: 10.APR.2018 18:35:12

20 dB Bandwidth Plot on Channel 39

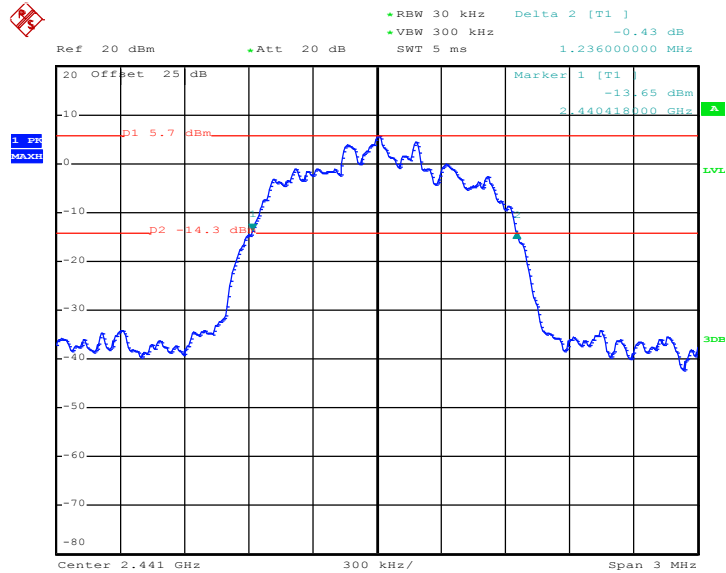

Date: 10.APR.2018 18:36:25



20 dB Bandwidth Plot on Channel 78

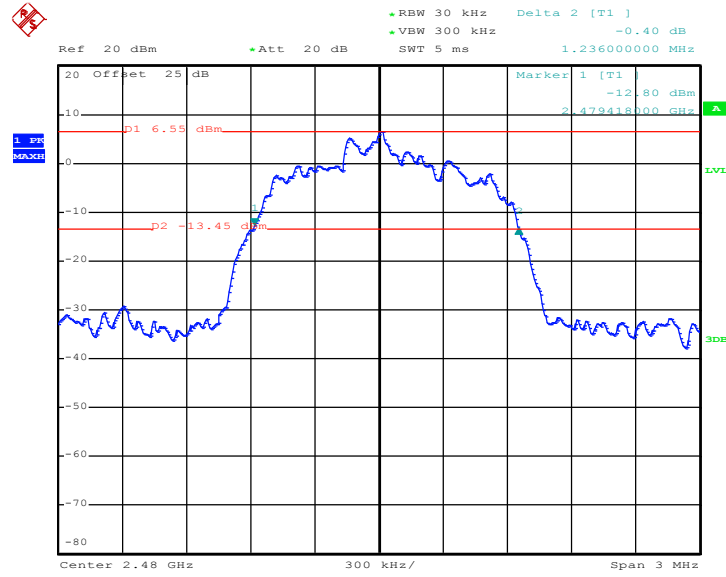

Date: 10.APR.2018 18:37:35



3.4.6 Test Result of 99% Occupied Bandwidth

Please refer to Appendix A.

<1Mbps>

99% Occupied Bandwidth Plot on Channel 00

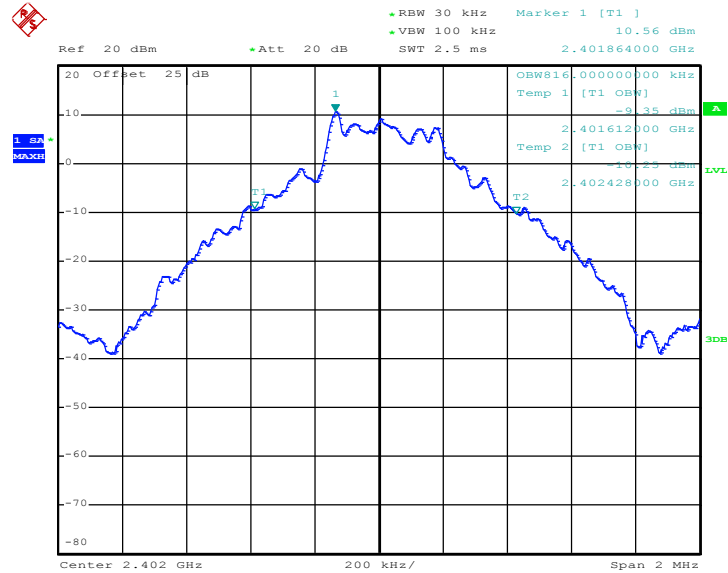

Date: 10.APR.2018 17:01:05



99% Occupied Bandwidth Plot on Channel 39

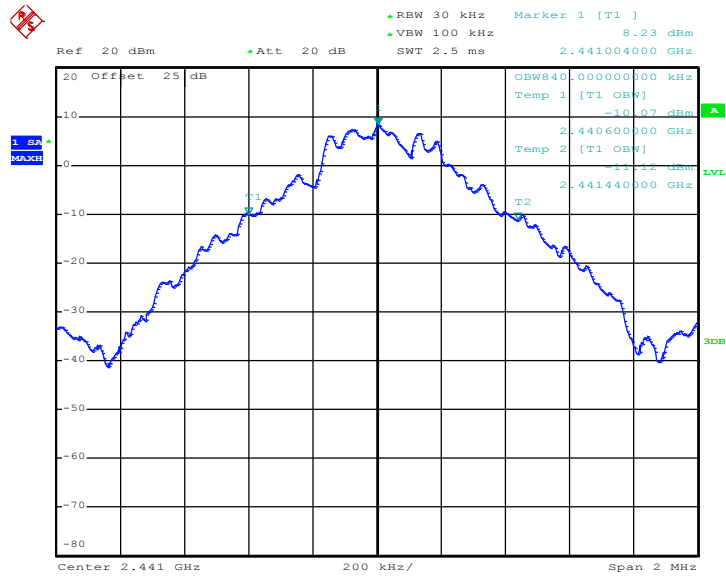

Date: 10.APR.2018 17:01:41

99% Occupied Bandwidth Plot on Channel 78

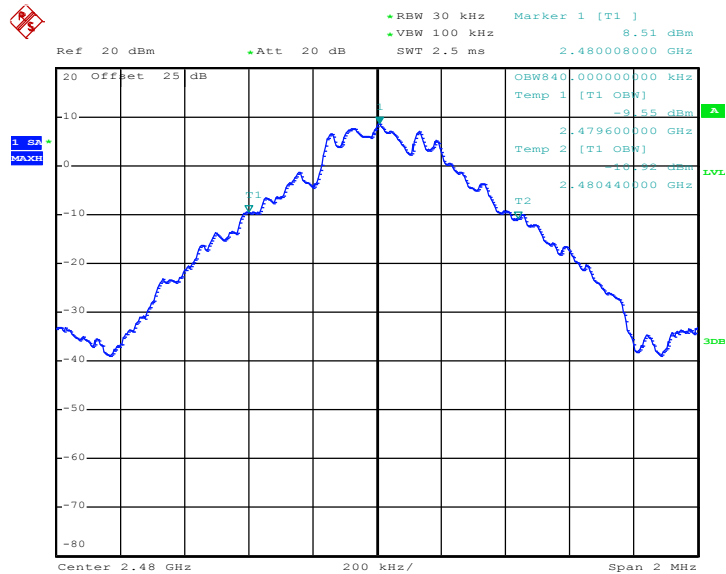

Date: 10.APR.2018 17:02:17



<2Mbps>

99% Occupied Bandwidth Plot on Channel 00

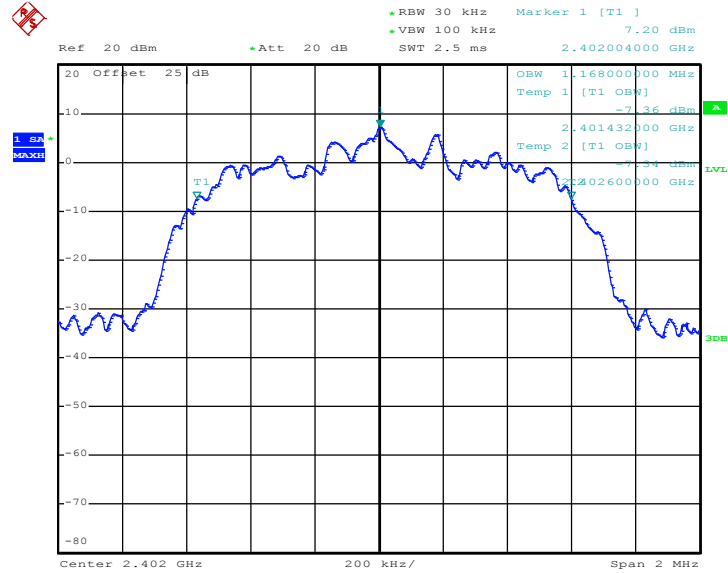

Date: 10.APR.2018 17:02:54

99% Occupied Bandwidth Plot on Channel 39

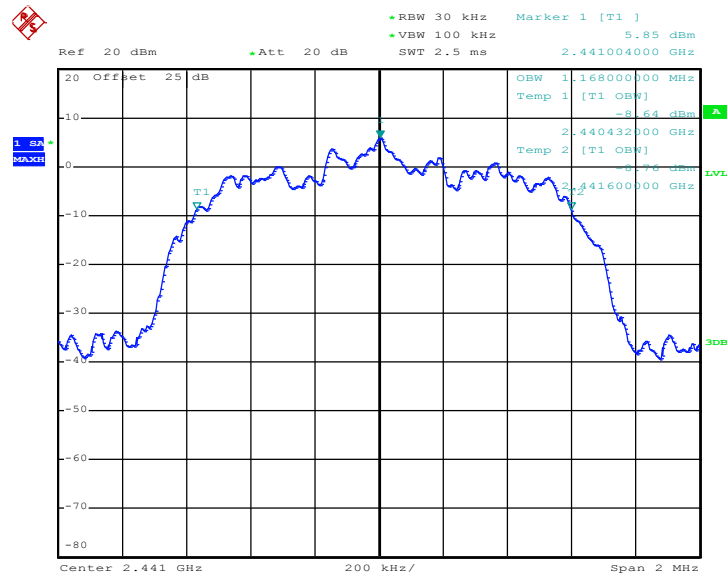

Date: 10.APR.2018 17:03:30



99% Occupied Bandwidth Plot on Channel 78

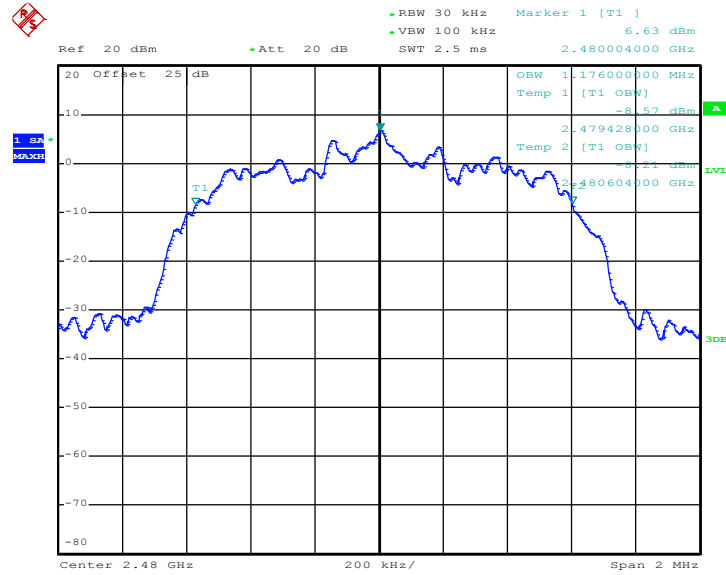

Date: 10.APR.2018 17:04:06

<3Mbps>

99% Occupied Bandwidth Plot on Channel 00

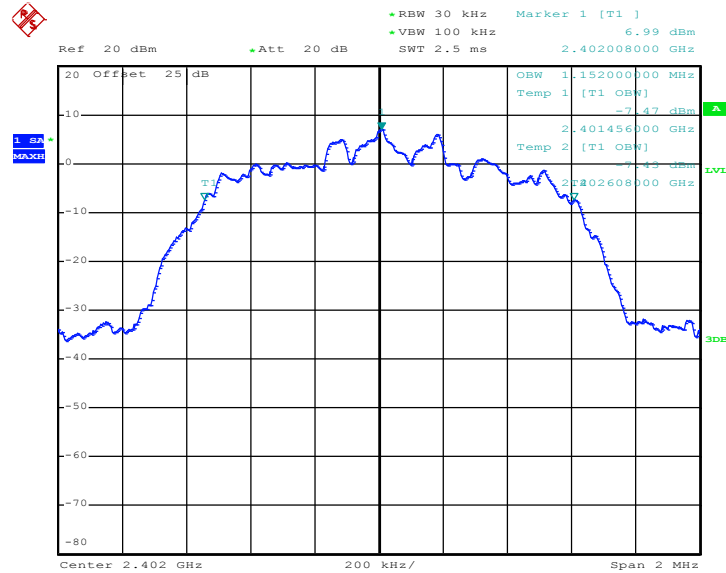

Date: 10.APR.2018 17:04:42



99% Occupied Bandwidth Plot on Channel 39

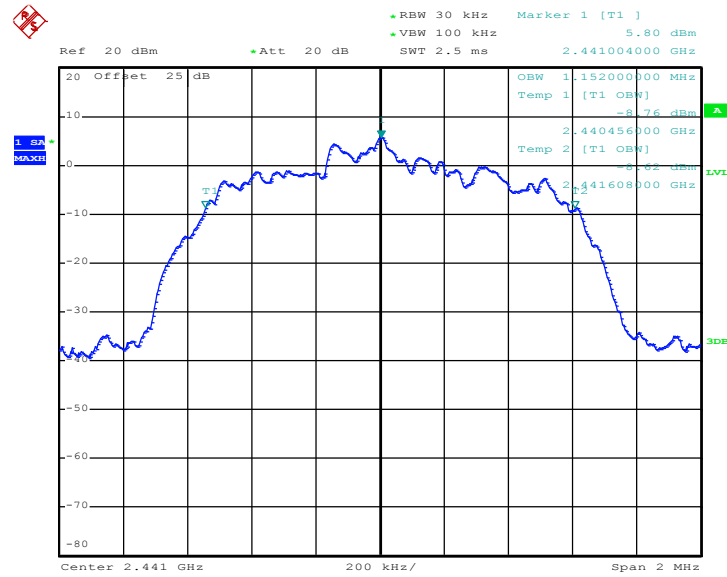

Date: 10.APR.2018 17:05:18

99% Occupied Bandwidth Plot on Channel 78

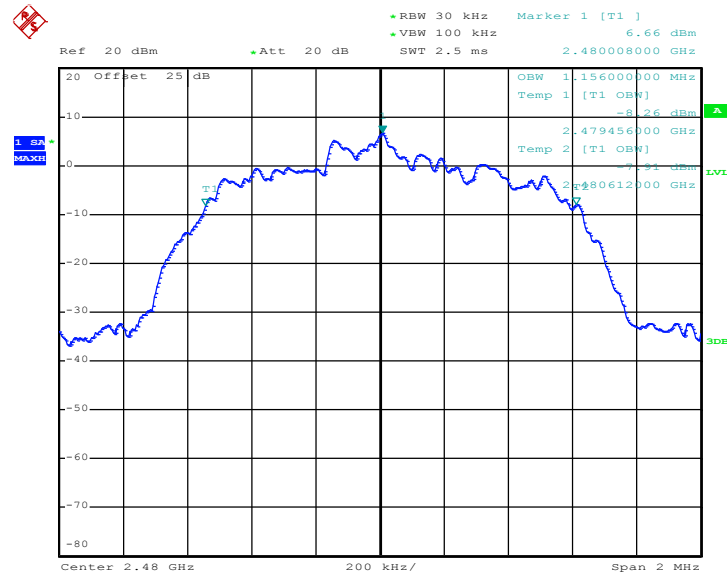

Date: 10.APR.2018 17:05:54

Note: The occupied channel bandwidth is maintained within the band of operation for all of the modulations.

3.5 Output Power Measurement

3.5.1 Limit of Output Power

The maximum peak conducted output power of the intentional radiator shall not exceed the following:

(1) For frequency hopping systems operating in the 2400-2483.5 MHz band employing at least 75 non-overlapping hopping channels, and all frequency hopping systems in the 5725-5850 MHz band: 1 watt. For all other frequency hopping systems in the 2400-2483.5 MHz band 0.125 watts. The power limit for 1Mbps, 2Mbps, 3Mbps and AFH modes are 0.125 watts.

3.5.2 Measuring Instruments

See list of measuring equipment of this test report.

3.5.3 Test Procedures

1. The testing follows ANSI C63.10-2013 clause 7.8.5.
2. The RF output of EUT was connected to the power meter by RF cable and attenuator. The path loss was compensated to the results for each measurement.
3. Set to the maximum power setting and enable the EUT transmit continuously.
4. Measure the conducted output power with cable loss and record the results in the test report.
5. Measure and record the results in the test report.

3.5.4 Test Setup

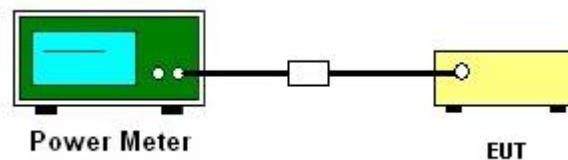

3.5.5 Test Result of Peak Output Power

Please refer to Appendix A.

3.5.6 Test Result of Average Output Power (Reporting Only)

Please refer to Appendix A.

3.6 Conducted Band Edges Measurement

3.6.1 Limit of Band Edges

In any 100 kHz bandwidth outside the intentional radiation frequency band, the radio frequency power shall be at least 20 dB below the highest level of the radiated power. In addition, radiated emissions which fall in the restricted bands must also comply with the radiated emission limits.

3.6.2 Measuring Instruments

See list of measuring equipment of this test report.

3.6.3 Test Procedures

1. The testing follows ANSI C63.10-2013 clause 7.8.6.
2. Set to the maximum power setting and enable the EUT transmit continuously.
3. Set RBW = 100kHz, VBW = 300kHz. Band edge emissions must be at least 20 dB down from the highest emission level within the authorized band as measured with a 100kHz RBW. The attenuation shall be 30 dB instead of 20 dB when RMS conducted output power procedure is used.
4. Enable hopping function of the EUT and then repeat step 2. and 3.
5. Measure and record the results in the test report.

3.6.4 Test Setup





3.6.5 Test Result of Conducted Band Edges

<1Mbps>

Low Band Edge Plot on Channel 00

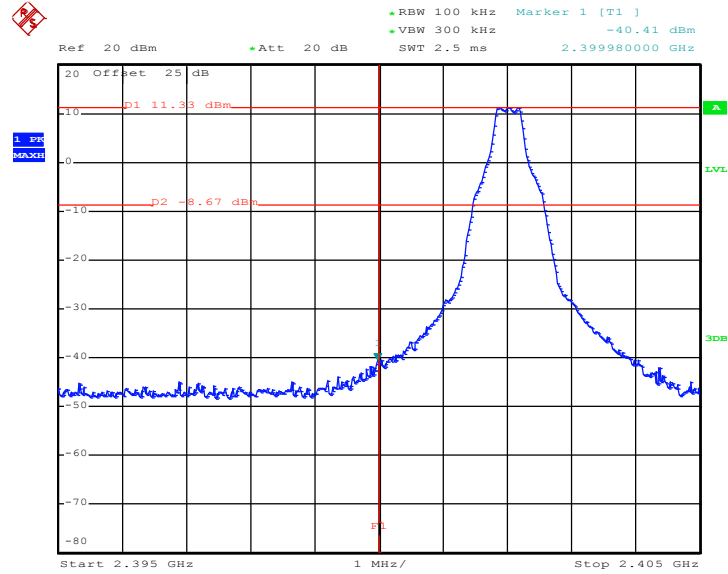

Date: 10.APR.2018 16:56:10

High Band Edge Plot on Channel 78

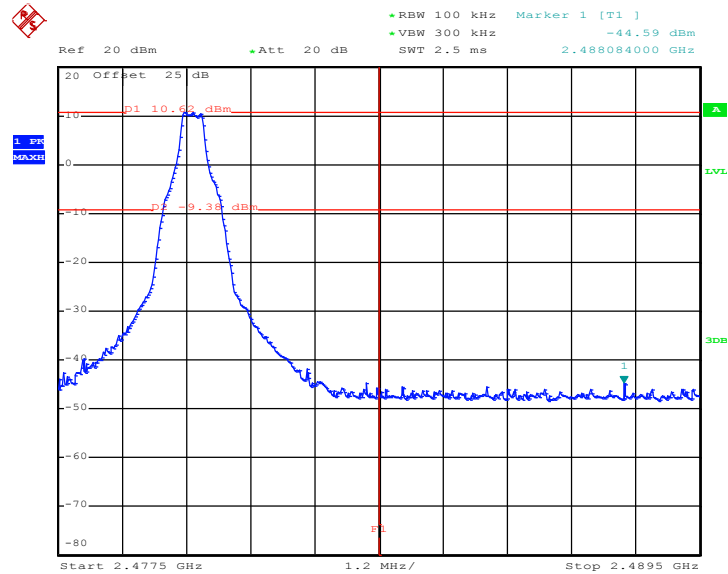

Date: 10.APR.2018 16:57:01



<2Mbps>

Low Band Edge Plot on Channel 00

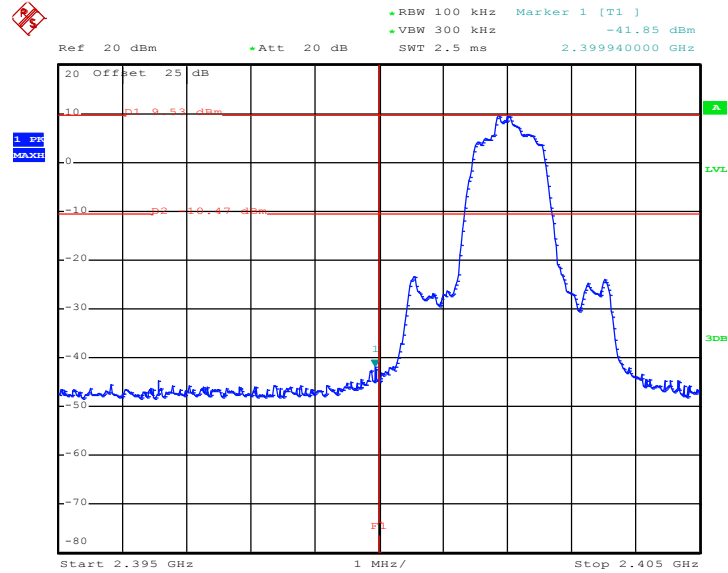

Date: 10.APR.2018 16:57:53

High Band Edge Plot on Channel 78

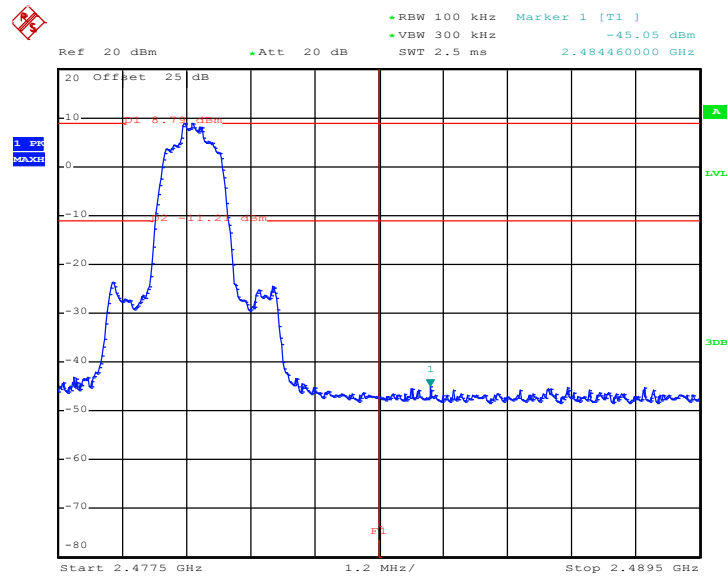

Date: 10.APR.2018 16:58:45



3.6.6 Test Result of Conducted Hopping Mode Band Edges

<1Mbps>

Hopping Mode Low Band Edge Plot

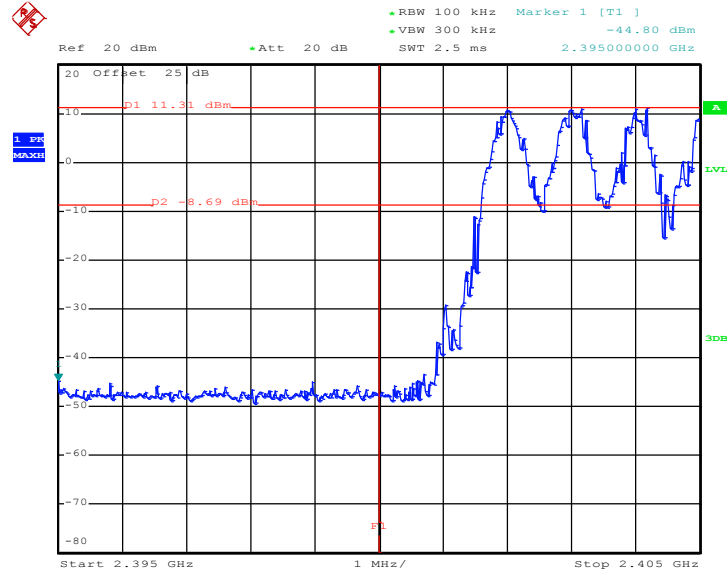

Date: 10.APR.2018 18:04:31

Hopping Mode High Band Edge Plot

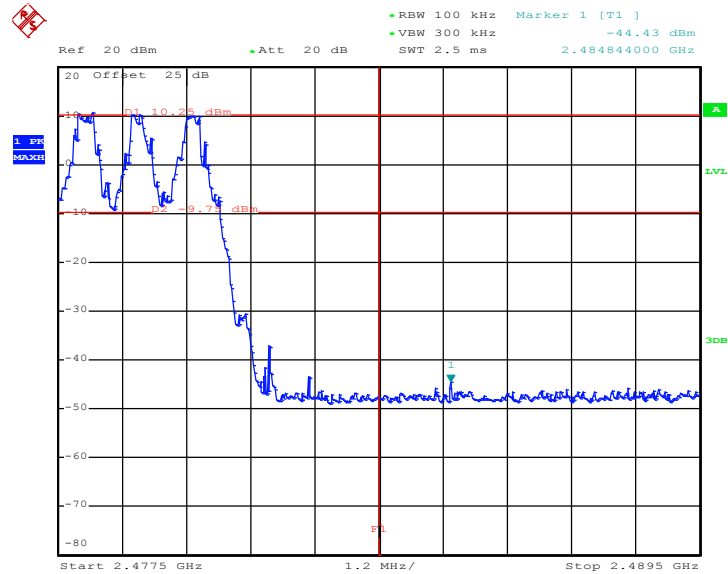

Date: 10.APR.2018 18:05:11



<2Mbps>

Hopping Mode Low Band Edge Plot

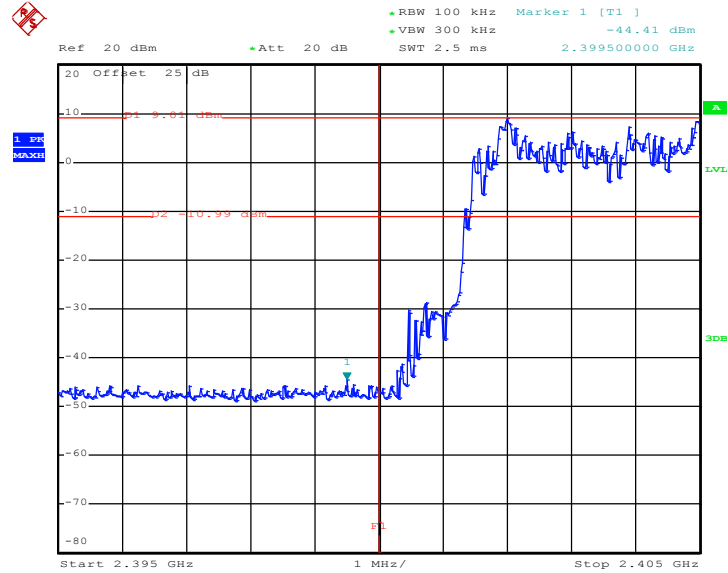

Date: 10.APR.2018 18:08:50

Hopping Mode High Band Edge Plot

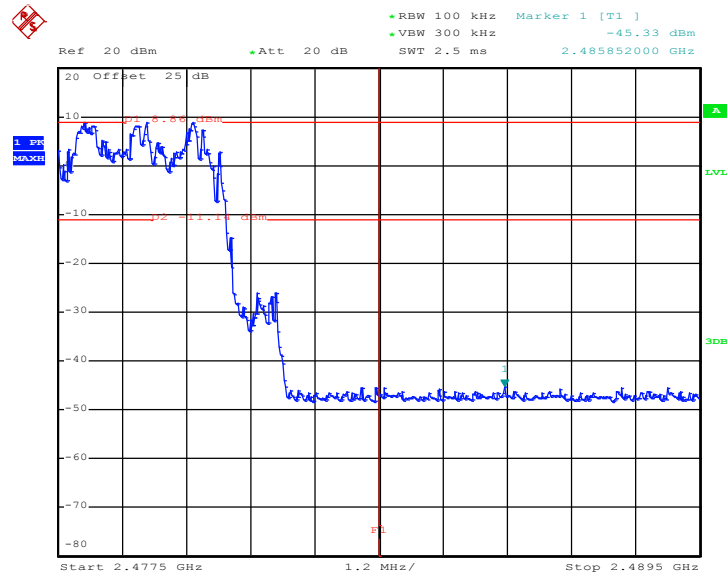

Date: 10.APR.2018 18:08:07

3.7 Conducted Spurious Emission Measurement

3.7.1 Limit of Spurious Emission Measurement

In any 100 kHz bandwidth outside the intentional radiation frequency band, the radio frequency power shall be at least 20 dB below the highest level of the radiated power. In addition, radiated emissions which fall in the restricted bands must also comply with the radiated emission limits.

3.7.2 Measuring Instruments

See list of measuring equipment of this test report.

3.7.3 Test Procedure

1. The testing follows ANSI C63.10-2013 clause 7.8.8.
2. The RF output of EUT was connected to the spectrum analyzer by RF cable and attenuator. The path loss was compensated to the results for each measurement.
3. Set to the maximum power setting and enable the EUT transmit continuously.
4. Set RBW = 100 kHz, VBW = 300kHz, scan up through 10th harmonic. All harmonics / spurs must be at least 20 dB down from the highest emission level within the authorized band as measured with a 100 kHz RBW.
5. Measure and record the results in the test report.
6. The RF fundamental frequency should be excluded against the limit line in the operating frequency band.

3.7.4 Test Setup

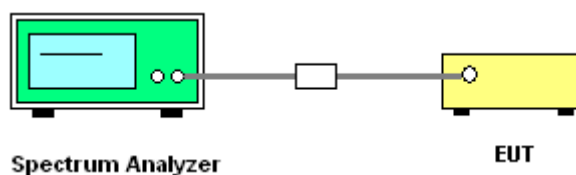



3.7.5 Test Result of Conducted Spurious Emission

<1Mbps>

CSE Plot on Ch 00 between 30MHz ~ 3 GHz

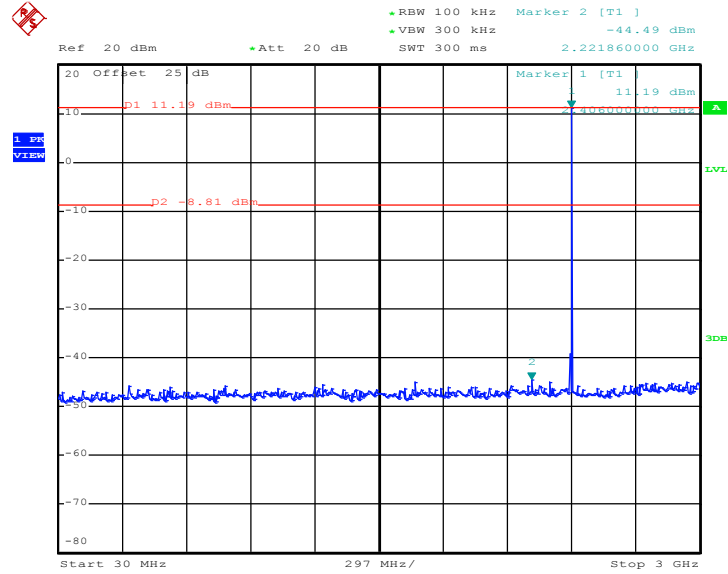

Date: 10.APR.2018 18:01:00

CSE Plot on Ch 00 between 2 GHz ~ 25 GHz

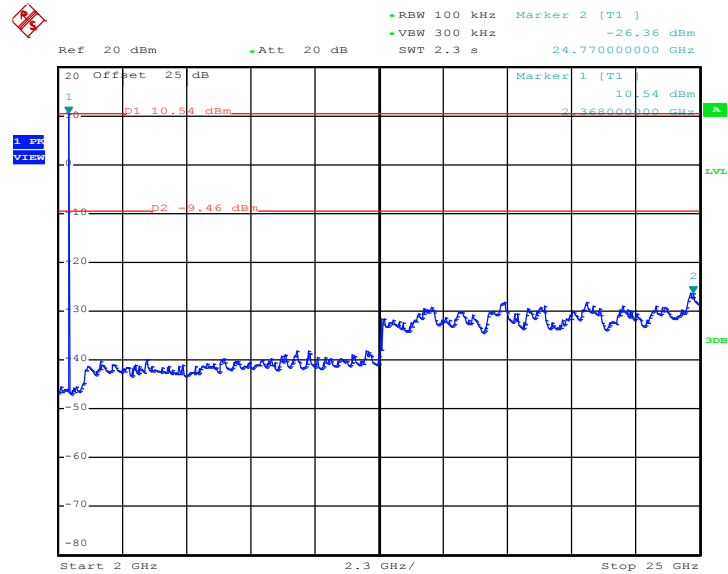

Date: 10.APR.2018 18:03:11



CSE Plot on Ch 39 between 30MHz ~ 3 GHz

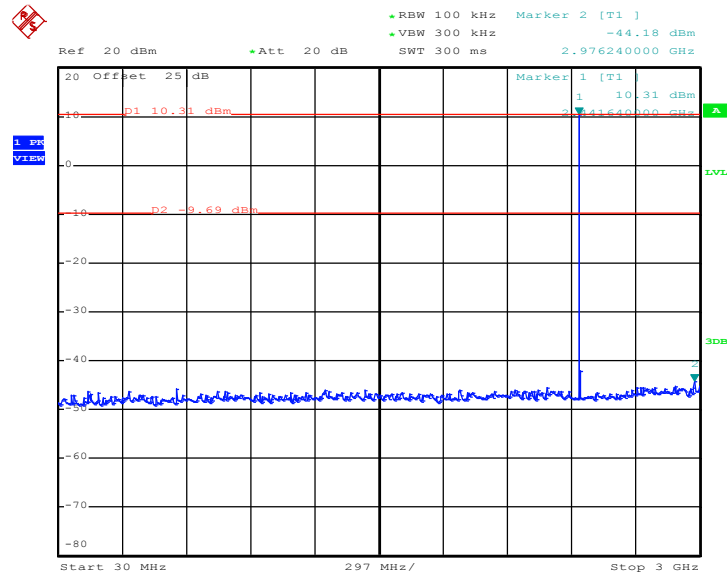

Date: 10.APR.2018 17:59:16

CSE Plot on Ch 39 between 2 GHz ~ 25 GHz

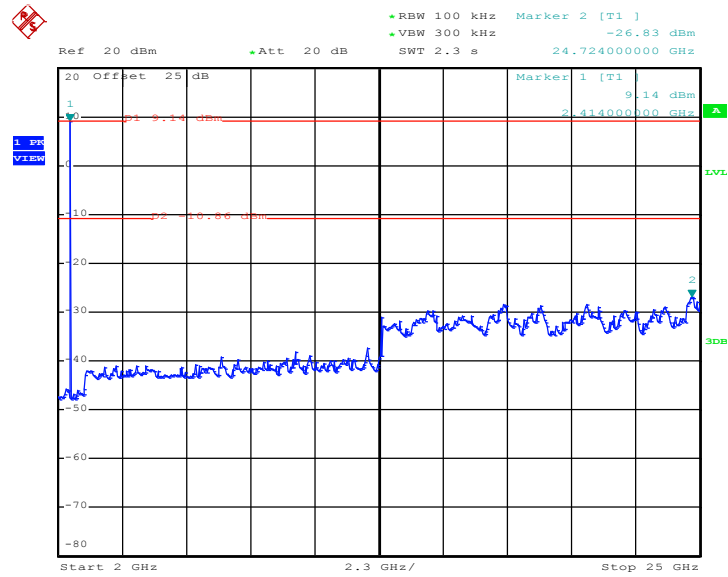

Date: 10.APR.2018 17:59:58



CSE Plot on Ch 78 between 30MHz ~ 3 GHz

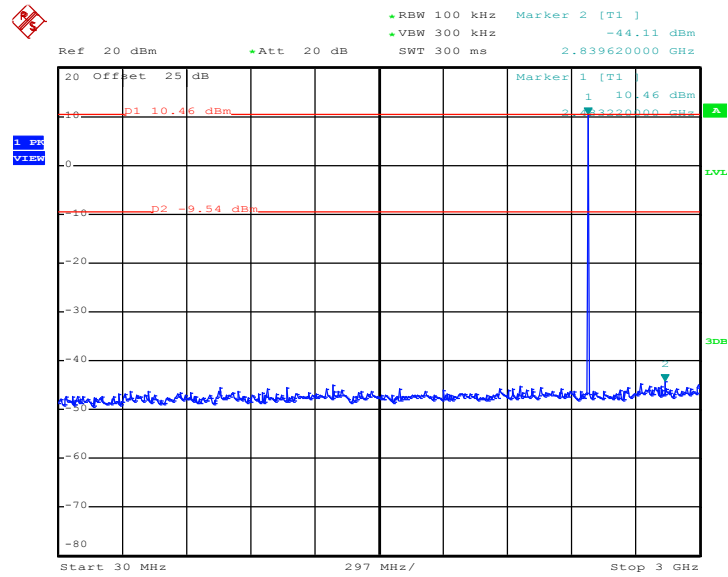

Date: 10.APR.2018 17:56:14

CSE Plot on Ch 78 between 2 GHz ~ 25 GHz

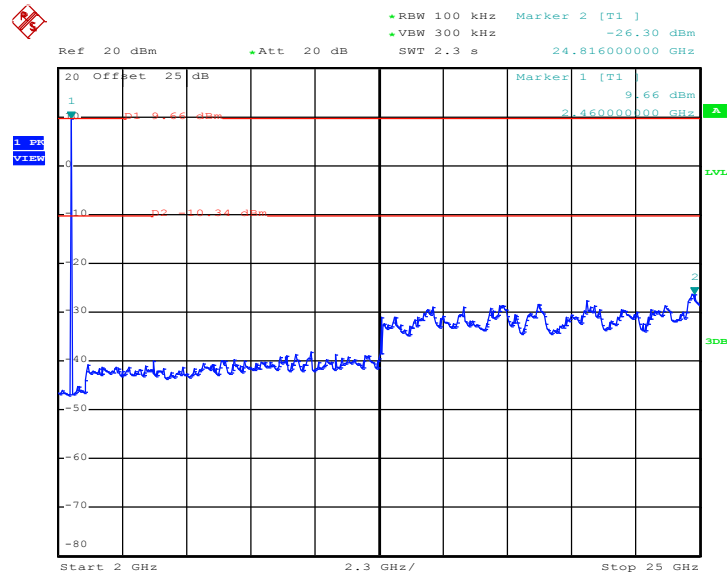

Date: 10.APR.2018 17:58:11



<2Mbps>

CSE Plot on Ch 00 between 30MHz ~ 3 GHz

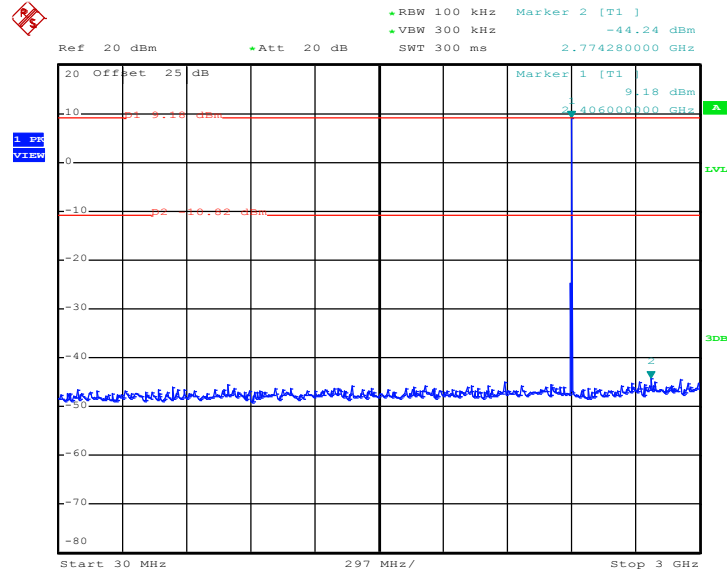

Date: 10.APR.2018 18:18:19

CSE Plot on Ch 00 between 2 GHz ~ 25 GHz

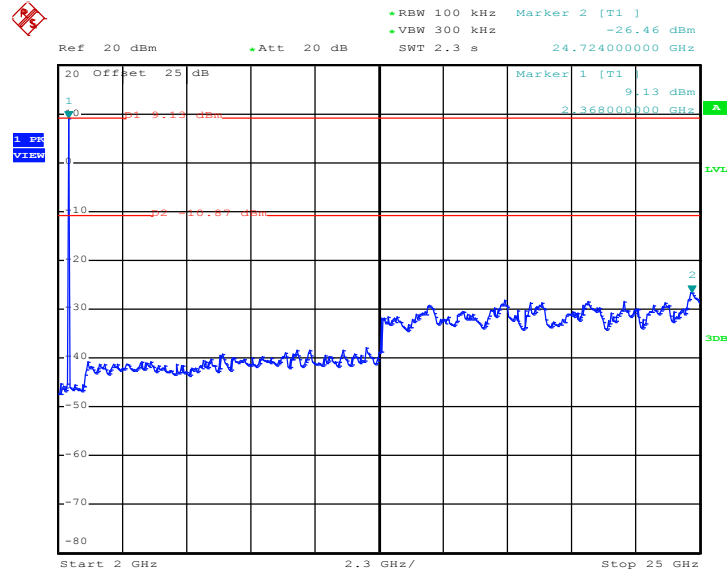

Date: 10.APR.2018 18:21:37



CSE Plot on Ch 39 between 30MHz ~ 3 GHz

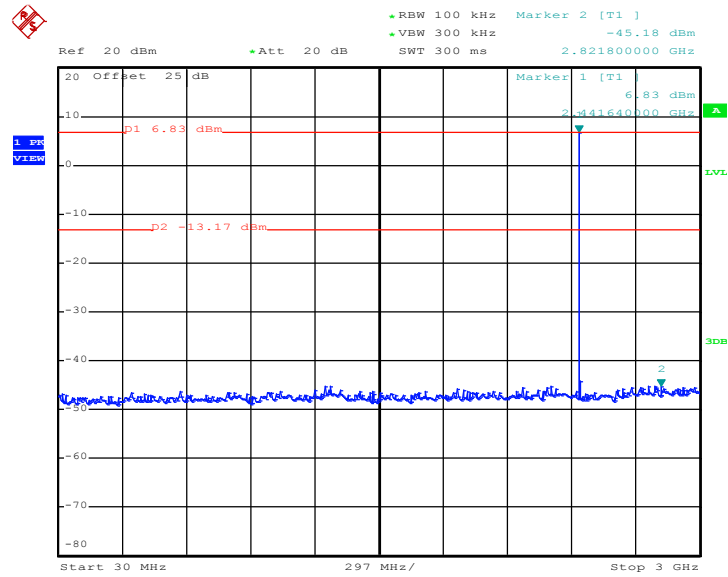

Date: 10.APR.2018 18:23:11

CSE Plot on Ch 39 between 2 GHz ~ 25 GHz

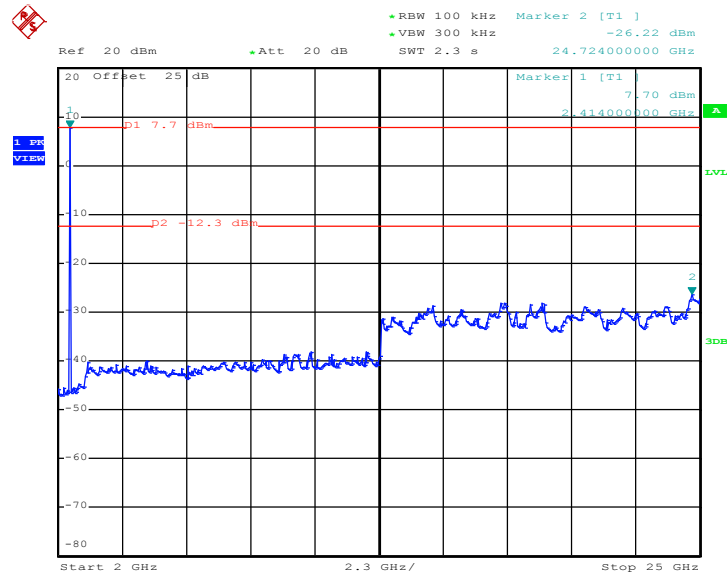

Date: 10.APR.2018 18:27:31



CSE Plot on Ch 78 between 30MHz ~ 3 GHz

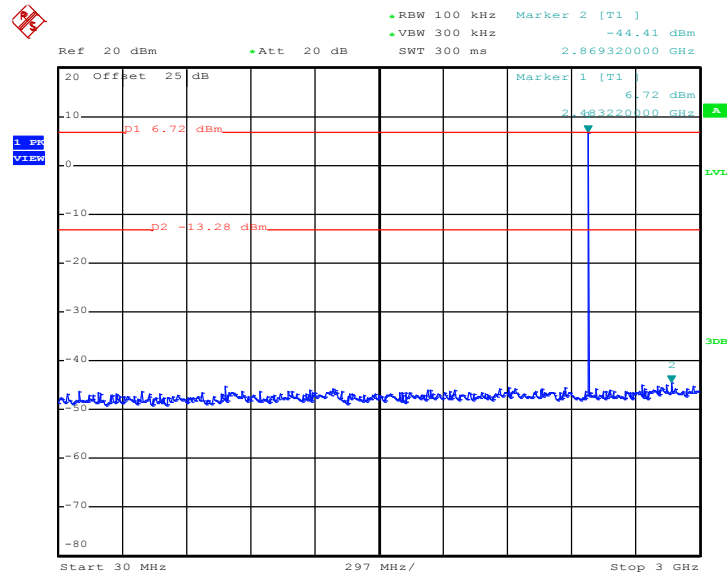

Date: 10.APR.2018 18:28:25

CSE Plot on Ch 78 between 2 GHz ~ 25 GHz

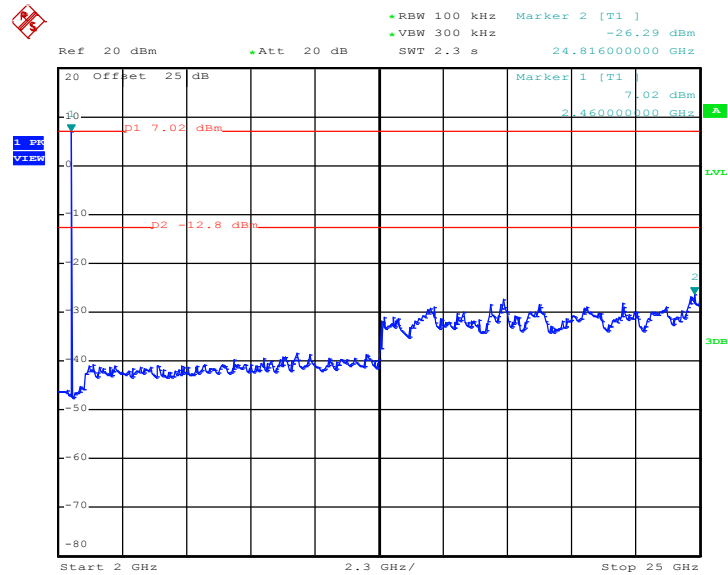

Date: 10.APR.2018 18:30:07



<3Mbps>

CSE Plot on Ch 00 between 30MHz ~ 3 GHz

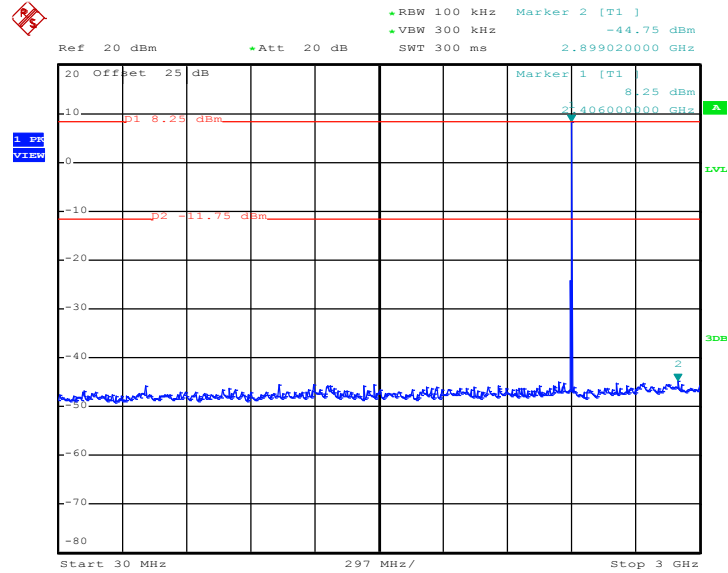

Date: 10.APR.2018 18:43:46

CSE Plot on Ch 00 between 2 GHz ~ 25 GHz

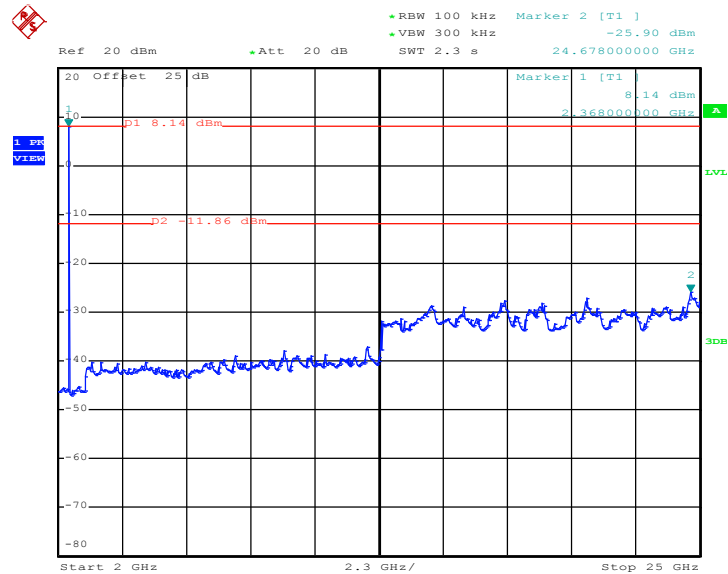

Date: 10.APR.2018 18:46:46



CSE Plot on Ch 39 between 30MHz ~ 3 GHz

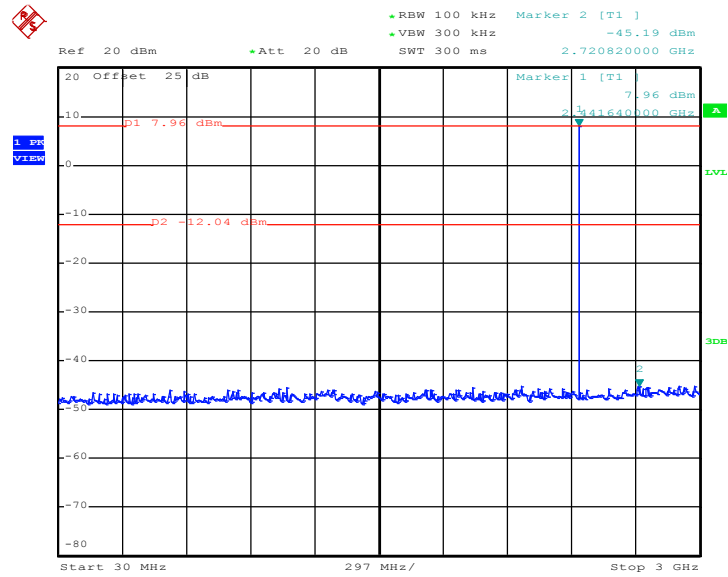

Date: 10.APR.2018 18:41:36

CSE Plot on Ch 39 between 2 GHz ~ 25 GHz

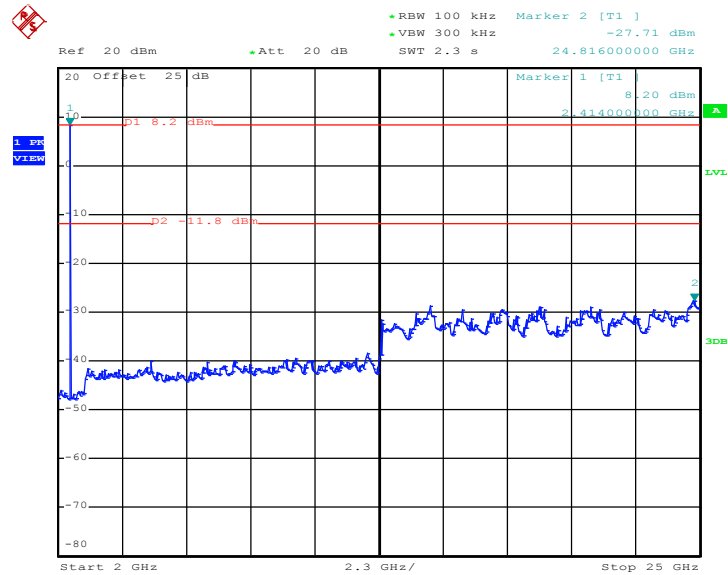

Date: 10.APR.2018 18:42:46



CSE Plot on Ch 78 between 30MHz ~ 3 GHz

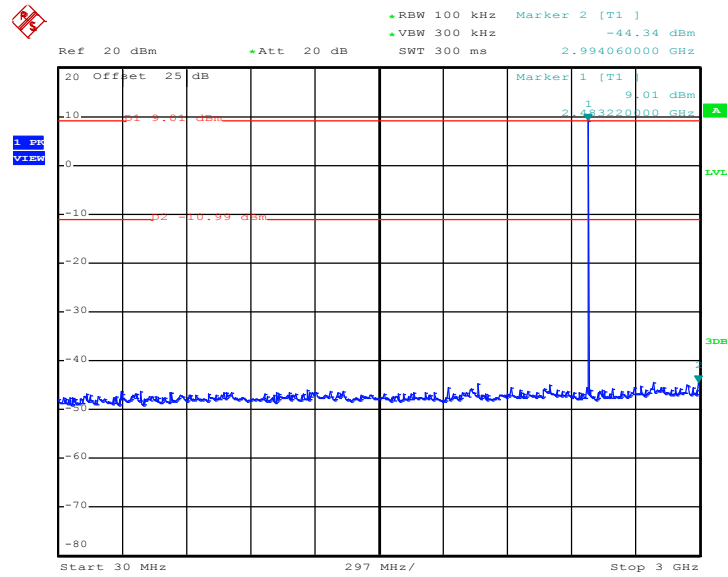

Date: 10.APR.2018 18:38:26

CSE Plot on Ch 78 between 2 GHz ~ 25 GHz

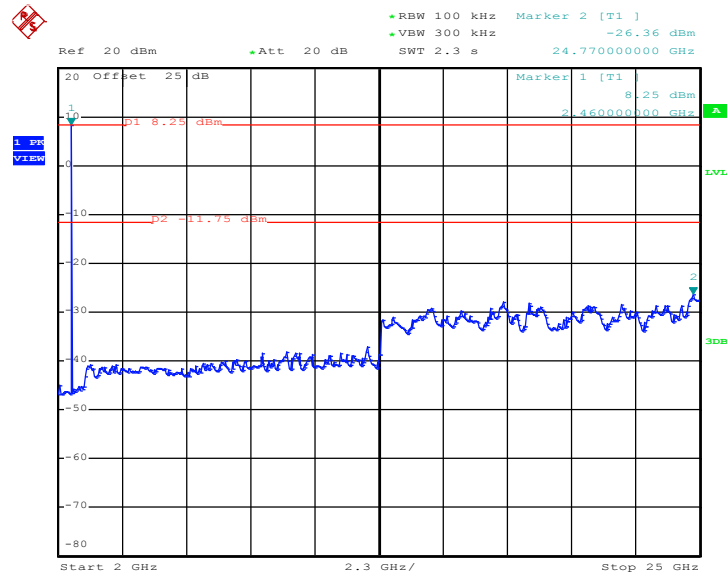

Date: 10.APR.2018 18:40:56



3.8 Radiated Band Edges and Spurious Emission Measurement

3.8.1 Limit of Radiated Band Edges and Spurious Emission

In any 100 kHz bandwidth outside the intentional radiator frequency band, all harmonics/spurious must be at least 20 dB below the highest emission level within the authorized band. In addition, radiated emissions which fall in the restricted bands must also comply with the limits as below.

Frequency (MHz)	Field Strength (microvolts/meter)	Measurement Distance (meters)
0.009 – 0.490	2400/F(kHz)	300
0.490 – 1.705	24000/F(kHz)	30
1.705 – 30.0	30	30
30 – 88	100	3
88 – 216	150	3
216 - 960	200	3
Above 960	500	3

3.8.2 Measuring Instruments

See list of measuring equipment of this test report.



3.8.3 Test Procedures

1. The EUT was placed on a turntable with 0.8 meter for frequency below 1GHz and 1.5 meter for frequency above 1GHz respectively above ground.
2. The EUT was set 3 meters from the interference receiving antenna, which was mounted on the top of a variable height antenna tower.
3. For each suspected emission, the EUT was arranged to its worst case and then tune the Antenna tower (from 1 m to 4 m) and turntable (from 0 degree to 360 degrees) to find the maximum reading. A pre-amp and a high pass filter are used for the test in order to get better signal level to comply with the guidelines.
4. Set to the maximum power setting and enable the EUT transmit continuously.
5. Use the following spectrum analyzer settings:
 - (1) Span shall wide enough to fully capture the emission being measured;
 - (2) Set RBW=100 kHz for $f < 1 \text{ GHz}$, RBW=1MHz for $f > 1\text{GHz}$; VBW \geq RBW; Sweep = auto; Detector function = peak; Trace = max hold for peak
 - (3) For average measurement: use duty cycle correction factor method per 15.35(c).
Duty cycle = On time/100 milliseconds
On time = $N_1 * L_1 + N_2 * L_2 + \dots + N_{n-1} * L_{n-1} + N_n * L_n$
Where N_1 is number of type 1 pulses, L_1 is length of type 1 pulses, etc.
Average Emission Level = Peak Emission Level + $20 * \log(\text{Duty cycle})$
6. Corrected Reading: Antenna Factor + Cable Loss + Read Level - Preamp Factor = Level
7. For testing below 1GHz, if the emission level of the EUT in peak mode was 3 dB lower than the limit specified, then peak values of EUT will be reported, otherwise, the emissions will be repeated one by one using the CISPR quasi-peak method and reported.
8. For testing above 1GHz, the emission level of the EUT in peak mode was 20dB lower than average limit (that means the emission level in average mode also complies with the limit in average mode), then peak values of EUT will be reported, otherwise, the emissions will be measured in average mode again and reported.

Note: The average levels were calculated from the peak level corrected with duty cycle correction factor (-24.76dB) derived from $20 \log(\text{dwell time}/100\text{ms})$. This correction is only for signals that hop with the fundamental signal, such as band-edge and harmonic. Other spurious signals that are independent of the hopping signal would not use this correction.

3.8.4 Test Setup

For radiated emissions below 30MHz

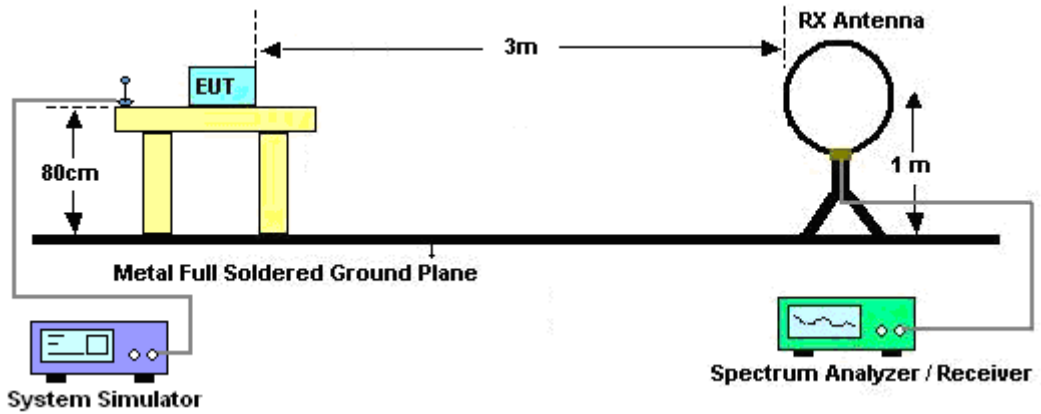

For radiated emissions from 30MHz to 1GHz

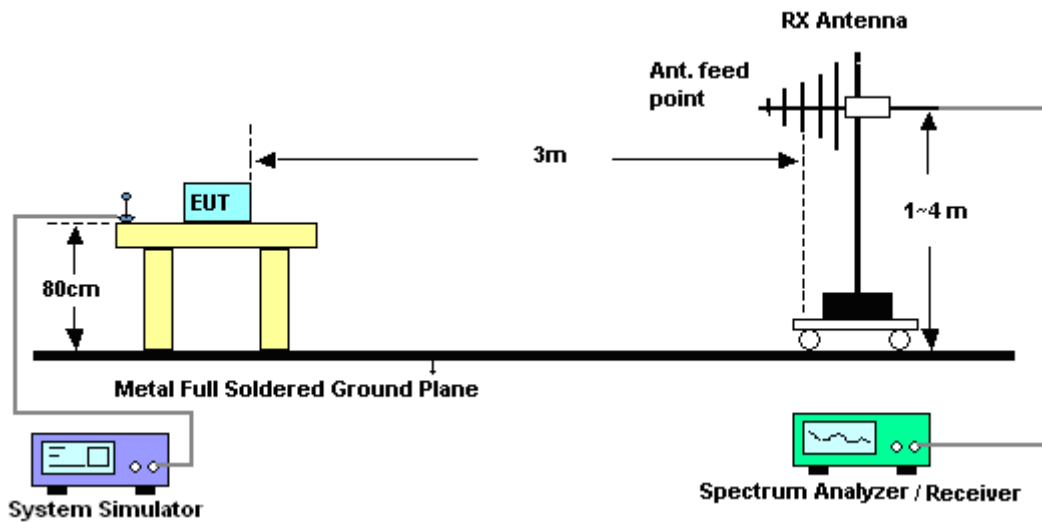

For radiated emissions above 1GHz

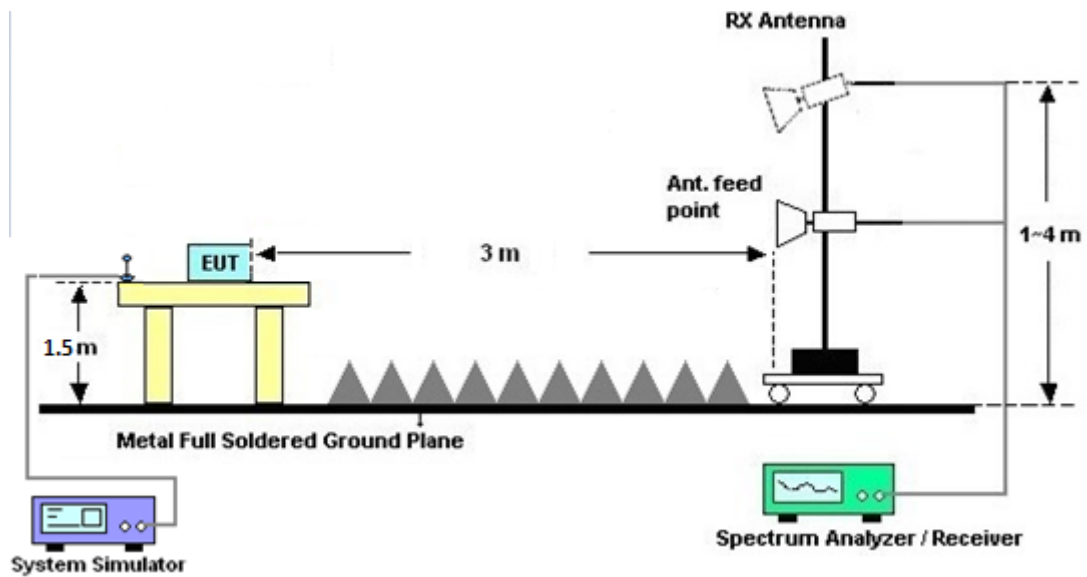

3.8.5 Test Results of Radiated Spurious Emissions (9 kHz ~ 30 MHz)

The low frequency, which started from 9 kHz to 30MHz, was pre-scanned and the result which was 20dB lower than the limit line was not reported.

There is a comparison data of both open-field test site and semi-Anechoic chamber, and the result came out very similar.

3.8.6 Test Result of Radiated Spurious at Band Edges

Please refer to Appendix C and D.

3.8.7 Duty Cycle

Please refer to Appendix E.

3.8.8 Test Result of Radiated Spurious Emission (30MHz ~ 10th Harmonic)

Please refer to Appendix C and D.



3.9 AC Conducted Emission Measurement

3.9.1 Limit of AC Conducted Emission

For equipment that is designed to be connected to the public utility (AC) power line, the radio frequency voltage that is conducted back onto the AC power line on any frequency or frequencies within the band 150 kHz to 30 MHz shall not exceed the limits in the following table.

Frequency of emission (MHz)	Conducted limit (dBµV)	
	Quasi-peak	Average
0.15-0.5	66 to 56*	56 to 46*
0.5-5	56	46
5-30	60	50

*Decreases with the logarithm of the frequency.

3.9.2 Measuring Instruments

See list of measuring equipment of this test report.

3.9.3 Test Procedures

1. The EUT was placed 0.4 meter from the conducting wall of the shielding room was kept at least 80 centimeters from any other grounded conducting surface.
2. Connect EUT to the power mains through a line impedance stabilization network (LISN).
3. All the support units are connecting to the other LISN.
4. The LISN provides 50 ohm coupling impedance for the measuring instrument.
5. The FCC states that a 50 ohm, 50 microhenry LISN should be used.
6. Both sides of AC line were checked for maximum conducted interference.
7. The frequency range from 150 kHz to 30 MHz was searched.
8. Set the test-receiver system to Peak Detect Function and specified bandwidth (IF Bandwidth = 9kHz) with Maximum Hold Mode. Then measurement is also conducted by Average Detector and Quasi-Peak Detector Function respectively.

3.9.4 Test Setup

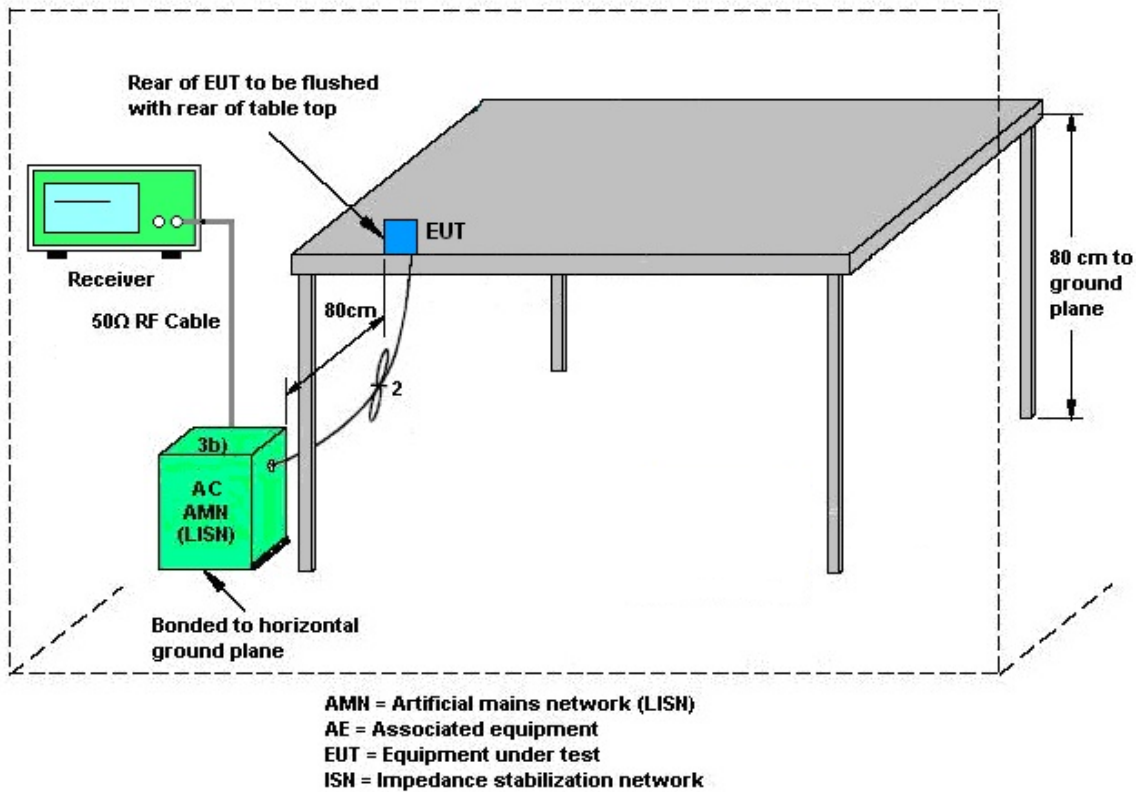

3.9.5 Test Result of AC Conducted Emission

Please refer to Appendix B.



3.10 Antenna Requirements

3.10.1 Standard Applicable

If directional gain of transmitting antennas is greater than 6dBi, the power shall be reduced by the same level in dB comparing to gain minus 6dBi. The use of a permanently attached antenna or of an antenna that uses a unique coupling to the intentional radiator shall be considered sufficient to comply with the rule.

3.10.2 Antenna Anti-Replacement Construction

An embedded-in antenna design is used.

3.10.3 Antenna Gain

The antenna peak gain of EUT is less than 6 dBi. Therefore, it is not necessary to reduce maximum peak output power limit.



4 List of Measuring Equipment

Instrument	Manufacturer	Model No.	Serial No.	Characteristics	Calibration Date	Test Date	Due Date	Remark
Power Meter	Agilent	E4416A	GB412923 44	N/A	Dec. 20, 2017	Apr. 03, 2018~ Apr. 10, 2018	Dec. 19, 2018	Conducted (TH05-HY)
Power Sensor	Agilent	E9327A	US404415 48	50MHz~18GHz	Dec. 20, 2017	Apr. 03, 2018~ Apr. 10, 2018	Dec. 19, 2018	Conducted (TH05-HY)
Spectrum Analyzer	Rohde & Schwarz	FSP40	100055	9kHz~40GHz	Jun. 20, 2017	Apr. 03, 2018~ Apr. 10, 2018	Jun. 19, 2018	Conducted (TH05-HY)
Switch Box & RF Cable	Burgeon	ETF-058	EC130048 4	N/A	Mar. 01, 2018	Apr. 03, 2018~ Apr. 10, 2018	Feb. 28, 2019	Conducted (TH05-HY)
Hygrometer	TECEPEL	HTC-1	2	N/A	Mar. 06, 2018	Apr. 03, 2018~ Apr. 10, 2018	Mar. 05, 2019	Conducted (TH05-HY)
RF Cable	HUBER + SUHNER	SUCOFLEX 104	MY842095 21	1GHz~26GHz	Dec. 01, 2017	Apr. 03, 2018~ Apr. 10, 2018	Nov. 30, 2018	Conducted (TH05-HY)
AC Power Source	ChainTek	APC-1000W	N/A	N/A	N/A	Apr. 17, 2018	N/A	Conduction (CO05-HY)
EMI Test Receiver	Rohde & Schwarz	ESR3	102388	3.6GHz	Dec. 08, 2017	Apr. 17, 2018	Dec. 07, 2018	Conduction (CO05-HY)
LISN	Rohde & Schwarz	ENV216	100080	9kHz~30MHz	Nov. 30, 2017	Apr. 17, 2018	Nov. 29, 2018	Conduction (CO05-HY)
LF Cable	HUBER + SUHNER	RG-214/U	LF01	N/A	Jan. 03, 2018	Apr. 17, 2018	Jan. 02, 2019	Conduction (CO05-HY)
Test Software	Rohde & Schwarz	EMC32 V10.30	N/A	N/A	N/A	Apr. 17, 2018	N/A	Conduction (CO05-HY)
Pulse Limiter	Rohde & Schwarz	ESH3-Z2	100851	N/A	Jan. 03, 2018	Apr. 17, 2018	Jan. 02, 2019	Conduction (CO05-HY)
Loop Antenna	Rohde & Schwarz	HFH2-Z2	100488	9 kHz~30 MHz	Nov. 23, 2017	Apr. 23, 2018~ Apr. 26, 2018	Nov. 22, 2018	Radiation (03CH12-HY)
Bilog Antenna	TESEQ	CBL 6111D&N-6-0 6	35414&AT- N0602	30MHz~1GHz	Oct. 14, 2017	Apr. 23, 2018~ Apr. 26, 2018	Oct. 13, 2018	Radiation (03CH12-HY)
Horn Antenna	SCHWARZBE CK	BBHA 9120D	9120D-132 8	1GHz ~ 18GHz	Oct. 20, 2017	Apr. 23, 2018~ Apr. 26, 2018	Oct. 19, 2018	Radiation (03CH12-HY)
SHF-EHF Horn Antenna	SCHWARZBE CK	BBHA 9170	BBHA9170 584	18GHz ~ 40GHz	Nov. 27, 2017	Apr. 23, 2018~ Apr. 26, 2018	Nov. 26, 2018	Radiation (03CH12-HY)
Spectrum Analyzer	Keysight	N9010A	MY542004 85	10Hz ~ 44GHz	Oct. 31, 2017	Apr. 23, 2018~ Apr. 26, 2018	Oct. 30, 2018	Radiation (03CH12-HY)
EMI Test Receiver	Rohde & Schwarz	ESU26	100390	20Hz~26.5GHz	Dec. 25, 2017	Apr. 23, 2018~ Apr. 26, 2018	Dec. 24, 2018	Radiation (03CH12-HY)
Preamplifier	COM-POWER	PA-103	161075	10MHz~1GHz	Mar. 26, 2018	Apr. 23, 2018~ Apr. 26, 2018	Mar. 25, 2019	Radiation (03CH12-HY)
Preamplifier	Jet-Power	JPA0118-55-3 03K	171000180 0054002	1GHz~18GHz	Apr. 17, 2018	Apr. 23, 2018~ Apr. 26, 2018	Apr. 16, 2019	Radiation (03CH12-HY)
Preamplifier	Keysight	83017A	MY532701 48	1GHz~26.5GHz	Jan. 15, 2018	Apr. 23, 2018~ Apr. 26, 2018	Jan. 14, 2019	Radiation (03CH12-HY)
Amplifier	MITEQ	TTA1840-35- HG	1871923	18GHz~40GHz, VSWR : 2.5:1 max	Jul. 18, 2017	Apr. 23, 2018~ Apr. 26, 2018	Jul. 17, 2018	Radiation (03CH12-HY)



Instrument	Manufacturer	Model No.	Serial No.	Characteristics	Calibration Date	Test Date	Due Date	Remark
Hygrometer	TECPEL	DTM-303B	TP140320	N/A	Nov. 13, 2017	Apr. 23, 2018~ Apr. 26, 2018	Nov. 12, 2018	Radiation (03CH12-HY)
RF Cable	HUBER + SUHNER	SUCOFLEX 126E	0058/126E	30M-18G	Mar. 14, 2018	Apr. 23, 2018~ Apr. 26, 2018	Mar. 13, 2019	Radiation (03CH12-HY)
RF Cable	HUBER + SUHNER	SUCOFLEX 104	MY15539/ 4	30M-18G	Mar. 14, 2018	Apr. 23, 2018~ Apr. 26, 2018	Mar. 13, 2019	Radiation (03CH12-HY)
RF Cable	HUBER + SUHNER	SUCOFLEX 104	MY36979/ 4	30M-18G	Mar. 14, 2018	Apr. 23, 2018~ Apr. 26, 2018	Mar. 13, 2019	Radiation (03CH12-HY)
RF Cable	HUBER + SUHNER	SUCOFLEX 102	505134/2	30M~40GHz	Oct. 17, 2017	Apr. 23, 2018~ Apr. 26, 2018	Oct. 16, 2018	Radiation (03CH12-HY)
RF Cable	HUBER + SUHNER	SUCOFLEX 102	800740/2	30M~40GHz	Oct. 17, 2017	Apr. 23, 2018~ Apr. 26, 2018	Oct. 16, 2018	Radiation (03CH12-HY)
Filter	Wainwright	WHKX12-270 0-3000-18000 -60ST	SN2	3 GHz Highpass	Jul. 17, 2017	Apr. 23, 2018~ Apr. 26, 2018	Jul. 16, 2018	Radiation (03CH12-HY)
Filter	Wainwright	WLKS1200-1 2SS	SN2	1.2G Low Pass	Jul. 17, 2017	Apr. 23, 2018~ Apr. 26, 2018	Jul. 16, 2018	Radiation (03CH12-HY)
Antenna Mast	EMEC	AM-BS-4500- B	N/A	1m~4m	N/A	Apr. 23, 2018~ Apr. 26, 2018	N/A	Radiation (03CH12-HY)
Turn Table	EMEC	TT2000	N/A	0~360 Degree	N/A	Apr. 23, 2018~ Apr. 26, 2018	N/A	Radiation (03CH12-HY)
Test Software	Audix	E3 6.2009-8-24	RK-00098 9	N/A	N/A	Apr. 23, 2018~ Apr. 26, 2018	N/A	Radiation (03CH12-HY)



5 Uncertainty of Evaluation

Uncertainty of Conducted Emission Measurement (150 kHz ~ 30 MHz)

Measuring Uncertainty for a Level of Confidence of 95% ($U = 2Uc(y)$)	2.70
---	------

Uncertainty of Radiated Emission Measurement (30 MHz ~ 1000 MHz)

Measuring Uncertainty for a Level of Confidence of 95% ($U = 2Uc(y)$)	5.10
---	------

Uncertainty of Radiated Emission Measurement (1000 MHz ~ 18000 MHz)

Measuring Uncertainty for a Level of Confidence of 95% ($U = 2Uc(y)$)	5.20
---	------

Uncertainty of Radiated Emission Measurement (18000 MHz ~ 40000 MHz)

Measuring Uncertainty for a Level of Confidence of 95% ($U = 2Uc(y)$)	4.70
---	------

Appendix A. Test Result of Conducted Test Items

Test Engineer:	Tommy Lee / Rebecca Li	Temperature:	21~25	°C
Test Date:	2018/4/3~2018/4/10	Relative Humidity:	51~54	%

TEST RESULTS DATA									
20dB and 99% Occupied Bandwidth and Hopping Channel Separation									
Mod.	Data Rate	NTX	CH.	Freq. (MHz)	20db BW (MHz)	99% Bandwidth (MHz)	Hopping Channel Separation Measurement (MHz)	Hopping Channel Separation Measurement Limit (MHz)	Pass/Fail
DH	1Mbps	1	0	2402	0.896	0.816	1.014	0.5973	Pass
DH	1Mbps	1	39	2441	0.892	0.840	1.002	0.5947	Pass
DH	1Mbps	1	78	2480	0.892	0.840	1.002	0.5947	Pass
2DH	2Mbps	1	0	2402	1.284	1.168	1.008	0.8560	Pass
2DH	2Mbps	1	39	2441	1.266	1.168	1.128	0.8440	Pass
2DH	2Mbps	1	78	2480	1.266	1.176	1.002	0.8440	Pass
3DH	3Mbps	1	0	2402	1.242	1.152	1.014	0.8280	Pass
3DH	3Mbps	1	39	2441	1.236	1.152	1.008	0.8240	Pass
3DH	3Mbps	1	78	2480	1.236	1.156	1.002	0.8240	Pass

TEST RESULTS DATA						
Dwell Time						
Mod.	Hopping Channel Number Rate	Hops Over Occupancy Time(hops)	Package Transfer Time (msec)	Dwell Time (sec)	Limits (sec)	Pass/Fail
Nomal	79	106.67	2.90	0.31	0.4	Pass
AFH	20	53.33	2.90	0.15	0.4	Pass

TEST RESULTS DATA					
Peak Power Table					
DH	CH.	NTX	Peak Power (dBm)	Power Limit (dBm)	Test Result
DH1	0	1	11.65	20.97	Pass
	39	1	10.82	20.97	Pass
	78	1	11.04	20.97	Pass
2DH1	0	1	11.17	20.97	Pass
	39	1	10.22	20.97	Pass
	78	1	10.52	20.97	Pass
3DH1	0	1	11.41	20.97	Pass
	39	1	10.52	20.97	Pass
	78	1	10.83	20.97	Pass

TEST RESULTS DATA				
Average Power Table				
(Reporting Only)				
DH	CH.	NTX	Average Power (dBm)	Duty Factor (dB)
DH1	0	1	11.53	5.16
	39	1	10.66	5.16
	78	1	10.88	5.16
2DH1	0	1	9.27	5.12
	39	1	8.07	5.12
	78	1	8.69	5.12
3DH1	0	1	9.26	5.07
	39	1	8.02	5.07
	78	1	8.67	5.07

TEST RESULTS DATA			
Number of Hopping Frequency			
Number of Hopping (Channel)	Adaptive Frequency Hopping (Channel)	Limits (Channel)	Pass/Fail
79	20	> 15	Pass



Appendix B. AC Conducted Emission Test Results

Test Engineer :	Blue Lan	Temperature :	25~26°C
		Relative Humidity :	55~58%

EUT Information

Report NO : 832501-01
 Test Mode : Mode 1
 Test Voltage : 120Vac/60Hz
 Phase : Line

Full Spectrum

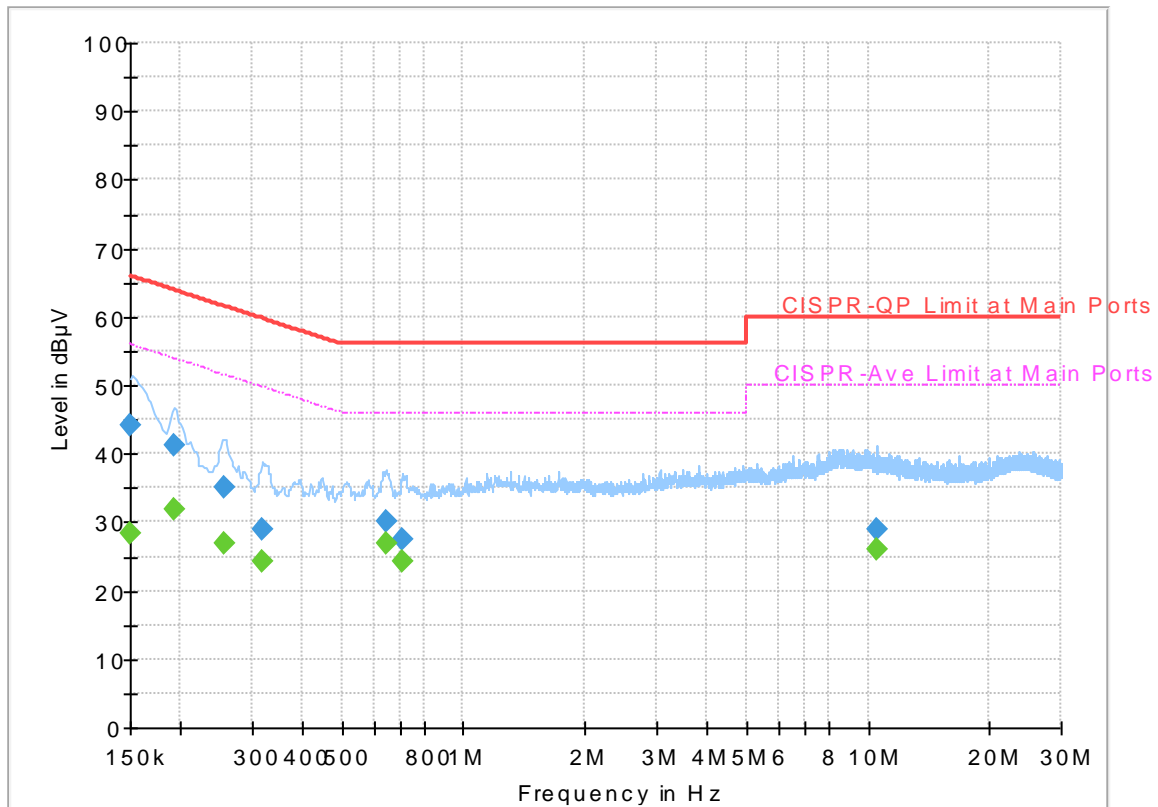

Final_Result

Frequency (MHz)	QuasiPeak (dBµV)	CAverage (dBµV)	Limit (dBµV)	Margin (dB)	Line	Filter	Corr. (dB)
0.150000	---	28.45	56.00	27.55	L1	OFF	19.5
0.150000	44.07	---	66.00	21.93	L1	OFF	19.5
0.192750	---	31.95	53.92	21.97	L1	OFF	19.5
0.192750	41.32	---	63.92	22.60	L1	OFF	19.5
0.255750	---	26.95	51.57	24.62	L1	OFF	19.5
0.255750	35.22	---	61.57	26.35	L1	OFF	19.5
0.318750	---	24.17	49.74	25.57	L1	OFF	19.5
0.318750	29.06	---	59.74	30.68	L1	OFF	19.5
0.642750	---	26.91	46.00	19.09	L1	OFF	19.5
0.642750	30.09	---	56.00	25.91	L1	OFF	19.5
0.708000	---	24.14	46.00	21.86	L1	OFF	19.5
0.708000	27.45	---	56.00	28.55	L1	OFF	19.5
10.524750	---	26.12	50.00	23.88	L1	OFF	19.7
10.524750	29.09	---	60.00	30.91	L1	OFF	19.7

EUT Information

Report NO : 832501-01
 Test Mode : Mode 1
 Test Voltage : 120Vac/60Hz
 Phase : Neutral

Full Spectrum

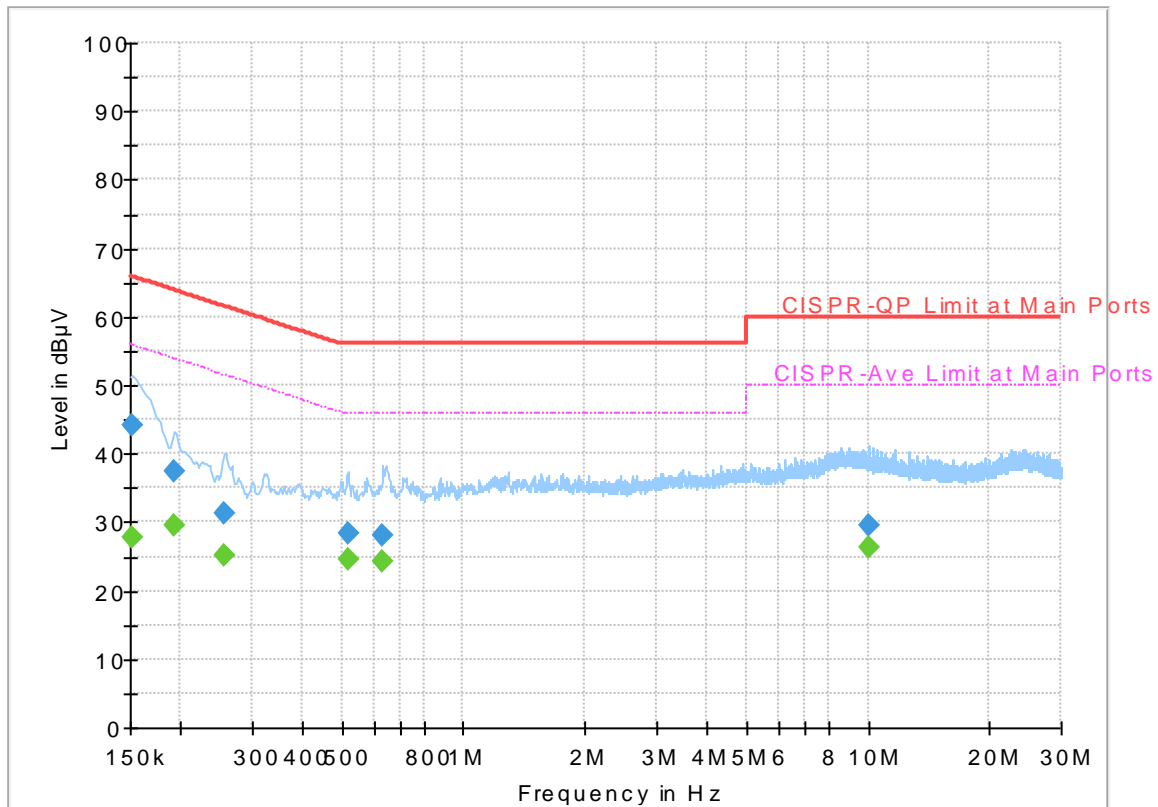

Final Result

Frequency (MHz)	QuasiPeak (dBµV)	CAverage (dBµV)	Limit (dBµV)	Margin (dB)	Line	Filter	Corr. (dB)
0.152250	---	27.86	55.88	28.02	N	OFF	19.5
0.152250	44.06	---	65.88	21.82	N	OFF	19.5
0.192750	---	29.43	53.92	24.49	N	OFF	19.5
0.192750	37.35	---	63.92	26.57	N	OFF	19.5
0.255750	---	25.14	51.57	26.43	N	OFF	19.5
0.255750	31.24	---	61.57	30.33	N	OFF	19.5
0.516750	---	24.60	46.00	21.40	N	OFF	19.5
0.516750	28.34	---	56.00	27.66	N	OFF	19.5
0.631500	---	24.14	46.00	21.86	N	OFF	19.5
0.631500	28.02	---	56.00	27.98	N	OFF	19.5
10.054500	---	26.37	50.00	23.63	N	OFF	19.7
10.054500	29.64	---	60.00	30.36	N	OFF	19.7



Appendix C. Radiated Spurious Emission

Test Engineer :	Watt Tseng, Karl Hou, and Nick Yu	Temperature :	21~23°C
		Relative Humidity :	59~62%

2.4GHz 2400~2483.5MHz

BT 1Mbps (Band Edge @ 3m)

BT	Note	Frequency	Level	Over	Limit	Read	Antenna	Path	Preamp	Ant	Table	Peak	Pol.	
		(MHz)	(dBμV/m)	(dB)	Limit	Level	Factor	Loss	Factor	Pos	Pos	Avg.		
					Line	(dBμV)	(dB/m)	(dB)	(dB)	(cm)	(deg)	(P/A)	(H/V)	
BT CH00 2402MHz		2353.575	43.17	-30.83	74	43.68	27.07	4	31.58	223	51	P	H	
		2353.575	18.41	-35.59	54	-	-	-	-	-	-	A	H	
	*	2402	104.37	-	-	104.75	27.15	4.04	31.57	223	51	P	H	
	*	2402	79.61	-	-	-	-	-	-	-	-	A	H	
													H	
														H
			2350.005	44.44	-29.56	74	44.99	27.03	4	31.58	317	270	P	V
			2350.005	19.68	-34.32	54	-	-	-	-	-	-	A	V
	*		2402	103.73	-	-	104.11	27.15	4.04	31.57	317	270	P	V
	*		2402	78.97	-	-	-	-	-	-	-	-	A	V
														V
	BT CH 39 2441MHz		2351.58	44.51	-29.49	74	45.02	27.07	4	31.58	225	59	P	H
		2351.58	19.75	-34.25	54	-	-	-	-	-	-	A	H	
*		2441	103.04	-	-	103.25	27.28	4.07	31.56	225	59	P	H	
*		2441	78.28	-	-	-	-	-	-	-	-	A	H	
			2489.57	44.8	-29.2	74	44.85	27.4	4.11	31.56	225	59	P	H
			2489.57	20.04	-33.96	54	-	-	-	-	-	-	A	H
			2350.32	44.22	-29.78	74	44.77	27.03	4	31.58	250	258	P	V
			2350.32	19.46	-34.54	54	-	-	-	-	-	-	A	V
*			2441	102.28	-	-	102.49	27.28	4.07	31.56	250	258	P	V
*			2441	77.52	-	-	-	-	-	-	-	-	A	V
			2491.11	45.04	-28.96	74	45.09	27.4	4.11	31.56	250	258	P	V
			2491.11	20.28	-33.72	54	-	-	-	-	-	-	A	V



BT CH 78 2480MHz	*	2480	101.55	-	-	101.66	27.36	4.09	31.56	236	52	P	H
	*	2480	76.79	-	-	-	-	-	-	-	-	A	H
		2483.68	51.32	-22.68	74	51.41	27.36	4.11	31.56	236	52	P	H
		2483.68	26.56	-27.44	54	-	-	-	-	-	-	A	H
													H
													H
	*	2480	100.45	-	-	100.56	27.36	4.09	31.56	222	247	P	V
	*	2480	75.69	-	-	-	-	-	-	-	-	A	V
		2483.52	49.83	-24.17	74	49.92	27.36	4.11	31.56	222	247	P	V
		2483.52	25.07	-28.93	54	-	-	-	-	-	-	A	V
													V
													V
Remark	1. No other spurious found. 2. All results are PASS against Peak and Average limit line.												



**2.4GHz 2400~2483.5MHz
BT 1Mbps (Harmonic @ 3m)**

BT	Note	Frequency	Level	Over Limit	Limit Line	Read Level	Antenna Factor	Path Loss	Preamp Factor	Ant Pos	Table Pos	Peak Avg.	Pol.	
		(MHz)	(dBμV/m)	(dB)	(dBμV/m)	(dBμV)	(dB/m)	(dB)	(dB)	(cm)	(deg)	(P/A)	(H/V)	
BT CH 00 2402MHz		4804	40.85	-33.15	74	59.41	31.32	6.7	56.58	100	0	P	H	
		4804	16.09	-37.91	54	-	-	-	-	-	-	A	H	
													H	
													H	
		4804	44.38	-29.62	74	62.94	31.32	6.7	56.58	100	0	P	V	
		4804	19.62	-34.38	54	-	-	-	-	-	-	-	A	V
														V
														V
BT CH 39 2441MHz		4882	39.38	-34.62	74	57.74	31.46	6.73	56.55	100	0	P	H	
		4882	14.62	-39.38	54	-	-	-	-	-	-	A	H	
		7323	42.38	-31.62	74	54.38	36.15	8.06	56.21	100	0	P	H	
		7323	17.62	-36.38	54	-	-	-	-	-	-	A	H	
		4882	42.28	-31.72	74	60.64	31.46	6.73	56.55	100	0	P	V	
		4882	17.52	-36.48	54	-	-	-	-	-	-	A	V	
		7323	43.2	-30.8	74	55.2	36.15	8.06	56.21	100	0	P	V	
		7323	18.44	-35.56	54	-	-	-	-	-	-	A	V	
BT CH 78 2480MHz		4960	40.27	-33.73	74	58.41	31.63	6.75	56.52	100	0	P	H	
		4960	15.51	-38.49	54	-	-	-	-	-	-	A	H	
		7440	44.18	-29.82	74	55.71	36.47	8.07	56.07	100	0	P	H	
		7440	19.42	-34.58	54	-	-	-	-	-	-	A	H	
		4960	41.96	-32.04	74	60.1	31.63	6.75	56.52	100	0	P	V	
		4960	17.2	-36.8	54	-	-	-	-	-	-	A	V	
		7440	44.1	-29.9	74	55.63	36.47	8.07	56.07	100	0	P	V	
		7440	19.34	-34.66	54	-	-	-	-	-	-	A	V	
Remark	1. No other spurious found. 2. All results are PASS against Peak and Average limit line.													



Emission below 1GHz

2.4GHz BT 1Mbps (LF)

BT	Note	Frequency	Level	Over Limit	Limit Line	Read Level	Antenna Factor	Path Loss	Preamp Factor	Ant Pos	Table Pos	Peak Avg.	Pol.	
		(MHz)	(dBμV/m)	(dB)	(dBμV/m)	(dBμV)	(dB/m)	(dB)	(dB)	(cm)	(deg)	(P/A)	(H/V)	
2.4GHz BT LF		43.77	26.04	-13.96	40	38.73	17.08	0.61	30.38	-	-	P	H	
		81.57	33.12	-6.88	40	49.42	13.32	0.82	30.44	100	0	P	H	
		204.15	30.72	-12.78	43.5	44.79	14.92	1.32	30.31	-	-	P	H	
		300	31.79	-14.21	46	41.36	19.08	1.49	30.14	-	-	P	H	
		451.2	29.73	-16.27	46	34.86	22.99	1.76	29.88	-	-	P	H	
		576.5	29.8	-16.2	46	31.88	25.57	2.02	29.67	-	-	P	H	
														H
														H
														H
														H
														H
														H
														H
			43.77	28.77	-11.23	40	41.46	17.08	0.61	30.38	-	-	P	V
			69.69	29.33	-10.67	40	47.08	11.97	0.73	30.45	100	0	P	V
			81.84	26.1	-13.9	40	42.4	13.32	0.82	30.44	-	-	P	V
			323.8	26.44	-19.56	46	35.66	19.36	1.52	30.1	-	-	P	V
			566	27.91	-18.09	46	29.7	25.86	2.03	29.68	-	-	P	V
			729.1	32.86	-13.14	46	32.76	27.27	2.28	29.45	-	-	P	V
														V
													V	
													V	
													V	
													V	
													V	
Remark	1. No other spurious found. 2. All results are PASS against limit line.													



2.4GHz 2400~2483.5MHz

BT 2Mbps (Band Edge @ 3m)

BT	Note	Frequency	Level	Over Limit	Limit Line	Read Level	Antenna Factor	Path Loss	Preamp Factor	Ant Pos	Table Pos	Peak Avg.	Pol.	
		(MHz)	(dBμV/m)	(dB)	(dBμV/m)	(dBμV)	(dB/m)	(dB)	(dB)	(cm)	(deg)	(P/A)	(H/V)	
BT CH00 2402MHz		2314.2	48.28	-25.72	74	48.96	26.94	3.97	31.59	223	51	P	H	
		2314.2	23.55	-30.45	54	-	-	-	-	-	-	A	H	
	*	2402	103.49	-	-	103.87	27.15	4.04	31.57	223	51	P	H	
	*	2402	78.76	-	-	-	-	-	-	-	-	A	H	
													H	
														H
			2315.985	44.4	-29.6	74	45.08	26.94	3.97	31.59	317	270	P	V
			2315.985	19.67	-34.33	54	-	-	-	-	-	-	A	V
	*		2402	102.79	-	-	103.17	27.15	4.04	31.57	317	270	P	V
	*		2402	78.06	-	-	-	-	-	-	-	-	A	V
														V
														V
BT CH 39 2441MHz		2329.46	44.09	-29.91	74	44.71	26.99	3.98	31.59	225	59	P	H	
		2329.46	19.36	-34.64	54	-	-	-	-	-	-	A	H	
	*	2441	101.84	-	-	102.05	27.28	4.07	31.56	225	59	P	H	
	*	2441	77.11	-	-	-	-	-	-	-	-	A	H	
			2485.72	44.53	-29.47	74	44.62	27.36	4.11	31.56	225	59	P	H
			2485.72	19.8	-34.2	54	-	-	-	-	-	-	A	H
			2362.78	44.43	-29.57	74	44.93	27.07	4.01	31.58	250	258	P	V
			2362.78	19.7	-34.3	54	-	-	-	-	-	-	A	V
	*		2441	101.09	-	-	101.3	27.28	4.07	31.56	250	258	P	V
	*		2441	76.36	-	-	-	-	-	-	-	-	A	V
			2484.53	44.43	-29.57	74	44.52	27.36	4.11	31.56	250	258	P	V
			2484.53	19.7	-34.3	54	-	-	-	-	-	-	A	V



BT CH 78 2480MHz	*	2480	100.59	-	-	100.7	27.36	4.09	31.56	236	52	P	H
	*	2480	75.86	-	-	-	-	-	-	-	-	A	H
		2483.52	49.8	-24.2	74	49.89	27.36	4.11	31.56	236	52	P	H
		2483.52	25.07	-28.93	54	-	-	-	-	-	-	A	H
													H
													H
	*	2480	99.59	-	-	99.7	27.36	4.09	31.56	222	247	P	V
	*	2480	74.86	-	-	-	-	-	-	-	-	A	V
		2483.6	47.54	-26.46	74	47.63	27.36	4.11	31.56	222	247	P	V
		2483.6	22.81	-31.19	54	-	-	-	-	-	-	A	V
													V
													V
Remark	1. No other spurious found. 2. All results are PASS against Peak and Average limit line.												



2.4GHz 2400~2483.5MHz
BT 2Mbps (Harmonic @ 3m)

BT	Note	Frequency	Level	Over Limit	Limit Line	Read Level	Antenna Factor	Path Loss	Preamp Factor	Ant Pos	Table Pos	Peak Avg.	Pol.	
		(MHz)	(dBμV/m)	(dB)	(dBμV/m)	(dBμV)	(dB/m)	(dB)	(dB)	(cm)	(deg)	(P/A)	(H/V)	
BT CH 00 2402MHz		4804	40.13	-33.87	74	58.69	31.32	6.7	56.58	100	0	P	H	
		4804	15.4	-38.6	54	-	-	-	-	-	-	A	H	
													H	
													H	
		4804	43.66	-30.34	74	62.22	31.32	6.7	56.58	100	0	P	V	
		4804	18.93	-35.07	54	-	-	-	-	-	-	-	A	V
														V
														V
BT CH 39 2441MHz		4882	39.93	-34.07	74	58.29	31.46	6.73	56.55	100	0	P	H	
		4882	15.2	-38.8	54	-	-	-	-	-	-	A	H	
		7323	42.86	-31.14	74	54.86	36.15	8.06	56.21	100	0	P	H	
		7323	18.13	-35.87	54	-	-	-	-	-	-	A	H	
		4882	40.51	-33.49	74	58.87	31.46	6.73	56.55	100	0	P	V	
		4882	15.78	-38.22	54	-	-	-	-	-	-	A	V	
		7323	44.09	-29.91	74	56.09	36.15	8.06	56.21	100	0	P	V	
		7323	19.36	-34.64	54	-	-	-	-	-	-	A	V	
BT CH 78 2480MHz		4960	40.59	-33.41	74	58.73	31.63	6.75	56.52	100	0	P	H	
		4960	15.86	-38.14	54	-	-	-	-	-	-	A	H	
		7440	44.6	-29.4	74	56.13	36.47	8.07	56.07	100	0	P	H	
		7440	19.87	-34.13	54	-	-	-	-	-	-	A	H	
		4960	41.96	-32.04	74	60.1	31.63	6.75	56.52	100	0	P	V	
		4960	17.23	-36.77	54	-	-	-	-	-	-	A	V	
		7440	45.32	-28.68	74	56.85	36.47	8.07	56.07	100	0	P	V	
		7440	20.59	-33.41	54	-	-	-	-	-	-	A	V	
Remark	1. No other spurious found. 2. All results are PASS against Peak and Average limit line.													



2.4GHz 2400~2483.5MHz

BT 3Mbps (Band Edge @ 3m)

BT	Note	Frequency	Level	Over Limit	Limit Line	Read Level	Antenna Factor	Path Loss	Preamp Factor	Ant Pos	Table Pos	Peak Avg.	Pol.	
		(MHz)	(dBμV/m)	(dB)	(dBμV/m)	(dBμV)	(dB/m)	(dB)	(dB)	(cm)	(deg)	(P/A)	(H/V)	
BT CH00 2402MHz		2323.965	48.27	-25.73	74	48.89	26.99	3.98	31.59	223	51	P	H	
		2323.965	23.54	-30.46	54	-	-	-	-	-	-	A	H	
	*	2402	103.54	-	-	103.92	27.15	4.04	31.57	223	51	P	H	
	*	2402	78.81	-	-	-	-	-	-	-	-	A	H	
													H	
														H
			2350.215	44.45	-29.55	74	45	27.03	4	31.58	317	270	P	V
			2350.215	19.72	-34.28	54	-	-	-	-	-	-	A	V
	*		2402	102.93	-	-	103.31	27.15	4.04	31.57	317	270	P	V
	*		2402	78.2	-	-	-	-	-	-	-	-	A	V
														V
														V
BT CH 39 2441MHz		2348.64	44.75	-29.25	74	45.3	27.03	4	31.58	225	59	P	H	
		2348.64	20.02	-33.98	54	-	-	-	-	-	-	A	H	
	*	2441	101.85	-	-	102.06	27.28	4.07	31.56	225	59	P	H	
	*	2441	77.12	-	-	-	-	-	-	-	-	A	H	
			2497.76	44.41	-29.59	74	44.45	27.4	4.11	31.55	225	59	P	H
			2497.76	19.68	-34.32	54	-	-	-	-	-	-	A	H
			2378.32	44.5	-29.5	74	44.94	27.11	4.03	31.58	250	258	P	V
			2378.32	19.77	-34.23	54	-	-	-	-	-	-	A	V
	*		2441	101.24	-	-	101.45	27.28	4.07	31.56	250	258	P	V
	*		2441	76.51	-	-	-	-	-	-	-	-	A	V
			2495.1	49.28	-24.72	74	49.32	27.4	4.11	31.55	250	258	P	V
			2495.1	24.55	-29.45	54	-	-	-	-	-	-	A	V



BT CH 78 2480MHz	*	2480	100.9	-	-	101.01	27.36	4.09	31.56	236	52	P	H
	*	2480	76.17	-	-	-	-	-	-	-	-	A	H
		2483.68	47.75	-26.25	74	47.84	27.36	4.11	31.56	236	52	P	H
		2483.68	23.02	-30.98	54	-	-	-	-	-	-	A	H
													H
													H
	*	2480	99.77	-	-	99.88	27.36	4.09	31.56	222	247	P	V
	*	2480	75.04	-	-	-	-	-	-	-	-	A	V
		2483.56	47.59	-26.41	74	47.68	27.36	4.11	31.56	222	247	P	V
		2483.56	22.86	-31.14	54	-	-	-	-	-	-	A	V
													V
													V
Remark	1. No other spurious found. 2. All results are PASS against Peak and Average limit line.												



2.4GHz 2400~2483.5MHz
BT 3Mbps (Harmonic @ 3m)

BT	Note	Frequency	Level	Over Limit	Limit Line	Read Level	Antenna Factor	Path Loss	Preamp Factor	Ant Pos	Table Pos	Peak Avg.	Pol.	
		(MHz)	(dBμV/m)	(dB)	(dBμV/m)	(dBμV)	(dB/m)	(dB)	(dB)	(cm)	(deg)	(P/A)	(H/V)	
BT CH 00 2402MHz		4804	40.02	-33.98	74	58.58	31.32	6.7	56.58	100	0	P	H	
		4804	15.29	-38.71	54	-	-	-	-	-	-	A	H	
													H	
													H	
		4804	43.36	-30.64	74	61.92	31.32	6.7	56.58	100	0	P	V	
		4804	18.63	-35.37	54	-	-	-	-	-	-	-	A	V
														V
														V
BT CH 39 2441MHz		4882	39.96	-34.04	74	58.32	31.46	6.73	56.55	100	0	P	H	
		4882	15.23	-38.77	54	-	-	-	-	-	-	A	H	
		7323	42.83	-31.17	74	54.83	36.15	8.06	56.21	100	0	P	H	
		7323	18.1	-35.9	54	-	-	-	-	-	-	A	H	
		4882	41.18	-32.82	74	59.54	31.46	6.73	56.55	100	0	P	V	
		4882	16.45	-37.55	54	-	-	-	-	-	-	A	V	
		7323	42.46	-31.54	74	54.46	36.15	8.06	56.21	100	0	P	V	
		7323	17.73	-36.27	54	-	-	-	-	-	-	A	V	
BT CH 78 2480MHz		4960	39.76	-34.24	74	57.9	31.63	6.75	56.52	100	0	P	H	
		4960	15.03	-38.97	54	-	-	-	-	-	-	A	H	
		7440	44.41	-29.59	74	55.94	36.47	8.07	56.07	100	0	P	H	
		7440	19.68	-34.32	54	-	-	-	-	-	-	A	H	
		4960	41.7	-32.3	74	59.84	31.63	6.75	56.52	100	0	P	V	
		4960	16.97	-37.03	54	-	-	-	-	-	-	A	V	
		7440	43.97	-30.03	74	55.5	36.47	8.07	56.07	100	0	P	V	
		7440	19.24	-34.76	54	-	-	-	-	-	-	A	V	
Remark	1. No other spurious found. 2. All results are PASS against Peak and Average limit line.													



Note symbol

*	Fundamental Frequency which can be ignored. However, the level of any unwanted emissions shall not exceed the level of the fundamental frequency.
!	Test result is over limit line.
P/A	Peak or Average
H/V	Horizontal or Vertical



A calculation example for radiated spurious emission is shown as below:

BT	Note	Frequency	Level	Over	Limit	Read	Antenna	Path	Preamp	Ant	Table	Peak	Pol.
		(MHz)	(dBμV/m)	(dB)	Limit Line	Level	Factor	Loss	Factor	Pos	Pos	Avg.	
					(dBμV/m)	(dBμV)	(dB/m)	(dB)	(dB)	(cm)	(deg)	(P/A)	(H/V)
BT		2390	55.45	-18.55	74	54.51	32.22	4.58	35.86	103	308	P	H
CH 00		2390	43.54	-10.46	54	42.6	32.22	4.58	35.86	103	308	A	H
2402MHz													

1. Path Loss(dB) = Cable loss(dB) + Filter loss(dB) + Attenuator loss(dB)
2. Level(dBμV/m) =
Antenna Factor(dB/m) + Path Loss(dB) + Read Level(dBμV) - Preamp Factor(dB)
3. Over Limit(dB) = Level(dBμV/m) – Limit Line(dBμV/m)

For Peak Limit @ 2390MHz:

1. Level(dBμV/m)
= Antenna Factor(dB/m) + Path Loss(dB) + Read Level(dBμV) - Preamp Factor(dB)
= 32.22(dB/m) + 4.58(dB) + 54.51(dBμV) – 35.86 (dB)
= 55.45 (dBμV/m)
2. Over Limit(dB)
= Level(dBμV/m) – Limit Line(dBμV/m)
= 55.45(dBμV/m) – 74(dBμV/m)
= -18.55(dB)

For Average Limit @ 2390MHz:

1. Level(dBμV/m)
= Antenna Factor(dB/m) + Path Loss(dB) + Read Level(dBμV) - Preamp Factor(dB)
= 32.22(dB/m) + 4.58(dB) + 42.6(dBμV) – 35.86 (dB)
= 43.54 (dBμV/m)
2. Over Limit(dB)
= Level(dBμV/m) – Limit Line(dBμV/m)
= 43.54(dBμV/m) – 54(dBμV/m)
= -10.46(dB)

Both peak and average measured complies with the limit line, so test result is “PASS”.



Appendix D. Radiated Spurious Emission Plots

Test Engineer :	Watt Tseng, Karl Hou, and Nick Yu	Temperature :	21~23°C
		Relative Humidity :	59~62%

2.4GHz 2400~2483.5MHz
BT 1Mbps (Band Edge @ 3m)

BT	2.4GHz 2400~2483.5MHz Band Edge @ 3m	
	BT CH00 2402MHz	
	Horizontal	Fundamental
Peak	<p> Site : 03CH1Z-HY Condition : PEAK_BE_74 3m HORN_91200_1328 HORIZONTAL Detector : Peak Project : 832501-01 Mode : 1 </p>	<p> Site : 03CH1Z-HY Condition : PEAK_74 3m HORN_91200_1328 HORIZONTAL Detector : Peak Project : 832501-01 Mode : 1 </p>

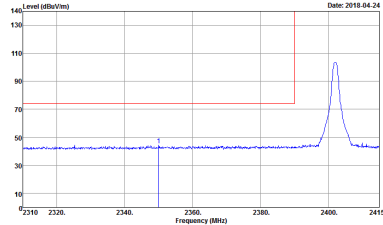
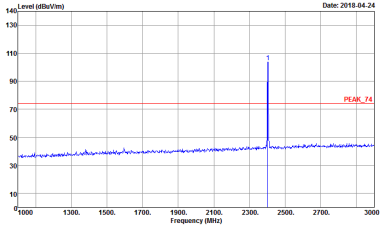

BT	2.4GHz 2400~2483.5MHz Band Edge @ 3m	
BT CH00 2402MHz		
	Vertical	Fundamental
Peak	 <p>Site : 03CH2-FY Condition : PEAK_9C_74 3m HORN_91200_1328 VERTICAL RBW:3000.000kHz VBW:3000.000kHz SWT:Auto Detector : Peak Project : 832501-01 Mode : 1</p>	 <p>Site : 03CH2-FY Condition : PEAK_74 3m HORN_91200_1328 VERTICAL RBW:3000.000kHz VBW:3000.000kHz SWT:Auto Detector : Peak Project : 832501-01 Mode : 1</p>



BT	2.4GHz 2400~2483.5MHz Band Edge @ 3m	
BT CH39 2441MHz		
Horizontal		Fundamental
<p>Peak</p>	<p>Site : 03CH2-1HY Condition : PEAK_BE_74 3m HORN_91200_1328 HORIZONTAL RBW:3000.000kHz VBW:3000.000kHz SWT:Auto Detector : Peak Project : 832501-01 Mode : 2</p>	<p>Site : 03CH2-1HY Condition : PEAK_74 3m HORN_91200_1328 HORIZONTAL RBW:3000.000kHz VBW:3000.000kHz SWT:Auto Detector : Peak Project : 832501-01 Mode : 2</p>
<p>Peak</p>	<p>Site : 03CH2-1HY Condition : PEAK_BE_74 3m HORN_91200_1328 HORIZONTAL RBW:3000.000kHz VBW:3000.000kHz SWT:Auto Detector : Peak Project : 832501-01 Mode : 2</p>	<p>Left blank</p>



BT	2.4GHz 2400~2483.5MHz Band Edge @ 3m	
BT CH39 2441MHz		
	Vertical	Fundamental
<p>Peak</p>	<p>Site : 03CH2-1HY Condition : PEAK_BE_74 3m HORN_91200_1328 VERTICAL RBW:3000.000KHz VBW:3000.000KHz SWT:Auto Detector : Peak Project : 832501-01 Mode : 2</p>	<p>Site : 03CH2-1HY Condition : PEAK_74 3m HORN_91200_1328 VERTICAL RBW:3000.000KHz VBW:3000.000KHz SWT:Auto Detector : Peak Project : 832501-01 Mode : 2</p>
<p>Peak</p>	<p>Site : 03CH2-1HY Condition : PEAK_BE_74 3m HORN_91200_1328 VERTICAL RBW:3000.000KHz VBW:3000.000KHz SWT:Auto Detector : Peak Project : 832501-01 Mode : 2</p>	<p>Left blank</p>

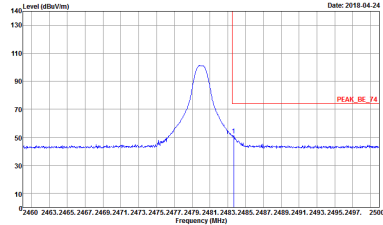
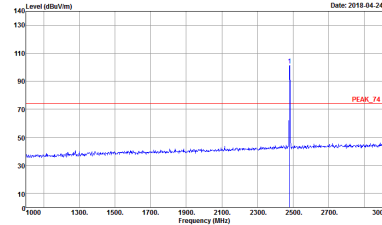

BT	2.4GHz 2400~2483.5MHz Band Edge @ 3m	
	BT CH78 2480MHz	
	Horizontal	Fundamental
Peak	 <p>Site : 03CHZ-FY Condition : PEAK_BE_F4 3m HORN_91200_1328 HORIZONTAL Detector : Peak Project : FR832501-01 Mode : 3</p>	 <p>Site : 03CHZ-FY Condition : PEAK_F4 3m HORN_91200_1328 HORIZONTAL Detector : Peak Project : FR832501-01 Mode : 3</p>

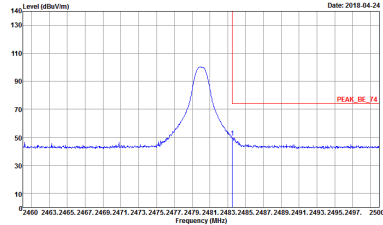
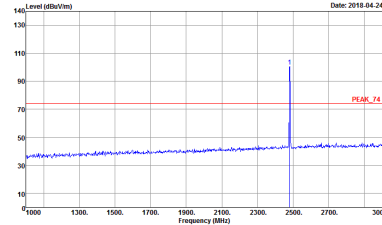

BT	2.4GHz 2400~2483.5MHz Band Edge @ 3m	
BT CH78 2480MHz		
	Vertical	Fundamental
Peak	 <p>Site : 03CH2-FY Condition : PEAK_BE_74 3m HORN_91200_1328 VERTICAL Detector : RBW:3000.000kHz VBW:3000.000kHz SWT:Auto Project : 832501-01 Mode : 3</p>	 <p>Site : 03CH2-FY Condition : PEAK_74 3m HORN_91200_1328 VERTICAL Detector : RBW:3000.000kHz VBW:3000.000kHz SWT:Auto Project : 832501-01 Mode : 3</p>



2.4GHz 2400~2483.5MHz
BT 1Mbps (Harmonic @ 3m)

BT	2.4GHz 2400~2483.5MHz Harmonic @ 3m	
	BT CH00 2402MHz	
	Horizontal	Vertical
Peak Avg.	<p>Site : 03CH12-44Y Condition : PEAK_74 3m HORN_91200_1328 HORIZONTAL Detector : Peak Project : 832501-01 Mode : 1</p>	<p>Site : 03CH12-44Y Condition : PEAK_74 3m HORN_91200_1328 VERTICAL Detector : Peak Project : 832501-01 Mode : 1</p>

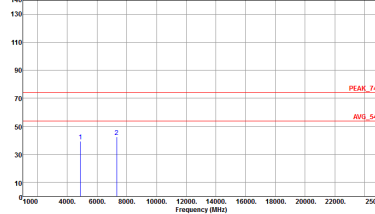
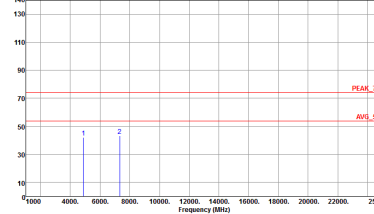

BT	2.4GHz 2400~2483.5MHz Harmonic @ 3m	
	BT CH39 2441MHz	
	Horizontal	Vertical
<p>Peak Avg.</p>	<p data-bbox="430 504 805 526">Date: 2018.04.24</p>  <p data-bbox="430 728 805 795">Site : 03CH12-11Y Condition : PEAK_74 3m HORN_9120D_1328 HORIZONTAL Detector : Peak Project : 832501-01 Mode : 2</p>	<p data-bbox="901 504 1276 526">Date: 2018.04.24</p>  <p data-bbox="901 728 1276 795">Site : 03CH12-11Y Condition : PEAK_74 3m HORN_9120D_1328 VERTICAL Detector : Peak Project : 832501-01 Mode : 2</p>

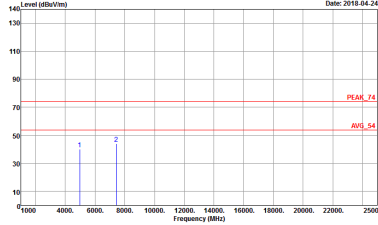
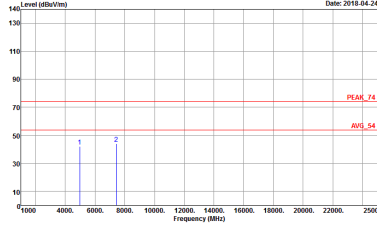

BT	2.4GHz 2400~2483.5MHz Harmonic @ 3m	
	BT CH78 2480MHz	
	Horizontal	Vertical
<p>Peak Avg.</p>	<p data-bbox="432 506 810 730"></p> <p data-bbox="432 734 691 792">Site : 03CH12-11Y Condition : PEAK_74 3m HORN_9120D_1328 HORIZONTAL Detector : Peak Project : 832501-01 Mode : 3</p>	<p data-bbox="906 506 1284 730"></p> <p data-bbox="906 734 1149 792">Site : 03CH12-11Y Condition : PEAK_74 3m HORN_9120D_1328 VERTICAL Detector : Peak Project : 832501-01 Mode : 3</p>

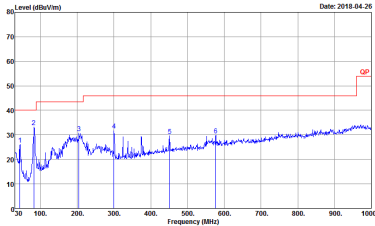
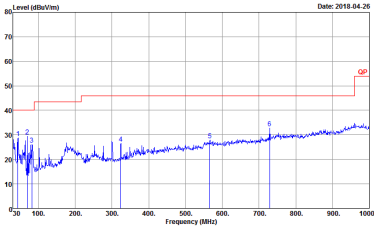

Emission below 1GHz
2.4GHz BT 1Mbps (LF)

BT	2.4GHz 2400~2483.5MHz	
	BT LF	
	Horizontal	Vertical
QP / Peak	 <p data-bbox="430 846 670 907">Site : 03CH2-HY Condition : QP 3m SILEOS_6111D_35414 HORIZONTAL Detector : Peak Project : 832501-01 Mode : 10</p>	 <p data-bbox="906 846 1145 907">Site : 03CH2-HY Condition : QP 3m SILEOS_6111D_35414 VERTICAL Detector : Peak Project : 832501-01 Mode : 10</p>

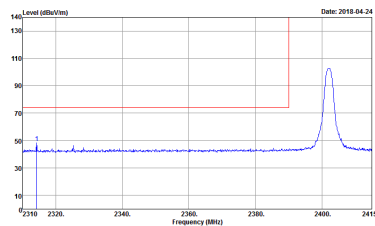
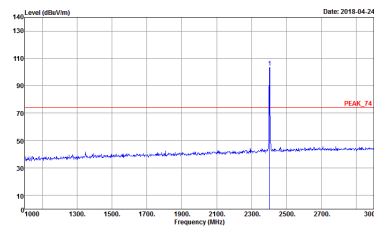

2.4GHz 2400~2483.5MHz
BT 2Mbps (Band Edge @ 3m)

BT	2.4GHz 2400~2483.5MHz Band Edge @ 3m	
	BT CH00 2402MHz	
	Horizontal	Fundamental
Peak	 <p>Site : 03CH2-HY Condition : PEAK_96_74 3m HORN_91200_1328 HORIZONTAL Detector : Peak Project : 832501-01 Mode : 4</p>	 <p>Site : 03CH2-HY Condition : PEAK_74 3m HORN_91200_1328 HORIZONTAL Detector : Peak Project : 832501-01 Mode : 4</p>

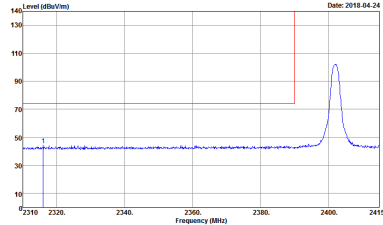
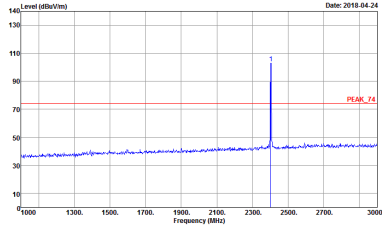

BT	2.4GHz 2400~2483.5MHz Band Edge @ 3m	
BT CH00 2402MHz		
	Vertical	Fundamental
Peak	 <p>Site : 03CH2-FY Condition : PEAK_9C_74 3m HORN_91200_1328 VERTICAL Detector : RBW:3000.000KHz VBW:3000.000KHz SWT:Auto Project : Peak Project : 832501-01 Mode : 4</p>	 <p>Site : 03CH2-FY Condition : PEAK_74 3m HORN_91200_1328 VERTICAL Detector : RBW:3000.000KHz VBW:3000.000KHz SWT:Auto Project : Peak Project : 832501-01 Mode : 4</p>

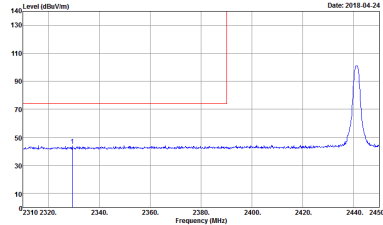
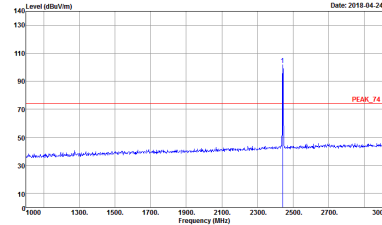
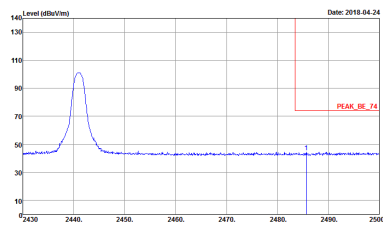

BT	2.4GHz 2400~2483.5MHz Band Edge @ 3m	
BT CH39 2441MHz		
Horizontal		Fundamental
Peak	 <p>Site : 03CH12-1HY Condition : PEAK_BE_74 3m HORN_91200_1328 HORIZONTAL : RBW:3000.000kHz VBW:3000.000kHz SWT:Auto Detector : Peak Project : 832501-01 Mode : 5</p>	 <p>Site : 03CH12-1HY Condition : PEAK_74 3m HORN_91200_1328 HORIZONTAL : RBW:3000.000kHz VBW:3000.000kHz SWT:Auto Detector : Peak Project : 832501-01 Mode : 5</p>
Peak	 <p>Site : 03CH12-1HY Condition : PEAK_BE_74 3m HORN_91200_1328 HORIZONTAL : RBW:3000.000kHz VBW:3000.000kHz SWT:Auto Detector : Peak Project : 832501-01 Mode : 5</p>	Left blank

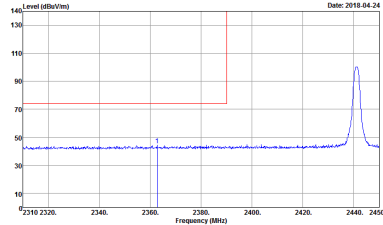
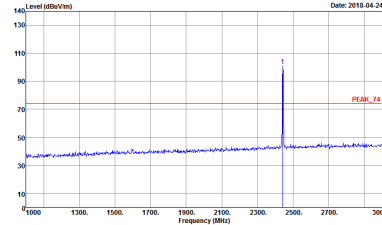
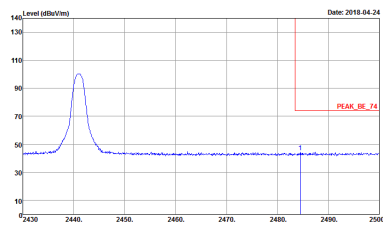

BT	2.4GHz 2400~2483.5MHz Band Edge @ 3m	
BT CH39 2441MHz		
Vertical		Fundamental
Peak	 <p>Site : 03CH12-1HY Condition : PEAK_BE_74 3m HORN_91200_1328 VERTICAL RBW:3000.000kHz VBW:3000.000kHz SWT:Auto Detector : Peak Project : 832501-01 Mode : 5</p>	 <p>Site : 03CH12-1HY Condition : PEAK_74 3m HORN_91200_1328 VERTICAL RBW:3000.000kHz VBW:3000.000kHz SWT:Auto Detector : Peak Project : 832501-01 Mode : 5</p>
Peak	 <p>Site : 03CH12-1HY Condition : PEAK_BE_74 3m HORN_91200_1328 VERTICAL RBW:3000.000kHz VBW:3000.000kHz SWT:Auto Detector : Peak Project : 832501-01 Mode : 5</p>	Left blank

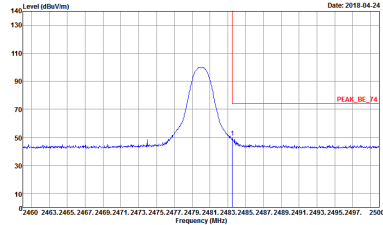
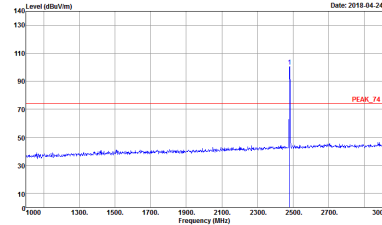

BT	2.4GHz 2400~2483.5MHz Band Edge @ 3m	
BT CH78 2480MHz		
	Horizontal	Fundamental
<p>Peak</p>	 <p>Site : 03CH2-FY Condition : PEAK_BE_74 3m HORN_91200_1328 HORIZONTAL RBW:3000.000KHz VBW:3000.000KHz SWT:Auto Detector : Peak Project : 832501-01 Mode : 6</p>	 <p>Site : 03CH2-FY Condition : PEAK_74 3m HORN_91200_1328 HORIZONTAL RBW:3000.000KHz VBW:3000.000KHz SWT:Auto Detector : Peak Project : 832501-01 Mode : 6</p>

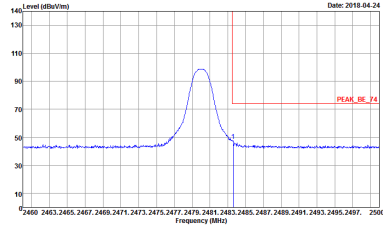
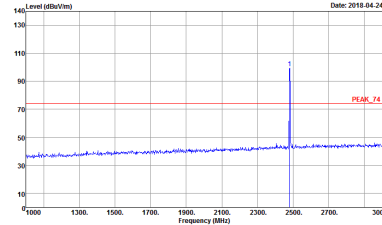

BT	2.4GHz 2400~2483.5MHz Band Edge @ 3m	
BT CH78 2480MHz		
Vertical		Fundamental
Peak	 <p>Site : 03CH2-FY Condition : PEAK_BE_74 3m HORN_91200_1328 VERTICAL RBW:3000.000KHz VBW:3000.000KHz SWT:Auto Detector : Peak Project : 832501-01 Mode : 6</p>	 <p>Site : 03CH2-FY Condition : PEAK_74 3m HORN_91200_1328 VERTICAL RBW:3000.000KHz VBW:3000.000KHz SWT:Auto Detector : Peak Project : 832501-01 Mode : 6</p>

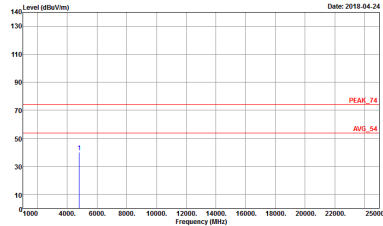
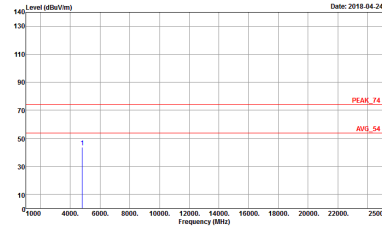

2.4GHz 2400~2483.5MHz
BT 2Mbps (Harmonic @ 3m)

BT	2.4GHz 2400~2483.5MHz Harmonic @ 3m	
	BT CH00 2402MHz	
	Horizontal	Vertical
<p>Peak Avg.</p>	 <p>Site : 03CH12-44Y Condition : PEAK_74 3m HORN_91200_1328 HORIZONTAL Detector : Peak Project : 832501-01 Mode : -4</p>	 <p>Site : 03CH12-44Y Condition : PEAK_74 3m HORN_91200_1328 VERTICAL Detector : Peak Project : 832501-01 Mode : -4</p>

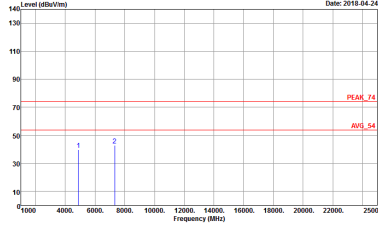
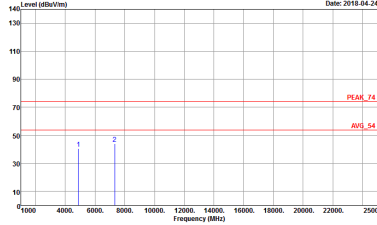

BT	2.4GHz 2400~2483.5MHz Harmonic @ 3m	
	BT CH39 2441MHz	
	Horizontal	Vertical
<p>Peak Avg.</p>	<p data-bbox="432 506 810 730"></p> <p data-bbox="432 734 691 792">Site : 03CH12-11Y Condition : PEAK_74 3m HORN_9120D_1328 HORIZONTAL Detector : Peak Project : 832501-01 Mode : F</p>	<p data-bbox="906 506 1284 730"></p> <p data-bbox="906 734 1149 792">Site : 03CH12-11Y Condition : PEAK_74 3m HORN_9120D_1328 VERTICAL Detector : Peak Project : 832501-01 Mode : F</p>

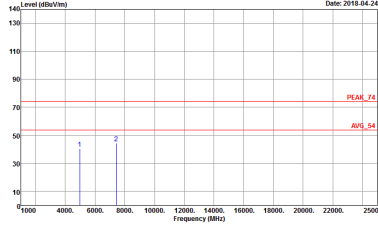
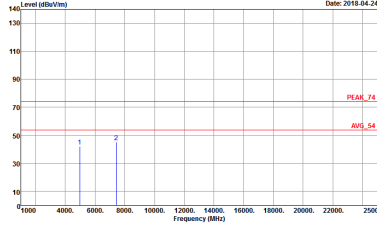

BT	2.4GHz 2400~2483.5MHz Harmonic @ 3m	
	BT CH78 2480MHz	
	Horizontal	Vertical
<p>Peak Avg.</p>	<p data-bbox="432 506 810 730"></p> <p data-bbox="432 734 691 792">Site : 03CH12-11Y Condition : PEAK_74 3m HORN_9120D_1328 HORIZONTAL Detector : Peak Project : 832501-01 Mode : -6</p>	<p data-bbox="906 506 1284 730"></p> <p data-bbox="906 734 1149 792">Site : 03CH12-11Y Condition : PEAK_74 3m HORN_9120D_1328 VERTICAL Detector : Peak Project : 832501-01 Mode : -6</p>



2.4GHz 2400~2483.5MHz
BT 3Mbps (Band Edge @ 3m)

Table with 2 columns: BT (2.4GHz 2400~2483.5MHz Band Edge @ 3m) and ANT (BT CH00 2402MHz). Row 1: 1, Horizontal, Fundamental. Each plot shows Level (dBm/Vm) vs Frequency (MHz) with a peak at 2402MHz. Includes metadata like Site, Condition, Detector, Project, Mode.



BT	2.4GHz 2400~2483.5MHz Band Edge @ 3m	
ANT	BT CH00 2402MHz	
1	Vertical	Fundamental
Peak	<p>Site : 03CH2-FY Condition : PEAK_9C_74 3m HORN_91200_1328 VERTICAL RBW:3000.000kHz VBW:3000.000kHz SWT:Auto Detector : Peak Project : 832501-01 Mode : 7</p>	<p>Site : 03CH2-FY Condition : PEAK_74 3m HORN_91200_1328 VERTICAL RBW:3000.000kHz VBW:3000.000kHz SWT:Auto Detector : Peak Project : 832501-01 Mode : 7</p>

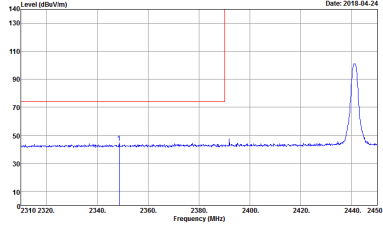
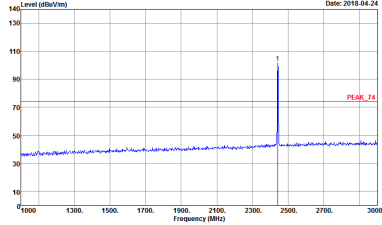
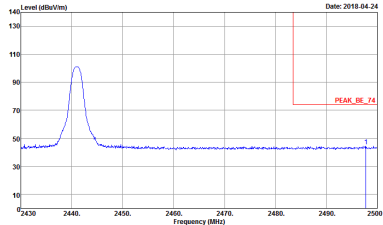

BT	2.4GHz 2400~2483.5MHz Band Edge @ 3m	
ANT	BT CH39 2441MHz	
1	Horizontal	Fundamental
Peak	 <p>Site : 03CH2-1Y Condition : PEAK_BE_74 3m HORN_91200_1328 HORIZONTAL RBW:3000.000KHz VBW:3000.000KHz SWT:Auto Detector : Peak Project : 832501-01 Mode : 8</p>	 <p>Site : 03CH2-1Y Condition : PEAK_74 3m HORN_91200_1328 HORIZONTAL RBW:3000.000KHz VBW:3000.000KHz SWT:Auto Detector : Peak Project : 832501-01 Mode : 8</p>
Peak	 <p>Site : 03CH2-1Y Condition : PEAK_BE_74 3m HORN_91200_1328 HORIZONTAL RBW:3000.000KHz VBW:3000.000KHz SWT:Auto Detector : Peak Project : 832501-01 Mode : 8</p>	Left blank



BT	2.4GHz 2400~2483.5MHz Band Edge @ 3m	
ANT	BT CH39 2441MHz	
1	Vertical	Fundamental
<p>Peak</p>	<p>Site : 03CH12-1HY Condition : PEAK_BE_74 3m HORN_91200_1328 VERTICAL RBW:3000.000KHz VBW:3000.000KHz SWT:Auto Detector : Peak Project : 832501-01 Mode : 8</p>	<p>Site : 03CH12-1HY Condition : PEAK_74 3m HORN_91200_1328 VERTICAL RBW:3000.000KHz VBW:3000.000KHz SWT:Auto Detector : Peak Project : 832501-01 Mode : 8</p>
<p>Peak</p>	<p>Site : 03CH12-1HY Condition : PEAK_BE_74 3m HORN_91200_1328 VERTICAL RBW:3000.000KHz VBW:3000.000KHz SWT:Auto Detector : Peak Project : 832501-01 Mode : 8</p>	<p>Left blank</p>



BT	2.4GHz 2400~2483.5MHz Band Edge @ 3m	
ANT	BT CH78 2480MHz	
1	Horizontal	Fundamental
Peak	<p>Site : 03CH2-FY Condition : PEAK_BE_74 3m HORN_91200_1328 HORIZONTAL Detector : RBW:3000.000kHz VBW:3000.000kHz SWT:Auto Project : Peak Project : 832501-01 Mode : 9</p>	<p>Site : 03CH2-FY Condition : PEAK_74 3m HORN_91200_1328 HORIZONTAL Detector : RBW:3000.000kHz VBW:3000.000kHz SWT:Auto Project : Peak Project : 832501-01 Mode : 9</p>

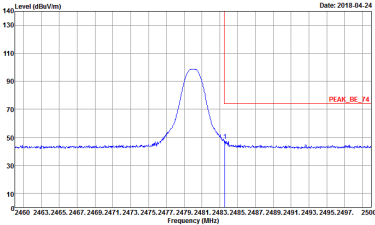
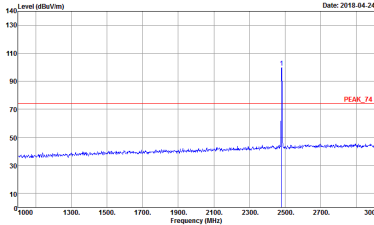

BT	2.4GHz 2400~2483.5MHz Band Edge @ 3m	
ANT	BT CH78 2480MHz	
1	Vertical	Fundamental
Peak	 <p>Site : 03CH2-FY Condition : PEAK_BE_74 3m HORN_91200_1328 VERTICAL RBW:3000.000KHz VBW:3000.000KHz SWT:Auto Detector : Peak Project : 832501-01 Mode : 9</p>	 <p>Site : 03CH2-FY Condition : PEAK_74 3m HORN_91200_1328 VERTICAL RBW:3000.000KHz VBW:3000.000KHz SWT:Auto Detector : Peak Project : 832501-01 Mode : 9</p>

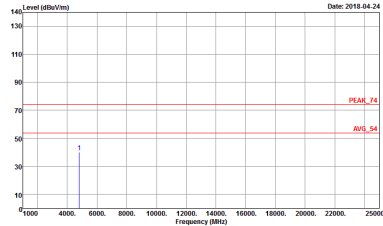
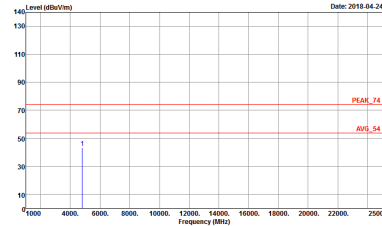

2.4GHz 2400~2483.5MHz
BT 3Mbps (Harmonic @ 3m)

BT	2.4GHz 2400~2483.5MHz Harmonic @ 3m	
ANT	BT CH00 2402MHz	
1	Horizontal	Vertical
<p>Peak Avg.</p>	 <p>Site : 03CH12-44Y Condition : PEAK_74 3m HORN_91200_1328 HORIZONTAL Detector : Peak Project : 832501-01 Mode : 7</p>	 <p>Site : 03CH12-44Y Condition : PEAK_74 3m HORN_91200_1328 VERTICAL Detector : Peak Project : 832501-01 Mode : 7</p>

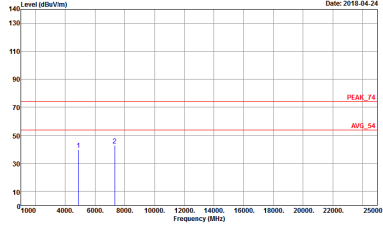
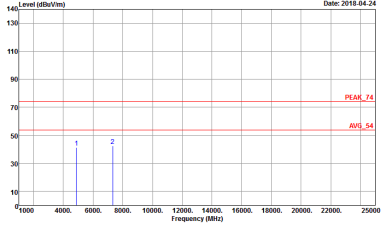

BT	2.4GHz 2400~2483.5MHz Harmonic @ 3m	
ANT	BT CH39 2441MHz	
1	Horizontal	Vertical
<p>Peak</p> <p>Avg.</p>	 <p>Site : 03CH12-11Y Condition : PEAK_74 3m HORN_9120D_1328 HORIZONTAL Detector : Peak Project : 832501-01 Mode : S</p>	 <p>Site : 03CH12-11Y Condition : PEAK_74 3m HORN_9120D_1328 VERTICAL Detector : Peak Project : 832501-01 Mode : S</p>



BT	2.4GHz 2400~2483.5MHz Harmonic @ 3m	
ANT	BT CH78 2480MHz	
1	Horizontal	Vertical
<p>Peak Avg.</p>	<p>Site : 03CH12-11Y Condition : PEAK_74 3m HORN_9120D_1328 HORIZONTAL Detector : Peak Project : 832501-01 Mode : -9</p>	<p>Site : 03CH12-11Y Condition : PEAK_74 3m HORN_9120D_1328 VERTICAL Detector : Peak Project : 832501-01 Mode : -9</p>



Appendix E. Duty Cycle Plots

<1Mbps>

DH5 on time (One Pulse) Plot on Channel 39

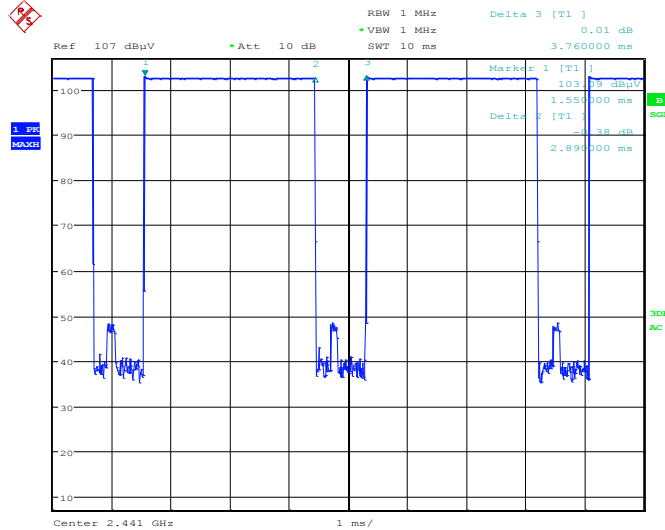

Date: 24.APR.2018 07:25:53

on time (Count Pulses) Plot on Channel 39

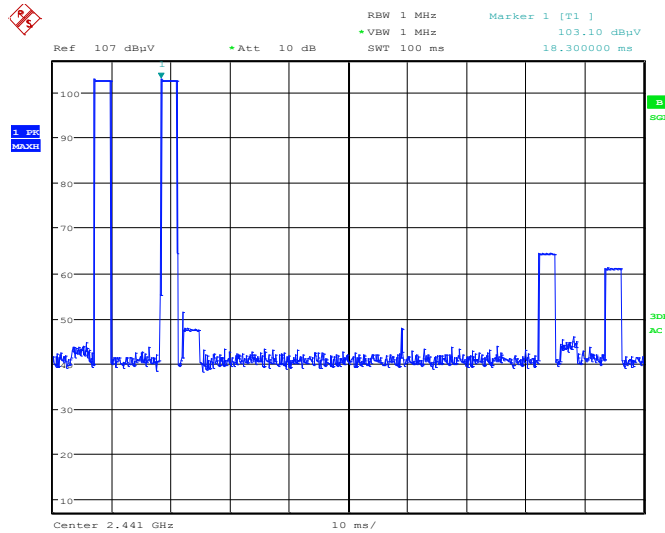

Date: 24.APR.2018 07:26:27

Note:

1. Worst case Duty cycle = on time/100 milliseconds = 2 * 2.89 / 100 = 5.78 %
2. Worst case Duty cycle correction factor = 20*log(Duty cycle) = -24.76 dB
3. DH5 has the highest duty cycle worst case and is reported.



<3Mbps>

3DH5 on time (One Pulse) Plot on Channel 39

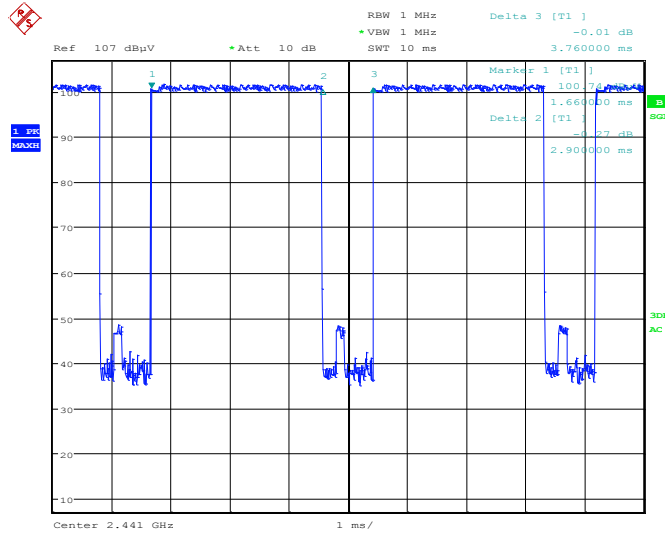

Date: 24.APR.2018 07:22:04

on time (Count Pulses) Plot on Channel 39

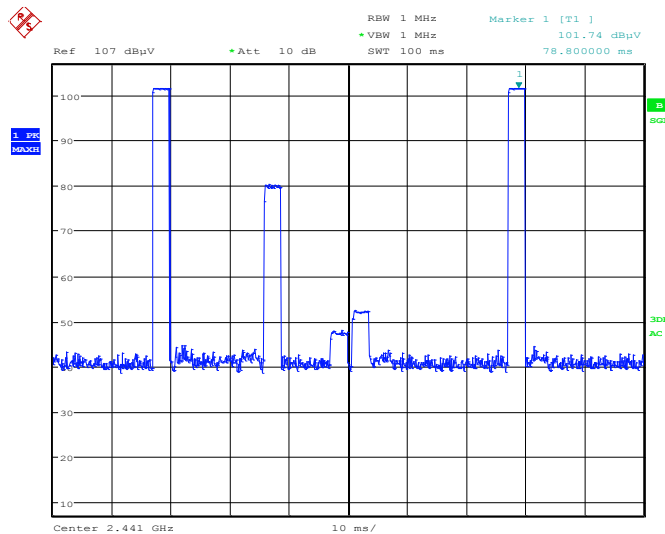

Date: 24.APR.2018 07:22:45

Note:

1. Worst case Duty cycle = on time/100 milliseconds = $2 * 2.90 / 100 = 5.80\%$
2. Worst case Duty cycle correction factor = $20 * \log(\text{Duty cycle}) = -24.73 \text{ dB}$
3. 3DH5 has the highest duty cycle worst case and is reported.



Duty Cycle Correction Factor Consideration for AFH mode:

Bluetooth normal hopping rate is 1600Hz and reduced to 800Hz in AFH mode; due to the reduced number of hopping frequencies, with the same packet configuration the dwell time in each channel frequency within 100msec period is longer in AFH mode than normal mode.

In AFH mode, the minimum hopping frequencies are 20, to get the longest dwell time DH5 packet is observed; the period to have DH5 packet completing one hopping sequence is

$$2.89 \text{ ms} \times 20 \text{ channels} = 57.8 \text{ ms}$$

There cannot be 2 complete hopping sequences within 100ms period, considering the random hopping behavior, maximum 2 hops can be possibly observed within the period. $[100\text{ms} / 57.6\text{ms}] = 2$ hops

Thus, the maximum possible ON time:

$$2.89 \text{ ms} \times 2 = 5.78 \text{ ms}$$

Worst case Duty Cycle Correction factor, which is derived from the maximum possible ON time,

$$20 \times \log(5.78 \text{ ms}/100\text{ms}) = -24.76 \text{ dB}$$

—————THE END—————