

ELECTROMAGNETIC EMISSIONS COMPLIANCE REPORT
INTENTIONAL RADIATOR CERTIFICATION TO
FCC PART 22 SUBPART H, PART 24 SUBPART E and PART 27
SUBPART C

OF

Applicant: Sony Mobile Communications INC
EUT Description: Mobile Phone
FCC ID: PY7-04605A
Report Number: ZR/2018/A001101
FCC Rule Part: 2 , 22H & 24E & 27C
Issue Date: 2018/11/30
Date of Test: 2018/10/19 to 2018/11/26
Date of EUT Received: 2018/10/18

We hereby certify that:

The above equipment was tested by SGS Shenzhen Ltd. Electronics & Communication Laboratory The test data, data evaluation, test procedures, and equipment configurations shown in this report were made in accordance with the procedures given in ANSI C63.26-2015 and the energy emitted by the sample EUT tested as described in this report is in compliance with conducted and radiated emission limits.

The test results of this report relate only to the tested sample identified in this report.

Authorized for issue by:		
Tested By	<i>Mike Hu</i>	2018/11/30
	(Mike Hu) /Project Engineer	Date
Checked By	<i>David Chen</i>	2018/11/30
	(David Chen) /Reviewer	Date
Approved By	<i>Derek yang</i>	2018/11/30
	(Derek Yang) Wireless Laboratory Manager	Date

Unless otherwise stated the results shown in this test report refer only to the sample(s) tested and such sample(s) are retained for 90 days only.

除非另有說明，此報告結果僅對測試之樣品負責，同時此樣品僅保留90天。本報告未經本公司書面許可，不可部份複製。

This document is issued by the Company subject to its General Conditions of Service printed overleaf, available on request or accessible at www.sgs.com/terms_and_conditions.htm and, for electronic format documents, subject to Terms and Conditions for Electronic Documents at www.sgs.com/terms_e-document.htm. Attention is drawn to the limitation of liability, indemnification and jurisdiction issues defined therein. Any holder of this document is advised that information contained hereon reflects the Company's findings at the time of its intervention only and within the limits of Client's instructions, if any. The Company's sole responsibility is to its Client and this document does not exonerate parties to a transaction from exercising all their rights and obligations under the transaction documents. This document cannot be reproduced except in full, without prior written approval of the Company. Any unauthorized alteration, forgery or falsification of the content or appearance of this document is unlawful and offenders may be prosecuted to the fullest extent of the law.

Revision History

Report Number	Revision	Description	Issue Date
--	Rev.00	Initial creation of document	2018/11/30

Unless otherwise stated the results shown in this test report refer only to the sample(s) tested and such sample(s) are retained for 90 days only.
除非另有說明，此報告結果僅對測試之樣品負責，同時此樣品僅保留90天。本報告未經本公司書面許可，不可部份複製。

This document is issued by the Company subject to its General Conditions of Service printed overleaf, available on request or accessible at www.sgs.com/terms_and_conditions.htm and, for electronic format documents, subject to Terms and Conditions for Electronic Documents at www.sgs.com/terms_e-document.htm. Attention is drawn to the limitation of liability, indemnification and jurisdiction issues defined therein. Any holder of this document is advised that information contained hereon reflects the Company's findings at the time of its intervention only and within the limits of Client's instructions, if any. The Company's sole responsibility is to its Client and this document does not exonerate parties to a transaction from exercising all their rights and obligations under the transaction documents. This document cannot be reproduced except in full, without prior written approval of the Company. Any unauthorized alteration, forgery or falsification of the content or appearance of this document is unlawful and offenders may be prosecuted to the fullest extent of the law.

SGS Shenzhen Ltd.

No. 1 Workshop, M-10, Middle section, Science & Technology Park, Nanshan District, Shenzhen, Guangdong, China 518057

t +86 (0) 755 2601 2053

f +86 (0) 755 2671 0594

<https://www.sgsgroup.com.cn/>

Member of SGS Group

Contents

1. GENERAL PRODUCT INFORMATION.....	4
2. SYSTEM TEST CONFIGURATION	9
3. SUMMARY OF TEST RESULTS	11
4. DESCRIPTION OF TEST MODES	12
5. MEASUREMENT UNCERTAINTY	18
6. MAXMUM OUTPUT POWER	19
7. OCCUPIED BANDWIDTH MEASUREMENT	37
8. OUT OF BAND EMISSION AT ANTENNA TERMINALS.....	90
9. FIELD STRENGTH OF SPURIOUS RADIATION MEASUREMENT.....	148
10. FREQUENCY STABILITY MEASUREMENT	160
11. PEAK TO AVERAGE RATIO	176
12. Photographs - EUT Constructional Details.....	197
13. Base station configures US MCC, and sets B38 or B40	198
14. UE cannot register B38.....	199
15. Base station configures US MCC, and sets other bands, UE can	200
16. Base station configures non-US MCC.....	201
17. UE registration on, and call box show UE capability does have B38/B40	202

Unless otherwise stated the results shown in this test report refer only to the sample(s) tested and such sample(s) are retained for 90 days only.
除非另有說明，此報告結果僅對測試之樣品負責，同時此樣品僅保留90天。本報告未經本公司書面許可，不可部份複製。

This document is issued by the Company subject to its General Conditions of Service printed overleaf, available on request or accessible at www.sgs.com/terms_and_conditions.htm and, for electronic format documents, subject to Terms and Conditions for Electronic Documents at www.sgs.com/terms_e-document.htm. Attention is drawn to the limitation of liability, indemnification and jurisdiction issues defined therein. Any holder of this document is advised that information contained hereon reflects the Company's findings at the time of its intervention only and within the limits of Client's instructions, if any. The Company's sole responsibility is to its Client and this document does not exonerate parties to a transaction from exercising all their rights and obligations under the transaction documents. This document cannot be reproduced except in full, without prior written approval of the Company. Any unauthorized alteration, forgery or falsification of the content or appearance of this document is unlawful and offenders may be prosecuted to the fullest extent of the law.

1. GENERAL PRODUCT INFORMATION

1.1. Product Description

General:

EUT Description:	Mobile Phone	
Power Supply:	3.45V DC to 4.38V DC	
Sample Type:	<input checked="" type="checkbox"/> Portable Device, <input type="checkbox"/> Module	
Antenna Type:	<input type="checkbox"/> External, <input checked="" type="checkbox"/> Integrated	
Antenna Gain	GSM850: -4.55dBi; GSM1900: 0.22dBi WCDMA BAND II: 0.22dBi WCDMA BAND V: -4.55dBi LTE BAND 2: 0.22dBi; LTE BAND 5: -4.55dBi; LTE BAND 7: 0.53dBi LTE BAND 41: 0.85dBi	
Target TX Output Power	GSM850:33.7 dBm GSM1900: 28.7dBm UMTS BAND II: 21dBm UMTS BAND V: 24dBm LTE BAND 2: 21.7dBm LTE BAND 5: 24.7dBm LTE BAND 7: 23.7dBm LTE BAND 41: 24.7dBm	
Supported Frequency Range	GSM850	Transmission (TX):824 to 849 MHz Receiving (RX):869 to 894 MHz
	GSM1900	Transmission (TX):1850 to 1910 MHz Receiving (RX): 1930 to 1990 MHz
	UMTS BAND II	Transmission (TX):1850 to 1910 MHz Receiving (RX):1930 to 1990 MHz
	UMTS BAND V	Transmission (TX):824 to 849 MHz Receiving (RX):869 to 894 MHz
	LTE BAND 2	Transmission (TX):1850 to 1910 MHz Receiving (RX):1930 to 1990 MHz
	LTE BAND 4	Transmission (TX): 824 to 849 MHz Receiving (RX): 869 to 894 MHz
	LTE BAND 7	Transmission (TX): 2500 to 2570 MHz Receiving (RX): 2620 to 2690 MHz
	LTE BAND 41	Transmission (TX): 2535 to 2655 MHz Receiving (RX): 2535 to 2655 MHz
Designation of Emissions (Remark: the necessary bandwidth of which is the worst value from the measured occupied bandwidths for each type of channel bandwidth configuration.)	GSM850	247KGXW; 249KG7W
	GSM1900	247KGXW; 255KG7W
	UMTS BAND II	4M17F9W; 4M17W7D
	UMTS BAND V	4M17F9W; 4M20W7D
	LTE BAND 2	1M09G7D;1M09W7D 2M69G7D;2M68W7D 4M47G7D;4M49W7D

Unless otherwise stated the results shown in this test report refer only to the sample(s) tested and such sample(s) are retained for 90 days only.
除非另有說明，此報告結果僅對測試之樣品負責，同時此樣品僅保留90天。本報告未經本公司書面許可，不可部份複製。

This document is issued by the Company subject to its General Conditions of Service printed overleaf, available on request or accessible at www.sgs.com/terms_and_conditions.htm and, for electronic format documents, subject to Terms and Conditions for Electronic Documents at www.sgs.com/terms_e-document.htm. Attention is drawn to the limitation of liability, indemnification and jurisdiction issues defined therein. Any holder of this document is advised that information contained hereon reflects the Company's findings at the time of its intervention only and within the limits of Client's instructions, if any. The Company's sole responsibility is to its Client and this document does not exonerate parties to a transaction from exercising all their rights and obligations under the transaction documents. This document cannot be reproduced except in full, without prior written approval of the Company. Any unauthorized alteration, forgery or falsification of the content or appearance of this document is unlawful and offenders may be prosecuted to the fullest extent of the law.

		8M93G7D;8M95W7D 13M5G7D;13M5W7D 17M9G7D;17M9W7D
	LTE BAND 5	1M09G7D;1M09W7D 2M69G7D;2M69W7D 4M48G7D;4M49W7D 8M95G7D;8M93W7D
	LTE BAND 7	4M48G7D;4M49W7D 8M93G7D;8M93W7D 13M5G7D;13M5W7D 17M9G7D;17M9W7D
	LTE BAND 41	4M47G7D;4M49W7D 8M91G7D;8M93W7D 13M5G7D;13M5W7D 17M9G7D;17M9W7D

Unless otherwise stated the results shown in this test report refer only to the sample(s) tested and such sample(s) are retained for 90 days only.
除非另有說明，此報告結果僅對測試之樣品負責，同時此樣品僅保留90天。本報告未經本公司書面許可，不可部份複製。

This document is issued by the Company subject to its General Conditions of Service printed overleaf, available on request or accessible at www.sgs.com/terms_and_conditions.htm and, for electronic format documents, subject to Terms and Conditions for Electronic Documents at www.sgs.com/terms_e-document.htm. Attention is drawn to the limitation of liability, indemnification and jurisdiction issues defined therein. Any holder of this document is advised that information contained hereon reflects the Company's findings at the time of its intervention only and within the limits of Client's instructions, if any. The Company's sole responsibility is to its Client and this document does not exonerate parties to a transaction from exercising all their rights and obligations under the transaction documents. This document cannot be reproduced except in full, without prior written approval of the Company. Any unauthorized alteration, forgery or falsification of the content or appearance of this document is unlawful and offenders may be prosecuted to the fullest extent of the law.

1.2. GSM/WCDMA/LTE: Cellular Phone Standards Frequency Range

Test Mode	TX / RX	RF Channel		
		Low (L)	Middle (M)	High (H)
GSM850	TX	Channel 128	Channel 190	Channel 251
		824.2MHz	836.6 MHz	848.8 MHz
	RX	Channel 128	Channel 190	Channel 251
		869.2 MHz	881.6 MHz	893.8 MHz
GSM1900	TX	Channel 512	Channel 661	Channel 810
		1850.2MHz	1880.0 MHz	1909.8 MHz
	RX	Channel 512	Channel 661	Channel 810
		1930.2 MHz	1960.0 MHz	1989.8 MHz

Test Mode	TX / RX	RF Channel		
		Low (L)	Middle (M)	High (H)
WCDMA BAND II	TX	Channel 9262	Channel 9400	Channel 9538
		1852.4 MHz	1880.0 MHz	1907.6 MHz
	RX	Channel 9662	Channel 9800	Channel 9938
		1932.4 MHz	1960.0 MHz	1987.6 MHz
WCDMA BAND V	TX	Channel 4132	Channel 4182	Channel 4233
		826.4MHz	836.4 MHz	846.6 MHz
	RX	Channel 4357	Channel 4407	Channel 4458
		871.4 MHz	881.4 MHz	891.6 MHz

Test Mode	Bandwidth	TX / RX	RF Channel		
			Low (L)	Middle (M)	High (H)
LTE BAND 2	1.4MHz	TX	Channel 18607	Channel 18900	Channel 19193
			1850.7 MHz	1880 MHz	1909.3 MHz
		RX	Channel 607	Channel 900	Channel 1193
			1930.7 MHz	1960 MHz	1989.3 MHz
	3MHz	TX	Channel 18615	Channel 18900	Channel 19185
			1851.5 MHz	1880 MHz	1908.5 MHz
		RX	Channel 615	Channel 900	Channel 1185
			1931.5 MHz	1960 MHz	1988.5 MHz
	5MHz	TX	Channel 18625	Channel 18900	Channel 19175
			1852.5 MHz	1880 MHz	1907.5 MHz
		RX	Channel 625	Channel 900	Channel 1175
			1932.5 MHz	1960 MHz	1987.5 MHz
	10MHz	TX	Channel 18650	Channel 18900	Channel 19150
			1855 MHz	1880 MHz	1905 MHz
		RX	Channel 650	Channel 900	Channel 1150
			1935 MHz	1960 MHz	1985 MHz
	15MHz	TX	Channel 18675	Channel 18900	Channel 19125
			1857.5 MHz	1880 MHz	1902.5 MHz
		RX	Channel 675	Channel 900	Channel 1125
			1937.5 MHz	1960 MHz	1982.5 MHz
	20MHz	TX	Channel 18700	Channel 18900	Channel 19100
			1860 MHz	1880 MHz	1900 MHz
		RX	Channel 700	Channel 900	Channel 1100
			1940 MHz	1960 MHz	1980 MHz

Unless otherwise stated the results shown in this test report refer only to the sample(s) tested and such sample(s) are retained for 90 days only.
 除非另有說明，此報告結果僅對測試之樣品負責，同時此樣品僅保留90天。本報告未經本公司書面許可，不可部份複製。

This document is issued by the Company subject to its General Conditions of Service printed overleaf, available on request or accessible at www.sgs.com/terms_and_conditions.htm and, for electronic format documents, subject to Terms and Conditions for Electronic Documents at www.sgs.com/terms_e-document.htm. Attention is drawn to the limitation of liability, indemnification and jurisdiction issues defined therein. Any holder of this document is advised that information contained hereon reflects the Company's findings at the time of its intervention only and within the limits of Client's instructions, if any. The Company's sole responsibility is to its Client and this document does not exonerate parties to a transaction from exercising all their rights and obligations under the transaction documents. This document cannot be reproduced except in full, without prior written approval of the Company. Any unauthorized alteration, forgery or falsification of the content or appearance of this document is unlawful and offenders may be prosecuted to the fullest extent of the law.

Test Mode	Bandwidth	TX / RX	RF Channel		
			Low (L)	Middle (M)	High (H)
LTE BAND 5	1.4MHz	TX	Channel 20407	Channel 20525	Channel 20643
			824.7 MHz	836.5 MHz	848.3 MHz
		RX	Channel 2407	Channel 2525	Channel 2643
			869.7 MHz	881.5 MHz	893.3 MHz
	3MHz	TX	Channel 20415	Channel 20525	Channel 20635
			825.5 MHz	836.5 MHz	847.5 MHz
		RX	Channel 2415	Channel 2525	Channel 2635
			870.5 MHz	881.5 MHz	892.5 MHz
	5MHz	TX	Channel 20425	Channel 20525	Channel 20625
			826.5 MHz	836.5 MHz	846.5 MHz
		RX	Channel 2425	Channel 2525	Channel 2625
			871.5 MHz	881.5 MHz	891.5 MHz
10MHz	TX	Channel 20450	Channel 20525	Channel 20600	
		829 MHz	836.5 MHz	844 MHz	
	RX	Channel 2450	Channel 2525	Channel 2600	
		874 MHz	881.5 MHz	889 MHz	

Test Mode	Bandwidth	TX / RX	RF Channel		
			Low (L)	Middle (M)	High (H)
LTE BAND 7	5MHz	TX	Channel 20775	Channel 21100	Channel 21425
			2502.5 MHz	2535 MHz	2567.5 MHz
		RX	Channel 2775	Channel 3100	Channel 5825
			2622.5 MHz	2655 MHz	2687.5 MHz
	10MHz	TX	Channel 20800	Channel 21100	Channel 21400
			2505 MHz	2535 MHz	2565 MHz
		RX	Channel 2800	Channel 3100	Channel 3400
			2625 MHz	2655 MHz	2685 MHz
	15MHz	TX	Channel 20825	Channel 21100	Channel 21375
			2507.5 MHz	2535 MHz	2562.5 MHz
		RX	Channel 2825	Channel 3100	Channel 3375
			2627.5 MHz	2655 MHz	2682.5 MHz
20MHz	TX	Channel 20850	Channel 21100	Channel 21350	
		2510 MHz	2535 MHz	2560 MHz	
	RX	Channel 2850	Channel 3100	Channel 3350	
		2630 MHz	2655 MHz	2680 MHz	

Test Mode	Bandwidth	TX / RX	RF Channel		
			Low (L)	Middle (M)	High (H)
LTE BAND 41	5MHz	TX/RX	Channel 40065	Channel40640	Channel 41215
			2537.5 MHz	2595 MHz	2652.5 MHz
	10MHz	TX/RX	Channel 40090	Channel40640	Channel 41190
			2540 MHz	2595 MHz	2650 MHz
	15MHz	TX/RX	Channel 40115	Channel40640	Channel 41165
			2542.5 MHz	2595 MHz	2647.5 MHz
	20MHz	TX/RX	Channel 40140	Channel40640	Channel 41440
			2545 MHz	2595 MHz	2645 MHz

Unless otherwise stated the results shown in this test report refer only to the sample(s) tested and such sample(s) are retained for 90 days only.
 除非另有說明，此報告結果僅對測試之樣品負責，同時此樣品僅保留90天。本報告未經本公司書面許可，不可部份複製。

This document is issued by the Company subject to its General Conditions of Service printed overleaf, available on request or accessible at www.sgs.com/terms_and_conditions.htm and, for electronic format documents, subject to Terms and Conditions for Electronic Documents at www.sgs.com/terms_e-document.htm. Attention is drawn to the limitation of liability, indemnification and jurisdiction issues defined therein. Any holder of this document is advised that information contained hereon reflects the Company's findings at the time of its intervention only and within the limits of Client's instructions, if any. The Company's sole responsibility is to its Client and this document does not exonerate parties to a transaction from exercising all their rights and obligations under the transaction documents. This document cannot be reproduced except in full, without prior written approval of the Company. Any unauthorized alteration, forgery or falsification of the content or appearance of this document is unlawful and offenders may be prosecuted to the fullest extent of the law.

1.3. Test Methodology of Applied Standards

FCC 47 CFR Part 2, 22, 24, 27

ANSI C63.26-2015

KDB971168 D01 Power Meas license Digital System v03

KDB941225 D01 SAR test for 3G devices v03r01 (SAR Measurement Procedures for 3G Devices, WCDMA / HSPA) was used for EUT and Base station setting.

Note: All test items have been performed and record as per the above standards.

1.4. Test Facility

The test facility is recognized, certified, or accredited by the following organizations:

- **CNAS (No. CNAS L2929)**

CNAS has accredited SGS-CSTC Standards Technical Services Co., Ltd. Shenzhen Branch EMC Lab to ISO/IEC 17025:2005 General Requirements for the Competence of Testing and Calibration Laboratories (CNAS-CL01 Accreditation Criteria for the Competence of Testing and Calibration Laboratories) for the competence in the field of testing.

- **A2LA (Certificate No. 3816.01)**

SGS-CSTC Standards Technical Services Co., Ltd., Shenzhen EMC Laboratory is accredited by the American Association for Laboratory Accreditation(A2LA). Certificate No. 3816.01.

- **VCCI**

The 3m Fully-anechoic chamber for above 1GHz, 10m Semi-anechoic chamber for below 1GHz, Shielded Room for Mains Port Conducted Interference Measurement and Telecommunication Port Conducted Interference Measurement of SGS-CSTC Standards Technical Services Co., Ltd. have been registered in accordance with the Regulations for Voluntary Control Measures with Registration No.: G-20026, R-14188, C-12383 and T-11153 respectively.

- **FCC –Designation Number: CN1178**

SGS-CSTC Standards Technical Services Co., Ltd., Shenzhen EMC Laboratory has been recognized as an accredited testing laboratory.

Designation Number: CN1178. Test Firm Registration Number: 406779.

- **Industry Canada (IC)**

Two 3m Semi-anechoic chambers and the 10m Semi-anechoic chamber of SGS-CSTC Standards Technical Services Co., Ltd. Shenzhen Branch EMC Lab have been registered by Certification and Engineering Bureau of Industry Canada for radio equipment testing with Registration No.: 4620C-1, 4620C-2, 4620C-3.

1.5. Special Accessories

AC Charger, USB cable and Earphone are used while the test is conducted and there is no other accessory attached. This is the worst case condition.

1.6. Equipment Modifications

There were no modifications incorporated into the EUT.

Unless otherwise stated the results shown in this test report refer only to the sample(s) tested and such sample(s) are retained for 90 days only.
除非另有說明，此報告結果僅對測試之樣品負責，同時此樣品僅保留90天。本報告未經本公司書面許可，不可部份複製。

This document is issued by the Company subject to its General Conditions of Service printed overleaf, available on request or accessible at www.sgs.com/terms_and_conditions.htm and, for electronic format documents, subject to Terms and Conditions for Electronic Documents at www.sgs.com/terms_e-document.htm. Attention is drawn to the limitation of liability, indemnification and jurisdiction issues defined therein. Any holder of this document is advised that information contained hereon reflects the Company's findings at the time of its intervention only and within the limits of Client's instructions, if any. The Company's sole responsibility is to its Client and this document does not exonerate parties to a transaction from exercising all their rights and obligations under the transaction documents. This document cannot be reproduced except in full, without prior written approval of the Company. Any unauthorized alteration, forgery or falsification of the content or appearance of this document is unlawful and offenders may be prosecuted to the fullest extent of the law.

2. SYSTEM TEST CONFIGURATION

2.1. EUT Configuration

The EUT configuration for testing is installed on RF field strength measurement to meet the Commissions requirement and operating in a manner which intends to maximize its emission characteristics in a continuous normal application.

2.2. EUT Exercise

The EUT (Transmitter) was operated in the continuous transmission mode employed with the simulator of the Base Station that fixates at test default channels to fix the Tx frequency which was for the purpose of the measurements.

2.3. Test Procedure

2.3.1 Conducted Measurement at Antenna Port

According to measurement procured ANSI C63.26-2015, A low loss of RF cable was used to connect the antenna port of EUT to measurement equipment.

2.3.2 Radiated Emissions (ERP/EIRP)

According to measurement procured ANSI C63.26-2015, The EUT is a placed on a turn table, for emission measurements below 1 GHz is 0.8 m above ground plane, for emission measurements above 1 GHz, the table height shall be 1.5 m. The turn table shall rotate 360 degrees to determine the position of maximum emission level. EUT is set 3m away from the receiving antenna which varied from 1m to 4m to find out the highest emission. And also, each emission was to be maximized by changing the polarization of receiving antenna both Horizontal and Vertical. In order to find out the max. emission, the relative positions of this hand-held transmitter (EUT) was rotated through three orthogonal axes and measurement procedures for electric field radiated emissions above 1 GHz the EUT measurement is to be made “while keeping the antenna in the ‘cone of radiation’ from that area and pointed at the area both in azimuth and elevation, with polarization oriented for maximum response.” is still within the 3dB illumination BW of the measurement antenna according to the requirements in Section 8 and 13.

2.4. Measurement Results Explanation Example

For all conducted test items:

The offset level is set in the spectrum analyzer to compensate the RF cable loss and attenuation factor between EUT conducted port and spectrum analyzer. With the offset compensation, the spectrum analyzer reading level is exactly EUT RF output level.

Note:

The spectrum analyzer offset is derived from RF cable loss and attenuator factor.

Following shows an offset computation in physical test.

	RF cable loss (dB)	Attenuation factor(dB)	offset(dB)
Low Band (Below 1GHz)	0.6	4.6	5.2
High Band (Above 1 GHz)	0.7	4.7	5.4

Unless otherwise stated the results shown in this test report refer only to the sample(s) tested and such sample(s) are retained for 90 days only.
 除非另有說明，此報告結果僅對測試之樣品負責，同時此樣品僅保留90天。本報告未經本公司書面許可，不可部份複製。

This document is issued by the Company subject to its General Conditions of Service printed overleaf, available on request or accessible at www.sgs.com/terms_and_conditions.htm and, for electronic format documents, subject to Terms and Conditions for Electronic Documents at www.sgs.com/terms_e-document.htm. Attention is drawn to the limitation of liability, indemnification and jurisdiction issues defined therein. Any holder of this document is advised that information contained hereon reflects the Company's findings at the time of its intervention only and within the limits of Client's instructions, if any. The Company's sole responsibility is to its Client and this document does not exonerate parties to a transaction from exercising all their rights and obligations under the transaction documents. This document cannot be reproduced except in full, without prior written approval of the Company. Any unauthorized alteration, forgery or falsification of the content or appearance of this document is unlawful and offenders may be prosecuted to the fullest extent of the law.

2.5. Configuration of Tested System

Fig. 2-1 Configuration of Tested System (Fixed Channel-Conducted)

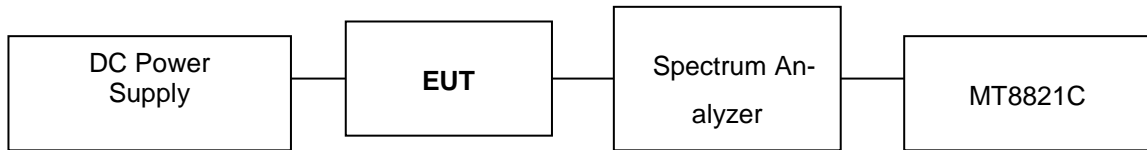
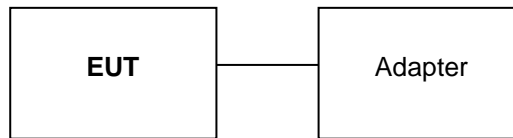

Fig. 2-2 Configuration of Tested System (Fixed Channel-Radiated)



Remote Side

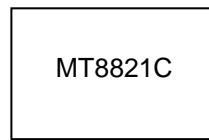

Table 2-1 Equipment Used in

Item	Equipment	Mfr/Brand	Model/ Type No.	Series No.	Data Cable	Power Cord
1.	Universal Radio Communication Tester	Anritsu	MT8821C	6201462742	shielded	Un-shielded

Unless otherwise stated the results shown in this test report refer only to the sample(s) tested and such sample(s) are retained for 90 days only.
除非另有說明，此報告結果僅對測試之樣品負責，同時此樣品僅保留90天。本報告未經本公司書面許可，不可部份複製。

This document is issued by the Company subject to its General Conditions of Service printed overleaf, available on request or accessible at www.sgs.com/terms_and_conditions.htm and, for electronic format documents, subject to Terms and Conditions for Electronic Documents at www.sgs.com/terms_e-document.htm. Attention is drawn to the limitation of liability, indemnification and jurisdiction issues defined therein. Any holder of this document is advised that information contained hereon reflects the Company's findings at the time of its intervention only and within the limits of Client's instructions, if any. The Company's sole responsibility is to its Client and this document does not exonerate parties to a transaction from exercising all their rights and obligations under the transaction documents. This document cannot be reproduced except in full, without prior written approval of the Company. Any unauthorized alteration, forgery or falsification of the content or appearance of this document is unlawful and offenders may be prosecuted to the fullest extent of the law.

3. SUMMARY OF TEST RESULTS

FCC Rules	Description Of Test	Result
§2.1046(a)	RF Power Output	Compliant
§2.1046(a) §22.913(a)(5) §24.232(c) §27.50(h)	ERP/ EIRP measurement	Compliant
§2.1049(h)	99% & 26dB Occupied Bandwidth	Compliant
§2.1051 §22.917(a) §24.238(a) §27.53(m)(4)(6)	Out of Band Emissions at Antenna Terminals and Band Edge / Emission mask requirements	Compliant
§2.1053 §22.917(a) §24.238(a) §27.53(m)(4)	Field Strength of Spurious Radiation	Compliant
§24.232(d) §27.53(d) (5) §27.50(i) (B)	Peak to Average Ratio	Compliant
§2.1055(a)(1) §22.355 §24.235 §27.54	Frequency Stability	Compliant

Unless otherwise stated the results shown in this test report refer only to the sample(s) tested and such sample(s) are retained for 90 days only.
除非另有說明，此報告結果僅對測試之樣品負責，同時此樣品僅保留90天。本報告未經本公司書面許可，不可部份複製。

This document is issued by the Company subject to its General Conditions of Service printed overleaf, available on request or accessible at www.sgs.com/terms_and_conditions.htm and, for electronic format documents, subject to Terms and Conditions for Electronic Documents at www.sgs.com/terms_e-document.htm. Attention is drawn to the limitation of liability, indemnification and jurisdiction issues defined therein. Any holder of this document is advised that information contained hereon reflects the Company's findings at the time of its intervention only and within the limits of Client's instructions, if any. The Company's sole responsibility is to its Client and this document does not exonerate parties to a transaction from exercising all their rights and obligations under the transaction documents. This document cannot be reproduced except in full, without prior written approval of the Company. Any unauthorized alteration, forgery or falsification of the content or appearance of this document is unlawful and offenders may be prosecuted to the fullest extent of the law.

4. DESCRIPTION OF TEST MODES

4.1. The Worst Test Modes and Channel Details

1. The EUT has been tested under operating condition.
2. Pre-Scan has been conducted to determine the worst-case mode from all possible combinations between available modulations, data rates, X(E1)Y(E2)Z(H) axis and antenna ports. The worst case was found as listed below. Following channel(s) was (were) selected for the final test as listed below:

BAND	RADIATED EMISSION
GSM850	E2-plan
GSM1900	E2-plan
WCDMA/HSPA Band II	E2-plan
WCDMA/HSPA Band V	E2-plan
LTE Band 2	E2-plan
LTE Band 5	E2-plan
LTE Band 7	E2-plan
LTE Band 41	E2-plan

4.1.1. GSM/EGPRS MODE

TEST ITEM	AVAILABLE CHANNEL	TESTED CHANNEL	MODE
ERP	128 to 251	128, 190, 251	GSM/EGPRS850
EIRP	512 to 810	512, 661, 810	GSM/EGPRS1900
FREQUENCY STABILITY	128 to 251 512 to 810	128, 190, 251 512, 661, 810	GSM/EGPRS850 GSM/EGPRS1900
OCCUPIED BANDWIDTH	128 to 251 512 to 810	128, 190, 251 512, 661, 810	GSM/EGPRS850 GSM/EGPRS1900
PEAK TO AVERAGE RATIO	128 to 251 512 to 810	128, 190, 251 512, 661, 810	GSM/EGPRS850 GSM/EGPRS1900
BAND EDGE	128 to 251 512 to 810	128, 251 512, 810	GSM/EGPRS850 GSM/EGPRS1900
CONDCUDED EMISSION	128 to 251 512 to 810	128, 190, 251 512, 661, 810	GSM/EGPRS850 GSM/EGPRS1900
RADIATED EMISSION	128 to 251 512 to 810	128, 190, 251 512, 661, 810	GSM/EGPRS850 GSM/EGPRS1900

Unless otherwise stated the results shown in this test report refer only to the sample(s) tested and such sample(s) are retained for 90 days only.
除非另有說明，此報告結果僅對測試之樣品負責，同時此樣品僅保留90天。本報告未經本公司書面許可，不可部份複製。

This document is issued by the Company subject to its General Conditions of Service printed overleaf, available on request or accessible at www.sgs.com/terms_and_conditions.htm and, for electronic format documents, subject to Terms and Conditions for Electronic Documents at www.sgs.com/terms_e-document.htm. Attention is drawn to the limitation of liability, indemnification and jurisdiction issues defined therein. Any holder of this document is advised that information contained hereon reflects the Company's findings at the time of its intervention only and within the limits of Client's instructions, if any. The Company's sole responsibility is to its Client and this document does not exonerate parties to a transaction from exercising all their rights and obligations under the transaction documents. This document cannot be reproduced except in full, without prior written approval of the Company. Any unauthorized alteration, forgery or falsification of the content or appearance of this document is unlawful and offenders may be prosecuted to the fullest extent of the law.

4.1.2. WCDMA/HSPA MODE

TEST ITEM	AVAILABLE CHANNEL	TESTED CHANNEL	MODE
ERP	4132 to 4233	4132, 4183, 4233	WCDMA/HSPA+ Band V
EIRP	9262 to 9538	9262, 9400, 9538	WCDMA/HSPA+ Band II
FREQUENCY STABILITY	4132 to 4233 9262 to 9538	4183 9400	WCDMA/HSPA+ Band II WCDMA/HSPA+ Band V
OCCUPIED BANDWIDTH	4132 to 4233 9262 to 9538	4132, 4183, 4233 9262, 9400, 9538	WCDMA/HSPA+ Band II WCDMA/HSPA+ Band V
PEAK TO AVERAGE RATIO	4132 to 4233 9262 to 9538	4132, 4183, 4233 9262, 9400, 9538	WCDMA/HSPA+ Band II WCDMA/HSPA+ Band V
BAND EDGE	4132 to 4233 9262 to 9538	4132, 4233 9262, 9538	WCDMA/HSPA+ Band II WCDMA/HSPA+ Band V
CONDUCTED EMISSION	4132 to 4233 9262 to 9538	4132, 4183, 4233 9262, 9400, 9538	WCDMA/HSPA+ Band II WCDMA/HSPA+ Band V
RADIATED EMISSION	4132 to 4233 9262 to 9538	4132, 4183, 4233 9262, 9400, 9538	WCDMA Band II WCDMA Band V

Unless otherwise stated the results shown in this test report refer only to the sample(s) tested and such sample(s) are retained for 90 days only.
 除非另有說明，此報告結果僅對測試之樣品負責，同時此樣品僅保留90天。本報告未經本公司書面許可，不可部份複製。

This document is issued by the Company subject to its General Conditions of Service printed overleaf, available on request or accessible at www.sgs.com/terms_and_conditions.htm and, for electronic format documents, subject to Terms and Conditions for Electronic Documents at www.sgs.com/terms_e-document.htm. Attention is drawn to the limitation of liability, indemnification and jurisdiction issues defined therein. Any holder of this document is advised that information contained hereon reflects the Company's findings at the time of its intervention only and within the limits of Client's instructions, if any. The Company's sole responsibility is to its Client and this document does not exonerate parties to a transaction from exercising all their rights and obligations under the transaction documents. This document cannot be reproduced except in full, without prior written approval of the Company. Any unauthorized alteration, forgery or falsification of the content or appearance of this document is unlawful and offenders may be prosecuted to the fullest extent of the law.

4.1.3. LTE Band 2 MODE

TEST ITEM	AVAILABLE CHANNEL	TESTED CHANNEL	CHANNEL BANDWIDTH	MODULATION	MODE
EIRP	18607 to 19193	18607, 18900, 19193	1.4MHz	QPSK, 16QAM	1RB#0, 1RB#2,1RB#5,3RB#0, 3RB#1, 3RB#3,6RB#0
	18615 to 19185	18615, 18900, 19185	3MHz	QPSK, 16QAM	1RB#0, 1RB#8,1RB#14, 8RB#0, 8RB#4, 8RB#7,15RB#0
	18625 to 19175	18625, 18900, 19175	5MHz	QPSK, 16QAM	1RB#0, 1RB#12,1RB#24, 12RB#0, 12RB#6, 12RB#13,25RB#0
	18650 to 19150	18650, 18900, 19150	10MHz	QPSK, 16QAM	1RB#0, 1RB#24,1RB#49, 25RB#0, 25RB#12, 25RB#25,50RB#0
	18675 to 19125	18675, 18900, 19125	15MHz	QPSK, 16QAM	1RB#0, 1RB#38,1RB#74, 36RB#0, 36RB#18, 36RB#39,75RB#0
	18700 to 19100	18700, 18900, 19100	20MHz	QPSK, 16QAM	1RB#0, 1RB#49, 50RB#0, 50RB#25, 50RB#50,1RB#99,100RB#0
FREQUENCY STABILITY	18700 to 19100	18700, 18900, 19100	20MHz	QPSK, 16QAM	100RB#0
OCCUPIED BANDWIDTH	18607 to 19193	18607, 18900, 19193	1.4MHz	QPSK, 16QAM	6RB#0
	18615 to 19185	18615, 18900, 19185	3MHz	QPSK, 16QAM	15RB#0
	18625 to 19175	18625, 18900, 19175	5MHz	QPSK, 16QAM	25RB#0
	18650 to 19150	18650, 18900, 19150	10MHz	QPSK, 16QAM	50RB#0
	18675 to 19125	18675, 18900, 19125	15MHz	QPSK, 16QAM	75RB#0
	18700 to 19100	18700, 18900, 19100	20MHz	QPSK, 16QAM	100RB#0
PEAK TO AVERAGE RATIO	18700 to 19100	18700, 18900, 19100	20MHz	QPSK, 16QAM	100RB#0
BAND EDGE	18607 to 19193	18607, 19193	1.4MHz	QPSK, 16QAM	1RB#0,1RB#5,6RB#0
	18615 to 19185	18615, 19185	3MHz	QPSK, 16QAM	1RB#0,1RB#14,15RB#0
	18625 to 19175	18625, 19175	5MHz	QPSK, 16QAM	1RB#0,1RB#24,25RB#0
	18650 to 19150	18650, 19150	10MHz	QPSK, 16QAM	1RB#0,1RB#49,50RB#0
	18675 to 19125	18675, 19125	15MHz	QPSK, 16QAM	1RB#0,1RB#74,75RB#0
	18700 to 19100	18700, 19100	20MHz	QPSK, 16QAM	1RB#0,1RB#99,100RB#0
CONDUCTED EMISSION	18607 to 19193	18607, 18900, 19193	1.4MHz	QPSK, 16QAM	1RB#0
	18615 to 19185	18615, 18900, 19185	3MHz	QPSK, 16QAM	1RB#0
	18625 to 19175	18625, 18900, 19175	5MHz	QPSK, 16QAM	1RB#0
	18650 to 19150	18650, 18900, 19150	10MHz	QPSK, 16QAM	1RB#0
	18675 to 19125	18675, 18900, 19125	15MHz	QPSK, 16QAM	1RB#0
	18700 to 19100	18700, 18900, 19100	20MHz	QPSK, 16QAM	1RB#0
RADIATED EMISSION	18625 to 19175	18625, 18900, 19175	3MHz	QPSK	1RB#0

Unless otherwise stated the results shown in this test report refer only to the sample(s) tested and such sample(s) are retained for 90 days only.

除非另有說明，此報告結果僅對測試之樣品負責，同時此樣品僅保留90天。本報告未經本公司書面許可，不可部份複製。

This document is issued by the Company subject to its General Conditions of Service printed overleaf, available on request or accessible at www.sgs.com/terms_and_conditions.htm and, for electronic format documents, subject to Terms and Conditions for Electronic Documents at www.sgs.com/terms_e-document.htm. Attention is drawn to the limitation of liability, indemnification and jurisdiction issues defined therein. Any holder of this document is advised that information contained hereon reflects the Company's findings at the time of its intervention only and within the limits of Client's instructions, if any. The Company's sole responsibility is to its Client and this document does not exonerate parties to a transaction from exercising all their rights and obligations under the transaction documents. This document cannot be reproduced except in full, without prior written approval of the Company. Any unauthorized alteration, forgery or falsification of the content or appearance of this document is unlawful and offenders may be prosecuted to the fullest extent of the law.

4.1.4. LTE Band 5 MODE

TEST ITEM	AVAILABLE CHANNEL	TESTED CHANNEL	CHANNEL BANDWIDTH	MODULATION	MODE
ERP	20470 to 20643	20470,20525,20643	1.4MHz	QPSK, 16QAM	1RB#0, 1RB#2,1RB#5,3RB#0, 3RB#1, 3RB#3,6RB#0
	20415 to 20635	20415,20525,20635	3MHz	QPSK, 16QAM	1RB#0, 1RB#8,1RB#14, 8RB#0, 8RB#4, 8RB#7,15RB#0
	20425 to 20625	20425,20525,20625	5MHz	QPSK, 16QAM	1RB#0, 1RB#12,1RB#24, 12RB#0, 12RB#6, 12RB#13,25RB#0
	20450 to 20600	20450,20525,20600	10MHz	QPSK, 16QAM	1RB#0, 1RB#24,1RB#49, 25RB#0, 25RB#12, 25RB#25,50RB#0
FREQUENCY STABILITY	20450 to 20600	20450,20525, 20600	10MHz	QPSK, 16QAM	50RB#0
OCCUPIED BANDWIDTH	20470 to 20643	20470,20525,20643	1.4MHz	QPSK, 16QAM	6RB#0
	20415 to 20635	20415,20525,20635	3MHz	QPSK, 16QAM	15RB#0
	20425 to 20625	20425,20525,20625	5MHz	QPSK, 16QAM	25RB#0
	20450 to 20600	20450,20525,20600	10MHz	QPSK, 16QAM	50RB#0
PEAK TO AVERAGE RATIO	20450 to 20600	20450,20525,20600	10MHz	QPSK, 16QAM	50RB#0
BAND EDGE	20470 to 20643	20470,20643	1.4MHz	QPSK, 16QAM	1RB#0,1RB#5,6RB#0
	20415 to 20635	20415,20635	3MHz	QPSK, 16QAM	1RB#0,1RB#14,15RB#0
	20425 to 20625	20425,20625	5MHz	QPSK, 16QAM	1RB#0,1RB#24,25RB#0
	20450 to 20600	20450,20600	10MHz	QPSK, 16QAM	1RB#0,1RB#49,50RB#0
CONDUCTED EMISSION	20470 to 20643	20470,20525,20643	1.4MHz	QPSK, 16QAM	1RB#0
	20415 to 20635	20415,20525,20635	3MHz	QPSK, 16QAM	1RB#0
	20425 to 20625	20425,20525,20625	5MHz	QPSK, 16QAM	1RB#0
	20450 to 20600	20450,20525,20600	10MHz	QPSK, 16QAM	1RB#0
RADIATED EMISSION	20450 to 20600	20450,20525,20600	10MHz	QPSK	1RB#0

Unless otherwise stated the results shown in this test report refer only to the sample(s) tested and such sample(s) are retained for 90 days only.
 除非另有說明，此報告結果僅對測試之樣品負責，同時此樣品僅保留90天。本報告未經本公司書面許可，不可部份複製。

This document is issued by the Company subject to its General Conditions of Service printed overleaf, available on request or accessible at www.sgs.com/terms_and_conditions.htm and, for electronic format documents, subject to Terms and Conditions for Electronic Documents at www.sgs.com/terms_e-document.htm. Attention is drawn to the limitation of liability, indemnification and jurisdiction issues defined therein. Any holder of this document is advised that information contained hereon reflects the Company's findings at the time of its intervention only and within the limits of Client's instructions, if any. The Company's sole responsibility is to its Client and this document does not exonerate parties to a transaction from exercising all their rights and obligations under the transaction documents. This document cannot be reproduced except in full, without prior written approval of the Company. Any unauthorized alteration, forgery or falsification of the content or appearance of this document is unlawful and offenders may be prosecuted to the fullest extent of the law.

4.1.5. LTE Band 7 MODE

TEST ITEM	AVAILABLE CHANNEL	TESTED CHANNEL	CHANNEL BANDWIDTH	MODULATION	MODE
EIRP	20775 to 21425	20775,21100,21425	5MHz	QPSK, 16QAM	1RB#0, 1RB#12,1RB#24, 12RB#0, 12RB#6, 12RB#13,25RB#0
	20800 to 21400	20800,21100,21400	10MHz	QPSK, 16QAM	1RB#0, 1RB#24,1RB#49, 25RB#0, 25RB#12, 25RB#25,50RB#0
	20825 to 21375	20825, 21100,21375	15MHz	QPSK, 16QAM	1RB#0, 1RB#38,1RB#74, 36RB#0, 36RB#18, 36RB#39,75RB#0
	20850 to 21350	20850,21100,21350	20MHz	QPSK, 16QAM	1RB#0, 1RB#49, 50RB#0, 50RB#25, 50RB#50,1RB#99,100RB#0
FREQUENCY STABILITY	20850 to 21350	20850,21100,21350	20MHz	QPSK, 16QAM	100RB#0
OCCUPIED BANDWIDTH	20775 to 21425	20775,21100,21425	5MHz	QPSK, 16QAM	25RB#0
	20800 to 21400	20800,21100,21400	10MHz	QPSK, 16QAM	50RB#0
	20825 to 21375	20825,21100,21375	15MHz	QPSK, 16QAM	75RB#0
	20850 to 21350	20850,21100,21350	20MHz	QPSK, 16QAM	100RB#0
PEAK TO AVERAGE RATIO	20850 to 21350	20850,21100,21350	20MHz	QPSK, 16QAM	100RB#0
BAND EDGE	20775 to 21425	20775,21425	5MHz	QPSK, 16QAM	1RB#0,1RB#24,25RB#0
	20800 to 21400	20800,21400	10MHz	QPSK, 16QAM	1RB#0,1RB#49,50RB#0
	20825 to 21375	20825,21375	15MHz	QPSK, 16QAM	1RB#0,1RB#74,75RB#0
	20850 to 21350	20850,21350	20MHz	QPSK, 16QAM	1RB#0,1RB#99,100RB#0
CONDUCTED EMISSION	20850 to 21350	20850,21100,21350	20MHz	QPSK, 16QAM	1RB#0
RADIATED EMISSION	20850 to 21350	20850,21100,21350	20MHz	QPSK	1RB#0

Unless otherwise stated the results shown in this test report refer only to the sample(s) tested and such sample(s) are retained for 90 days only.
 除非另有說明，此報告結果僅對測試之樣品負責，同時此樣品僅保留90天。本報告未經本公司書面許可，不可部份複製。

This document is issued by the Company subject to its General Conditions of Service printed overleaf, available on request or accessible at www.sgs.com/terms_and_conditions.htm and, for electronic format documents, subject to Terms and Conditions for Electronic Documents at www.sgs.com/terms_e-document.htm. Attention is drawn to the limitation of liability, indemnification and jurisdiction issues defined therein. Any holder of this document is advised that information contained hereon reflects the Company's findings at the time of its intervention only and within the limits of Client's instructions, if any. The Company's sole responsibility is to its Client and this document does not exonerate parties to a transaction from exercising all their rights and obligations under the transaction documents. This document cannot be reproduced except in full, without prior written approval of the Company. Any unauthorized alteration, forgery or falsification of the content or appearance of this document is unlawful and offenders may be prosecuted to the fullest extent of the law.

4.1.6. LTE Band 41 MODE

TEST ITEM	AVAILABLE CHANNEL	TESTED CHANNEL	CHANNEL BANDWIDTH	MODULATION	MODE
EIRP	40065 to 41215	40065,40640,41215	5MHz	QPSK, 16QAM	1RB#0, 1RB#12,1RB#24, 12RB#0, 12RB#6, 12RB#13,25RB#0
	40090 to 41190	40090,40640,41190	10MHz	QPSK, 16QAM	1RB#0, 1RB#24,1RB#49, 25RB#0, 25RB#12, 25RB#25,50RB#0
	40115 to 41165	40115,40640,41165	15MHz	QPSK, 16QAM	1RB#0, 1RB#38,1RB#74, 36RB#0, 36RB#18, 36RB#39,75RB#0
	40140 to 41440	40140,40640,41440	20MHz	QPSK, 16QAM	1RB#0, 1RB#49, 50RB#0, 50RB#25, 50RB#50,1RB#99,100RB#0
FREQUENCY STABILITY	40140 to 41440	40140,40640,41440	20MHz	QPSK, 16QAM	100RB#0
OCCUPIED BANDWIDTH	40065 to 41215	40065,40640,41215	5MHz	QPSK, 16QAM	25RB#0
	40090 to 41190	40090,40640,41190	10MHz	QPSK, 16QAM	50RB#0
	40115 to 41165	40115,40640,41165	15MHz	QPSK, 16QAM	75RB#0
	40140 to 41440	40140,40640,41440	20MHz	QPSK, 16QAM	100RB#0
PEAK TO AVERAGE RATIO	40140 to 41440	40140,40640,41440	20MHz	QPSK, 16QAM	100RB#0
BAND EDGE	40065 to 41215	40065,41215	5MHz	QPSK, 16QAM	1RB#0,1RB#24,25RB#0
	40090 to 41190	40090,41190	10MHz	QPSK, 16QAM	1RB#0,1RB#49,50RB#0
	40115 to 41165	40115,41165	15MHz	QPSK, 16QAM	1RB#0,1RB#74,75RB#0
	40140 to 41440	40140,41440	20MHz	QPSK, 16QAM	1RB#0,1RB#99,100RB#0
CONDUCTED EMISSION	40140 to 41440	40140,40640,41440	20MHz	QPSK, 16QAM	1RB#0
RADIATED EMISSION	40140 to 41440	40140,40640,41440	20MHz	QPSK	1RB#0

Unless otherwise stated the results shown in this test report refer only to the sample(s) tested and such sample(s) are retained for 90 days only.

除非另有說明，此報告結果僅對測試之樣品負責，同時此樣品僅保留90天。本報告未經本公司書面許可，不可部份複製。

This document is issued by the Company subject to its General Conditions of Service printed overleaf, available on request or accessible at www.sgs.com/terms_and_conditions.htm and, for electronic format documents, subject to Terms and Conditions for Electronic Documents at www.sgs.com/terms_e-document.htm. Attention is drawn to the limitation of liability, indemnification and jurisdiction issues defined therein. Any holder of this document is advised that information contained hereon reflects the Company's findings at the time of its intervention only and within the limits of Client's instructions, if any. The Company's sole responsibility is to its Client and this document does not exonerate parties to a transaction from exercising all their rights and obligations under the transaction documents. This document cannot be reproduced except in full, without prior written approval of the Company. Any unauthorized alteration, forgery or falsification of the content or appearance of this document is unlawful and offenders may be prosecuted to the fullest extent of the law.

5. MEASUREMENT UNCERTAINTY

For a 95% confidence level ($k = 2$), the measurement expanded uncertainties for defined systems, in accordance with the recommendations of ISO 17025 as following:

Test Item	Extended Uncertainty	Data
Transmit Output Power Data	Power [dBm]	$U = \pm 0.37$ dB
Bandwidth	Magnitude [%]	$U = \pm 0.2\%$
Band Edge Compliance	Disturbance Power [dBm]	$U = \pm 2.0$ dB
Spurious Emissions, Conducted	Disturbance Power [dBm]	$U = \pm 2.0$ dB
Field Strength of Spurious Radiation	ERP[dBm]/EIRP [dBm]	For 3 m Chamber: $U = \pm 4.5$ dB (30 MHz to 1GHz) $U = \pm 3.3$ dB (above 1 GHz) For 10 m Chamber: $U = \pm 4.5$ dB (30 MHz to 1GHz) $U = \pm 3.2$ dB (above 1 GHz)
Frequency Stability	Frequency Accuracy [ppm]	$U = \pm 0.24$ ppm

Unless otherwise stated the results shown in this test report refer only to the sample(s) tested and such sample(s) are retained for 90 days only.
除非另有說明，此報告結果僅對測試之樣品負責，同時此樣品僅保留90天。本報告未經本公司書面許可，不可部份複製。

This document is issued by the Company subject to its General Conditions of Service printed overleaf, available on request or accessible at www.sgs.com/terms_and_conditions.htm and, for electronic format documents, subject to Terms and Conditions for Electronic Documents at www.sgs.com/terms_e-document.htm. Attention is drawn to the limitation of liability, indemnification and jurisdiction issues defined therein. Any holder of this document is advised that information contained hereon reflects the Company's findings at the time of its intervention only and within the limits of Client's instructions, if any. The Company's sole responsibility is to its Client and this document does not exonerate parties to a transaction from exercising all their rights and obligations under the transaction documents. This document cannot be reproduced except in full, without prior written approval of the Company. Any unauthorized alteration, forgery or falsification of the content or appearance of this document is unlawful and offenders may be prosecuted to the fullest extent of the law.

6. MAXMUM OUTPUT POWER

6.1. Standard Applicable

A base station simulator was used to establish communication with the EUT. Its parameters were set to transmit the maximum power on the EUT. The measured power in the radio frequency on the transmitter output terminals.

ERP/EIRP LIMIT

According to FCC §2.1046

FCC 22.913(a) Mobile station is limited to 7W ERP.

FCC 24.232(b) Mobile and portable stations are limited to 2 W EIRP.

FCC 27, 50(h)(2) Mobile and other user stations. Mobile stations are limited to 2 W EIRP

6.2. Test Set-up

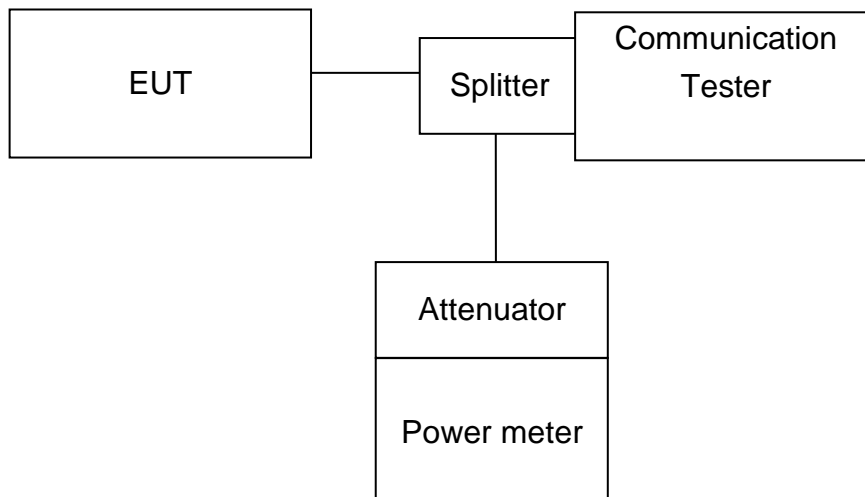

Note: Measurement setup for testing on Antenna connector

6.3. Measurement Procedure

The transmitter output was connected to a calibrated attenuator, the other end of which was connected to a power meter. Transmitter output was read off the power meter in dBm. The power output at the transmitter antenna port was determined by adding the value of the attenuator to the power meter reading. TS 151 010-1 is reference to conduct the test measurement of output power.

The Procedure of KDB941225 (SAR Measurement Procedures for 3G devices, (WCDMA/HSPA+) was used for EUT and Base station setting. RMC 12.2kps is used for this testing, and KDB 971168 D01 Power Meas License

Unless otherwise stated the results shown in this test report refer only to the sample(s) tested and such sample(s) are retained for 90 days only.
除非另有說明，此報告結果僅對測試之樣品負責，同時此樣品僅保留90天。本報告未經本公司書面許可，不可部份複製。

This document is issued by the Company subject to its General Conditions of Service printed overleaf, available on request or accessible at www.sgs.com/terms_and_conditions.htm and, for electronic format documents, subject to Terms and Conditions for Electronic Documents at www.sgs.com/terms_e-document.htm. Attention is drawn to the limitation of liability, indemnification and jurisdiction issues defined therein. Any holder of this document is advised that information contained hereon reflects the Company's findings at the time of its intervention only and within the limits of Client's instructions, if any. The Company's sole responsibility is to its Client and this document does not exonerate parties to a transaction from exercising all their rights and obligations under the transaction documents. This document cannot be reproduced except in full, without prior written approval of the Company. Any unauthorized alteration, forgery or falsification of the content or appearance of this document is unlawful and offenders may be prosecuted to the fullest extent of the law.

Digital System as the supplemental test methodology to adjust the proper setting obtaining the measurement results
All LTE bands conducted average power is obtained from the simulator telecommunication test set.
The following tests were conducted according to the test requirements outlined in section 6.2 of the 3GPP.

TEST PROCEDURE:

ANSI C63.26:2015

KDB 971168 Section 5.6

ERP/EIRP = P_{Meas} + GT-LC

where: ERP/EIRP = effective or equivalent radiated power, respectively (expressed in the same units as P_{Meas}, typically dBW or dBm);

P_{Meas} = measured transmitter output power or PSD, in dBm or dBW;

GT = gain of the transmitting antenna, in dBd (ERP) or dBi (EIRP);

LC = signal attenuation in the connecting cable between the transmitter and antenna, in dB.

For devices utilizing multiple antennas, KDB 662911 provides guidance for determining the effective array transmit antenna gain term to be used in the above equation.

6.4. Measurement Equipment Used

RF conducted test					
Test Equipment	Manufacturer	Model No.	Inventory No.	Cal. date	Cal. Due date
				(yyyy-mm-dd)	(yyyy-mm-dd)
Dual Output Mobile Communication DC Source	Agilent Technologies Inc	66311B	W009-09	2018/9/15	2019/9/15
Signal Analyzer	Rohde & Schwarz	FSV	W025-05	2018/3/13	2019/3/12
Coaxial Cable	SGS	N/A	SEM031-01	2018/7/12	2019/7/11
Attenuator	Weinschel Associates	WA41	SEM021-09	N/A	N/A
Signal Generator	KEYSIGHT	N5173B	SEM006-05	2018/9/2	2019/9/2
Humidity/ Temperature Indicator	Shanghai Meteorological Industry Factory	HTC-1	W006-17	2018/9/10	2019/9/10
Temperature Chamber	GIANT FORCE	ICT-150-40-CP-AR	W027-03	2018/11/27	2019/11/27
Wideband Radio Communication Tester	Anristu	MT8821C	6201462742	2018/5/2	2019/5/1
Wideband Radio Communication Tester	Rohde & Schwarz	CMW500	W005-02	2018/3/13	2019/3/12

Unless otherwise stated the results shown in this test report refer only to the sample(s) tested and such sample(s) are retained for 90 days only.
除非另有說明，此報告結果僅對測試之樣品負責，同時此樣品僅保留90天。本報告未經本公司書面許可，不可部份複製。

This document is issued by the Company subject to its General Conditions of Service printed overleaf, available on request or accessible at www.sgs.com/terms_and_conditions.htm and, for electronic format documents, subject to Terms and Conditions for Electronic Documents at www.sgs.com/terms_e-document.htm. Attention is drawn to the limitation of liability, indemnification and jurisdiction issues defined therein. Any holder of this document is advised that information contained hereon reflects the Company's findings at the time of its intervention only and within the limits of Client's instructions, if any. The Company's sole responsibility is to its Client and this document does not exonerate parties to a transaction from exercising all their rights and obligations under the transaction documents. This document cannot be reproduced except in full, without prior written approval of the Company. Any unauthorized alteration, forgery or falsification of the content or appearance of this document is unlawful and offenders may be prosecuted to the fullest extent of the law.

6.5. Measurement Result

6.5.1. GSM/GPRS/EGPRS MODE:

BAND	Channel	Power(dBm)	ERP(dBm)	Limit(dBm)	Verdict
GSM850	128	32.92	26.22	38.45	PASS
GSM850	190	32.95	26.25	38.45	PASS
GSM850	251	32.98	26.28	38.45	PASS
EGPRS850(8PSK 1TX)	128	27.54	20.84	38.45	PASS
EGPRS850(8PSK 1TX)	190	27.55	20.85	38.45	PASS
EGPRS850(8PSK 1TX)	251	27.57	20.87	38.45	PASS
BAND	Channel	Power(dBm)	EIRP(dBm)	Limit(dBm)	Verdict
GSM1900	512	28.26	28.48	33.00	PASS
GSM1900	661	28.35	28.57	33.00	PASS
GSM1900	810	28.37	28.59	33.00	PASS
EGPRS1900(8PSK 1TX)	512	26.84	27.06	33.00	PASS
EGPRS1900(8PSK 1TX)	661	26.88	27.10	33.00	PASS
EGPRS1900(8PSK 1TX)	810	26.86	27.08	33.00	PASS

6.5.2. WCDMA/HSDPA/HSUPA band II, V

BAND	Modulation	Channel	Power(dBm)	EIRP(dBm)	Limit(dBm)	Verdict
WCDMA Band II	QPSK	9262	20.47	20.69	33.00	PASS
WCDMA Band II	QPSK	9400	20.71	20.93	33.00	PASS
WCDMA Band II	QPSK	9538	20.61	20.83	33.00	PASS
HSDPA Band II(Subtest 1)	QPSK	9262	19.73	19.95	33.00	PASS
HSDPA Band II(Subtest 1)	QPSK	9400	19.63	19.85	33.00	PASS
HSDPA Band II(Subtest 1)	QPSK	9538	19.56	19.78	33.00	PASS
HSUPA Band II(Subtest 1)	QPSK	9262	18.41	18.63	33.00	PASS
HSUPA Band II(Subtest 1)	QPSK	9400	18.42	18.64	33.00	PASS
HSUPA Band II(Subtest 1)	QPSK	9538	18.50	18.72	33.00	PASS
HSPA+ Band II	16QAM	9262	17.77	17.99	33.00	PASS
HSPA+ Band II	16QAM	9400	17.69	17.91	33.00	PASS
HSPA+ Band II	16QAM	9538	17.58	17.80	33.00	PASS

BAND	Modulation	Channel	Power(dBm)	ERP(dBm)	Limit(dBm)	Verdict
WCDMA Band V	QPSK	4132	23.79	17.09	38.45	PASS
WCDMA Band V	QPSK	4182	23.81	17.11	38.45	PASS
WCDMA Band V	QPSK	4233	23.82	17.12	38.45	PASS
HSDPA Band V(Subtest 1)	QPSK	4132	21.82	15.12	38.45	PASS
HSDPA Band V(Subtest 1)	QPSK	4182	21.87	15.17	38.45	PASS
HSDPA Band V(Subtest 1)	QPSK	4233	21.85	15.15	38.45	PASS
HSUPA Band V(Subtest 1)	QPSK	4132	20.84	14.14	38.45	PASS
HSUPA Band V(Subtest 1)	QPSK	4182	20.78	14.08	38.45	PASS
HSUPA Band V(Subtest 1)	QPSK	4233	20.84	14.14	38.45	PASS
HSPA+ Band V	16QAM	4132	20.35	13.65	38.45	PASS
HSPA+ Band V	16QAM	4182	20.22	13.52	38.45	PASS
HSPA+ Band V	16QAM	4233	20.68	13.98	38.45	PASS

Unless otherwise stated the results shown in this test report refer only to the sample(s) tested and such sample(s) are retained for 90 days only.

除非另有說明，此報告結果僅對測試之樣品負責，同時此樣品僅保留90天。本報告未經本公司書面許可，不可部份複製。

This document is issued by the Company subject to its General Conditions of Service printed overleaf, available on request or accessible at www.sgs.com/terms_and_conditions.htm and, for electronic format documents, subject to Terms and Conditions for Electronic Documents at www.sgs.com/terms_e-document.htm. Attention is drawn to the limitation of liability, indemnification and jurisdiction issues defined therein. Any holder of this document is advised that information contained hereon reflects the Company's findings at the time of its intervention only and within the limits of Client's instructions, if any. The Company's sole responsibility is to its Client and this document does not exonerate parties to a transaction from exercising all their rights and obligations under the transaction documents. This document cannot be reproduced except in full, without prior written approval of the Company. Any unauthorized alteration, forgery or falsification of the content or appearance of this document is unlawful and offenders may be prosecuted to the fullest extent of the law.

6.5.3. LTE Band2 Mode:

BAND	Bandwidth	Modulation	Channel	RB Configuration	Result (dBm)	EIRP (dBm)	Limit (dBm)	Verdict
Band2	1.4MHz	QPSK	18607	1RB#0	21.17	21.39	33.00	PASS
Band2	1.4MHz	QPSK	18607	1RB#2	21.33	21.55	33.00	PASS
Band2	1.4MHz	QPSK	18607	1RB#5	21.18	21.40	33.00	PASS
Band2	1.4MHz	QPSK	18607	3RB#0	21.27	21.49	33.00	PASS
Band2	1.4MHz	QPSK	18607	3RB#1	21.33	21.55	33.00	PASS
Band2	1.4MHz	QPSK	18607	3RB#3	21.30	21.52	33.00	PASS
Band2	1.4MHz	QPSK	18607	6RB#0	20.28	20.50	33.00	PASS
Band2	1.4MHz	QPSK	18900	1RB#0	21.18	21.40	33.00	PASS
Band2	1.4MHz	QPSK	18900	1RB#2	21.29	21.51	33.00	PASS
Band2	1.4MHz	QPSK	18900	1RB#5	21.19	21.41	33.00	PASS
Band2	1.4MHz	QPSK	18900	3RB#0	21.26	21.48	33.00	PASS
Band2	1.4MHz	QPSK	18900	3RB#1	21.32	21.54	33.00	PASS
Band2	1.4MHz	QPSK	18900	3RB#3	21.31	21.53	33.00	PASS
Band2	1.4MHz	QPSK	18900	6RB#0	20.26	20.48	33.00	PASS
Band2	1.4MHz	QPSK	19193	1RB#0	21.30	21.52	33.00	PASS
Band2	1.4MHz	QPSK	19193	1RB#2	21.42	21.64	33.00	PASS
Band2	1.4MHz	QPSK	19193	1RB#5	21.28	21.50	33.00	PASS
Band2	1.4MHz	QPSK	19193	3RB#0	21.39	21.61	33.00	PASS
Band2	1.4MHz	QPSK	19193	3RB#1	21.45	21.67	33.00	PASS
Band2	1.4MHz	QPSK	19193	3RB#3	21.39	21.61	33.00	PASS
Band2	1.4MHz	QPSK	19193	6RB#0	20.37	20.59	33.00	PASS
Band2	1.4MHz	16QAM	18607	1RB#0	20.44	20.66	33.00	PASS
Band2	1.4MHz	16QAM	18607	1RB#2	20.53	20.75	33.00	PASS
Band2	1.4MHz	16QAM	18607	1RB#5	20.53	20.75	33.00	PASS
Band2	1.4MHz	16QAM	18607	3RB#0	20.41	20.63	33.00	PASS
Band2	1.4MHz	16QAM	18607	3RB#1	20.48	20.70	33.00	PASS
Band2	1.4MHz	16QAM	18607	3RB#3	20.32	20.54	33.00	PASS
Band2	1.4MHz	16QAM	18607	6RB#0	19.38	19.60	33.00	PASS
Band2	1.4MHz	16QAM	18900	1RB#0	20.49	20.71	33.00	PASS
Band2	1.4MHz	16QAM	18900	1RB#2	20.59	20.81	33.00	PASS
Band2	1.4MHz	16QAM	18900	1RB#5	20.51	20.73	33.00	PASS
Band2	1.4MHz	16QAM	18900	3RB#0	20.37	20.59	33.00	PASS
Band2	1.4MHz	16QAM	18900	3RB#1	20.50	20.72	33.00	PASS
Band2	1.4MHz	16QAM	18900	3RB#3	20.39	20.61	33.00	PASS
Band2	1.4MHz	16QAM	18900	6RB#0	19.38	19.60	33.00	PASS
Band2	1.4MHz	16QAM	19193	1RB#0	20.65	20.87	33.00	PASS
Band2	1.4MHz	16QAM	19193	1RB#2	20.66	20.88	33.00	PASS
Band2	1.4MHz	16QAM	19193	1RB#5	20.59	20.81	33.00	PASS
Band2	1.4MHz	16QAM	19193	3RB#0	20.54	20.76	33.00	PASS
Band2	1.4MHz	16QAM	19193	3RB#1	20.61	20.83	33.00	PASS
Band2	1.4MHz	16QAM	19193	3RB#3	20.51	20.73	33.00	PASS
Band2	1.4MHz	16QAM	19193	6RB#0	19.46	19.68	33.00	PASS
Band2	3MHz	QPSK	18615	1RB#0	21.31	21.53	33.00	PASS
Band2	3MHz	QPSK	18615	1RB#8	21.28	21.50	33.00	PASS
Band2	3MHz	QPSK	18615	1RB#14	21.28	21.50	33.00	PASS
Band2	3MHz	QPSK	18615	8RB#0	20.33	20.55	33.00	PASS

Unless otherwise stated the results shown in this test report refer only to the sample(s) tested and such sample(s) are retained for 90 days only.
 除非另有說明，此報告結果僅對測試之樣品負責，同時此樣品僅保留90天。本報告未經本公司書面許可，不可部份複製。

This document is issued by the Company subject to its General Conditions of Service printed overleaf, available on request or accessible at www.sgs.com/terms_and_conditions.htm and, for electronic format documents, subject to Terms and Conditions for Electronic Documents at www.sgs.com/terms_e-document.htm. Attention is drawn to the limitation of liability, indemnification and jurisdiction issues defined therein. Any holder of this document is advised that information contained hereon reflects the Company's findings at the time of its intervention only and within the limits of Client's instructions, if any. The Company's sole responsibility is to its Client and this document does not exonerate parties to a transaction from exercising all their rights and obligations under the transaction documents. This document cannot be reproduced except in full, without prior written approval of the Company. Any unauthorized alteration, forgery or falsification of the content or appearance of this document is unlawful and offenders may be prosecuted to the fullest extent of the law.

Band2	3MHz	QPSK	18615	8RB#4	20.35	20.57	33.00	PASS
Band2	3MHz	QPSK	18615	8RB#7	20.33	20.55	33.00	PASS
Band2	3MHz	QPSK	18615	15RB#0	20.30	20.52	33.00	PASS
Band2	3MHz	QPSK	18900	1RB#0	21.28	21.50	33.00	PASS
Band2	3MHz	QPSK	18900	1RB#8	21.29	21.51	33.00	PASS
Band2	3MHz	QPSK	18900	1RB#14	21.27	21.49	33.00	PASS
Band2	3MHz	QPSK	18900	8RB#0	20.33	20.55	33.00	PASS
Band2	3MHz	QPSK	18900	8RB#4	20.35	20.57	33.00	PASS
Band2	3MHz	QPSK	18900	8RB#7	20.29	20.51	33.00	PASS
Band2	3MHz	QPSK	18900	15RB#0	20.28	20.50	33.00	PASS
Band2	3MHz	QPSK	19185	1RB#0	21.35	21.57	33.00	PASS
Band2	3MHz	QPSK	19185	1RB#8	21.38	21.60	33.00	PASS
Band2	3MHz	QPSK	19185	1RB#14	21.38	21.60	33.00	PASS
Band2	3MHz	QPSK	19185	8RB#0	20.40	20.62	33.00	PASS
Band2	3MHz	QPSK	19185	8RB#4	20.44	20.66	33.00	PASS
Band2	3MHz	QPSK	19185	8RB#7	20.41	20.63	33.00	PASS
Band2	3MHz	QPSK	19185	15RB#0	20.37	20.59	33.00	PASS
Band2	3MHz	16QAM	18615	1RB#0	20.57	20.79	33.00	PASS
Band2	3MHz	16QAM	18615	1RB#8	20.56	20.78	33.00	PASS
Band2	3MHz	16QAM	18615	1RB#14	20.58	20.80	33.00	PASS
Band2	3MHz	16QAM	18615	8RB#0	19.41	19.63	33.00	PASS
Band2	3MHz	16QAM	18615	8RB#4	19.40	19.62	33.00	PASS
Band2	3MHz	16QAM	18615	8RB#7	19.40	19.62	33.00	PASS
Band2	3MHz	16QAM	18615	15RB#0	19.31	19.53	33.00	PASS
Band2	3MHz	16QAM	18900	1RB#0	20.61	20.83	33.00	PASS
Band2	3MHz	16QAM	18900	1RB#8	20.65	20.87	33.00	PASS
Band2	3MHz	16QAM	18900	1RB#14	20.53	20.75	33.00	PASS
Band2	3MHz	16QAM	18900	8RB#0	19.38	19.60	33.00	PASS
Band2	3MHz	16QAM	18900	8RB#4	19.40	19.62	33.00	PASS
Band2	3MHz	16QAM	18900	8RB#7	19.38	19.60	33.00	PASS
Band2	3MHz	16QAM	18900	15RB#0	19.30	19.52	33.00	PASS
Band2	3MHz	16QAM	19185	1RB#0	20.63	20.85	33.00	PASS
Band2	3MHz	16QAM	19185	1RB#8	20.66	20.88	33.00	PASS
Band2	3MHz	16QAM	19185	1RB#14	20.68	20.90	33.00	PASS
Band2	3MHz	16QAM	19185	8RB#0	19.49	19.71	33.00	PASS
Band2	3MHz	16QAM	19185	8RB#4	19.49	19.71	33.00	PASS
Band2	3MHz	16QAM	19185	8RB#7	19.47	19.69	33.00	PASS
Band2	3MHz	16QAM	19185	15RB#0	19.40	19.62	33.00	PASS
Band2	5MHz	QPSK	18625	1RB#0	21.20	21.42	33.00	PASS
Band2	5MHz	QPSK	18625	1RB#12	21.50	21.72	33.00	PASS
Band2	5MHz	QPSK	18625	1RB#24	21.16	21.38	33.00	PASS
Band2	5MHz	QPSK	18625	12RB#0	20.33	20.55	33.00	PASS
Band2	5MHz	QPSK	18625	12RB#6	20.38	20.60	33.00	PASS
Band2	5MHz	QPSK	18625	12RB#13	20.34	20.56	33.00	PASS
Band2	5MHz	QPSK	18625	25RB#0	20.34	20.56	33.00	PASS
Band2	5MHz	QPSK	18900	1RB#0	21.21	21.43	33.00	PASS
Band2	5MHz	QPSK	18900	1RB#12	21.47	21.69	33.00	PASS
Band2	5MHz	QPSK	18900	1RB#24	21.15	21.37	33.00	PASS
Band2	5MHz	QPSK	18900	12RB#0	20.30	20.52	33.00	PASS
Band2	5MHz	QPSK	18900	12RB#6	20.36	20.58	33.00	PASS
Band2	5MHz	QPSK	18900	12RB#13	20.32	20.54	33.00	PASS
Band2	5MHz	QPSK	18900	25RB#0	20.31	20.53	33.00	PASS

Unless otherwise stated the results shown in this test report refer only to the sample(s) tested and such sample(s) are retained for 90 days only.

除非另有說明，此報告結果僅對測試之樣品負責，同時此樣品僅保留90天。本報告未經本公司書面許可，不可部份複製。

This document is issued by the Company subject to its General Conditions of Service printed overleaf, available on request or accessible at www.sgs.com/terms_and_conditions.htm and, for electronic format documents, subject to Terms and Conditions for Electronic Documents at www.sgs.com/terms_e-document.htm. Attention is drawn to the limitation of liability, indemnification and jurisdiction issues defined therein. Any holder of this document is advised that information contained hereon reflects the Company's findings at the time of its intervention only and within the limits of Client's instructions, if any. The Company's sole responsibility is to its Client and this document does not exonerate parties to a transaction from exercising all their rights and obligations under the transaction documents. This document cannot be reproduced except in full, without prior written approval of the Company. Any unauthorized alteration, forgery or falsification of the content or appearance of this document is unlawful and offenders may be prosecuted to the fullest extent of the law.

Band2	5MHz	QPSK	19175	1RB#0	21.26	21.48	33.00	PASS
Band2	5MHz	QPSK	19175	1RB#12	21.55	21.77	33.00	PASS
Band2	5MHz	QPSK	19175	1RB#24	21.29	21.51	33.00	PASS
Band2	5MHz	QPSK	19175	12RB#0	20.37	20.59	33.00	PASS
Band2	5MHz	QPSK	19175	12RB#6	20.49	20.71	33.00	PASS
Band2	5MHz	QPSK	19175	12RB#13	20.46	20.68	33.00	PASS
Band2	5MHz	QPSK	19175	25RB#0	20.42	20.64	33.00	PASS
Band2	5MHz	16QAM	18625	1RB#0	20.49	20.71	33.00	PASS
Band2	5MHz	16QAM	18625	1RB#12	20.68	20.90	33.00	PASS
Band2	5MHz	16QAM	18625	1RB#24	20.48	20.70	33.00	PASS
Band2	5MHz	16QAM	18625	12RB#0	19.34	19.56	33.00	PASS
Band2	5MHz	16QAM	18625	12RB#6	19.42	19.64	33.00	PASS
Band2	5MHz	16QAM	18625	12RB#13	19.39	19.61	33.00	PASS
Band2	5MHz	16QAM	18625	25RB#0	19.40	19.62	33.00	PASS
Band2	5MHz	16QAM	18900	1RB#0	20.51	20.73	33.00	PASS
Band2	5MHz	16QAM	18900	1RB#12	20.66	20.88	33.00	PASS
Band2	5MHz	16QAM	18900	1RB#24	20.41	20.63	33.00	PASS
Band2	5MHz	16QAM	18900	12RB#0	19.35	19.57	33.00	PASS
Band2	5MHz	16QAM	18900	12RB#6	19.42	19.64	33.00	PASS
Band2	5MHz	16QAM	18900	12RB#13	19.36	19.58	33.00	PASS
Band2	5MHz	16QAM	18900	25RB#0	19.33	19.55	33.00	PASS
Band2	5MHz	16QAM	19175	1RB#0	20.58	20.80	33.00	PASS
Band2	5MHz	16QAM	19175	1RB#12	20.68	20.90	33.00	PASS
Band2	5MHz	16QAM	19175	1RB#24	20.61	20.83	33.00	PASS
Band2	5MHz	16QAM	19175	12RB#0	19.41	19.63	33.00	PASS
Band2	5MHz	16QAM	19175	12RB#6	19.50	19.72	33.00	PASS
Band2	5MHz	16QAM	19175	12RB#13	19.47	19.69	33.00	PASS
Band2	5MHz	16QAM	19175	25RB#0	19.44	19.66	33.00	PASS
Band2	10MHz	QPSK	18650	1RB#0	21.30	21.52	33.00	PASS
Band2	10MHz	QPSK	18650	1RB#24	21.39	21.61	33.00	PASS
Band2	10MHz	QPSK	18650	1RB#49	21.30	21.52	33.00	PASS
Band2	10MHz	QPSK	18650	25RB#0	20.39	20.61	33.00	PASS
Band2	10MHz	QPSK	18650	25RB#12	20.38	20.60	33.00	PASS
Band2	10MHz	QPSK	18650	25RB#25	20.41	20.63	33.00	PASS
Band2	10MHz	QPSK	18650	50RB#0	20.42	20.64	33.00	PASS
Band2	10MHz	QPSK	18900	1RB#0	21.29	21.51	33.00	PASS
Band2	10MHz	QPSK	18900	1RB#24	21.41	21.63	33.00	PASS
Band2	10MHz	QPSK	18900	1RB#49	21.23	21.45	33.00	PASS
Band2	10MHz	QPSK	18900	25RB#0	20.34	20.56	33.00	PASS
Band2	10MHz	QPSK	18900	25RB#12	20.34	20.56	33.00	PASS
Band2	10MHz	QPSK	18900	25RB#25	20.38	20.60	33.00	PASS
Band2	10MHz	QPSK	18900	50RB#0	20.32	20.54	33.00	PASS
Band2	10MHz	QPSK	19150	1RB#0	21.31	21.53	33.00	PASS
Band2	10MHz	QPSK	19150	1RB#24	21.48	21.70	33.00	PASS
Band2	10MHz	QPSK	19150	1RB#49	21.34	21.56	33.00	PASS
Band2	10MHz	QPSK	19150	25RB#0	20.47	20.69	33.00	PASS
Band2	10MHz	QPSK	19150	25RB#12	20.44	20.66	33.00	PASS
Band2	10MHz	QPSK	19150	25RB#25	20.47	20.69	33.00	PASS
Band2	10MHz	QPSK	19150	50RB#0	20.43	20.65	33.00	PASS
Band2	10MHz	16QAM	18650	1RB#0	20.50	20.72	33.00	PASS
Band2	10MHz	16QAM	18650	1RB#24	20.64	20.86	33.00	PASS
Band2	10MHz	16QAM	18650	1RB#49	20.56	20.78	33.00	PASS

Unless otherwise stated the results shown in this test report refer only to the sample(s) tested and such sample(s) are retained for 90 days only.

除非另有說明，此報告結果僅對測試之樣品負責，同時此樣品僅保留90天。本報告未經本公司書面許可，不可部份複製。

This document is issued by the Company subject to its General Conditions of Service printed overleaf, available on request or accessible at www.sgs.com/terms_and_conditions.htm and, for electronic format documents, subject to Terms and Conditions for Electronic Documents at www.sgs.com/terms_e-document.htm. Attention is drawn to the limitation of liability, indemnification and jurisdiction issues defined therein. Any holder of this document is advised that information contained hereon reflects the Company's findings at the time of its intervention only and within the limits of Client's instructions, if any. The Company's sole responsibility is to its Client and this document does not exonerate parties to a transaction from exercising all their rights and obligations under the transaction documents. This document cannot be reproduced except in full, without prior written approval of the Company. Any unauthorized alteration, forgery or falsification of the content or appearance of this document is unlawful and offenders may be prosecuted to the fullest extent of the law.

Band2	10MHz	16QAM	18650	25RB#0	19.44	19.66	33.00	PASS
Band2	10MHz	16QAM	18650	25RB#12	19.41	19.63	33.00	PASS
Band2	10MHz	16QAM	18650	25RB#25	19.40	19.62	33.00	PASS
Band2	10MHz	16QAM	18650	50RB#0	19.42	19.64	33.00	PASS
Band2	10MHz	16QAM	18900	1RB#0	20.52	20.74	33.00	PASS
Band2	10MHz	16QAM	18900	1RB#24	20.66	20.88	33.00	PASS
Band2	10MHz	16QAM	18900	1RB#49	20.46	20.68	33.00	PASS
Band2	10MHz	16QAM	18900	25RB#0	19.37	19.59	33.00	PASS
Band2	10MHz	16QAM	18900	25RB#12	19.36	19.58	33.00	PASS
Band2	10MHz	16QAM	18900	25RB#25	19.40	19.62	33.00	PASS
Band2	10MHz	16QAM	18900	50RB#0	19.35	19.57	33.00	PASS
Band2	10MHz	16QAM	19150	1RB#0	20.62	20.84	33.00	PASS
Band2	10MHz	16QAM	19150	1RB#24	20.62	20.84	33.00	PASS
Band2	10MHz	16QAM	19150	1RB#49	20.65	20.87	33.00	PASS
Band2	10MHz	16QAM	19150	25RB#0	19.48	19.70	33.00	PASS
Band2	10MHz	16QAM	19150	25RB#12	19.43	19.65	33.00	PASS
Band2	10MHz	16QAM	19150	25RB#25	19.48	19.70	33.00	PASS
Band2	10MHz	16QAM	19150	50RB#0	19.44	19.66	33.00	PASS
Band2	15MHz	QPSK	18675	1RB#0	21.26	21.48	33.00	PASS
Band2	15MHz	QPSK	18675	1RB#38	21.37	21.59	33.00	PASS
Band2	15MHz	QPSK	18675	1RB#74	21.20	21.42	33.00	PASS
Band2	15MHz	QPSK	18675	36RB#0	20.32	20.54	33.00	PASS
Band2	15MHz	QPSK	18675	36RB#18	20.36	20.58	33.00	PASS
Band2	15MHz	QPSK	18675	36RB#39	20.31	20.53	33.00	PASS
Band2	15MHz	QPSK	18675	75RB#0	20.32	20.54	33.00	PASS
Band2	15MHz	QPSK	18900	1RB#0	21.19	21.41	33.00	PASS
Band2	15MHz	QPSK	18900	1RB#38	21.27	21.49	33.00	PASS
Band2	15MHz	QPSK	18900	1RB#74	21.16	21.38	33.00	PASS
Band2	15MHz	QPSK	18900	36RB#0	20.30	20.52	33.00	PASS
Band2	15MHz	QPSK	18900	36RB#18	20.29	20.51	33.00	PASS
Band2	15MHz	QPSK	18900	36RB#39	20.30	20.52	33.00	PASS
Band2	15MHz	QPSK	18900	75RB#0	20.30	20.52	33.00	PASS
Band2	15MHz	QPSK	19125	1RB#0	21.25	21.47	33.00	PASS
Band2	15MHz	QPSK	19125	1RB#38	21.31	21.53	33.00	PASS
Band2	15MHz	QPSK	19125	1RB#74	21.26	21.48	33.00	PASS
Band2	15MHz	QPSK	19125	36RB#0	20.42	20.64	33.00	PASS
Band2	15MHz	QPSK	19125	36RB#18	20.41	20.63	33.00	PASS
Band2	15MHz	QPSK	19125	36RB#39	20.41	20.63	33.00	PASS
Band2	15MHz	QPSK	19125	75RB#0	20.40	20.62	33.00	PASS
Band2	15MHz	16QAM	18675	1RB#0	20.49	20.71	33.00	PASS
Band2	15MHz	16QAM	18675	1RB#38	20.65	20.87	33.00	PASS
Band2	15MHz	16QAM	18675	1RB#74	20.42	20.64	33.00	PASS
Band2	15MHz	16QAM	18675	36RB#0	19.34	19.56	33.00	PASS
Band2	15MHz	16QAM	18675	36RB#18	19.36	19.58	33.00	PASS
Band2	15MHz	16QAM	18675	36RB#39	19.31	19.53	33.00	PASS
Band2	15MHz	16QAM	18675	75RB#0	19.34	19.56	33.00	PASS
Band2	15MHz	16QAM	18900	1RB#0	20.46	20.68	33.00	PASS
Band2	15MHz	16QAM	18900	1RB#38	20.61	20.83	33.00	PASS
Band2	15MHz	16QAM	18900	1RB#74	20.36	20.58	33.00	PASS
Band2	15MHz	16QAM	18900	36RB#0	19.31	19.53	33.00	PASS
Band2	15MHz	16QAM	18900	36RB#18	19.32	19.54	33.00	PASS
Band2	15MHz	16QAM	18900	36RB#39	19.32	19.54	33.00	PASS

Unless otherwise stated the results shown in this test report refer only to the sample(s) tested and such sample(s) are retained for 90 days only.

除非另有說明，此報告結果僅對測試之樣品負責，同時此樣品僅保留90天。本報告未經本公司書面許可，不可部份複製。

This document is issued by the Company subject to its General Conditions of Service printed overleaf, available on request or accessible at www.sgs.com/terms_and_conditions.htm and, for electronic format documents, subject to Terms and Conditions for Electronic Documents at www.sgs.com/terms_e-document.htm. Attention is drawn to the limitation of liability, indemnification and jurisdiction issues defined therein. Any holder of this document is advised that information contained hereon reflects the Company's findings at the time of its intervention only and within the limits of Client's instructions, if any. The Company's sole responsibility is to its Client and this document does not exonerate parties to a transaction from exercising all their rights and obligations under the transaction documents. This document cannot be reproduced except in full, without prior written approval of the Company. Any unauthorized alteration, forgery or falsification of the content or appearance of this document is unlawful and offenders may be prosecuted to the fullest extent of the law.

Band2	15MHz	16QAM	18900	75RB#0	19.32	19.54	33.00	PASS
Band2	15MHz	16QAM	19125	1RB#0	20.53	20.75	33.00	PASS
Band2	15MHz	16QAM	19125	1RB#38	20.66	20.88	33.00	PASS
Band2	15MHz	16QAM	19125	1RB#74	20.62	20.84	33.00	PASS
Band2	15MHz	16QAM	19125	36RB#0	19.41	19.63	33.00	PASS
Band2	15MHz	16QAM	19125	36RB#18	19.41	19.63	33.00	PASS
Band2	15MHz	16QAM	19125	36RB#39	19.39	19.61	33.00	PASS
Band2	15MHz	16QAM	19125	75RB#0	19.40	19.62	33.00	PASS
Band2	20MHz	QPSK	18700	1RB#0	21.19	21.41	33.00	PASS
Band2	20MHz	QPSK	18700	1RB#49	21.41	21.63	33.00	PASS
Band2	20MHz	QPSK	18700	1RB#99	21.12	21.34	33.00	PASS
Band2	20MHz	QPSK	18700	50RB#0	20.33	20.55	33.00	PASS
Band2	20MHz	QPSK	18700	50RB#25	20.35	20.57	33.00	PASS
Band2	20MHz	QPSK	18700	50RB#50	20.20	20.42	33.00	PASS
Band2	20MHz	QPSK	18700	100RB#0	20.24	20.46	33.00	PASS
Band2	20MHz	QPSK	18900	1RB#0	21.15	21.37	33.00	PASS
Band2	20MHz	QPSK	18900	1RB#49	21.35	21.57	33.00	PASS
Band2	20MHz	QPSK	18900	1RB#99	21.08	21.30	33.00	PASS
Band2	20MHz	QPSK	18900	50RB#0	20.26	20.48	33.00	PASS
Band2	20MHz	QPSK	18900	50RB#25	20.26	20.48	33.00	PASS
Band2	20MHz	QPSK	18900	50RB#50	20.29	20.51	33.00	PASS
Band2	20MHz	QPSK	18900	100RB#0	20.29	20.51	33.00	PASS
Band2	20MHz	QPSK	19100	1RB#0	21.16	21.38	33.00	PASS
Band2	20MHz	QPSK	19100	1RB#49	21.43	21.65	33.00	PASS
Band2	20MHz	QPSK	19100	1RB#99	21.22	21.44	33.00	PASS
Band2	20MHz	QPSK	19100	50RB#0	20.44	20.66	33.00	PASS
Band2	20MHz	QPSK	19100	50RB#25	20.34	20.56	33.00	PASS
Band2	20MHz	QPSK	19100	50RB#50	20.30	20.52	33.00	PASS
Band2	20MHz	QPSK	19100	100RB#0	20.40	20.62	33.00	PASS
Band2	20MHz	16QAM	18700	1RB#0	20.48	20.70	33.00	PASS
Band2	20MHz	16QAM	18700	1RB#49	20.66	20.88	33.00	PASS
Band2	20MHz	16QAM	18700	1RB#99	20.40	20.62	33.00	PASS
Band2	20MHz	16QAM	18700	50RB#0	19.33	19.55	33.00	PASS
Band2	20MHz	16QAM	18700	50RB#25	19.36	19.58	33.00	PASS
Band2	20MHz	16QAM	18700	50RB#50	19.20	19.42	33.00	PASS
Band2	20MHz	16QAM	18700	100RB#0	19.25	19.47	33.00	PASS
Band2	20MHz	16QAM	18900	1RB#0	20.52	20.74	33.00	PASS
Band2	20MHz	16QAM	18900	1RB#49	20.59	20.81	33.00	PASS
Band2	20MHz	16QAM	18900	1RB#99	20.34	20.56	33.00	PASS
Band2	20MHz	16QAM	18900	50RB#0	19.28	19.50	33.00	PASS
Band2	20MHz	16QAM	18900	50RB#25	19.29	19.51	33.00	PASS
Band2	20MHz	16QAM	18900	50RB#50	19.29	19.51	33.00	PASS
Band2	20MHz	16QAM	18900	100RB#0	19.33	19.55	33.00	PASS
Band2	20MHz	16QAM	19100	1RB#0	20.49	20.71	33.00	PASS
Band2	20MHz	16QAM	19100	1RB#49	20.66	20.88	33.00	PASS
Band2	20MHz	16QAM	19100	1RB#99	20.51	20.73	33.00	PASS
Band2	20MHz	16QAM	19100	50RB#0	19.43	19.65	33.00	PASS
Band2	20MHz	16QAM	19100	50RB#25	19.34	19.56	33.00	PASS
Band2	20MHz	16QAM	19100	50RB#50	19.31	19.53	33.00	PASS
Band2	20MHz	16QAM	19100	100RB#0	19.37	19.59	33.00	PASS

Unless otherwise stated the results shown in this test report refer only to the sample(s) tested and such sample(s) are retained for 90 days only.

除非另有說明，此報告結果僅對測試之樣品負責，同時此樣品僅保留90天。本報告未經本公司書面許可，不可部份複製。

This document is issued by the Company subject to its General Conditions of Service printed overleaf, available on request or accessible at www.sgs.com/terms_and_conditions.htm and, for electronic format documents, subject to Terms and Conditions for Electronic Documents at www.sgs.com/terms_e-document.htm. Attention is drawn to the limitation of liability, indemnification and jurisdiction issues defined therein. Any holder of this document is advised that information contained hereon reflects the Company's findings at the time of its intervention only and within the limits of Client's instructions, if any. The Company's sole responsibility is to its Client and this document does not exonerate parties to a transaction from exercising all their rights and obligations under the transaction documents. This document cannot be reproduced except in full, without prior written approval of the Company. Any unauthorized alteration, forgery or falsification of the content or appearance of this document is unlawful and offenders may be prosecuted to the fullest extent of the law.

6.5.4. LTE Band5 Mode:

BAND	Bandwidth	Modulation	Channel	RB Configuration	Result (dBm)	ERP (dBm)	Limit (dBm)	Verdict
Band5	1.4MHz	QPSK	20407	1RB#0	24.23	17.53	38.45	PASS
Band5	1.4MHz	QPSK	20407	1RB#2	24.40	17.70	38.45	PASS
Band5	1.4MHz	QPSK	20407	1RB#5	24.26	17.56	38.45	PASS
Band5	1.4MHz	QPSK	20407	3RB#0	24.33	17.63	38.45	PASS
Band5	1.4MHz	QPSK	20407	3RB#1	24.41	17.71	38.45	PASS
Band5	1.4MHz	QPSK	20407	3RB#3	24.37	17.67	38.45	PASS
Band5	1.4MHz	QPSK	20407	6RB#0	23.35	16.65	38.45	PASS
Band5	1.4MHz	QPSK	20525	1RB#0	24.29	17.59	38.45	PASS
Band5	1.4MHz	QPSK	20525	1RB#2	24.43	17.73	38.45	PASS
Band5	1.4MHz	QPSK	20525	1RB#5	24.28	17.58	38.45	PASS
Band5	1.4MHz	QPSK	20525	3RB#0	24.39	17.69	38.45	PASS
Band5	1.4MHz	QPSK	20525	3RB#1	24.44	17.74	38.45	PASS
Band5	1.4MHz	QPSK	20525	3RB#3	24.37	17.67	38.45	PASS
Band5	1.4MHz	QPSK	20525	6RB#0	23.38	16.68	38.45	PASS
Band5	1.4MHz	QPSK	20643	1RB#0	24.22	17.52	38.45	PASS
Band5	1.4MHz	QPSK	20643	1RB#2	24.38	17.68	38.45	PASS
Band5	1.4MHz	QPSK	20643	1RB#5	24.25	17.55	38.45	PASS
Band5	1.4MHz	QPSK	20643	3RB#0	24.36	17.66	38.45	PASS
Band5	1.4MHz	QPSK	20643	3RB#1	24.42	17.72	38.45	PASS
Band5	1.4MHz	QPSK	20643	3RB#3	24.34	17.64	38.45	PASS
Band5	1.4MHz	QPSK	20643	6RB#0	23.38	16.68	38.45	PASS
Band5	1.4MHz	16QAM	20407	1RB#0	23.35	16.65	38.45	PASS
Band5	1.4MHz	16QAM	20407	1RB#2	23.49	16.79	38.45	PASS
Band5	1.4MHz	16QAM	20407	1RB#5	23.34	16.64	38.45	PASS
Band5	1.4MHz	16QAM	20407	3RB#0	23.28	16.58	38.45	PASS
Band5	1.4MHz	16QAM	20407	3RB#1	23.36	16.66	38.45	PASS
Band5	1.4MHz	16QAM	20407	3RB#3	23.31	16.61	38.45	PASS
Band5	1.4MHz	16QAM	20407	6RB#0	22.40	15.70	38.45	PASS
Band5	1.4MHz	16QAM	20525	1RB#0	23.46	16.76	38.45	PASS
Band5	1.4MHz	16QAM	20525	1RB#2	23.58	16.88	38.45	PASS
Band5	1.4MHz	16QAM	20525	1RB#5	23.48	16.78	38.45	PASS
Band5	1.4MHz	16QAM	20525	3RB#0	23.38	16.68	38.45	PASS
Band5	1.4MHz	16QAM	20525	3RB#1	23.37	16.67	38.45	PASS
Band5	1.4MHz	16QAM	20525	3RB#3	23.35	16.65	38.45	PASS
Band5	1.4MHz	16QAM	20525	6RB#0	22.43	15.73	38.45	PASS
Band5	1.4MHz	16QAM	20643	1RB#0	23.35	16.65	38.45	PASS
Band5	1.4MHz	16QAM	20643	1RB#2	23.55	16.85	38.45	PASS
Band5	1.4MHz	16QAM	20643	1RB#5	23.42	16.72	38.45	PASS
Band5	1.4MHz	16QAM	20643	3RB#0	23.34	16.64	38.45	PASS
Band5	1.4MHz	16QAM	20643	3RB#1	23.32	16.62	38.45	PASS
Band5	1.4MHz	16QAM	20643	3RB#3	23.33	16.63	38.45	PASS
Band5	1.4MHz	16QAM	20643	6RB#0	22.39	15.69	38.45	PASS
Band5	3MHz	QPSK	20415	1RB#0	24.29	17.59	38.45	PASS
Band5	3MHz	QPSK	20415	1RB#8	24.30	17.60	38.45	PASS
Band5	3MHz	QPSK	20415	1RB#14	24.33	17.63	38.45	PASS
Band5	3MHz	QPSK	20415	8RB#0	23.33	16.63	38.45	PASS
Band5	3MHz	QPSK	20415	8RB#4	23.34	16.64	38.45	PASS
Band5	3MHz	QPSK	20415	8RB#7	23.35	16.65	38.45	PASS
Band5	3MHz	QPSK	20415	15RB#0	23.32	16.62	38.45	PASS

Unless otherwise stated the results shown in this test report refer only to the sample(s) tested and such sample(s) are retained for 90 days only.

除非另有說明，此報告結果僅對測試之樣品負責，同時此樣品僅保留90天。本報告未經本公司書面許可，不可部份複製。

This document is issued by the Company subject to its General Conditions of Service printed overleaf, available on request or accessible at www.sgs.com/terms_and_conditions.htm and, for electronic format documents, subject to Terms and Conditions for Electronic Documents at www.sgs.com/terms_e-document.htm. Attention is drawn to the limitation of liability, indemnification and jurisdiction issues defined therein. Any holder of this document is advised that information contained hereon reflects the Company's findings at the time of its intervention only and within the limits of Client's instructions, if any. The Company's sole responsibility is to its Client and this document does not exonerate parties to a transaction from exercising all their rights and obligations under the transaction documents. This document cannot be reproduced except in full, without prior written approval of the Company. Any unauthorized alteration, forgery or falsification of the content or appearance of this document is unlawful and offenders may be prosecuted to the fullest extent of the law.

Band5	3MHz	QPSK	20525	1RB#0	24.27	17.57	38.45	PASS
Band5	3MHz	QPSK	20525	1RB#8	24.33	17.63	38.45	PASS
Band5	3MHz	QPSK	20525	1RB#14	24.29	17.59	38.45	PASS
Band5	3MHz	QPSK	20525	8RB#0	23.33	16.63	38.45	PASS
Band5	3MHz	QPSK	20525	8RB#4	23.38	16.68	38.45	PASS
Band5	3MHz	QPSK	20525	8RB#7	23.32	16.62	38.45	PASS
Band5	3MHz	QPSK	20525	15RB#0	23.34	16.64	38.45	PASS
Band5	3MHz	QPSK	20635	1RB#0	24.27	17.57	38.45	PASS
Band5	3MHz	QPSK	20635	1RB#8	24.27	17.57	38.45	PASS
Band5	3MHz	QPSK	20635	1RB#14	24.27	17.57	38.45	PASS
Band5	3MHz	QPSK	20635	8RB#0	23.32	16.62	38.45	PASS
Band5	3MHz	QPSK	20635	8RB#4	23.35	16.65	38.45	PASS
Band5	3MHz	QPSK	20635	8RB#7	23.32	16.62	38.45	PASS
Band5	3MHz	QPSK	20635	15RB#0	23.33	16.63	38.45	PASS
Band5	3MHz	16QAM	20415	1RB#0	23.33	16.63	38.45	PASS
Band5	3MHz	16QAM	20415	1RB#8	23.51	16.81	38.45	PASS
Band5	3MHz	16QAM	20415	1RB#14	23.43	16.73	38.45	PASS
Band5	3MHz	16QAM	20415	8RB#0	22.29	15.59	38.45	PASS
Band5	3MHz	16QAM	20415	8RB#4	22.31	15.61	38.45	PASS
Band5	3MHz	16QAM	20415	8RB#7	22.35	15.65	38.45	PASS
Band5	3MHz	16QAM	20415	15RB#0	22.27	15.57	38.45	PASS
Band5	3MHz	16QAM	20525	1RB#0	23.52	16.82	38.45	PASS
Band5	3MHz	16QAM	20525	1RB#8	23.43	16.73	38.45	PASS
Band5	3MHz	16QAM	20525	1RB#14	23.43	16.73	38.45	PASS
Band5	3MHz	16QAM	20525	8RB#0	22.33	15.63	38.45	PASS
Band5	3MHz	16QAM	20525	8RB#4	22.40	15.70	38.45	PASS
Band5	3MHz	16QAM	20525	8RB#7	22.37	15.67	38.45	PASS
Band5	3MHz	16QAM	20525	15RB#0	22.31	15.61	38.45	PASS
Band5	3MHz	16QAM	20635	1RB#0	23.44	16.74	38.45	PASS
Band5	3MHz	16QAM	20635	1RB#8	23.33	16.63	38.45	PASS
Band5	3MHz	16QAM	20635	1RB#14	23.42	16.72	38.45	PASS
Band5	3MHz	16QAM	20635	8RB#0	22.30	15.60	38.45	PASS
Band5	3MHz	16QAM	20635	8RB#4	22.37	15.67	38.45	PASS
Band5	3MHz	16QAM	20635	8RB#7	22.28	15.58	38.45	PASS
Band5	3MHz	16QAM	20635	15RB#0	22.29	15.59	38.45	PASS
Band5	5MHz	QPSK	20425	1RB#0	24.15	17.45	38.45	PASS
Band5	5MHz	QPSK	20425	1RB#12	24.43	17.73	38.45	PASS
Band5	5MHz	QPSK	20425	1RB#24	24.21	17.51	38.45	PASS
Band5	5MHz	QPSK	20425	12RB#0	23.29	16.59	38.45	PASS
Band5	5MHz	QPSK	20425	12RB#6	23.38	16.68	38.45	PASS
Band5	5MHz	QPSK	20425	12RB#13	23.35	16.65	38.45	PASS
Band5	5MHz	QPSK	20425	25RB#0	23.34	16.64	38.45	PASS
Band5	5MHz	QPSK	20525	1RB#0	24.20	17.50	38.45	PASS
Band5	5MHz	QPSK	20525	1RB#12	24.45	17.75	38.45	PASS
Band5	5MHz	QPSK	20525	1RB#24	24.17	17.47	38.45	PASS
Band5	5MHz	QPSK	20525	12RB#0	23.34	16.64	38.45	PASS
Band5	5MHz	QPSK	20525	12RB#6	23.36	16.66	38.45	PASS
Band5	5MHz	QPSK	20525	12RB#13	23.32	16.62	38.45	PASS
Band5	5MHz	QPSK	20525	25RB#0	23.38	16.68	38.45	PASS
Band5	5MHz	QPSK	20625	1RB#0	24.20	17.50	38.45	PASS
Band5	5MHz	QPSK	20625	1RB#12	24.42	17.72	38.45	PASS
Band5	5MHz	QPSK	20625	1RB#24	24.13	17.43	38.45	PASS

Unless otherwise stated the results shown in this test report refer only to the sample(s) tested and such sample(s) are retained for 90 days only.

除非另有說明，此報告結果僅對測試之樣品負責，同時此樣品僅保留90天。本報告未經本公司書面許可，不可部份複製。

This document is issued by the Company subject to its General Conditions of Service printed overleaf, available on request or accessible at www.sgs.com/terms_and_conditions.htm and, for electronic format documents, subject to Terms and Conditions for Electronic Documents at www.sgs.com/terms_e-document.htm. Attention is drawn to the limitation of liability, indemnification and jurisdiction issues defined therein. Any holder of this document is advised that information contained hereon reflects the Company's findings at the time of its intervention only and within the limits of Client's instructions, if any. The Company's sole responsibility is to its Client and this document does not exonerate parties to a transaction from exercising all their rights and obligations under the transaction documents. This document cannot be reproduced except in full, without prior written approval of the Company. Any unauthorized alteration, forgery or falsification of the content or appearance of this document is unlawful and offenders may be prosecuted to the fullest extent of the law.

Band5	5MHz	QPSK	20625	12RB#0	23.31	16.61	38.45	PASS
Band5	5MHz	QPSK	20625	12RB#6	23.34	16.64	38.45	PASS
Band5	5MHz	QPSK	20625	12RB#13	23.29	16.59	38.45	PASS
Band5	5MHz	QPSK	20625	25RB#0	23.32	16.62	38.45	PASS
Band5	5MHz	16QAM	20425	1RB#0	23.36	16.66	38.45	PASS
Band5	5MHz	16QAM	20425	1RB#12	23.63	16.93	38.45	PASS
Band5	5MHz	16QAM	20425	1RB#24	23.33	16.63	38.45	PASS
Band5	5MHz	16QAM	20425	12RB#0	22.27	15.57	38.45	PASS
Band5	5MHz	16QAM	20425	12RB#6	22.34	15.64	38.45	PASS
Band5	5MHz	16QAM	20425	12RB#13	22.34	15.64	38.45	PASS
Band5	5MHz	16QAM	20425	25RB#0	22.32	15.62	38.45	PASS
Band5	5MHz	16QAM	20525	1RB#0	23.44	16.74	38.45	PASS
Band5	5MHz	16QAM	20525	1RB#12	23.69	16.99	38.45	PASS
Band5	5MHz	16QAM	20525	1RB#24	23.29	16.59	38.45	PASS
Band5	5MHz	16QAM	20525	12RB#0	22.33	15.63	38.45	PASS
Band5	5MHz	16QAM	20525	12RB#6	22.34	15.64	38.45	PASS
Band5	5MHz	16QAM	20525	12RB#13	22.30	15.60	38.45	PASS
Band5	5MHz	16QAM	20525	25RB#0	22.34	15.64	38.45	PASS
Band5	5MHz	16QAM	20625	1RB#0	23.30	16.60	38.45	PASS
Band5	5MHz	16QAM	20625	1RB#12	23.52	16.82	38.45	PASS
Band5	5MHz	16QAM	20625	1RB#24	23.27	16.57	38.45	PASS
Band5	5MHz	16QAM	20625	12RB#0	22.30	15.60	38.45	PASS
Band5	5MHz	16QAM	20625	12RB#6	22.30	15.60	38.45	PASS
Band5	5MHz	16QAM	20625	12RB#13	22.26	15.56	38.45	PASS
Band5	5MHz	16QAM	20625	25RB#0	22.27	15.57	38.45	PASS
Band5	10MHz	QPSK	20450	1RB#0	24.22	17.52	38.45	PASS
Band5	10MHz	QPSK	20450	1RB#24	24.42	17.72	38.45	PASS
Band5	10MHz	QPSK	20450	1RB#49	24.29	17.59	38.45	PASS
Band5	10MHz	QPSK	20450	25RB#0	23.34	16.64	38.45	PASS
Band5	10MHz	QPSK	20450	25RB#12	23.39	16.69	38.45	PASS
Band5	10MHz	QPSK	20450	25RB#25	23.38	16.68	38.45	PASS
Band5	10MHz	QPSK	20450	50RB#0	23.37	16.67	38.45	PASS
Band5	10MHz	QPSK	20525	1RB#0	24.31	17.61	38.45	PASS
Band5	10MHz	QPSK	20525	1RB#24	24.38	17.68	38.45	PASS
Band5	10MHz	QPSK	20525	1RB#49	24.30	17.60	38.45	PASS
Band5	10MHz	QPSK	20525	25RB#0	23.42	16.72	38.45	PASS
Band5	10MHz	QPSK	20525	25RB#12	23.36	16.66	38.45	PASS
Band5	10MHz	QPSK	20525	25RB#25	23.36	16.66	38.45	PASS
Band5	10MHz	QPSK	20525	50RB#0	23.40	16.70	38.45	PASS
Band5	10MHz	QPSK	20600	1RB#0	24.26	17.56	38.45	PASS
Band5	10MHz	QPSK	20600	1RB#24	24.37	17.67	38.45	PASS
Band5	10MHz	QPSK	20600	1RB#49	24.23	17.53	38.45	PASS
Band5	10MHz	QPSK	20600	25RB#0	23.39	16.69	38.45	PASS
Band5	10MHz	QPSK	20600	25RB#12	23.39	16.69	38.45	PASS
Band5	10MHz	QPSK	20600	25RB#25	23.31	16.61	38.45	PASS
Band5	10MHz	QPSK	20600	50RB#0	23.36	16.66	38.45	PASS
Band5	10MHz	16QAM	20450	1RB#0	23.36	16.66	38.45	PASS
Band5	10MHz	16QAM	20450	1RB#24	23.61	16.91	38.45	PASS
Band5	10MHz	16QAM	20450	1RB#49	23.39	16.69	38.45	PASS
Band5	10MHz	16QAM	20450	25RB#0	22.31	15.61	38.45	PASS
Band5	10MHz	16QAM	20450	25RB#12	22.37	15.67	38.45	PASS
Band5	10MHz	16QAM	20450	25RB#25	22.33	15.63	38.45	PASS

Unless otherwise stated the results shown in this test report refer only to the sample(s) tested and such sample(s) are retained for 90 days only.

除非另有說明，此報告結果僅對測試之樣品負責，同時此樣品僅保留90天。本報告未經本公司書面許可，不可部份複製。

This document is issued by the Company subject to its General Conditions of Service printed overleaf, available on request or accessible at www.sgs.com/terms_and_conditions.htm and, for electronic format documents, subject to Terms and Conditions for Electronic Documents at www.sgs.com/terms_e-document.htm. Attention is drawn to the limitation of liability, indemnification and jurisdiction issues defined therein. Any holder of this document is advised that information contained hereon reflects the Company's findings at the time of its intervention only and within the limits of Client's instructions, if any. The Company's sole responsibility is to its Client and this document does not exonerate parties to a transaction from exercising all their rights and obligations under the transaction documents. This document cannot be reproduced except in full, without prior written approval of the Company. Any unauthorized alteration, forgery or falsification of the content or appearance of this document is unlawful and offenders may be prosecuted to the fullest extent of the law.

Band5	10MHz	16QAM	20450	50RB#0	22.35	15.65	38.45	PASS
Band5	10MHz	16QAM	20525	1RB#0	23.48	16.78	38.45	PASS
Band5	10MHz	16QAM	20525	1RB#24	23.49	16.79	38.45	PASS
Band5	10MHz	16QAM	20525	1RB#49	23.41	16.71	38.45	PASS
Band5	10MHz	16QAM	20525	25RB#0	22.38	15.68	38.45	PASS
Band5	10MHz	16QAM	20525	25RB#12	22.32	15.62	38.45	PASS
Band5	10MHz	16QAM	20525	25RB#25	22.34	15.64	38.45	PASS
Band5	10MHz	16QAM	20525	50RB#0	22.36	15.66	38.45	PASS
Band5	10MHz	16QAM	20600	1RB#0	23.39	16.69	38.45	PASS
Band5	10MHz	16QAM	20600	1RB#24	23.58	16.88	38.45	PASS
Band5	10MHz	16QAM	20600	1RB#49	23.31	16.61	38.45	PASS
Band5	10MHz	16QAM	20600	25RB#0	22.35	15.65	38.45	PASS
Band5	10MHz	16QAM	20600	25RB#12	22.39	15.69	38.45	PASS
Band5	10MHz	16QAM	20600	25RB#25	22.27	15.57	38.45	PASS
Band5	10MHz	16QAM	20600	50RB#0	22.33	15.63	38.45	PASS

6.5.5. LTE Band7 Mode:

BAND	Bandwidth	Modulation	Channel	RB Configuration	Result (dBm)	EIRP (dBm)	Limit (dBm)	Verdict
Band7	5MHz	QPSK	20775	1RB#0	23.10	23.63	33.00	PASS
Band7	5MHz	QPSK	20775	1RB#12	23.39	23.92	33.00	PASS
Band7	5MHz	QPSK	20775	1RB#24	23.02	23.55	33.00	PASS
Band7	5MHz	QPSK	20775	12RB#0	22.24	22.77	33.00	PASS
Band7	5MHz	QPSK	20775	12RB#6	22.27	22.80	33.00	PASS
Band7	5MHz	QPSK	20775	12RB#13	22.23	22.76	33.00	PASS
Band7	5MHz	QPSK	20775	25RB#0	22.23	22.76	33.00	PASS
Band7	5MHz	QPSK	21100	1RB#0	22.90	23.43	33.00	PASS
Band7	5MHz	QPSK	21100	1RB#12	23.17	23.70	33.00	PASS
Band7	5MHz	QPSK	21100	1RB#24	22.92	23.45	33.00	PASS
Band7	5MHz	QPSK	21100	12RB#0	22.07	22.60	33.00	PASS
Band7	5MHz	QPSK	21100	12RB#6	22.11	22.64	33.00	PASS
Band7	5MHz	QPSK	21100	12RB#13	22.05	22.58	33.00	PASS
Band7	5MHz	QPSK	21100	25RB#0	22.06	22.59	33.00	PASS
Band7	5MHz	QPSK	21425	1RB#0	23.05	23.58	33.00	PASS
Band7	5MHz	QPSK	21425	1RB#12	23.31	23.84	33.00	PASS
Band7	5MHz	QPSK	21425	1RB#24	23.07	23.60	33.00	PASS
Band7	5MHz	QPSK	21425	12RB#0	22.24	22.77	33.00	PASS
Band7	5MHz	QPSK	21425	12RB#6	22.28	22.81	33.00	PASS
Band7	5MHz	QPSK	21425	12RB#13	22.19	22.72	33.00	PASS
Band7	5MHz	QPSK	21425	25RB#0	22.22	22.75	33.00	PASS
Band7	5MHz	16QAM	20775	1RB#0	22.29	22.82	33.00	PASS
Band7	5MHz	16QAM	20775	1RB#12	22.46	22.99	33.00	PASS
Band7	5MHz	16QAM	20775	1RB#24	22.17	22.70	33.00	PASS
Band7	5MHz	16QAM	20775	12RB#0	21.26	21.79	33.00	PASS
Band7	5MHz	16QAM	20775	12RB#6	21.26	21.79	33.00	PASS
Band7	5MHz	16QAM	20775	12RB#13	21.25	21.78	33.00	PASS
Band7	5MHz	16QAM	20775	25RB#0	21.23	21.76	33.00	PASS
Band7	5MHz	16QAM	21100	1RB#0	22.21	22.74	33.00	PASS
Band7	5MHz	16QAM	21100	1RB#12	22.47	23.00	33.00	PASS
Band7	5MHz	16QAM	21100	1RB#24	22.15	22.68	33.00	PASS
Band7	5MHz	16QAM	21100	12RB#0	21.07	21.60	33.00	PASS

Unless otherwise stated the results shown in this test report refer only to the sample(s) tested and such sample(s) are retained for 90 days only.

除非另有說明，此報告結果僅對測試之樣品負責，同時此樣品僅保留90天。本報告未經本公司書面許可，不可部份複製。

This document is issued by the Company subject to its General Conditions of Service printed overleaf, available on request or accessible at www.sgs.com/terms_and_conditions.htm and, for electronic format documents, subject to Terms and Conditions for Electronic Documents at www.sgs.com/terms_e-document.htm. Attention is drawn to the limitation of liability, indemnification and jurisdiction issues defined therein. Any holder of this document is advised that information contained hereon reflects the Company's findings at the time of its intervention only and within the limits of Client's instructions, if any. The Company's sole responsibility is to its Client and this document does not exonerate parties to a transaction from exercising all their rights and obligations under the transaction documents. This document cannot be reproduced except in full, without prior written approval of the Company. Any unauthorized alteration, forgery or falsification of the content or appearance of this document is unlawful and offenders may be prosecuted to the fullest extent of the law.

Band7	5MHz	16QAM	21100	12RB#6	21.17	21.70	33.00	PASS
Band7	5MHz	16QAM	21100	12RB#13	21.09	21.62	33.00	PASS
Band7	5MHz	16QAM	21100	25RB#0	21.10	21.63	33.00	PASS
Band7	5MHz	16QAM	21425	1RB#0	22.31	22.84	33.00	PASS
Band7	5MHz	16QAM	21425	1RB#12	22.57	23.10	33.00	PASS
Band7	5MHz	16QAM	21425	1RB#24	22.25	22.78	33.00	PASS
Band7	5MHz	16QAM	21425	12RB#0	21.31	21.84	33.00	PASS
Band7	5MHz	16QAM	21425	12RB#6	21.34	21.87	33.00	PASS
Band7	5MHz	16QAM	21425	12RB#13	21.22	21.75	33.00	PASS
Band7	5MHz	16QAM	21425	25RB#0	21.23	21.76	33.00	PASS
Band7	10MHz	QPSK	20800	1RB#0	23.28	23.81	33.00	PASS
Band7	10MHz	QPSK	20800	1RB#24	23.30	23.83	33.00	PASS
Band7	10MHz	QPSK	20800	1RB#49	23.16	23.69	33.00	PASS
Band7	10MHz	QPSK	20800	25RB#0	22.29	22.82	33.00	PASS
Band7	10MHz	QPSK	20800	25RB#12	22.29	22.82	33.00	PASS
Band7	10MHz	QPSK	20800	25RB#25	22.28	22.81	33.00	PASS
Band7	10MHz	QPSK	20800	50RB#0	22.27	22.80	33.00	PASS
Band7	10MHz	QPSK	21100	1RB#0	23.08	23.61	33.00	PASS
Band7	10MHz	QPSK	21100	1RB#24	23.15	23.68	33.00	PASS
Band7	10MHz	QPSK	21100	1RB#49	23.04	23.57	33.00	PASS
Band7	10MHz	QPSK	21100	25RB#0	22.13	22.66	33.00	PASS
Band7	10MHz	QPSK	21100	25RB#12	22.13	22.66	33.00	PASS
Band7	10MHz	QPSK	21100	25RB#25	22.14	22.67	33.00	PASS
Band7	10MHz	QPSK	21100	50RB#0	22.17	22.70	33.00	PASS
Band7	10MHz	QPSK	21400	1RB#0	23.17	23.70	33.00	PASS
Band7	10MHz	QPSK	21400	1RB#24	23.29	23.82	33.00	PASS
Band7	10MHz	QPSK	21400	1RB#49	23.16	23.69	33.00	PASS
Band7	10MHz	QPSK	21400	25RB#0	22.28	22.81	33.00	PASS
Band7	10MHz	QPSK	21400	25RB#12	22.26	22.79	33.00	PASS
Band7	10MHz	QPSK	21400	25RB#25	22.26	22.79	33.00	PASS
Band7	10MHz	QPSK	21400	50RB#0	22.25	22.78	33.00	PASS
Band7	10MHz	16QAM	20800	1RB#0	22.42	22.95	33.00	PASS
Band7	10MHz	16QAM	20800	1RB#24	22.57	23.10	33.00	PASS
Band7	10MHz	16QAM	20800	1RB#49	22.42	22.95	33.00	PASS
Band7	10MHz	16QAM	20800	25RB#0	21.30	21.83	33.00	PASS
Band7	10MHz	16QAM	20800	25RB#12	21.30	21.83	33.00	PASS
Band7	10MHz	16QAM	20800	25RB#25	21.30	21.83	33.00	PASS
Band7	10MHz	16QAM	20800	50RB#0	21.27	21.80	33.00	PASS
Band7	10MHz	16QAM	21100	1RB#0	22.31	22.84	33.00	PASS
Band7	10MHz	16QAM	21100	1RB#24	22.43	22.96	33.00	PASS
Band7	10MHz	16QAM	21100	1RB#49	22.24	22.77	33.00	PASS
Band7	10MHz	16QAM	21100	25RB#0	21.20	21.73	33.00	PASS
Band7	10MHz	16QAM	21100	25RB#12	21.16	21.69	33.00	PASS
Band7	10MHz	16QAM	21100	25RB#25	21.16	21.69	33.00	PASS
Band7	10MHz	16QAM	21100	50RB#0	21.21	21.74	33.00	PASS
Band7	10MHz	16QAM	21400	1RB#0	22.41	22.94	33.00	PASS
Band7	10MHz	16QAM	21400	1RB#24	22.54	23.07	33.00	PASS
Band7	10MHz	16QAM	21400	1RB#49	22.48	23.01	33.00	PASS
Band7	10MHz	16QAM	21400	25RB#0	21.32	21.85	33.00	PASS
Band7	10MHz	16QAM	21400	25RB#12	21.29	21.82	33.00	PASS
Band7	10MHz	16QAM	21400	25RB#25	21.31	21.84	33.00	PASS
Band7	10MHz	16QAM	21400	50RB#0	21.29	21.82	33.00	PASS

Unless otherwise stated the results shown in this test report refer only to the sample(s) tested and such sample(s) are retained for 90 days only.

除非另有說明，此報告結果僅對測試之樣品負責，同時此樣品僅保留90天。本報告未經本公司書面許可，不可部份複製。

This document is issued by the Company subject to its General Conditions of Service printed overleaf, available on request or accessible at www.sgs.com/terms_and_conditions.htm and, for electronic format documents, subject to Terms and Conditions for Electronic Documents at www.sgs.com/terms_e-document.htm. Attention is drawn to the limitation of liability, indemnification and jurisdiction issues defined therein. Any holder of this document is advised that information contained hereon reflects the Company's findings at the time of its intervention only and within the limits of Client's instructions, if any. The Company's sole responsibility is to its Client and this document does not exonerate parties to a transaction from exercising all their rights and obligations under the transaction documents. This document cannot be reproduced except in full, without prior written approval of the Company. Any unauthorized alteration, forgery or falsification of the content or appearance of this document is unlawful and offenders may be prosecuted to the fullest extent of the law.

Band7	15MHz	QPSK	20825	1RB#0	23.27	23.80	33.00	PASS
Band7	15MHz	QPSK	20825	1RB#38	23.24	23.77	33.00	PASS
Band7	15MHz	QPSK	20825	1RB#74	23.09	23.62	33.00	PASS
Band7	15MHz	QPSK	20825	36RB#0	22.31	22.84	33.00	PASS
Band7	15MHz	QPSK	20825	36RB#18	22.29	22.82	33.00	PASS
Band7	15MHz	QPSK	20825	36RB#39	22.25	22.78	33.00	PASS
Band7	15MHz	QPSK	20825	75RB#0	22.26	22.79	33.00	PASS
Band7	15MHz	QPSK	21100	1RB#0	23.05	23.58	33.00	PASS
Band7	15MHz	QPSK	21100	1RB#38	23.10	23.63	33.00	PASS
Band7	15MHz	QPSK	21100	1RB#74	22.98	23.51	33.00	PASS
Band7	15MHz	QPSK	21100	36RB#0	22.22	22.75	33.00	PASS
Band7	15MHz	QPSK	21100	36RB#18	22.16	22.69	33.00	PASS
Band7	15MHz	QPSK	21100	36RB#39	22.14	22.67	33.00	PASS
Band7	15MHz	QPSK	21100	75RB#0	22.16	22.69	33.00	PASS
Band7	15MHz	QPSK	21375	1RB#0	23.15	23.68	33.00	PASS
Band7	15MHz	QPSK	21375	1RB#38	23.21	23.74	33.00	PASS
Band7	15MHz	QPSK	21375	1RB#74	23.11	23.64	33.00	PASS
Band7	15MHz	QPSK	21375	36RB#0	22.27	22.80	33.00	PASS
Band7	15MHz	QPSK	21375	36RB#18	22.28	22.81	33.00	PASS
Band7	15MHz	QPSK	21375	36RB#39	22.24	22.77	33.00	PASS
Band7	15MHz	QPSK	21375	75RB#0	22.24	22.77	33.00	PASS
Band7	15MHz	16QAM	20825	1RB#0	22.38	22.91	33.00	PASS
Band7	15MHz	16QAM	20825	1RB#38	22.40	22.93	33.00	PASS
Band7	15MHz	16QAM	20825	1RB#74	22.32	22.85	33.00	PASS
Band7	15MHz	16QAM	20825	36RB#0	21.30	21.83	33.00	PASS
Band7	15MHz	16QAM	20825	36RB#18	21.27	21.80	33.00	PASS
Band7	15MHz	16QAM	20825	36RB#39	21.24	21.77	33.00	PASS
Band7	15MHz	16QAM	20825	75RB#0	21.27	21.80	33.00	PASS
Band7	15MHz	16QAM	21100	1RB#0	22.19	22.72	33.00	PASS
Band7	15MHz	16QAM	21100	1RB#38	22.33	22.86	33.00	PASS
Band7	15MHz	16QAM	21100	1RB#74	22.21	22.74	33.00	PASS
Band7	15MHz	16QAM	21100	36RB#0	21.18	21.71	33.00	PASS
Band7	15MHz	16QAM	21100	36RB#18	21.17	21.70	33.00	PASS
Band7	15MHz	16QAM	21100	36RB#39	21.14	21.67	33.00	PASS
Band7	15MHz	16QAM	21100	75RB#0	21.19	21.72	33.00	PASS
Band7	15MHz	16QAM	21375	1RB#0	22.36	22.89	33.00	PASS
Band7	15MHz	16QAM	21375	1RB#38	22.44	22.97	33.00	PASS
Band7	15MHz	16QAM	21375	1RB#74	22.28	22.81	33.00	PASS
Band7	15MHz	16QAM	21375	36RB#0	21.24	21.77	33.00	PASS
Band7	15MHz	16QAM	21375	36RB#18	21.28	21.81	33.00	PASS
Band7	15MHz	16QAM	21375	36RB#39	21.27	21.80	33.00	PASS
Band7	15MHz	16QAM	21375	75RB#0	21.27	21.80	33.00	PASS
Band7	20MHz	QPSK	20850	1RB#0	23.21	23.74	33.00	PASS
Band7	20MHz	QPSK	20850	1RB#49	23.33	23.86	33.00	PASS
Band7	20MHz	QPSK	20850	1RB#99	22.96	23.49	33.00	PASS
Band7	20MHz	QPSK	20850	50RB#0	22.27	22.80	33.00	PASS
Band7	20MHz	QPSK	20850	50RB#25	22.29	22.82	33.00	PASS
Band7	20MHz	QPSK	20850	50RB#50	22.21	22.74	33.00	PASS
Band7	20MHz	QPSK	20850	100RB#0	22.23	22.76	33.00	PASS
Band7	20MHz	QPSK	21100	1RB#0	23.00	23.53	33.00	PASS
Band7	20MHz	QPSK	21100	1RB#49	23.19	23.72	33.00	PASS
Band7	20MHz	QPSK	21100	1RB#99	22.90	23.43	33.00	PASS

Unless otherwise stated the results shown in this test report refer only to the sample(s) tested and such sample(s) are retained for 90 days only.

除非另有說明，此報告結果僅對測試之樣品負責，同時此樣品僅保留90天。本報告未經本公司書面許可，不可部份複製。

This document is issued by the Company subject to its General Conditions of Service printed overleaf, available on request or accessible at www.sgs.com/terms_and_conditions.htm and, for electronic format documents, subject to Terms and Conditions for Electronic Documents at www.sgs.com/terms_e-document.htm. Attention is drawn to the limitation of liability, indemnification and jurisdiction issues defined therein. Any holder of this document is advised that information contained hereon reflects the Company's findings at the time of its intervention only and within the limits of Client's instructions, if any. The Company's sole responsibility is to its Client and this document does not exonerate parties to a transaction from exercising all their rights and obligations under the transaction documents. This document cannot be reproduced except in full, without prior written approval of the Company. Any unauthorized alteration, forgery or falsification of the content or appearance of this document is unlawful and offenders may be prosecuted to the fullest extent of the law.

Band7	20MHz	QPSK	21100	50RB#0	22.14	22.67	33.00	PASS
Band7	20MHz	QPSK	21100	50RB#25	22.17	22.70	33.00	PASS
Band7	20MHz	QPSK	21100	50RB#50	22.09	22.62	33.00	PASS
Band7	20MHz	QPSK	21100	100RB#0	22.14	22.67	33.00	PASS
Band7	20MHz	QPSK	21350	1RB#0	23.06	23.59	33.00	PASS
Band7	20MHz	QPSK	21350	1RB#49	23.27	23.80	33.00	PASS
Band7	20MHz	QPSK	21350	1RB#99	23.03	23.56	33.00	PASS
Band7	20MHz	QPSK	21350	50RB#0	22.27	22.80	33.00	PASS
Band7	20MHz	QPSK	21350	50RB#25	22.28	22.81	33.00	PASS
Band7	20MHz	QPSK	21350	50RB#50	22.18	22.71	33.00	PASS
Band7	20MHz	QPSK	21350	100RB#0	22.22	22.75	33.00	PASS
Band7	20MHz	16QAM	20850	1RB#0	22.37	22.90	33.00	PASS
Band7	20MHz	16QAM	20850	1RB#49	22.50	23.03	33.00	PASS
Band7	20MHz	16QAM	20850	1RB#99	22.14	22.67	33.00	PASS
Band7	20MHz	16QAM	20850	50RB#0	21.26	21.79	33.00	PASS
Band7	20MHz	16QAM	20850	50RB#25	21.30	21.83	33.00	PASS
Band7	20MHz	16QAM	20850	50RB#50	21.24	21.77	33.00	PASS
Band7	20MHz	16QAM	20850	100RB#0	21.27	21.80	33.00	PASS
Band7	20MHz	16QAM	21100	1RB#0	22.28	22.81	33.00	PASS
Band7	20MHz	16QAM	21100	1RB#49	22.47	23.00	33.00	PASS
Band7	20MHz	16QAM	21100	1RB#99	22.06	22.59	33.00	PASS
Band7	20MHz	16QAM	21100	50RB#0	21.17	21.70	33.00	PASS
Band7	20MHz	16QAM	21100	50RB#25	21.21	21.74	33.00	PASS
Band7	20MHz	16QAM	21100	50RB#50	21.12	21.65	33.00	PASS
Band7	20MHz	16QAM	21100	100RB#0	21.18	21.71	33.00	PASS
Band7	20MHz	16QAM	21350	1RB#0	22.25	22.78	33.00	PASS
Band7	20MHz	16QAM	21350	1RB#49	22.48	23.01	33.00	PASS
Band7	20MHz	16QAM	21350	1RB#99	22.28	22.81	33.00	PASS
Band7	20MHz	16QAM	21350	50RB#0	21.26	21.79	33.00	PASS
Band7	20MHz	16QAM	21350	50RB#25	21.28	21.81	33.00	PASS
Band7	20MHz	16QAM	21350	50RB#50	21.20	21.73	33.00	PASS
Band7	20MHz	16QAM	21350	100RB#0	21.26	21.79	33.00	PASS

6.5.6. LTE Band41 Mode:

BAND	Bandwidth	Modulation	Channel	RB Configuration	Result (dBm)	EIRP (dBm)	Limit (dBm)	Verdict
Band41	5MHz	QPSK	40065	1RB#0	24.45	25.30	33.00	PASS
Band41	5MHz	QPSK	40065	1RB#12	24.55	25.40	33.00	PASS
Band41	5MHz	QPSK	40065	1RB#24	24.41	25.26	33.00	PASS
Band41	5MHz	QPSK	40065	12RB#0	23.57	24.42	33.00	PASS
Band41	5MHz	QPSK	40065	12RB#6	23.63	24.48	33.00	PASS
Band41	5MHz	QPSK	40065	12RB#13	23.55	24.40	33.00	PASS
Band41	5MHz	QPSK	40065	25RB#0	23.56	24.41	33.00	PASS
Band41	5MHz	QPSK	40640	1RB#0	24.27	25.12	33.00	PASS
Band41	5MHz	QPSK	40640	1RB#12	24.40	25.25	33.00	PASS
Band41	5MHz	QPSK	40640	1RB#24	24.24	25.09	33.00	PASS
Band41	5MHz	QPSK	40640	12RB#0	23.41	24.26	33.00	PASS
Band41	5MHz	QPSK	40640	12RB#6	23.47	24.32	33.00	PASS
Band41	5MHz	QPSK	40640	12RB#13	23.40	24.25	33.00	PASS
Band41	5MHz	QPSK	40640	25RB#0	23.39	24.24	33.00	PASS
Band41	5MHz	QPSK	41215	1RB#0	24.00	24.85	33.00	PASS

Unless otherwise stated the results shown in this test report refer only to the sample(s) tested and such sample(s) are retained for 90 days only.

除非另有說明，此報告結果僅對測試之樣品負責，同時此樣品僅保留90天。本報告未經本公司書面許可，不可部份複製。

This document is issued by the Company subject to its General Conditions of Service printed overleaf, available on request or accessible at www.sgs.com/terms_and_conditions.htm and, for electronic format documents, subject to Terms and Conditions for Electronic Documents at www.sgs.com/terms_e-document.htm. Attention is drawn to the limitation of liability, indemnification and jurisdiction issues defined therein. Any holder of this document is advised that information contained hereon reflects the Company's findings at the time of its intervention only and within the limits of Client's instructions, if any. The Company's sole responsibility is to its Client and this document does not exonerate parties to a transaction from exercising all their rights and obligations under the transaction documents. This document cannot be reproduced except in full, without prior written approval of the Company. Any unauthorized alteration, forgery or falsification of the content or appearance of this document is unlawful and offenders may be prosecuted to the fullest extent of the law.

Band41	5MHz	QPSK	41215	1RB#12	24.08	24.93	33.00	PASS
Band41	5MHz	QPSK	41215	1RB#24	23.95	24.80	33.00	PASS
Band41	5MHz	QPSK	41215	12RB#0	23.16	24.01	33.00	PASS
Band41	5MHz	QPSK	41215	12RB#6	23.23	24.08	33.00	PASS
Band41	5MHz	QPSK	41215	12RB#13	23.13	23.98	33.00	PASS
Band41	5MHz	QPSK	41215	25RB#0	23.16	24.01	33.00	PASS
Band41	5MHz	16QAM	40065	1RB#0	23.65	24.50	33.00	PASS
Band41	5MHz	16QAM	40065	1RB#12	23.61	24.46	33.00	PASS
Band41	5MHz	16QAM	40065	1RB#24	23.67	24.52	33.00	PASS
Band41	5MHz	16QAM	40065	12RB#0	22.55	23.40	33.00	PASS
Band41	5MHz	16QAM	40065	12RB#6	22.59	23.44	33.00	PASS
Band41	5MHz	16QAM	40065	12RB#13	22.56	23.41	33.00	PASS
Band41	5MHz	16QAM	40065	25RB#0	22.47	23.32	33.00	PASS
Band41	5MHz	16QAM	40640	1RB#0	23.50	24.35	33.00	PASS
Band41	5MHz	16QAM	40640	1RB#12	23.59	24.44	33.00	PASS
Band41	5MHz	16QAM	40640	1RB#24	23.47	24.32	33.00	PASS
Band41	5MHz	16QAM	40640	12RB#0	22.37	23.22	33.00	PASS
Band41	5MHz	16QAM	40640	12RB#6	22.42	23.27	33.00	PASS
Band41	5MHz	16QAM	40640	12RB#13	22.35	23.20	33.00	PASS
Band41	5MHz	16QAM	40640	25RB#0	22.25	23.10	33.00	PASS
Band41	5MHz	16QAM	41215	1RB#0	23.28	24.13	33.00	PASS
Band41	5MHz	16QAM	41215	1RB#12	23.37	24.22	33.00	PASS
Band41	5MHz	16QAM	41215	1RB#24	23.26	24.11	33.00	PASS
Band41	5MHz	16QAM	41215	12RB#0	22.15	23.00	33.00	PASS
Band41	5MHz	16QAM	41215	12RB#6	22.23	23.08	33.00	PASS
Band41	5MHz	16QAM	41215	12RB#13	22.13	22.98	33.00	PASS
Band41	5MHz	16QAM	41215	25RB#0	22.07	22.92	33.00	PASS
Band41	10MHz	QPSK	40090	1RB#0	24.52	25.37	33.00	PASS
Band41	10MHz	QPSK	40090	1RB#24	24.60	25.45	33.00	PASS
Band41	10MHz	QPSK	40090	1RB#49	24.44	25.29	33.00	PASS
Band41	10MHz	QPSK	40090	25RB#0	23.59	24.44	33.00	PASS
Band41	10MHz	QPSK	40090	25RB#12	23.59	24.44	33.00	PASS
Band41	10MHz	QPSK	40090	25RB#25	23.57	24.42	33.00	PASS
Band41	10MHz	QPSK	40090	50RB#0	23.59	24.44	33.00	PASS
Band41	10MHz	QPSK	40640	1RB#0	24.34	25.19	33.00	PASS
Band41	10MHz	QPSK	40640	1RB#24	24.44	25.29	33.00	PASS
Band41	10MHz	QPSK	40640	1RB#49	24.30	25.15	33.00	PASS
Band41	10MHz	QPSK	40640	25RB#0	23.45	24.30	33.00	PASS
Band41	10MHz	QPSK	40640	25RB#12	23.43	24.28	33.00	PASS
Band41	10MHz	QPSK	40640	25RB#25	23.44	24.29	33.00	PASS
Band41	10MHz	QPSK	40640	50RB#0	23.45	24.30	33.00	PASS
Band41	10MHz	QPSK	41190	1RB#0	24.12	24.97	33.00	PASS
Band41	10MHz	QPSK	41190	1RB#24	24.20	25.05	33.00	PASS
Band41	10MHz	QPSK	41190	1RB#49	24.04	24.89	33.00	PASS
Band41	10MHz	QPSK	41190	25RB#0	23.30	24.15	33.00	PASS
Band41	10MHz	QPSK	41190	25RB#12	23.21	24.06	33.00	PASS
Band41	10MHz	QPSK	41190	25RB#25	23.19	24.04	33.00	PASS
Band41	10MHz	QPSK	41190	50RB#0	23.22	24.07	33.00	PASS
Band41	10MHz	16QAM	40090	1RB#0	23.65	24.50	33.00	PASS
Band41	10MHz	16QAM	40090	1RB#24	23.68	24.53	33.00	PASS
Band41	10MHz	16QAM	40090	1RB#49	23.68	24.53	33.00	PASS
Band41	10MHz	16QAM	40090	25RB#0	22.48	23.33	33.00	PASS

Unless otherwise stated the results shown in this test report refer only to the sample(s) tested and such sample(s) are retained for 90 days only.

除非另有說明，此報告結果僅對測試之樣品負責，同時此樣品僅保留90天。本報告未經本公司書面許可，不可部份複製。

This document is issued by the Company subject to its General Conditions of Service printed overleaf, available on request or accessible at www.sgs.com/terms_and_conditions.htm and, for electronic format documents, subject to Terms and Conditions for Electronic Documents at www.sgs.com/terms_e-document.htm. Attention is drawn to the limitation of liability, indemnification and jurisdiction issues defined therein. Any holder of this document is advised that information contained hereon reflects the Company's findings at the time of its intervention only and within the limits of Client's instructions, if any. The Company's sole responsibility is to its Client and this document does not exonerate parties to a transaction from exercising all their rights and obligations under the transaction documents. This document cannot be reproduced except in full, without prior written approval of the Company. Any unauthorized alteration, forgery or falsification of the content or appearance of this document is unlawful and offenders may be prosecuted to the fullest extent of the law.

Band41	10MHz	16QAM	40090	25RB#12	22.49	23.34	33.00	PASS
Band41	10MHz	16QAM	40090	25RB#25	22.48	23.33	33.00	PASS
Band41	10MHz	16QAM	40090	50RB#0	22.56	23.41	33.00	PASS
Band41	10MHz	16QAM	40640	1RB#0	23.57	24.42	33.00	PASS
Band41	10MHz	16QAM	40640	1RB#24	23.67	24.52	33.00	PASS
Band41	10MHz	16QAM	40640	1RB#49	23.51	24.36	33.00	PASS
Band41	10MHz	16QAM	40640	25RB#0	22.32	23.17	33.00	PASS
Band41	10MHz	16QAM	40640	25RB#12	22.32	23.17	33.00	PASS
Band41	10MHz	16QAM	40640	25RB#25	22.32	23.17	33.00	PASS
Band41	10MHz	16QAM	40640	50RB#0	22.41	23.26	33.00	PASS
Band41	10MHz	16QAM	41190	1RB#0	23.38	24.23	33.00	PASS
Band41	10MHz	16QAM	41190	1RB#24	23.51	24.36	33.00	PASS
Band41	10MHz	16QAM	41190	1RB#49	23.33	24.18	33.00	PASS
Band41	10MHz	16QAM	41190	25RB#0	22.19	23.04	33.00	PASS
Band41	10MHz	16QAM	41190	25RB#12	22.16	23.01	33.00	PASS
Band41	10MHz	16QAM	41190	25RB#25	22.12	22.97	33.00	PASS
Band41	10MHz	16QAM	41190	50RB#0	22.24	23.09	33.00	PASS
Band41	15MHz	QPSK	40115	1RB#0	24.44	25.29	33.00	PASS
Band41	15MHz	QPSK	40115	1RB#38	24.45	25.30	33.00	PASS
Band41	15MHz	QPSK	40115	1RB#74	24.35	25.20	33.00	PASS
Band41	15MHz	QPSK	40115	36RB#0	23.55	24.40	33.00	PASS
Band41	15MHz	QPSK	40115	36RB#18	23.53	24.38	33.00	PASS
Band41	15MHz	QPSK	40115	36RB#39	23.51	24.36	33.00	PASS
Band41	15MHz	QPSK	40115	75RB#0	23.49	24.34	33.00	PASS
Band41	15MHz	QPSK	40640	1RB#0	24.31	25.16	33.00	PASS
Band41	15MHz	QPSK	40640	1RB#38	24.30	25.15	33.00	PASS
Band41	15MHz	QPSK	40640	1RB#74	24.22	25.07	33.00	PASS
Band41	15MHz	QPSK	40640	36RB#0	23.39	24.24	33.00	PASS
Band41	15MHz	QPSK	40640	36RB#18	23.41	24.26	33.00	PASS
Band41	15MHz	QPSK	40640	36RB#39	23.38	24.23	33.00	PASS
Band41	15MHz	QPSK	40640	75RB#0	23.37	24.22	33.00	PASS
Band41	15MHz	QPSK	41165	1RB#0	24.09	24.94	33.00	PASS
Band41	15MHz	QPSK	41165	1RB#38	24.09	24.94	33.00	PASS
Band41	15MHz	QPSK	41165	1RB#74	23.97	24.82	33.00	PASS
Band41	15MHz	QPSK	41165	36RB#0	23.24	24.09	33.00	PASS
Band41	15MHz	QPSK	41165	36RB#18	23.21	24.06	33.00	PASS
Band41	15MHz	QPSK	41165	36RB#39	23.12	23.97	33.00	PASS
Band41	15MHz	QPSK	41165	75RB#0	23.19	24.04	33.00	PASS
Band41	15MHz	16QAM	40115	1RB#0	23.67	24.52	33.00	PASS
Band41	15MHz	16QAM	40115	1RB#38	23.66	24.51	33.00	PASS
Band41	15MHz	16QAM	40115	1RB#74	23.61	24.46	33.00	PASS
Band41	15MHz	16QAM	40115	36RB#0	22.47	23.32	33.00	PASS
Band41	15MHz	16QAM	40115	36RB#18	22.48	23.33	33.00	PASS
Band41	15MHz	16QAM	40115	36RB#39	22.45	23.30	33.00	PASS
Band41	15MHz	16QAM	40115	75RB#0	22.46	23.31	33.00	PASS
Band41	15MHz	16QAM	40640	1RB#0	23.52	24.37	33.00	PASS
Band41	15MHz	16QAM	40640	1RB#38	23.55	24.40	33.00	PASS
Band41	15MHz	16QAM	40640	1RB#74	23.43	24.28	33.00	PASS
Band41	15MHz	16QAM	40640	36RB#0	22.34	23.19	33.00	PASS
Band41	15MHz	16QAM	40640	36RB#18	22.34	23.19	33.00	PASS
Band41	15MHz	16QAM	40640	36RB#39	22.33	23.18	33.00	PASS
Band41	15MHz	16QAM	40640	75RB#0	22.32	23.17	33.00	PASS

Unless otherwise stated the results shown in this test report refer only to the sample(s) tested and such sample(s) are retained for 90 days only.

除非另有說明，此報告結果僅對測試之樣品負責，同時此樣品僅保留90天。本報告未經本公司書面許可，不可部份複製。

This document is issued by the Company subject to its General Conditions of Service printed overleaf, available on request or accessible at www.sgs.com/terms_and_conditions.htm and, for electronic format documents, subject to Terms and Conditions for Electronic Documents at www.sgs.com/terms_e-document.htm. Attention is drawn to the limitation of liability, indemnification and jurisdiction issues defined therein. Any holder of this document is advised that information contained hereon reflects the Company's findings at the time of its intervention only and within the limits of Client's instructions, if any. The Company's sole responsibility is to its Client and this document does not exonerate parties to a transaction from exercising all their rights and obligations under the transaction documents. This document cannot be reproduced except in full, without prior written approval of the Company. Any unauthorized alteration, forgery or falsification of the content or appearance of this document is unlawful and offenders may be prosecuted to the fullest extent of the law.

Band41	15MHz	16QAM	41165	1RB#0	23.34	24.19	33.00	PASS
Band41	15MHz	16QAM	41165	1RB#38	23.38	24.23	33.00	PASS
Band41	15MHz	16QAM	41165	1RB#74	23.25	24.10	33.00	PASS
Band41	15MHz	16QAM	41165	36RB#0	22.20	23.05	33.00	PASS
Band41	15MHz	16QAM	41165	36RB#18	22.17	23.02	33.00	PASS
Band41	15MHz	16QAM	41165	36RB#39	22.10	22.95	33.00	PASS
Band41	15MHz	16QAM	41165	75RB#0	22.15	23.00	33.00	PASS
Band41	20MHz	QPSK	40140	1RB#0	24.43	25.28	33.00	PASS
Band41	20MHz	QPSK	40140	1RB#49	24.55	25.40	33.00	PASS
Band41	20MHz	QPSK	40140	1RB#99	24.29	25.14	33.00	PASS
Band41	20MHz	QPSK	40140	50RB#0	23.56	24.41	33.00	PASS
Band41	20MHz	QPSK	40140	50RB#25	23.62	24.47	33.00	PASS
Band41	20MHz	QPSK	40140	50RB#50	23.53	24.38	33.00	PASS
Band41	20MHz	QPSK	40140	100RB#0	23.56	24.41	33.00	PASS
Band41	20MHz	QPSK	40640	1RB#0	24.30	25.15	33.00	PASS
Band41	20MHz	QPSK	40640	1RB#49	24.41	25.26	33.00	PASS
Band41	20MHz	QPSK	40640	1RB#99	24.17	25.02	33.00	PASS
Band41	20MHz	QPSK	40640	50RB#0	23.40	24.25	33.00	PASS
Band41	20MHz	QPSK	40640	50RB#25	23.45	24.30	33.00	PASS
Band41	20MHz	QPSK	40640	50RB#50	23.39	24.24	33.00	PASS
Band41	20MHz	QPSK	40640	100RB#0	23.41	24.26	33.00	PASS
Band41	20MHz	QPSK	41140	1RB#0	24.11	24.96	33.00	PASS
Band41	20MHz	QPSK	41140	1RB#49	24.18	25.03	33.00	PASS
Band41	20MHz	QPSK	41140	1RB#99	23.91	24.76	33.00	PASS
Band41	20MHz	QPSK	41140	50RB#0	23.31	24.16	33.00	PASS
Band41	20MHz	QPSK	41140	50RB#25	23.20	24.05	33.00	PASS
Band41	20MHz	QPSK	41140	50RB#50	23.07	23.92	33.00	PASS
Band41	20MHz	QPSK	41140	100RB#0	23.20	24.05	33.00	PASS
Band41	20MHz	16QAM	40140	1RB#0	23.62	24.47	33.00	PASS
Band41	20MHz	16QAM	40140	1RB#49	23.66	24.51	33.00	PASS
Band41	20MHz	16QAM	40140	1RB#99	23.48	24.33	33.00	PASS
Band41	20MHz	16QAM	40140	50RB#0	22.49	23.34	33.00	PASS
Band41	20MHz	16QAM	40140	50RB#25	22.54	23.39	33.00	PASS
Band41	20MHz	16QAM	40140	50RB#50	22.44	23.29	33.00	PASS
Band41	20MHz	16QAM	40140	100RB#0	22.51	23.36	33.00	PASS
Band41	20MHz	16QAM	40640	1RB#0	23.52	24.37	33.00	PASS
Band41	20MHz	16QAM	40640	1RB#49	23.62	24.47	33.00	PASS
Band41	20MHz	16QAM	40640	1RB#99	23.38	24.23	33.00	PASS
Band41	20MHz	16QAM	40640	50RB#0	22.37	23.22	33.00	PASS
Band41	20MHz	16QAM	40640	50RB#25	22.36	23.21	33.00	PASS
Band41	20MHz	16QAM	40640	50RB#50	22.35	23.20	33.00	PASS
Band41	20MHz	16QAM	40640	100RB#0	22.41	23.26	33.00	PASS
Band41	20MHz	16QAM	41140	1RB#0	23.36	24.21	33.00	PASS
Band41	20MHz	16QAM	41140	1RB#49	23.43	24.28	33.00	PASS
Band41	20MHz	16QAM	41140	1RB#99	23.20	24.05	33.00	PASS
Band41	20MHz	16QAM	41140	50RB#0	22.30	23.15	33.00	PASS
Band41	20MHz	16QAM	41140	50RB#25	22.18	23.03	33.00	PASS
Band41	20MHz	16QAM	41140	50RB#50	22.08	22.93	33.00	PASS
Band41	20MHz	16QAM	41140	100RB#0	22.20	23.05	33.00	PASS

Unless otherwise stated the results shown in this test report refer only to the sample(s) tested and such sample(s) are retained for 90 days only.

除非另有說明，此報告結果僅對測試之樣品負責，同時此樣品僅保留90天。本報告未經本公司書面許可，不可部份複製。

This document is issued by the Company subject to its General Conditions of Service printed overleaf, available on request or accessible at www.sgs.com/terms_and_conditions.htm and, for electronic format documents, subject to Terms and Conditions for Electronic Documents at www.sgs.com/terms_e-document.htm. Attention is drawn to the limitation of liability, indemnification and jurisdiction issues defined therein. Any holder of this document is advised that information contained hereon reflects the Company's findings at the time of its intervention only and within the limits of Client's instructions, if any. The Company's sole responsibility is to its Client and this document does not exonerate parties to a transaction from exercising all their rights and obligations under the transaction documents. This document cannot be reproduced except in full, without prior written approval of the Company. Any unauthorized alteration, forgery or falsification of the content or appearance of this document is unlawful and offenders may be prosecuted to the fullest extent of the law.

7. OCCUPIED BANDWIDTH MEASUREMENT

7.1. Standard Applicable

The occupied bandwidth is the frequency bandwidth such that, below its lower and above its upper frequency limits, the mean powers radiated are each equal to 0.5 percent of the total mean power.

7.2. Test Set-up

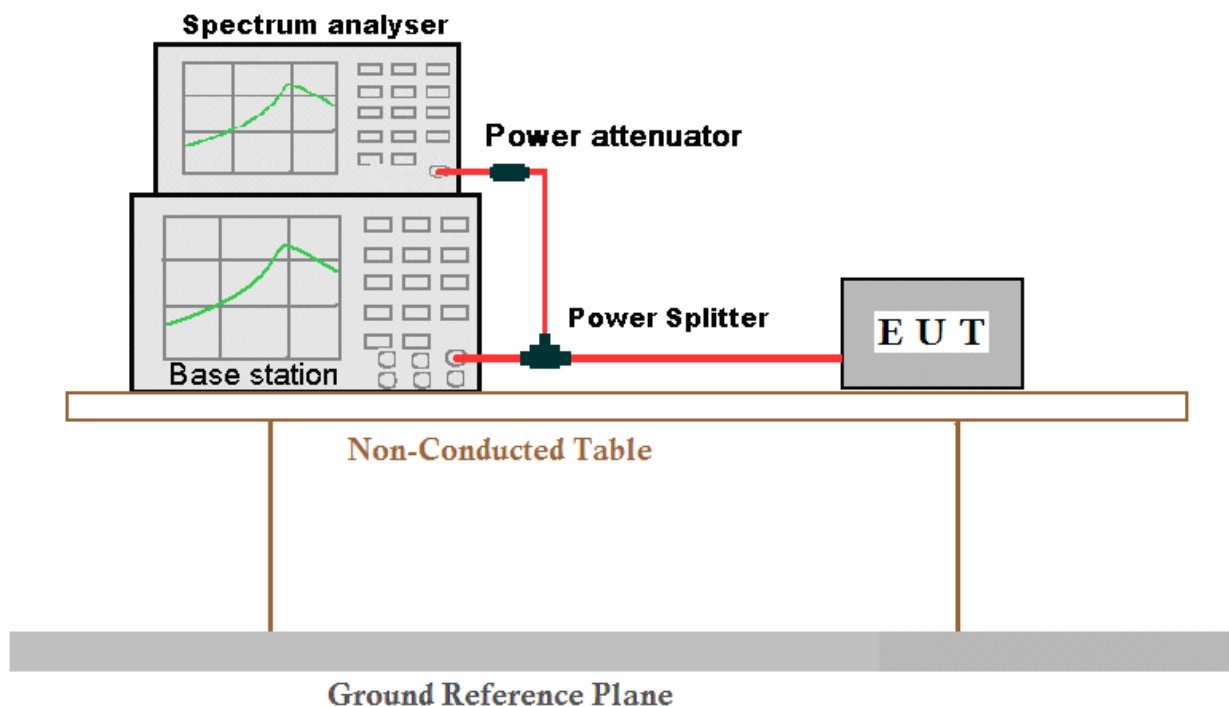

7.3. Measurement Procedure

99% &26dB Bandwidth with detector peak

The EUT's output RF connector was connected with a short cable to the spectrum analyzer, RBW was set to about 1% of emission BW, VBW= 3 times RBW, -26dBc display line was placed on the screen (or 26dB bandwidth), the occupied bandwidth is the delta frequency between the two points where the display line intersects the signal trace. Then set RBW to 99% bandwidth, RBW= 1%, VBW= 3 RBW, with span > 2 * Signal BW, set % Power = 99%.

99% Bandwidth with detector sample

The EUT's output RF connector was connected with a short cable to the spectrum analyzer, RBW was set to about 1% ~ 5% of emission BW, VBW= 3 times RBW, -20dBc display line was placed on the screen (or 20dB bandwidth). Set RBW to 99% bandwidth, RBW= 1% ~ 5%, VBW= 3 RBW, with span > 2 * Signal BW, set % Power = 99%.

Unless otherwise stated the results shown in this test report refer only to the sample(s) tested and such sample(s) are retained for 90 days only.
除非另有說明，此報告結果僅對測試之樣品負責，同時此樣品僅保留90天。本報告未經本公司書面許可，不可部份複製。

This document is issued by the Company subject to its General Conditions of Service printed overleaf, available on request or accessible at www.sgs.com/terms_and_conditions.htm and, for electronic format documents, subject to Terms and Conditions for Electronic Documents at www.sgs.com/terms_e-document.htm. Attention is drawn to the limitation of liability, indemnification and jurisdiction issues defined therein. Any holder of this document is advised that information contained hereon reflects the Company's findings at the time of its intervention only and within the limits of Client's instructions, if any. The Company's sole responsibility is to its Client and this document does not exonerate parties to a transaction from exercising all their rights and obligations under the transaction documents. This document cannot be reproduced except in full, without prior written approval of the Company. Any unauthorized alteration, forgery or falsification of the content or appearance of this document is unlawful and offenders may be prosecuted to the fullest extent of the law.

7.4. Measurement Equipment Used

RF conducted test					
Test Equipment	Manufacturer	Model No.	Inventory No.	Cal. date	Cal. Due date
				(yyyy-mm-dd)	(yyyy-mm-dd)
Dual Output Mobile Communication DC Source	Agilent Technologies Inc	66311B	W009-09	2018/9/15	2019/9/15
Signal Analyzer	Rohde & Schwarz	FSV	W025-05	2018/3/13	2019/3/12
Coaxial Cable	SGS	N/A	SEM031-01	2018/7/12	2019/7/11
Attenuator	Weinschel Associates	WA41	SEM021-09	N/A	N/A
Signal Generator	KEYSIGHT	N5173B	SEM006-05	2018/9/2	2019/9/2
Humidity/ Temperature Indicator	Shanghai Meteorological Industry Factory	HTC-1	W006-17	2018/9/10	2019/9/10
Temperature Chamber	GIANT FORCE	ICT-150-40-CP-AR	W027-03	2017/12/4	2018/12/4
Wideband Radio Communication Tester	Anristu	MT8821C	6201462742	2018/5/2	2019/5/1
Wideband Radio Communication Tester	Rohde & Schwarz	CMW500	W005-02	2018/3/13	2019/3/12

Unless otherwise stated the results shown in this test report refer only to the sample(s) tested and such sample(s) are retained for 90 days only.
 除非另有說明，此報告結果僅對測試之樣品負責，同時此樣品僅保留90天。本報告未經本公司書面許可，不可部份複製。

This document is issued by the Company subject to its General Conditions of Service printed overleaf, available on request or accessible at www.sgs.com/terms_and_conditions.htm and, for electronic format documents, subject to Terms and Conditions for Electronic Documents at www.sgs.com/terms_e-document.htm. Attention is drawn to the limitation of liability, indemnification and jurisdiction issues defined therein. Any holder of this document is advised that information contained hereon reflects the Company's findings at the time of its intervention only and within the limits of Client's instructions, if any. The Company's sole responsibility is to its Client and this document does not exonerate parties to a transaction from exercising all their rights and obligations under the transaction documents. This document cannot be reproduced except in full, without prior written approval of the Company. Any unauthorized alteration, forgery or falsification of the content or appearance of this document is unlawful and offenders may be prosecuted to the fullest extent of the law.

7.5. Measurement Result

7.5.1. Measurement Result: GSM

7.5.1.1. Test Result

BAND	Channel	Occupied Bandwidth (kHz)	26dB Bandwidth (kHz)	Limit(kHz)	Verdict
GSM850	128	247.47	307.25	---	PASS
GSM850	190	244.57	301.45	---	PASS
GSM850	251	246.02	313.04	---	PASS
EGPRS850	128	248.91	289.86	---	PASS
EGPRS850	190	247.47	300.00	---	PASS
EGPRS850	251	244.57	302.90	---	PASS
GSM1900	512	243.13	282.61	---	PASS
GSM1900	661	247.47	305.80	---	PASS
GSM1900	810	243.13	302.90	---	PASS
EGPRS1900	512	254.70	317.39	---	PASS
EGPRS1900	661	251.81	315.94	---	PASS
EGPRS1900	810	254.70	300.00	---	PASS

7.5.1.2. Test Plots

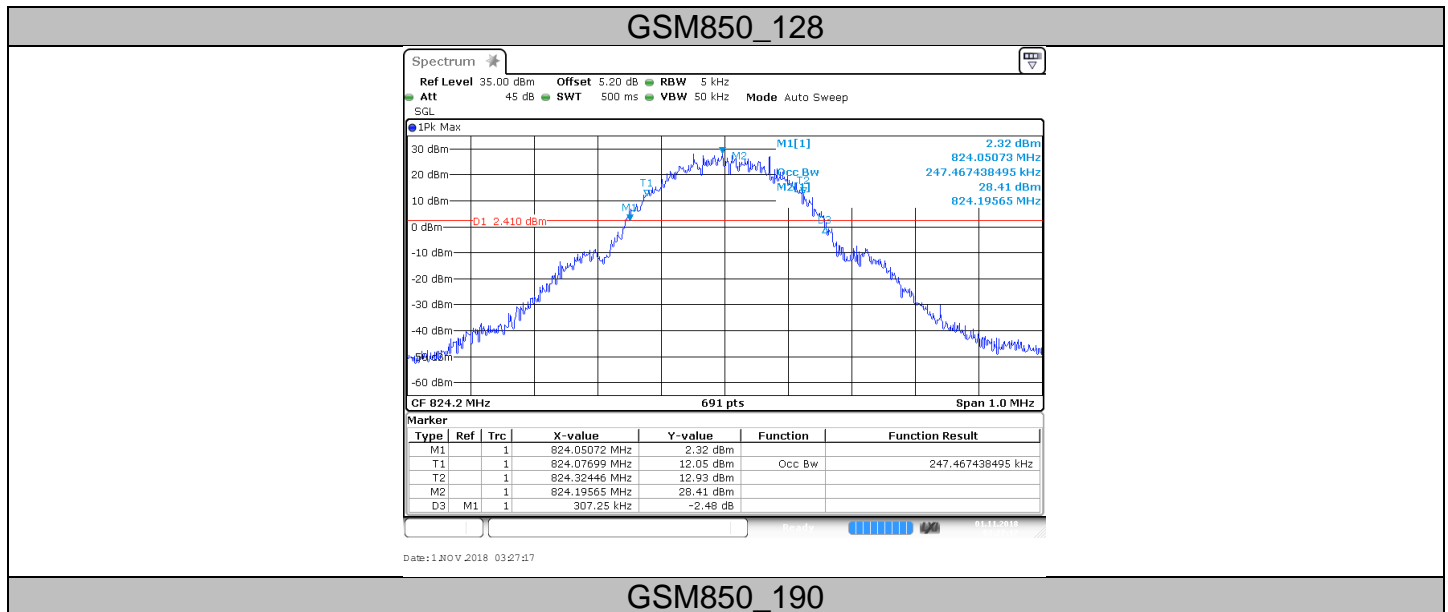

GSM850_190

Unless otherwise stated the results shown in this test report refer only to the sample(s) tested and such sample(s) are retained for 90 days only.
除非另有說明，此報告結果僅對測試之樣品負責，同時此樣品僅保留90天。本報告未經本公司書面許可，不可部份複製。

This document is issued by the Company subject to its General Conditions of Service printed overleaf, available on request or accessible at www.sgs.com/terms_and_conditions.htm and, for electronic format documents, subject to Terms and Conditions for Electronic Documents at www.sgs.com/terms_e-document.htm. Attention is drawn to the limitation of liability, indemnification and jurisdiction issues defined therein. Any holder of this document is advised that information contained hereon reflects the Company's findings at the time of its intervention only and within the limits of Client's instructions, if any. The Company's sole responsibility is to its Client and this document does not exonerate parties to a transaction from exercising all their rights and obligations under the transaction documents. This document cannot be reproduced except in full, without prior written approval of the Company. Any unauthorized alteration, forgery or falsification of the content or appearance of this document is unlawful and offenders may be prosecuted to the fullest extent of the law.

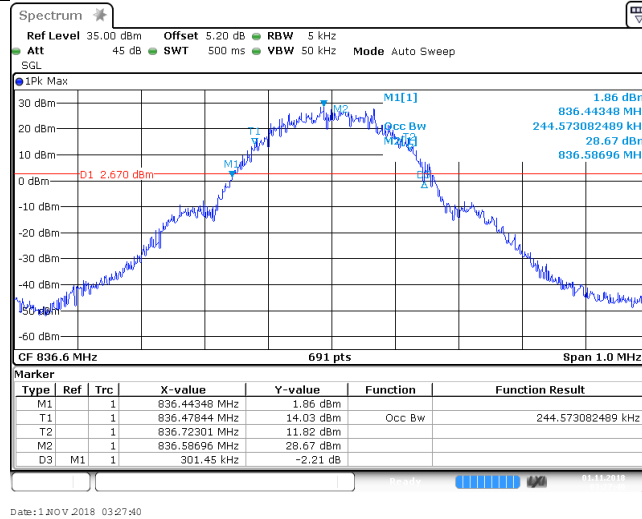

GSM850_251

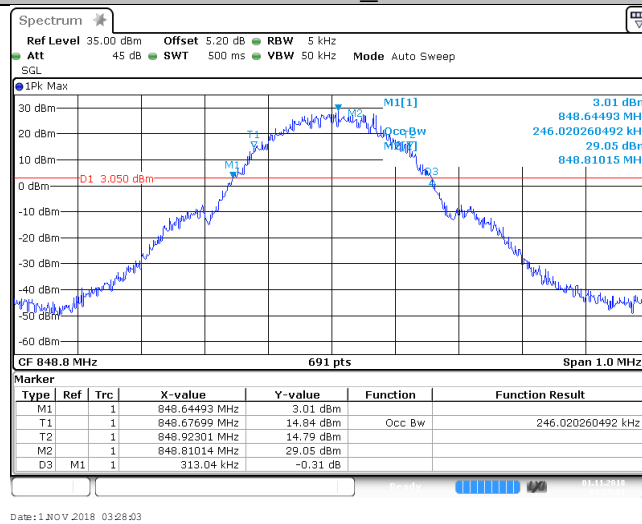

EGPRS850_128

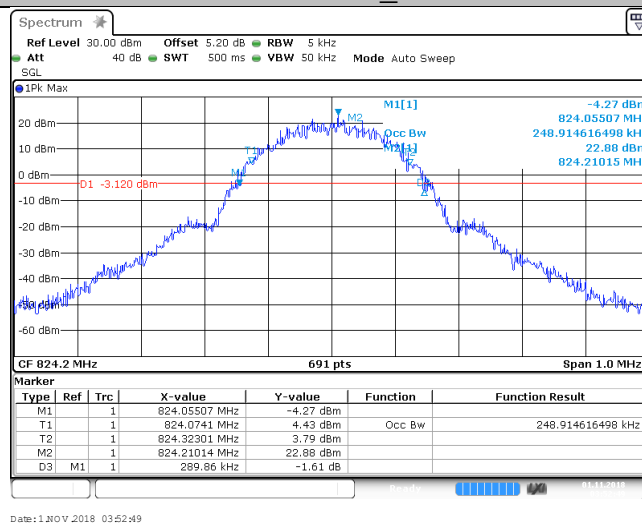

EGPRS850_190

Unless otherwise stated the results shown in this test report refer only to the sample(s) tested and such sample(s) are retained for 90 days only.

除非另有說明，此報告結果僅對測試之樣品負責，同時此樣品僅保留90天。本報告未經本公司書面許可，不可部份複製。

This document is issued by the Company subject to its General Conditions of Service printed overleaf, available on request or accessible at www.sgs.com/terms_and_conditions.htm and, for electronic format documents, subject to Terms and Conditions for Electronic Documents at www.sgs.com/terms_e-document.htm. Attention is drawn to the limitation of liability, indemnification and jurisdiction issues defined therein. Any holder of this document is advised that information contained hereon reflects the Company's findings at the time of its intervention only and within the limits of Client's instructions, if any. The Company's sole responsibility is to its Client and this document does not exonerate parties to a transaction from exercising all their rights and obligations under the transaction documents. This document cannot be reproduced except in full, without prior written approval of the Company. Any unauthorized alteration, forgery or falsification of the content or appearance of this document is unlawful and offenders may be prosecuted to the fullest extent of the law.

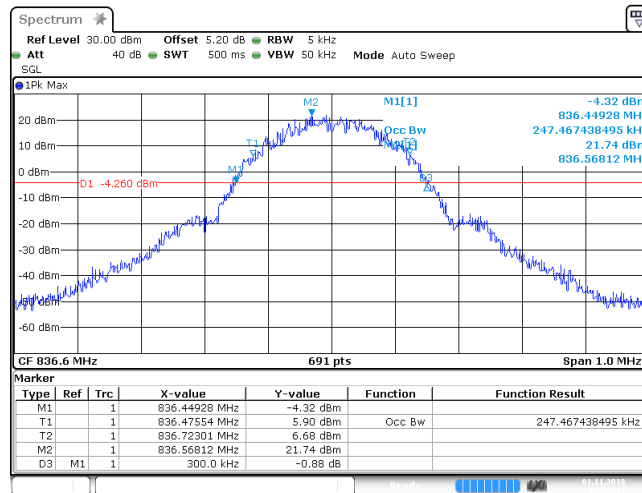

Date: 1 NOV 2018 03:53:13

EGPRS850_251

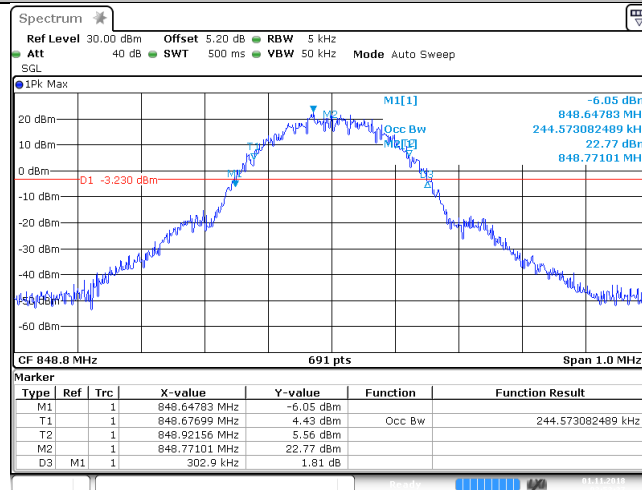

Date: 1 NOV 2018 03:53:38

GSM1900_512

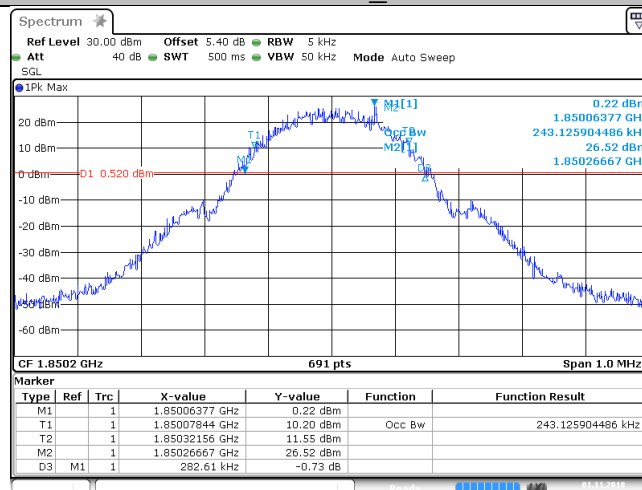

Date: 1 NOV 2018 03:34:27

GSM1900_661

Unless otherwise stated the results shown in this test report refer only to the sample(s) tested and such sample(s) are retained for 90 days only.
 除非另有說明，此報告結果僅對測試之樣品負責，同時此樣品僅保留90天。本報告未經本公司書面許可，不可部份複製。

This document is issued by the Company subject to its General Conditions of Service printed overleaf, available on request or accessible at www.sgs.com/terms_and_conditions.htm and, for electronic format documents, subject to Terms and Conditions for Electronic Documents at www.sgs.com/terms_e-document.htm. Attention is drawn to the limitation of liability, indemnification and jurisdiction issues defined therein. Any holder of this document is advised that information contained hereon reflects the Company's findings at the time of its intervention only and within the limits of Client's instructions, if any. The Company's sole responsibility is to its Client and this document does not exonerate parties to a transaction from exercising all their rights and obligations under the transaction documents. This document cannot be reproduced except in full, without prior written approval of the Company. Any unauthorized alteration, forgery or falsification of the content or appearance of this document is unlawful and offenders may be prosecuted to the fullest extent of the law.

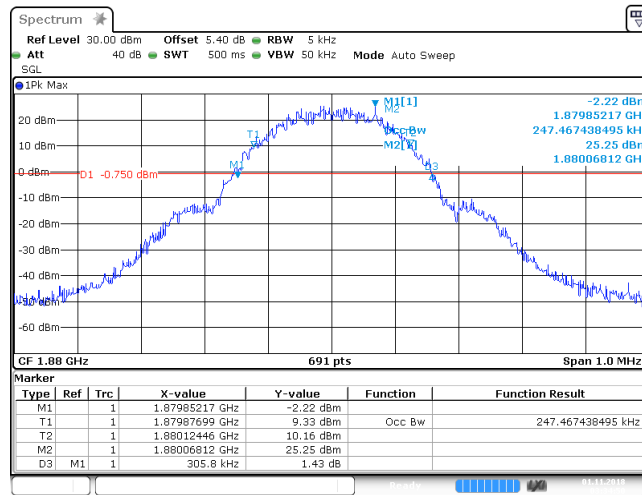

Date: 1 NOV 2018 03:24:50

GSM1900_810

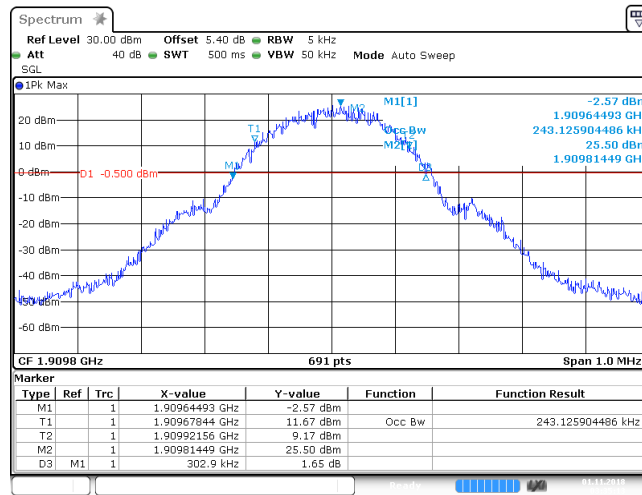

Date: 1 NOV 2018 03:25:13

EGPRS1900_512

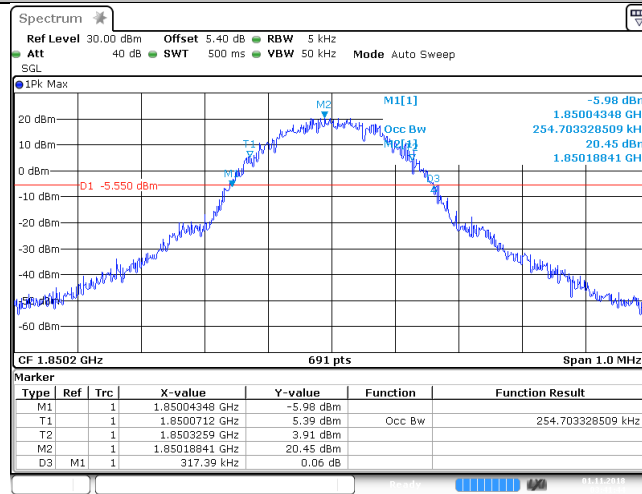

Date: 1 NOV 2018 03:41:44

Unless otherwise stated the results shown in this test report refer only to the sample(s) tested and such sample(s) are retained for 90 days only.
除非另有說明，此報告結果僅對測試之樣品負責，同時此樣品僅保留90天。本報告未經本公司書面許可，不可部份複製。

This document is issued by the Company subject to its General Conditions of Service printed overleaf, available on request or accessible at www.sgs.com/terms_and_conditions.htm and, for electronic format documents, subject to Terms and Conditions for Electronic Documents at www.sgs.com/terms_e-document.htm. Attention is drawn to the limitation of liability, indemnification and jurisdiction issues defined therein. Any holder of this document is advised that information contained hereon reflects the Company's findings at the time of its intervention only and within the limits of Client's instructions, if any. The Company's sole responsibility is to its Client and this document does not exonerate parties to a transaction from exercising all their rights and obligations under the transaction documents. This document cannot be reproduced except in full, without prior written approval of the Company. Any unauthorized alteration, forgery or falsification of the content or appearance of this document is unlawful and offenders may be prosecuted to the fullest extent of the law.

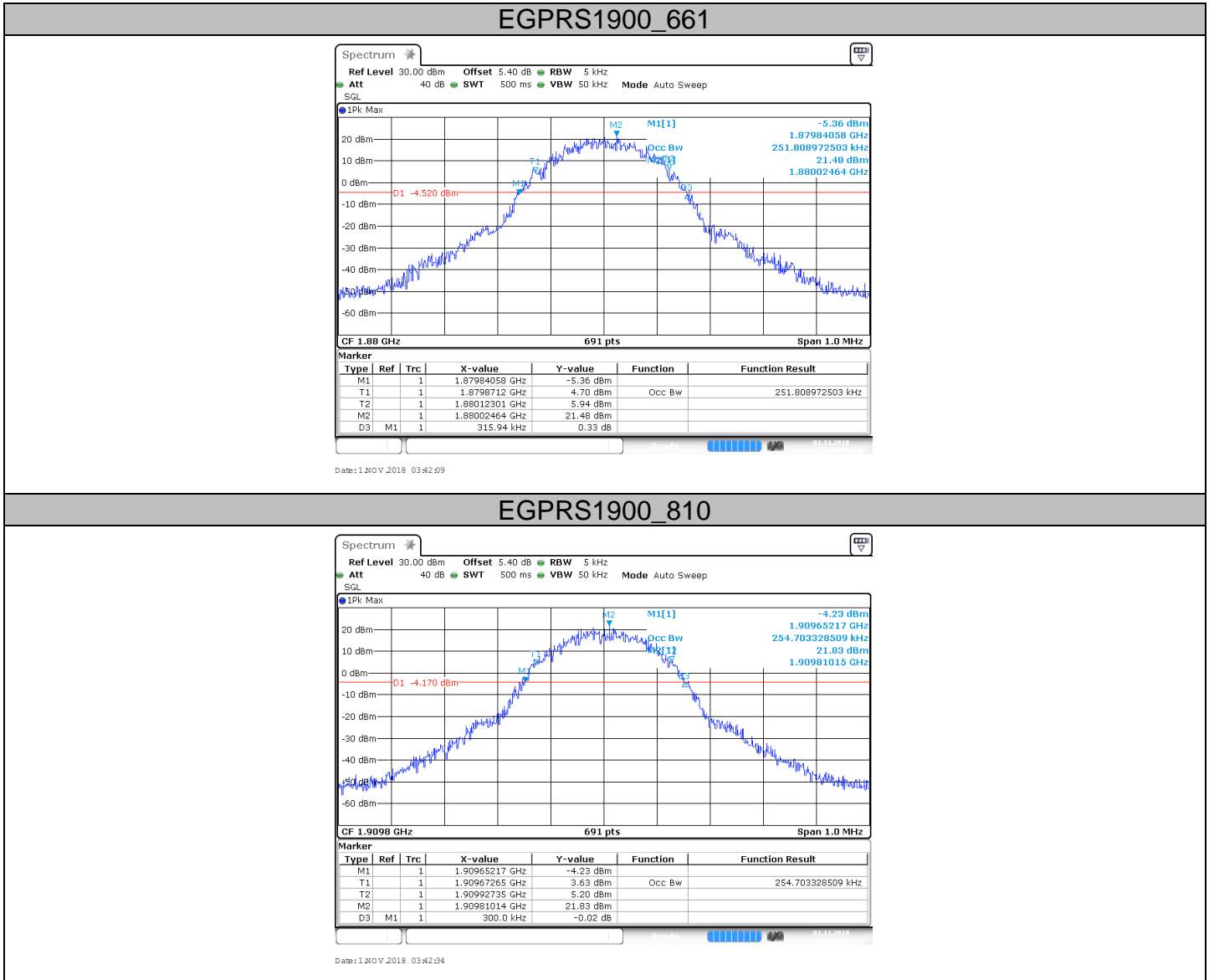

7.5.2. Measurement Result: WCDMA Band II

7.5.2.1. Test Result

BAND	Channel	Modulation	Occupied Bandwidth (kHz)	26dB Bandwidth (kHz)	Limit(kHz)	Verdict
Band II	9262	QPSK	4167.87	4753.60	---	PASS
Band II	9400	QPSK	4153.40	4724.60	---	PASS
Band II	9538	QPSK	4167.87	4753.60	---	PASS
Band II	9262	16QAM	4167.87	4739.10	---	PASS
Band II	9400	16QAM	4167.87	4724.60	---	PASS
Band II	9538	16QAM	4167.87	4724.60	---	PASS
Band V	4132	QPSK	4167.87	4724.60	---	PASS
Band V	4182	QPSK	4153.40	4724.60	---	PASS
Band V	4233	QPSK	4167.87	4724.60	---	PASS

Unless otherwise stated the results shown in this test report refer only to the sample(s) tested and such sample(s) are retained for 90 days only.
除非另有說明，此報告結果僅對測試之樣品負責，同時此樣品僅保留90天。本報告未經本公司書面許可，不可部份複製。

This document is issued by the Company subject to its General Conditions of Service printed overleaf, available on request or accessible at www.sgs.com/terms_and_conditions.htm and, for electronic format documents, subject to Terms and Conditions for Electronic Documents at www.sgs.com/terms_e-document.htm. Attention is drawn to the limitation of liability, indemnification and jurisdiction issues defined therein. Any holder of this document is advised that information contained hereon reflects the Company's findings at the time of its intervention only and within the limits of Client's instructions, if any. The Company's sole responsibility is to its Client and this document does not exonerate parties to a transaction from exercising all their rights and obligations under the transaction documents. This document cannot be reproduced except in full, without prior written approval of the Company. Any unauthorized alteration, forgery or falsification of the content or appearance of this document is unlawful and offenders may be prosecuted to the fullest extent of the law.

Band V	4132	16QAM	4196.82	4739.10	---	PASS
Band V	4182	16QAM	4182.34	4739.10	---	PASS
Band V	4233	16QAM	4182.34	4739.10	---	PASS

7.5.2.2. Test Plots of WCDMA Band II

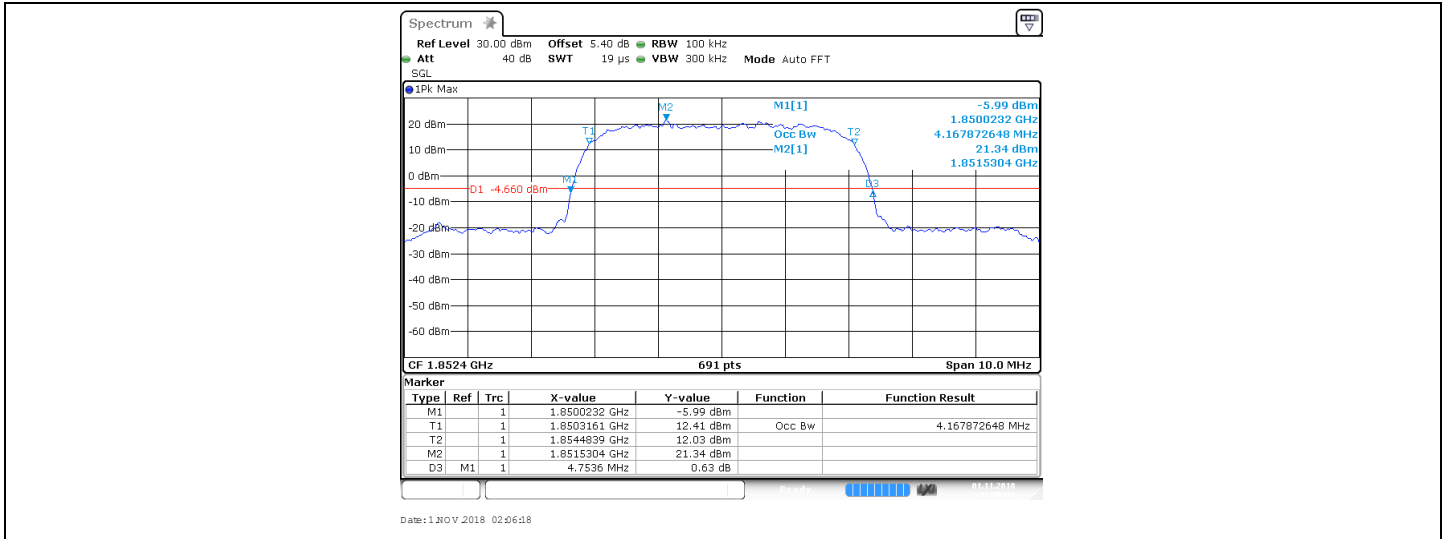

Band II_QPSK_9262

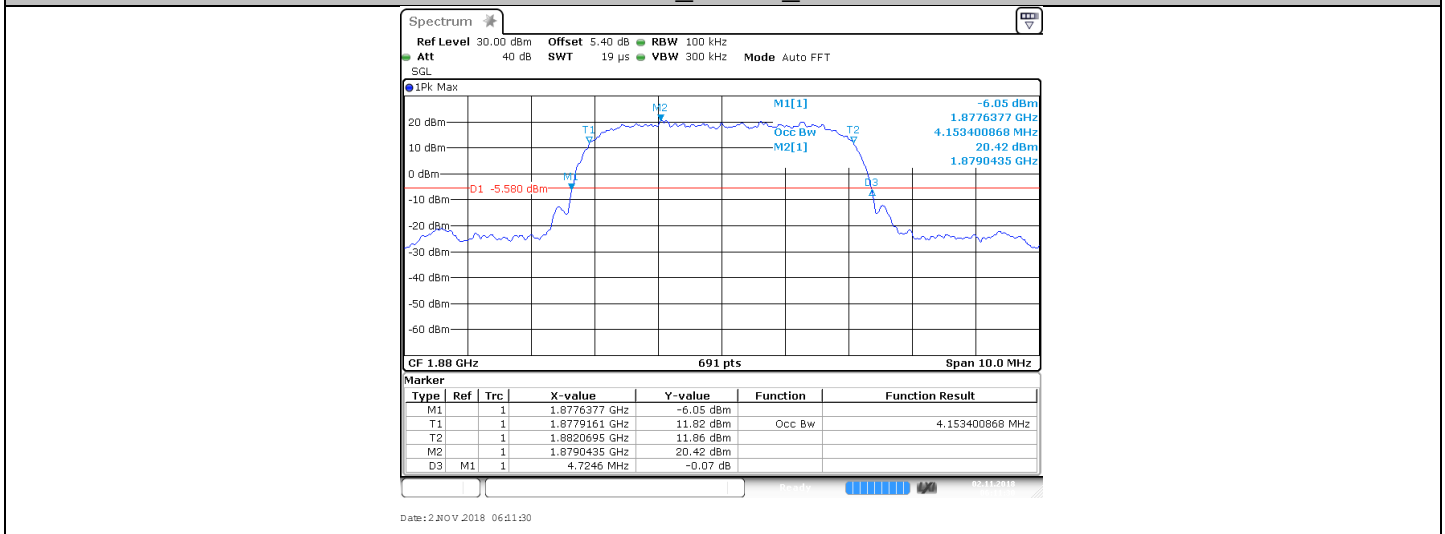

Band II_QPSK_9400

Unless otherwise stated the results shown in this test report refer only to the sample(s) tested and such sample(s) are retained for 90 days only.
除非另有說明，此報告結果僅對測試之樣品負責，同時此樣品僅保留90天。本報告未經本公司書面許可，不可部份複製。

This document is issued by the Company subject to its General Conditions of Service printed overleaf, available on request or accessible at www.sgs.com/terms_and_conditions.htm and, for electronic format documents, subject to Terms and Conditions for Electronic Documents at www.sgs.com/terms_e-document.htm. Attention is drawn to the limitation of liability, indemnification and jurisdiction issues defined therein. Any holder of this document is advised that information contained hereon reflects the Company's findings at the time of its intervention only and within the limits of Client's instructions, if any. The Company's sole responsibility is to its Client and this document does not exonerate parties to a transaction from exercising all their rights and obligations under the transaction documents. This document cannot be reproduced except in full, without prior written approval of the Company. Any unauthorized alteration, forgery or falsification of the content or appearance of this document is unlawful and offenders may be prosecuted to the fullest extent of the law.

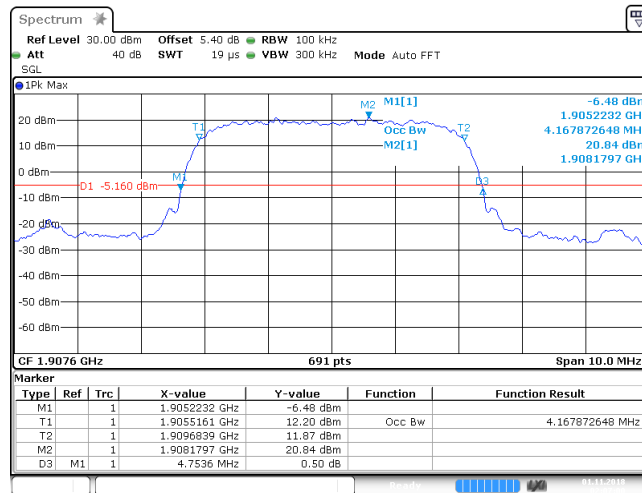

Date: 13 NOV 2018 02:07:00

Band II_QPSK_9538

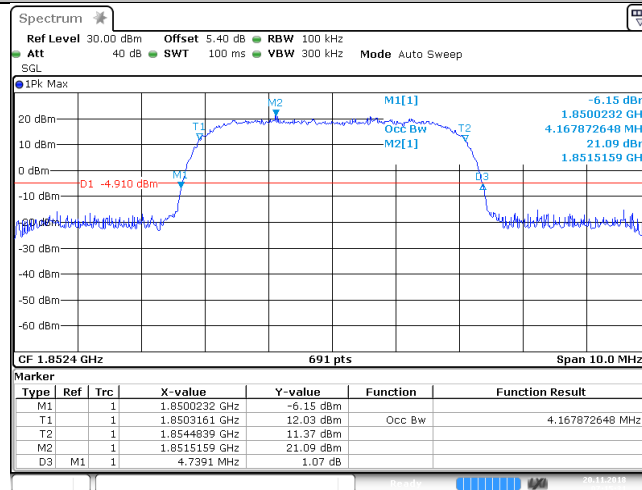

Date: 20 NOV 2018 07:15:31

Band II_16QAM_9262

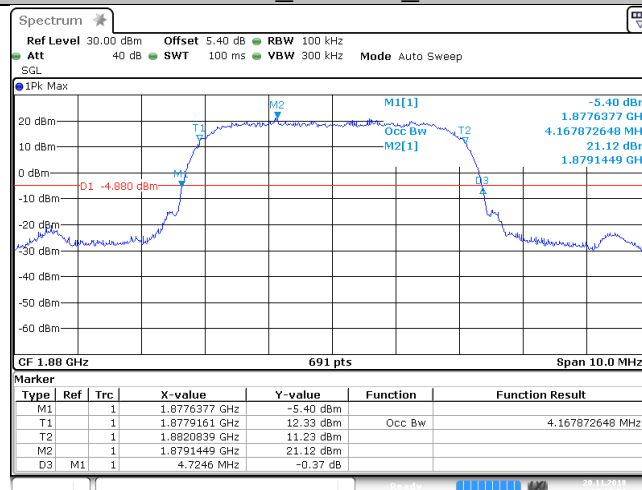

Date: 20 NOV 2018 07:15:54

Band II_16QAM_9400

Unless otherwise stated the results shown in this test report refer only to the sample(s) tested and such sample(s) are retained for 90 days only.
除非另有說明，此報告結果僅對測試之樣品負責，同時此樣品僅保留90天。本報告未經本公司書面許可，不可部份複製。

This document is issued by the Company subject to its General Conditions of Service printed overleaf, available on request or accessible at www.sgs.com/terms_and_conditions.htm and, for electronic format documents, subject to Terms and Conditions for Electronic Documents at www.sgs.com/terms_e-document.htm. Attention is drawn to the limitation of liability, indemnification and jurisdiction issues defined therein. Any holder of this document is advised that information contained hereon reflects the Company's findings at the time of its intervention only and within the limits of Client's instructions, if any. The Company's sole responsibility is to its Client and this document does not exonerate parties to a transaction from exercising all their rights and obligations under the transaction documents. This document cannot be reproduced except in full, without prior written approval of the Company. Any unauthorized alteration, forgery or falsification of the content or appearance of this document is unlawful and offenders may be prosecuted to the fullest extent of the law.

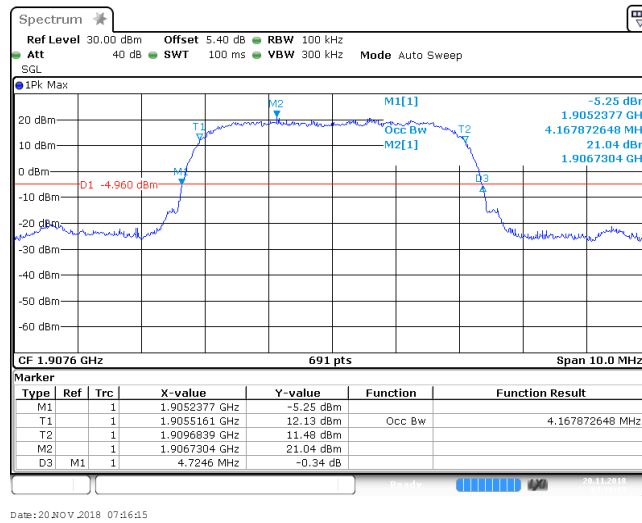

Band II_16QAM_9538

7.5.2.3. Test Result of WCDMA Band V

7.5.2.4. Test Plots

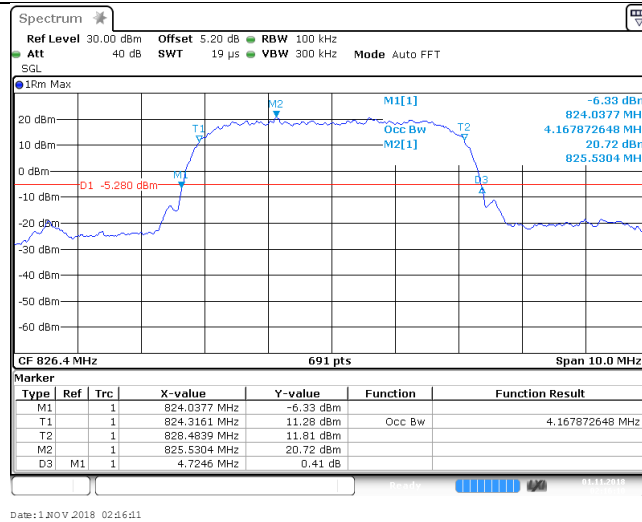

Band V_QPSK_4132

Unless otherwise stated the results shown in this test report refer only to the sample(s) tested and such sample(s) are retained for 90 days only.
除非另有說明，此報告結果僅對測試之樣品負責，同時此樣品僅保留90天。本報告未經本公司書面許可，不可部份複製。

This document is issued by the Company subject to its General Conditions of Service printed overleaf, available on request or accessible at www.sgs.com/terms_and_conditions.htm and, for electronic format documents, subject to Terms and Conditions for Electronic Documents at www.sgs.com/terms_e-document.htm. Attention is drawn to the limitation of liability, indemnification and jurisdiction issues defined therein. Any holder of this document is advised that information contained hereon reflects the Company's findings at the time of its intervention only and within the limits of Client's instructions, if any. The Company's sole responsibility is to its Client and this document does not exonerate parties to a transaction from exercising all their rights and obligations under the transaction documents. This document cannot be reproduced except in full, without prior written approval of the Company. Any unauthorized alteration, forgery or falsification of the content or appearance of this document is unlawful and offenders may be prosecuted to the fullest extent of the law.

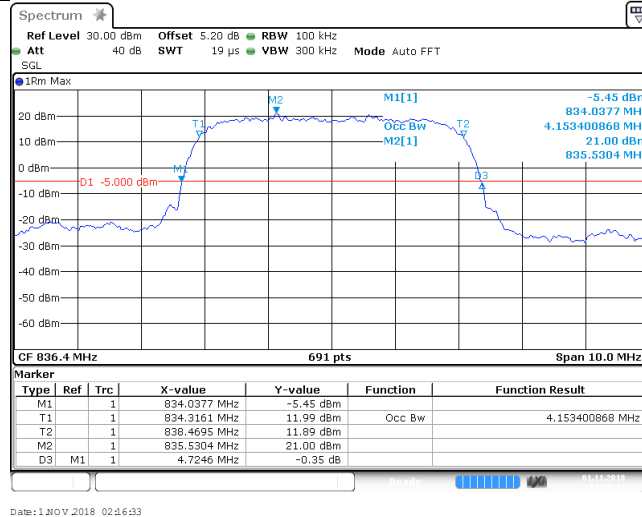

Band V_QPSK_4182

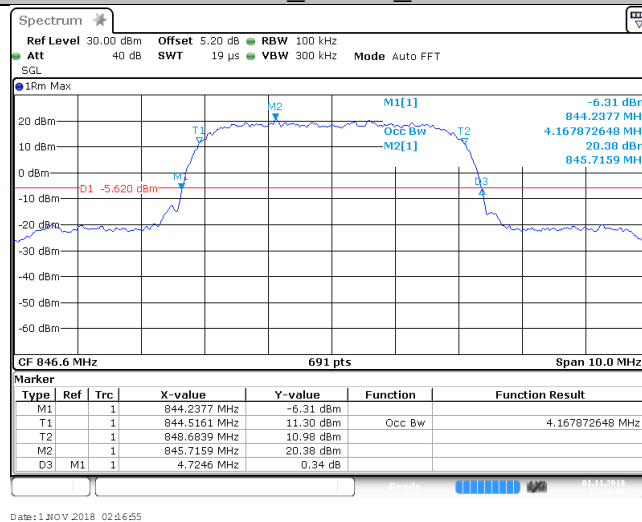

Band V_QPSK_4233

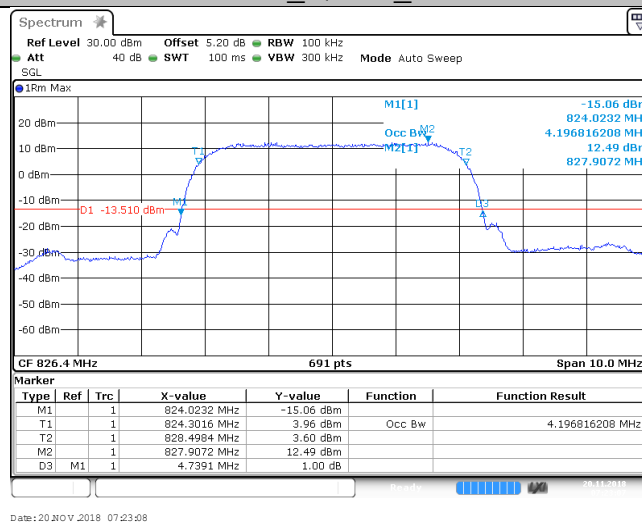

Band V_16QAM_4132

Unless otherwise stated the results shown in this test report refer only to the sample(s) tested and such sample(s) are retained for 90 days only.
除非另有說明，此報告結果僅對測試之樣品負責，同時此樣品僅保留90天。本報告未經本公司書面許可，不可部份複製。

This document is issued by the Company subject to its General Conditions of Service printed overleaf, available on request or accessible at www.sgs.com/terms_and_conditions.htm and, for electronic format documents, subject to Terms and Conditions for Electronic Documents at www.sgs.com/terms_e-document.htm. Attention is drawn to the limitation of liability, indemnification and jurisdiction issues defined therein. Any holder of this document is advised that information contained hereon reflects the Company's findings at the time of its intervention only and within the limits of Client's instructions, if any. The Company's sole responsibility is to its Client and this document does not exonerate parties to a transaction from exercising all their rights and obligations under the transaction documents. This document cannot be reproduced except in full, without prior written approval of the Company. Any unauthorized alteration, forgery or falsification of the content or appearance of this document is unlawful and offenders may be prosecuted to the fullest extent of the law.

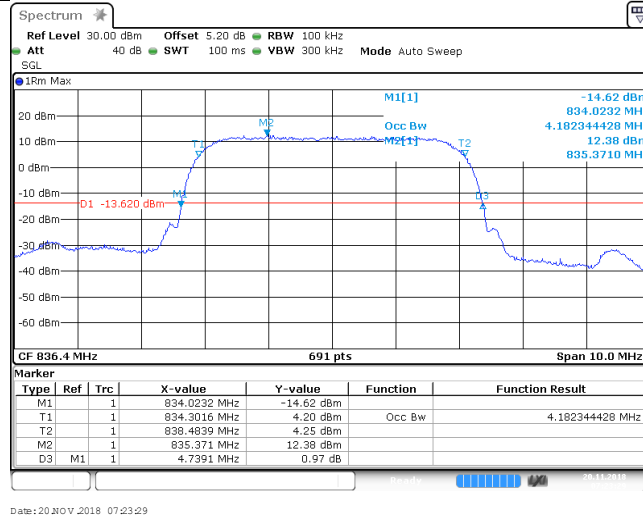

Band V_16QAM_4182

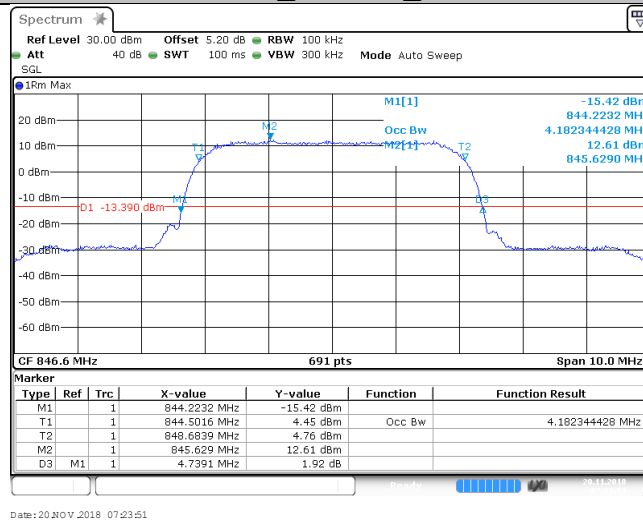

Band V_16QAM_4233

Unless otherwise stated the results shown in this test report refer only to the sample(s) tested and such sample(s) are retained for 90 days only.
除非另有說明，此報告結果僅對測試之樣品負責，同時此樣品僅保留90天。本報告未經本公司書面許可，不可部份複製。

This document is issued by the Company subject to its General Conditions of Service printed overleaf, available on request or accessible at www.sgs.com/terms_and_conditions.htm and, for electronic format documents, subject to Terms and Conditions for Electronic Documents at www.sgs.com/terms_e-document.htm. Attention is drawn to the limitation of liability, indemnification and jurisdiction issues defined therein. Any holder of this document is advised that information contained hereon reflects the Company's findings at the time of its intervention only and within the limits of Client's instructions, if any. The Company's sole responsibility is to its Client and this document does not exonerate parties to a transaction from exercising all their rights and obligations under the transaction documents. This document cannot be reproduced except in full, without prior written approval of the Company. Any unauthorized alteration, forgery or falsification of the content or appearance of this document is unlawful and offenders may be prosecuted to the fullest extent of the law.

7.5.3. Measurement Result: LTE Band 2 Mode

7.5.3.1. Test Result

BAND	Bandwidth	Modulation	Channel	RB Configuration	Occupied Bandwidth (MHz)	26dB Bandwidth (MHz)	Verdict
Band2	1.4MHz	QPSK	18607	6RB#0	1.088	1.278	PASS
Band2	1.4MHz	QPSK	18900	6RB#0	1.088	1.287	PASS
Band2	1.4MHz	QPSK	19193	6RB#0	1.088	1.284	PASS
Band2	1.4MHz	16QAM	18607	6RB#0	1.091	1.284	PASS
Band2	1.4MHz	16QAM	18900	6RB#0	1.091	1.290	PASS
Band2	1.4MHz	16QAM	19193	6RB#0	1.088	1.293	PASS
Band2	3MHz	QPSK	18615	15RB#0	2.691	2.928	PASS
Band2	3MHz	QPSK	18900	15RB#0	2.691	2.916	PASS
Band2	3MHz	QPSK	19185	15RB#0	2.691	2.922	PASS
Band2	3MHz	16QAM	18615	15RB#0	2.673	2.904	PASS
Band2	3MHz	16QAM	18900	15RB#0	2.679	2.904	PASS
Band2	3MHz	16QAM	19185	15RB#0	2.679	2.898	PASS
Band2	5MHz	QPSK	18625	25RB#0	4.466	4.830	PASS
Band2	5MHz	QPSK	18900	25RB#0	4.466	4.840	PASS
Band2	5MHz	QPSK	19175	25RB#0	4.466	4.830	PASS
Band2	5MHz	16QAM	18625	25RB#0	4.486	4.820	PASS
Band2	5MHz	16QAM	18900	25RB#0	4.476	4.850	PASS
Band2	5MHz	16QAM	19175	25RB#0	4.486	4.860	PASS
Band2	10MHz	QPSK	18650	50RB#0	8.931	9.740	PASS
Band2	10MHz	QPSK	18900	50RB#0	8.931	9.640	PASS
Band2	10MHz	QPSK	19150	50RB#0	8.931	9.620	PASS
Band2	10MHz	16QAM	18650	50RB#0	8.911	9.600	PASS
Band2	10MHz	16QAM	18900	50RB#0	8.931	9.640	PASS
Band2	10MHz	16QAM	19150	50RB#0	8.951	9.620	PASS
Band2	15MHz	QPSK	18675	75RB#0	13.457	14.670	PASS
Band2	15MHz	QPSK	18900	75RB#0	13.457	14.670	PASS
Band2	15MHz	QPSK	19125	75RB#0	13.487	14.700	PASS
Band2	15MHz	16QAM	18675	75RB#0	13.427	14.700	PASS
Band2	15MHz	16QAM	18900	75RB#0	13.457	14.640	PASS
Band2	15MHz	16QAM	19125	75RB#0	13.457	14.700	PASS
Band2	20MHz	QPSK	18700	100RB#0	17.862	20.520	PASS
Band2	20MHz	QPSK	18900	100RB#0	17.902	19.320	PASS
Band2	20MHz	QPSK	19100	100RB#0	17.902	19.320	PASS
Band2	20MHz	16QAM	18700	100RB#0	17.862	19.840	PASS
Band2	20MHz	16QAM	18900	100RB#0	17.902	19.360	PASS
Band2	20MHz	16QAM	19100	100RB#0	17.902	19.280	PASS

Unless otherwise stated the results shown in this test report refer only to the sample(s) tested and such sample(s) are retained for 90 days only.
 除非另有說明，此報告結果僅對測試之樣品負責，同時此樣品僅保留90天。本報告未經本公司書面許可，不可部份複製。

This document is issued by the Company subject to its General Conditions of Service printed overleaf, available on request or accessible at www.sgs.com/terms_and_conditions.htm and, for electronic format documents, subject to Terms and Conditions for Electronic Documents at www.sgs.com/terms_e-document.htm. Attention is drawn to the limitation of liability, indemnification and jurisdiction issues defined therein. Any holder of this document is advised that information contained hereon reflects the Company's findings at the time of its intervention only and within the limits of Client's instructions, if any. The Company's sole responsibility is to its Client and this document does not exonerate parties to a transaction from exercising all their rights and obligations under the transaction documents. This document cannot be reproduced except in full, without prior written approval of the Company. Any unauthorized alteration, forgery or falsification of the content or appearance of this document is unlawful and offenders may be prosecuted to the fullest extent of the law.

7.5.3.2. Test Plots

Band2_1.4MHz_QPSK_18607_6RB#0

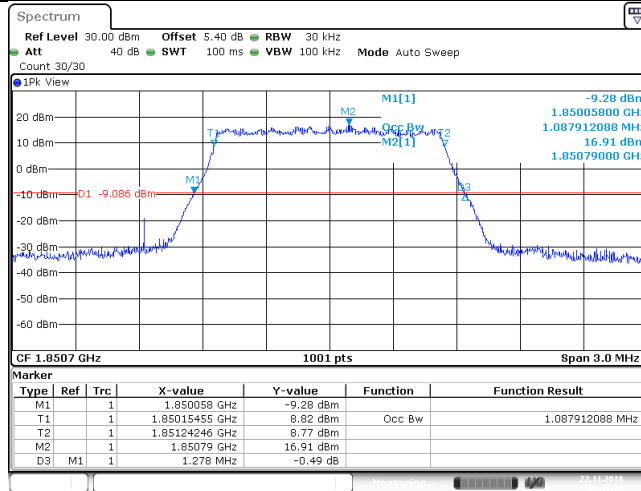

Date: 22 NOV 2018 10:41:01

Band2_1.4MHz_QPSK_18900_6RB#0

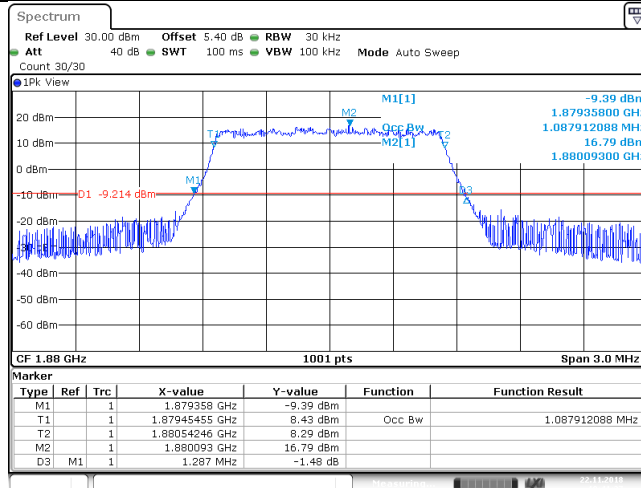

Date: 22 NOV 2018 10:41:28

Band2_1.4MHz_QPSK_19193_6RB#0

Unless otherwise stated the results shown in this test report refer only to the sample(s) tested and such sample(s) are retained for 90 days only.
除非另有說明，此報告結果僅對測試之樣品負責，同時此樣品僅保留90天。本報告未經本公司書面許可，不可部份複製。

This document is issued by the Company subject to its General Conditions of Service printed overleaf, available on request or accessible at www.sgs.com/terms_and_conditions.htm and, for electronic format documents, subject to Terms and Conditions for Electronic Documents at www.sgs.com/terms_e-document.htm. Attention is drawn to the limitation of liability, indemnification and jurisdiction issues defined therein. Any holder of this document is advised that information contained hereon reflects the Company's findings at the time of its intervention only and within the limits of Client's instructions, if any. The Company's sole responsibility is to its Client and this document does not exonerate parties to a transaction from exercising all their rights and obligations under the transaction documents. This document cannot be reproduced except in full, without prior written approval of the Company. Any unauthorized alteration, forgery or falsification of the content or appearance of this document is unlawful and offenders may be prosecuted to the fullest extent of the law.

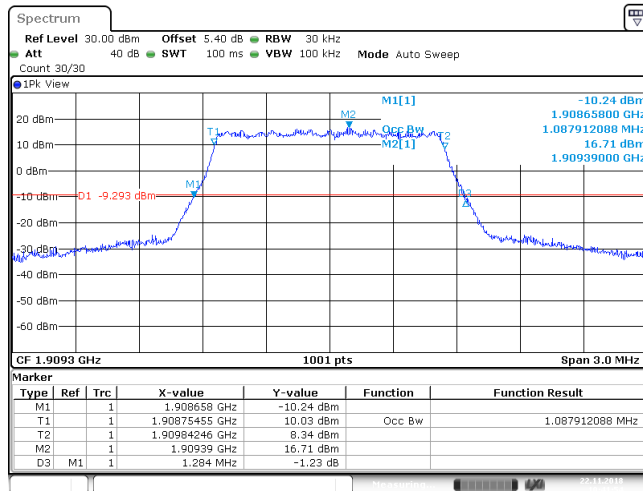

Band2_1.4MHz_16QAM_18607_6RB#0

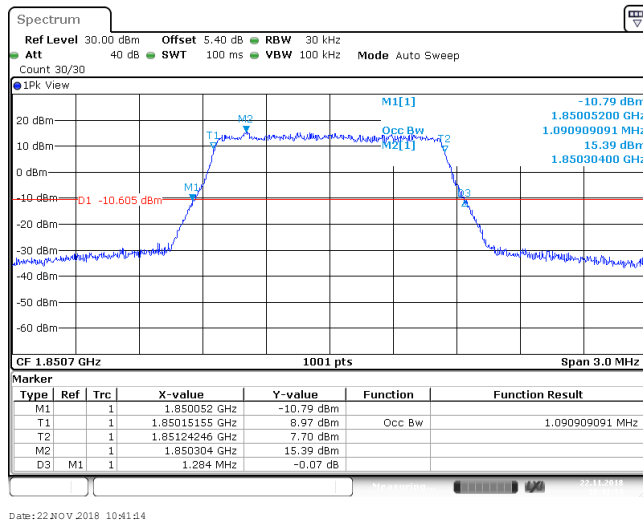

Band2_1.4MHz_16QAM_18900_6RB#0

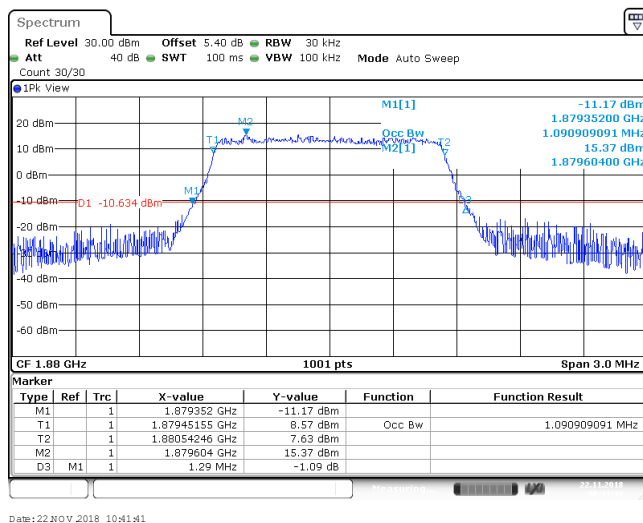

Unless otherwise stated the results shown in this test report refer only to the sample(s) tested and such sample(s) are retained for 90 days only.
除非另有說明，此報告結果僅對測試之樣品負責，同時此樣品僅保留90天。本報告未經本公司書面許可，不可部份複製。

This document is issued by the Company subject to its General Conditions of Service printed overleaf, available on request or accessible at www.sgs.com/terms_and_conditions.htm and, for electronic format documents, subject to Terms and Conditions for Electronic Documents at www.sgs.com/terms_e-document.htm. Attention is drawn to the limitation of liability, indemnification and jurisdiction issues defined therein. Any holder of this document is advised that information contained hereon reflects the Company's findings at the time of its intervention only and within the limits of Client's instructions, if any. The Company's sole responsibility is to its Client and this document does not exonerate parties to a transaction from exercising all their rights and obligations under the transaction documents. This document cannot be reproduced except in full, without prior written approval of the Company. Any unauthorized alteration, forgery or falsification of the content or appearance of this document is unlawful and offenders may be prosecuted to the fullest extent of the law.

Band2_1.4MHz_16QAM_19193_6RB#0

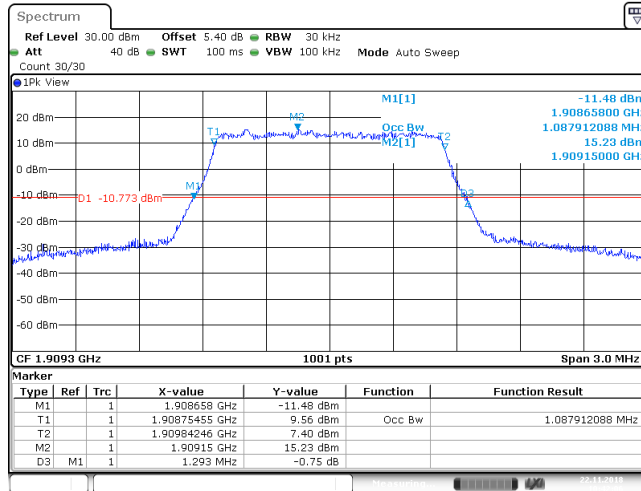

Date: 22 NOV 2018 10:42:07

Band2_3MHz_QPSK_18615_15RB#0

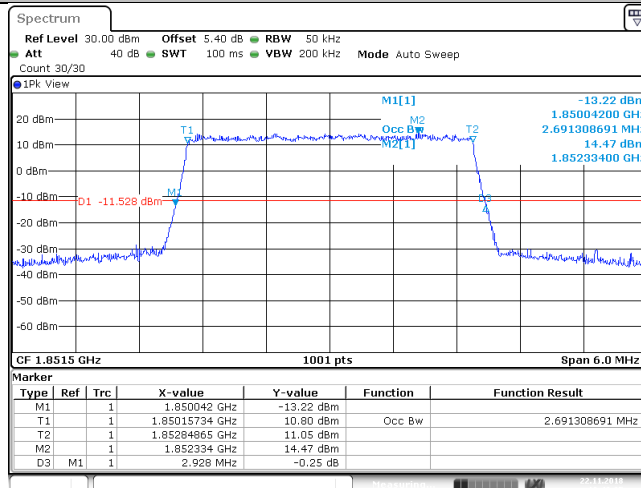

Date: 22 NOV 2018 10:42:25

Band2_3MHz_QPSK_18900_15RB#0

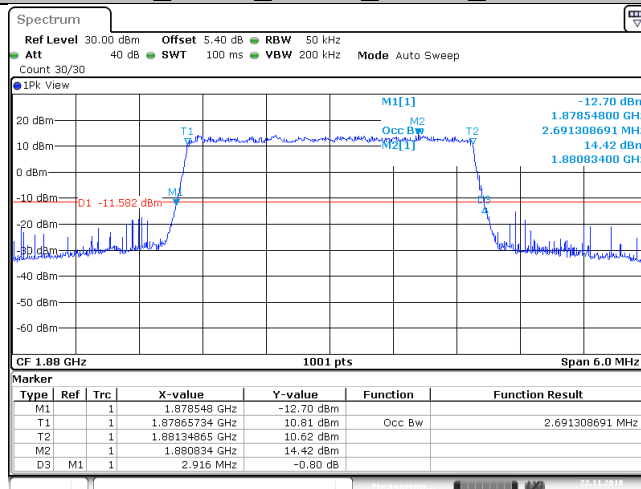

Date: 22 NOV 2018 10:42:52

Unless otherwise stated the results shown in this test report refer only to the sample(s) tested and such sample(s) are retained for 90 days only.

除非另有說明，此報告結果僅對測試之樣品負責，同時此樣品僅保留90天。本報告未經本公司書面許可，不可部份複製。

This document is issued by the Company subject to its General Conditions of Service printed overleaf, available on request or accessible at www.sgs.com/terms_and_conditions.htm and, for electronic format documents, subject to Terms and Conditions for Electronic Documents at www.sgs.com/terms_e-document.htm. Attention is drawn to the limitation of liability, indemnification and jurisdiction issues defined therein. Any holder of this document is advised that information contained hereon reflects the Company's findings at the time of its intervention only and within the limits of Client's instructions, if any. The Company's sole responsibility is to its Client and this document does not exonerate parties to a transaction from exercising all their rights and obligations under the transaction documents. This document cannot be reproduced except in full, without prior written approval of the Company. Any unauthorized alteration, forgery or falsification of the content or appearance of this document is unlawful and offenders may be prosecuted to the fullest extent of the law.

Band2_3MHz_QPSK_19185_15RB#0

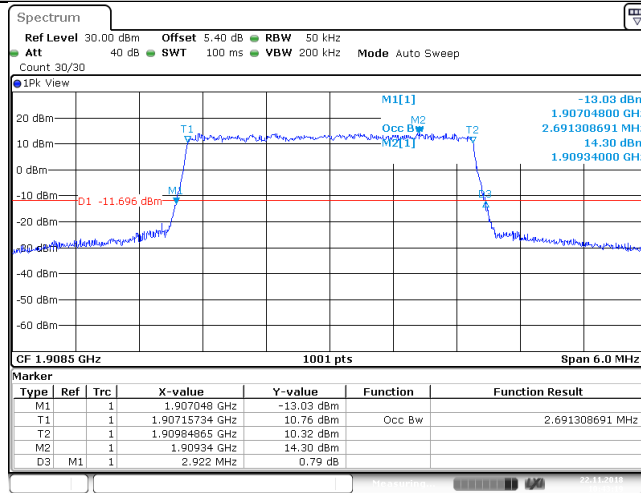

Date: 22 NOV 2018 10:43:19

Band2_3MHz_16QAM_18615_15RB#0

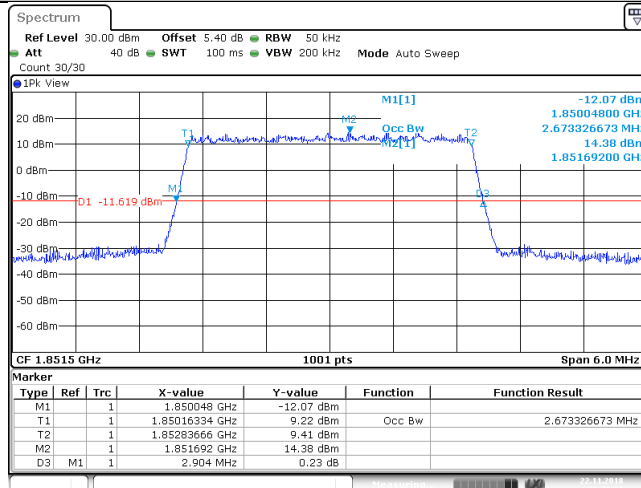

Date: 22 NOV 2018 10:42:39

Band2_3MHz_16QAM_18900_15RB#0

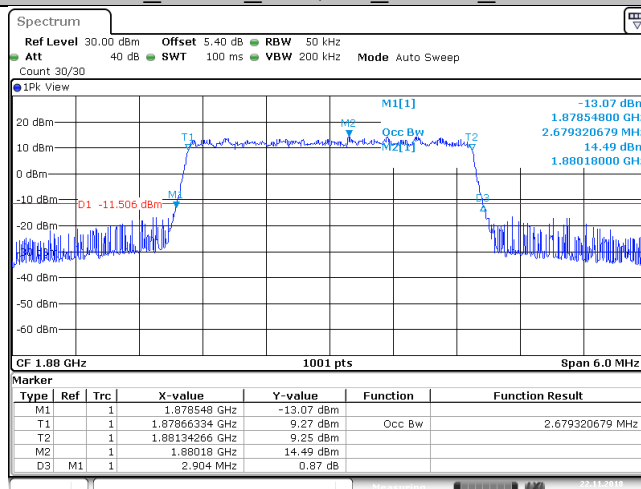

Date: 22 NOV 2018 10:43:05

Unless otherwise stated the results shown in this test report refer only to the sample(s) tested and such sample(s) are retained for 90 days only.
 除非另有說明，此報告結果僅對測試之樣品負責，同時此樣品僅保留90天。本報告未經本公司書面許可，不可部份複製。

This document is issued by the Company subject to its General Conditions of Service printed overleaf, available on request or accessible at www.sgs.com/terms_and_conditions.htm and, for electronic format documents, subject to Terms and Conditions for Electronic Documents at www.sgs.com/terms_e-document.htm. Attention is drawn to the limitation of liability, indemnification and jurisdiction issues defined therein. Any holder of this document is advised that information contained hereon reflects the Company's findings at the time of its intervention only and within the limits of Client's instructions, if any. The Company's sole responsibility is to its Client and this document does not exonerate parties to a transaction from exercising all their rights and obligations under the transaction documents. This document cannot be reproduced except in full, without prior written approval of the Company. Any unauthorized alteration, forgery or falsification of the content or appearance of this document is unlawful and offenders may be prosecuted to the fullest extent of the law.

Band2_3MHz_16QAM_19185_15RB#0

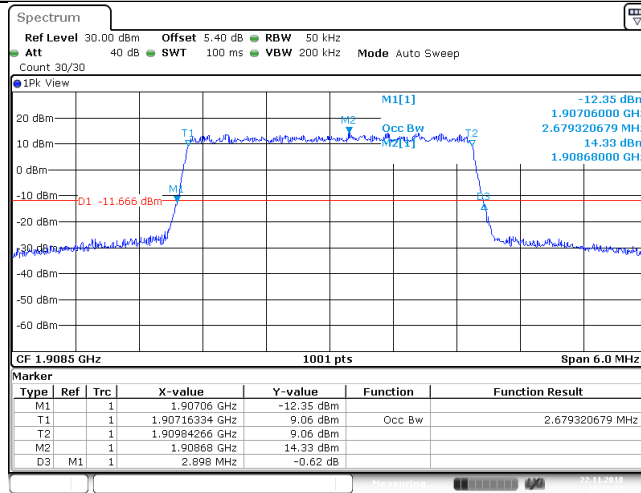

Band2_5MHz_QPSK_18625_25RB#0

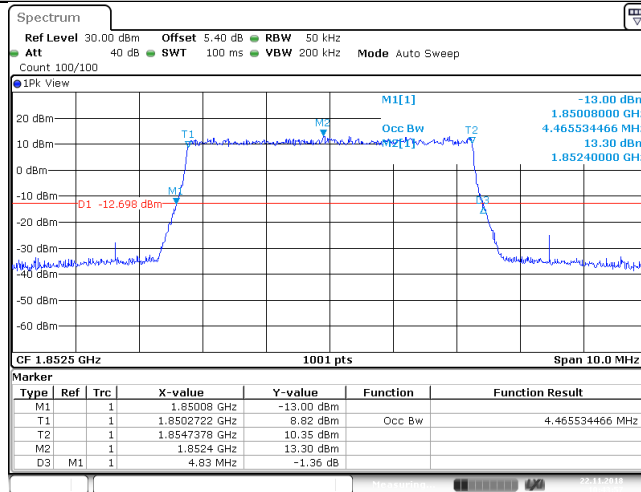

Band2_5MHz_QPSK_18900_25RB#0

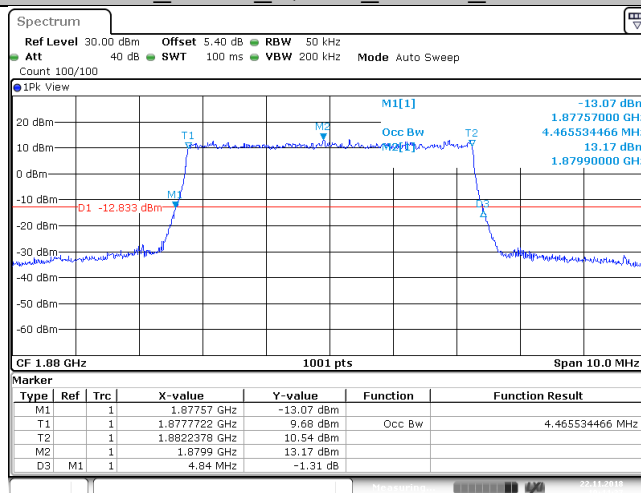

Unless otherwise stated the results shown in this test report refer only to the sample(s) tested and such sample(s) are retained for 90 days only.
 除非另有說明，此報告結果僅對測試之樣品負責，同時此樣品僅保留90天。本報告未經本公司書面許可，不可部份複製。

This document is issued by the Company subject to its General Conditions of Service printed overleaf, available on request or accessible at www.sgs.com/terms_and_conditions.htm and, for electronic format documents, subject to Terms and Conditions for Electronic Documents at www.sgs.com/terms_e-document.htm. Attention is drawn to the limitation of liability, indemnification and jurisdiction issues defined therein. Any holder of this document is advised that information contained hereon reflects the Company's findings at the time of its intervention only and within the limits of Client's instructions, if any. The Company's sole responsibility is to its Client and this document does not exonerate parties to a transaction from exercising all their rights and obligations under the transaction documents. This document cannot be reproduced except in full, without prior written approval of the Company. Any unauthorized alteration, forgery or falsification of the content or appearance of this document is unlawful and offenders may be prosecuted to the fullest extent of the law.

Band2_5MHz_QPSK_19175_25RB#0

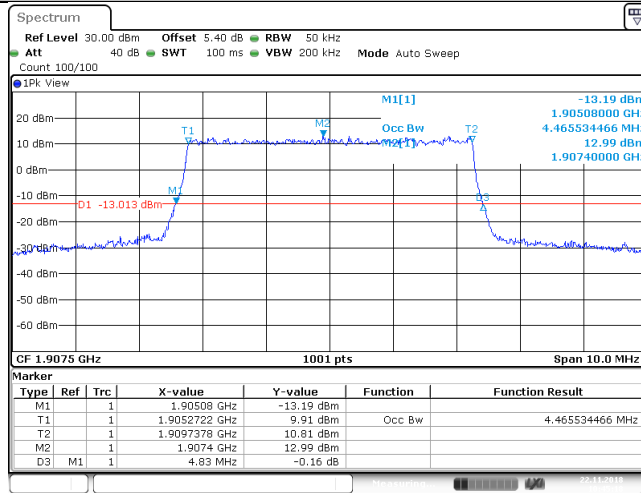

Date: 22 NOV 2018 10:45:08

Band2_5MHz_16QAM_18625_25RB#0

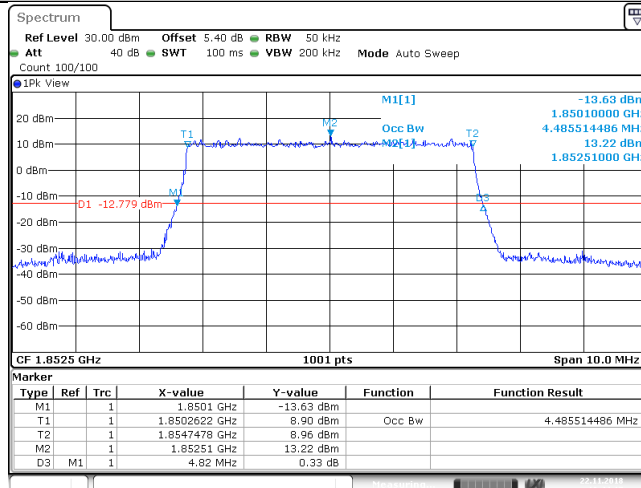

Date: 22 NOV 2018 10:44:47

Band2_5MHz_16QAM_18900_25RB#0

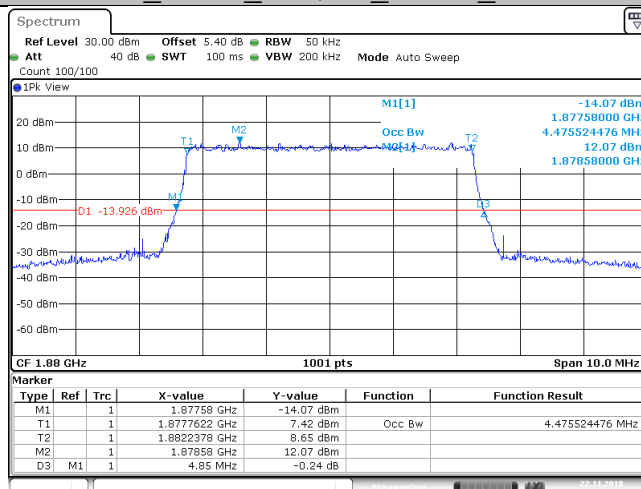

Date: 22 NOV 2018 10:44:57

Unless otherwise stated the results shown in this test report refer only to the sample(s) tested and such sample(s) are retained for 90 days only.
 除非另有說明，此報告結果僅對測試之樣品負責，同時此樣品僅保留90天。本報告未經本公司書面許可，不可部份複製。

This document is issued by the Company subject to its General Conditions of Service printed overleaf, available on request or accessible at www.sgs.com/terms_and_conditions.htm and, for electronic format documents, subject to Terms and Conditions for Electronic Documents at www.sgs.com/terms_e-document.htm. Attention is drawn to the limitation of liability, indemnification and jurisdiction issues defined therein. Any holder of this document is advised that information contained hereon reflects the Company's findings at the time of its intervention only and within the limits of Client's instructions, if any. The Company's sole responsibility is to its Client and this document does not exonerate parties to a transaction from exercising all their rights and obligations under the transaction documents. This document cannot be reproduced except in full, without prior written approval of the Company. Any unauthorized alteration, forgery or falsification of the content or appearance of this document is unlawful and offenders may be prosecuted to the fullest extent of the law.

Band2_5MHz_16QAM_19175_25RB#0

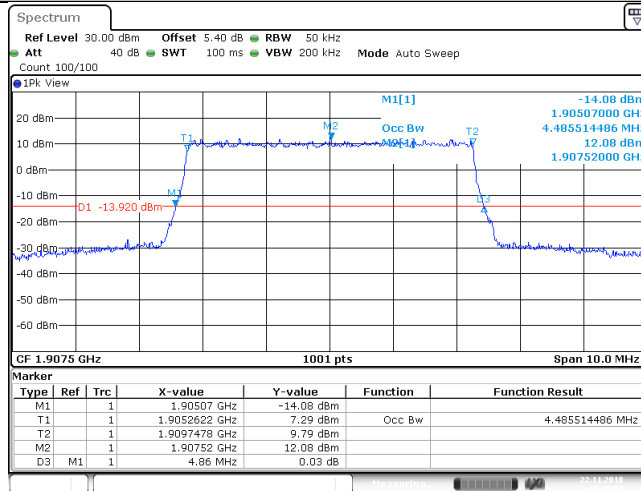

Date: 22 NOV 2018 10:45:37

Band2_10MHz_QPSK_18650_50RB#0

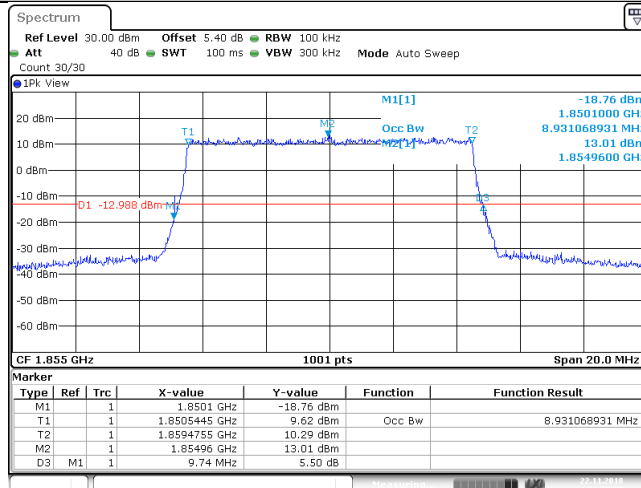

Date: 22 NOV 2018 10:45:56

Band2_10MHz_QPSK_18900_50RB#0

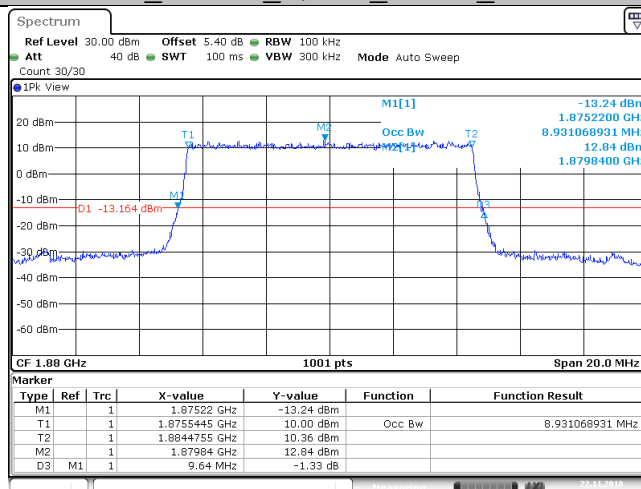

Date: 22 NOV 2018 10:46:22

Unless otherwise stated the results shown in this test report refer only to the sample(s) tested and such sample(s) are retained for 90 days only.
除非另有說明，此報告結果僅對測試之樣品負責，同時此樣品僅保留90天。本報告未經本公司書面許可，不可部份複製。

This document is issued by the Company subject to its General Conditions of Service printed overleaf, available on request or accessible at www.sgs.com/terms_and_conditions.htm and, for electronic format documents, subject to Terms and Conditions for Electronic Documents at www.sgs.com/terms_e-document.htm. Attention is drawn to the limitation of liability, indemnification and jurisdiction issues defined therein. Any holder of this document is advised that information contained hereon reflects the Company's findings at the time of its intervention only and within the limits of Client's instructions, if any. The Company's sole responsibility is to its Client and this document does not exonerate parties to a transaction from exercising all their rights and obligations under the transaction documents. This document cannot be reproduced except in full, without prior written approval of the Company. Any unauthorized alteration, forgery or falsification of the content or appearance of this document is unlawful and offenders may be prosecuted to the fullest extent of the law.

Band2_10MHz_QPSK_19150_50RB#0

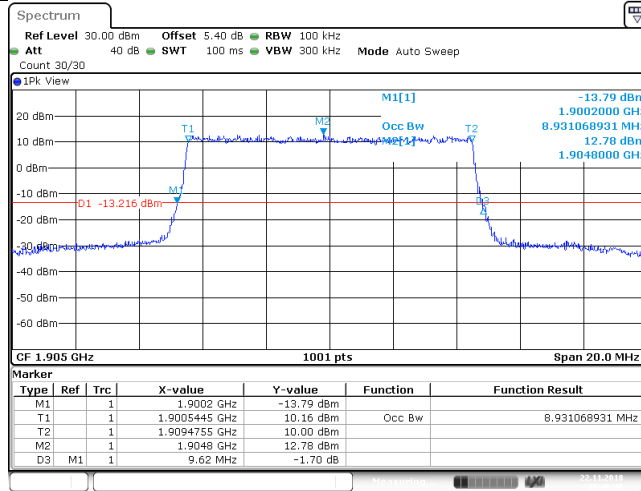

Band2_10MHz_16QAM_18650_50RB#0

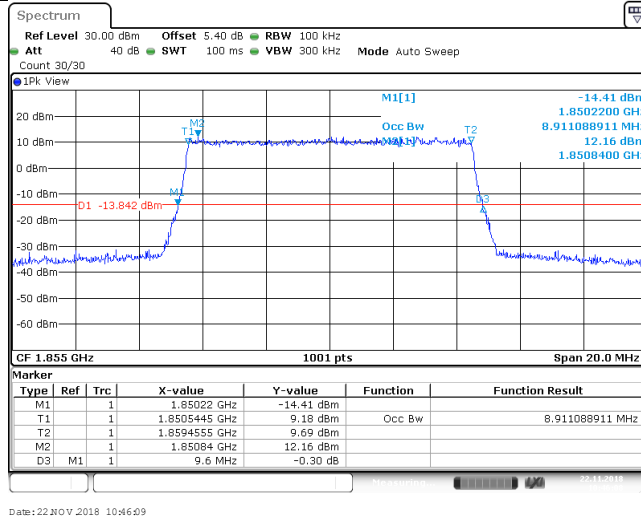

Band2_10MHz_16QAM_18900_50RB#0

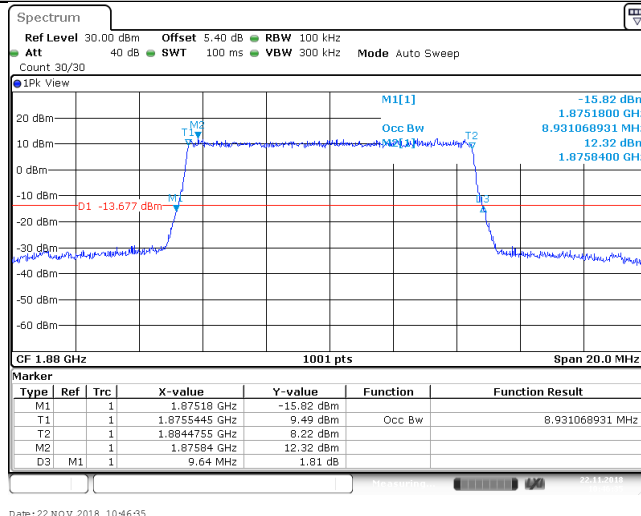

Unless otherwise stated the results shown in this test report refer only to the sample(s) tested and such sample(s) are retained for 90 days only.
 除非另有說明，此報告結果僅對測試之樣品負責，同時此樣品僅保留90天。本報告未經本公司書面許可，不可部份複製。

This document is issued by the Company subject to its General Conditions of Service printed overleaf, available on request or accessible at www.sgs.com/terms_and_conditions.htm and, for electronic format documents, subject to Terms and Conditions for Electronic Documents at www.sgs.com/terms_e-document.htm. Attention is drawn to the limitation of liability, indemnification and jurisdiction issues defined therein. Any holder of this document is advised that information contained hereon reflects the Company's findings at the time of its intervention only and within the limits of Client's instructions, if any. The Company's sole responsibility is to its Client and this document does not exonerate parties to a transaction from exercising all their rights and obligations under the transaction documents. This document cannot be reproduced except in full, without prior written approval of the Company. Any unauthorized alteration, forgery or falsification of the content or appearance of this document is unlawful and offenders may be prosecuted to the fullest extent of the law.

Band2_10MHz_16QAM_19150_50RB#0

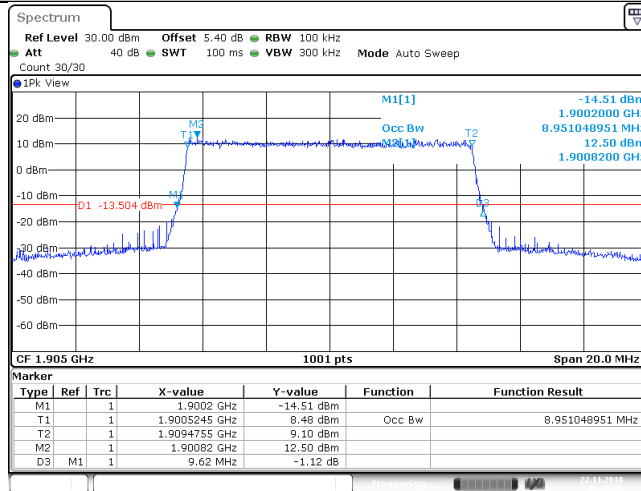

Date: 22 NOV 2018 10:47:01

Band2_15MHz_QPSK_18675_75RB#0

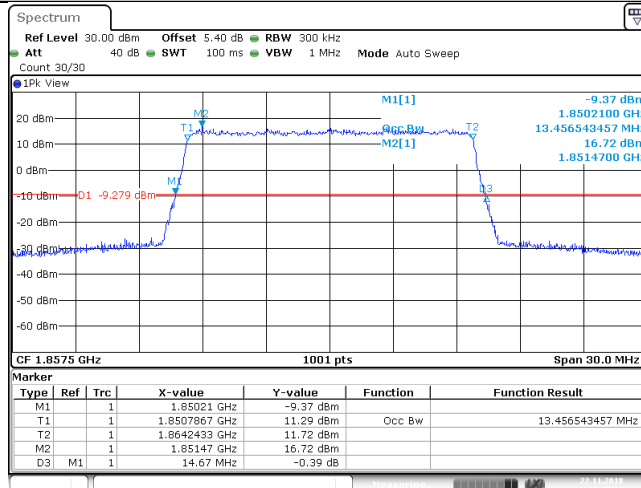

Date: 22 NOV 2018 10:47:19

Band2_15MHz_QPSK_18900_75RB#0

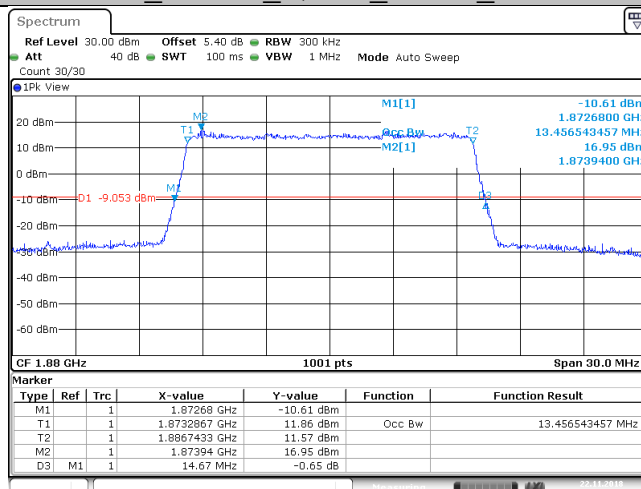

Date: 22 NOV 2018 10:47:45

Unless otherwise stated the results shown in this test report refer only to the sample(s) tested and such sample(s) are retained for 90 days only.
 除非另有說明，此報告結果僅對測試之樣品負責，同時此樣品僅保留90天。本報告未經本公司書面許可，不可部份複製。

This document is issued by the Company subject to its General Conditions of Service printed overleaf, available on request or accessible at www.sgs.com/terms_and_conditions.htm and, for electronic format documents, subject to Terms and Conditions for Electronic Documents at www.sgs.com/terms_e-document.htm. Attention is drawn to the limitation of liability, indemnification and jurisdiction issues defined therein. Any holder of this document is advised that information contained hereon reflects the Company's findings at the time of its intervention only and within the limits of Client's instructions, if any. The Company's sole responsibility is to its Client and this document does not exonerate parties to a transaction from exercising all their rights and obligations under the transaction documents. This document cannot be reproduced except in full, without prior written approval of the Company. Any unauthorized alteration, forgery or falsification of the content or appearance of this document is unlawful and offenders may be prosecuted to the fullest extent of the law.

Band2_15MHz_QPSK_19125_75RB#0

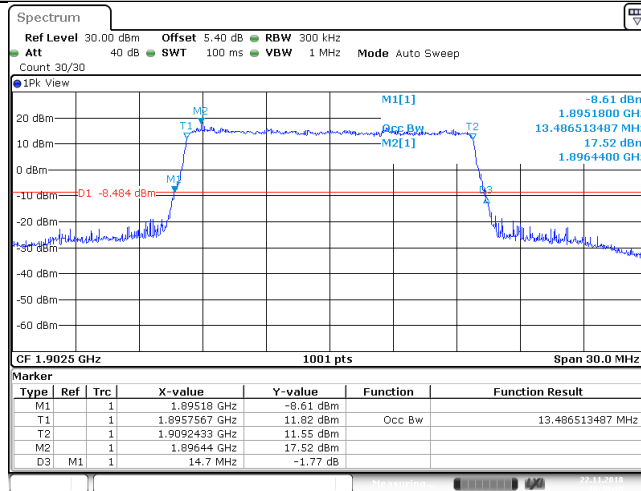

Band2_15MHz_16QAM_18675_75RB#0

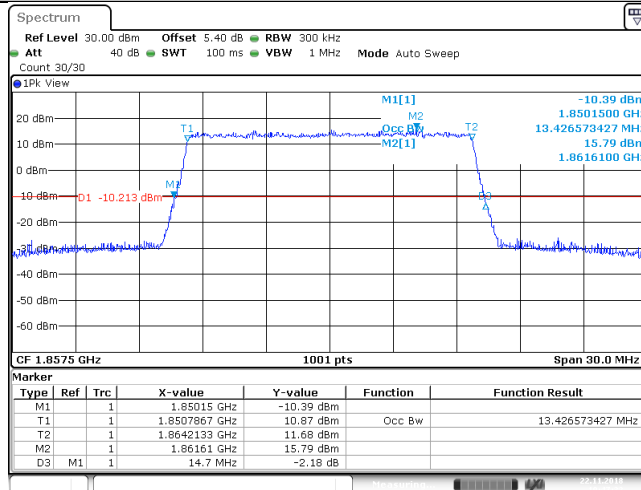

Band2_15MHz_16QAM_18900_75RB#0

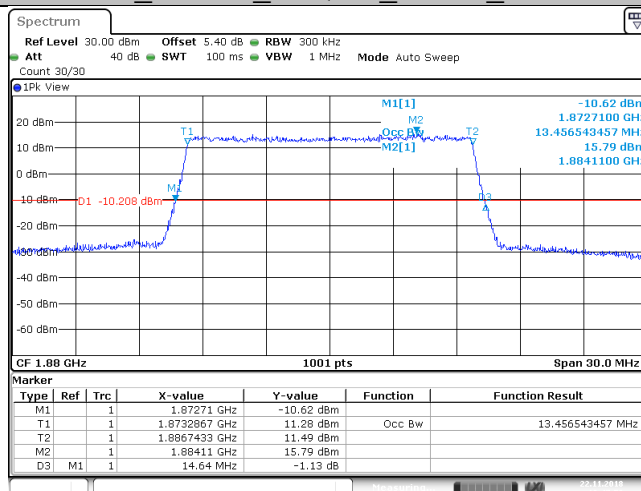

Unless otherwise stated the results shown in this test report refer only to the sample(s) tested and such sample(s) are retained for 90 days only.
 除非另有說明，此報告結果僅對測試之樣品負責，同時此樣品僅保留90天。本報告未經本公司書面許可，不可部份複製。

This document is issued by the Company subject to its General Conditions of Service printed overleaf, available on request or accessible at www.sgs.com/terms_and_conditions.htm and, for electronic format documents, subject to Terms and Conditions for Electronic Documents at www.sgs.com/terms_e-document.htm. Attention is drawn to the limitation of liability, indemnification and jurisdiction issues defined therein. Any holder of this document is advised that information contained hereon reflects the Company's findings at the time of its intervention only and within the limits of Client's instructions, if any. The Company's sole responsibility is to its Client and this document does not exonerate parties to a transaction from exercising all their rights and obligations under the transaction documents. This document cannot be reproduced except in full, without prior written approval of the Company. Any unauthorized alteration, forgery or falsification of the content or appearance of this document is unlawful and offenders may be prosecuted to the fullest extent of the law.

Band2_15MHz_16QAM_19125_75RB#0

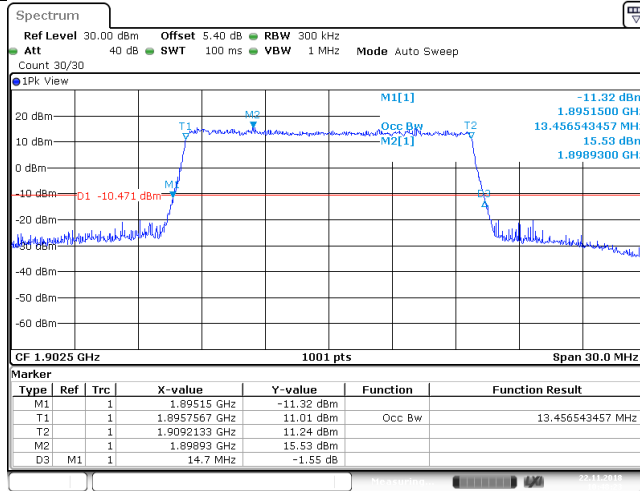

Band2_20MHz_QPSK_18700_100RB#0

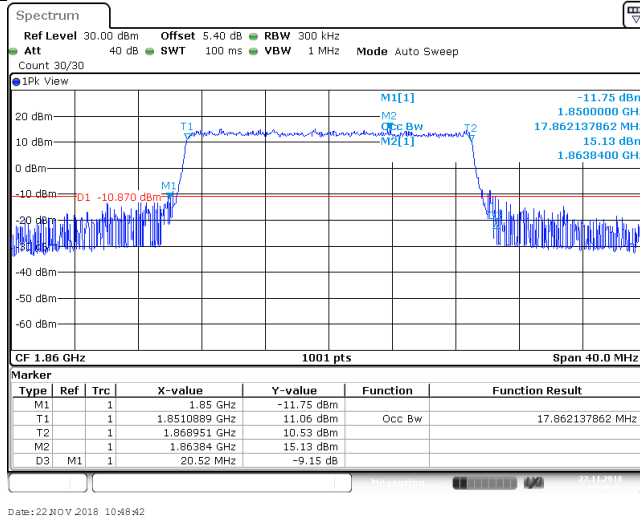

Band2_20MHz_QPSK_18900_100RB#0

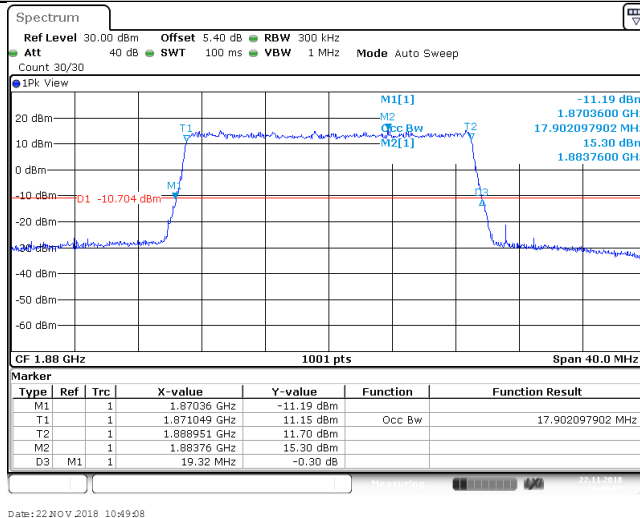

Unless otherwise stated the results shown in this test report refer only to the sample(s) tested and such sample(s) are retained for 90 days only.
 除非另有說明，此報告結果僅對測試之樣品負責，同時此樣品僅保留90天。本報告未經本公司書面許可，不可部份複製。

This document is issued by the Company subject to its General Conditions of Service printed overleaf, available on request or accessible at www.sgs.com/terms_and_conditions.htm and, for electronic format documents, subject to Terms and Conditions for Electronic Documents at www.sgs.com/terms_e-document.htm. Attention is drawn to the limitation of liability, indemnification and jurisdiction issues defined therein. Any holder of this document is advised that information contained hereon reflects the Company's findings at the time of its intervention only and within the limits of Client's instructions, if any. The Company's sole responsibility is to its Client and this document does not exonerate parties to a transaction from exercising all their rights and obligations under the transaction documents. This document cannot be reproduced except in full, without prior written approval of the Company. Any unauthorized alteration, forgery or falsification of the content or appearance of this document is unlawful and offenders may be prosecuted to the fullest extent of the law.

Band2_20MHz_QPSK_19100_100RB#0

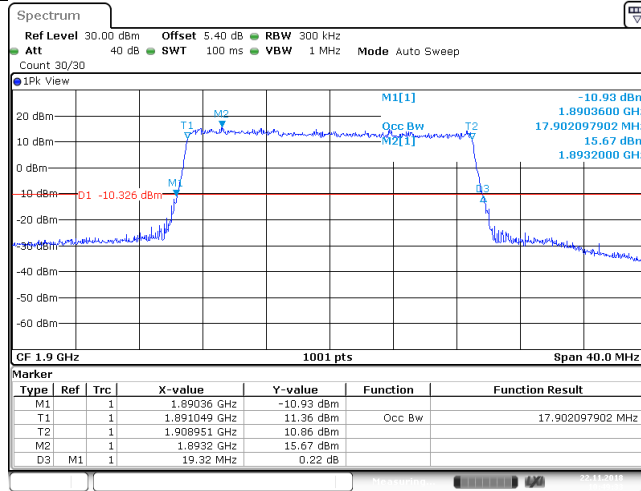

Date: 22 NOV 2018 10:49:33

Band2_20MHz_16QAM_18700_100RB#0

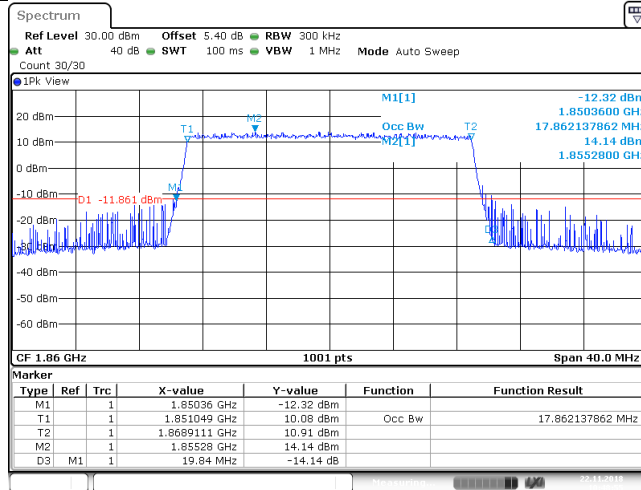

Date: 22 NOV 2018 10:48:55

Band2_20MHz_16QAM_18900_100RB#0

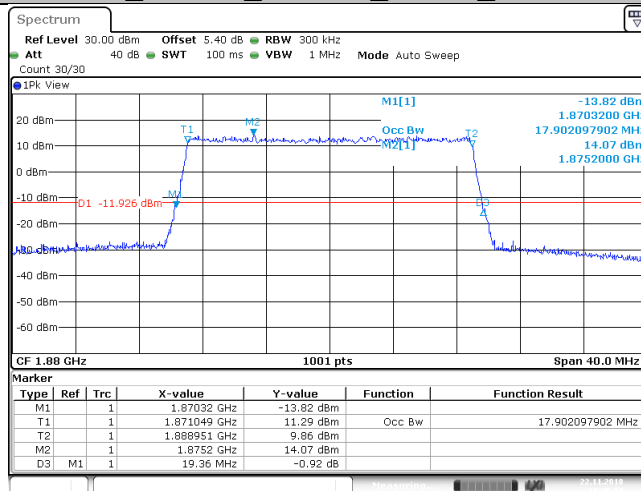

Date: 22 NOV 2018 10:49:20

Unless otherwise stated the results shown in this test report refer only to the sample(s) tested and such sample(s) are retained for 90 days only.
 除非另有說明，此報告結果僅對測試之樣品負責，同時此樣品僅保留90天。本報告未經本公司書面許可，不可部份複製。

This document is issued by the Company subject to its General Conditions of Service printed overleaf, available on request or accessible at www.sgs.com/terms_and_conditions.htm and, for electronic format documents, subject to Terms and Conditions for Electronic Documents at www.sgs.com/terms_e-document.htm. Attention is drawn to the limitation of liability, indemnification and jurisdiction issues defined therein. Any holder of this document is advised that information contained hereon reflects the Company's findings at the time of its intervention only and within the limits of Client's instructions, if any. The Company's sole responsibility is to its Client and this document does not exonerate parties to a transaction from exercising all their rights and obligations under the transaction documents. This document cannot be reproduced except in full, without prior written approval of the Company. Any unauthorized alteration, forgery or falsification of the content or appearance of this document is unlawful and offenders may be prosecuted to the fullest extent of the law.

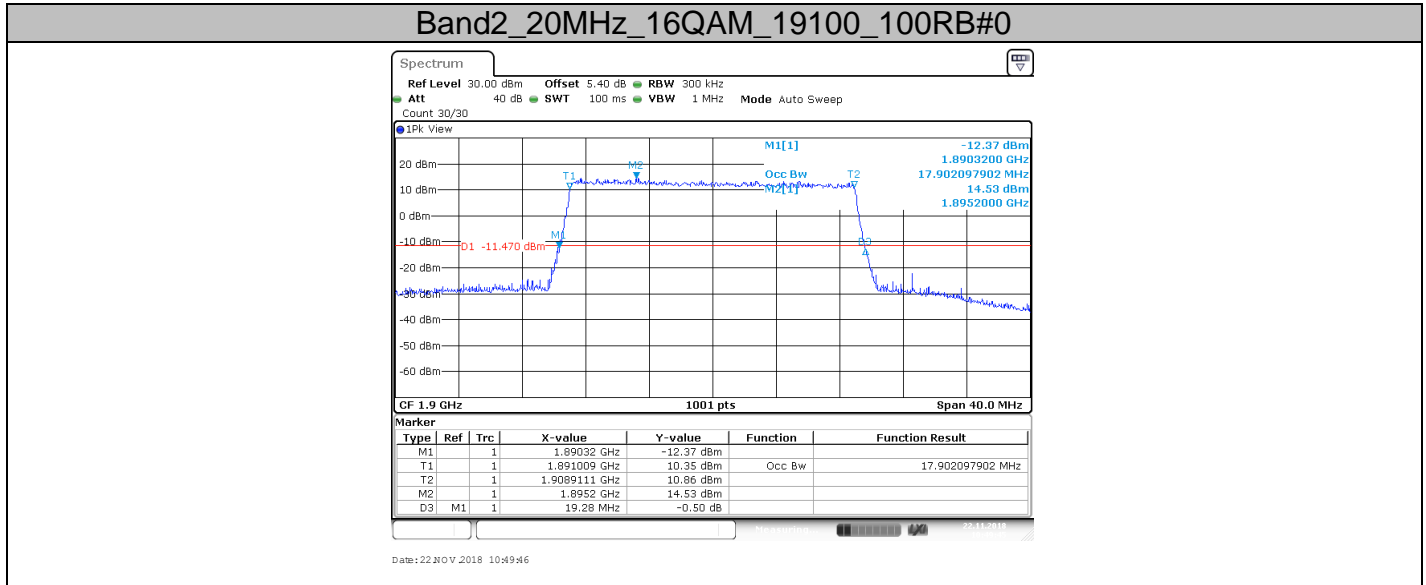

7.6. Measurement Result: LTE BAND 5 Mode

7.6.1.1. Test Result

BAND	Bandwidth	Modulation	Channel	RB Configuration	Occupied Bandwidth (MHz)	26dB Bandwidth (MHz)	Verdict
Band5	1.4MHz	QPSK	20407	6RB#0	1.091	1.287	PASS
Band5	1.4MHz	QPSK	20525	6RB#0	1.091	1.290	PASS
Band5	1.4MHz	QPSK	20643	6RB#0	1.091	1.314	PASS
Band5	1.4MHz	16QAM	20407	6RB#0	1.091	1.290	PASS
Band5	1.4MHz	16QAM	20525	6RB#0	1.088	1.278	PASS
Band5	1.4MHz	16QAM	20643	6RB#0	1.091	1.305	PASS
Band5	3MHz	QPSK	20415	15RB#0	2.691	2.928	PASS
Band5	3MHz	QPSK	20525	15RB#0	2.691	2.922	PASS
Band5	3MHz	QPSK	20635	15RB#0	2.691	2.934	PASS
Band5	3MHz	16QAM	20415	15RB#0	2.679	2.904	PASS
Band5	3MHz	16QAM	20525	15RB#0	2.685	2.904	PASS
Band5	3MHz	16QAM	20635	15RB#0	2.673	2.898	PASS
Band5	5MHz	QPSK	20425	25RB#0	4.466	4.830	PASS
Band5	5MHz	QPSK	20525	25RB#0	4.476	4.830	PASS
Band5	5MHz	QPSK	20625	25RB#0	4.466	4.830	PASS
Band5	5MHz	16QAM	20425	25RB#0	4.486	4.870	PASS
Band5	5MHz	16QAM	20525	25RB#0	4.476	4.850	PASS
Band5	5MHz	16QAM	20625	25RB#0	4.486	4.860	PASS
Band5	10MHz	QPSK	20450	50RB#0	8.931	9.620	PASS
Band5	10MHz	QPSK	20525	50RB#0	8.951	9.560	PASS
Band5	10MHz	QPSK	20600	50RB#0	8.931	9.640	PASS
Band5	10MHz	16QAM	20450	50RB#0	8.931	9.600	PASS
Band5	10MHz	16QAM	20525	50RB#0	8.931	9.580	PASS
Band5	10MHz	16QAM	20600	50RB#0	8.931	9.600	PASS

Unless otherwise stated the results shown in this test report refer only to the sample(s) tested and such sample(s) are retained for 90 days only.
除非另有說明，此報告結果僅對測試之樣品負責，同時此樣品僅保留90天。本報告未經本公司書面許可，不可部份複製。

This document is issued by the Company subject to its General Conditions of Service printed overleaf, available on request or accessible at www.sgs.com/terms_and_conditions.htm and, for electronic format documents, subject to Terms and Conditions for Electronic Documents at www.sgs.com/terms_e-document.htm. Attention is drawn to the limitation of liability, indemnification and jurisdiction issues defined therein. Any holder of this document is advised that information contained hereon reflects the Company's findings at the time of its intervention only and within the limits of Client's instructions, if any. The Company's sole responsibility is to its Client and this document does not exonerate parties to a transaction from exercising all their rights and obligations under the transaction documents. This document cannot be reproduced except in full, without prior written approval of the Company. Any unauthorized alteration, forgery or falsification of the content or appearance of this document is unlawful and offenders may be prosecuted to the fullest extent of the law.

7.6.1.2. Test Plots

Band5_1.4MHz_QPSK_20407_6RB#0

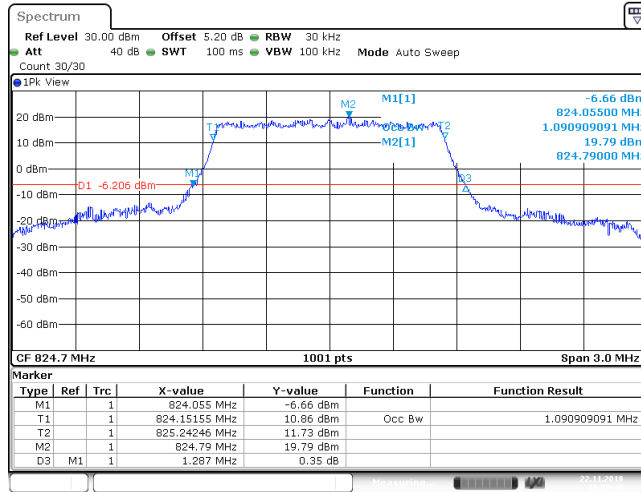

Date: 22 NOV 2018 10:00:40

Band5_1.4MHz_QPSK_20525_6RB#0

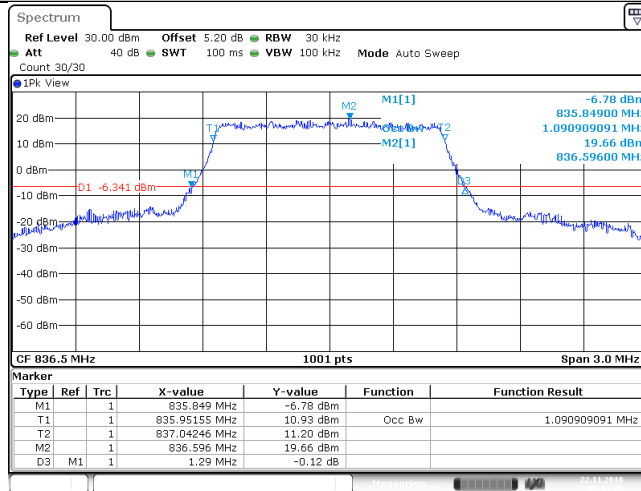

Date: 22 NOV 2018 10:01:07

Band5_1.4MHz_QPSK_20643_6RB#0

Unless otherwise stated the results shown in this test report refer only to the sample(s) tested and such sample(s) are retained for 90 days only.
除非另有說明，此報告結果僅對測試之樣品負責，同時此樣品僅保留90天。本報告未經本公司書面許可，不可部份複製。

This document is issued by the Company subject to its General Conditions of Service printed overleaf, available on request or accessible at www.sgs.com/terms_and_conditions.htm and, for electronic format documents, subject to Terms and Conditions for Electronic Documents at www.sgs.com/terms_e-document.htm. Attention is drawn to the limitation of liability, indemnification and jurisdiction issues defined therein. Any holder of this document is advised that information contained hereon reflects the Company's findings at the time of its intervention only and within the limits of Client's instructions, if any. The Company's sole responsibility is to its Client and this document does not exonerate parties to a transaction from exercising all their rights and obligations under the transaction documents. This document cannot be reproduced except in full, without prior written approval of the Company. Any unauthorized alteration, forgery or falsification of the content or appearance of this document is unlawful and offenders may be prosecuted to the fullest extent of the law.

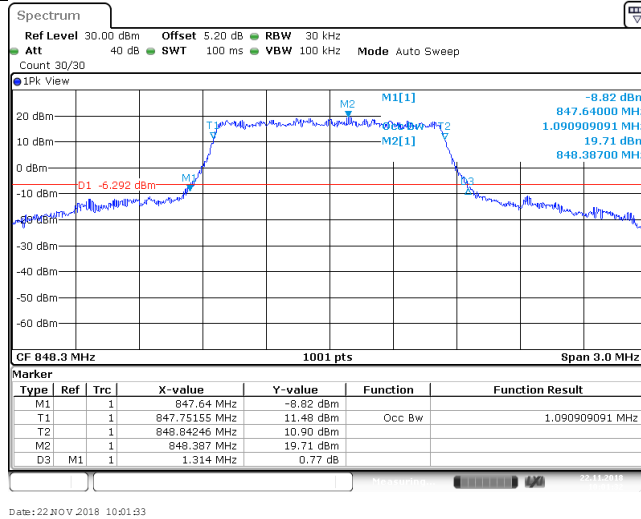

Band5_1.4MHz_16QAM_20407_6RB#0

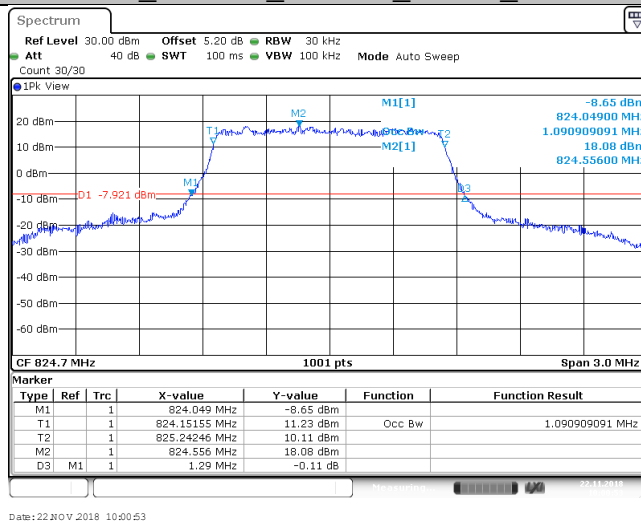

Band5_1.4MHz_16QAM_20525_6RB#0

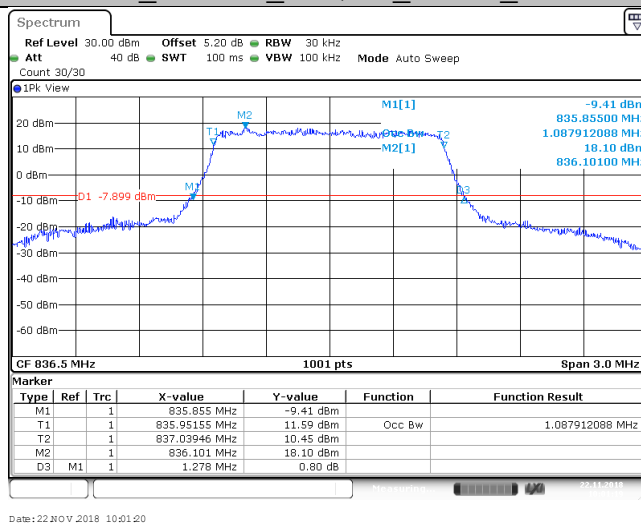

Band5_1.4MHz_16QAM_20643_6RB#0

Unless otherwise stated the results shown in this test report refer only to the sample(s) tested and such sample(s) are retained for 90 days only.
除非另有說明，此報告結果僅對測試之樣品負責，同時此樣品僅保留90天。本報告未經本公司書面許可，不可部份複製。

This document is issued by the Company subject to its General Conditions of Service printed overleaf, available on request or accessible at www.sgs.com/terms_and_conditions.htm and, for electronic format documents, subject to Terms and Conditions for Electronic Documents at www.sgs.com/terms_e-document.htm. Attention is drawn to the limitation of liability, indemnification and jurisdiction issues defined therein. Any holder of this document is advised that information contained hereon reflects the Company's findings at the time of its intervention only and within the limits of Client's instructions, if any. The Company's sole responsibility is to its Client and this document does not exonerate parties to a transaction from exercising all their rights and obligations under the transaction documents. This document cannot be reproduced except in full, without prior written approval of the Company. Any unauthorized alteration, forgery or falsification of the content or appearance of this document is unlawful and offenders may be prosecuted to the fullest extent of the law.

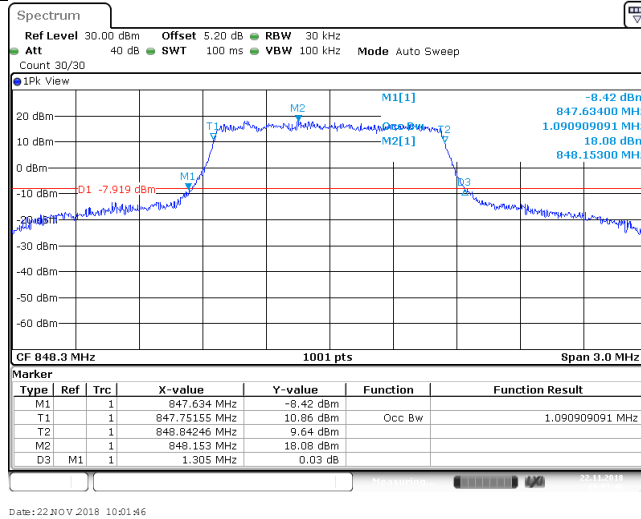

Band5_3MHz_QPSK_20415_15RB#0

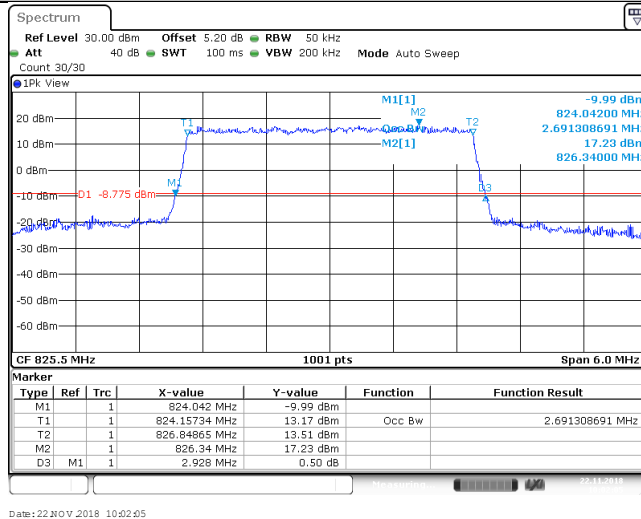

Band5_3MHz_QPSK_20525_15RB#0

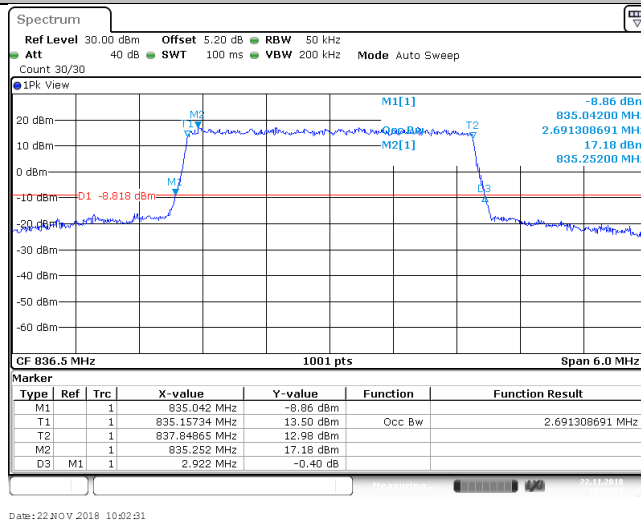

Band5_3MHz_QPSK_20635_15RB#0

Unless otherwise stated the results shown in this test report refer only to the sample(s) tested and such sample(s) are retained for 90 days only.
除非另有說明，此報告結果僅對測試之樣品負責，同時此樣品僅保留90天。本報告未經本公司書面許可，不可部份複製。

This document is issued by the Company subject to its General Conditions of Service printed overleaf, available on request or accessible at www.sgs.com/terms_and_conditions.htm and, for electronic format documents, subject to Terms and Conditions for Electronic Documents at www.sgs.com/terms_e-document.htm. Attention is drawn to the limitation of liability, indemnification and jurisdiction issues defined therein. Any holder of this document is advised that information contained hereon reflects the Company's findings at the time of its intervention only and within the limits of Client's instructions, if any. The Company's sole responsibility is to its Client and this document does not exonerate parties to a transaction from exercising all their rights and obligations under the transaction documents. This document cannot be reproduced except in full, without prior written approval of the Company. Any unauthorized alteration, forgery or falsification of the content or appearance of this document is unlawful and offenders may be prosecuted to the fullest extent of the law.

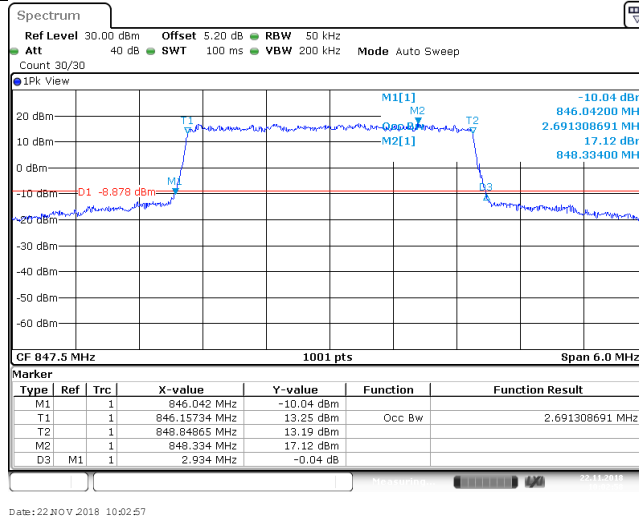

Band5_3MHz_16QAM_20415_15RB#0

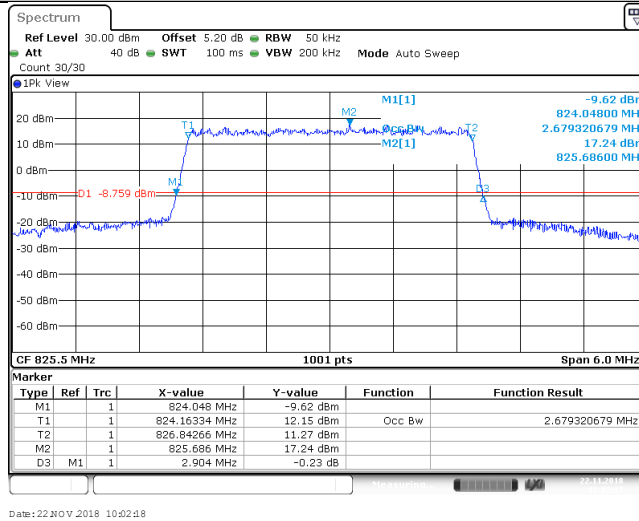

Band5_3MHz_16QAM_20525_15RB#0

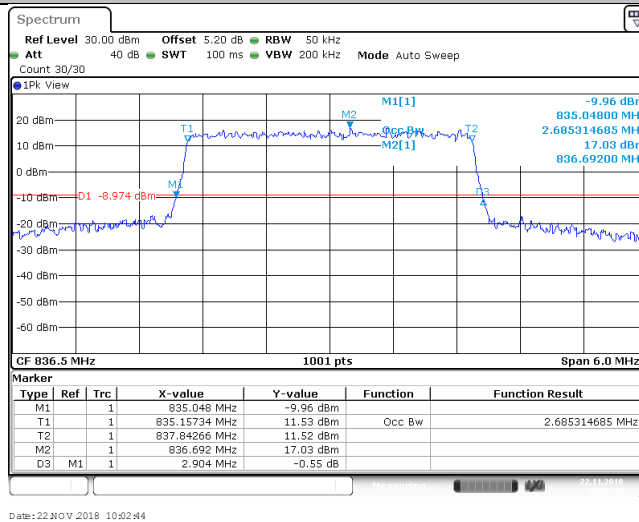

Band5_3MHz_16QAM_20635_15RB#0

Unless otherwise stated the results shown in this test report refer only to the sample(s) tested and such sample(s) are retained for 90 days only.
除非另有說明，此報告結果僅對測試之樣品負責，同時此樣品僅保留90天。本報告未經本公司書面許可，不可部份複製。

This document is issued by the Company subject to its General Conditions of Service printed overleaf, available on request or accessible at www.sgs.com/terms_and_conditions.htm and, for electronic format documents, subject to Terms and Conditions for Electronic Documents at www.sgs.com/terms_e-document.htm. Attention is drawn to the limitation of liability, indemnification and jurisdiction issues defined therein. Any holder of this document is advised that information contained hereon reflects the Company's findings at the time of its intervention only and within the limits of Client's instructions, if any. The Company's sole responsibility is to its Client and this document does not exonerate parties to a transaction from exercising all their rights and obligations under the transaction documents. This document cannot be reproduced except in full, without prior written approval of the Company. Any unauthorized alteration, forgery or falsification of the content or appearance of this document is unlawful and offenders may be prosecuted to the fullest extent of the law.

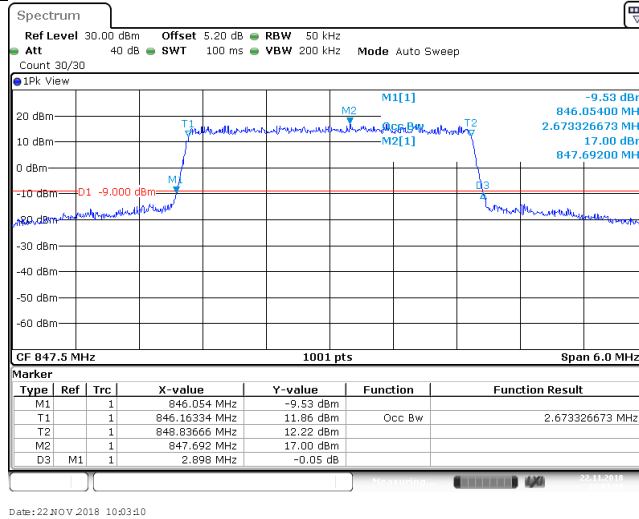

Band5 5MHz_QPSK_20425_25RB#0

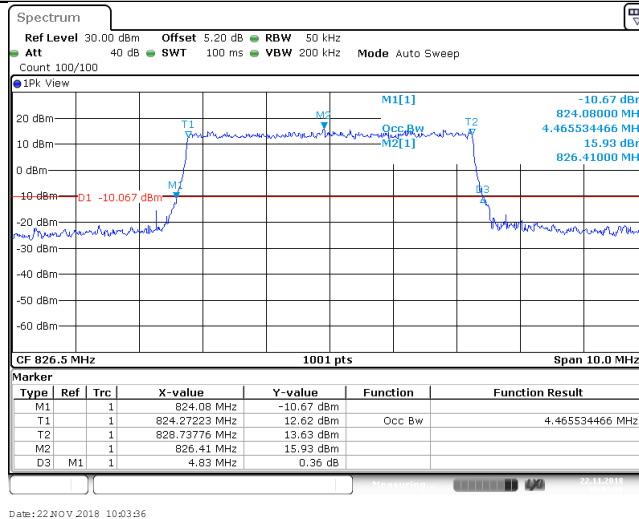

Band5 5MHz_QPSK_20525_25RB#0

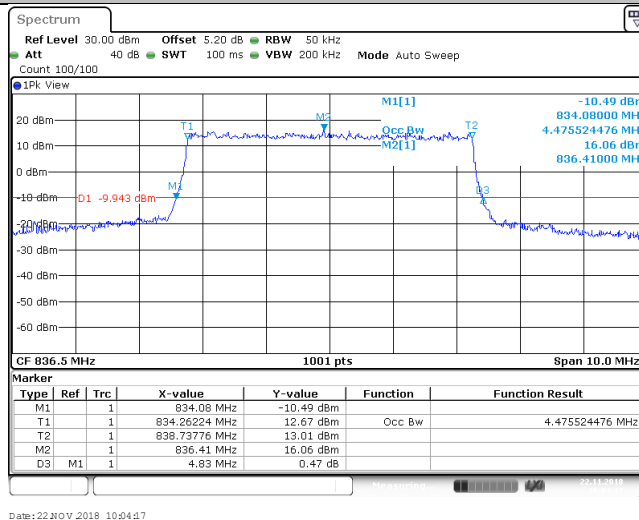

Band5 5MHz_QPSK_20625_25RB#0

Unless otherwise stated the results shown in this test report refer only to the sample(s) tested and such sample(s) are retained for 90 days only.
除非另有說明，此報告結果僅對測試之樣品負責，同時此樣品僅保留90天。本報告未經本公司書面許可，不可部份複製。

This document is issued by the Company subject to its General Conditions of Service printed overleaf, available on request or accessible at www.sgs.com/terms_and_conditions.htm and, for electronic format documents, subject to Terms and Conditions for Electronic Documents at www.sgs.com/terms_e-document.htm. Attention is drawn to the limitation of liability, indemnification and jurisdiction issues defined therein. Any holder of this document is advised that information contained hereon reflects the Company's findings at the time of its intervention only and within the limits of Client's instructions, if any. The Company's sole responsibility is to its Client and this document does not exonerate parties to a transaction from exercising all their rights and obligations under the transaction documents. This document cannot be reproduced except in full, without prior written approval of the Company. Any unauthorized alteration, forgery or falsification of the content or appearance of this document is unlawful and offenders may be prosecuted to the fullest extent of the law.

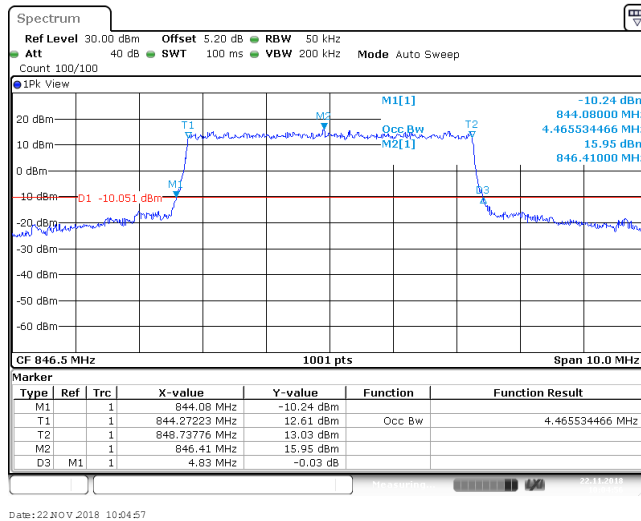

Date: 22 NOV 2018 10:04:57

Band5_5MHz_16QAM_20425_25RB#0

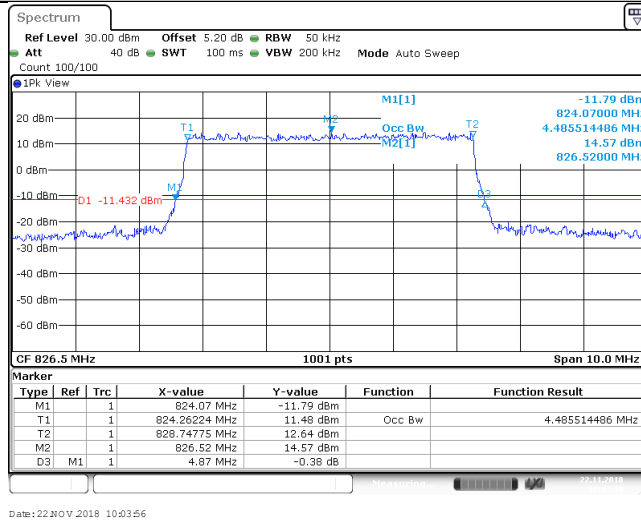

Date: 22 NOV 2018 10:03:56

Band5_5MHz_16QAM_20525_25RB#0

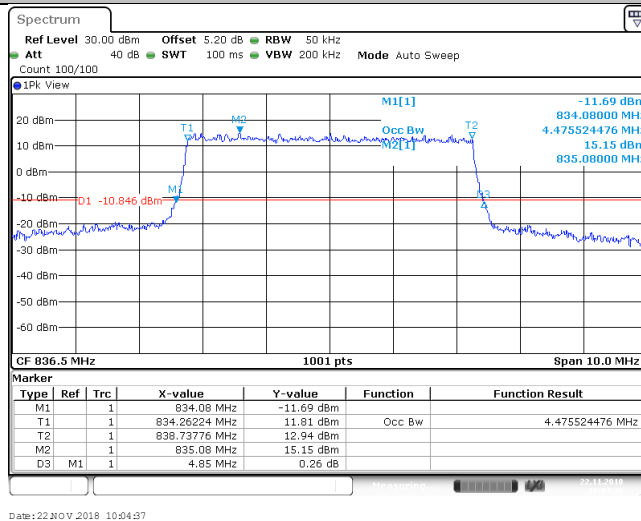

Date: 22 NOV 2018 10:04:57

Band5_5MHz_16QAM_20625_25RB#0

Unless otherwise stated the results shown in this test report refer only to the sample(s) tested and such sample(s) are retained for 90 days only.
除非另有說明，此報告結果僅對測試之樣品負責，同時此樣品僅保留90天。本報告未經本公司書面許可，不可部份複製。

This document is issued by the Company subject to its General Conditions of Service printed overleaf, available on request or accessible at www.sgs.com/terms_and_conditions.htm and, for electronic format documents, subject to Terms and Conditions for Electronic Documents at www.sgs.com/terms_e-document.htm. Attention is drawn to the limitation of liability, indemnification and jurisdiction issues defined therein. Any holder of this document is advised that information contained hereon reflects the Company's findings at the time of its intervention only and within the limits of Client's instructions, if any. The Company's sole responsibility is to its Client and this document does not exonerate parties to a transaction from exercising all their rights and obligations under the transaction documents. This document cannot be reproduced except in full, without prior written approval of the Company. Any unauthorized alteration, forgery or falsification of the content or appearance of this document is unlawful and offenders may be prosecuted to the fullest extent of the law.

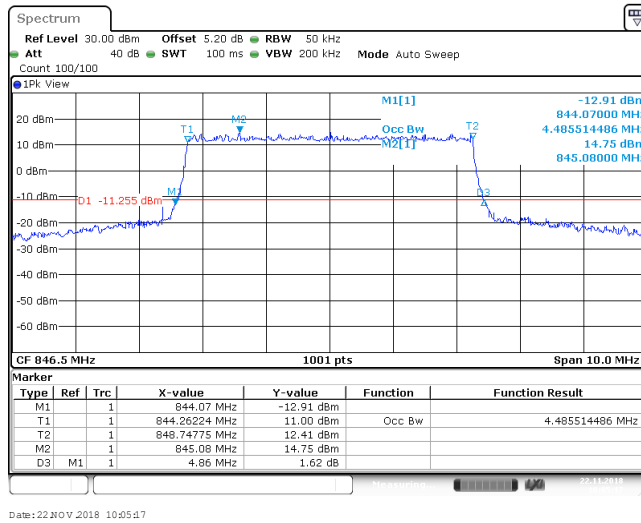

Date: 22 NOV 2018 10:05:17

Band5_10MHz_QPSK_20450_50RB#0

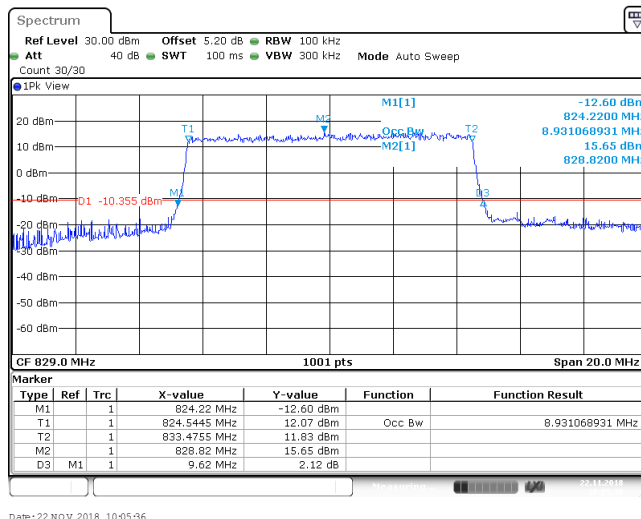

Date: 22 NOV 2018 10:05:36

Band5_10MHz_QPSK_20525_50RB#0

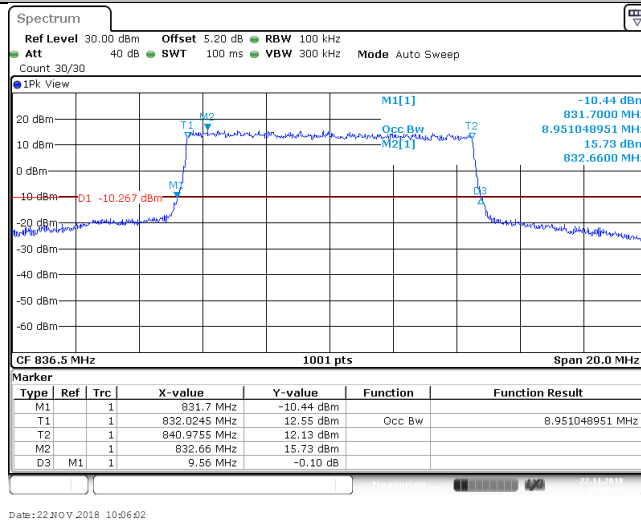

Date: 22 NOV 2018 10:06:02

Unless otherwise stated the results shown in this test report refer only to the sample(s) tested and such sample(s) are retained for 90 days only.
除非另有說明，此報告結果僅對測試之樣品負責，同時此樣品僅保留90天。本報告未經本公司書面許可，不可部份複製。

This document is issued by the Company subject to its General Conditions of Service printed overleaf, available on request or accessible at www.sgs.com/terms_and_conditions.htm and, for electronic format documents, subject to Terms and Conditions for Electronic Documents at www.sgs.com/terms_e-document.htm. Attention is drawn to the limitation of liability, indemnification and jurisdiction issues defined therein. Any holder of this document is advised that information contained hereon reflects the Company's findings at the time of its intervention only and within the limits of Client's instructions, if any. The Company's sole responsibility is to its Client and this document does not exonerate parties to a transaction from exercising all their rights and obligations under the transaction documents. This document cannot be reproduced except in full, without prior written approval of the Company. Any unauthorized alteration, forgery or falsification of the content or appearance of this document is unlawful and offenders may be prosecuted to the fullest extent of the law.

Band5_10MHz_QPSK_20600_50RB#0

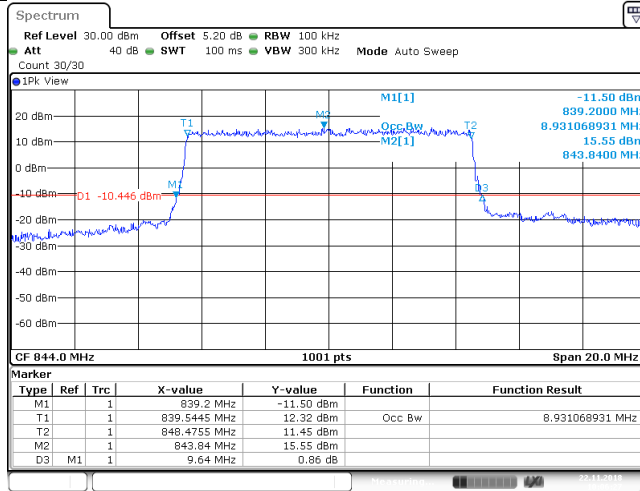

Band5_10MHz_16QAM_20450_50RB#0

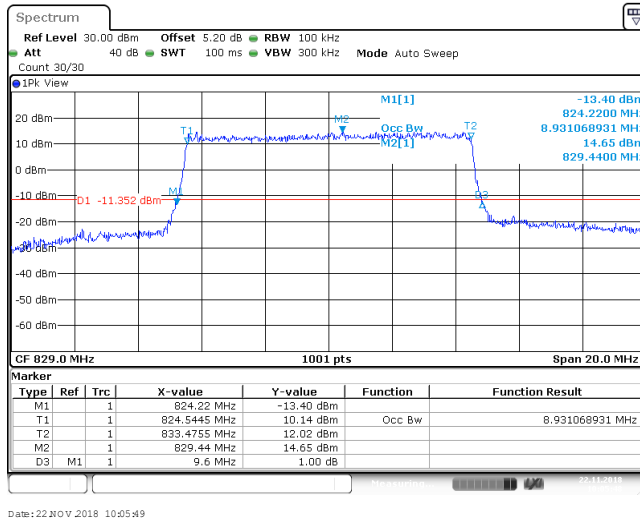

Band5_10MHz_16QAM_20525_50RB#0

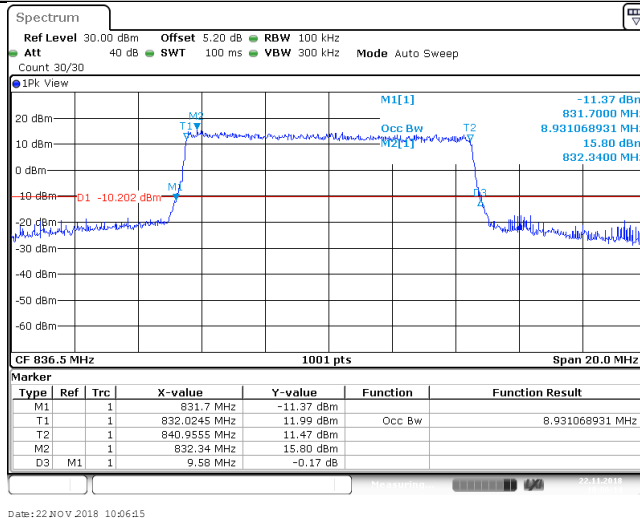

Unless otherwise stated the results shown in this test report refer only to the sample(s) tested and such sample(s) are retained for 90 days only.
除非另有說明，此報告結果僅對測試之樣品負責，同時此樣品僅保留90天。本報告未經本公司書面許可，不可部份複製。

This document is issued by the Company subject to its General Conditions of Service printed overleaf, available on request or accessible at www.sgs.com/terms_and_conditions.htm and, for electronic format documents, subject to Terms and Conditions for Electronic Documents at www.sgs.com/terms_e-document.htm. Attention is drawn to the limitation of liability, indemnification and jurisdiction issues defined therein. Any holder of this document is advised that information contained hereon reflects the Company's findings at the time of its intervention only and within the limits of Client's instructions, if any. The Company's sole responsibility is to its Client and this document does not exonerate parties to a transaction from exercising all their rights and obligations under the transaction documents. This document cannot be reproduced except in full, without prior written approval of the Company. Any unauthorized alteration, forgery or falsification of the content or appearance of this document is unlawful and offenders may be prosecuted to the fullest extent of the law.

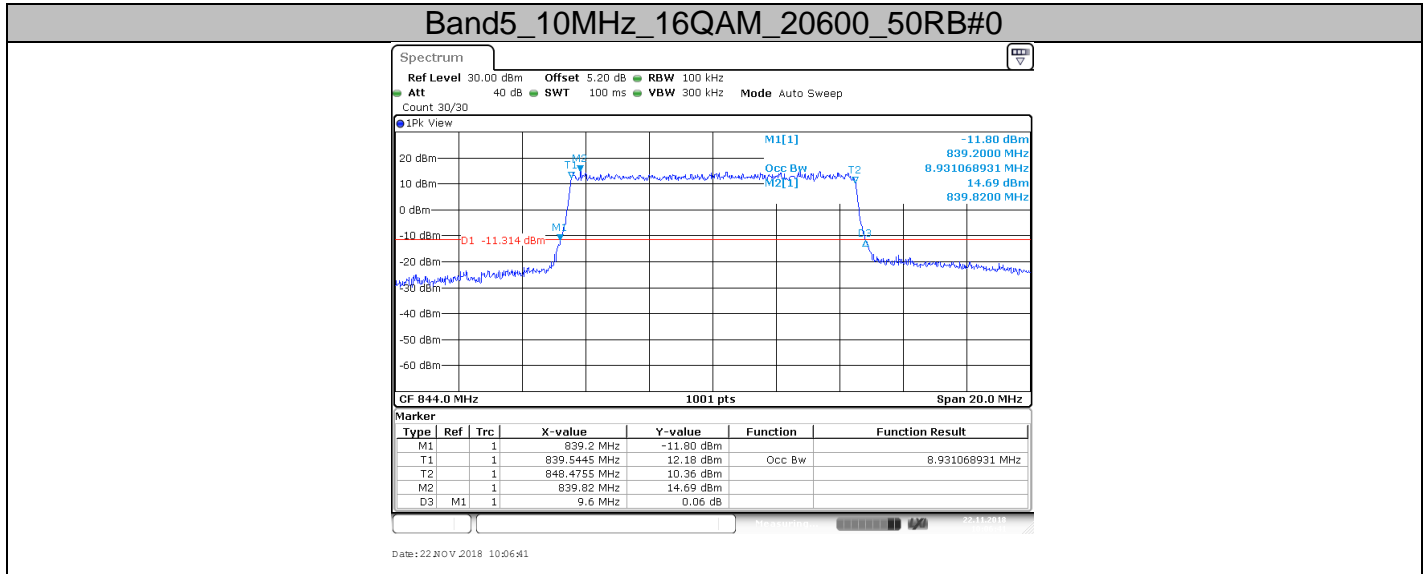

7.7. Measurement Result: LTE BAND 7 Mode

7.7.1.1. Test Result

BAND	Bandwidth	Modulation	Channel	RB Configuration	Occupied Bandwidth (MHz)	26dB Bandwidth (MHz)	Verdict
Band7	5MHz	QPSK	20775	25RB#0	4.466	4.840	PASS
Band7	5MHz	QPSK	21100	25RB#0	4.476	4.830	PASS
Band7	5MHz	QPSK	21425	25RB#0	4.466	4.840	PASS
Band7	5MHz	16QAM	20775	25RB#0	4.476	4.840	PASS
Band7	5MHz	16QAM	21100	25RB#0	4.486	4.840	PASS
Band7	5MHz	16QAM	21425	25RB#0	4.486	4.840	PASS
Band7	10MHz	QPSK	20800	50RB#0	8.931	9.620	PASS
Band7	10MHz	QPSK	21100	50RB#0	8.931	9.640	PASS
Band7	10MHz	QPSK	21400	50RB#0	8.931	9.620	PASS
Band7	10MHz	16QAM	20800	50RB#0	8.931	9.640	PASS
Band7	10MHz	16QAM	21100	50RB#0	8.931	9.640	PASS
Band7	10MHz	16QAM	21400	50RB#0	8.931	9.640	PASS
Band7	15MHz	QPSK	20825	75RB#0	13.457	14.700	PASS
Band7	15MHz	QPSK	21100	75RB#0	13.427	15.300	PASS
Band7	15MHz	QPSK	21375	75RB#0	13.457	14.700	PASS
Band7	15MHz	16QAM	20825	75RB#0	13.457	14.670	PASS
Band7	15MHz	16QAM	21100	75RB#0	13.427	14.670	PASS
Band7	15MHz	16QAM	21375	75RB#0	13.427	14.670	PASS
Band7	20MHz	QPSK	20850	100RB#0	17.862	19.240	PASS
Band7	20MHz	QPSK	21100	100RB#0	17.902	19.280	PASS
Band7	20MHz	QPSK	21350	100RB#0	17.902	19.360	PASS
Band7	20MHz	16QAM	20850	100RB#0	17.902	19.280	PASS
Band7	20MHz	16QAM	21100	100RB#0	17.862	19.320	PASS
Band7	20MHz	16QAM	21350	100RB#0	17.862	19.320	PASS

Unless otherwise stated the results shown in this test report refer only to the sample(s) tested and such sample(s) are retained for 90 days only.
除非另有說明，此報告結果僅對測試之樣品負責，同時此樣品僅保留90天。本報告未經本公司書面許可，不可部份複製。

This document is issued by the Company subject to its General Conditions of Service printed overleaf, available on request or accessible at www.sgs.com/terms_and_conditions.htm and, for electronic format documents, subject to Terms and Conditions for Electronic Documents at www.sgs.com/terms_e-document.htm. Attention is drawn to the limitation of liability, indemnification and jurisdiction issues defined therein. Any holder of this document is advised that information contained hereon reflects the Company's findings at the time of its intervention only and within the limits of Client's instructions, if any. The Company's sole responsibility is to its Client and this document does not exonerate parties to a transaction from exercising all their rights and obligations under the transaction documents. This document cannot be reproduced except in full, without prior written approval of the Company. Any unauthorized alteration, forgery or falsification of the content or appearance of this document is unlawful and offenders may be prosecuted to the fullest extent of the law.

7.7.1.2. Test Plots

Band7_5MHz_QPSK_20775_25RB#0

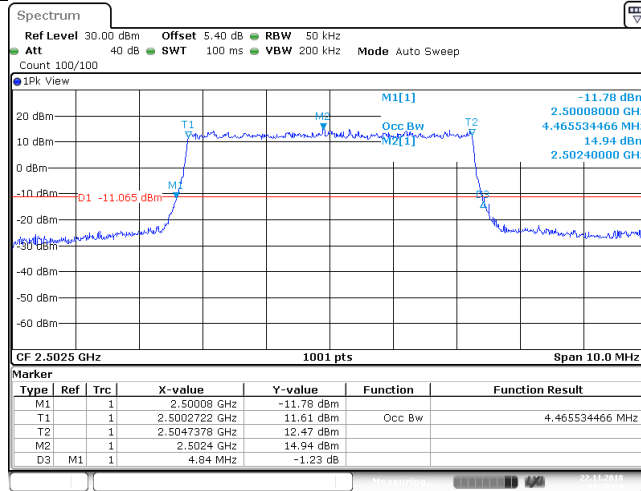

Date: 22 NOV 2018 09:38:24

Band7_5MHz_QPSK_21100_25RB#0

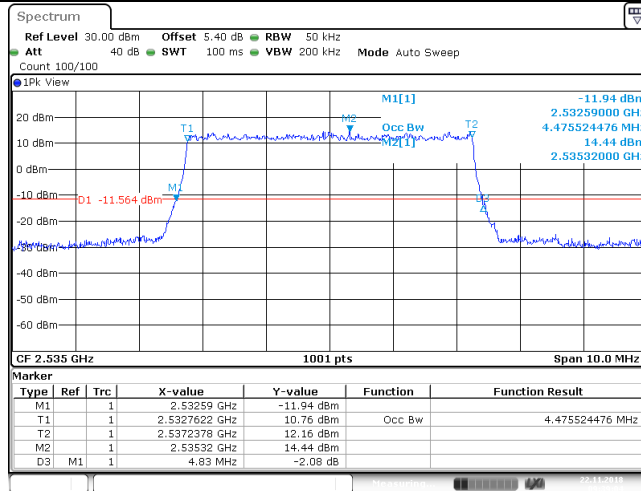

Date: 22 NOV 2018 09:39:04

Band7_5MHz_QPSK_21425_25RB#0

Unless otherwise stated the results shown in this test report refer only to the sample(s) tested and such sample(s) are retained for 90 days only.
除非另有說明，此報告結果僅對測試之樣品負責，同時此樣品僅保留90天。本報告未經本公司書面許可，不可部份複製。

This document is issued by the Company subject to its General Conditions of Service printed overleaf, available on request or accessible at www.sgs.com/terms_and_conditions.htm and, for electronic format documents, subject to Terms and Conditions for Electronic Documents at www.sgs.com/terms_e-document.htm. Attention is drawn to the limitation of liability, indemnification and jurisdiction issues defined therein. Any holder of this document is advised that information contained hereon reflects the Company's findings at the time of its intervention only and within the limits of Client's instructions, if any. The Company's sole responsibility is to its Client and this document does not exonerate parties to a transaction from exercising all their rights and obligations under the transaction documents. This document cannot be reproduced except in full, without prior written approval of the Company. Any unauthorized alteration, forgery or falsification of the content or appearance of this document is unlawful and offenders may be prosecuted to the fullest extent of the law.

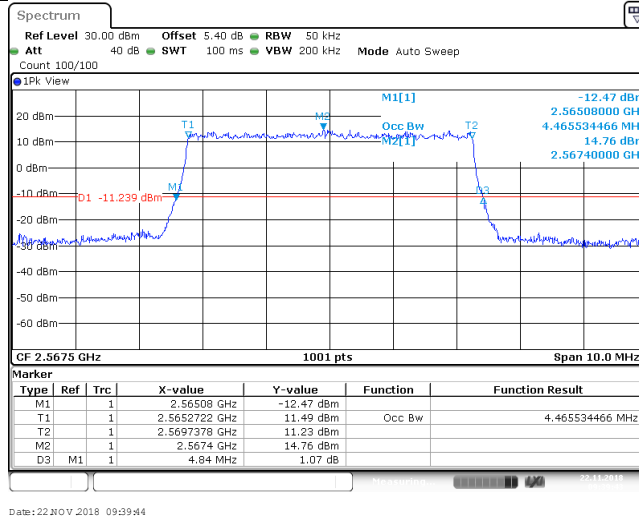

Band7_5MHz_16QAM_20775_25RB#0

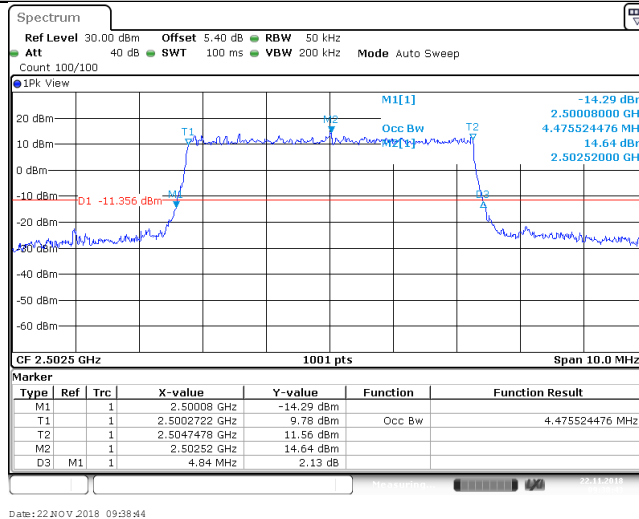

Band7_5MHz_16QAM_21100_25RB#0

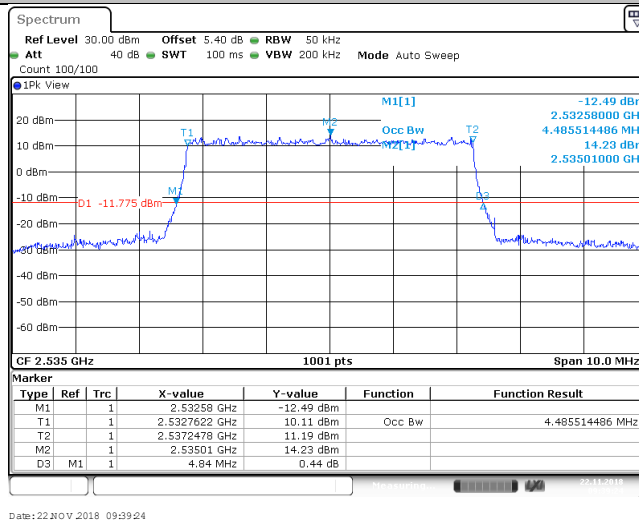

Band7_5MHz_16QAM_21425_25RB#0

Unless otherwise stated the results shown in this test report refer only to the sample(s) tested and such sample(s) are retained for 90 days only.
除非另有說明，此報告結果僅對測試之樣品負責，同時此樣品僅保留90天。本報告未經本公司書面許可，不可部份複製。

This document is issued by the Company subject to its General Conditions of Service printed overleaf, available on request or accessible at www.sgs.com/terms_and_conditions.htm and, for electronic format documents, subject to Terms and Conditions for Electronic Documents at www.sgs.com/terms_e-document.htm. Attention is drawn to the limitation of liability, indemnification and jurisdiction issues defined therein. Any holder of this document is advised that information contained hereon reflects the Company's findings at the time of its intervention only and within the limits of Client's instructions, if any. The Company's sole responsibility is to its Client and this document does not exonerate parties to a transaction from exercising all their rights and obligations under the transaction documents. This document cannot be reproduced except in full, without prior written approval of the Company. Any unauthorized alteration, forgery or falsification of the content or appearance of this document is unlawful and offenders may be prosecuted to the fullest extent of the law.

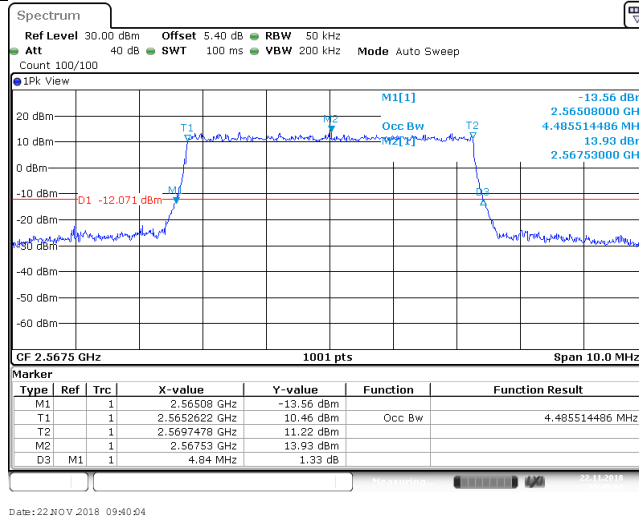

Band7_10MHz_QPSK_20800_50RB#0

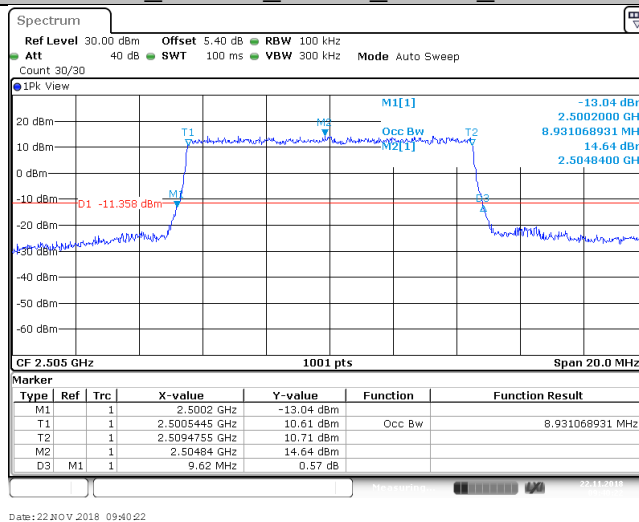

Band7_10MHz_QPSK_21100_50RB#0

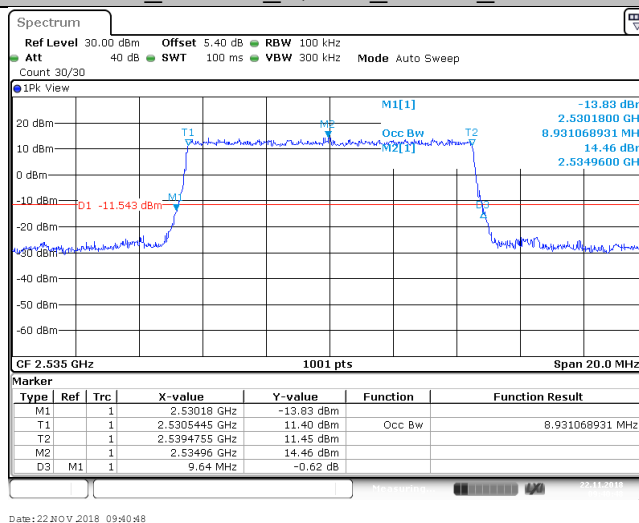

Band7_10MHz_QPSK_21400_50RB#0

Unless otherwise stated the results shown in this test report refer only to the sample(s) tested and such sample(s) are retained for 90 days only.
除非另有說明，此報告結果僅對測試之樣品負責，同時此樣品僅保留90天。本報告未經本公司書面許可，不可部份複製。

This document is issued by the Company subject to its General Conditions of Service printed overleaf, available on request or accessible at www.sgs.com/terms_and_conditions.htm and, for electronic format documents, subject to Terms and Conditions for Electronic Documents at www.sgs.com/terms_e-document.htm. Attention is drawn to the limitation of liability, indemnification and jurisdiction issues defined therein. Any holder of this document is advised that information contained hereon reflects the Company's findings at the time of its intervention only and within the limits of Client's instructions, if any. The Company's sole responsibility is to its Client and this document does not exonerate parties to a transaction from exercising all their rights and obligations under the transaction documents. This document cannot be reproduced except in full, without prior written approval of the Company. Any unauthorized alteration, forgery or falsification of the content or appearance of this document is unlawful and offenders may be prosecuted to the fullest extent of the law.

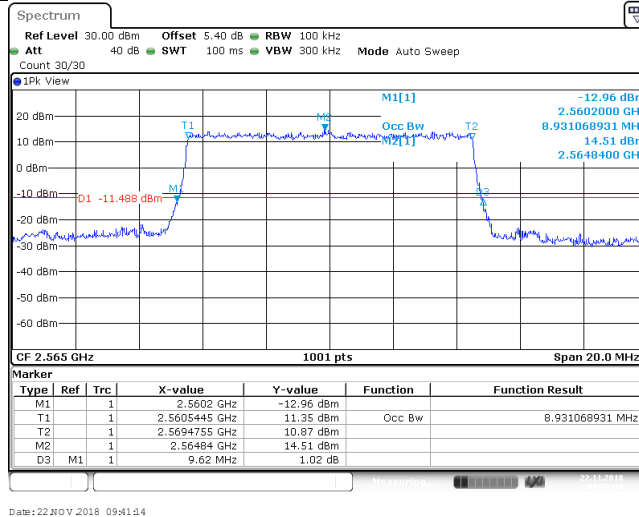

Band7_10MHz_16QAM_20800_50RB#0

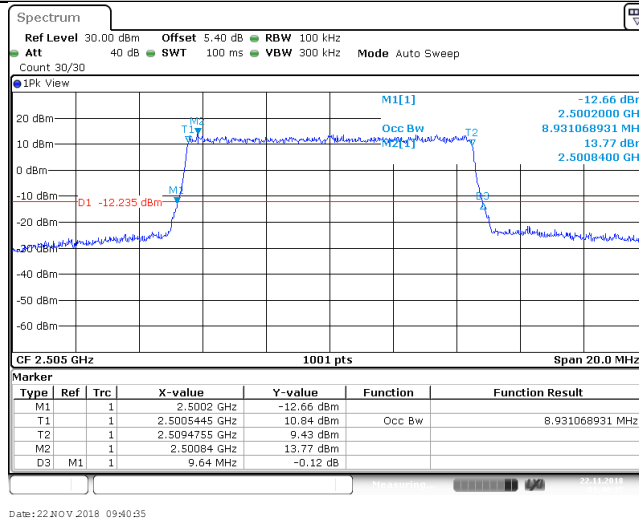

Band7_10MHz_16QAM_21100_50RB#0

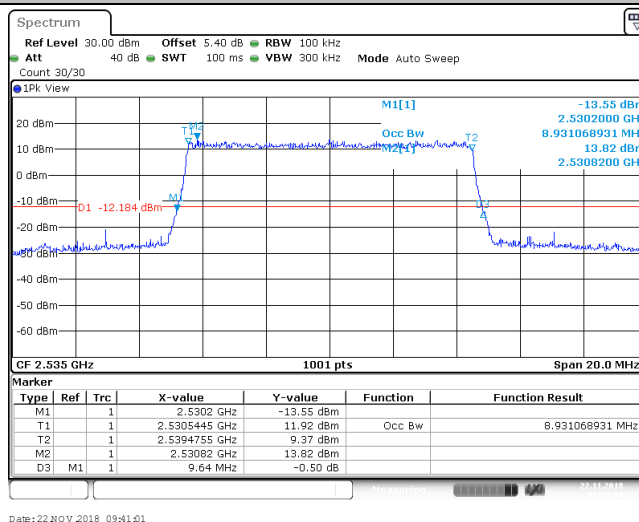

Band7_10MHz_16QAM_21400_50RB#0

Unless otherwise stated the results shown in this test report refer only to the sample(s) tested and such sample(s) are retained for 90 days only.
除非另有說明，此報告結果僅對測試之樣品負責，同時此樣品僅保留90天。本報告未經本公司書面許可，不可部份複製。

This document is issued by the Company subject to its General Conditions of Service printed overleaf, available on request or accessible at www.sgs.com/terms_and_conditions.htm and, for electronic format documents, subject to Terms and Conditions for Electronic Documents at www.sgs.com/terms_e-document.htm. Attention is drawn to the limitation of liability, indemnification and jurisdiction issues defined therein. Any holder of this document is advised that information contained hereon reflects the Company's findings at the time of its intervention only and within the limits of Client's instructions, if any. The Company's sole responsibility is to its Client and this document does not exonerate parties to a transaction from exercising all their rights and obligations under the transaction documents. This document cannot be reproduced except in full, without prior written approval of the Company. Any unauthorized alteration, forgery or falsification of the content or appearance of this document is unlawful and offenders may be prosecuted to the fullest extent of the law.

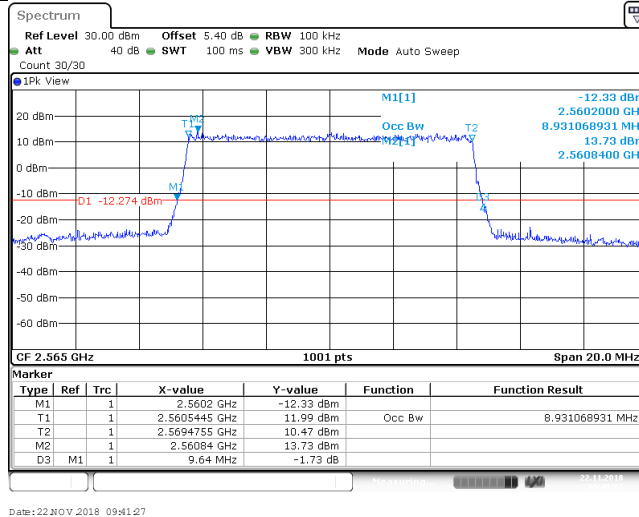

Band7_15MHz_QPSK_20825_75RB#0

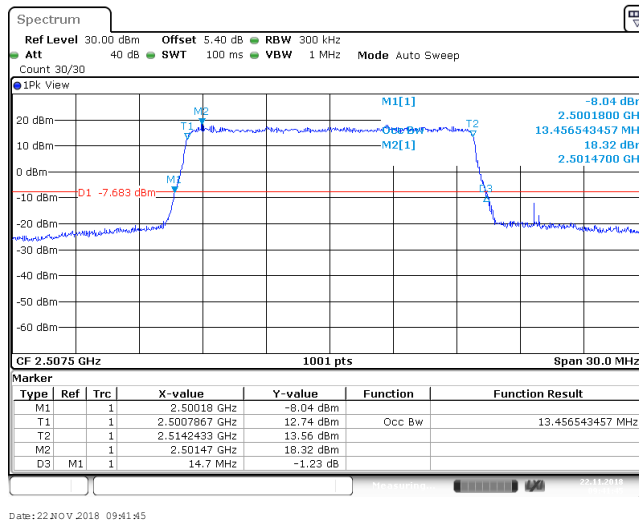

Band7_15MHz_QPSK_21100_75RB#0

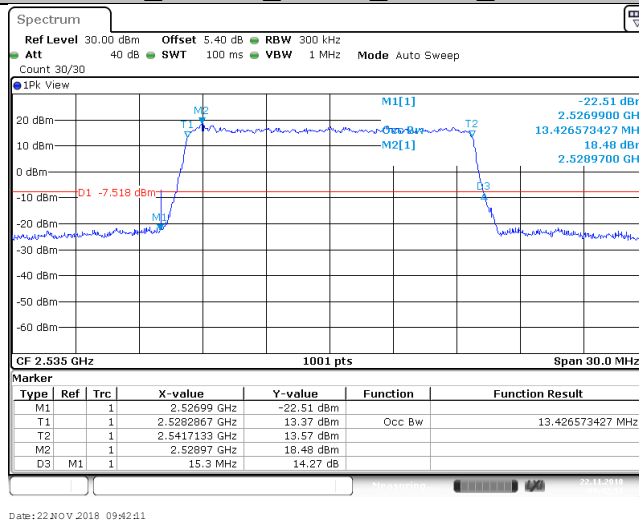

Band7_15MHz_QPSK_21375_75RB#0

Unless otherwise stated the results shown in this test report refer only to the sample(s) tested and such sample(s) are retained for 90 days only.
除非另有說明，此報告結果僅對測試之樣品負責，同時此樣品僅保留90天。本報告未經本公司書面許可，不可部份複製。

This document is issued by the Company subject to its General Conditions of Service printed overleaf, available on request or accessible at www.sgs.com/terms_and_conditions.htm and, for electronic format documents, subject to Terms and Conditions for Electronic Documents at www.sgs.com/terms_e-document.htm. Attention is drawn to the limitation of liability, indemnification and jurisdiction issues defined therein. Any holder of this document is advised that information contained hereon reflects the Company's findings at the time of its intervention only and within the limits of Client's instructions, if any. The Company's sole responsibility is to its Client and this document does not exonerate parties to a transaction from exercising all their rights and obligations under the transaction documents. This document cannot be reproduced except in full, without prior written approval of the Company. Any unauthorized alteration, forgery or falsification of the content or appearance of this document is unlawful and offenders may be prosecuted to the fullest extent of the law.

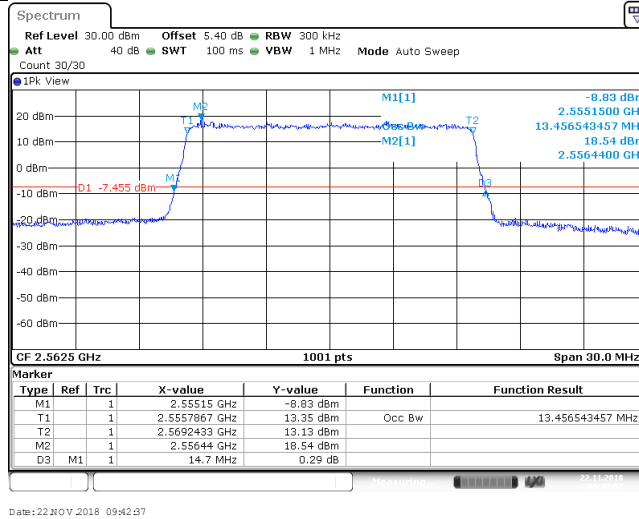

Band7_15MHz_16QAM_20825_75RB#0

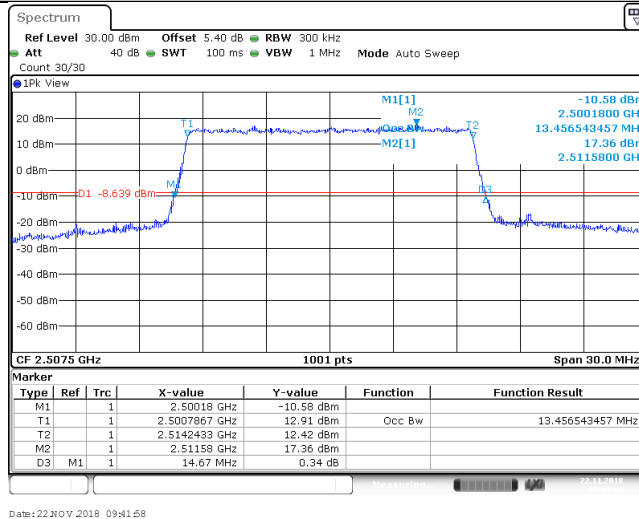

Band7_15MHz_16QAM_21100_75RB#0

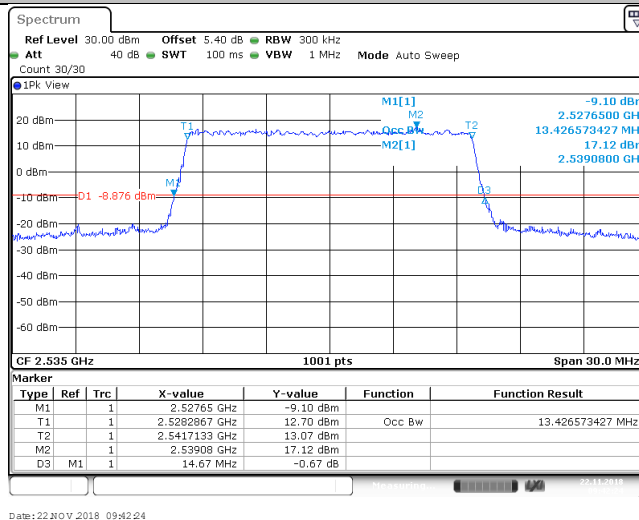

Band7_15MHz_16QAM_21375_75RB#0

Unless otherwise stated the results shown in this test report refer only to the sample(s) tested and such sample(s) are retained for 90 days only.
除非另有說明，此報告結果僅對測試之樣品負責，同時此樣品僅保留90天。本報告未經本公司書面許可，不可部份複製。

This document is issued by the Company subject to its General Conditions of Service printed overleaf, available on request or accessible at www.sgs.com/terms_and_conditions.htm and, for electronic format documents, subject to Terms and Conditions for Electronic Documents at www.sgs.com/terms_e-document.htm. Attention is drawn to the limitation of liability, indemnification and jurisdiction issues defined therein. Any holder of this document is advised that information contained hereon reflects the Company's findings at the time of its intervention only and within the limits of Client's instructions, if any. The Company's sole responsibility is to its Client and this document does not exonerate parties to a transaction from exercising all their rights and obligations under the transaction documents. This document cannot be reproduced except in full, without prior written approval of the Company. Any unauthorized alteration, forgery or falsification of the content or appearance of this document is unlawful and offenders may be prosecuted to the fullest extent of the law.

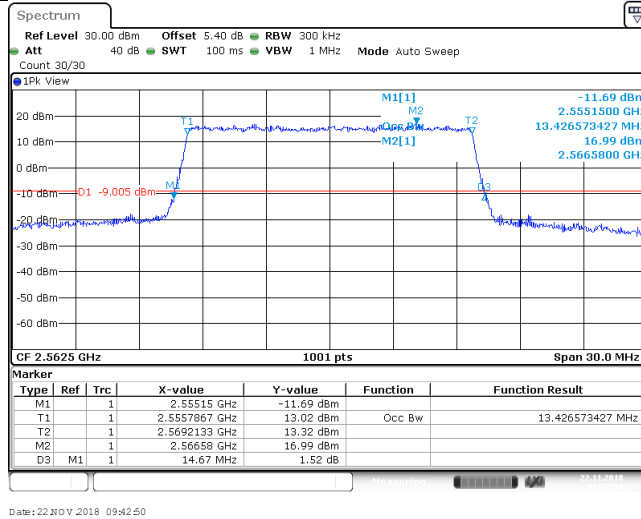

Band7 20MHz_QPSK_20850_100RB#0

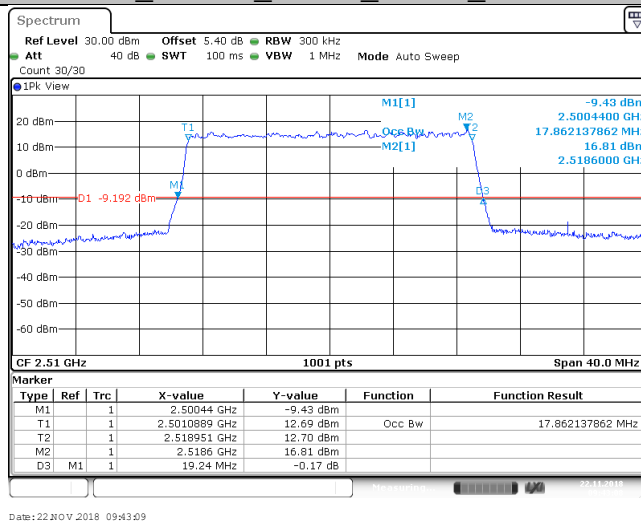

Band7_20MHz_QPSK_21100_100RB#0

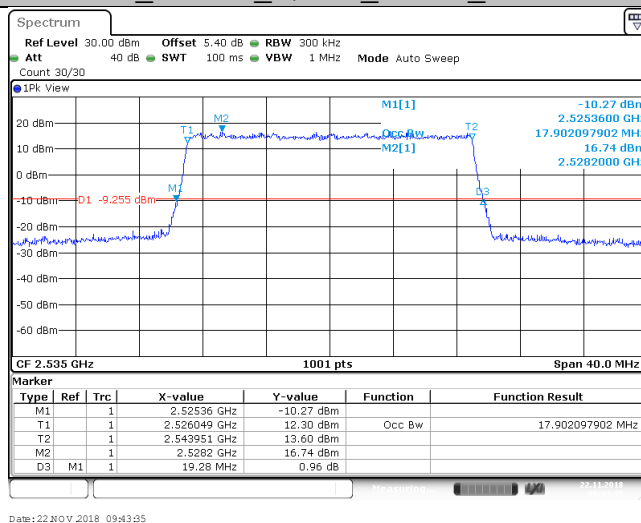

Band7_20MHz_QPSK_21350_100RB#0

Unless otherwise stated the results shown in this test report refer only to the sample(s) tested and such sample(s) are retained for 90 days only.
除非另有說明，此報告結果僅對測試之樣品負責，同時此樣品僅保留90天。本報告未經本公司書面許可，不可部份複製。

This document is issued by the Company subject to its General Conditions of Service printed overleaf, available on request or accessible at www.sgs.com/terms_and_conditions.htm and, for electronic format documents, subject to Terms and Conditions for Electronic Documents at www.sgs.com/terms_e-document.htm. Attention is drawn to the limitation of liability, indemnification and jurisdiction issues defined therein. Any holder of this document is advised that information contained hereon reflects the Company's findings at the time of its intervention only and within the limits of Client's instructions, if any. The Company's sole responsibility is to its Client and this document does not exonerate parties to a transaction from exercising all their rights and obligations under the transaction documents. This document cannot be reproduced except in full, without prior written approval of the Company. Any unauthorized alteration, forgery or falsification of the content or appearance of this document is unlawful and offenders may be prosecuted to the fullest extent of the law.

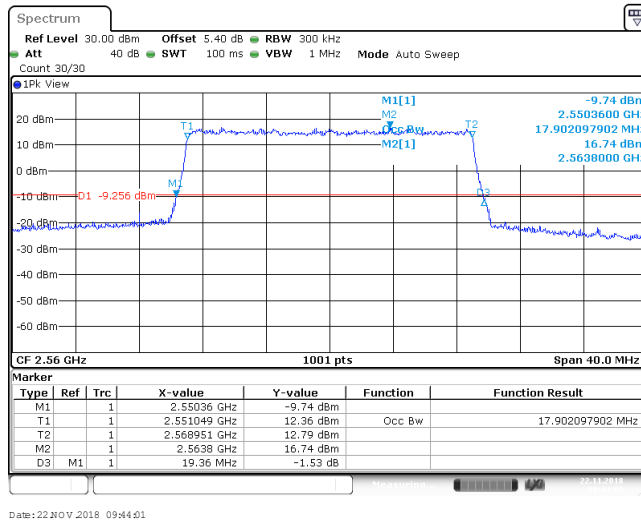

Date: 22 NOV 2018 09:44:01

Band7_20MHz_16QAM_20850_100RB#0

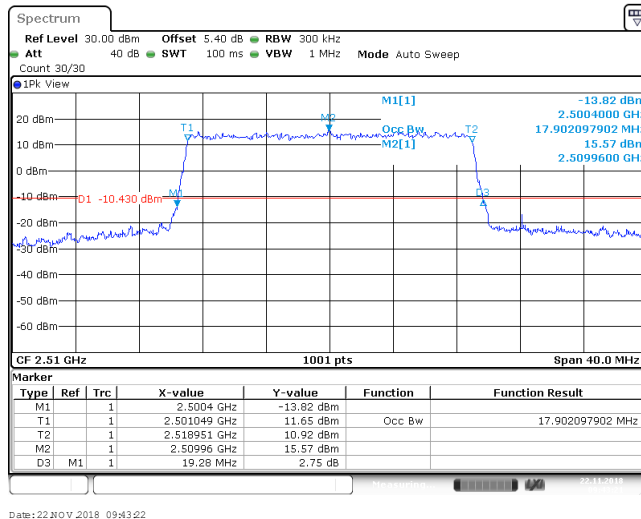

Date: 22 NOV 2018 09:43:22

Band7_20MHz_16QAM_21100_100RB#0

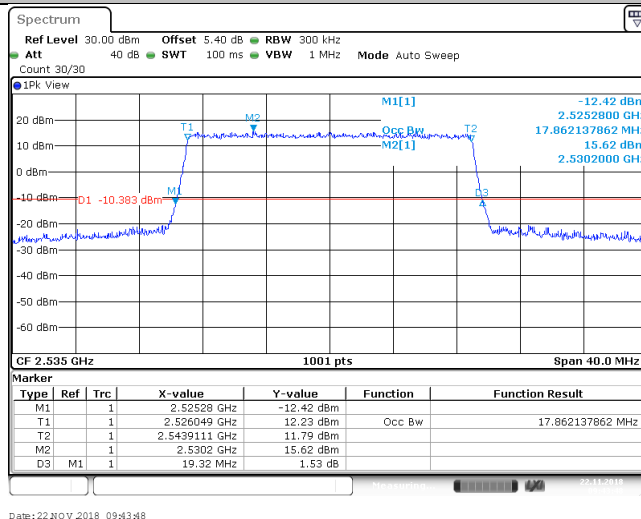

Date: 22 NOV 2018 09:43:48

Unless otherwise stated the results shown in this test report refer only to the sample(s) tested and such sample(s) are retained for 90 days only.
除非另有說明，此報告結果僅對測試之樣品負責，同時此樣品僅保留90天。本報告未經本公司書面許可，不可部份複製。

This document is issued by the Company subject to its General Conditions of Service printed overleaf, available on request or accessible at www.sgs.com/terms_and_conditions.htm and, for electronic format documents, subject to Terms and Conditions for Electronic Documents at www.sgs.com/terms_e-document.htm. Attention is drawn to the limitation of liability, indemnification and jurisdiction issues defined therein. Any holder of this document is advised that information contained hereon reflects the Company's findings at the time of its intervention only and within the limits of Client's instructions, if any. The Company's sole responsibility is to its Client and this document does not exonerate parties to a transaction from exercising all their rights and obligations under the transaction documents. This document cannot be reproduced except in full, without prior written approval of the Company. Any unauthorized alteration, forgery or falsification of the content or appearance of this document is unlawful and offenders may be prosecuted to the fullest extent of the law.

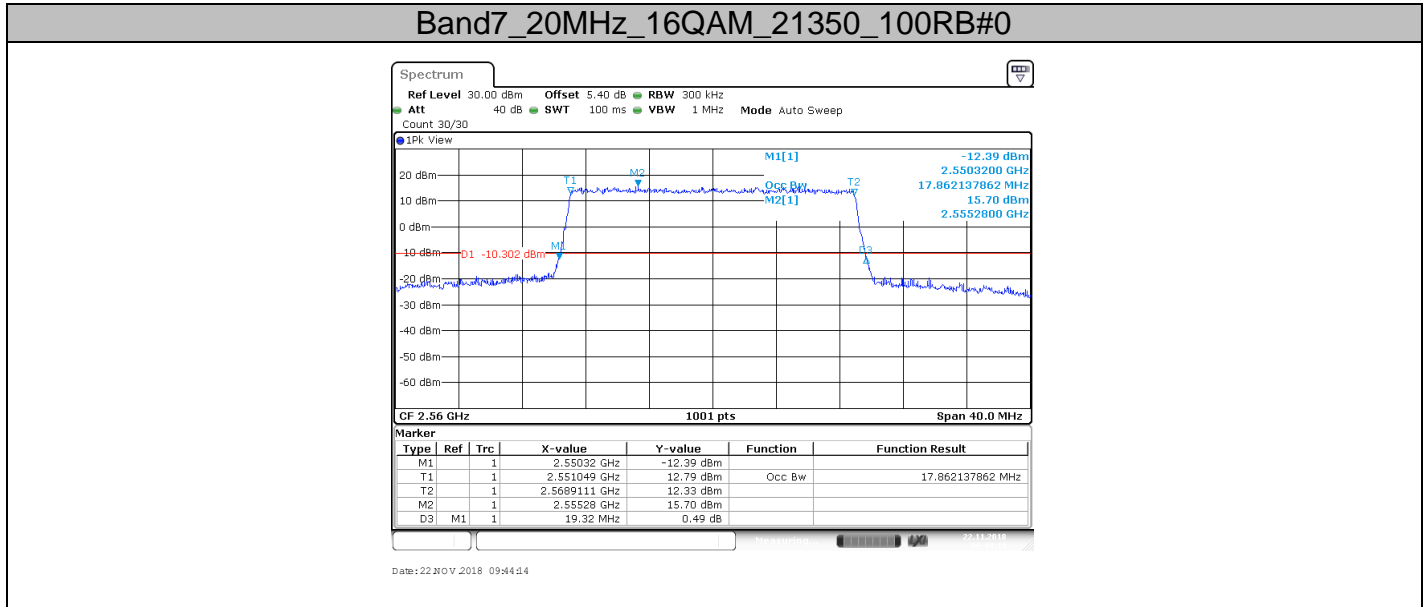

7.8. Measurement Result: LTE BAND 41 Mode

7.8.1.1. Test Result

BAND	Bandwidth	Modulation	Channel	RB Configuration	Occupied Bandwidth (MHz)	26dB Bandwidth (MHz)	Verdict
Band41	5MHz	QPSK	40065	25RB#0	4.466	4.940	PASS
Band41	5MHz	QPSK	40640	25RB#0	4.466	5.120	PASS
Band41	5MHz	QPSK	41215	25RB#0	4.466	4.870	PASS
Band41	5MHz	16QAM	40065	25RB#0	4.486	4.870	PASS
Band41	5MHz	16QAM	40640	25RB#0	4.476	4.850	PASS
Band41	5MHz	16QAM	41215	25RB#0	4.496	4.890	PASS
Band41	10MHz	QPSK	40090	50RB#0	8.911	9.860	PASS
Band41	10MHz	QPSK	40640	50RB#0	8.911	9.860	PASS
Band41	10MHz	QPSK	41190	50RB#0	8.911	9.780	PASS
Band41	10MHz	16QAM	40090	50RB#0	8.931	9.520	PASS
Band41	10MHz	16QAM	40640	50RB#0	8.931	9.600	PASS
Band41	10MHz	16QAM	41190	50RB#0	8.911	9.600	PASS
Band41	15MHz	QPSK	40115	75RB#0	13.487	16.350	PASS
Band41	15MHz	QPSK	40640	75RB#0	13.487	16.680	PASS
Band41	15MHz	QPSK	41165	75RB#0	13.487	16.950	PASS
Band41	15MHz	16QAM	40115	75RB#0	13.427	15.510	PASS
Band41	15MHz	16QAM	40640	75RB#0	13.457	15.300	PASS
Band41	15MHz	16QAM	41165	75RB#0	13.457	15.270	PASS
Band41	20MHz	QPSK	40140	100RB#0	17.942	20.360	PASS
Band41	20MHz	QPSK	40640	100RB#0	17.942	20.360	PASS
Band41	20MHz	QPSK	41140	100RB#0	17.902	19.920	PASS
Band41	20MHz	16QAM	40140	100RB#0	17.862	20.800	PASS
Band41	20MHz	16QAM	40640	100RB#0	17.902	20.600	PASS
Band41	20MHz	16QAM	41140	100RB#0	17.902	19.440	PASS

Unless otherwise stated the results shown in this test report refer only to the sample(s) tested and such sample(s) are retained for 90 days only.

除非另有說明，此報告結果僅對測試之樣品負責，同時此樣品僅保留90天。本報告未經本公司書面許可，不可部份複製。

This document is issued by the Company subject to its General Conditions of Service printed overleaf, available on request or accessible at www.sgs.com/terms_and_conditions.htm and, for electronic format documents, subject to Terms and Conditions for Electronic Documents at www.sgs.com/terms_e-document.htm. Attention is drawn to the limitation of liability, indemnification and jurisdiction issues defined therein. Any holder of this document is advised that information contained hereon reflects the Company's findings at the time of its intervention only and within the limits of Client's instructions, if any. The Company's sole responsibility is to its Client and this document does not exonerate parties to a transaction from exercising all their rights and obligations under the transaction documents. This document cannot be reproduced except in full, without prior written approval of the Company. Any unauthorized alteration, forgery or falsification of the content or appearance of this document is unlawful and offenders may be prosecuted to the fullest extent of the law.

7.8.1.2. Test Plots

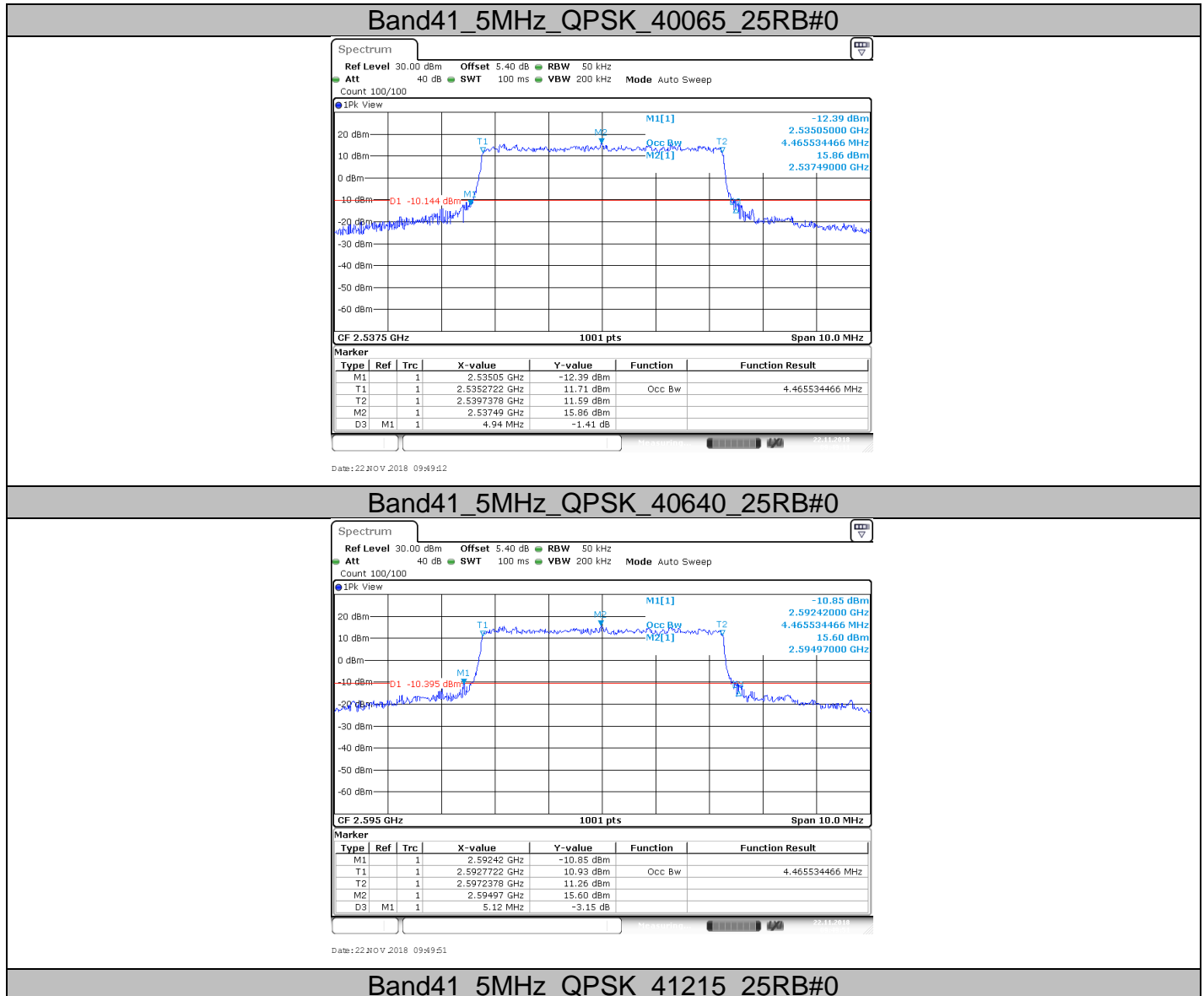

Unless otherwise stated the results shown in this test report refer only to the sample(s) tested and such sample(s) are retained for 90 days only.
除非另有說明，此報告結果僅對測試之樣品負責，同時此樣品僅保留90天。本報告未經本公司書面許可，不可部份複製。

This document is issued by the Company subject to its General Conditions of Service printed overleaf, available on request or accessible at www.sgs.com/terms_and_conditions.htm and, for electronic format documents, subject to Terms and Conditions for Electronic Documents at www.sgs.com/terms_e-document.htm. Attention is drawn to the limitation of liability, indemnification and jurisdiction issues defined therein. Any holder of this document is advised that information contained hereon reflects the Company's findings at the time of its intervention only and within the limits of Client's instructions, if any. The Company's sole responsibility is to its Client and this document does not exonerate parties to a transaction from exercising all their rights and obligations under the transaction documents. This document cannot be reproduced except in full, without prior written approval of the Company. Any unauthorized alteration, forgery or falsification of the content or appearance of this document is unlawful and offenders may be prosecuted to the fullest extent of the law.

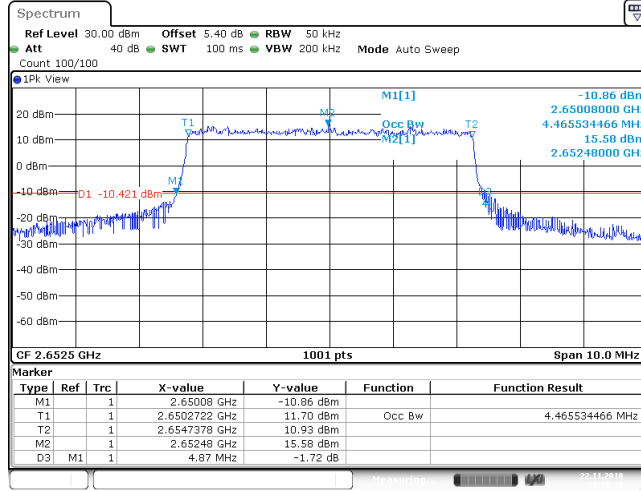

Band41_5MHz_16QAM_40065_25RB#0

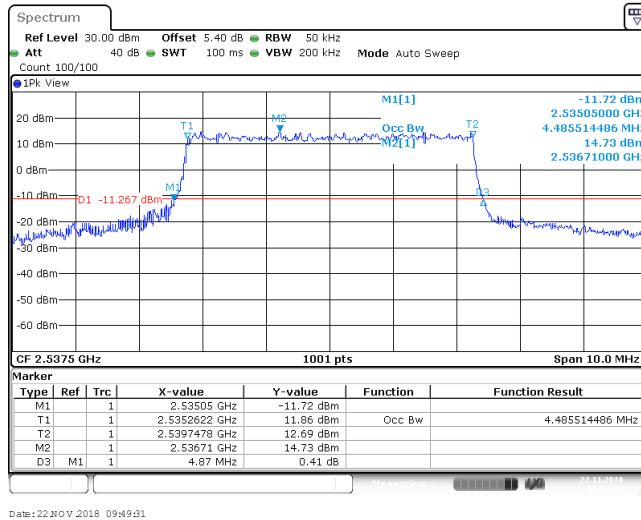

Band41_5MHz_16QAM_40640_25RB#0

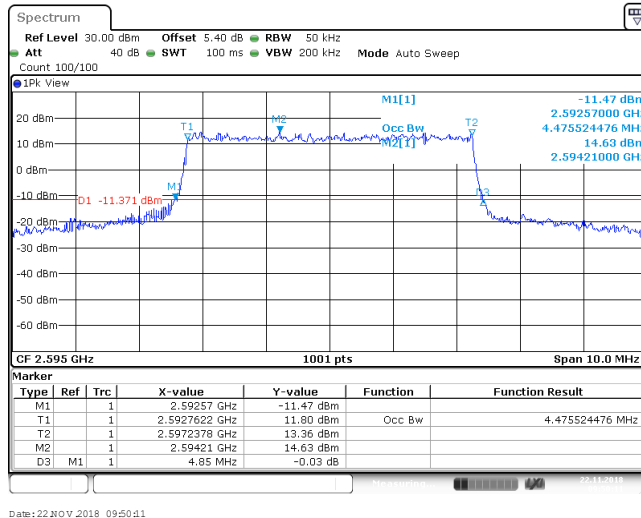

Unless otherwise stated the results shown in this test report refer only to the sample(s) tested and such sample(s) are retained for 90 days only.
除非另有說明，此報告結果僅對測試之樣品負責，同時此樣品僅保留90天。本報告未經本公司書面許可，不可部份複製。

This document is issued by the Company subject to its General Conditions of Service printed overleaf, available on request or accessible at www.sgs.com/terms_and_conditions.htm and, for electronic format documents, subject to Terms and Conditions for Electronic Documents at www.sgs.com/terms_e-document.htm. Attention is drawn to the limitation of liability, indemnification and jurisdiction issues defined therein. Any holder of this document is advised that information contained hereon reflects the Company's findings at the time of its intervention only and within the limits of Client's instructions, if any. The Company's sole responsibility is to its Client and this document does not exonerate parties to a transaction from exercising all their rights and obligations under the transaction documents. This document cannot be reproduced except in full, without prior written approval of the Company. Any unauthorized alteration, forgery or falsification of the content or appearance of this document is unlawful and offenders may be prosecuted to the fullest extent of the law.

Band41_5MHz_16QAM_41215_25RB#0

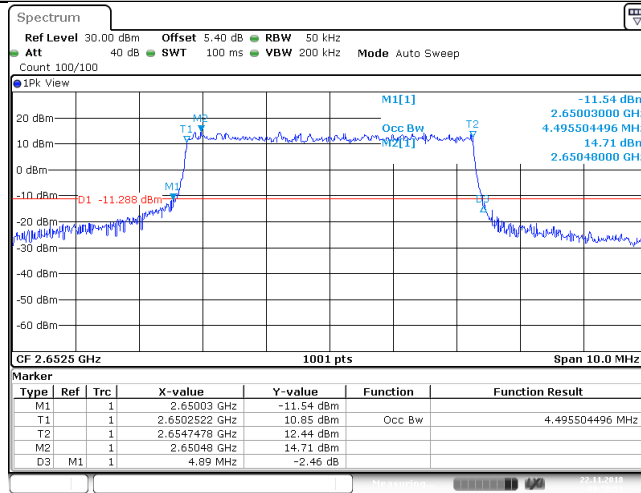

Date: 22 NOV 2018 09:50:51

Band41_10MHz_QPSK_40090_50RB#0

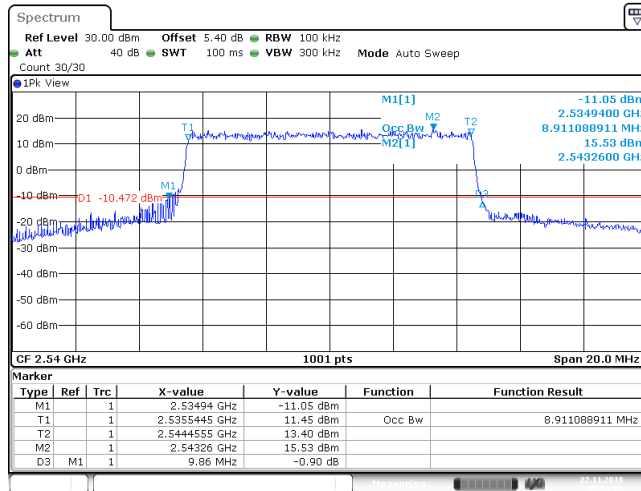

Date: 22 NOV 2018 09:51:09

Band41_10MHz_QPSK_40640_50RB#0

Unless otherwise stated the results shown in this test report refer only to the sample(s) tested and such sample(s) are retained for 90 days only.
除非另有說明，此報告結果僅對測試之樣品負責，同時此樣品僅保留90天。本報告未經本公司書面許可，不可部份複製。

This document is issued by the Company subject to its General Conditions of Service printed overleaf, available on request or accessible at www.sgs.com/terms_and_conditions.htm and, for electronic format documents, subject to Terms and Conditions for Electronic Documents at www.sgs.com/terms_e-document.htm. Attention is drawn to the limitation of liability, indemnification and jurisdiction issues defined therein. Any holder of this document is advised that information contained hereon reflects the Company's findings at the time of its intervention only and within the limits of Client's instructions, if any. The Company's sole responsibility is to its Client and this document does not exonerate parties to a transaction from exercising all their rights and obligations under the transaction documents. This document cannot be reproduced except in full, without prior written approval of the Company. Any unauthorized alteration, forgery or falsification of the content or appearance of this document is unlawful and offenders may be prosecuted to the fullest extent of the law.

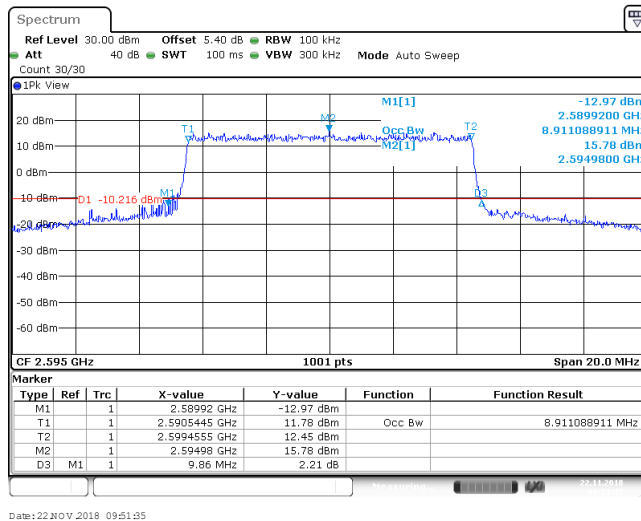

Band41_10MHz_QPSK_41190_50RB#0

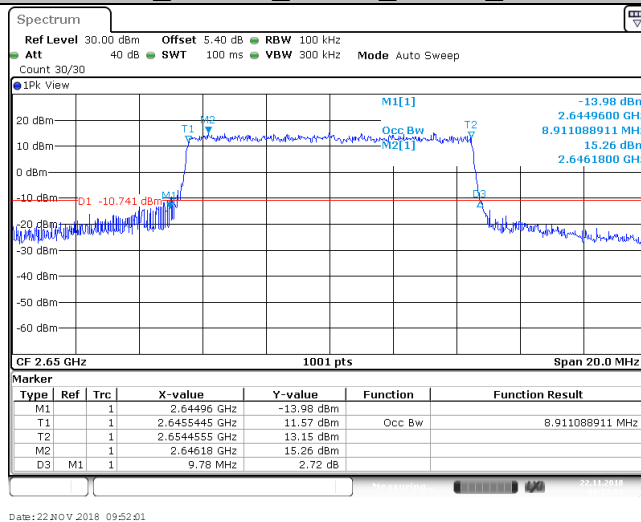

Band41_10MHz_16QAM_40090_50RB#0

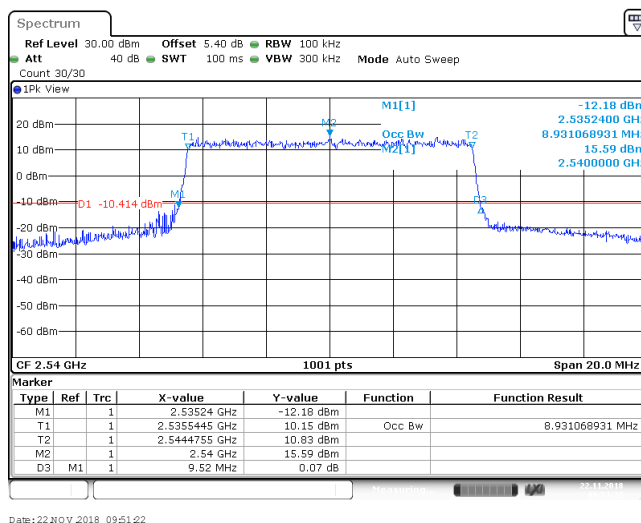

Unless otherwise stated the results shown in this test report refer only to the sample(s) tested and such sample(s) are retained for 90 days only.
除非另有說明，此報告結果僅對測試之樣品負責，同時此樣品僅保留90天。本報告未經本公司書面許可，不可部份複製。

This document is issued by the Company subject to its General Conditions of Service printed overleaf, available on request or accessible at www.sgs.com/terms_and_conditions.htm and, for electronic format documents, subject to Terms and Conditions for Electronic Documents at www.sgs.com/terms_e-document.htm. Attention is drawn to the limitation of liability, indemnification and jurisdiction issues defined therein. Any holder of this document is advised that information contained hereon reflects the Company's findings at the time of its intervention only and within the limits of Client's instructions, if any. The Company's sole responsibility is to its Client and this document does not exonerate parties to a transaction from exercising all their rights and obligations under the transaction documents. This document cannot be reproduced except in full, without prior written approval of the Company. Any unauthorized alteration, forgery or falsification of the content or appearance of this document is unlawful and offenders may be prosecuted to the fullest extent of the law.

Band41_10MHz_16QAM_40640_50RB#0

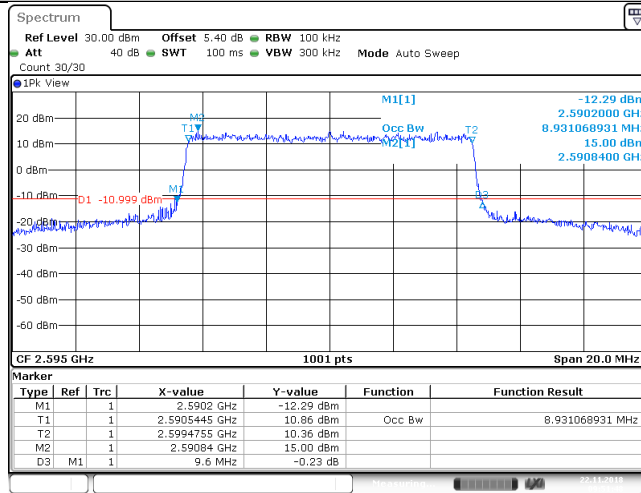

Date: 22 NOV 2018 09:51:48

Band41_10MHz_16QAM_41190_50RB#0

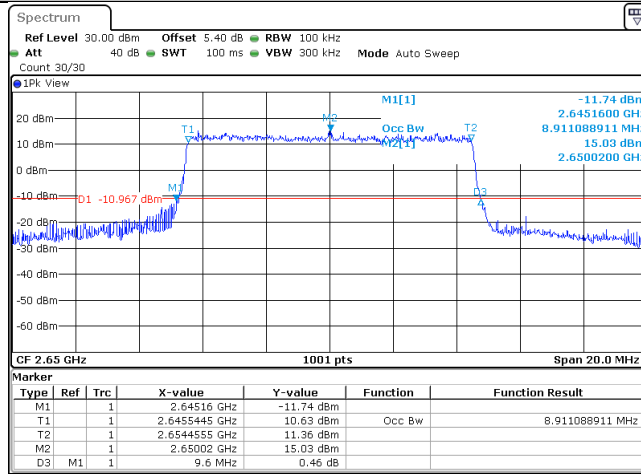

Date: 22 NOV 2018 09:52:14

Band41_15MHz_QPSK_40115_75RB#0

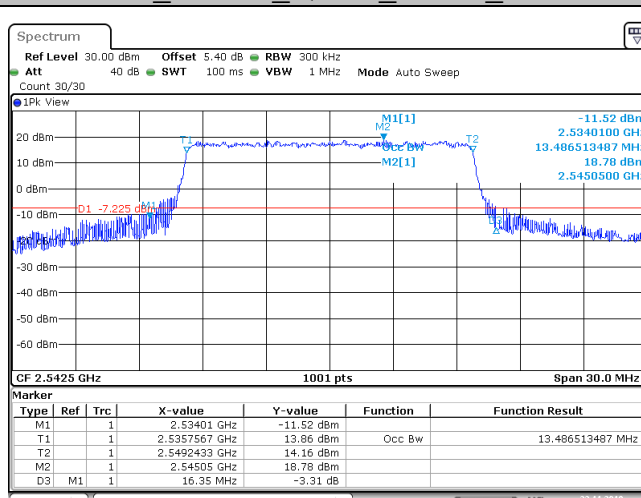

Date: 22 NOV 2018 09:52:33

Unless otherwise stated the results shown in this test report refer only to the sample(s) tested and such sample(s) are retained for 90 days only.
除非另有說明，此報告結果僅對測試之樣品負責，同時此樣品僅保留90天。本報告未經本公司書面許可，不可部份複製。

This document is issued by the Company subject to its General Conditions of Service printed overleaf, available on request or accessible at www.sgs.com/terms_and_conditions.htm and, for electronic format documents, subject to Terms and Conditions for Electronic Documents at www.sgs.com/terms_e-document.htm. Attention is drawn to the limitation of liability, indemnification and jurisdiction issues defined therein. Any holder of this document is advised that information contained hereon reflects the Company's findings at the time of its intervention only and within the limits of Client's instructions, if any. The Company's sole responsibility is to its Client and this document does not exonerate parties to a transaction from exercising all their rights and obligations under the transaction documents. This document cannot be reproduced except in full, without prior written approval of the Company. Any unauthorized alteration, forgery or falsification of the content or appearance of this document is unlawful and offenders may be prosecuted to the fullest extent of the law.

Band41_15MHz_QPSK_40640_75RB#0

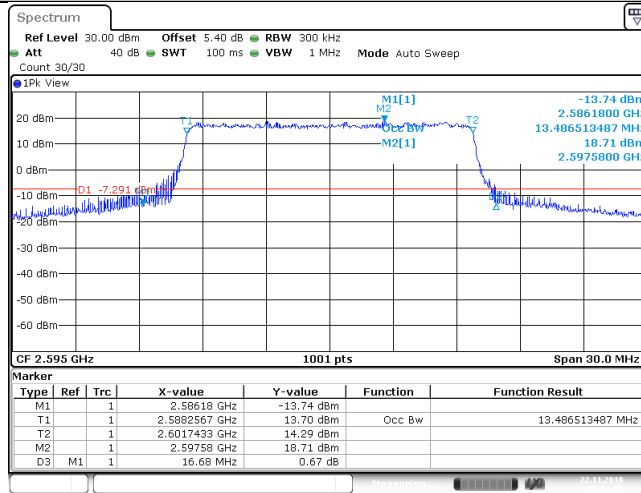

Date: 22 NOV 2018 09:52:59

Band41_15MHz_QPSK_41165_75RB#0

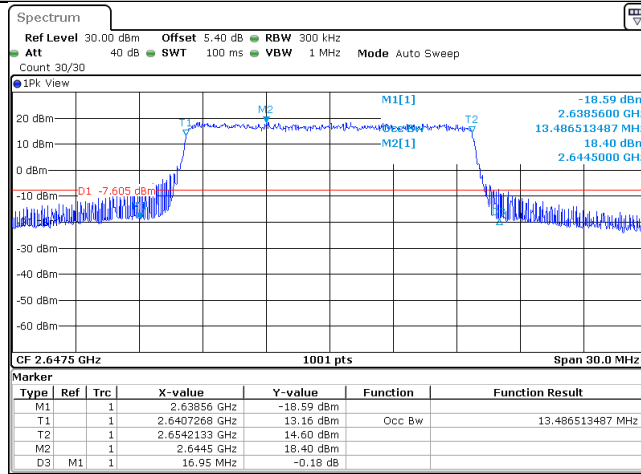

Date: 22 NOV 2018 09:53:25

Band41_15MHz_16QAM_40115_75RB#0

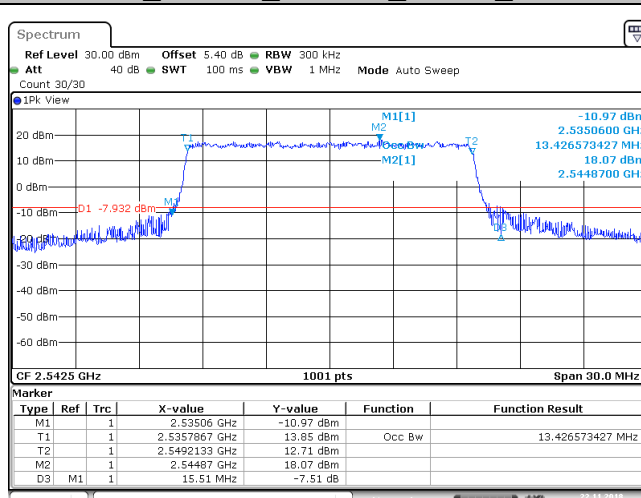

Date: 22 NOV 2018 09:52:16

Unless otherwise stated the results shown in this test report refer only to the sample(s) tested and such sample(s) are retained for 90 days only.
 除非另有說明，此報告結果僅對測試之樣品負責，同時此樣品僅保留90天。本報告未經本公司書面許可，不可部份複製。

This document is issued by the Company subject to its General Conditions of Service printed overleaf, available on request or accessible at www.sgs.com/terms_and_conditions.htm and, for electronic format documents, subject to Terms and Conditions for Electronic Documents at www.sgs.com/terms_e-document.htm. Attention is drawn to the limitation of liability, indemnification and jurisdiction issues defined therein. Any holder of this document is advised that information contained hereon reflects the Company's findings at the time of its intervention only and within the limits of Client's instructions, if any. The Company's sole responsibility is to its Client and this document does not exonerate parties to a transaction from exercising all their rights and obligations under the transaction documents. This document cannot be reproduced except in full, without prior written approval of the Company. Any unauthorized alteration, forgery or falsification of the content or appearance of this document is unlawful and offenders may be prosecuted to the fullest extent of the law.

Band41_15MHz_16QAM_40640_75RB#0

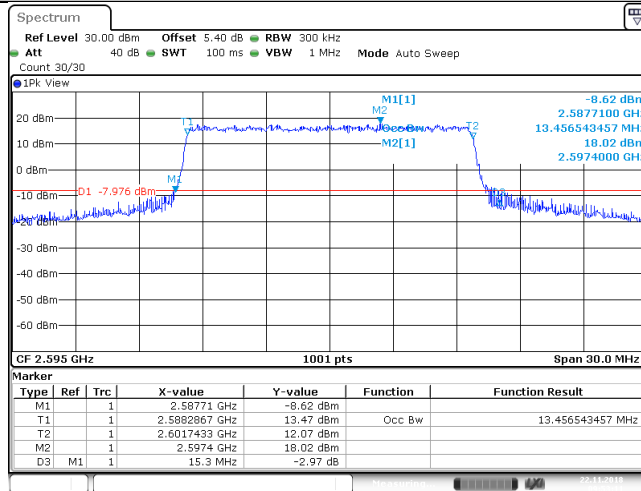

Band41_15MHz_16QAM_41165_75RB#0

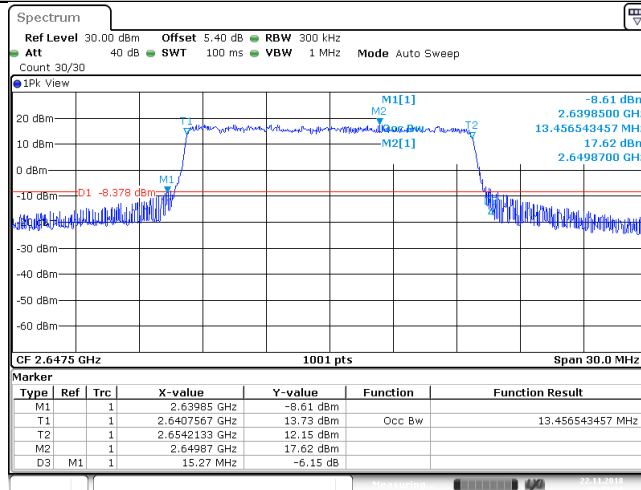

Band41_20MHz_QPSK_40140_100RB#0

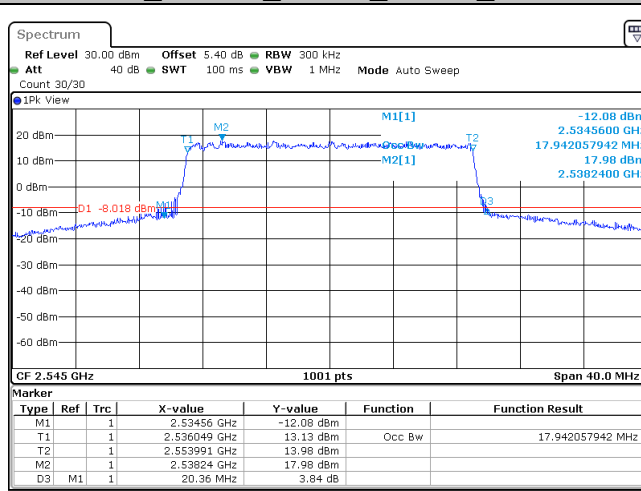

Unless otherwise stated the results shown in this test report refer only to the sample(s) tested and such sample(s) are retained for 90 days only.
 除非另有說明，此報告結果僅對測試之樣品負責，同時此樣品僅保留90天。本報告未經本公司書面許可，不可部份複製。

This document is issued by the Company subject to its General Conditions of Service printed overleaf, available on request or accessible at www.sgs.com/terms_and_conditions.htm and, for electronic format documents, subject to Terms and Conditions for Electronic Documents at www.sgs.com/terms_e-document.htm. Attention is drawn to the limitation of liability, indemnification and jurisdiction issues defined therein. Any holder of this document is advised that information contained hereon reflects the Company's findings at the time of its intervention only and within the limits of Client's instructions, if any. The Company's sole responsibility is to its Client and this document does not exonerate parties to a transaction from exercising all their rights and obligations under the transaction documents. This document cannot be reproduced except in full, without prior written approval of the Company. Any unauthorized alteration, forgery or falsification of the content or appearance of this document is unlawful and offenders may be prosecuted to the fullest extent of the law.

Band41_20MHz_QPSK_40640_100RB#0

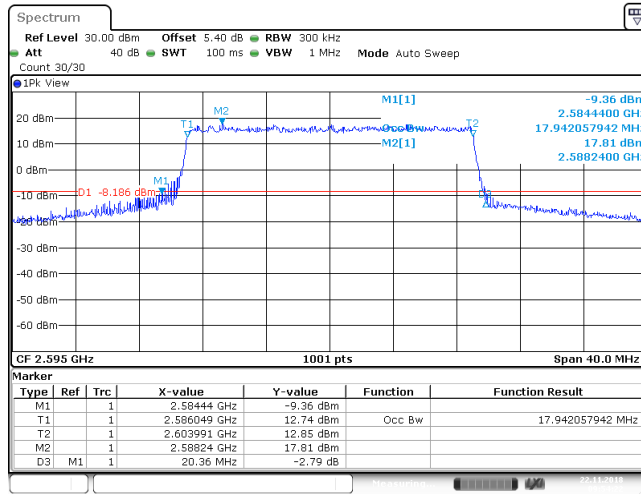

Date: 22 NOV 2018 09:54:22

Band41_20MHz_QPSK_41140_100RB#0

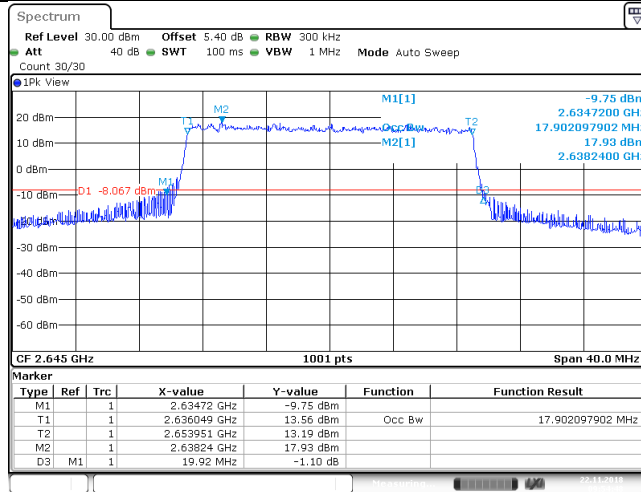

Date: 22 NOV 2018 09:54:18

Band41_20MHz_16QAM_40140_100RB#0

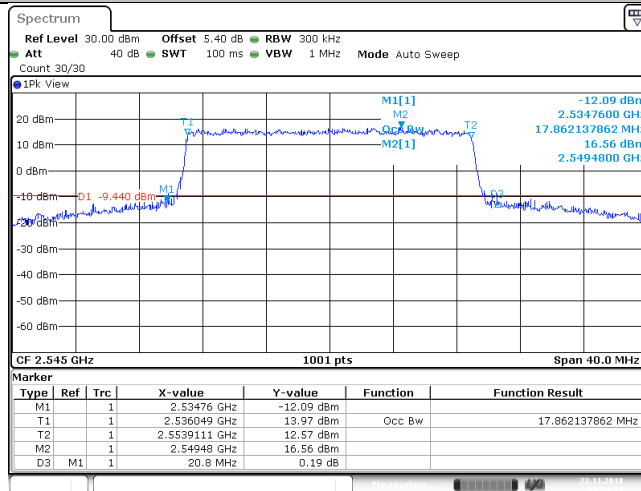

Date: 22 NOV 2018 09:54:09

Unless otherwise stated the results shown in this test report refer only to the sample(s) tested and such sample(s) are retained for 90 days only.
除非另有說明，此報告結果僅對測試之樣品負責，同時此樣品僅保留90天。本報告未經本公司書面許可，不可部份複製。

This document is issued by the Company subject to its General Conditions of Service printed overleaf, available on request or accessible at www.sgs.com/terms_and_conditions.htm and, for electronic format documents, subject to Terms and Conditions for Electronic Documents at www.sgs.com/terms_e-document.htm. Attention is drawn to the limitation of liability, indemnification and jurisdiction issues defined therein. Any holder of this document is advised that information contained hereon reflects the Company's findings at the time of its intervention only and within the limits of Client's instructions, if any. The Company's sole responsibility is to its Client and this document does not exonerate parties to a transaction from exercising all their rights and obligations under the transaction documents. This document cannot be reproduced except in full, without prior written approval of the Company. Any unauthorized alteration, forgery or falsification of the content or appearance of this document is unlawful and offenders may be prosecuted to the fullest extent of the law.

Band41_20MHz_16QAM_40640_100RB#0

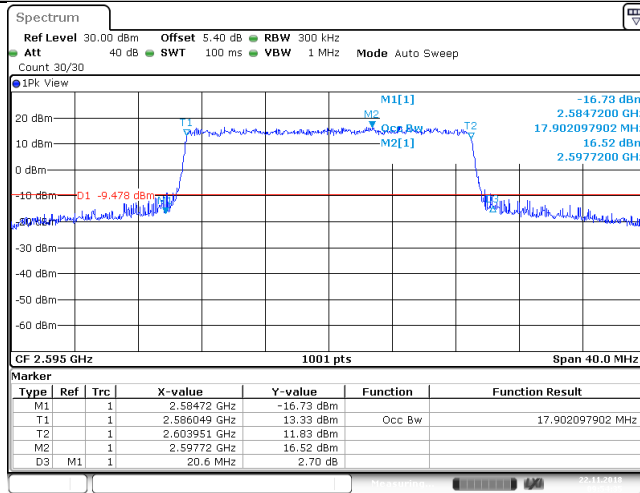

Band41_20MHz_16QAM_41140_100RB#0

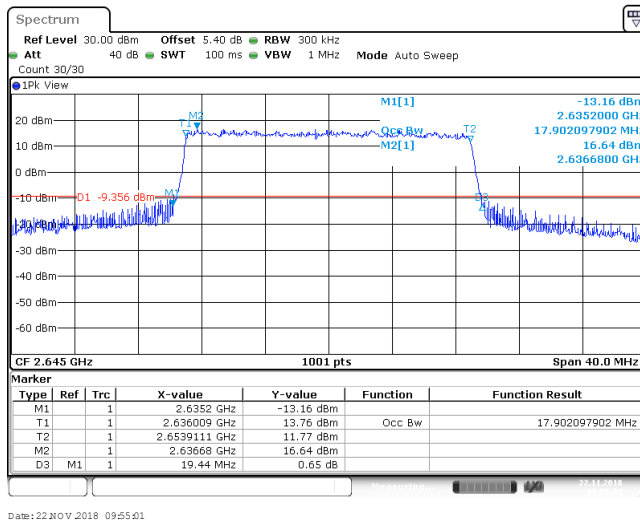

Unless otherwise stated the results shown in this test report refer only to the sample(s) tested and such sample(s) are retained for 90 days only.
 除非另有說明，此報告結果僅對測試之樣品負責，同時此樣品僅保留90天。本報告未經本公司書面許可，不可部份複製。

This document is issued by the Company subject to its General Conditions of Service printed overleaf, available on request or accessible at www.sgs.com/terms_and_conditions.htm and, for electronic format documents, subject to Terms and Conditions for Electronic Documents at www.sgs.com/terms_e-document.htm. Attention is drawn to the limitation of liability, indemnification and jurisdiction issues defined therein. Any holder of this document is advised that information contained hereon reflects the Company's findings at the time of its intervention only and within the limits of Client's instructions, if any. The Company's sole responsibility is to its Client and this document does not exonerate parties to a transaction from exercising all their rights and obligations under the transaction documents. This document cannot be reproduced except in full, without prior written approval of the Company. Any unauthorized alteration, forgery or falsification of the content or appearance of this document is unlawful and offenders may be prosecuted to the fullest extent of the law.

8. OUT OF BAND EMISSION AT ANTENNA TERMINALS

8.1. Standard Applicable

FCC §22.917(a), §24.238(a), §27.53(h), Out of band emissions. The power of any emission outside of the authorized operating frequency ranges must be attenuated below the transmitting power (P) by a factor of at least $43 + 10 \log(P)$ dB.

FCC §27.53(c)

(c) For operations in the 746–758 MHz band and the 776–788 MHz band, the power of any emission outside the licensee's frequency band(s) of operation shall be attenuated below the transmitter power (P) within the licensed band(s) of operation, measured in watts, in accordance with the following:

(2) On any frequency outside the 776–788 MHz band, the power of any emission shall be attenuated outside the band below the transmitter power (P) by at least $43 + 10 \log(P)$ dB (-13dBm)

(4) On all frequencies between 763-775 MHz and 793-805 MHz, by a factor not less than

$65 + 10 \log(P)$ dB in a 6.25 kHz band segment, for mobile and portable stations;

§27.53 (f) For operations in the 746-758 MHz, 775-788 MHz, and 805-806 MHz bands, emissions in the band 1559-1610 MHz shall be limited to -70 dBW/MHz equivalent isotropically radiated power (EIRP) for wideband signals, and -80 dBW EIRP for discrete emissions of less than 700 Hz bandwidth. For the purpose of equipment authorization, a transmitter shall be tested with an antenna that is representative of the type that will be used with the equipment in normal operation.

FCC §27.53(c) (5) & FCC §27.53(g)

Compliance with this provision is based on the use of measurement instrumentation employing a resolution bandwidth of 100 kilohertz or greater. However, in the 100 kilohertz bands immediately outside and adjacent to a licensee's frequency block, a resolution bandwidth of at least 30 kHz may be employed.

FCC §27.53(h) (3)

Compliance with this provision is based on the use of measurement instrumentation employing a resolution bandwidth of 1 megahertz or greater. However, in the 1 megahertz bands immediately outside and adjacent to the licensee's frequency block, a resolution bandwidth of at least one percent of the emission bandwidth of the fundamental emission of the transmitter may be employed. The emission bandwidth is defined as the width of the signal between two points, one below the carrier center frequency and one above the carrier center frequency, outside of which all emissions are attenuated at least 26 dB below the transmitter power.

FCC §27.53(m) (4) (6)

For mobile digital stations, the attenuation factor shall be not less than $40 + 10 \log(P)$ dB on all frequencies between the channel edge and 5 megahertz from the channel edge, $43 + 10 \log(P)$ dB on all frequencies between 5 megahertz and X megahertz from the channel edge, and $55 + 10 \log(P)$ dB on all frequencies more than X megahertz from the channel edge, where X is the greater of 6 megahertz or the actual emission bandwidth as defined in paragraph (m)(6) of this section. In addition, the attenuation factor shall not be less than $43 + 10 \log(P)$ dB on all frequencies between 2490.5 MHz and 2496 MHz and $55 + 10 \log(P)$ dB at or below 2490.5 MHz. Mobile Satellite Service licensees operating on frequencies below 2495 MHz may also submit a documented interference complaint against BRS licensees operating on channel BRS Channel 1 on the same terms and conditions as adjacent channel BRS or EBS licensees.

Measurement procedure. Compliance with these rules is based on the use of measurement instrumentation employing a resolution bandwidth of 1 megahertz or greater. However, in the 1 MHz bands immediately outside and adjacent to the frequency block a resolution bandwidth of at least one percent of the emission bandwidth of the funda-

Unless otherwise stated the results shown in this test report refer only to the sample(s) tested and such sample(s) are retained for 90 days only.
除非另有說明，此報告結果僅對測試之樣品負責，同時此樣品僅保留90天。本報告未經本公司書面許可，不可部份複製。

This document is issued by the Company subject to its General Conditions of Service printed overleaf, available on request or accessible at www.sgs.com/terms_and_conditions.htm and, for electronic format documents, subject to Terms and Conditions for Electronic Documents at www.sgs.com/terms_e-document.htm. Attention is drawn to the limitation of liability, indemnification and jurisdiction issues defined therein. Any holder of this document is advised that information contained hereon reflects the Company's findings at the time of its intervention only and within the limits of Client's instructions, if any. The Company's sole responsibility is to its Client and this document does not exonerate parties to a transaction from exercising all their rights and obligations under the transaction documents. This document cannot be reproduced except in full, without prior written approval of the Company. Any unauthorized alteration, forgery or falsification of the content or appearance of this document is unlawful and offenders may be prosecuted to the fullest extent of the law.