



FCC RADIO TEST REPORT

FCC ID : PY7-01875J
Equipment : GSM/WCDMA/LTE Phone with BT, DTS/UNII a/b/g/n/ac, GPS and NFC
Brand Name : Sony
Applicant : Sony Mobile Communications Inc.
4-12-3 Higashi-Shinagawa, Shinagawa-ku,
Tokyo, 140-0002, Japan
Manufacturer : Sony Mobile Communications Inc.
4-12-3 Higashi-Shinagawa, Shinagawa-ku,
Tokyo, 140-0002, Japan
Standard : FCC Part 15 Subpart C §15.225

The product was received on Jun. 04, 2019 and testing was started from Jul. 10, 2019 and completed on Jul. 10, 2019. We, SPORTON INTERNATIONAL INC. EMC & Wireless Communications Laboratory, would like to declare that the tested sample has been evaluated in accordance with the test procedures and has been in compliance with the applicable technical standards.

The report must not be used by the client to claim product certification, approval, or endorsement by TAF or any agency of government.

The test results in this spot check data report apply exclusively to the tested model / sample. Without written approval of SPORTON INTERNATIONAL INC. EMC & Wireless Communications Laboratory, the test report shall not be reproduced except in full.

Approved by: Jones Tsai

SPORTON INTERNATIONAL INC. EMC & Wireless Communications Laboratory
No. 52, Huaya 1st Rd., Guishan Dist., Taoyuan City, Taiwan (R.O.C.)



Table of Contents

History of this test report	3
Summary of Test Result	4
1. General Description	5
1.1 Product Feature of Equipment Under Test	5
1.2 Modification of EUT	5
1.3 Testing Location	6
1.4 Applicable Standards	6
2. Test Configuration of Equipment Under Test.....	7
2.1 Descriptions of Test Mode	7
2.2 Connection Diagram of Test System	8
2.3 EUT Operation Test Setup	8
3. Test Results	9
3.1 Field Strength of Fundamental Emissions and Mask Measurement	9
3.2 Radiated Emissions Measurement.....	11
3.3 Antenna Requirements	14
4. List of Measuring Equipment	15
5. Uncertainty of Evaluation.....	16
Appendix A. Test Results of Radiated Test Items	
A1. Test Result of Field Strength of Fundamental Emissions	
A2. Results of Radiated Emissions (9 kHz~30MHz)	
A3. Results of Radiated Emissions (30MHz~1GHz)	



History of this test report

Report No.	Version	Description	Issued Date
FR940907-03D	01	Initial issue of report	Jul. 24, 2019



Summary of Test Result

Report Clause	Ref Std. Clause	Test Items	Result (PASS/FAIL)	Remark
-	15.207	AC Power Line Conducted Emissions	Not Required	-
-	15.215(c)	20dB Spectrum Bandwidth	Not Required	-
	2.1049	99% OBW Spectrum Bandwidth	Not Required	-
-	15.225(e)	Frequency Stability	Not Required	-
3.1	15.225(a)(b)(c)	Field Strength of Fundamental Emissions	Pass	Max level 23.15 dBµV/m at 13.560 MHz
3.2	15.225(d) 15.209	Radiated Spurious Emissions	Pass	Under limit 7.59 dB at 42.610MHz
3.3	15.203	Antenna Requirements	Pass	-

Remark:

1. Not required means after assessing, test items are not necessary to carry out.
2. This is a spot check data report and data performed in appendix of this report are chosen from the worst case of the original FCC ID report. All the test cases were performed on original report which can be referred to Sporton Report Number FR940905-02D.

Declaration of Conformity:

The test results with all measurement uncertainty excluded are presented in accordance with the regulation limits or requirements declared by manufacturers.

Comments and Explanations:

The declared of product specification for EUT presented in the report are provided by the manufacturer, and the manufacturer takes all the responsibilities for the accuracy of product specification.

Reviewed by: Wii Chang

Report Producer: Yimin Ho



1. General Description

1.1 Product Feature of Equipment Under Test

GSM/WCDMA/LTE, Bluetooth, DTS/UNII a/b/g/n/ac, NFC, and GNSS.

Product Specification subjective to this standard	
Antenna Type	Loop Antenna

EUT Information List			
HW Version	SW Version	S/N	Performed Test Item
A	1.25	BH9300B1H4	Radiated Spurious Emission

Accessory List	
AC Adapter	Model Name : UCH32
	S/N: 6218W30200140
Earphone	Model Name.: MH750
	S/N : N/A
USB Cable	Model Name.: UCB24
	S/N : N/A
2 in 1 USB Audio Cable	Model Name.: EC270
	S/N : N/A

Note:

1. Above EUT list used are electrically identical per declared by manufacturer.
2. Above the accessories list are used to exercise the EUT during test, and the serial number of each type of accessories is listed in each section of this report.
3. For other wireless features of this EUT, test report will be issued separately.

1.2 Modification of EUT

No modifications are made to the EUT during all test items.



1.3 Testing Location

Test Site	SPORTON INTERNATIONAL INC. EMC & Wireless Communications Laboratory
Test Site Location	No.58, Aly. 75, Ln. 564, Wenhua 3rd, Rd., Guishan Dist., Taoyuan City, Taiwan (R.O.C.) TEL: +886-3-327-0868 FAX: +886-3-327-0855
Test Site No.	Sporton Site No. 03CH11-HY
Test Engineer	Troye Hsieh
Temperature	22~24°C
Relative Humidity	55~63%

Note: The test site complies with ANSI C63.4 2014 requirement.

FCC Designation No.: TW0007

1.4 Applicable Standards

According to the specifications of the manufacturer, the EUT must comply with the requirements of the following standards:

- ♦ FCC Part 15 Subpart C §15.225
- ♦ FCC KDB 414788 D01 Radiated Test Site v01r01
- ♦ ANSI C63.10-2013



2. Test Configuration of Equipment Under Test

2.1 Descriptions of Test Mode

Investigation has been done on all the possible configurations.

The following table is a list of the test modes shown in this test report.

Test Items	
Radiated Emissions 9kHz~30MHz	Radiated Emissions 30MHz~1GHz

The EUT pre-scanned in four NFC type, A, B, F, V. The worst type (type F) was recorded in this report. Pre-scanned tests X, Y, Z, and Accessory in three orthogonal panels to determine the final configuration (Y plane with Earphone and Adapter) from all possible combinations.

2.2 Connection Diagram of Test System

<For Radiated Emissions Measurement with NFC Card>

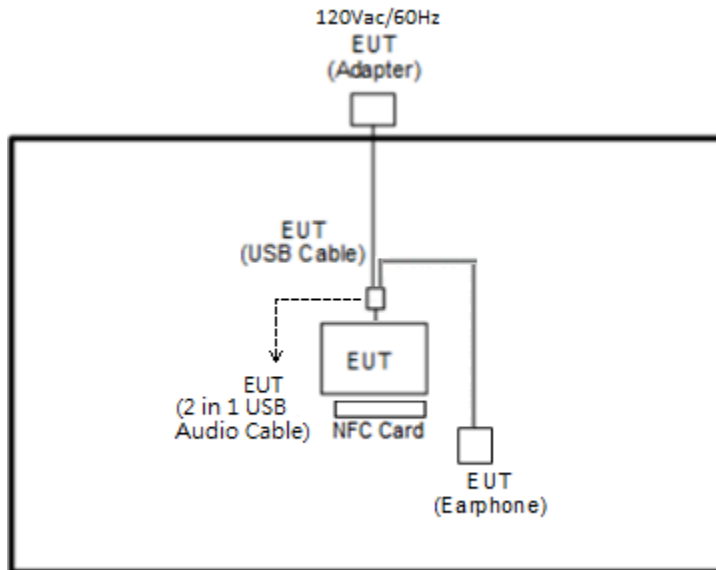

2.3 EUT Operation Test Setup

The EUT was programmed to be in continuously transmitting mode.

The ancillary equipment, NFC card, is used to make the EUT (NFC) continuously transmit at 13.56MHz and is placed around 0 cm gap to the EUT.



3. Test Results

3.1 Field Strength of Fundamental Emissions and Mask Measurement

3.1.1 Limit

Rules and specifications	FCC CFR 47 Part 15 section 15.225			
Description	Compliance with the spectrum mask is tested with RBW set to 9kHz.			
Freq. of Emission (MHz)	Field Strength (μ V/m) at 30m	Field Strength (dB μ V/m) at 30m	Field Strength (dB μ V/m) at 10m	Field Strength (dB μ V/m) at 3m
1.705~13.110	30	29.5	48.58	69.5
13.110~13.410	106	40.5	59.58	80.5
13.410~13.553	334	50.5	69.58	90.5
13.553~13.567	15848	84.0	103.08	124.0
13.567~13.710	334	50.5	69.58	90.5
13.710~14.010	106	40.5	59.58	80.5
14.010~30.000	30	29.5	48.58	69.5

3.1.2 Measuring Instruments

See list of measuring instruments of this test report.

3.1.3 Test Procedures

1. Configure the EUT according to ANSI C63.10. The EUT was placed on the top of the turntable 0.8 meter above ground. The phase center of the loop receiving antenna mounted antenna tower was placed 3 meters far away from the turntable.
 2. Power on the EUT and all the supporting units. The turntable was rotated by 360 degrees to determine the position of the highest radiation.
 3. The height of the receiving antenna was fixed at one meter above ground to find the maximum emissions field strength.
 4. For Fundamental emissions, use the receiver to measure QP reading.
 5. When the radiated emissions limits are expressed in terms of the average value of the emissions, and pulsed operation is employed, the measurement field strength shall be determined by averaging over one complete pulse train, including blanking intervals, as long as the pulse train does not exceed 0.1 seconds. As an alternative (provided the transmitter operates for longer than 0.1 seconds) or in cases where the pulse train exceeds 0.1 seconds, the measured field strength shall be determined from the average absolute voltage during a 0.1 second interval during which the field strength is at its maximum value.
 6. Compliance with the spectrum mask is tested with RBW set to 9kHz.
- Note: Emission level (dB μ V/m) = 20 log Emission level (μ V/m).

3.1.4 Test Setup

For radiated emissions below 30MHz

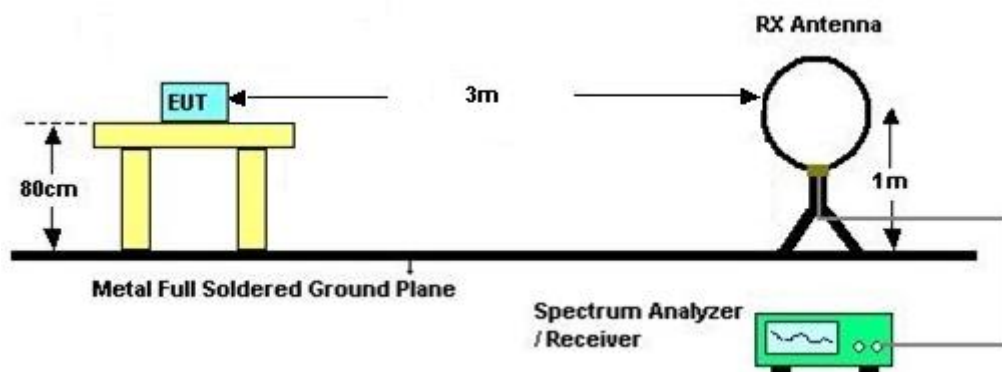

3.1.5 Test Result of Field Strength of Fundamental Emissions and Mask

Please refer to Appendix A.



3.2 Radiated Emissions Measurement

3.2.1 Limit

The field strength of any emissions which appear outside of 13.110 ~14.010MHz band shall not exceed the general radiated emissions limits.

Frequencies (MHz)	Field Strength (μV/m)	Measurement Distance (meters)
0.009~0.490	2400/F(kHz)	300
0.490~1.705	24000/F(kHz)	30
1.705~30.0	30	30
30~88	100	3
88~216	150	3
216~960	200	3
Above 960	500	3

3.2.2 Measuring Instruments

See list of measuring instruments of this test report.

3.2.3 Measuring Instrument Setting

The following table is the setting of receiver:

Receiver Parameter	Setting
Attenuation	Auto
Frequency Range: 9kHz~150kHz	RBW 200Hz for QP
Frequency Range: 150kHz~30MHz	RBW 9kHz for QP
Frequency Range: 30MHz~1000MHz	RBW 120kHz for Peak

Note: The emission limits shown in the above table are based on measurements employing a CISPR quasi-peak detector except for the frequency bands 9-90 kHz and 110-490 kHz. Radiated emission limits in these two bands are based on measurements employing an average detector.



3.2.4 Test Procedures

1. Configure the EUT according to ANSI C63.10. The EUT was placed on the top of the turntable 0.8 meter above ground. The phase center of the receiving antenna mounted on the top of a height-variable antenna tower was placed 3 meters far away from the turntable.
2. Power on the EUT and all the supporting units. The turntable was rotated by 360 degrees to determine the position of the highest radiation.
3. The height of the broadband receiving antenna was varied between one meter and four meters above ground to find the maximum emissions field strength of both horizontal and vertical polarization.
4. For each suspected emissions, the antenna tower was scan (from 1 M to 4 M) and then the turntable was rotated (from 0 degree to 360 degrees) to find the maximum reading.
5. Set the test-receiver system to Peak or CISPR quasi-peak Detect Function with specified bandwidth under Maximum Hold Mode.
6. When the radiated emissions limits are expressed in terms of the average value of the emissions, and pulsed operation is employed, the measurement field strength shall be determined by averaging over one complete pulse train, including blanking intervals, as long as the pulse train does not exceed 0.1 seconds. As an alternative (provided the transmitter operates for longer than 0.1 seconds) or in cases where the pulse train exceeds 0.1 seconds, the measured field strength shall be determined from the average absolute voltage during a 0.1 second interval during which the field strength is at its maximum value.
7. In case the emission is lower than 30MHz, loop antenna has to be used for measurement and the recorded data should be QP measured by receiver.

3.2.5 Test Setup

For radiated emissions below 30MHz

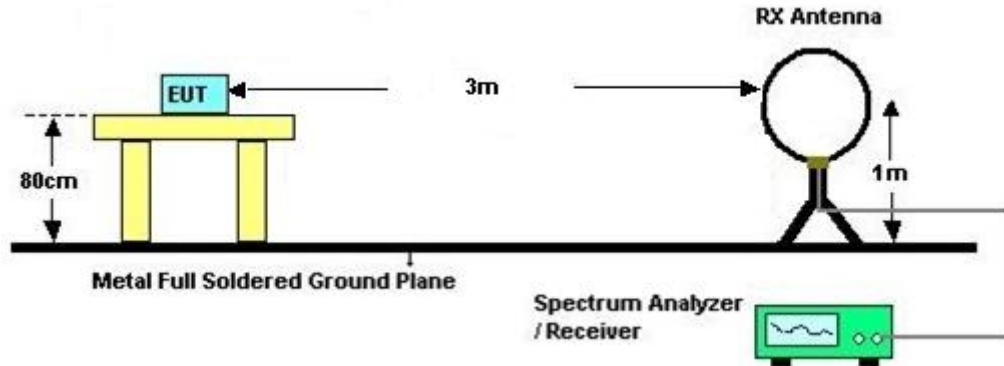

For radiated emissions above 30MHz

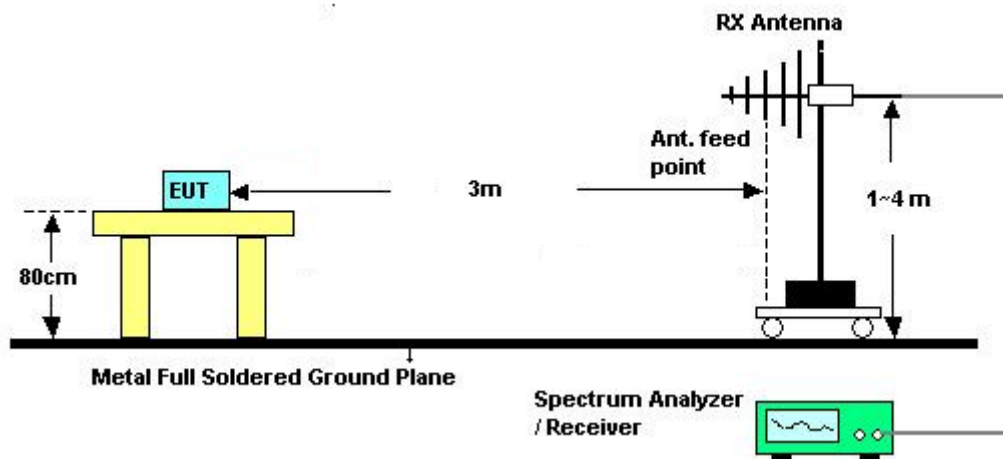

3.2.6 Test Result of Radiated Emissions Measurement

Please refer to Appendix A.

Remark:

1. There is a comparison data of both open-field test site and alternative test site - semi-Anechoic chamber according to 414788 D01 Radiated Test Site v01r01, and the result came out very similar.
2. According to C63.10 radiated Test, the EUT pre-scanned horizontal, vertical, and ground-parallel three polarization's, the worst case is horizontal & vertical polarization, test data of two mode was reported.



3.3 Antenna Requirements

3.3.1 Standard Applicable

Except for special regulations, the Low-power Radio-frequency Devices must not be equipped with any jacket for installing an antenna with extension cable. An intentional radiator shall be designed to ensure that no antenna other than that furnished by the responsible party shall be used with the device. The use of a permanently attached antenna or of an antenna that uses a unique coupling to the intentional radiator shall be considered sufficient to comply with the provisions of this Section. The manufacturer may design the unit so that the user can replace a broken antenna, but the use of a standard antenna jack or electrical connector is prohibited.

The use of a permanently attached antenna or of an antenna that uses a unique coupling to the intentional radiator shall be considered sufficient to comply with the rule.

3.3.2 Antenna Anti-Replacement Construction

An embedded-in antenna design is used.



4. List of Measuring Equipment

Instrument	Manufacturer	Model No.	Serial No.	Characteristics	Calibration Date	Test Date	Due Date	Remark
Amplifier	SONOMA	310N	187312	9kHz~1GHz	Dec. 04, 2018	Jul. 10, 2019	Dec. 03, 2019	Radiation (03CH11-HY)
Bilog Antenna	TESEQ	CBL 6111D&N-6-06	35414&AT-N0602	30MHz~1GHz	Oct. 13, 2018	Jul. 10, 2019	Oct. 12, 2019	Radiation (03CH11-HY)
Hygrometer	TECPEL	DTN-303B	TP140325	N/A	Nov. 05, 2018	Jul. 10, 2019	Nov. 04, 2019	Radiation (03CH11-HY)
Spectrum Analyzer	Keysight	N9010A	MY54200486	10Hz ~ 44GHz	Oct. 19, 2018	Jul. 10, 2019	Oct. 18, 2019	Radiation (03CH11-HY)
Controller	EMEC	EM 1000	N/A	Control Turn table & Ant Mast	N/A	Jul. 10, 2019	N/A	Radiation (03CH11-HY)
Antenna Mast	EMEC	AM-BS-4500-B	N/A	1~4m	N/A	Jul. 10, 2019	N/A	Radiation (03CH11-HY)
Turn Table	EMEC	TT 2000	N/A	0~360 Degree	N/A	Jul. 10, 2019	N/A	Radiation (03CH11-HY)
EMI Test Receiver	Keysight	N9038A(MXE)	MY53290045	N/A	Jan. 19, 2019	Jul. 10, 2019	Jan. 18, 2020	Radiation (03CH11-HY)
Filter	Wainwright	WHK20/1000C7/40SS	SN2	20M High Pass	Sep. 16, 2018	Jul. 10, 2019	Sep. 15, 2019	Radiation (03CH11-HY)
RF Cable	HUBER + SUHNER	SUCOFLEX 104	MY9837/4 PE	9kHz-30MHz	Mar. 14, 2018	Jul. 10, 2019	Mar. 12, 2020	Radiation (03CH11-HY)
RF Cable	HUBER + SUHNER	SUCOFLEX 104	MY9837/4 PE	30M-18G	Mar. 14, 2018	Jul. 10, 2019	Mar. 12, 2020	Radiation (03CH11-HY)
RF Cable	HUBER + SUHNER	SUCOFLEX 102	MY2859/2	30MHz-40GHz	Mar. 14, 2018	Jul. 10, 2019	Mar. 12, 2020	Radiation (03CH11-HY)
Loop Antenna	Rohde & Schwarz	HFH2-Z2	100488	9 kHz~30 MHz	Jan. 07, 2019	Jul. 10, 2019	Jan. 06, 2020	Radiation (03CH11-HY)
Software	Audix	E3 6.2009-8-24	RK-001042	N/A	N/A	Jul. 10, 2019	N/A	Radiation (03CH11-HY)



5. Uncertainty of Evaluation

Uncertainty of Radiated Emission Measurement (9 kHz ~ 30 MHz)

Measuring Uncertainty for a Level of Confidence of 95% ($U = 2Uc(y)$)	3.45
---	------

Uncertainty of Radiated Emission Measurement (30 MHz ~ 1000 MHz)

Measuring Uncertainty for a Level of Confidence of 95% ($U = 2Uc(y)$)	5.20
---	------



Appendix A. Test Results of Radiated Test Items

A1. Test Result of Field Strength of Fundamental Emissions

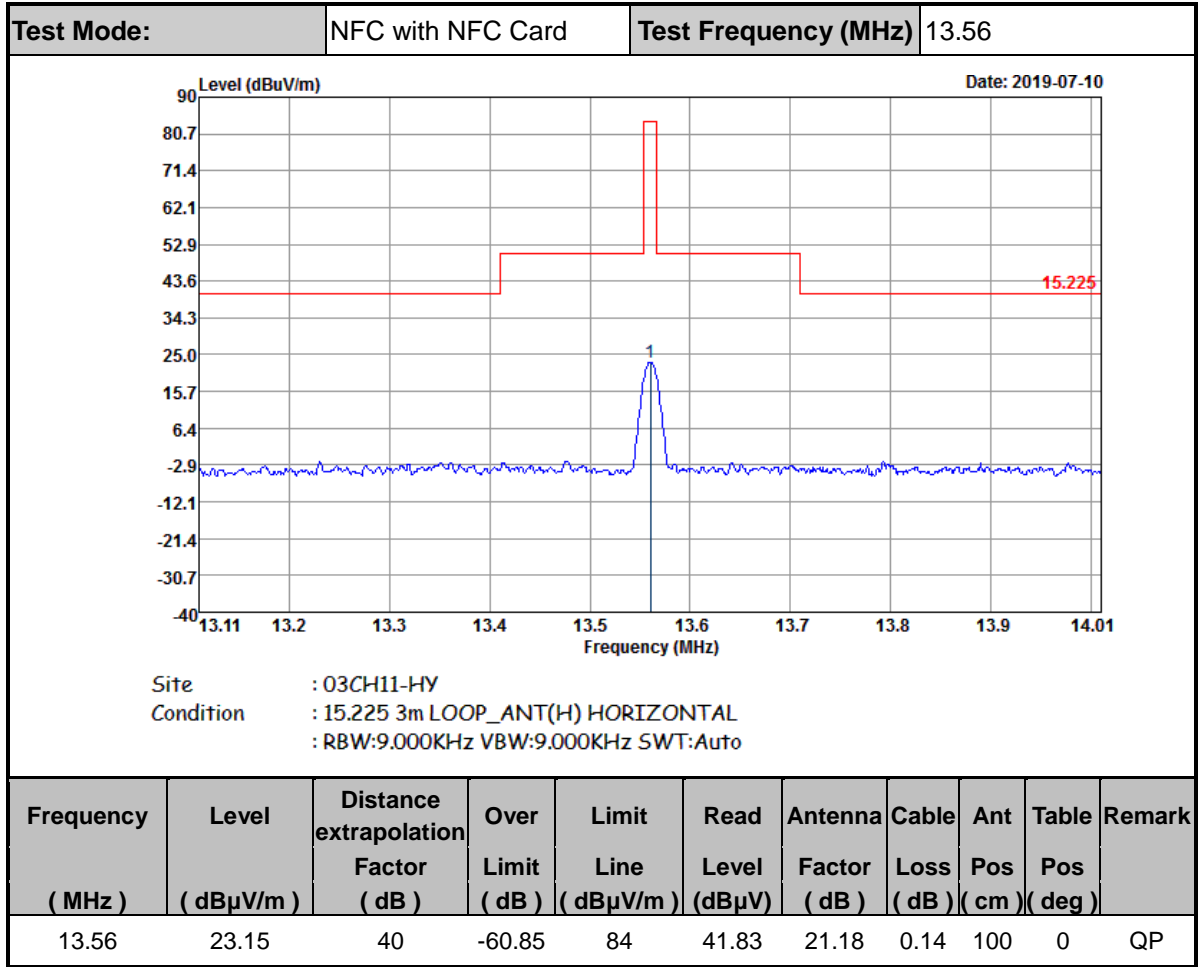

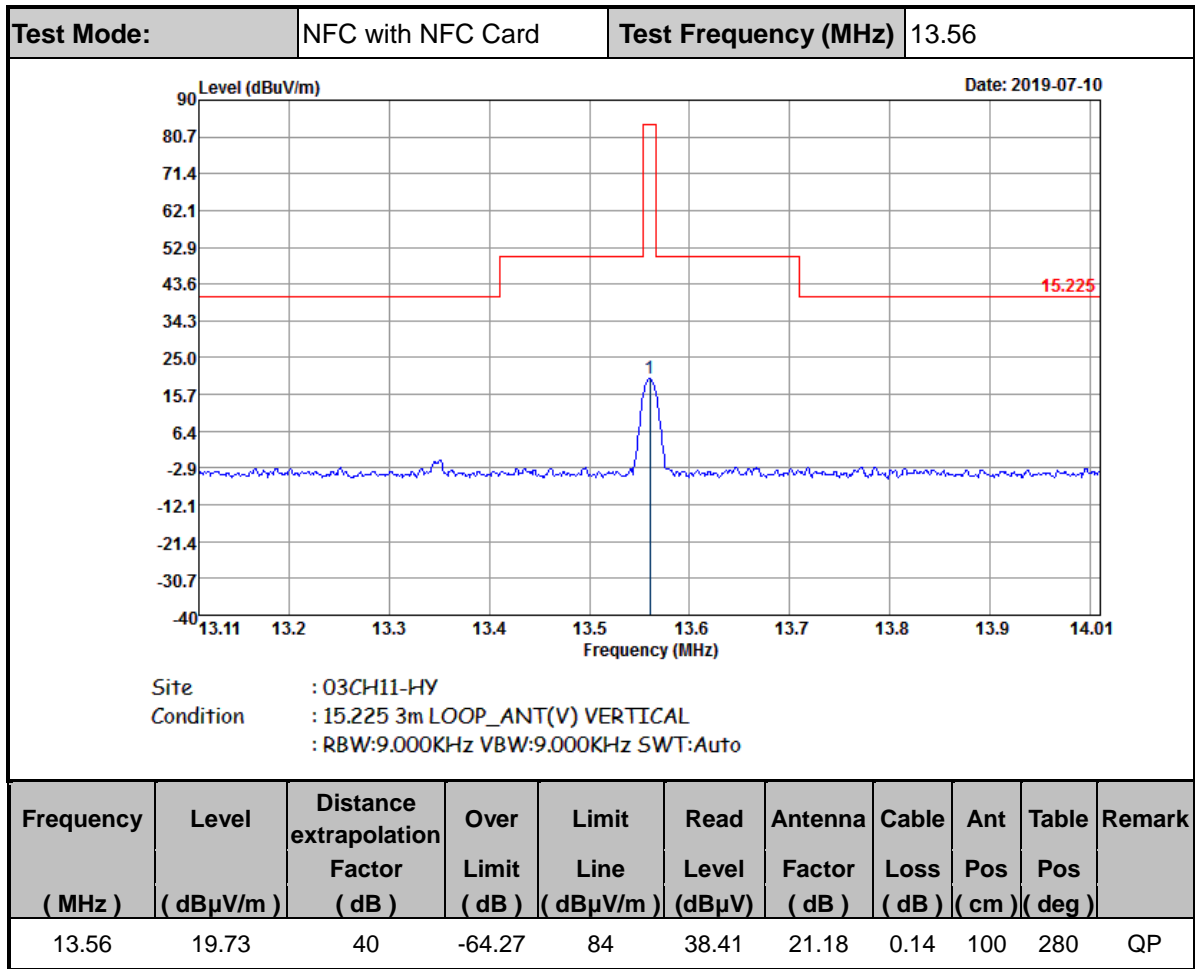

A2. Results of Radiated Spurious Emissions (9 kHz~30MHz)

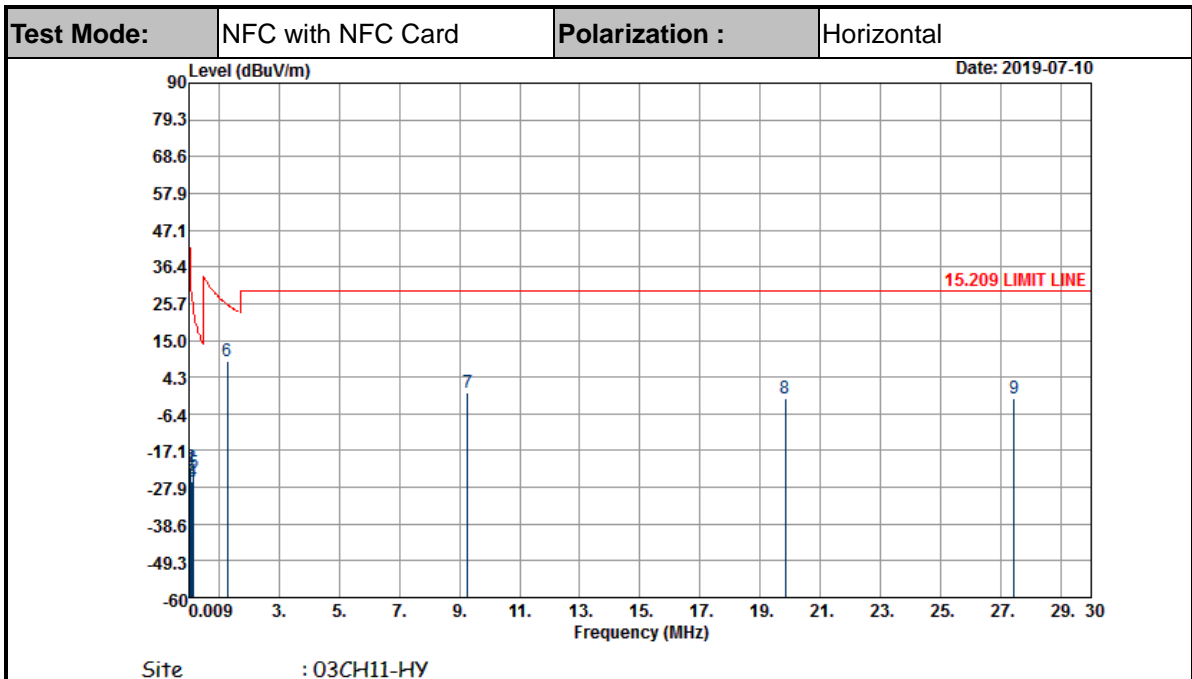

Frequency (MHz)	Level (dBμV/m)	Distance extrapolation Factor (dB)	Over Limit (dB)	Limit Line (dBμV/m)	Read Level (dBμV)	Antenna Factor (dB)	Cable Loss (dB)	Ant Pos (cm)	Table Pos (deg)	Remark
0.06246	-22.28	80	-53.97	31.69	38.46	19.25	0.01	-	-	Average
0.07812	-21.79	80	-51.54	29.75	39.01	19.19	0.01	-	-	Average
0.0938	-25.96	80	-54.12	28.16	34.91	19.12	0.01	-	-	QP
0.14068	-26.23	80	-50.87	24.64	34.7	19.06	0.01	-	-	Average
0.1551	-23.51	80	-47.3	23.79	37.44	19.04	0.01	-	-	Average
1.279	9.1	40	-16.37	25.47	29.79	19.3	0.01	100	0	QP
9.28	-0.33	40	-29.83	29.5	18.83	20.71	0.13	-	-	QP
19.825	-1.74	40	-31.24	29.5	16.4	21.69	0.17	-	-	QP
27.435	-2.03	40	-31.53	29.5	16.01	21.77	0.19	-	-	QP

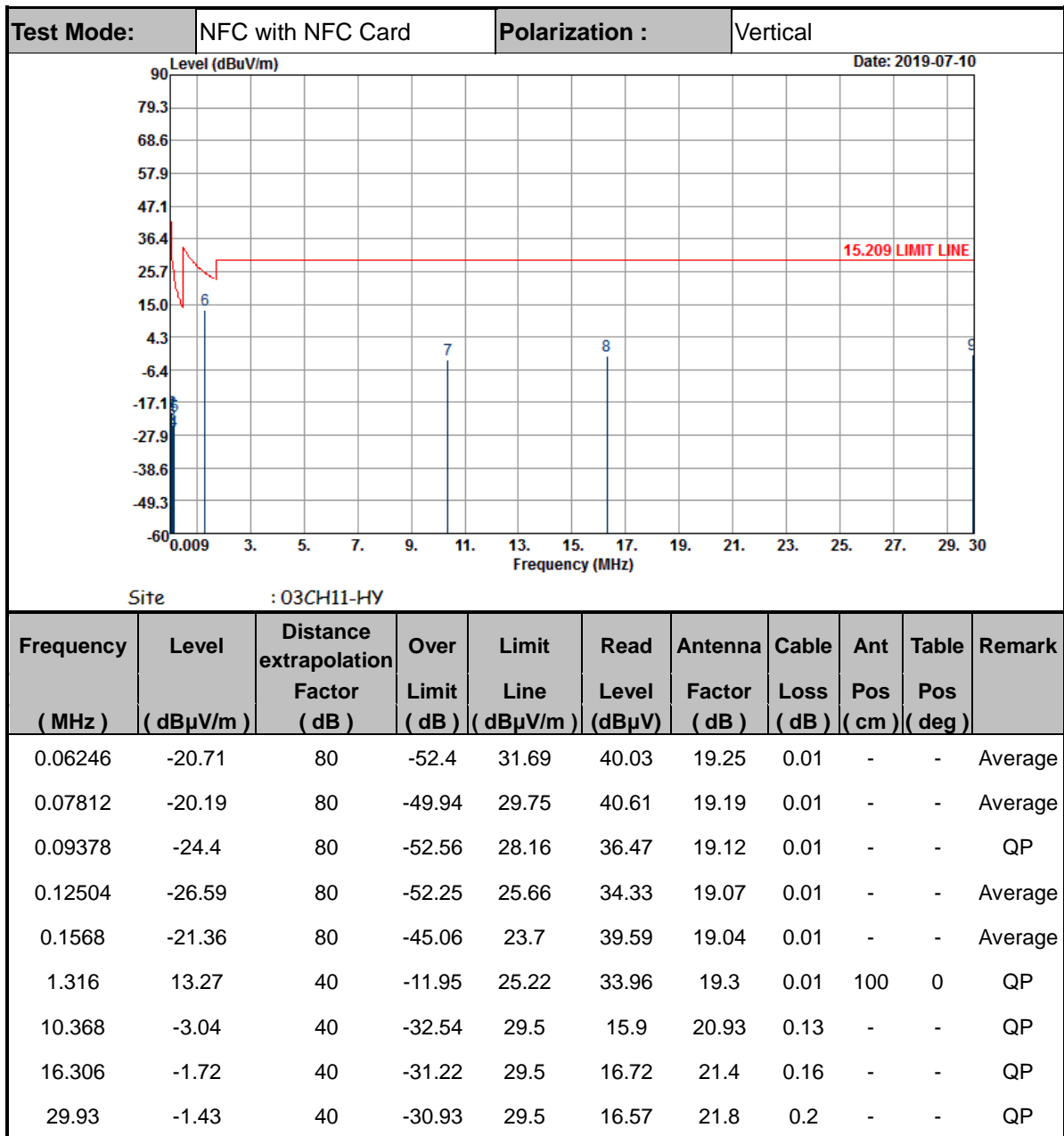

Note:

1. The amplitude of spurious emissions which are attenuated by more than 20dB below the permissible value has no need to be reported.
2. Distance extrapolation factor = 40 log (specific distance / test distance) (dB);



A3. Results of Radiated Spurious Emissions (30MHz~1GHz)

Test Mode:	NFC with NFC Card	Polarization :	Horizontal
-------------------	-------------------	-----------------------	------------

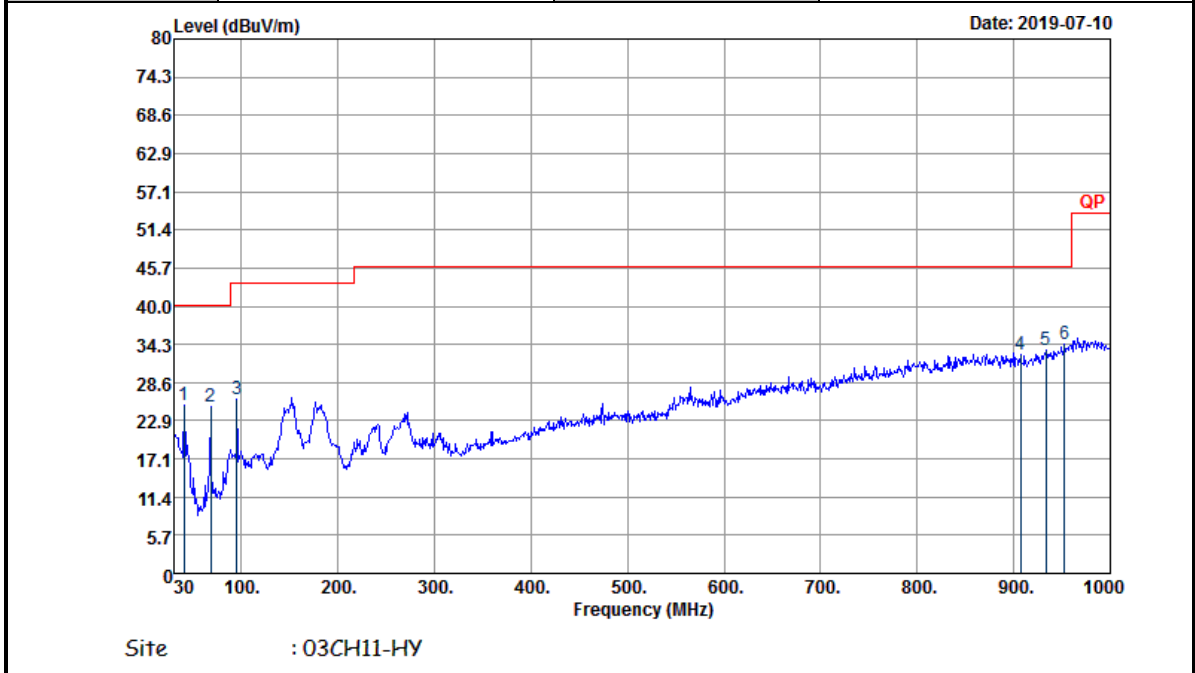

Frequency (MHz)	Level (dB μ V/m)	Over Limit (dB)	Limit Line (dB μ V/m)	Read Level (dB μ V)	Antenna Factor (dB)	Path Loss (dB)	Preamp Factor (dB)	Ant Pos (cm)	Table Pos (deg)	Remark
40.67	25.13	-14.87	40	37.86	18.7	0.94	32.37	-	-	Peak
67.83	25	-15	40	44.34	11.83	1.18	32.35	-	-	Peak
94.99	26.18	-17.32	43.5	41.94	15.13	1.44	32.33	-	-	Peak
906.88	32.7	-13.3	46	29.97	29.01	5.01	31.29	-	-	Peak
933.07	33.49	-12.51	46	29.75	29.62	5.17	31.05	-	-	Peak
952.47	34.28	-11.72	46	29.16	30.68	5.31	30.87	100	0	Peak

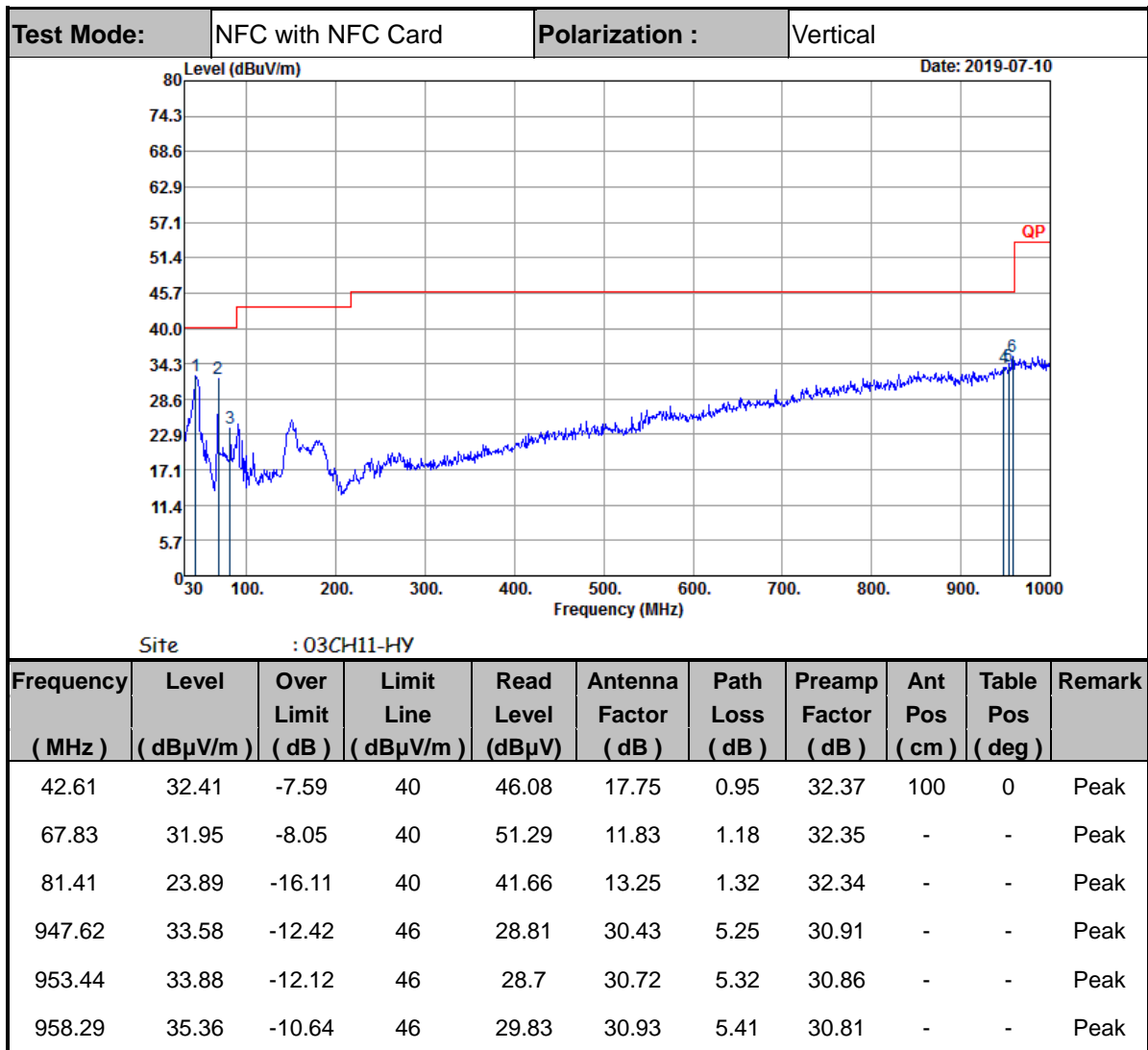

Note:

1. The amplitude of spurious emissions which are attenuated by more than 20dB below the permissible value has no need to be reported.
2. Emission level (dBμV/m) = 20 log Emission level (μV/m).
3. Corrected Reading: Antenna Factor + Cable Loss + Read Level - Preamp Factor= Level.

————THE END————