



FCC RADIO TEST REPORT

FCC ID : PY7-72473U
Equipment : GSM/WCDMA/LTE Phone with BT, DTS/UNII
a/b/g/n/ac, GPS and NFC
Brand Name : Sony
Applicant : Sony Mobile Communications Inc.
4-12-3 Higashi-Shinagawa, Shinagawa-ku,
Tokyo, 140-0002, Japan
Manufacturer : Sony Mobile Communications Inc.
4-12-3 Higashi-Shinagawa, Shinagawa-ku,
Tokyo, 140-0002, Japan
Standard : FCC Part 15 Subpart C §15.247

The product was received on Jun. 05, 2019 and testing was started from Jun. 17, 2019 and completed on Jul. 08, 2019. We, SPORTON INTERNATIONAL INC. EMC & Wireless Communications Laboratory, would like to declare that the tested sample has been evaluated in accordance with the test procedures and has been in compliance with the applicable technical standards.

The report must not be used by the client to claim product certification, approval, or endorsement by TAF or any agency of government.

The test results in this report apply exclusively to the tested model / sample. Without written approval of SPORTON INTERNATIONAL INC. EMC & Wireless Communications Laboratory, the test report shall not be reproduced except in full.

Approved by: Jones Tsai

SPORTON INTERNATIONAL INC. EMC & Wireless Communications Laboratory
No. 52, Huaya 1st Rd., Guishan Dist., Taoyuan City, Taiwan (R.O.C.)



Table of Contents

History of this test report.....	3
Summary of Test Result.....	4
1 General Description	5
1.1 Product Feature of Equipment Under Test.....	5
1.2 Modification of EUT	5
1.3 Testing Location	6
1.4 Applicable Standards.....	6
2 Test Configuration of Equipment Under Test	7
2.1 Carrier Frequency and Channel	7
2.2 Test Mode.....	7
2.3 Connection Diagram of Test System.....	8
2.4 Support Unit used in test configuration and system	9
2.5 EUT Operation Test Setup	9
2.6 Measurement Results Explanation Example.....	9
3 Test Result	10
3.1 6dB and 99% Bandwidth Measurement	10
3.2 Output Power Measurement.....	12
3.3 Power Spectral Density Measurement	13
3.4 Conducted Band Edges and Spurious Emission Measurement	16
3.5 Radiated Band Edges and Spurious Emission Measurement	47
3.6 AC Conducted Emission Measurement.....	51
3.7 Antenna Requirements.....	53
4 List of Measuring Equipment.....	54
5 Uncertainty of Evaluation.....	56
Appendix A. Conducted Test Results	
Appendix B. AC Conducted Emission Test Result	
Appendix C. Radiated Spurious Emission	
Appendix D. Radiated Spurious Emission Plots	
Appendix E. Duty Cycle Plots	



Summary of Test Result

Report Clause	Ref Std. Clause	Test Items	Result (PASS/FAIL)	Remark
3.1	15.247(a)(2)	6dB Bandwidth	Pass	-
3.1	2.1049	99% Occupied Bandwidth	Reporting only	-
3.2	15.247(b)	Power Output Measurement	Pass	-
3.3	15.247(e)	Power Spectral Density	Pass	-
3.4	15.247(d)	Conducted Band Edges	Pass	-
		Conducted Spurious Emission	Pass	-
3.5	15.247(d)	Radiated Band Edges and Radiated Spurious Emission	Pass	Under limit 3.21 dB at 2483.520 MHz
3.6	15.207	AC Conducted Emission	Pass	Under limit 18.05 dB at 0.596 MHz
3.7	15.203 & 15.247(b)	Antenna Requirement	Pass	-

Declaration of Conformity:

The test results with all measurement uncertainty excluded are presented in accordance with the regulation limits or requirements declared by manufacturers.

Comments and Explanations:

The declared of product specification for EUT presented in the report are provided by the manufacturer, and the manufacturer takes all the responsibilities for the accuracy of product specification.

Reviewed by: Wii Chang**Report Producer: Yimin Ho**



1 General Description

1.1 Product Feature of Equipment Under Test

GSM/WCDMA/LTE, Bluetooth, DTS/UNII a/b/g/n/ac, NFC, and GNSS.

Standards-related Product Specification	
Antenna Type / Gain	<Ant. 1>: Loop Antenna with gain -2.1 dBi <Ant. 2>: Monopole Antenna with gain -6.8 dBi

EUT Information List			
HW Version	SW Version	S/N	Performed Test Item
A	0_77003_A_28_2	BH930027H2	RF conducted measurement
	7.19	BH930081H1 BH93008ZH1	Radiated Spurious Emission
		BH93008LH1	AC Conducted Emission

Accessory List	
AC Adapter	Model Name : UCH32
	S/N: 6218W30200106 (for radiated emission) 6218W30200197 (for conducted emission)
Earphone	Model Name.: MH750
	S/N : N/A
USB Cable	Model Name.: UCB24
	S/N : N/A
2 in 1 USB Audio Cable	Model Name.: EC270
	S/N : N/A

Note:

- Above EUT list used are electrically identical per declared by manufacturer.
- Above the accessories list are used to exercise the EUT during test, and the serial number of each type of accessories is listed in each section of this report. .
- For other wireless features of this EUT, test report will be issued separately.
- The antenna 1 and antenna 2 in this test report are equivalent to WLAN chain 0 and chain 1 in Antenna Specification by manufacturer.
- The firmware installed in the EUT during testing was 0_77003_A_28_2.

1.2 Modification of EUT

No modifications are made to the EUT during all test items.



1.3 Testing Location

Test Site	SPORTON INTERNATIONAL INC. EMC & Wireless Communications Laboratory	
Test Site Location	No.52, Huaya 1st Rd., Guishan Dist., Taoyuan City, Taiwan (R.O.C.) TEL: +886-3-327-3456 FAX: +886-3-328-4978	
Test Site No.	Sporton Site No.	
	TH05-HY	CO05-HY

Note: The test site complies with ANSI C63.4 2014 requirement.

Test Site	SPORTON INTERNATIONAL INC. EMC & Wireless Communications Laboratory	
Test Site Location	No.58, Aly. 75, Ln. 564, Wenhua 3rd, Rd., Guishan Dist., Taoyuan City, Taiwan (R.O.C.) TEL: +886-3-327-0868 FAX: +886-3-327-0855	
Test Site No.	Sporton Site No.	
	03CH16-HY	

Note: The test site complies with ANSI C63.4 2014 requirement.

FCC Designation No.: TW1190 and TW0007

1.4 Applicable Standards

According to the specifications of the manufacturer, the EUT must comply with the requirements of the following standards:

- ♦ FCC Part 15 Subpart C §15.247
- ♦ FCC KDB Publication No. 558074 D01 DTS Meas. Guidance v05r02
- ♦ FCC KDB 414788 D01 Radiated Test Site v01r01.
- ♦ FCC KDB 662911 D01 Multiple Transmitter Output v02r01.
- ♦ ANSI C63.10-2013

Remark:

1. All test items were verified and recorded according to the standards and without any deviation during the test.
2. This EUT has also been tested and complied with the requirements of FCC Part 15, Subpart B, recorded in a separate test report.

2 Test Configuration of Equipment Under Test

- a. The EUT has been associated with peripherals and configuration operated in a manner tended to maximize its emission characteristics in a typical application. Frequency range investigated: conduction emission (150 kHz to 30 MHz), radiation emission (9 kHz to the 10th harmonic of the highest fundamental frequency or to 40 GHz, whichever is lower). For radiated measurement, pre-scanned in three orthogonal panels, X, Y, Z and Accessory. The worst cases (X plane with Adapter) were recorded in this report.

- b. AC power line Conducted Emission was tested under maximum output power.

2.1 Carrier Frequency and Channel

Frequency Band	Channel	Freq. (MHz)	Channel	Freq. (MHz)
2400-2483.5 MHz	1	2412	8	2447
	2	2417	9	2452
	3	2422	10	2457
	4	2427	11	2462
	5	2432	12	2467
	6	2437	13	2472
	7	2442		

2.2 Test Mode

Final test modes are considering the modulation and worse data rates as below table.

Modulation	Data Rate
802.11b	1 Mbps
802.11g	6 Mbps
802.11n HT20	MCS0

Test Cases	
AC Conducted Emission	Mode 1 :GSM850 Idle + Bluetooth Link + WLAN (2.4GHz) Link + MPEG4 + USB Audio Cable + USB Cable (Charging from Adapter) + Battery + Earphone
Remark: The single mode covered by MIMO mode base on the MIMO mode power higher than the single mode.	

2.3 Connection Diagram of Test System

<WLAN Tx Mode>

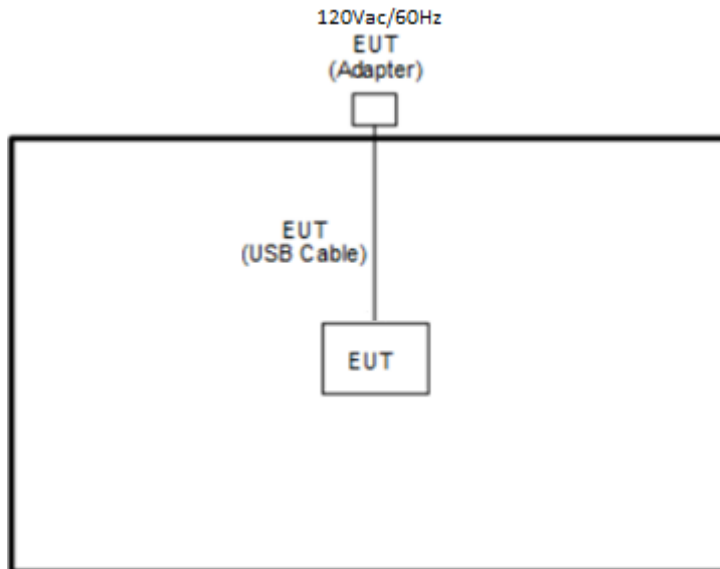

<AC Conducted Emission Mode>

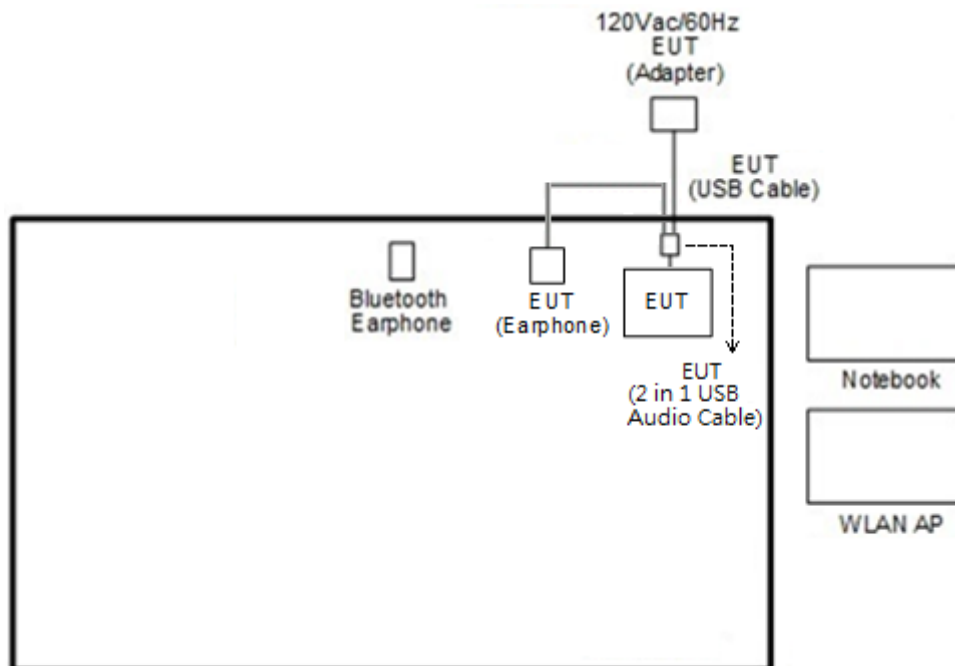



2.4 Support Unit used in test configuration and system

Item	Equipment	Trade Name	Model Name	FCC ID	Data Cable	Power Cord
1.	System Simulator	Anritsu	MT8820C	N/A	N/A	Unshielded, 1.8 m
2.	Bluetooth Earphone	Sony	SBH82D	PY7-RD0010	N/A	N/A
3.	WLAN AP	ASUS	RT-AC1750	MSQ-RTAC66U	N/A	Unshielded, 1.8 m
4.	Notebook	DELL	Latitude E3340	FCC DoC	N/A	AC I/P: Unshielded, 1.2 m DC O/P: Shielded, 1.8 m
5.	SD Card	SanDisk	MicroSD HC	FCC DoC	N/A	N/A

2.5 EUT Operation Test Setup

The RF test items, utility “Tera Term” was installed in Notebook which was programmed in order to make the EUT get into the engineering modes to provide channel selection, power level, data rate and the application type and for continuous transmitting signals.

2.6 Measurement Results Explanation Example

For all conducted test items:

The offset level is set in the spectrum analyzer to compensate the RF cable loss and attenuator factor between EUT conducted output port and spectrum analyzer. With the offset compensation, the spectrum analyzer reading level is exactly the EUT RF output level.

Example:

The spectrum analyzer offset is derived from RF cable loss and attenuator factor.

Offset = RF cable loss + attenuator factor.

Following shows an offset computation example with cable loss 4.2 dB and 10dB attenuator.

$$\begin{aligned} \text{Offset(dB)} &= \text{RF cable loss(dB)} + \text{attenuator factor(dB)}. \\ &= 4.2 + 10 = 14.2 \text{ (dB)} \end{aligned}$$

3 Test Result

3.1 6dB and 99% Bandwidth Measurement

3.1.1 Limit of 6dB and 99% Bandwidth

The minimum 6 dB bandwidth shall be at least 500 kHz.

3.1.2 Measuring Instruments

See list of measuring equipment of this test report.

3.1.3 Test Procedures

1. The testing follows the ANSI C63.10 Section 6.9.3 (OBW) and 11.8.1 (6dB BW).
2. The RF output of EUT was connected to the spectrum analyzer by RF cable and attenuator. The path loss was compensated to the results for each measurement.
3. Set to the maximum power setting and enable the EUT transmit continuously.
4. Make the measurement with the spectrum analyzer's resolution bandwidth (RBW) = 100 kHz. Set the Video bandwidth (VBW) = 300 kHz. In order to make an accurate measurement. The 6 dB bandwidth must be greater than 500 kHz.
5. For 99% Bandwidth Measurement, the spectrum analyzer's resolution bandwidth (RBW) is set 1-5% of the emission bandwidth and set the Video bandwidth (VBW) $\geq 3 * RBW$.
6. Measure and record the results in the test report.

3.1.4 Test Setup

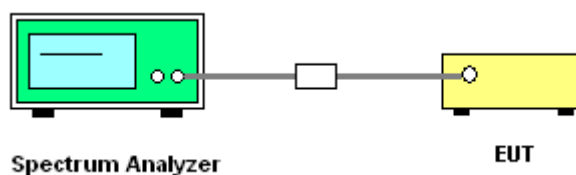



3.1.5 Test Result of 6dB and 99% Occupied Bandwidth

Please refer to Appendix A.

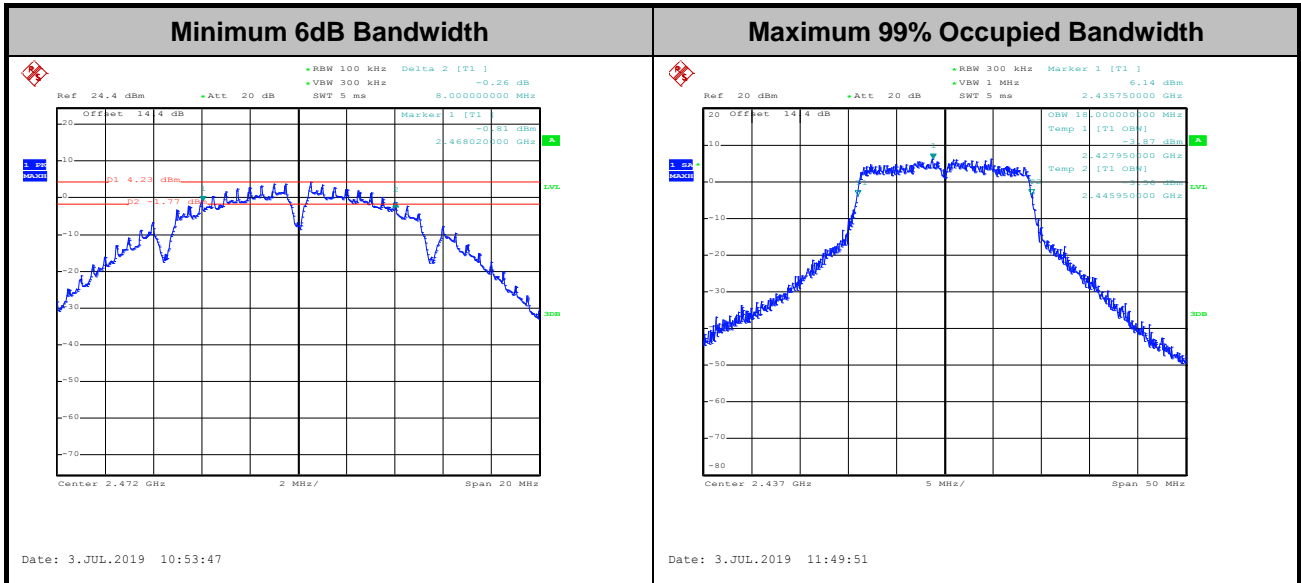

Note: The occupied channel bandwidth is maintained within the band of operation for all of the modulations.

3.2 Output Power Measurement

3.2.1 Limit of Output Power

For systems using digital modulation in the 2400-2483.5MHz, the limit for peak output power is 30dBm. If transmitting antenna with directional gain greater than 6dBi is used, the peak output power from the intentional radiator shall be reduced below the above stated value by the amount in dB that the directional gain of the antenna exceeds 6 dBi. In case of point-to-point operation, the limit has to be reduced by 1dB for every 3dB that the directional gain of the antenna exceeds 6dBi.

3.2.2 Measuring Instruments

See list of measuring equipment of this test report.

3.2.3 Test Procedures

1. For Average Power, the testing follows ANSI C63.10 Section 11.9.2.3.2 Method AVGPM-G.
2. The RF output of EUT was connected to the power meter by RF cable and attenuator. The path loss was compensated to the results for each measurement.
3. Set to the maximum power setting and enable the EUT transmit continuously.
4. Measure the conducted output power and record the results in the test report.
5. For MIMO mode, calculation method follows FCC KDB 662911 D01 Multiple Transmitter Output v02r01.

3.2.4 Test Setup

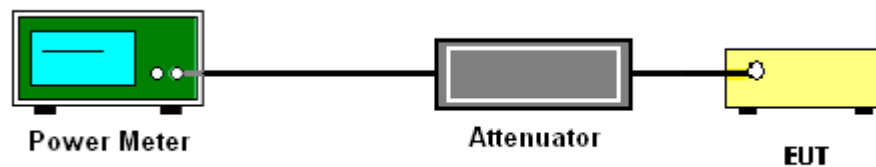

3.2.5 Test Result of Average output Power

Please refer to Appendix A.



3.3 Power Spectral Density Measurement

3.3.1 Limit of Power Spectral Density

The peak power spectral density shall not be greater than 8dBm in any 3kHz band at any time interval of continuous transmission.

3.3.2 Measuring Instruments

See list of measuring equipment of this test report.

3.3.3 Test Procedures

1. The testing follows the ANSI C63.10 Section 11.10.2 Method PKPSD.
2. The RF output of EUT was connected to the spectrum analyzer by RF cable and attenuator. The path loss was compensated to the results for each measurement.
3. Set to the maximum power setting and enable the EUT transmit continuously.
4. Make the measurement with the spectrum analyzer's resolution bandwidth (RBW) = 3 kHz. Video bandwidth VBW = 10 kHz In order to make an accurate measurement, set the span to 1.5 times DTS Channel Bandwidth. (6dB BW)
5. Detector = peak, Sweep time = auto couple, Trace mode = max hold, Allow trace to fully stabilize. Use the peak marker function to determine the maximum power level.
6. Measure and record the results in the test report.
7. For MIMO mode, calculation method follows FCC KDB 662911 D01 Multiple Transmitter Output v02r01.

If measurements performed using method (2) plus $10 \log(N)$ exceeds the emission limit, the test should choose method (1) before declaring that the device fails the emission limit.

Method (1): Measure and sum the spectra across the outputs.

The total final Power Spectral Density is from a device with 2 transmitter outputs. The spectrum measurements of the individual outputs are all performed with the same span and number of points, the spectrum value in the first spectral bin of output 1 is summed with that in the first spectral bin of output 2 to obtain the value for the first frequency bin of the summed spectrum.

Method (2): Measure and add $10 \log(N)$ dB, where N is the number of outputs. (N=2)

3.3.4 Test Setup

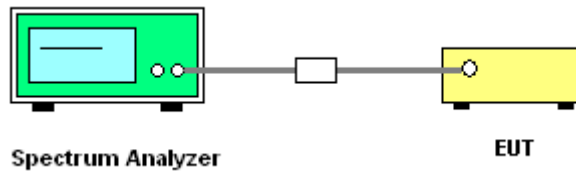

3.3.5 Test Result of Power Spectral Density

Please refer to Appendix A.

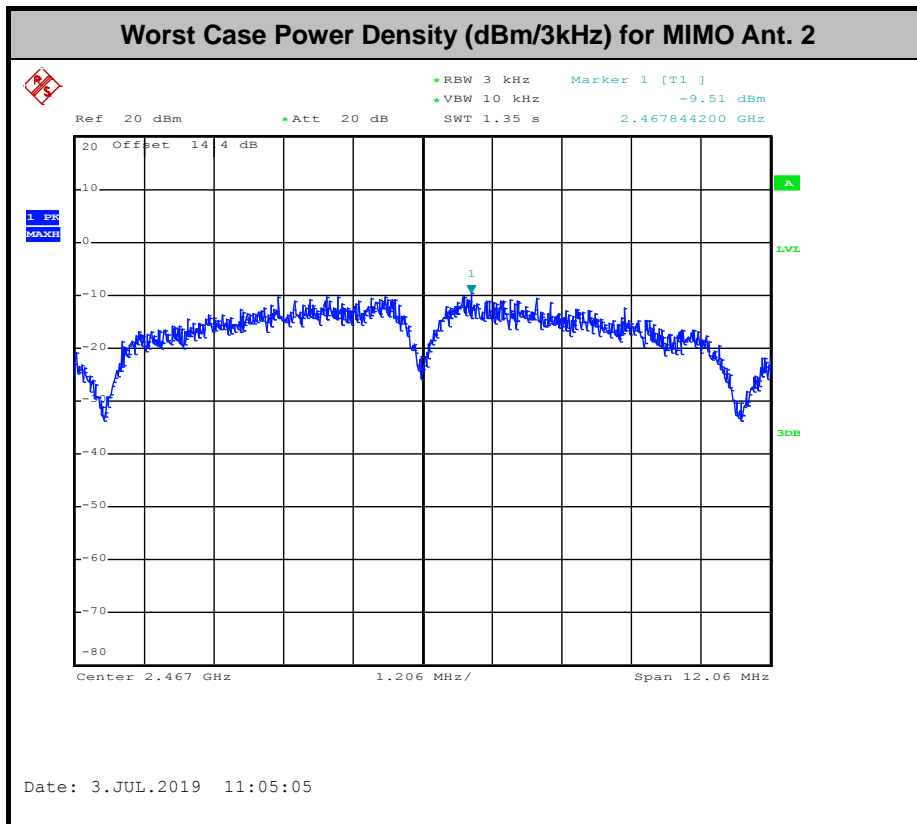
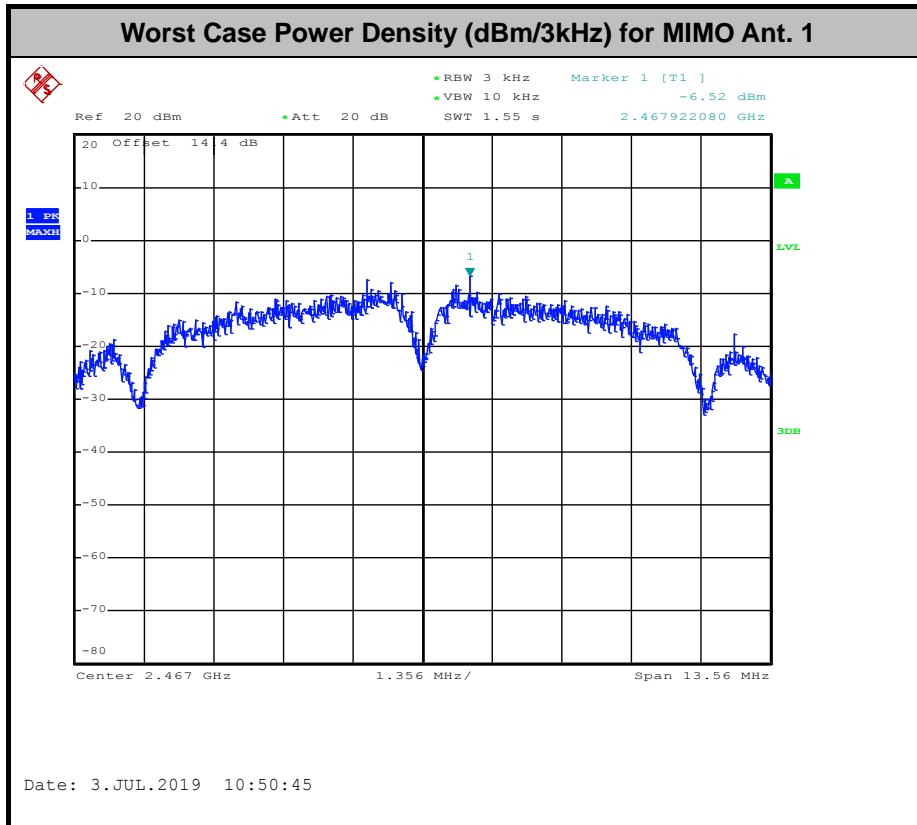

3.4 Conducted Band Edges and Spurious Emission Measurement

3.4.1 Limit of Conducted Band Edges and Spurious Emission Measurement

In any 100 kHz bandwidth outside of the authorized frequency band, the emissions which fall in the non-restricted bands shall be attenuated at least 20 dB / 30dB relative to the maximum PSD level in 100 kHz by RF conducted measurement.

3.4.2 Measuring Instruments

See list of measuring equipment of this test report.

3.4.3 Test Procedures

1. The testing follows the ANSI C63.10 Section 11.11.3 Emission level measurement.
2. The RF output of EUT was connected to the spectrum analyzer by RF cable and attenuator. The path loss was compensated to the results for each measurement.
3. Set to the maximum power setting and enable the EUT transmit continuously.
4. Set RBW = 100 kHz, VBW=300 kHz, Peak Detector. Unwanted Emissions measured in any 100 kHz bandwidth outside of the authorized frequency band shall be attenuated by at least 20 dB relative to the maximum in-band peak PSD level in 100 kHz when maximum peak conducted output power procedure is used. If the transmitter complies with the conducted power limits based on the use of RMS averaging over a time interval, the attenuation required under this paragraph shall be 30 dB instead of 20 dB per 15.247(d).
5. Measure and record the results in the test report.
6. The RF fundamental frequency should be excluded against the limit line in the operating frequency band.

3.4.4 Test Setup

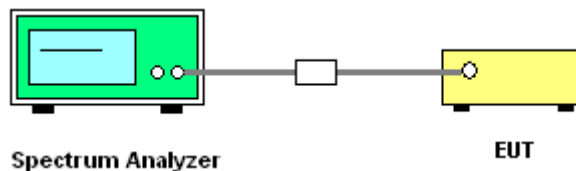



3.4.5 Test Result of Conducted Band Edges and Spurious Emission

Test Engineer : Howard Lin	Temperature :	21~25°C
	Relative Humidity :	51~54%

Number of TX = 2, Ant. 1 (Measured)

Test Mode :	802.11b	Test Channel :	01
-------------	---------	----------------	----

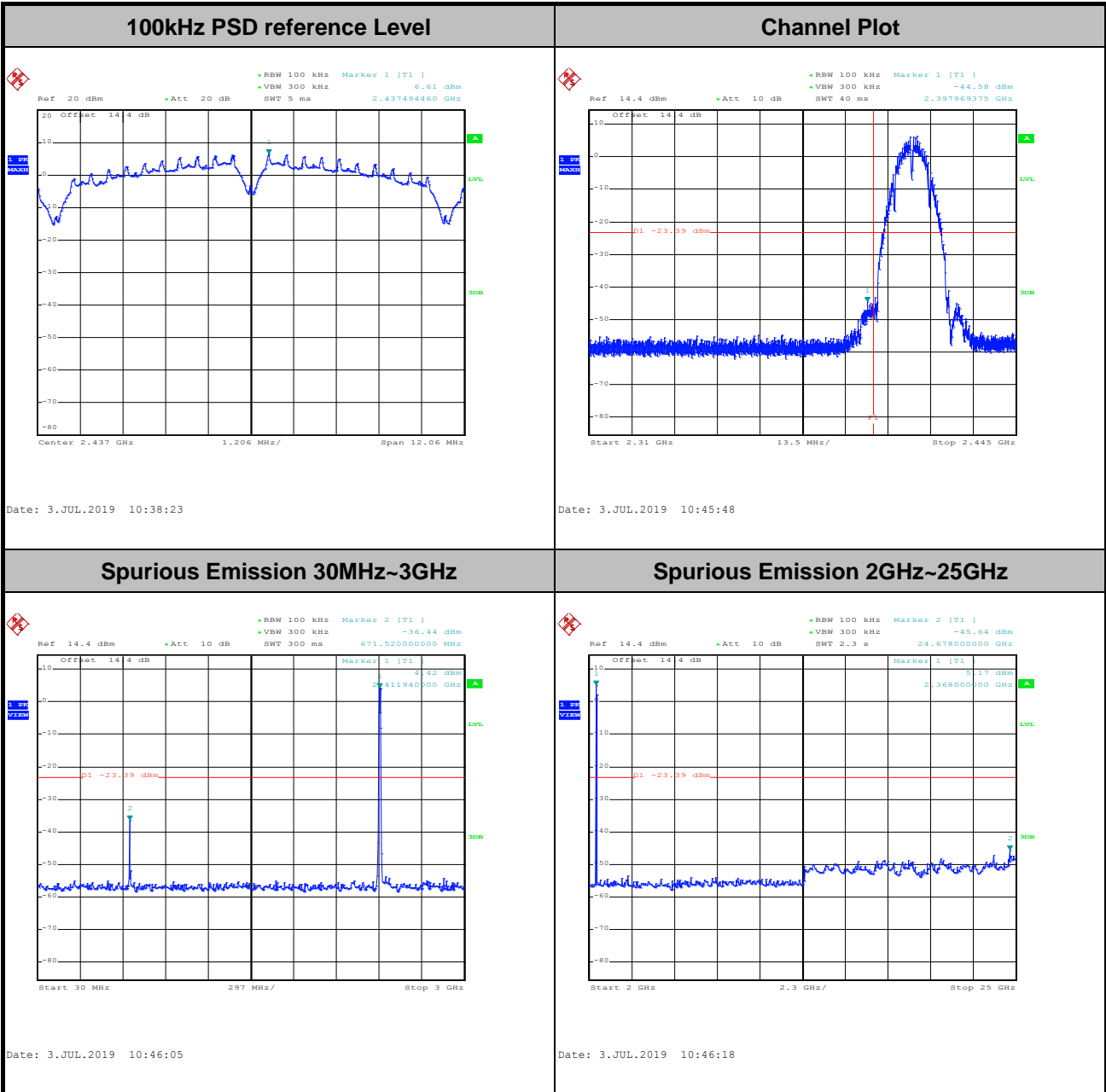



Test Mode :	802.11b	Test Channel :	06
-------------	---------	----------------	----

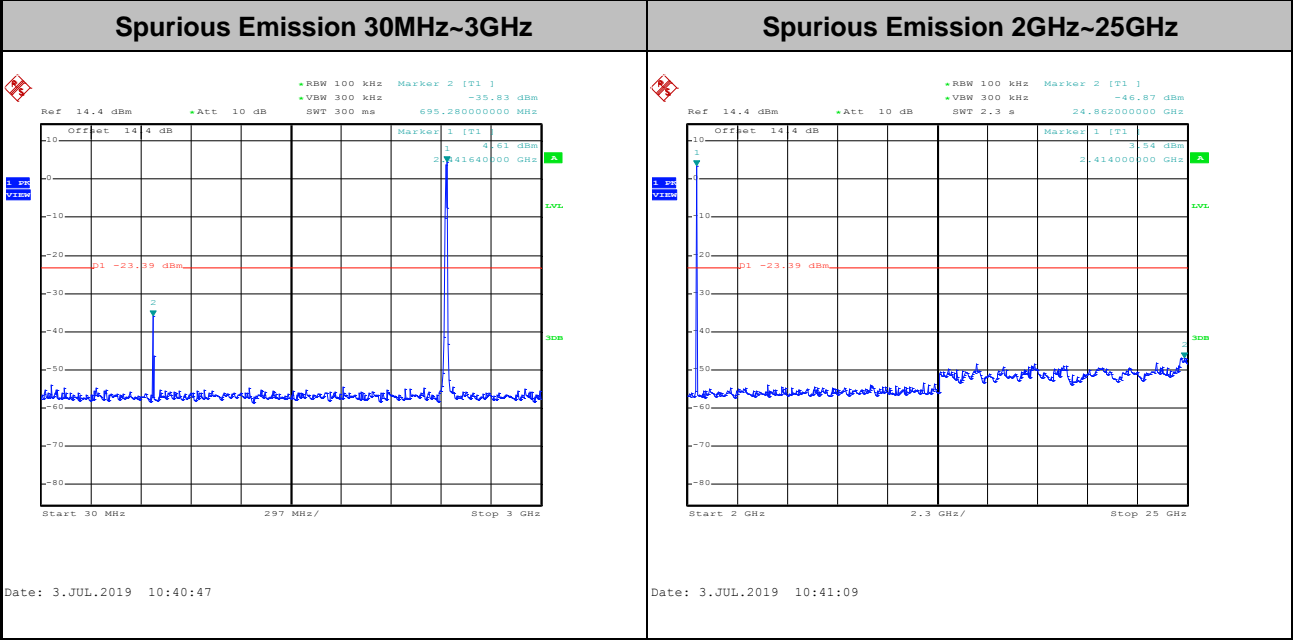
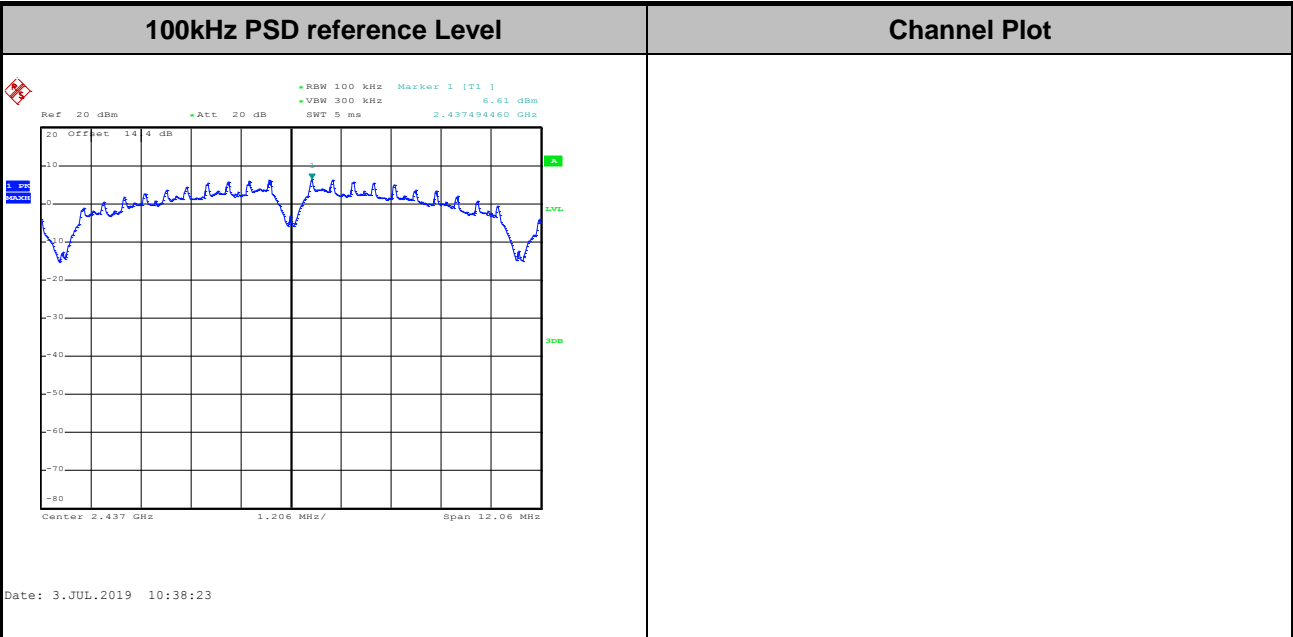



Test Mode :	802.11b	Test Channel :	11
-------------	---------	----------------	----

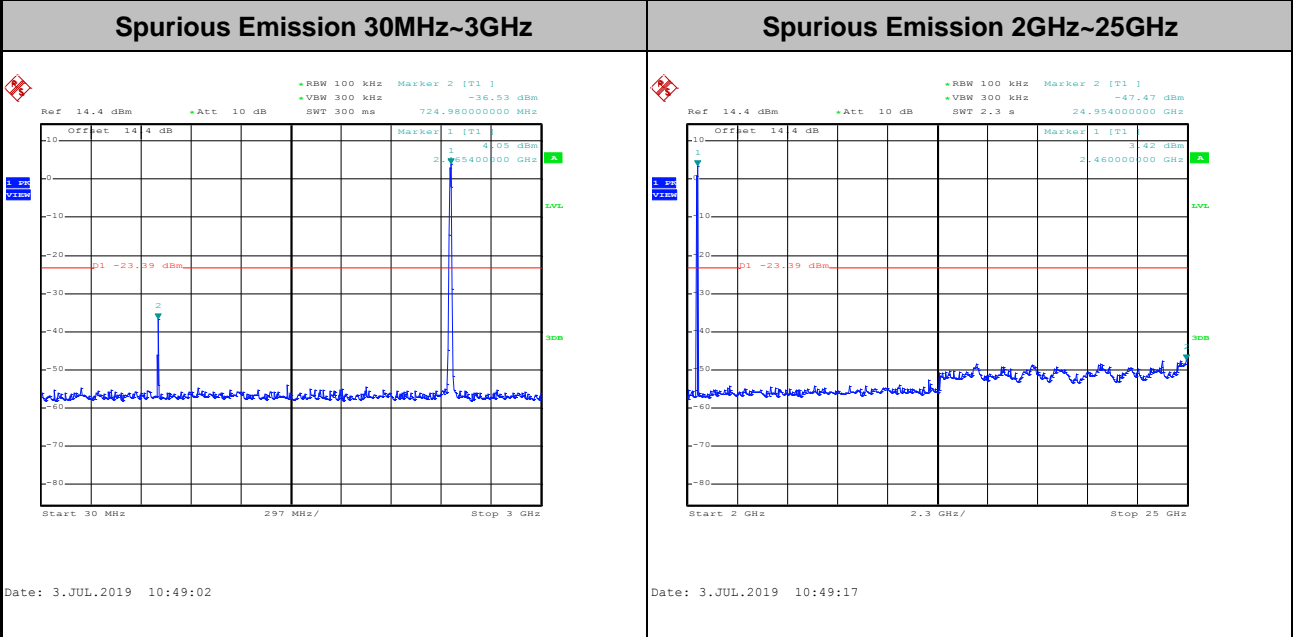
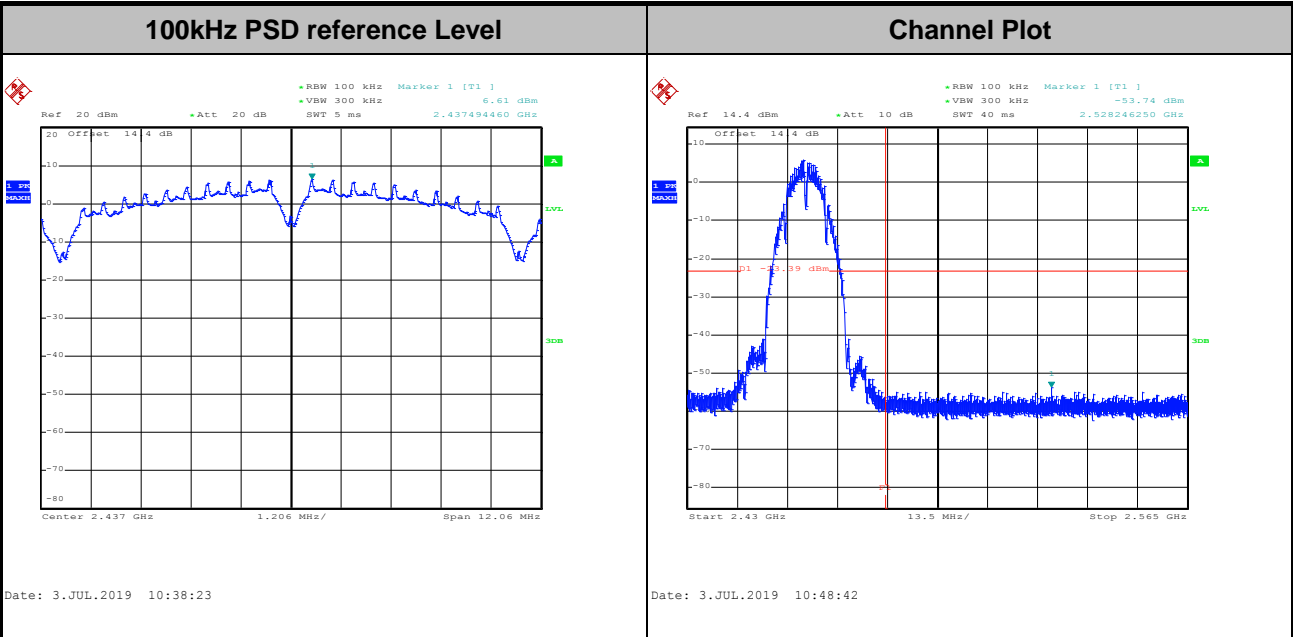



Test Mode :	802.11b	Test Channel :	12
-------------	---------	----------------	----

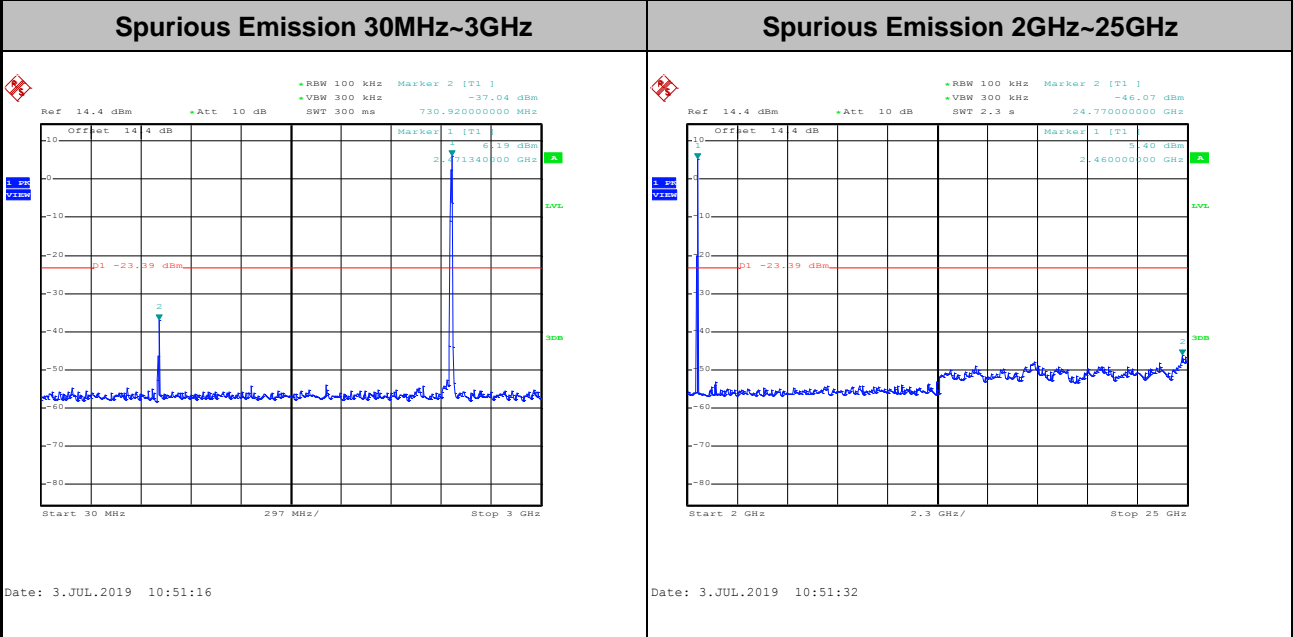
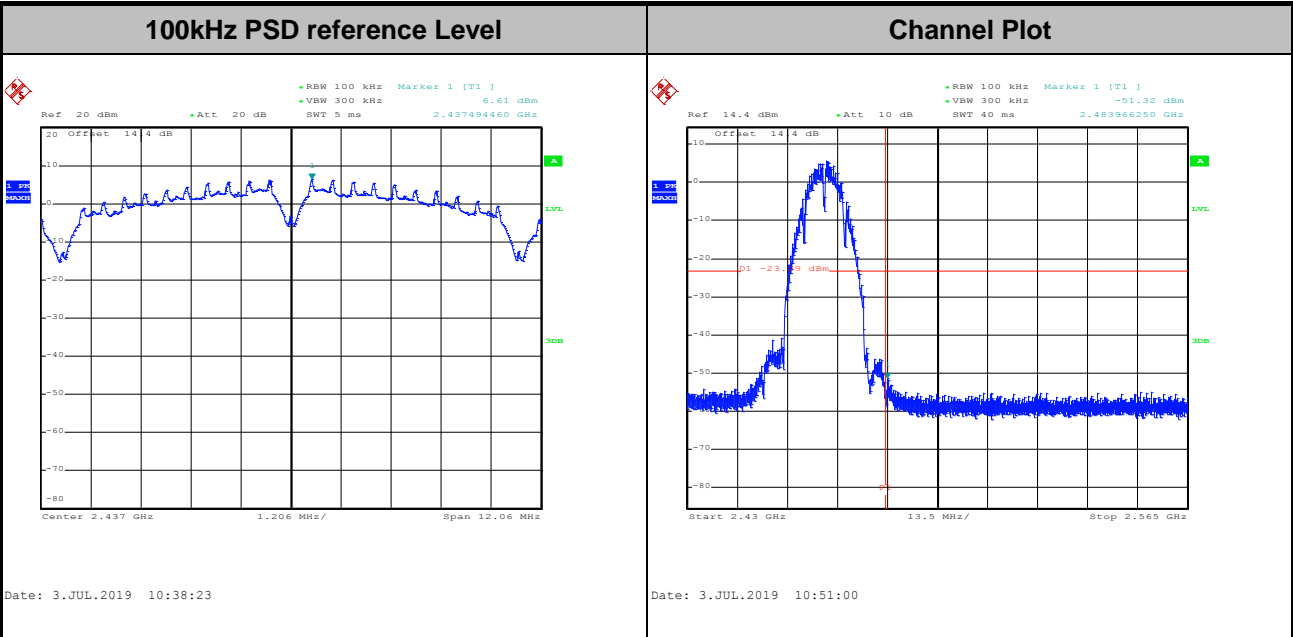



Test Mode :	802.11b	Test Channel :	13
-------------	---------	----------------	----

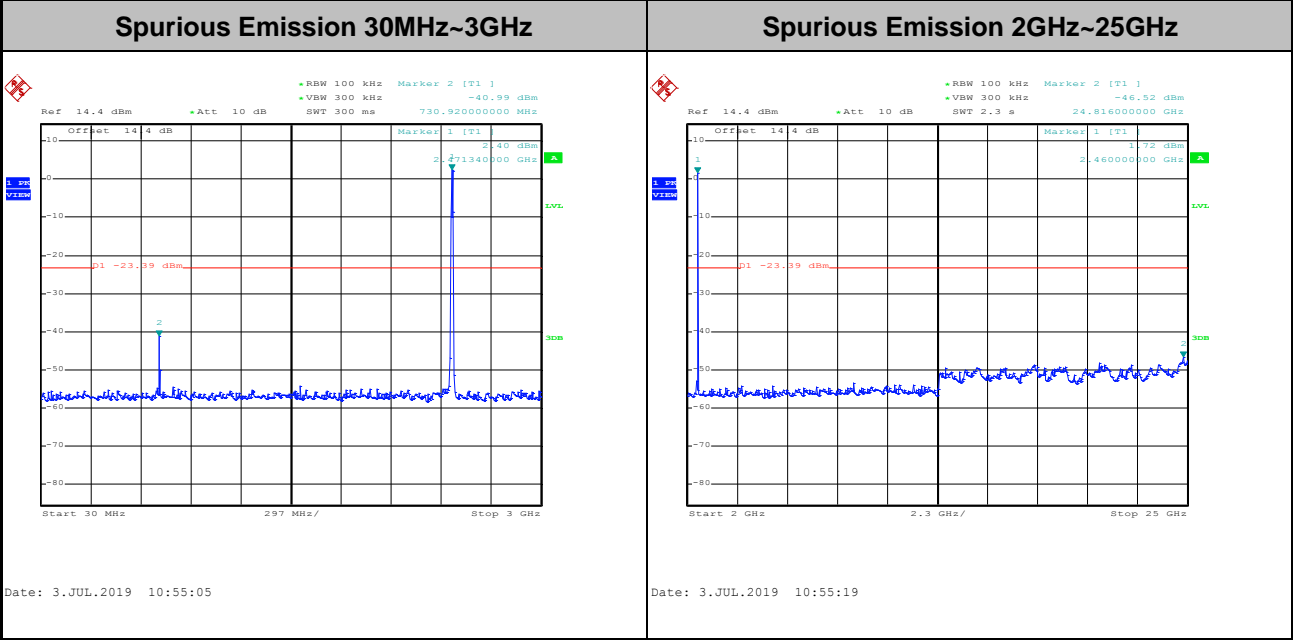
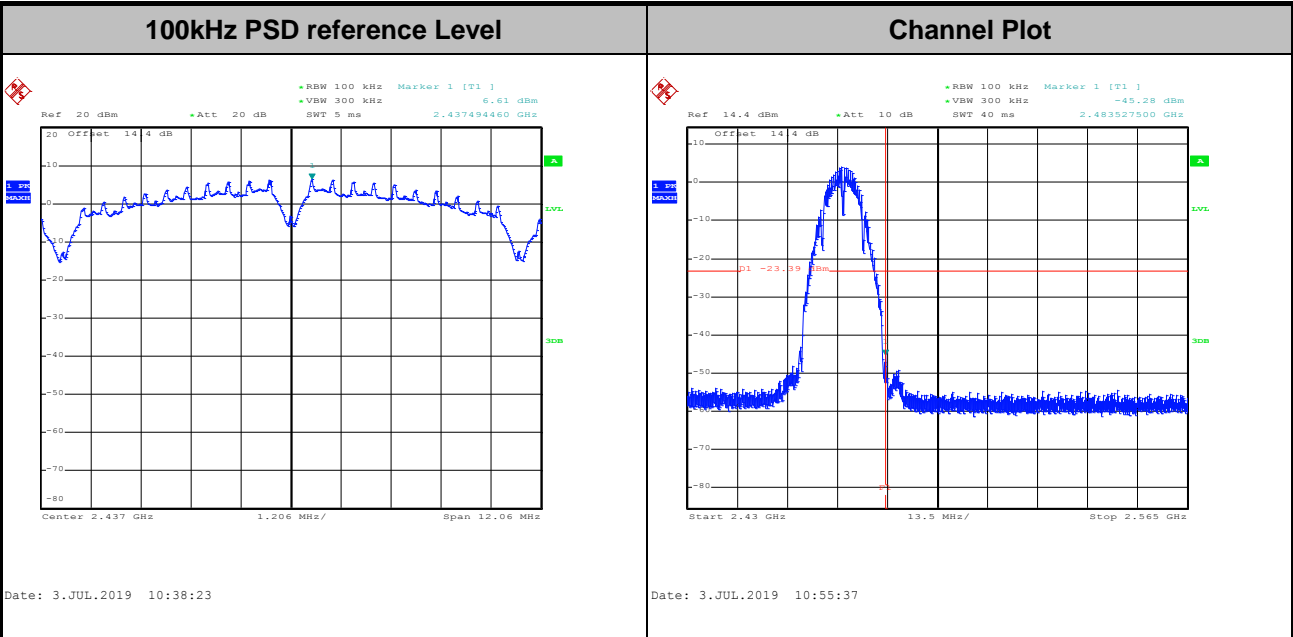



Test Mode :	802.11g	Test Channel :	01
-------------	---------	----------------	----

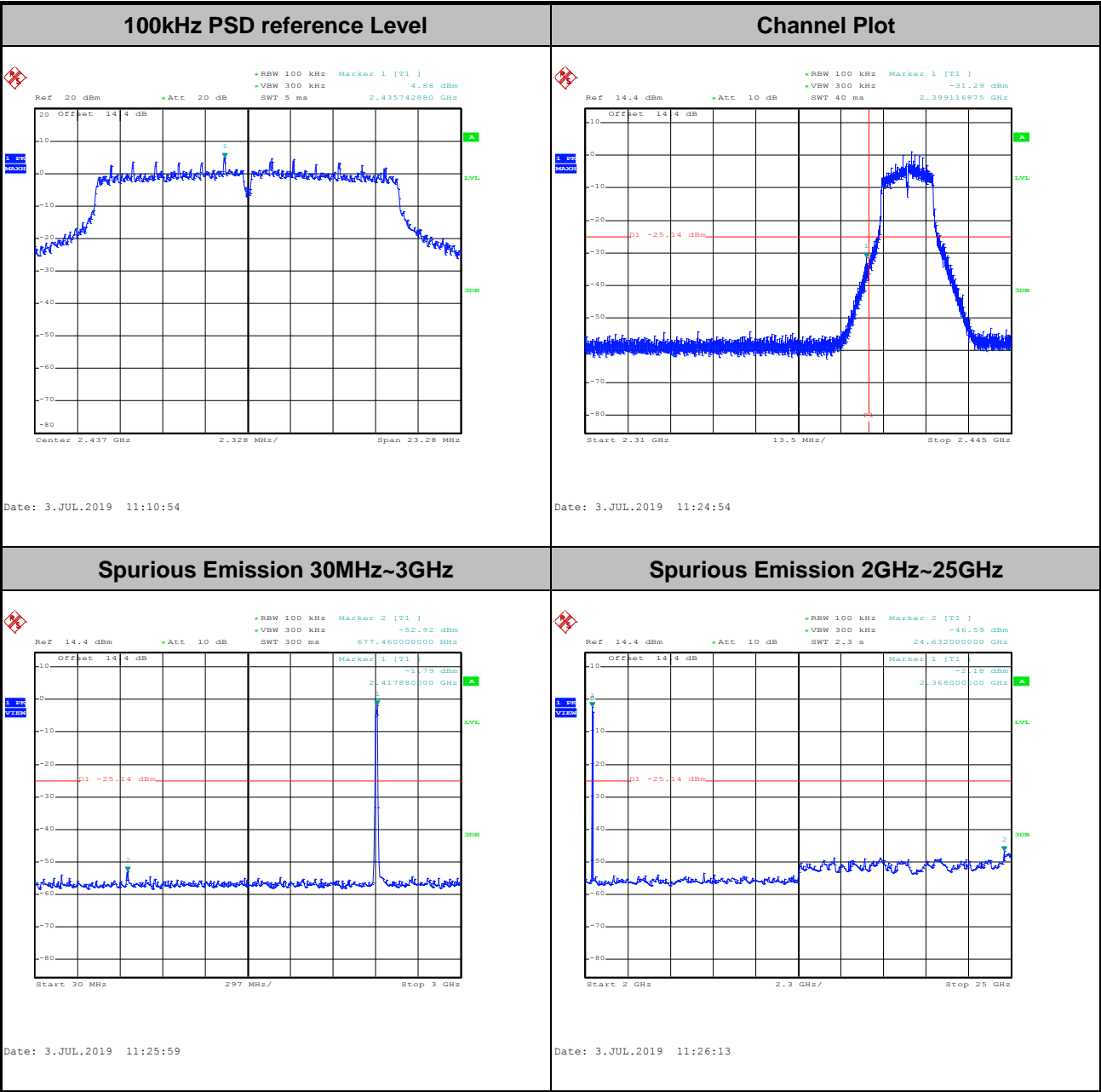



Test Mode :	802.11g	Test Channel :	06
-------------	---------	----------------	----

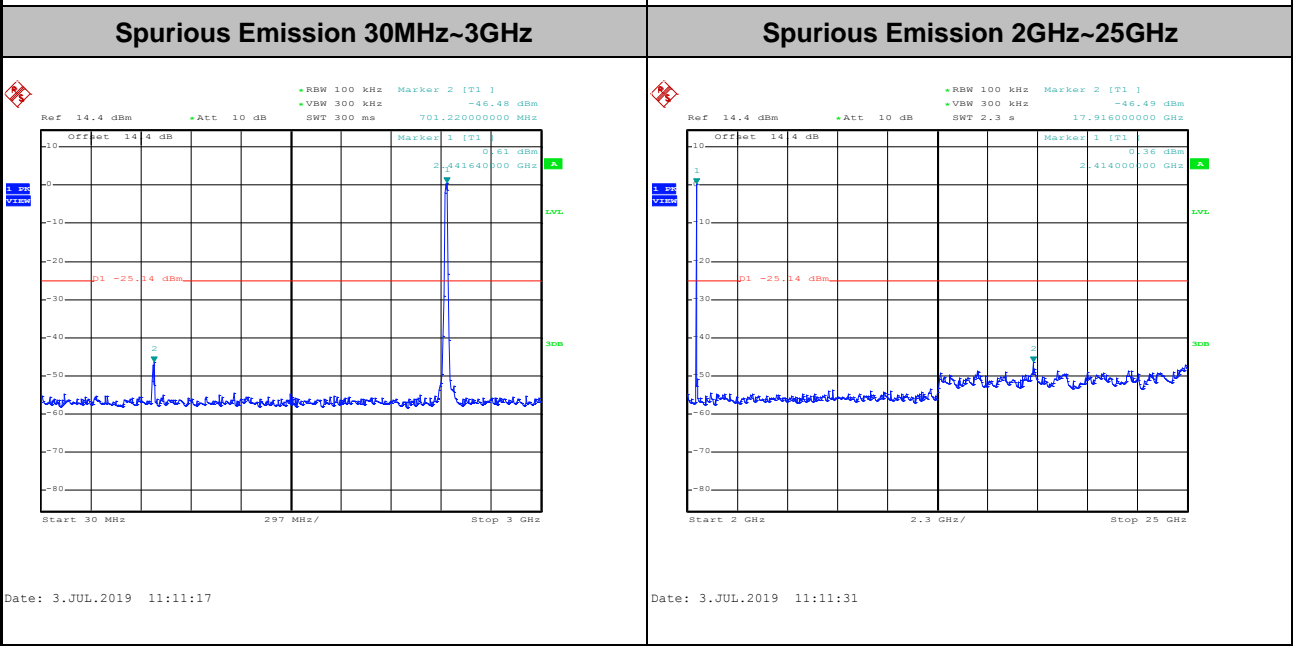
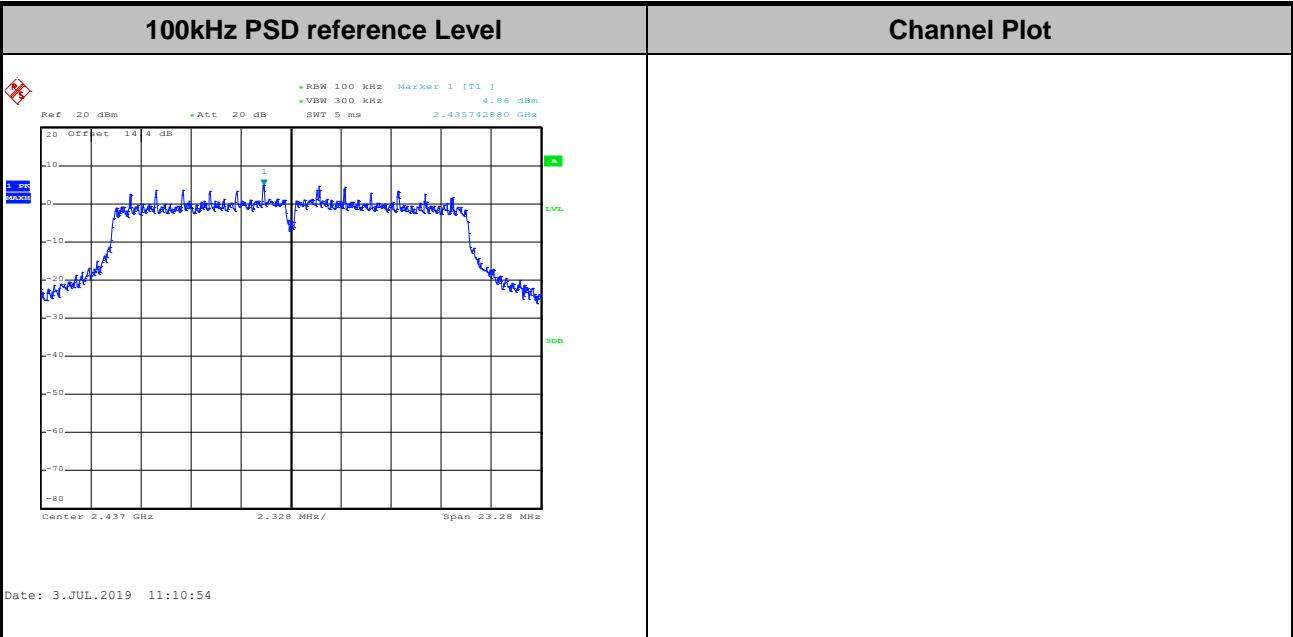



Test Mode :	802.11g	Test Channel :	11
-------------	---------	----------------	----

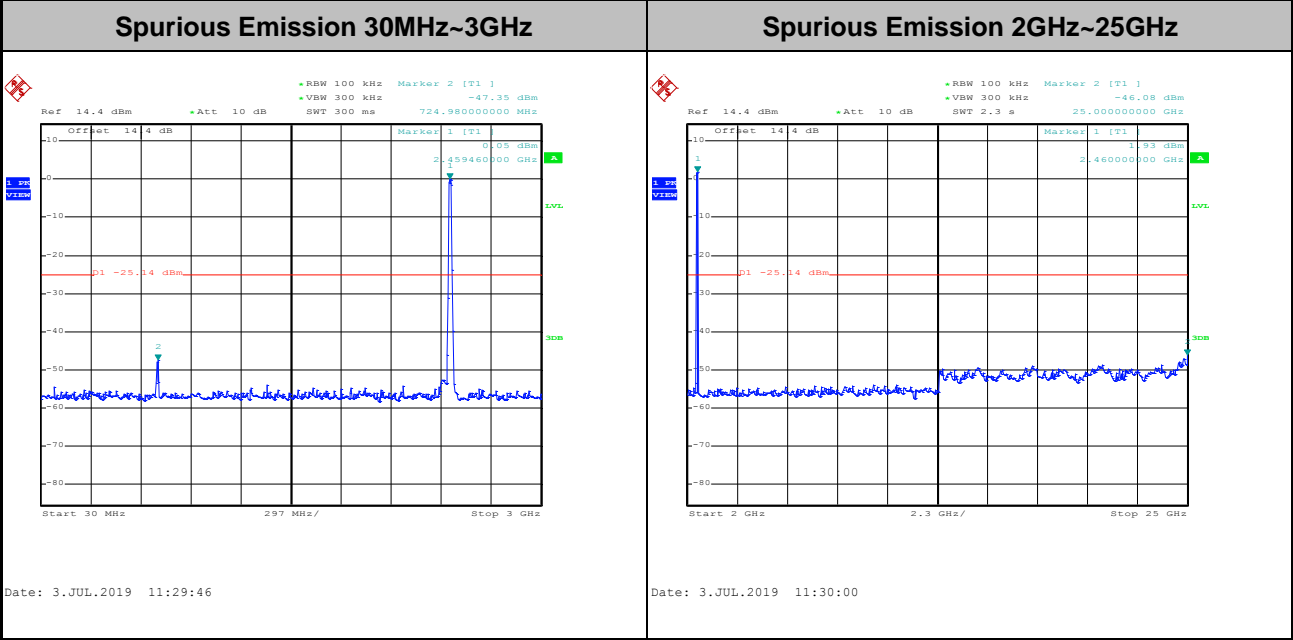
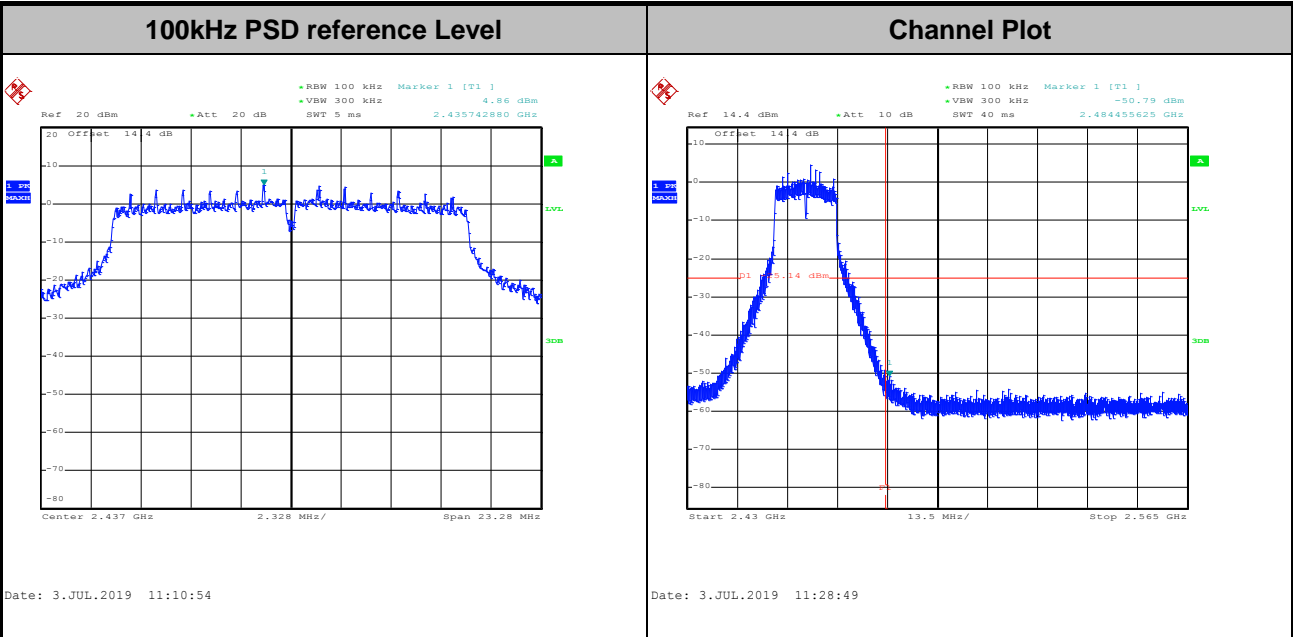



Test Mode :	802.11g	Test Channel :	12
-------------	---------	----------------	----

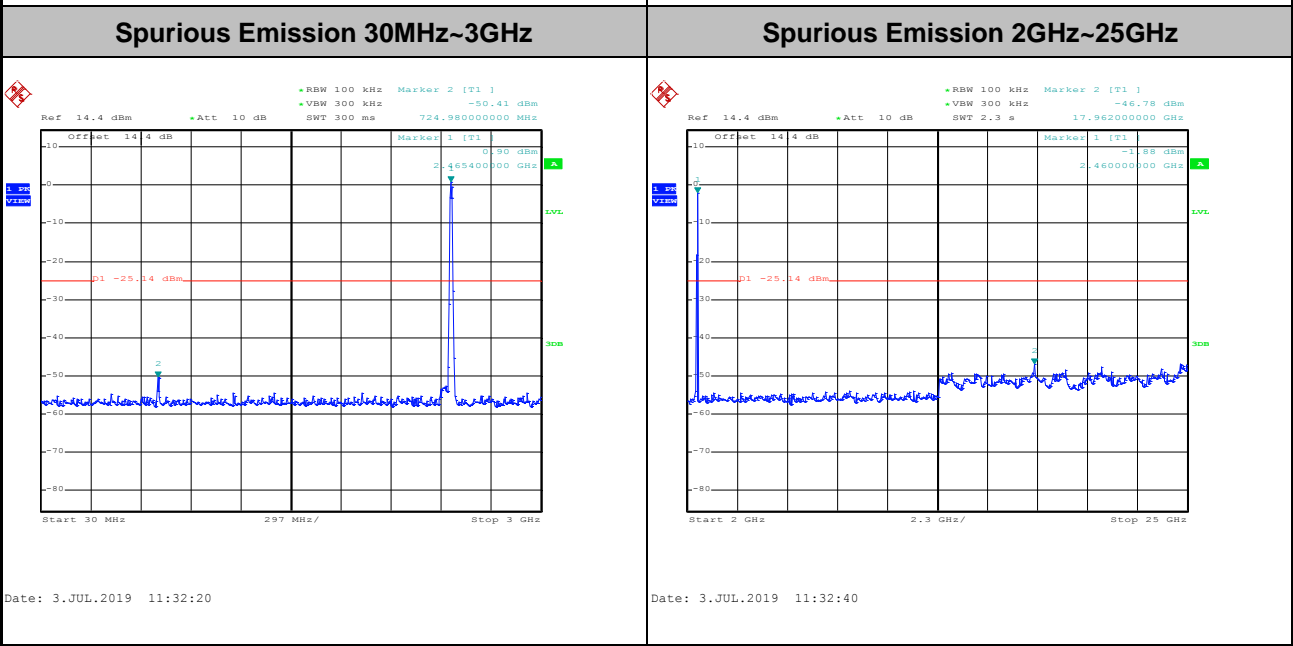
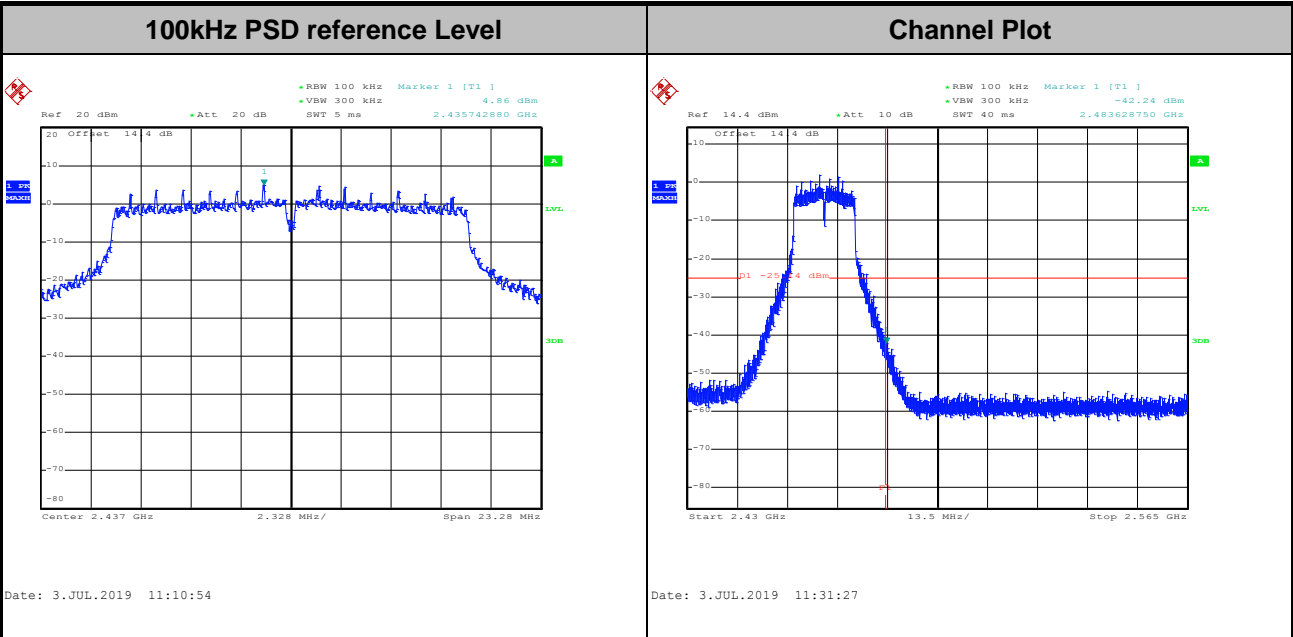



Test Mode :	802.11g	Test Channel :	13
-------------	---------	----------------	----

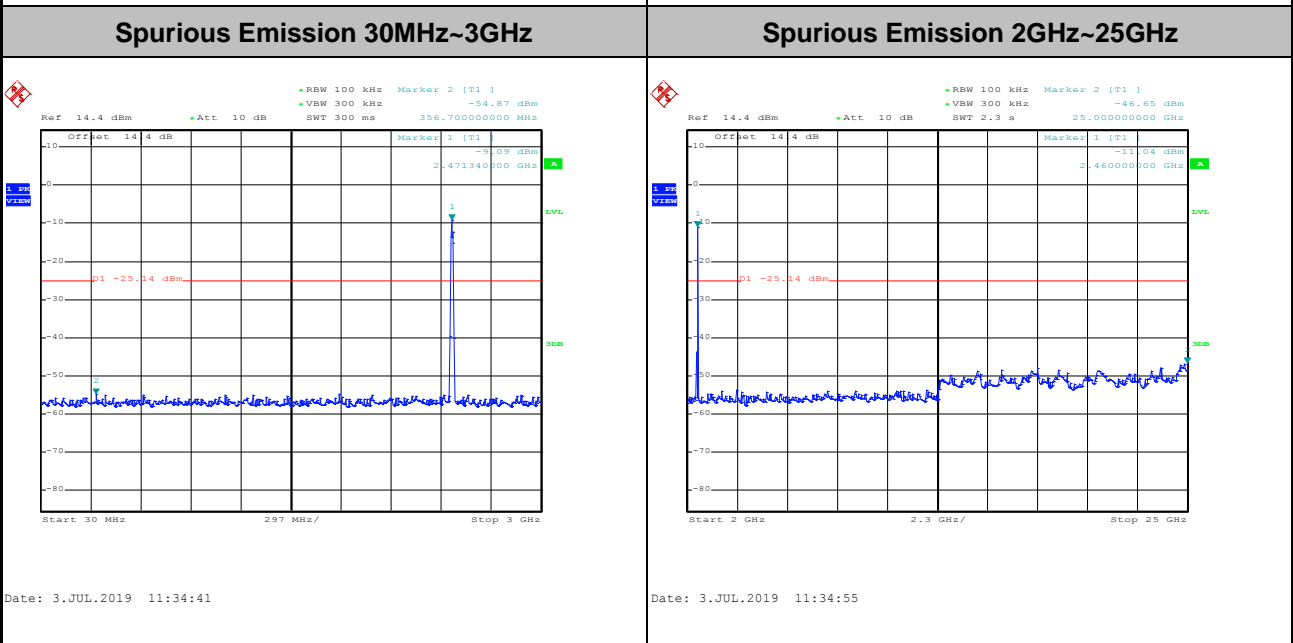
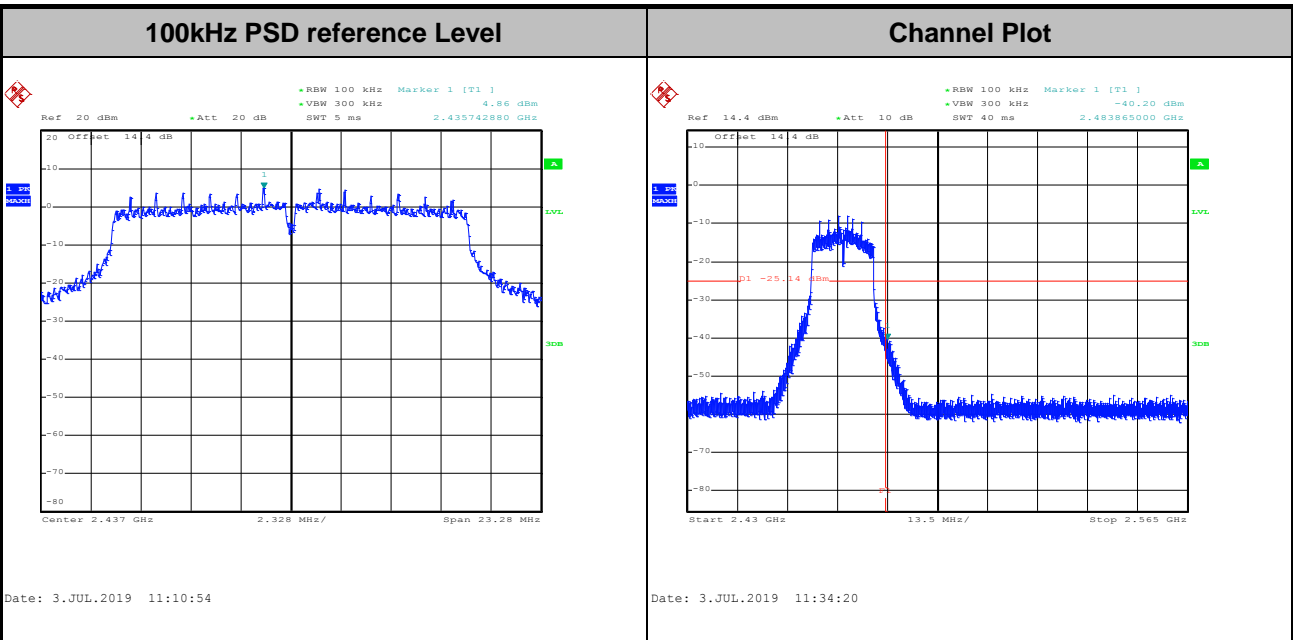



Test Mode :	802.11n HT20	Test Channel :	01
-------------	--------------	----------------	----

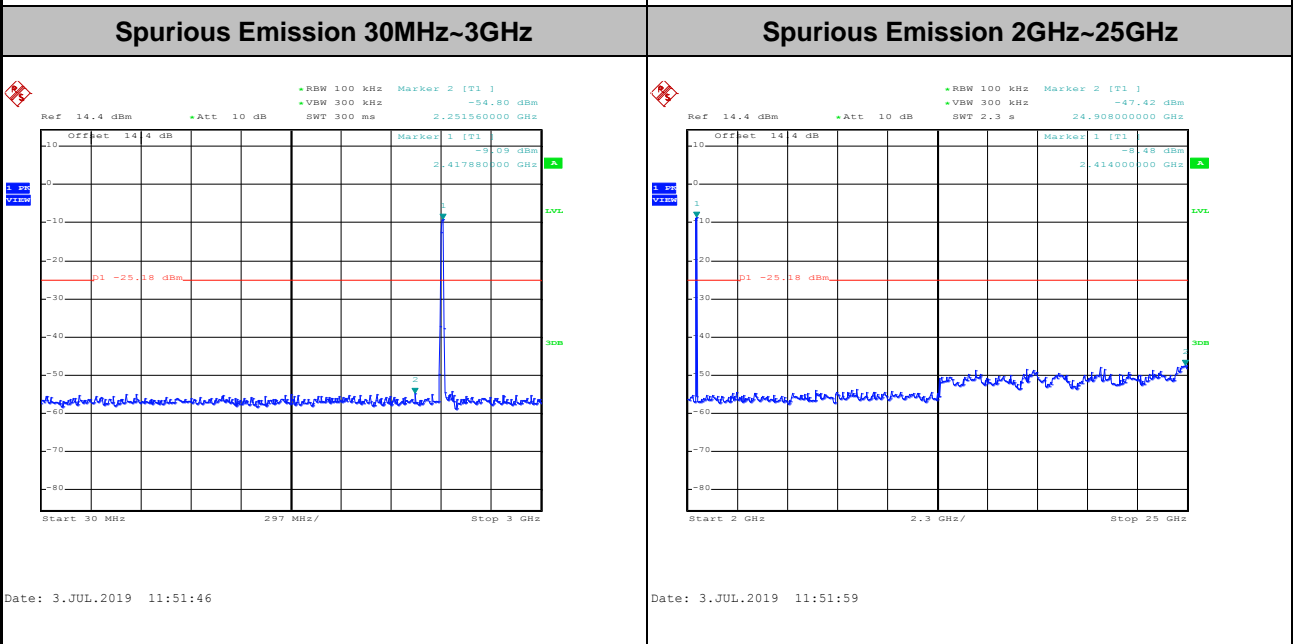
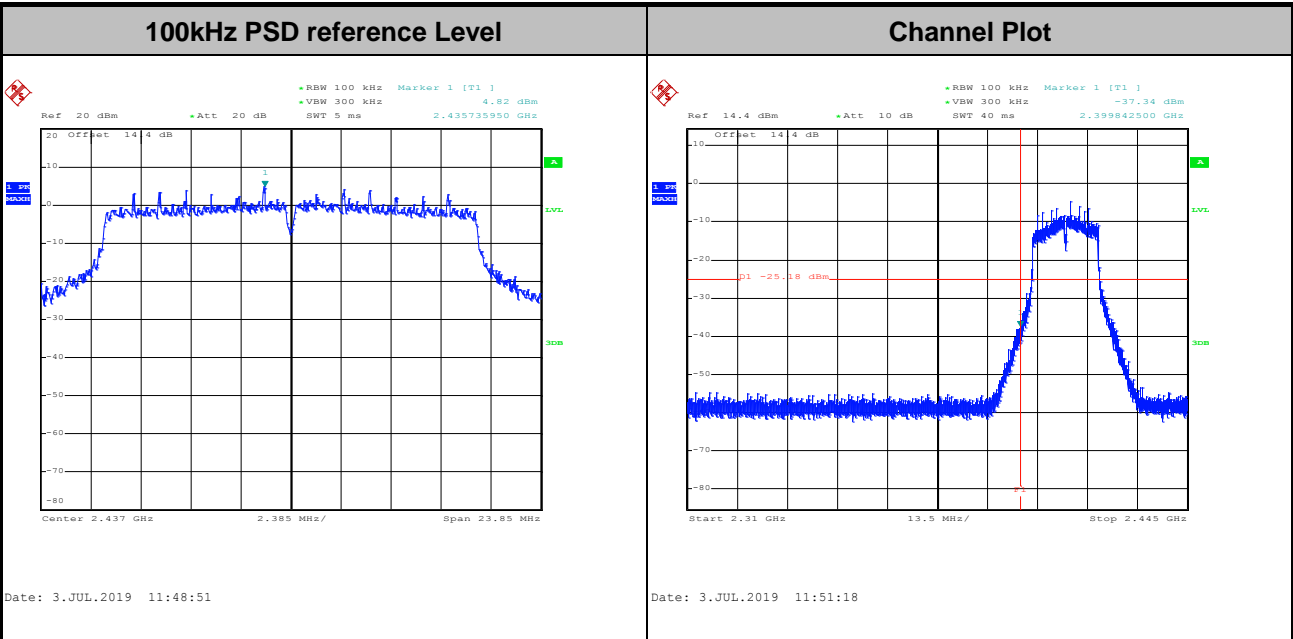



Test Mode :	802.11n HT20	Test Channel :	06
-------------	--------------	----------------	----

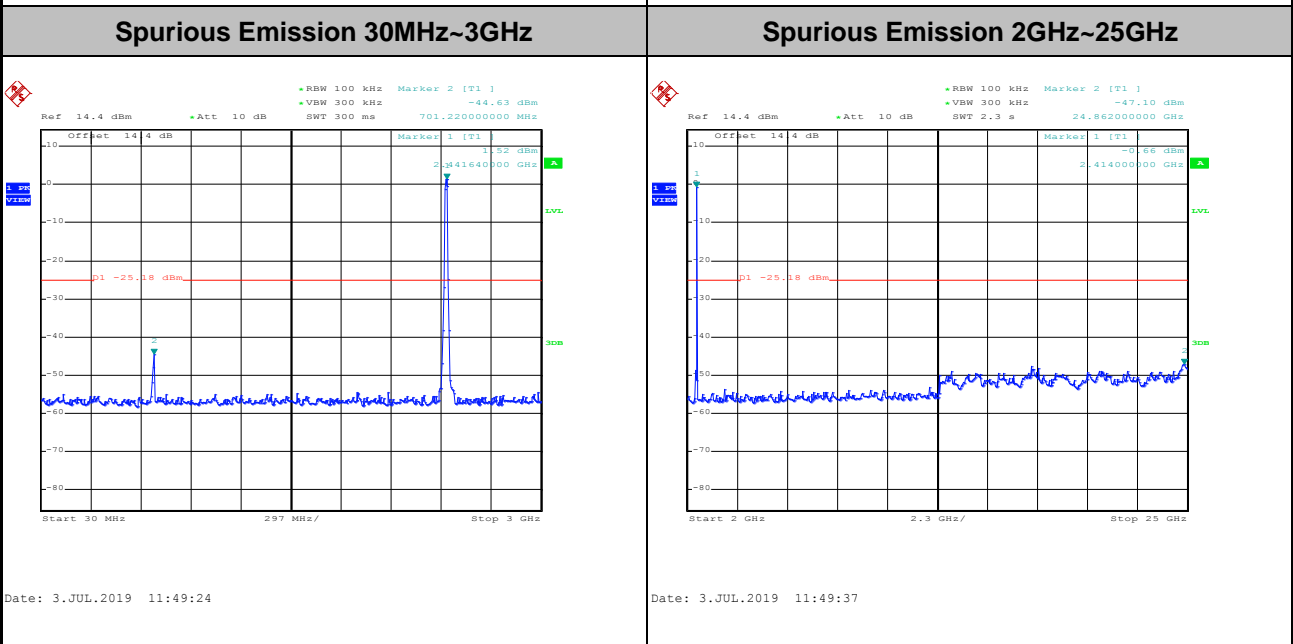
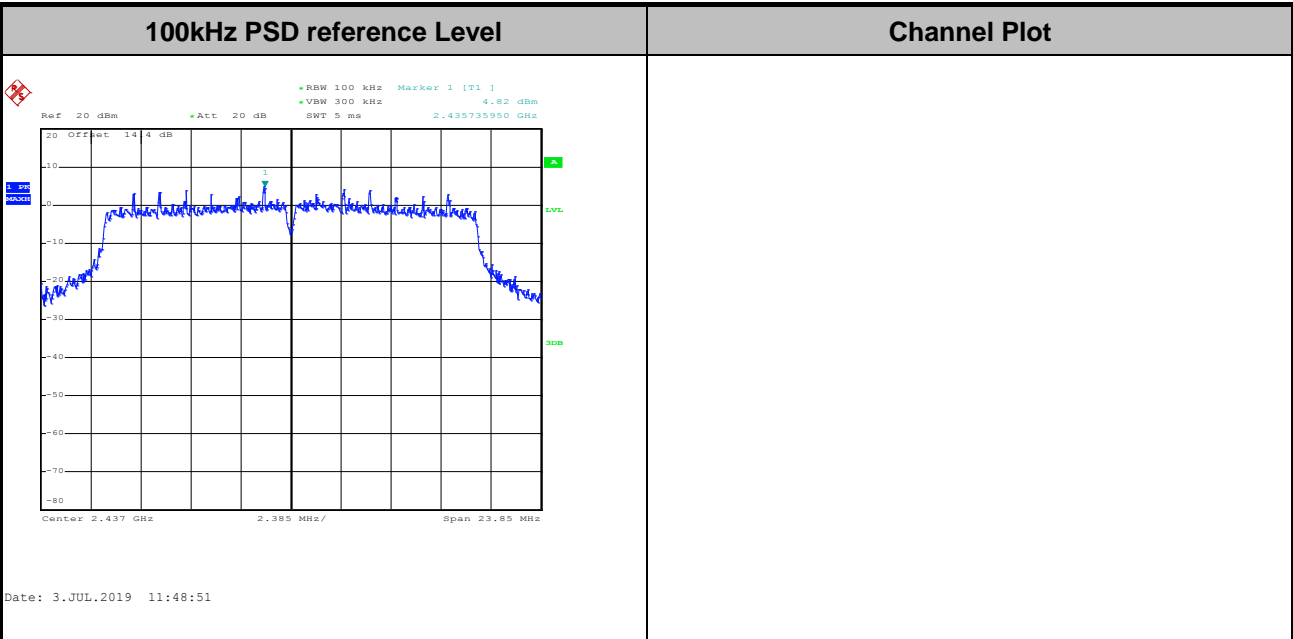



Test Mode :	802.11n HT20	Test Channel :	11
-------------	--------------	----------------	----

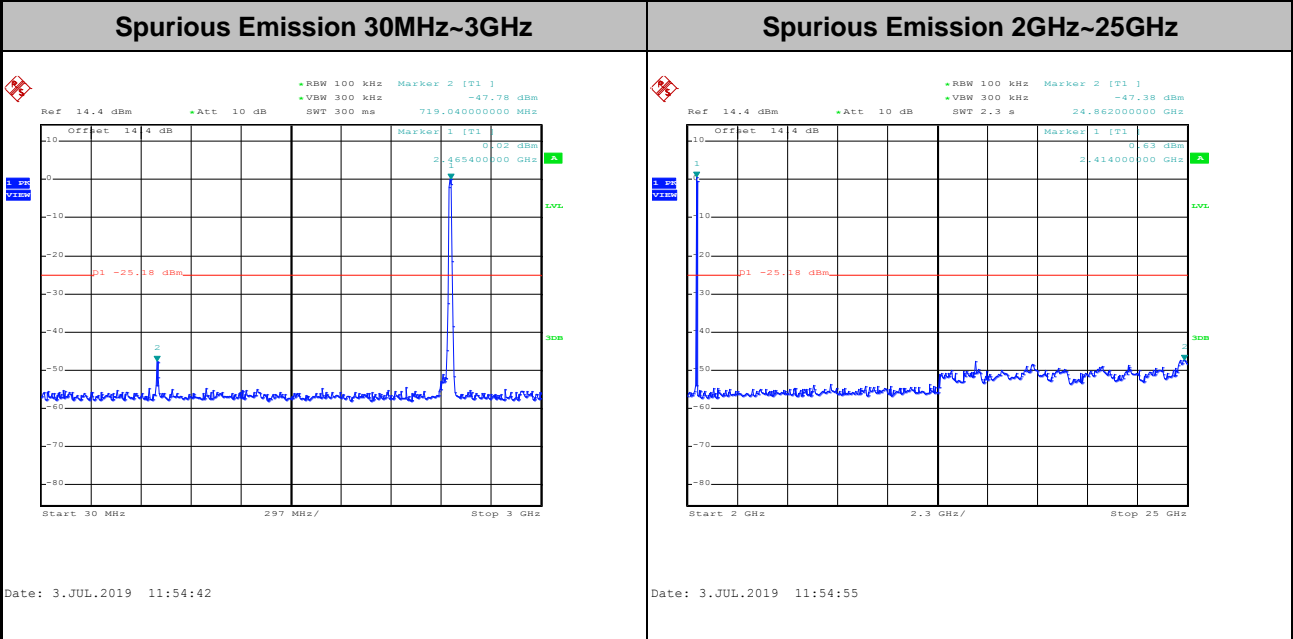
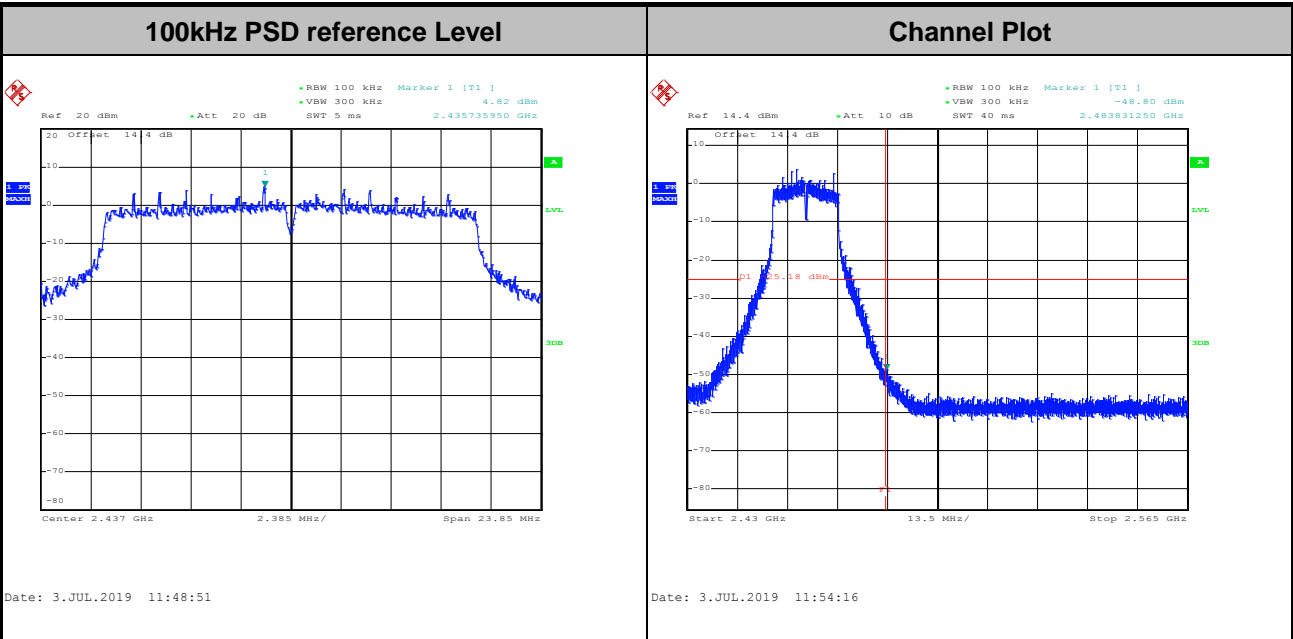



Test Mode :	802.11n HT20	Test Channel :	12
-------------	--------------	----------------	----

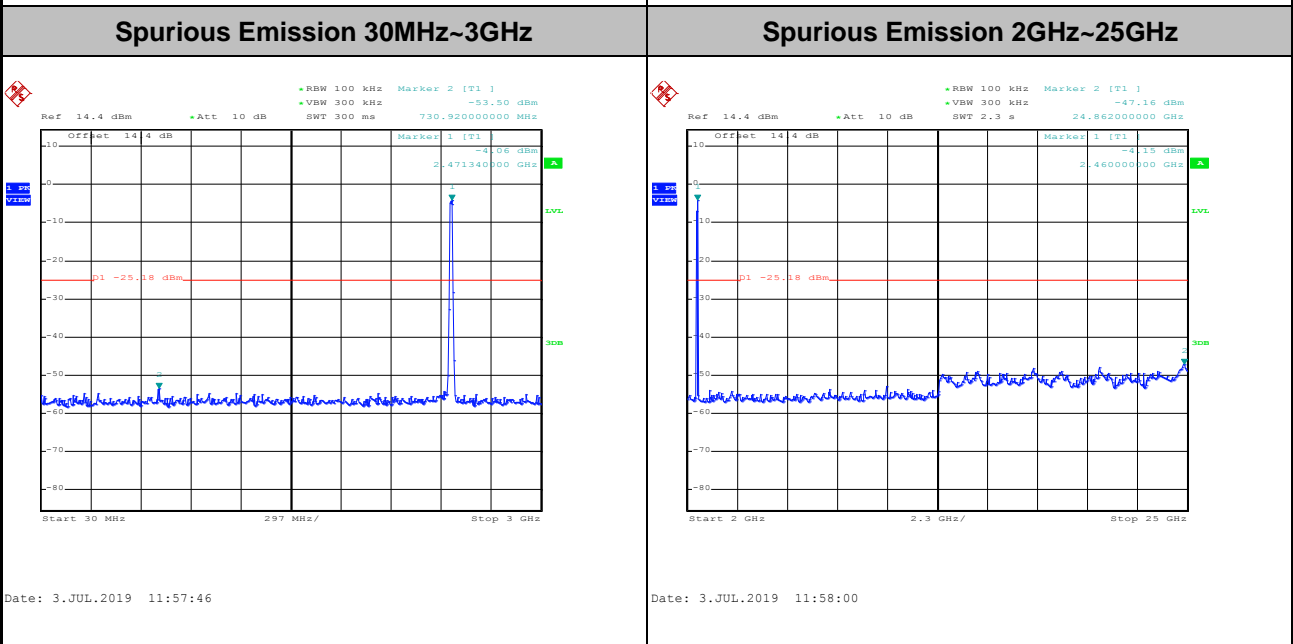
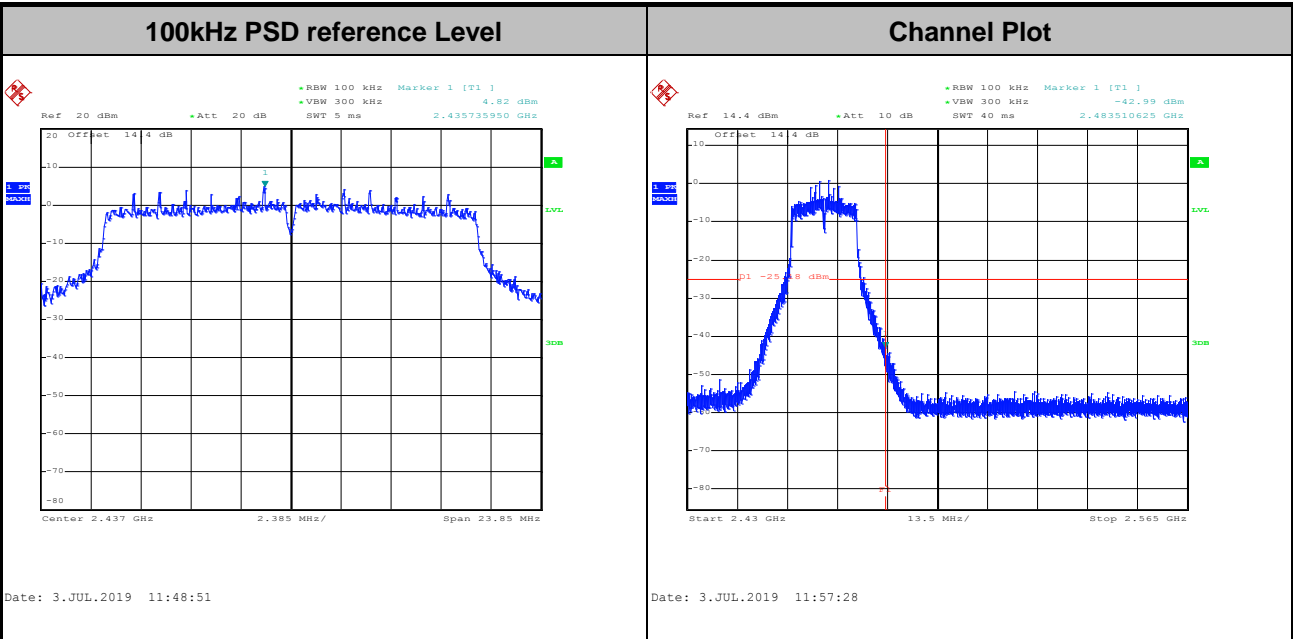



Test Mode :	802.11n HT20	Test Channel :	13
-------------	--------------	----------------	----

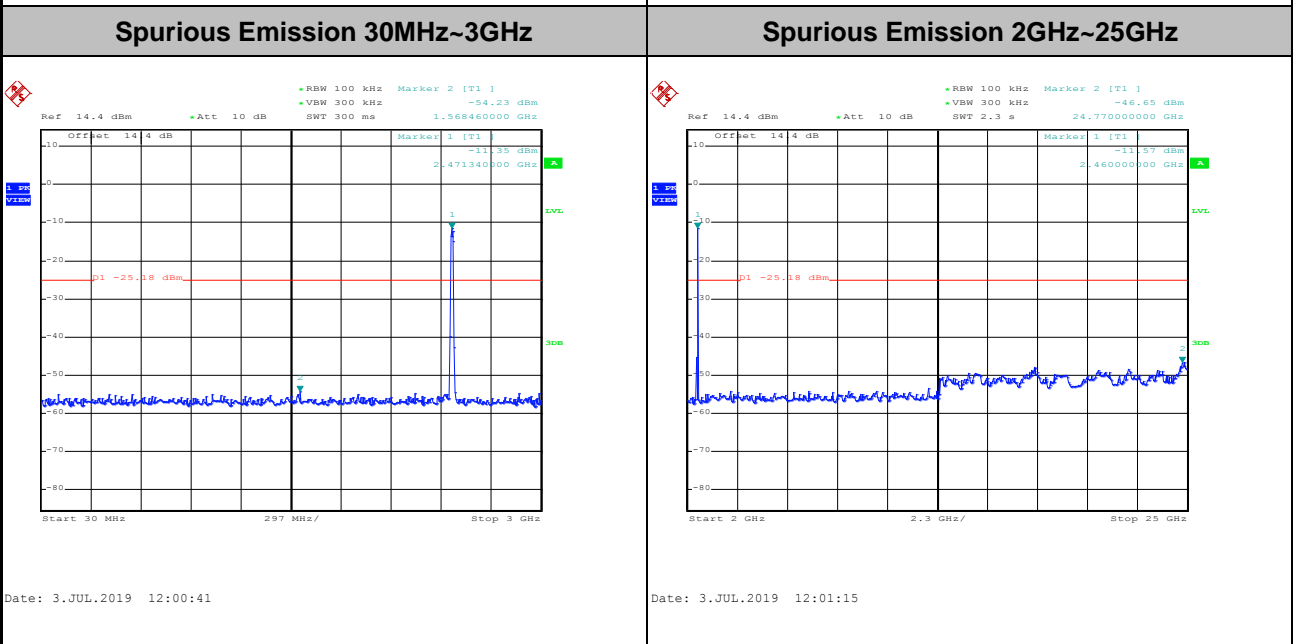
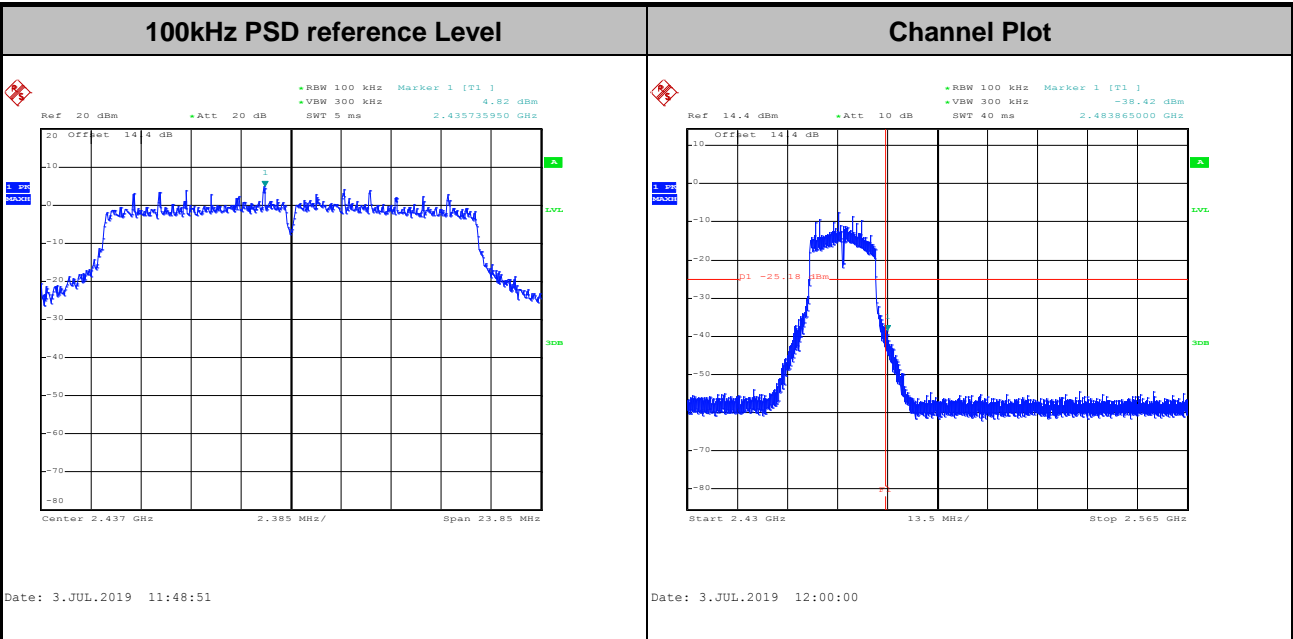



Test Mode :	802.11b	Test Channel :	06
-------------	---------	----------------	----

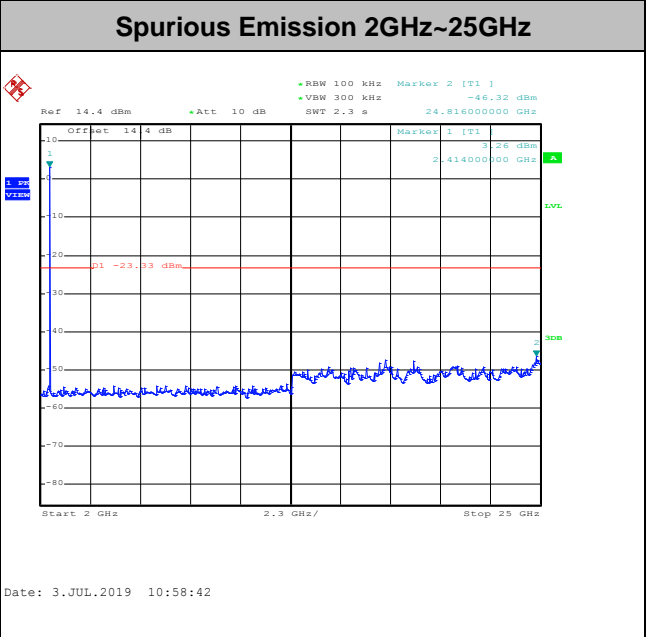
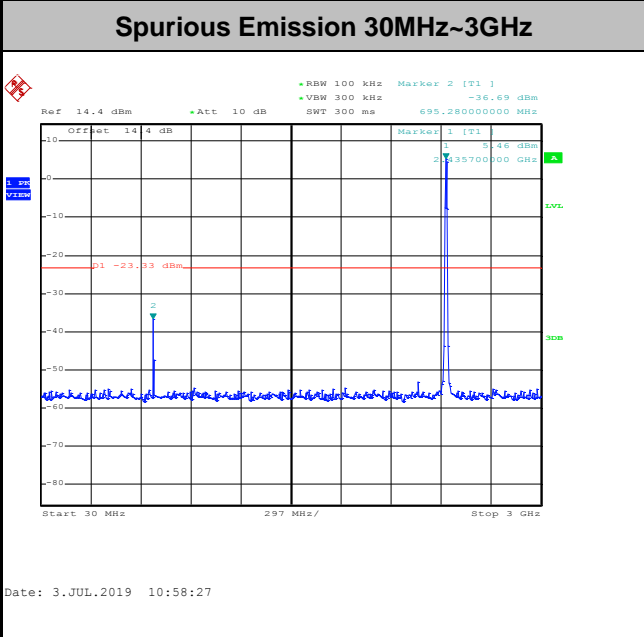
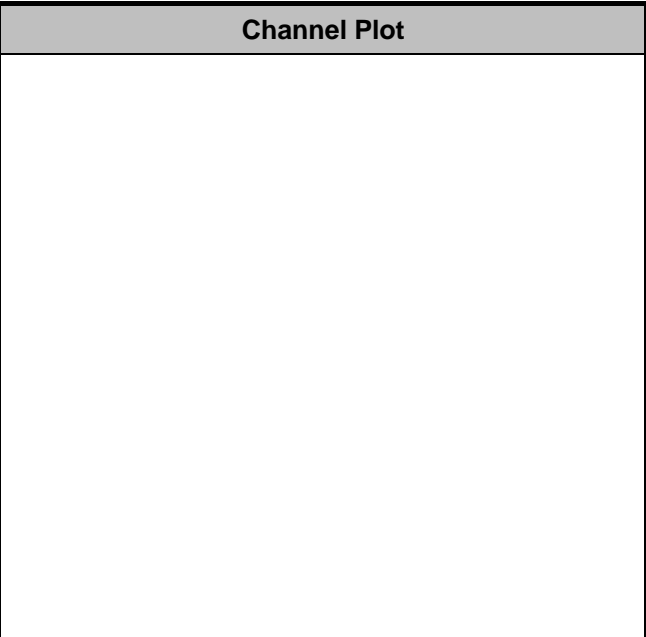
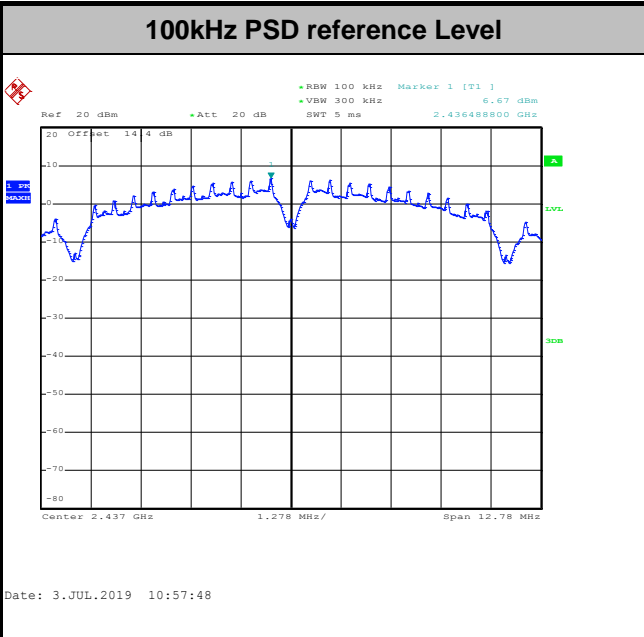



Test Mode :	802.11b	Test Channel :	11
-------------	---------	----------------	----

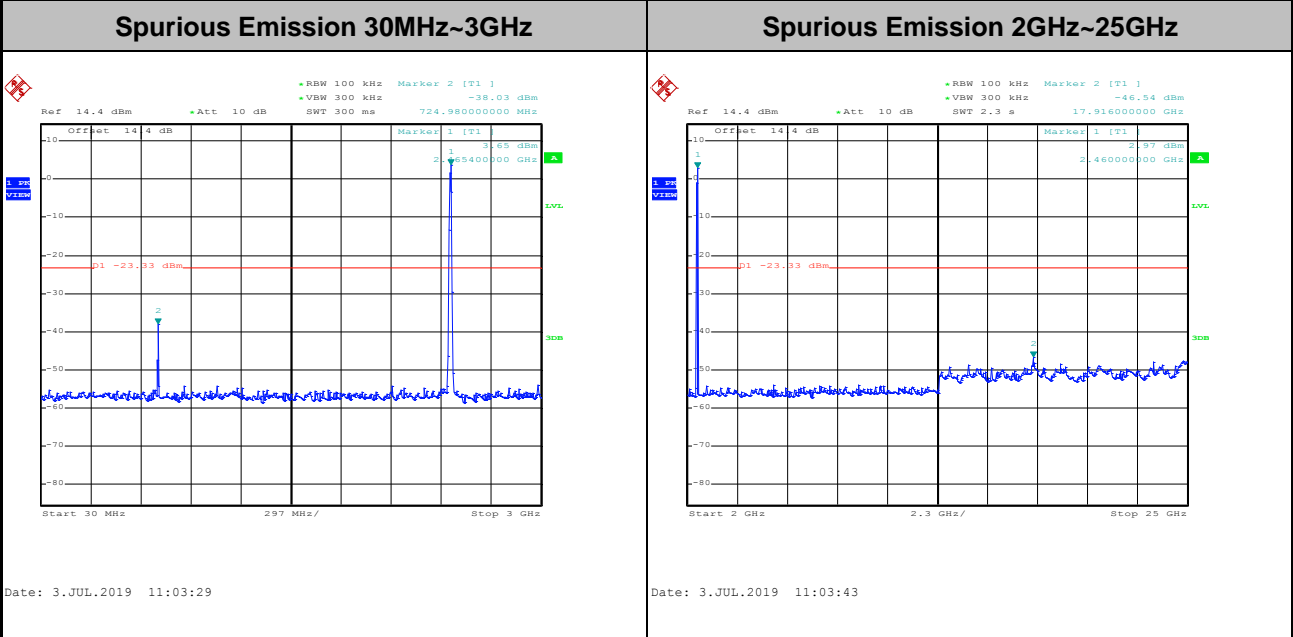
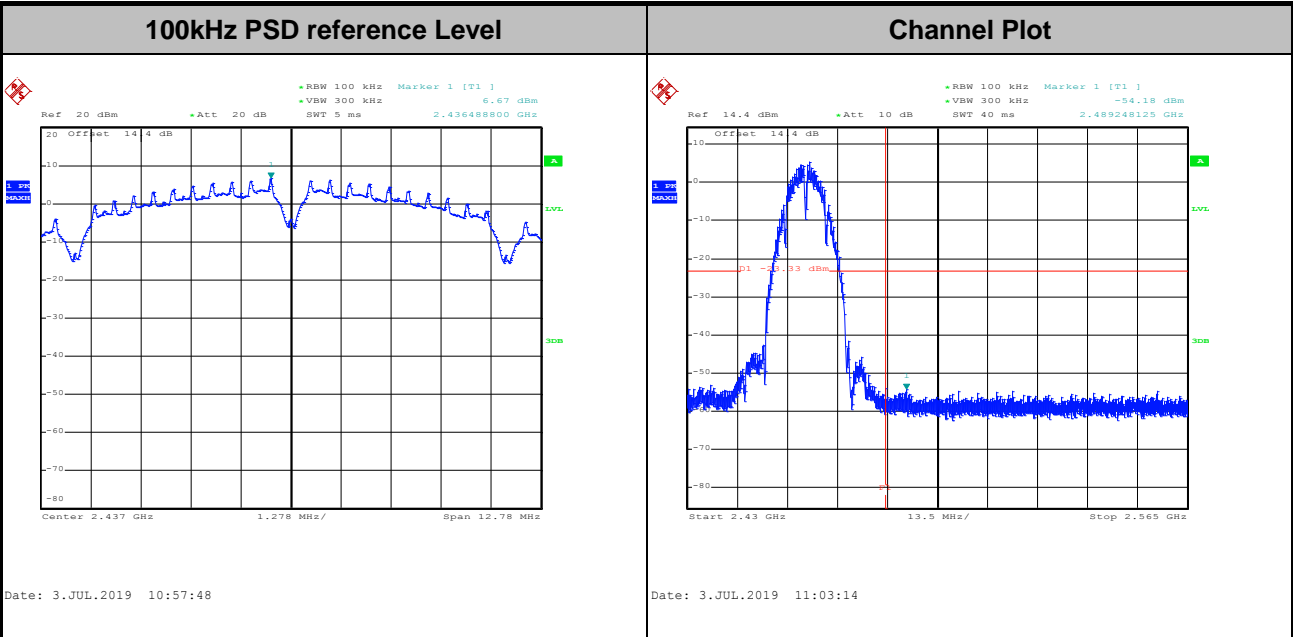



Test Mode :	802.11b	Test Channel :	12
-------------	---------	----------------	----

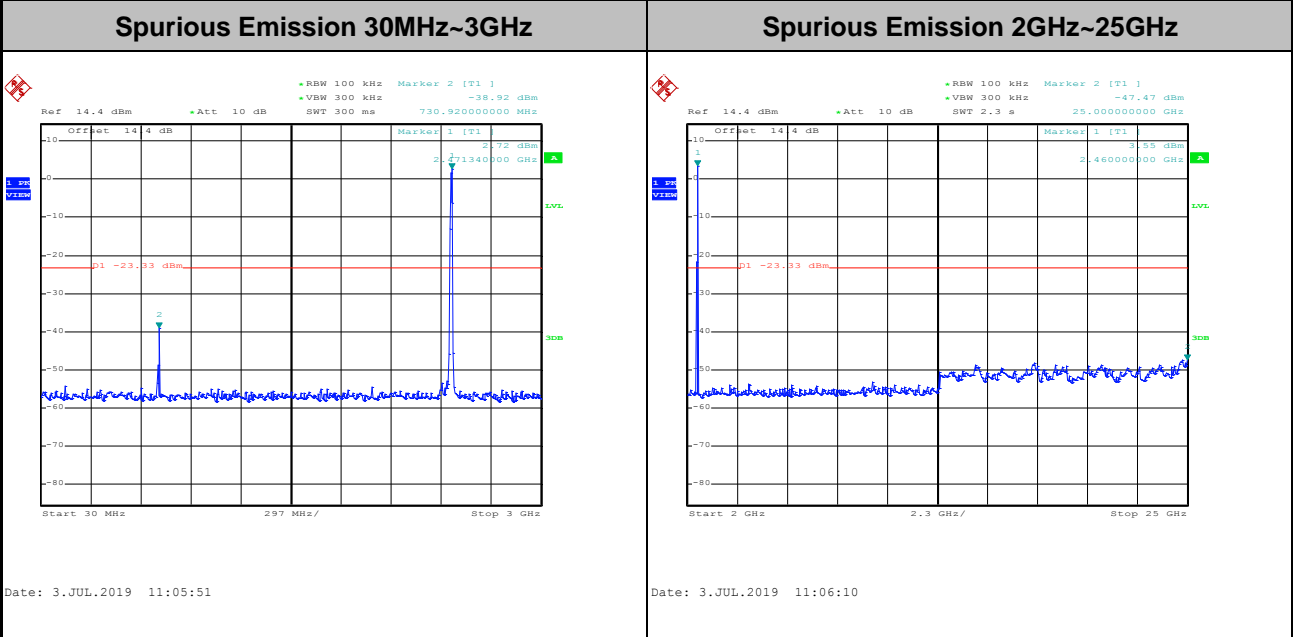
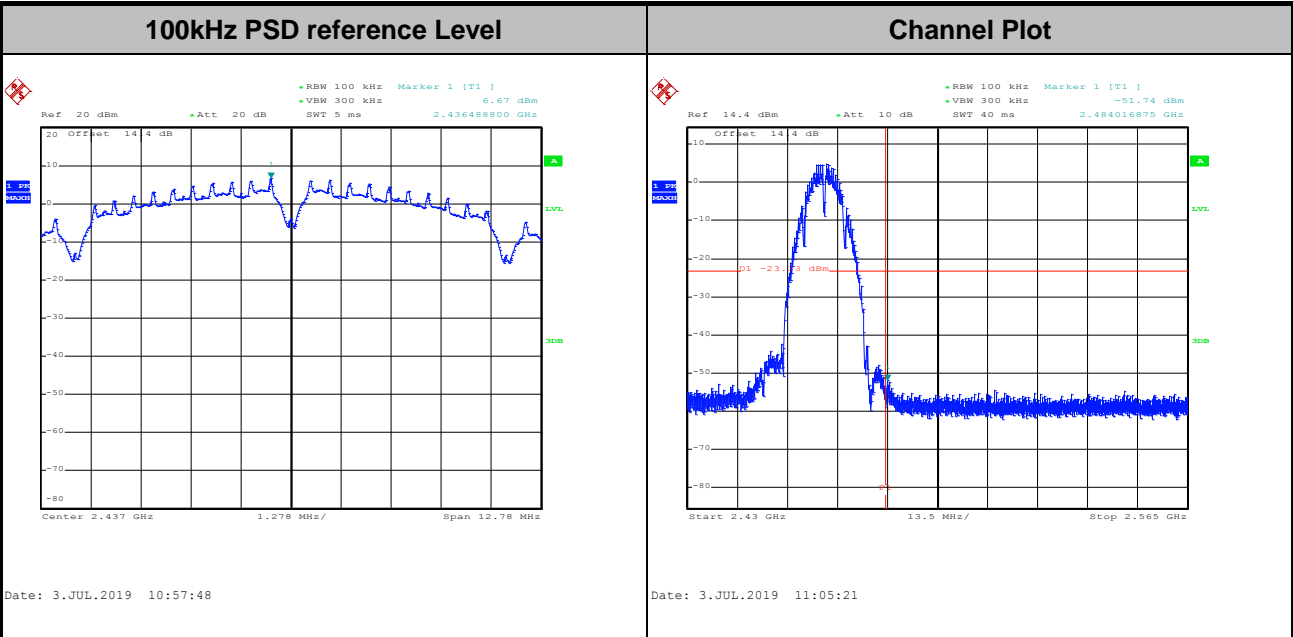



Test Mode :	802.11b	Test Channel :	13
-------------	---------	----------------	----

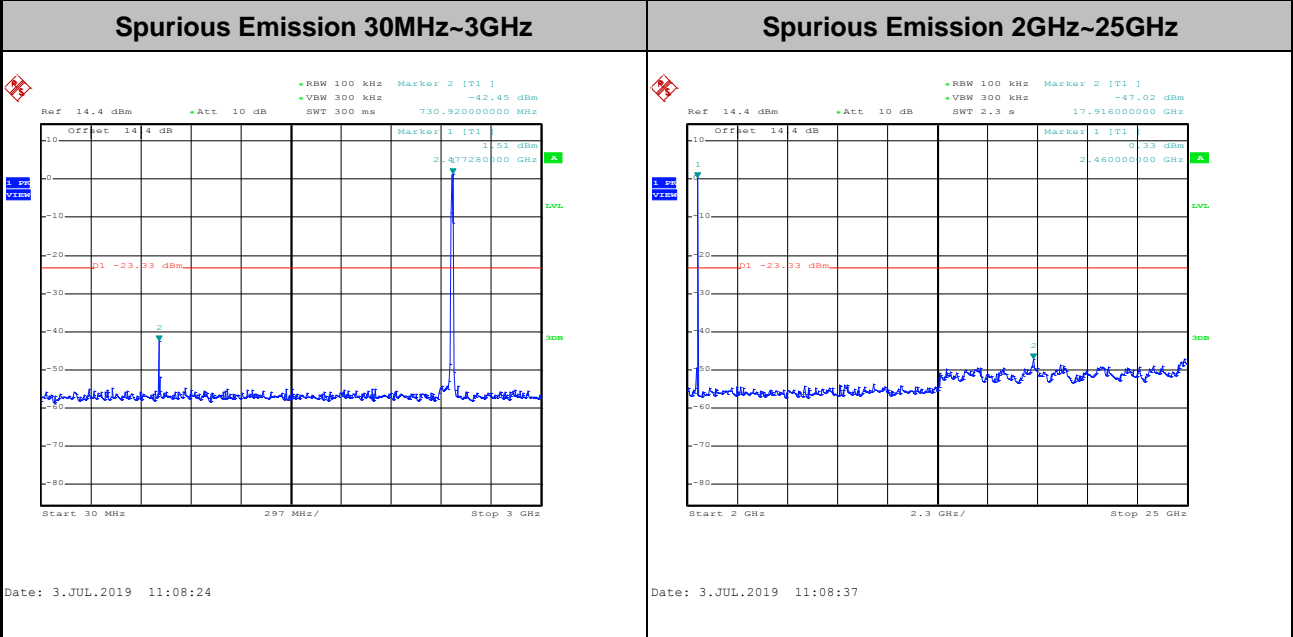
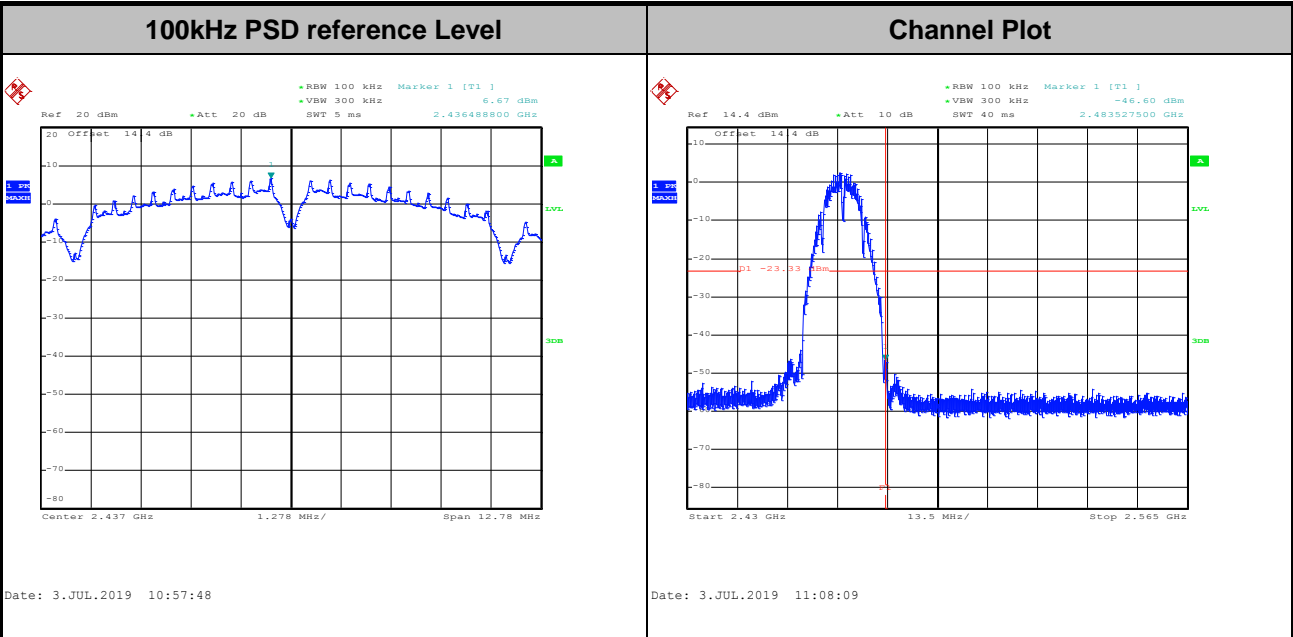



Test Mode : 802.11g Test Channel : 01

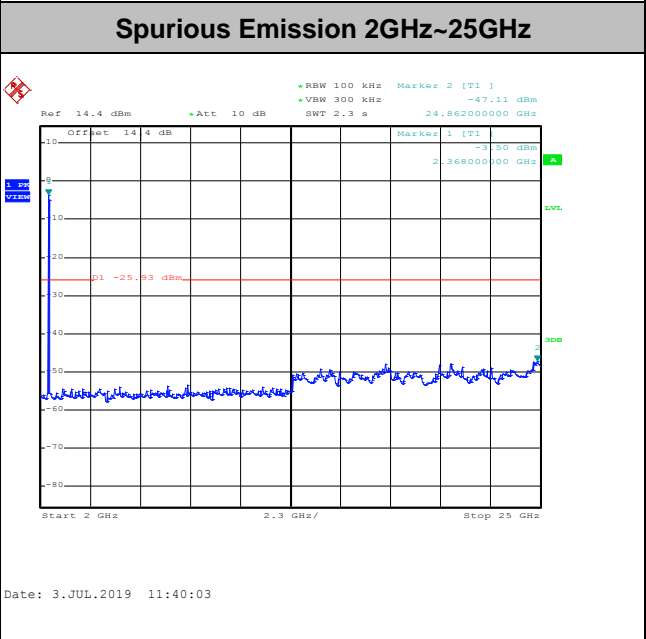
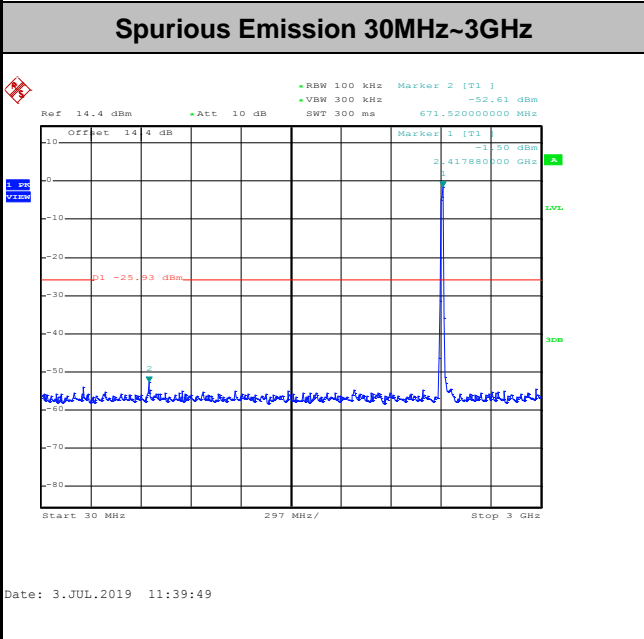
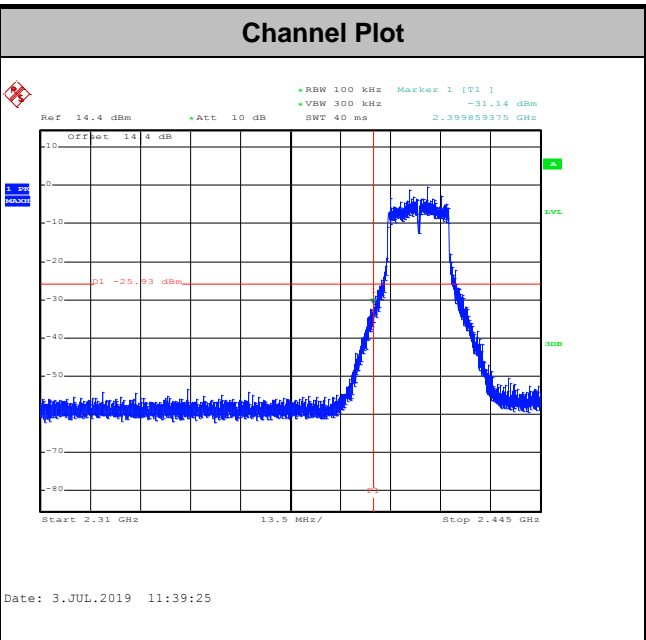
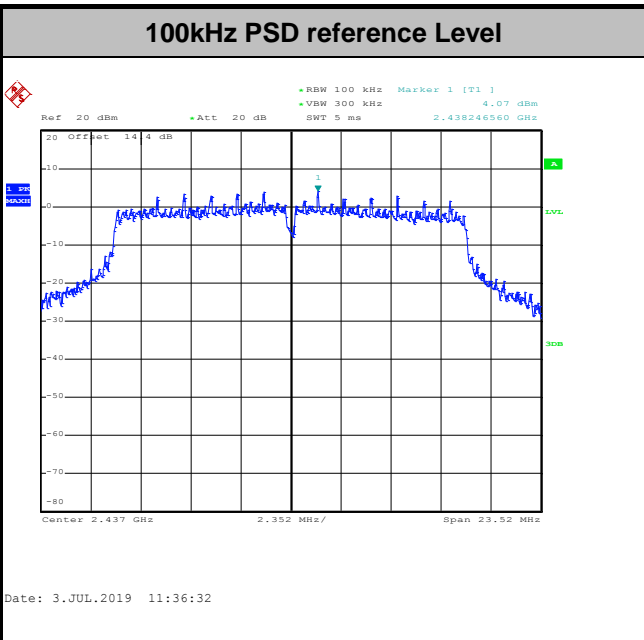



Test Mode :	802.11g	Test Channel :	06
-------------	---------	----------------	----

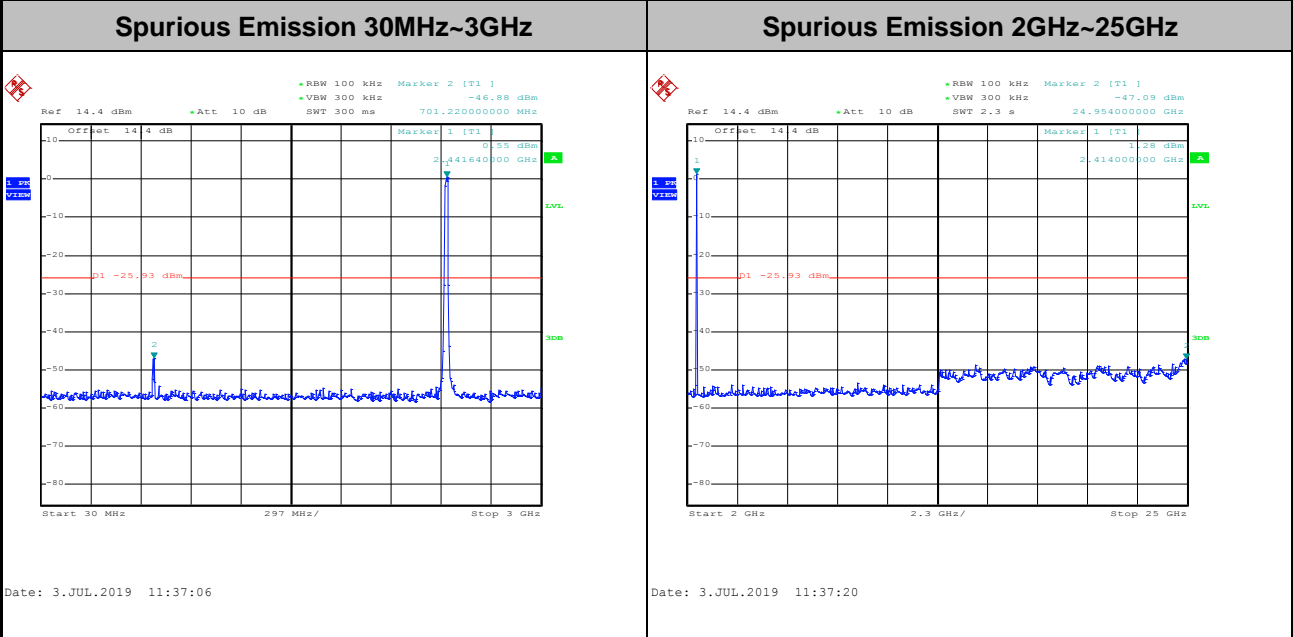
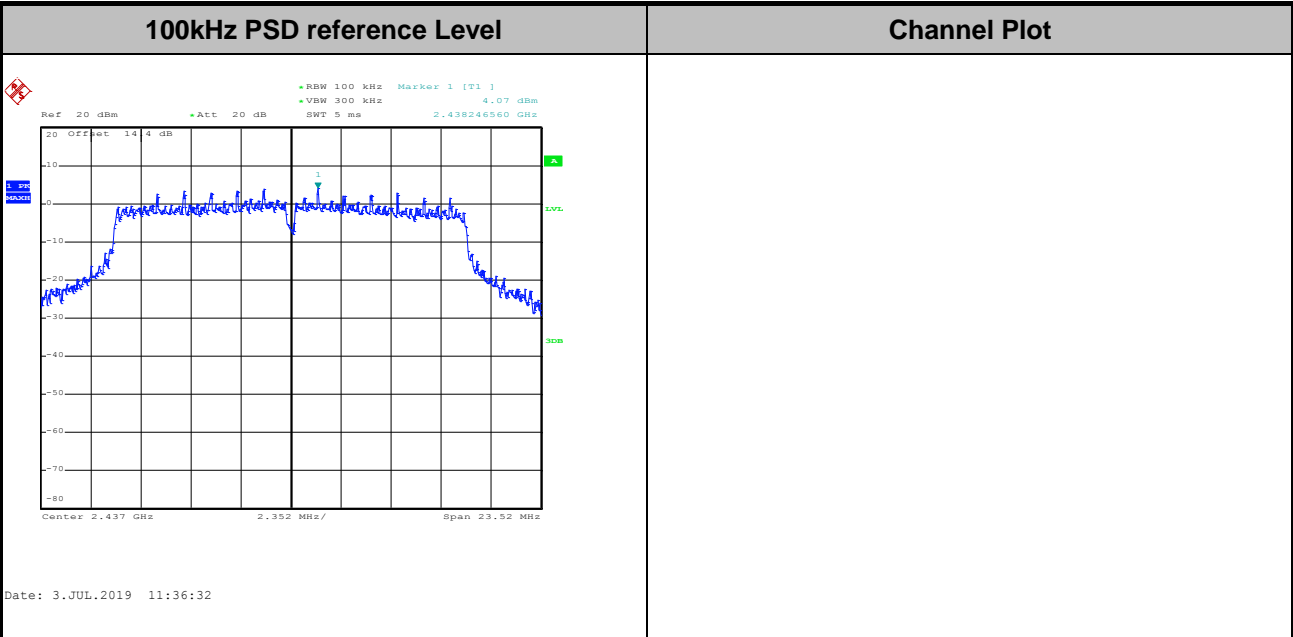



Test Mode :	802.11g	Test Channel :	11
-------------	---------	----------------	----

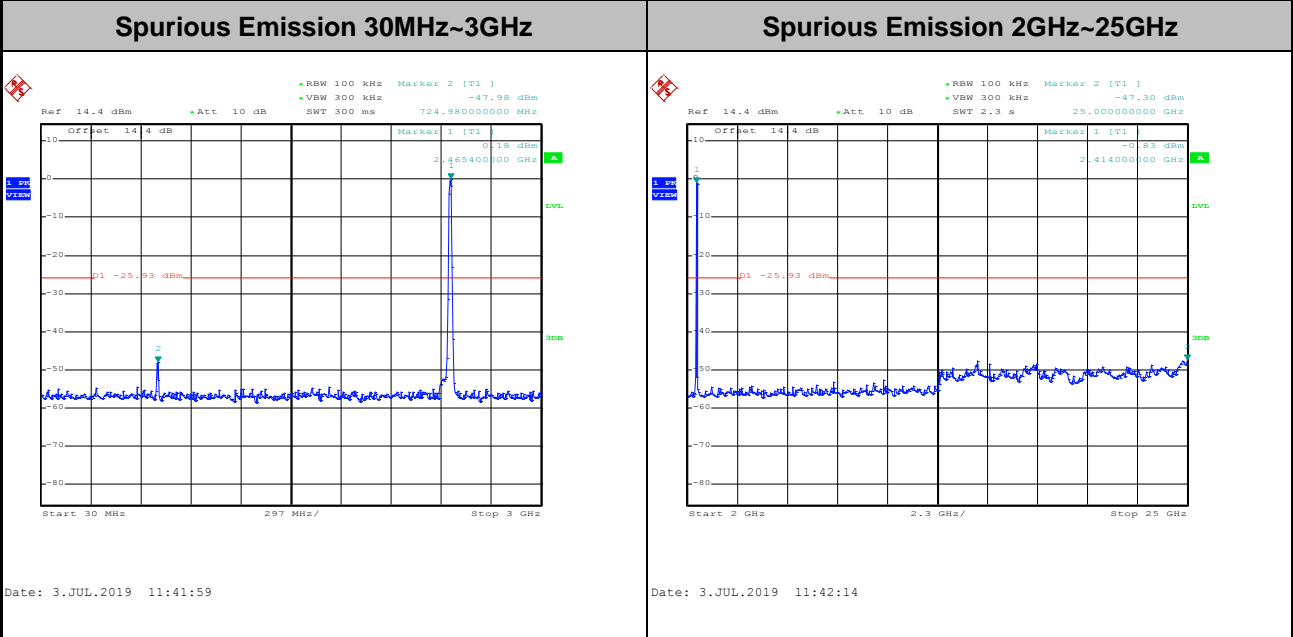
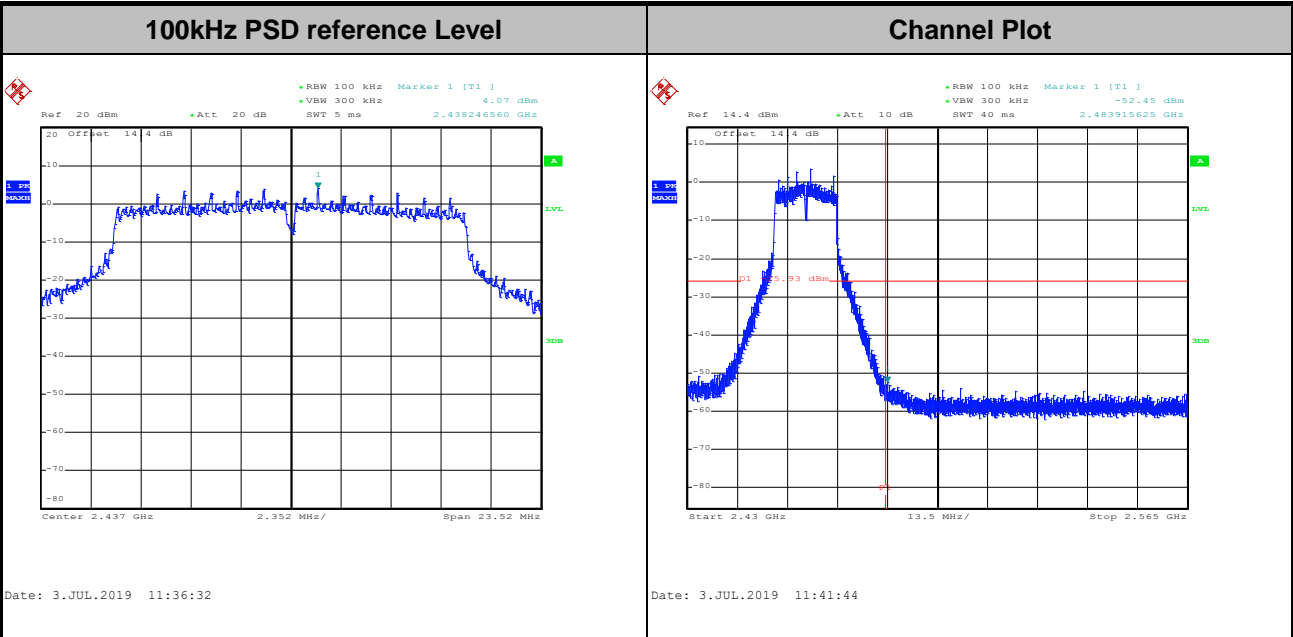



Test Mode : 802.11g Test Channel : 12

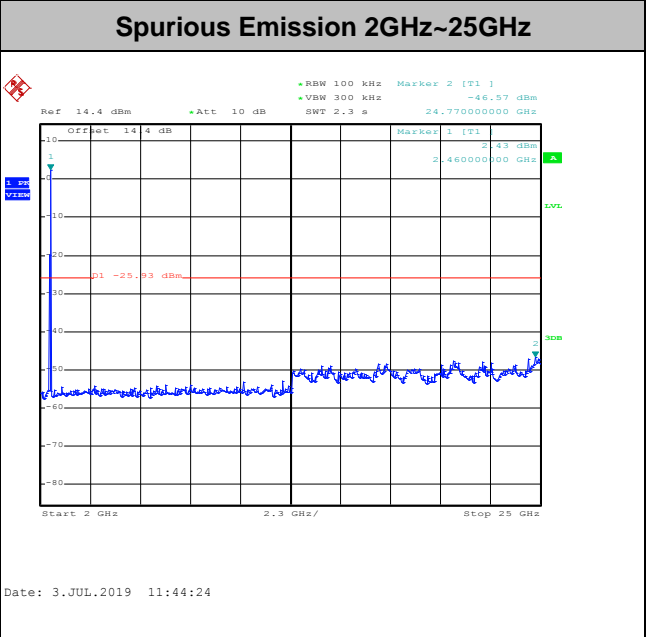
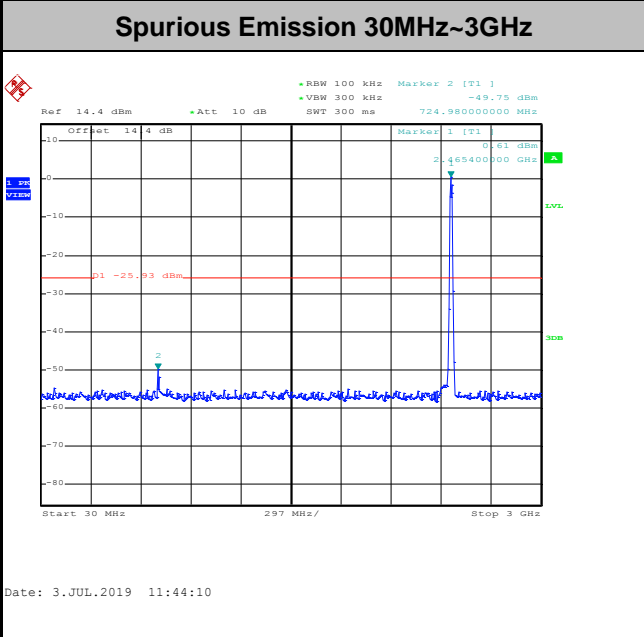
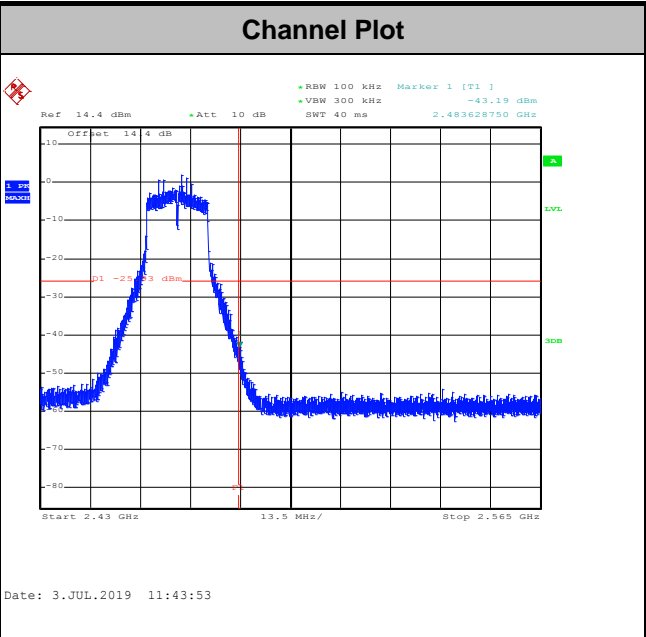
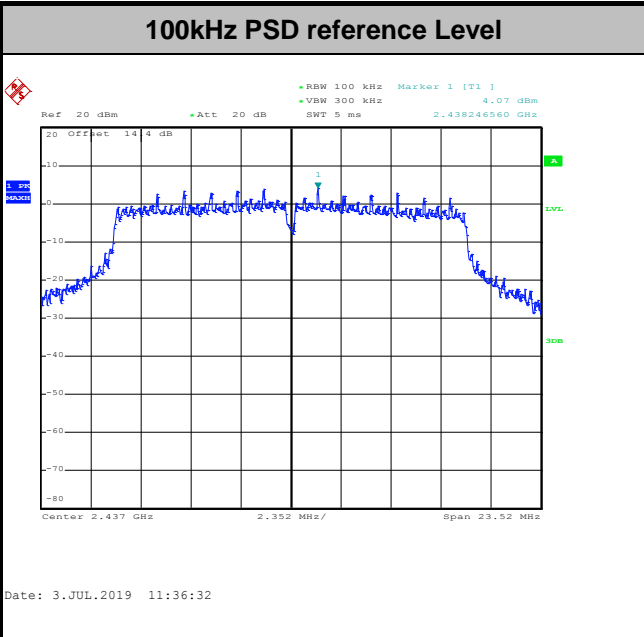



Test Mode :	802.11g	Test Channel :	13
-------------	---------	----------------	----

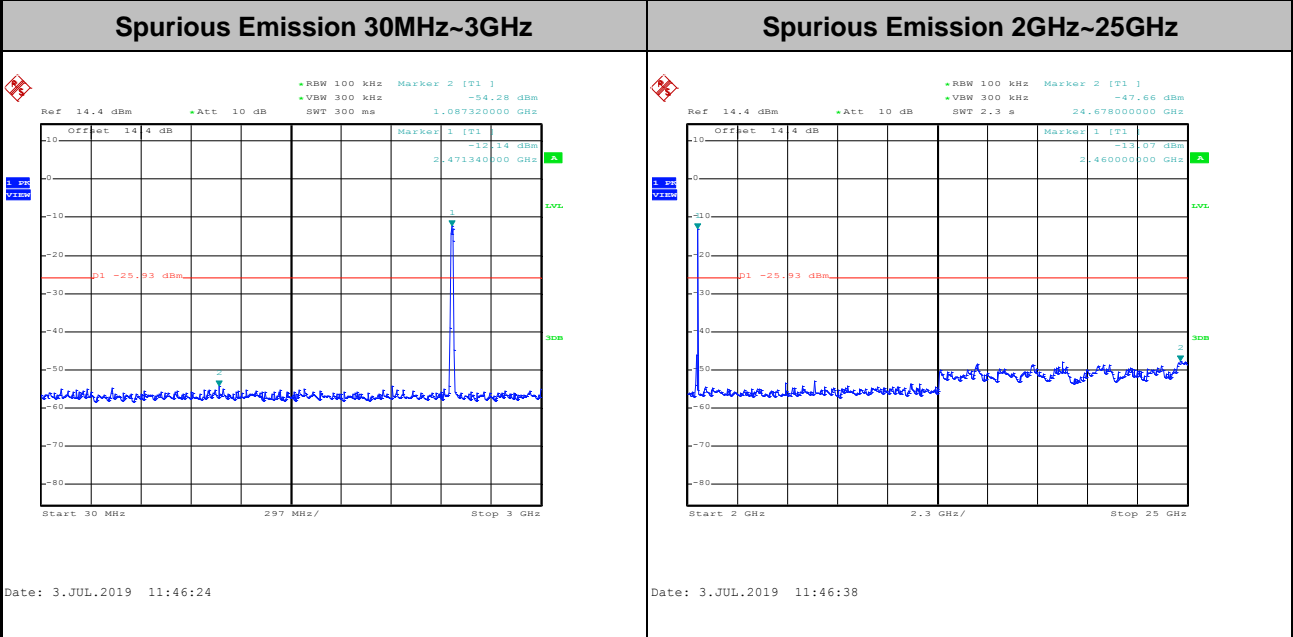
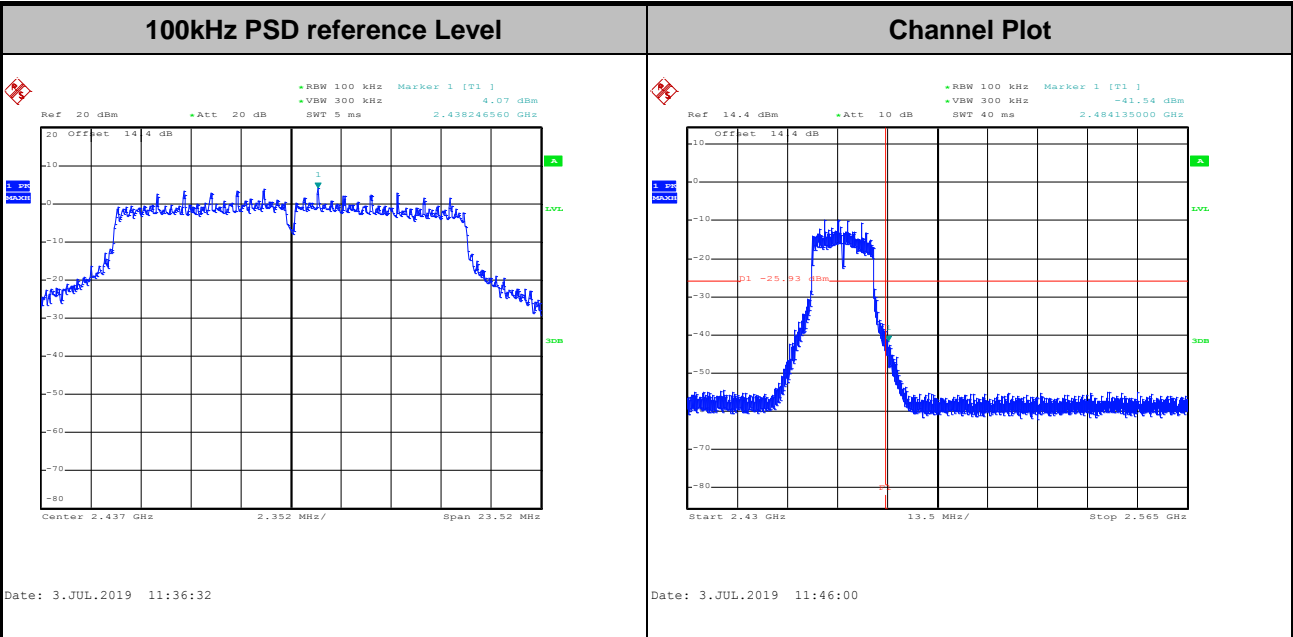



Test Mode :	802.11n HT20	Test Channel :	01
-------------	--------------	----------------	----

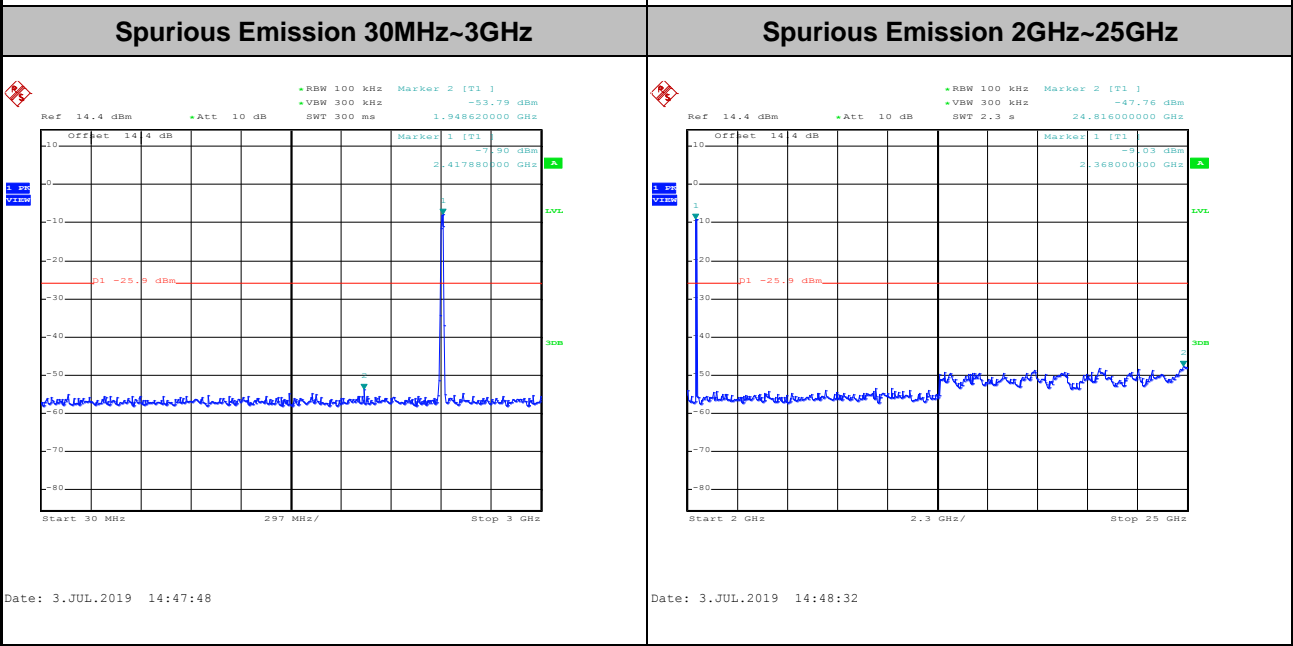
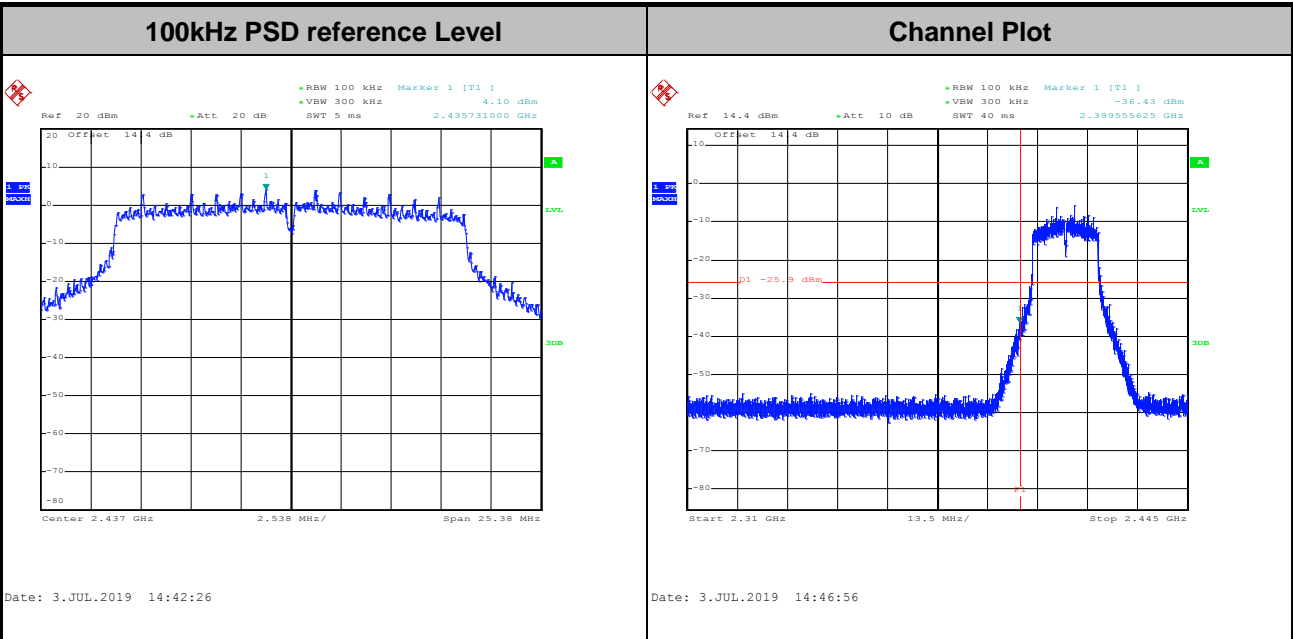



Test Mode :	802.11n HT20	Test Channel :	06
-------------	--------------	----------------	----

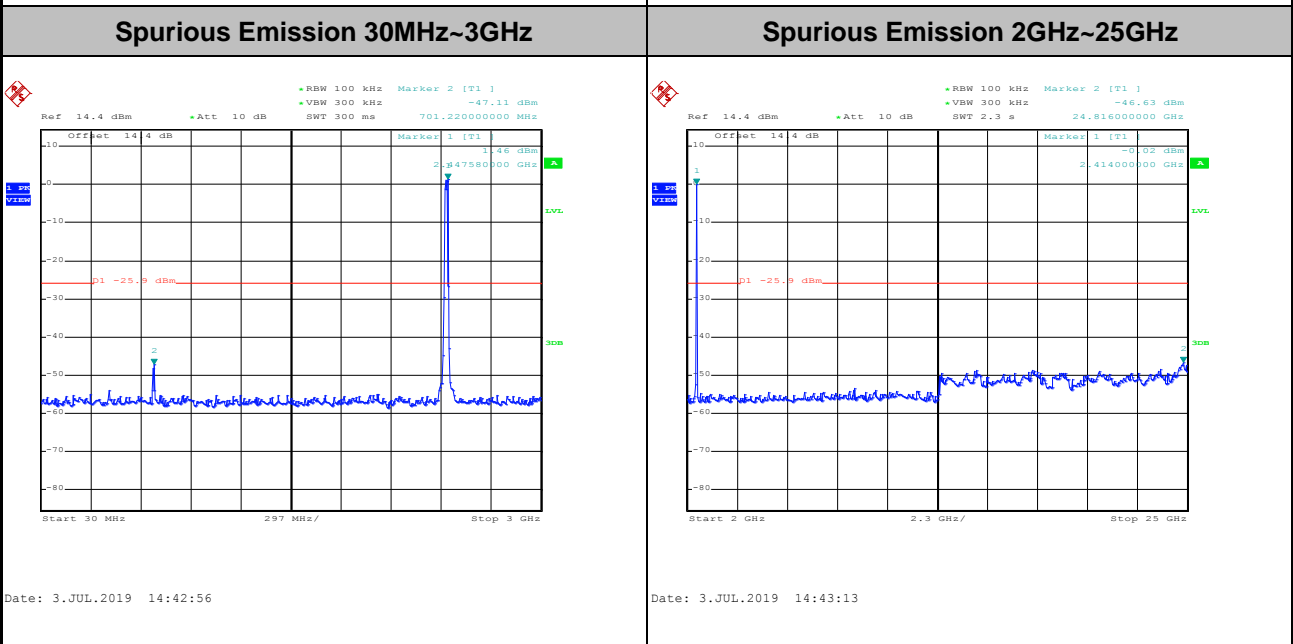
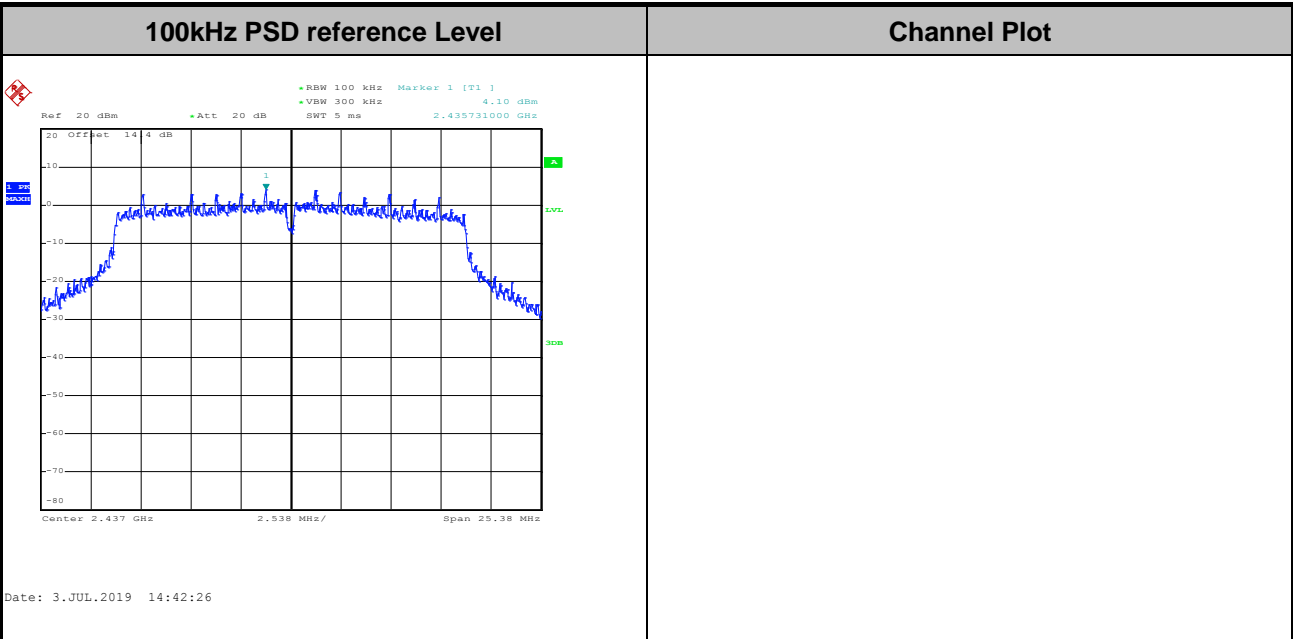



Test Mode :	802.11n HT20	Test Channel :	11
-------------	--------------	----------------	----

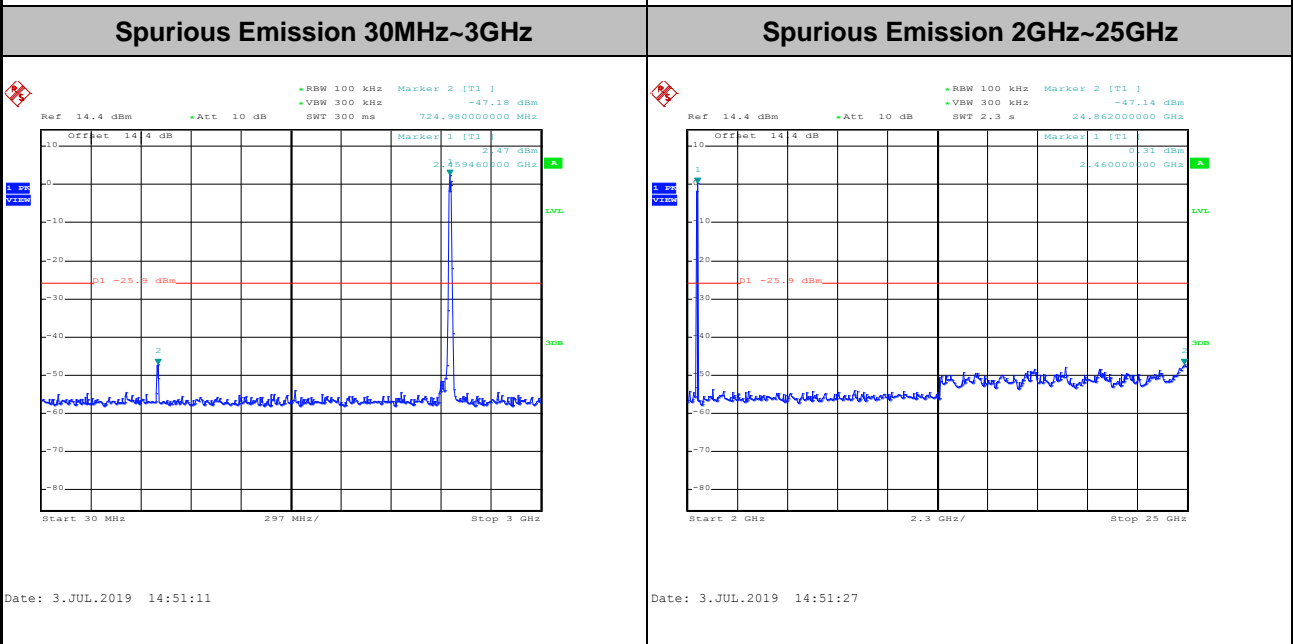
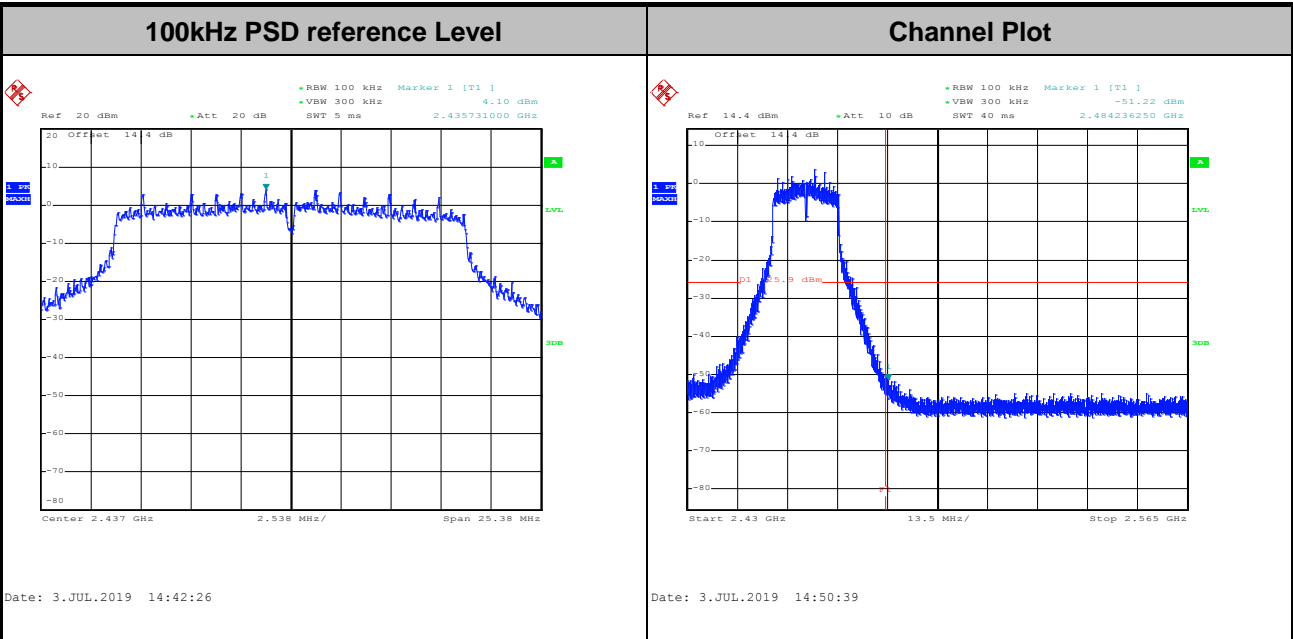



Test Mode :	802.11n HT20	Test Channel :	12
-------------	--------------	----------------	----

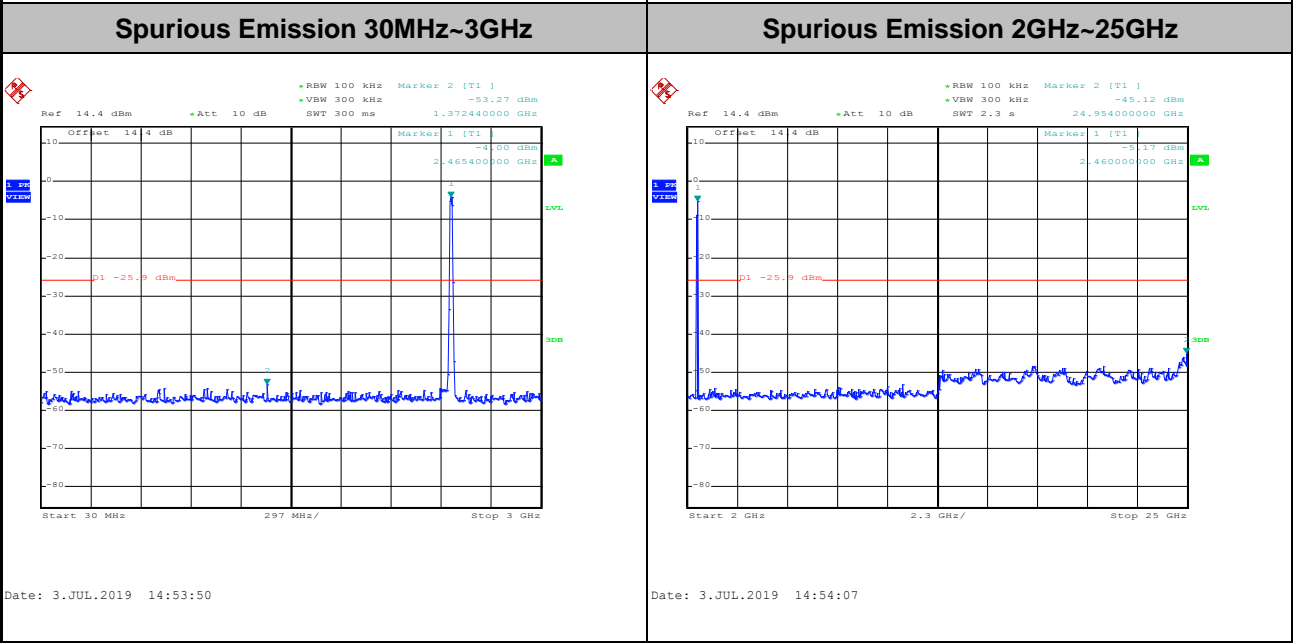
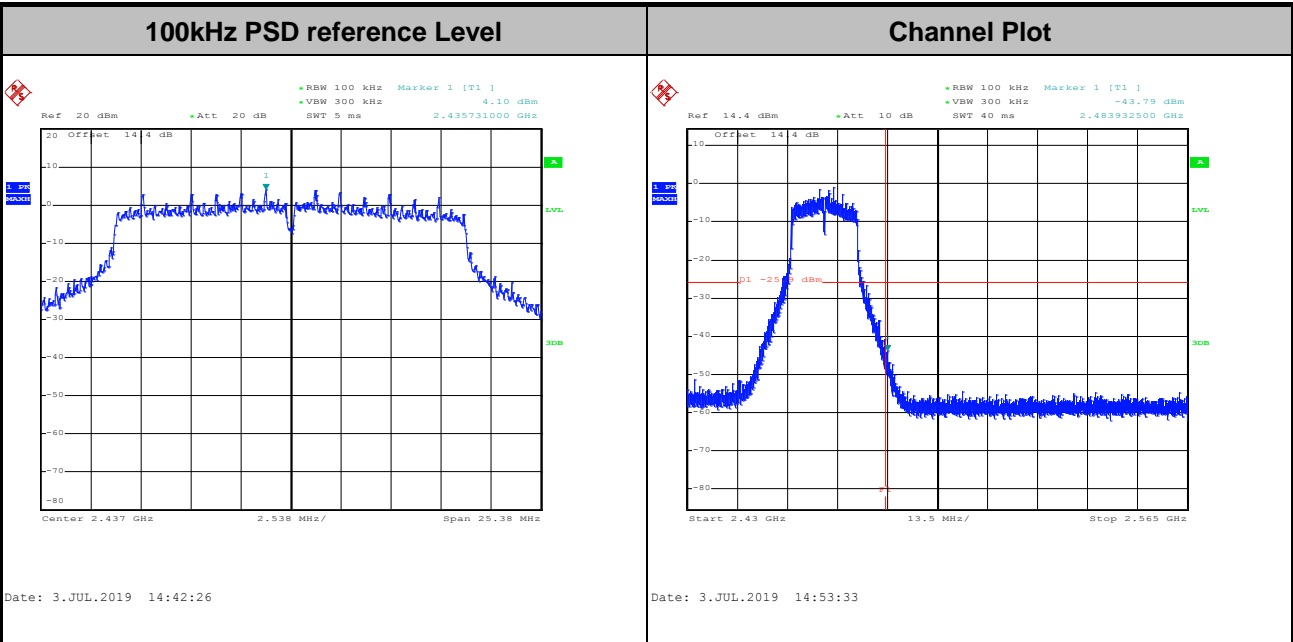



Test Mode :	802.11n HT20	Test Channel :	13
-------------	--------------	----------------	----

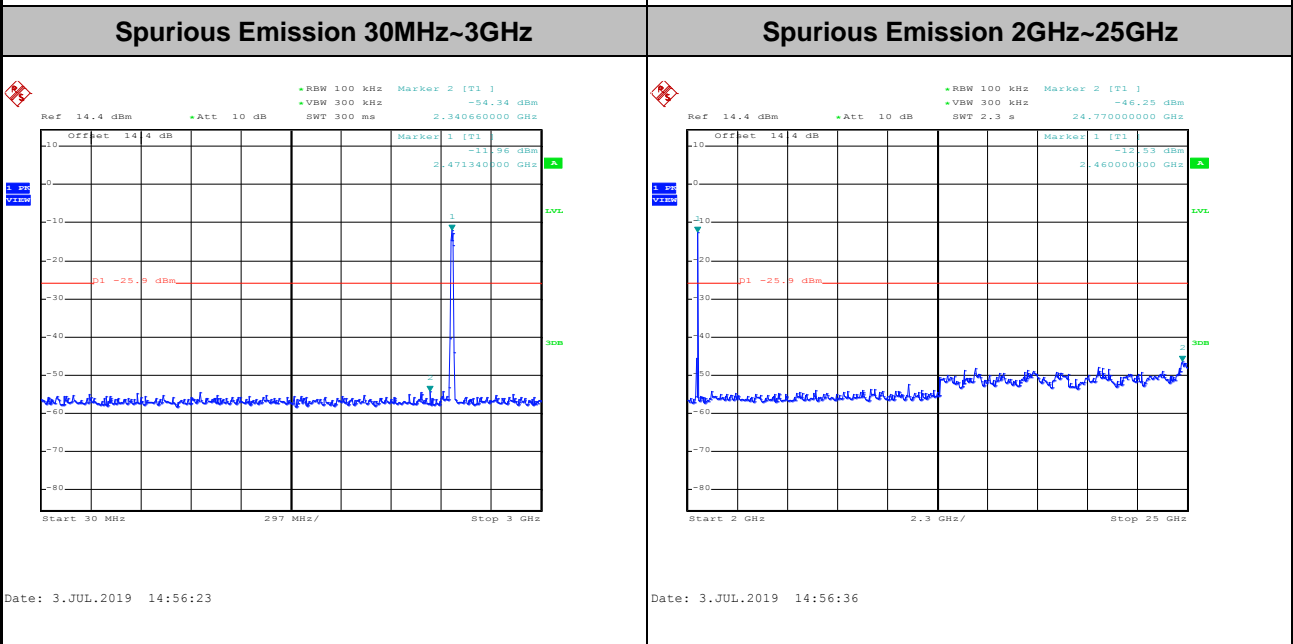
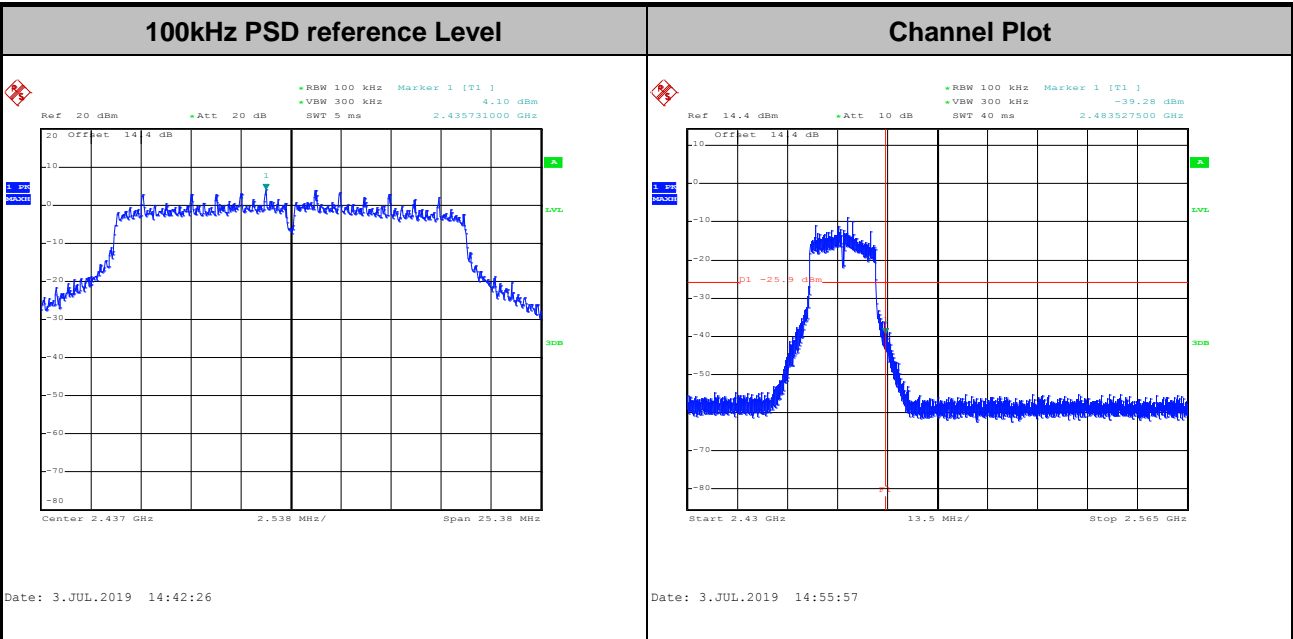



3.5 Radiated Band Edges and Spurious Emission Measurement

3.5.1 Limit of Radiated band edge and Spurious Emission Measurement

In any 100 kHz bandwidth outside the intentional radiator frequency band, all harmonics/spurious must be at least 20 dB below the highest emission level within the authorized band. If the output power of this device was measured by spectrum analyzer, the attenuation under this paragraph shall be 30 dB instead of 20 dB. In addition, radiated emissions which fall in the restricted bands must also comply with the limits as below.

Frequency (MHz)	Field Strength (microvolts/meter)	Measurement Distance (meters)
0.009 – 0.490	2400/F(kHz)	300
0.490 – 1.705	24000/F(kHz)	30
1.705 – 30.0	30	30
30 – 88	100	3
88 – 216	150	3
216 - 960	200	3
Above 960	500	3

3.5.2 Measuring Instruments

See list of measuring equipment of this test report.



3.5.3 Test Procedures

1. The testing follows the ANSI C63.10 Section 11.12.1 Radiated emission measurements.
2. The EUT was arranged to its worst case and then tune the antenna tower (from 1 m to 4 m) and turntable (from 0 degree to 360 degrees) to find the maximum reading. A pre-amp and a high pass filter are used for the test in order to get better signal level.
3. The EUT was placed on a turntable with 0.8 meter for frequency below 1GHz and 1.5 meter for frequency above 1GHz respectively above ground.
4. The EUT was set 3 meters from the interference receiving antenna, which was mounted on the top of a variable height antenna tower.
5. Corrected Reading: Antenna Factor + Cable Loss + Read Level - Preamp Factor = Level
6. For testing below 1GHz, if the emission level of the EUT in peak mode was 3 dB lower than the limit specified, then peak values of EUT will be reported, otherwise, the emissions will be repeated one by one using the CISPR quasi-peak method and reported.
7. For testing above 1GHz, the emission level of the EUT in peak mode was 20dB lower than average limit (that means the emission level in average mode also complies with the limit in average mode), then peak values of EUT will be reported, otherwise, the emissions will be measured in average mode again and reported.
8. Use the following spectrum analyzer settings:
 - (1) Span shall wide enough to fully capture the emission being measured;
 - (2) Set RBW=100 kHz for $f < 1$ GHz; VBW \geq RBW; Sweep = auto; Detector function = peak; Trace = max hold;
 - (3) Set RBW = 1 MHz, VBW= 3MHz for $f \geq 1$ GHz for peak measurement.
For average measurement:
 - VBW = 10 Hz, when duty cycle is no less than 98 percent.
 - VBW $\geq 1/T$, when duty cycle is less than 98 percent where T is the minimum transmission duration over which the transmitter is on and is transmitting at its maximum power control level for the tested mode of operation.

3.5.4 Test Setup

For radiated emissions below 30MHz

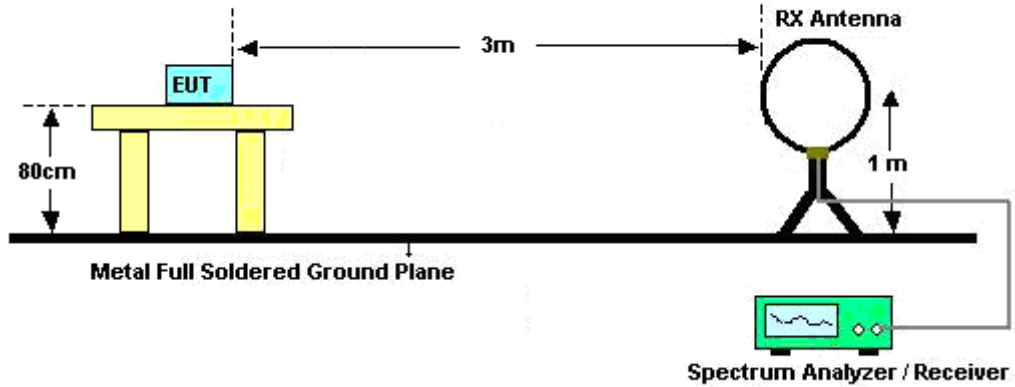

For radiated emissions from 30MHz to 1GHz

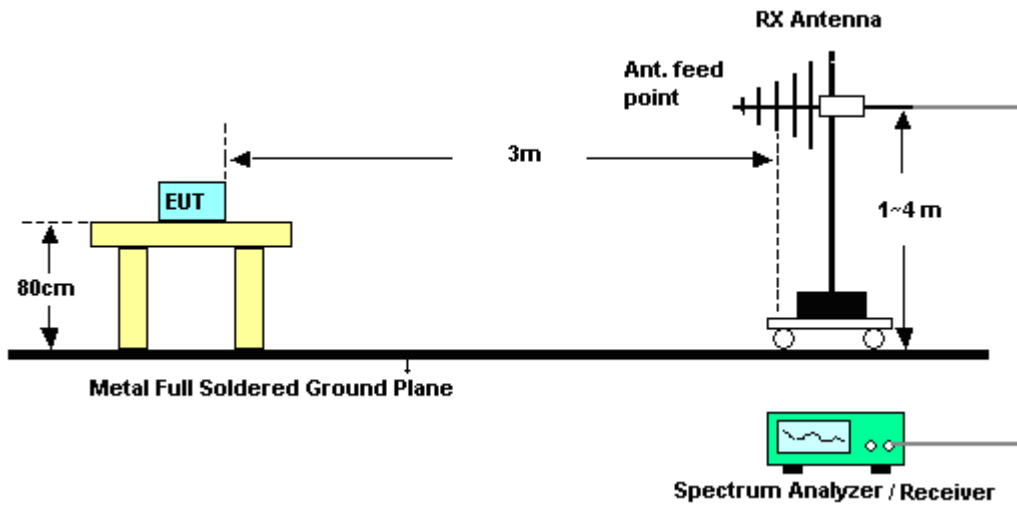

For radiated emissions above 1GHz

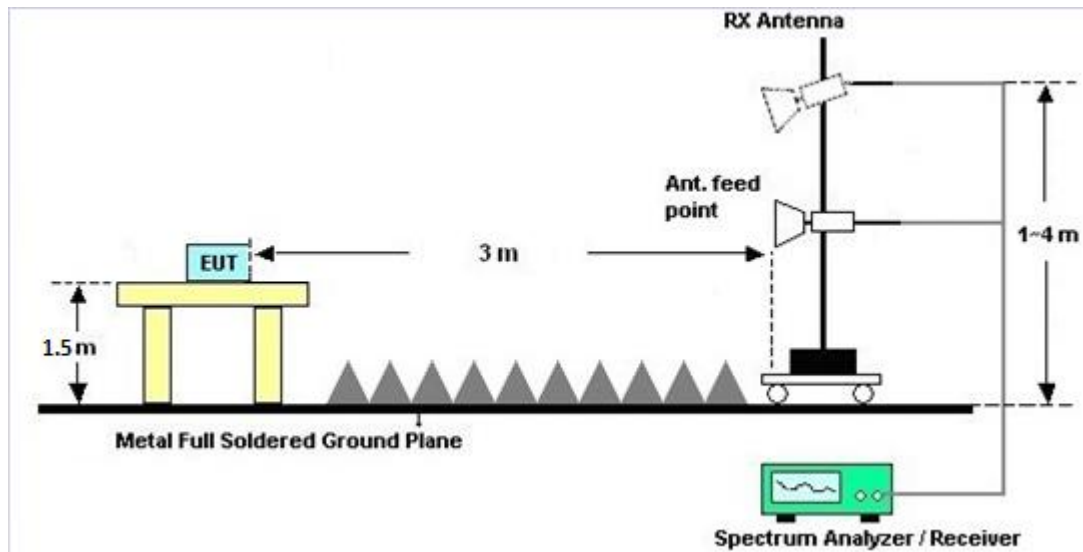

3.5.5 Test Results of Radiated Spurious Emissions (9kHz ~ 30MHz)

The low frequency, which started from 9 kHz to 30MHz, was pre-scanned and the result which was 20dB lower than the limit line was not reported.

There is a comparison data of both open-field test site and alternative test site - semi-Anechoic chamber according to 414788 D01 Radiated Test Site v01r01, and the result came out very similar.

3.5.6 Test Result of Radiated Spurious at Band Edges

Please refer to Appendix C and D.

3.5.7 Duty Cycle

Please refer to Appendix E.

3.5.8 Test Result of Radiated Spurious Emission (30MHz ~ 10th Harmonic)

Please refer to Appendix C and D.

3.6 AC Conducted Emission Measurement

3.6.1 Limit of AC Conducted Emission

For equipment that is designed to be connected to the public utility (AC) power line, the radio frequency voltage that is conducted back onto the AC power line on any frequency or frequencies within the band 150 kHz to 30 MHz shall not exceed the limits in the following table.

Frequency of Emission (MHz)	Conducted Limit (dB μ V)	
	Quasi-Peak	Average
0.15-0.5	66 to 56*	56 to 46*
0.5-5	56	46
5-30	60	50

*Decreases with the logarithm of the frequency.

3.6.2 Measuring Instruments

See list of measuring equipment of this test report.

3.6.3 Test Procedures

1. The EUT was placed 0.4 meter from the conducting wall of the shielding room, and it was kept at least 80 centimeters from any other grounded conducting surface.
2. Connect EUT to the power mains through a line impedance stabilization network (LISN).
3. All the support units are connecting to the other LISN.
4. The LISN provides 50 ohm coupling impedance for the measuring instrument.
5. The FCC states that a 50 ohm, 50 microhenry LISN should be used.
6. Both sides of AC line were checked for maximum conducted interference.
7. The frequency range from 150 kHz to 30 MHz was searched.
8. Set the test-receiver system to Peak Detect Function and specified bandwidth (IF bandwidth = 9kHz) with Maximum Hold Mode.

3.6.4 Test Setup

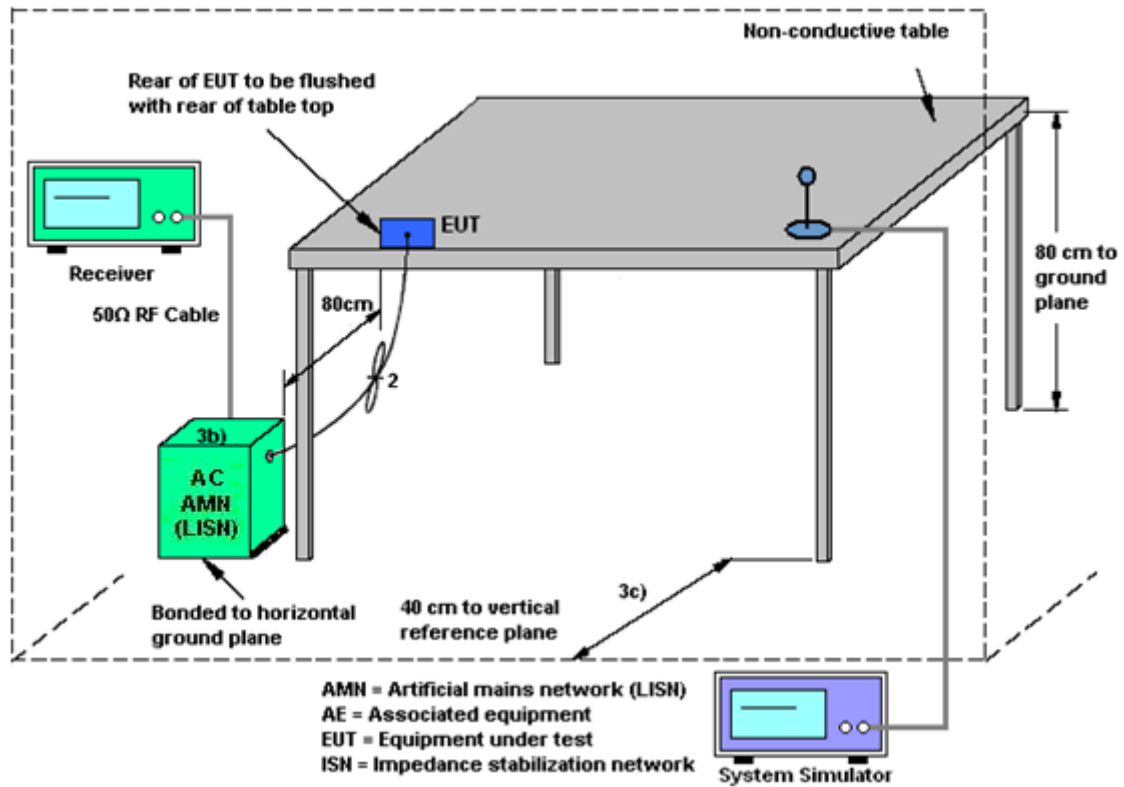

3.6.5 Test Result of AC Conducted Emission

Please refer to Appendix B.



3.7 Antenna Requirements

3.7.1 Standard Applicable

If directional gain of transmitting Antennas is greater than 6dBi, the power shall be reduced by the same level in dB comparing to gain minus 6dBi. The use of a permanently attached Antenna or of an Antenna that uses a unique coupling to the intentional radiator shall be considered sufficient to comply with the rule.

3.7.2 Antenna Anti-Replacement Construction

An embedded-in antenna design is used.

3.7.3 Antenna Gain

<CDD Modes >

FCC KDB 662911 D01 Multiple Transmitter Output v02r01

For CDD transmissions, directional gain is calculated as

Directional gain = G_{ANT} + Array Gain, where Array Gain is as follows.

For power spectral density (PSD) measurements on all devices,

Array Gain = $10 \log(N_{ANT}/N_{SS}=1)$ dB.

For power measurements on IEEE 802.11 devices,

Array Gain = 0 dB (i.e., no array gain) for $N_{ANT} \leq 4$.

Directional gain may be calculated by using the formulas applicable to equal gain antennas with G_{ANT} set equal to the gain of the antenna having the highest gain;

The EUT supports CDD mode.

For power, the directional gain G_{ANT} is set equal to the antenna having the highest gain, i.e., F)2)f)i).

For PSD, the directional gain calculation is following F)2)f)ii) of KDB 662911 D01 v02r01.

The power and PSD limit should be modified if the directional gain of EUT is over 6 dBi,

The directional gain "DG" is calculated as following table.

<CDD Modes>						
			DG	DG	Power	PSD
			for	for	Limit	Limit
	Ant. 1	Ant. 2	Power	PSD	Reduction	Reduction
	(dBi)	(dBi)	(dBi)	(dBi)	(dB)	(dB)
2.4 GHz	-2.10	-6.80	-2.10	-1.13	0.00	0.00

$Power\ Limit\ Reduction = DG(Power) - 6dBi, (min = 0)$

$PSD\ Limit\ Reduction = DG(PSD) - 6dBi, (min = 0)$



4 List of Measuring Equipment

Instrument	Manufacturer	Model No.	Serial No.	Characteristics	Calibration Date	Test Date	Due Date	Remark
Hygrometer	Testo	DTM-303A	TP157075	N/A	Nov. 05, 2018	Jun. 17, 2019~ Jul. 03, 2019	Nov. 04, 2019	Conducted (TH05-HY)
Power Sensor	DARE	RPR3006W	13I00030SN O32	9kHz~6GHz	Dec. 03, 2018	Jun. 17, 2019~ Jul. 03, 2019	Dec. 02, 2019	Conducted (TH05-HY)
Spectrum Analyzer	Rohde & Schwarz	FSV40	101397	10Hz~40GHz	Nov. 13, 2018	Jun. 17, 2019~ Jul. 03, 2019	Nov. 12, 2019	Conducted (TH05-HY)
Switch Box & RF Cable	EM	EMSW18	SW1070903	N/A	Dec. 19, 2018	Jun. 17, 2019~ Jul. 03, 2019	Dec. 18, 2019	Conducted (TH05-HY)
AC Power Source	ChainTek	APC-1000W	N/A	N/A	N/A	Jun. 30, 2019	N/A	Conduction (CO05-HY)
EMI Test Receiver	Rohde & Schwarz	ESR3	102388	9kHz~3.6GHz	Nov. 12, 2018	Jun. 30, 2019	Nov. 11, 2019	Conduction (CO05-HY)
Hygrometer	Testo	608-H1	34913912	N/A	Mar. 19, 2019	Jun. 30, 2019	Mar. 18, 2020	Conduction (CO05-HY)
LISN	Rohde & Schwarz	ENV216	100080	9kHz~30MHz	Nov. 14, 2018	Jun. 30, 2019	Nov. 13, 2019	Conduction (CO05-HY)
LISN	Rohde & Schwarz	ENV216	100081	9kHz~30MHz	Nov. 09, 2018	Jun. 30, 2019	Nov. 08, 2019	Conduction (CO05-HY)
Software	Rohde & Schwarz	EMC32 V10.30	N/A	N/A	N/A	Jun. 30, 2019	N/A	Conduction (CO05-HY)
LF Cable	HUBER + SUHNER	RG-214/U	LF01	N/A	Dec. 31, 2018	Jun. 30, 2019	Dec. 30, 2019	Conduction (CO05-HY)
Pulse Limiter	Rohde & Schwarz	ESH3-Z2	100851	N/A	Dec. 31, 2018	Jun. 30, 2019	Dec. 30, 2019	Conduction (CO05-HY)
Loop Antenna	Rohde & Schwarz	HFH2-Z2	100315	9 kHz~30 MHz	Jan. 11, 2019	Jul. 03, 2019~ Jul. 08, 2019	Jan. 10, 2020	Radiation (03CH16-HY)
Bilog Antenna	TESEQ	CBL6111D& 00802N1D0 1N-06	47020&06	30MHz to 1GHz	Oct. 13, 2018	Jul. 03, 2019~ Jul. 08, 2019	Oct. 12, 2019	Radiation (03CH16-HY)
Horn Antenna	SCHWARZBE CK	BBHA 9120 D	9120D-1522	1G~18GHz	Sep. 07, 2018	Jul. 03, 2019~ Jul. 08, 2019	Sep. 06, 2019	Radiation (03CH16-HY)
SHF-EHF Horn Antenna	SCHWARZBE CK	BBHA 9170	BBHA91702 51	18GHz ~ 40GHz	Nov. 20, 2018	Jul. 03, 2019~ Jul. 08, 2019	Nov. 19, 2019	Radiation (03CH16-HY)
Amplifier	SONOMA	310N	371607	9kHz~1000MHz	Oct. 02, 2018	Jul. 03, 2019~ Jul. 08, 2019	Oct. 01, 2019	Radiation (03CH16-HY)
Preamplifier	Jet-Power	JPA0118-55- 303	1710001800 055007	1GHz~18GHz	Apr. 01, 2019	Jul. 03, 2019~ Jul. 08, 2019	Mar. 31, 2020	Radiation (03CH16-HY)
Preamplifier	Keysight	83017A	MY5327026 4	1GHz~26.5GHz	Dec. 12, 2018	Jul. 03, 2019~ Jul. 08, 2019	Dec. 11, 2019	Radiation (03CH16-HY)
Amplifier	MITEQ	TTA1840-35- HG	1871923	18GHz~40GHz, VSWR : 2.5:1 max	Jul. 16, 2018	Jul. 03, 2019~ Jul. 08, 2019	Jul. 15, 2019	Radiation (03CH16-HY)
EMI Test Receiver	Keysight	N9038A (MXE)	MY57290111	3Hz~26.5GHz	Nov. 29, 2018	Jul. 03, 2019~ Jul. 08, 2019	Nov. 28, 2019	Radiation (03CH16-HY)
Spectrum Analyzer	Agilent	N9010A	MY5420048 6	10Hz~44GHz	Oct. 19, 2018	Jul. 03, 2019~ Jul. 08, 2019	Oct. 18, 2019	Radiation (03CH16-HY)



Instrument	Manufacturer	Model No.	Serial No.	Characteristics	Calibration Date	Test Date	Due Date	Remark
Hygrometer	TECEPEL	DTM-303B	TP162965	N/A	Oct. 22, 2018	Jul. 03, 2019~ Jul. 08, 2019	Oct. 21, 2019	Radiation (03CH16-HY)
Filter	Wainwright	WLK4-1000- 1530-8000-4 0SS	SN11	1G Low Pass	Sep. 16, 2018	Jul. 03, 2019~ Jul. 08, 2019	Sep. 17, 2019	Radiation (03CH16-HY)
Filter	Wainwright	WHKX12-27 00-3000-180 00-60SS	SN3	2.7G High Pass	Sep. 16, 2018	Jul. 03, 2019~ Jul. 08, 2019	Sep. 17, 2019	Radiation (03CH16-HY)
RF Cable	HUBER + SUHNER	SUCOFLEX 126E	MY1082/26 EA	30M-18G	Oct. 15, 2018	Jul. 03, 2019~ Jul. 08, 2019	Oct. 14, 2019	Radiation (03CH16-HY)
RF Cable	HUBER + SUHNER	SUCOFLEX 104	MY15539/4	30M-18G	Feb. 26, 2019	Jul. 03, 2019~ Jul. 08, 2019	Feb. 25, 2020	Radiation (03CH16-HY)
RF Cable	HUBER + SUHNER	SUCOFLEX 104	MY36980/4	30M~18GHz	Apr. 15, 2019	Jul. 03, 2019~ Jul. 08, 2019	Apr. 14, 2020	Radiation (03CH16-HY)
Controller	ChainTek	3000-1	N/A	Control Turn table & Ant Mast	N/A	Jul. 03, 2019~ Jul. 08, 2019	N/A	Radiation (03CH16-HY)
Antenna Mast	ChainTek	MBS-520-1	N/A	1m~4m	N/A	Jul. 03, 2019~ Jul. 08, 2019	N/A	Radiation (03CH16-HY)
Turn Table	ChainTek	T-200-S-1	N/A	0~360 Degree	N/A	Jul. 03, 2019~ Jul. 08, 2019	N/A	Radiation (03CH16-HY)
Software	Audix	E3 6.2009-8-24	RK-001136	N/A	N/A	Jul. 03, 2019~ Jul. 08, 2019	N/A	Radiation (03CH16-HY)



5 Uncertainty of Evaluation

Uncertainty of Conducted Emission Measurement (150kHz ~ 30MHz)

Measuring Uncertainty for a Level of Confidence of 95% ($U = 2Uc(y)$)	2.20
---	------

Uncertainty of Radiated Emission Measurement (30 MHz ~ 1000 MHz)

Measuring Uncertainty for a Level of Confidence of 95% ($U = 2Uc(y)$)	4.90
---	------

Uncertainty of Radiated Emission Measurement (1000 MHz ~ 18000 MHz)

Measuring Uncertainty for a Level of Confidence of 95% ($U = 2Uc(y)$)	5.80
---	------

Uncertainty of Radiated Emission Measurement (18000 MHz ~ 40000 MHz)

Measuring Uncertainty for a Level of Confidence of 95% ($U = 2Uc(y)$)	3.90
---	------

Appendix A. Test Result of Conducted Test Items

Test Engineer:	Howard Lin	Temperature:	21~25	°C
Test Date:	2019/6/17~2019/7/3	Relative Humidity:	51~54	%

TEST RESULTS DATA
6dB and 99% Occupied Bandwidth

2.4GHz Band										
Mod.	Data Rate	NTX	CH.	Freq. (MHz)	99% Occupied BW (MHz)		6dB BW (MHz)		6dB BW Limit (MHz)	Pass/Fail
					Ant 1	Ant 2	Ant 1	Ant 2		
11b	1Mbps	2	1	2412	13.55	13.55	8.52	8.04	0.50	Pass
11b	1Mbps	2	6	2437	13.90	13.85	8.04	8.52	0.50	Pass
11b	1Mbps	2	11	2462	13.90	13.90	8.56	8.04	0.50	Pass
11b	1Mbps	2	12	2467	13.95	13.85	9.04	8.04	0.50	Pass
11b	1Mbps	2	13	2472	13.55	13.70	8.00	8.52	0.50	Pass
11g	6Mbps	2	1	2412	16.60	16.70	15.12	15.32	0.50	Pass
11g	6Mbps	2	6	2437	16.85	16.80	15.52	15.68	0.50	Pass
11g	6Mbps	2	11	2462	16.80	16.65	15.72	15.08	0.50	Pass
11g	6Mbps	2	12	2467	16.70	16.70	15.76	15.68	0.50	Pass
11g	6Mbps	2	13	2472	16.60	16.70	15.28	15.68	0.50	Pass
HT20	MCS0	2	1	2412	17.75	17.80	15.04	16.50	0.50	Pass
HT20	MCS0	2	6	2437	18.00	17.90	15.90	16.92	0.50	Pass
HT20	MCS0	2	11	2462	18.00	17.85	15.64	17.16	0.50	Pass
HT20	MCS0	2	12	2467	17.95	17.85	15.04	16.54	0.50	Pass
HT20	MCS0	2	13	2472	17.85	17.80	15.12	16.32	0.50	Pass

TEST RESULTS DATA
Average Output Power

2.4GHz Band																
Mod.	Data Rate	N _{TX}	CH.	Freq. (MHz)	Average Conducted Power (dBm)			Conducted Power Limit (dBm)		DG (dBi)		EIRP Power (dBm)		EIRP Power Limit (dBm)		Pass /Fail
					Ant 1	Ant 2	SUM	Ant 1	Ant 2	Ant 1	Ant 2	Ant 1	Ant 2	Ant 1	Ant 2	
11b	1Mbps	1	1	2412	12.50	13.30		30.00	30.00	-2.10	-6.80	10.40	6.50	36.00	36.00	Pass
11b	1Mbps	1	6	2437	12.50	13.30		30.00	30.00	-2.10	-6.80	10.40	6.50	36.00	36.00	Pass
11b	1Mbps	1	11	2462	12.50	13.10		30.00	30.00	-2.10	-6.80	10.40	6.30	36.00	36.00	Pass
11b	1Mbps	1	12	2467	12.40	13.30		30.00	30.00	-2.10	-6.80	10.30	6.50	36.00	36.00	Pass
11b	1Mbps	1	13	2472	10.70	10.90		30.00	30.00	-2.10	-6.80	8.60	4.10	36.00	36.00	Pass
11g	6Mbps	1	1	2412	8.80	8.80		30.00	30.00	-2.10	-6.80	6.70	2.00	36.00	36.00	Pass
11g	6Mbps	1	6	2437	12.50	13.30		30.00	30.00	-2.10	-6.80	10.40	6.50	36.00	36.00	Pass
11g	6Mbps	1	11	2462	12.30	13.30	-	30.00	30.00	-2.10	-6.80	10.20	6.50	36.00	36.00	Pass
11g	6Mbps	1	12	2467	11.30	11.30		30.00	30.00	-2.10	-6.80	9.20	4.50	36.00	36.00	Pass
11g	6Mbps	1	13	2472	0.30	0.10		30.00	30.00	-2.10	-6.80	-1.80	-6.70	36.00	36.00	Pass
HT20	MCS0	1	1	2412	3.40	3.20		30.00	30.00	-2.10	-6.80	1.30	-3.60	36.00	36.00	Pass
HT20	MCS0	1	6	2437	12.40	13.30		30.00	30.00	-2.10	-6.80	10.30	6.50	36.00	36.00	Pass
HT20	MCS0	1	11	2462	12.50	13.30		30.00	30.00	-2.10	-6.80	10.40	6.50	36.00	36.00	Pass
HT20	MCS0	1	12	2467	9.30	9.30		30.00	30.00	-2.10	-6.80	7.20	2.50	36.00	36.00	Pass
HT20	MCS0	1	13	2472	0.20	0.30		30.00	30.00	-2.10	-6.80	-1.90	-6.50	36.00	36.00	Pass
11b	1Mbps	2	1	2412	12.60	13.40	16.03	30.00		-2.10		13.93		36.00		Pass
11b	1Mbps	2	6	2437	12.60	13.40	16.03	30.00		-2.10		13.93		36.00		Pass
11b	1Mbps	2	11	2462	12.60	13.40	16.03	30.00		-2.10		13.93		36.00		Pass
11b	1Mbps	2	12	2467	12.50	13.40	15.98	30.00		-2.10		13.88		36.00		Pass
11b	1Mbps	2	13	2472	10.80	11.00	13.91	30.00		-2.10		11.81		36.00		Pass
11g	6Mbps	2	1	2412	8.90	8.90	11.91	30.00		-2.10		9.81		36.00		Pass
11g	6Mbps	2	6	2437	12.60	13.40	16.03	30.00		-2.10		13.93		36.00		Pass
11g	6Mbps	2	11	2462	12.40	13.40	15.94	30.00		-2.10		13.84		36.00		Pass
11g	6Mbps	2	12	2467	11.40	11.40	14.41	30.00		-2.10		12.31		36.00		Pass
11g	6Mbps	2	13	2472	0.40	0.20	3.31	30.00		-2.10		1.21		36.00		Pass
HT20	MCS0	2	1	2412	3.50	3.30	6.41	30.00		-2.10		4.31		36.00		Pass
HT20	MCS0	2	6	2437	12.50	13.40	15.98	30.00		-2.10		13.88		36.00		Pass
HT20	MCS0	2	11	2462	12.60	13.40	16.03	30.00		-2.10		13.93		36.00		Pass
HT20	MCS0	2	12	2467	9.40	9.40	12.41	30.00		-2.10		10.31		36.00		Pass
HT20	MCS0	2	13	2472	0.30	0.40	3.36	30.00		-2.10		1.26		36.00		Pass

Note: Measured power (dBm) has offset with cable loss.

TEST RESULTS DATA
Peak Power Spectral Density

2.4GHz Band												
Mod.	Data Rate	NTX	CH.	Freq. (MHz)	Peak PSD (dBm/3kHz)			DG (dBi)		Peak PSD Limit (dBm/3kHz)		Pass/Fail
					Ant 1	Ant 2	Worse + 3.01	Ant 1	Ant 2	Ant 1	Ant 2	
11b	1Mbps	2	1	2412	-7.73	-7.96	-4.72	-1.13		8.00		Pass
11b	1Mbps	2	6	2437	-6.64	-8.32	-3.63	-1.13		8.00		Pass
11b	1Mbps	2	11	2462	-7.71	-8.95	-4.70	-1.13		8.00		Pass
11b	1Mbps	2	12	2467	-6.52	-9.51	-3.51	-1.13		8.00		Pass
11b	1Mbps	2	13	2472	-8.28	-9.89	-5.27	-1.13		8.00		Pass
11g	6Mbps	2	1	2412	-14.24	-15.23	-11.23	-1.13		8.00		Pass
11g	6Mbps	2	6	2437	-9.76	-10.32	-6.75	-1.13		8.00		Pass
11g	6Mbps	2	11	2462	-11.08	-9.94	-6.93	-1.13		8.00		Pass
11g	6Mbps	2	12	2467	-11.77	-13.29	-8.76	-1.13		8.00		Pass
11g	6Mbps	2	13	2472	-23.72	-24.56	-20.71	-1.13		8.00		Pass
HT20	MCS0	2	1	2412	-19.76	-19.29	-16.28	-1.13		8.00		Pass
HT20	MCS0	2	6	2437	-10.39	-10.92	-7.38	-1.13		8.00		Pass
HT20	MCS0	2	11	2462	-11.32	-11.82	-8.31	-1.13		8.00		Pass
HT20	MCS0	2	12	2467	-14.85	-16.62	-11.84	-1.13		8.00		Pass
HT20	MCS0	2	13	2472	-23.09	-24.67	-20.08	-1.13		8.00		Pass

Measured power density (dBm) has offset with cable loss.



Appendix B. AC Conducted Emission Test Results

Test Engineer :	Jimmy Chang	Temperature :	24~26°C
		Relative Humidity :	52~54%

EUT Information

Report NO : 940905-02
 Test Mode : Mode 1
 Test Voltage : 120Vac/60Hz
 Phase : Line

Full Spectrum

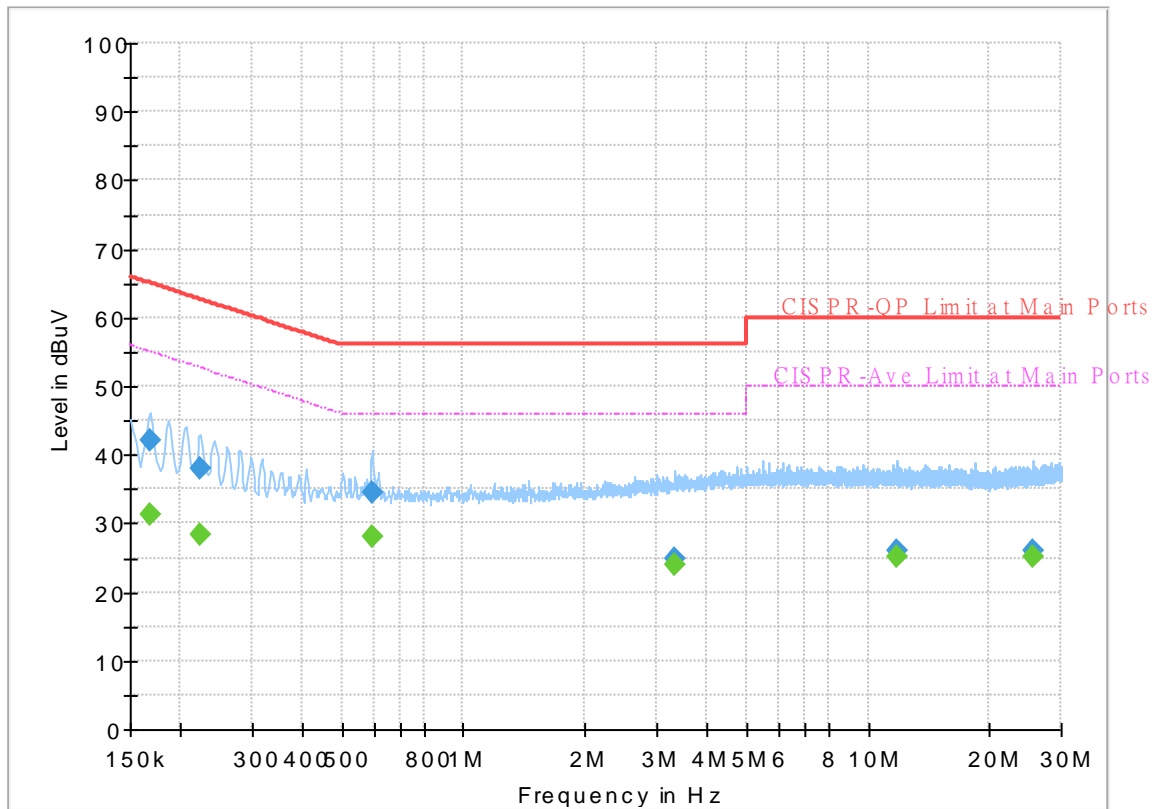

Final_Result

Frequency (MHz)	QuasiPeak (dBuV)	CAverage (dBuV)	Limit (dBuV)	Margin (dB)	Line	Filter	Corr. (dB)
0.168000	---	31.20	55.06	23.86	L1	OFF	19.5
0.168000	42.20	---	65.06	22.86	L1	OFF	19.5
0.224250	---	28.22	52.66	24.44	L1	OFF	19.5
0.224250	37.94	---	62.66	24.72	L1	OFF	19.5
0.595500	---	27.95	46.00	18.05	L1	OFF	19.5
0.595500	34.46	---	56.00	21.54	L1	OFF	19.5
3.318000	---	23.85	46.00	22.15	L1	OFF	19.7
3.318000	24.73	---	56.00	31.27	L1	OFF	19.7
11.735250	---	25.08	50.00	24.92	L1	OFF	20.0
11.735250	26.12	---	60.00	33.88	L1	OFF	20.0
25.521000	---	25.04	50.00	24.96	L1	OFF	20.4
25.521000	25.90	---	60.00	34.10	L1	OFF	20.4

EUT Information

Report NO : 940905-02
 Test Mode : Mode 1
 Test Voltage : 120Vac/60Hz
 Phase : Neutral

Full Spectrum

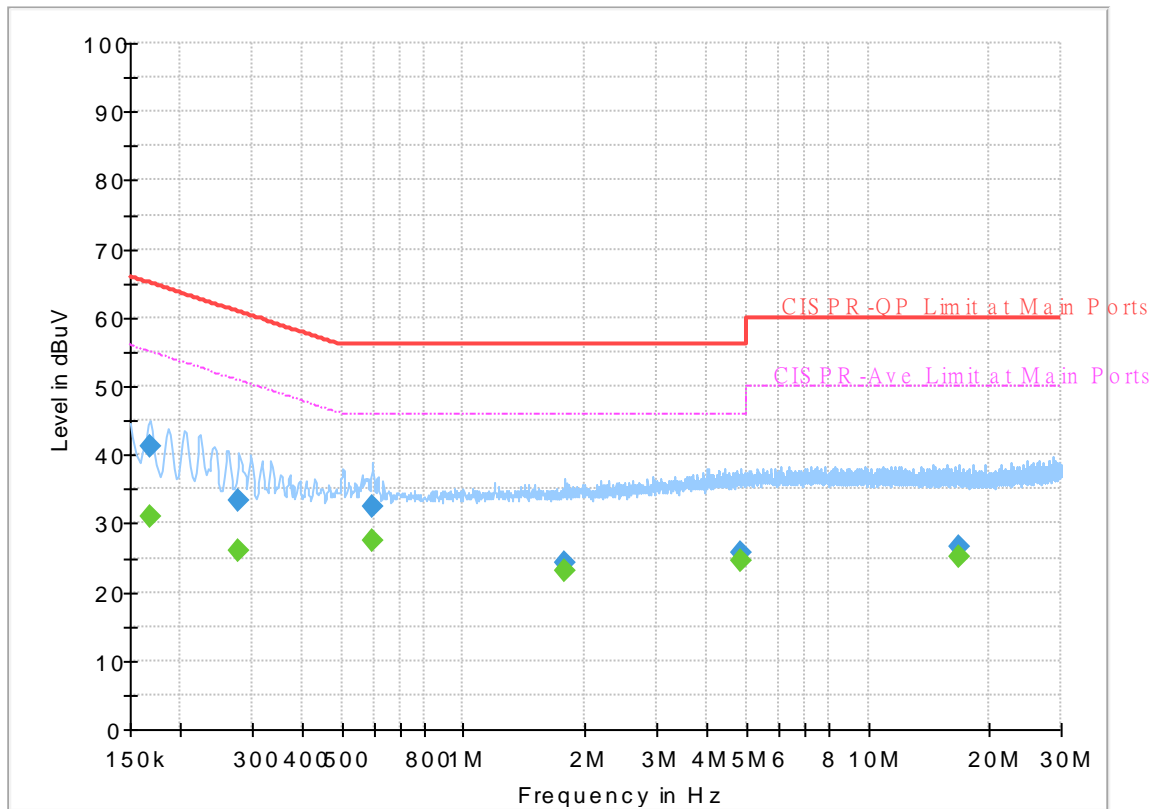

Final_Result

Frequency (MHz)	QuasiPeak (dBuV)	CAverage (dBuV)	Limit (dBuV)	Margin (dB)	Line	Filter	Corr. (dB)
0.168000	---	31.03	55.06	24.03	N	OFF	19.5
0.168000	41.34	---	65.06	23.72	N	OFF	19.5
0.278250	---	26.08	50.87	24.79	N	OFF	19.5
0.278250	33.43	---	60.87	27.44	N	OFF	19.5
0.595500	---	27.34	46.00	18.66	N	OFF	19.5
0.595500	32.52	---	56.00	23.48	N	OFF	19.5
1.785750	---	23.06	46.00	22.94	N	OFF	19.6
1.785750	24.15	---	56.00	31.85	N	OFF	19.6
4.827750	---	24.63	46.00	21.37	N	OFF	19.7
4.827750	25.68	---	56.00	30.32	N	OFF	19.7
16.777500	---	25.09	50.00	24.91	N	OFF	20.2
16.777500	26.58	---	60.00	33.42	N	OFF	20.2



Appendix C. Radiated Spurious Emission

Test Engineer :	Jacky Hung, Austin LI, CR Liro, and Peter Liao	Temperature :	20~25°C
		Relative Humidity :	50~60%

2.4GHz 2400~2483.5MHz

WIFI 802.11b (Band Edge @ 3m)

WIFI Ant.	Note	Frequency (MHz)	Level (dBμV/m)	Over Limit (dB)	Limit Line (dBμV/m)	Read Level (dBμV)	Antenna Factor (dB/m)	Path Loss (dB)	Preamp Factor (dB)	Ant Pos (cm)	Table Pos (deg)	Peak Avg. (P/A)	Pol. (H/V)	
802.11b CH 01 2412MHz		2338.56	55.56	-18.44	74	40.34	27.28	18.24	30.3	147	32	P	H	
		2389.065	43.6	-10.4	54	28.16	27.41	18.31	30.28	147	32	A	H	
	*	2412	104.25	-	-	88.72	27.47	18.34	30.28	147	32	P	H	
	*	2412	101.15	-	-	85.62	27.47	18.34	30.28	147	32	A	H	
													H	
			2351.79	56.27	-17.73	74	40.99	27.31	18.26	30.29	362	127	P	V
			2389.38	43.63	-10.37	54	28.19	27.41	18.31	30.28	362	127	A	V
	*		2412	101.06	-	-	85.53	27.47	18.34	30.28	362	127	P	V
	*		2412	97.81	-	-	82.28	27.47	18.34	30.28	362	127	A	V
														V
802.11b CH 06 2437MHz		2349.34	56.78	-17.22	74	41.51	27.31	18.26	30.3	113	36	P	H	
		2389.94	43.6	-10.4	54	28.15	27.41	18.32	30.28	113	36	A	H	
	*	2437	104.16	-	-	88.54	27.54	18.35	30.27	113	36	P	H	
	*	2437	101.15	-	-	85.53	27.54	18.35	30.27	113	36	A	H	
			2488.52	56.56	-17.44	74	40.76	27.67	18.38	30.25	113	36	P	H
			2487.33	44.16	-9.84	54	28.36	27.67	18.38	30.25	113	36	A	H
			2380	55.51	-18.49	74	40.11	27.39	18.3	30.29	395	94	P	V
			2389.1	43.56	-10.44	54	28.12	27.41	18.31	30.28	395	94	A	V
	*		2437	100.19	-	-	84.57	27.54	18.35	30.27	395	94	P	V
	*		2437	96.88	-	-	81.26	27.54	18.35	30.27	395	94	A	V
			2488.52	55.39	-18.61	74	39.59	27.67	18.38	30.25	395	94	P	V
			2492.86	44.16	-9.84	54	28.34	27.68	18.39	30.25	395	94	A	V



802.11b CH 11 2462MHz	*	2462	104.61	-	-	88.9	27.6	18.37	30.26	110	47	P	H
	*	2462	101.31	-	-	85.6	27.6	18.37	30.26	110	47	A	H
		2488.92	56.65	-17.35	74	40.85	27.67	18.38	30.25	110	47	P	H
		2488.68	44.18	-9.82	54	28.38	27.67	18.38	30.25	110	47	A	H
													H
													H
	*	2462	100.72	-	-	85.01	27.6	18.37	30.26	390	126	P	V
	*	2462	97.47	-	-	81.76	27.6	18.37	30.26	390	126	A	V
		2499.2	57.44	-16.56	74	41.6	27.7	18.39	30.25	390	126	P	V
		2487.16	44.03	-9.97	54	28.23	27.67	18.38	30.25	390	126	A	V
													V
													V
Remark	1. No other spurious found. 2. All results are PASS against Peak and Average limit line.												



WIFI	Note	Frequency	Level	Over	Limit	Read	Antenna	Path	Preamp	Ant	Table	Peak	Pol.
Ant. 1+2		(MHz)	(dBμV/m)	(dB)	Line (dBμV/m)	Level (dBμV)	Factor (dB/m)	Loss (dB)	Factor (dB)	Pos (cm)	Pos (deg)	Avg. (P/A)	(H/V)
802.11b CH 12 2467MHz	*	2467	103.27	-	-	87.55	27.61	18.37	30.26	106	0	P	H
	*	2467	100.2	-	-	84.48	27.61	18.37	30.26	106	0	A	H
		2492.76	56.07	-17.93	74	40.25	27.68	18.39	30.25	106	0	P	H
		2484.76	44.76	-9.24	54	28.97	27.66	18.38	30.25	106	0	A	H
													H
													H
	*	2467	99.82	-	-	84.1	27.61	18.37	30.26	389	124	P	V
	*	2467	96.44	-	-	80.72	27.61	18.37	30.26	389	124	A	V
		2496.36	56.48	-17.52	74	40.65	27.69	18.39	30.25	389	124	P	V
		2484.28	44.4	-9.6	54	28.61	27.66	18.38	30.25	389	124	A	V
													V
													V
802.11b CH 13 2472MHz	*	2472	102.09	-	-	86.35	27.63	18.37	30.26	109	0	P	H
	*	2472	99.08	-	-	83.34	27.63	18.37	30.26	109	0	A	H
		2483.52	57.07	-16.93	74	41.28	27.66	18.38	30.25	109	0	P	H
		2483.52	45.36	-8.64	54	29.57	27.66	18.38	30.25	109	0	A	H
													H
													H
	*	2472	98.78	-	-	83.04	27.63	18.37	30.26	383	125	P	V
	*	2472	95.27	-	-	79.53	27.63	18.37	30.26	383	125	A	V
		2483.92	56.04	-17.96	74	40.25	27.66	18.38	30.25	383	125	P	V
		2483.52	45.05	-8.95	54	29.26	27.66	18.38	30.25	383	125	A	V
													V
													V
Remark	1. No other spurious found.												
	2. All results are PASS against Peak and Average limit line.												



2.4GHz 2400~2483.5MHz

WIFI 802.11b (Harmonic @ 3m)

WIFI	Note	Frequency	Level	Over	Limit	Read	Antenna	Path	Preamp	Ant	Table	Peak	Pol.	
Ant.				Limit	Line	Level	Factor	Loss	Factor	Pos	Pos	Avg.		
1+2		(MHz)	(dBμV/m)	(dB)	(dBμV/m)	(dBμV)	(dB/m)	(dB)	(dB)	(cm)	(deg)	(P/A)	(H/V)	
802.11b CH 01 2412MHz		4824	39.77	-34.23	74	51.59	32.45	13.84	58.11	100	0	P	H	
													H	
													H	
													H	
			4824	39.31	-34.69	74	51.13	32.45	13.84	58.11	100	0	P	V
														V
														V
802.11b CH 06 2437MHz		4874	38.98	-35.02	74	50.63	32.55	13.92	58.12	100	0	P	H	
		7311	42.48	-31.52	74	47.49	37.24	15.25	57.5	100	0	P	H	
													H	
													H	
			4874	39.18	-34.82	74	50.83	32.55	13.92	58.12	100	0	P	V
			7311	41.99	-32.01	74	47	37.24	15.25	57.5	100	0	P	V
														V
802.11b CH 11 2462MHz		4924	39.74	-34.26	74	51.21	32.65	14.01	58.13	100	0	P	H	
		7386	42.35	-31.65	74	47.24	37.34	15.17	57.4	100	0	P	H	
													H	
													H	
			4924	39.99	-34.01	74	51.46	32.65	14.01	58.13	100	0	P	V
			7386	42.38	-31.62	74	47.27	37.34	15.17	57.4	100	0	P	V
														V
Remark	1. No other spurious found.													
	2. All results are PASS against Peak and Average limit line.													



WIFI	Note	Frequency	Level	Over	Limit	Read	Antenna	Path	Preamp	Ant	Table	Peak	Pol.	
Ant. 1+2		(MHz)	(dBμV/m)	(dB)	Line (dBμV/m)	Level (dBμV)	Factor (dB/m)	Loss (dB)	Factor (dB)	Pos (cm)	Pos (deg)	Avg. (P/A)	(H/V)	
802.11b CH 12 2467MHz		4934	39.7	-34.3	74	51.16	32.67	14.01	58.14	100	0	P	H	
		7401	42.46	-31.54	74	47.32	37.36	15.16	57.38	100	0	P	H	
													H	
													H	
		4934	39.57	-34.43	74	51.03	32.67	14.01	58.14	100	0	P	V	
		7401	42.64	-31.36	74	47.5	37.36	15.16	57.38	100	0	P	V	
														V
														V
802.11b CH 13 2472MHz		4944	39.64	-34.36	74	51.06	32.69	14.03	58.14	100	0	P	H	
		7416	42.06	-31.94	74	46.83	37.38	15.21	57.36	100	0	P	H	
													H	
													H	
		4944	39.27	-34.73	74	50.69	32.69	14.03	58.14	100	0	P	V	
		7416	42.92	-31.08	74	47.69	37.38	15.21	57.36	100	0	P	V	
														V
														V
Remark	1. No other spurious found. 2. All results are PASS against Peak and Average limit line.													



2.4GHz 2400~2483.5MHz

WiFi 802.11g (Band Edge @ 3m)

WiFi Ant.	Note	Frequency	Level	Over Limit	Limit Line	Read Level	Antenna Factor	Path Loss	Preamp Factor	Ant Pos	Table Pos	Peak Avg.	Pol.	
1+2		(MHz)	(dBμV/m)	(dB)	(dBμV/m)	(dBμV)	(dB/m)	(dB)	(dB)	(cm)	(deg)	(P/A)	(H/V)	
802.11g CH 01 2412MHz		2367.855	55.88	-18.12	74	40.53	27.36	18.28	30.29	107	17	P	H	
		2389.695	43.65	-10.35	54	28.2	27.41	18.32	30.28	107	17	A	H	
	*	2412	102.07	-	-	86.54	27.47	18.34	30.28	107	17	P	H	
	*	2412	94.45	-	-	78.92	27.47	18.34	30.28	107	17	A	H	
													H	
													H	
			2341.29	55.8	-18.2	74	40.57	27.29	18.24	30.3	356	103	P	V
			2387.175	43.58	-10.42	54	28.14	27.41	18.31	30.28	356	103	A	V
	*		2412	98.44	-	-	82.91	27.47	18.34	30.28	356	103	P	V
	*		2412	91.37	-	-	75.84	27.47	18.34	30.28	356	103	A	V
													V	
													V	
802.11g CH 06 2437MHz		2322.18	55.64	-18.36	74	40.48	27.24	18.22	30.3	138	14	P	H	
		2389.8	43.73	-10.27	54	28.28	27.41	18.32	30.28	138	14	A	H	
	*	2437	106.04	-	-	90.42	27.54	18.35	30.27	138	14	P	H	
	*	2437	98.25	-	-	82.63	27.54	18.35	30.27	138	14	A	H	
			2483.55	56.44	-17.56	74	40.65	27.66	18.38	30.25	138	14	P	H
			2487.89	44.44	-9.56	54	28.64	27.67	18.38	30.25	138	14	A	H
			2337.58	56.04	-17.96	74	40.82	27.28	18.24	30.3	399	110	P	V
			2389.94	43.63	-10.37	54	28.18	27.41	18.32	30.28	399	110	A	V
	*		2437	102.07	-	-	86.45	27.54	18.35	30.27	399	110	P	V
	*		2437	94.76	-	-	79.14	27.54	18.35	30.27	399	110	A	V
			2491.74	55.91	-18.09	74	40.09	27.68	18.39	30.25	399	110	P	V
			2498.67	44.21	-9.79	54	28.37	27.7	18.39	30.25	399	110	A	V



802.11g CH 11 2462MHz	*	2462	106.43	-	-	90.72	27.6	18.37	30.26	108	30	P	H
	*	2462	98.84	-	-	83.13	27.6	18.37	30.26	108	30	A	H
		2484.48	57.12	-16.88	74	41.33	27.66	18.38	30.25	108	30	P	H
		2483.52	45.95	-8.05	54	30.16	27.66	18.38	30.25	108	30	A	H
													H
													H
	*	2462	102.01	-	-	86.3	27.6	18.37	30.26	391	126	P	V
	*	2462	94.67	-	-	78.96	27.6	18.37	30.26	391	126	A	V
		2493.6	56.2	-17.8	74	40.38	27.68	18.39	30.25	391	126	P	V
		2483.92	44.68	-9.32	54	28.89	27.66	18.38	30.25	391	126	A	V
													V
													V
Remark	1. No other spurious found. 2. All results are PASS against Peak and Average limit line.												



WIFI	Note	Frequency	Level	Over	Limit	Read	Antenna	Path	Preamp	Ant	Table	Peak	Pol.
Ant. 1+2		(MHz)	(dBμV/m)	(dB)	Line (dBμV/m)	Level (dBμV)	Factor (dB/m)	Loss (dB)	Factor (dB)	Pos (cm)	Pos (deg)	Avg. (P/A)	(H/V)
802.11g CH 12 2467MHz	*	2467	103.23	-	-	87.51	27.61	18.37	30.26	134	17	P	H
	*	2467	96.47	-	-	80.75	27.61	18.37	30.26	134	17	A	H
		2483.6	61.99	-12.01	74	46.2	27.66	18.38	30.25	134	17	P	H
		2483.52	49.99	-4.01	54	34.2	27.66	18.38	30.25	134	17	A	H
													H
													H
	*	2467	100.64	-	-	84.92	27.61	18.37	30.26	389	105	P	V
	*	2467	92.75	-	-	77.03	27.61	18.37	30.26	389	105	A	V
		2485.04	59.7	-14.3	74	43.91	27.66	18.38	30.25	389	105	P	V
		2483.52	47.73	-6.27	54	31.94	27.66	18.38	30.25	389	105	A	V
													V
													V
802.11g CH 13 2472MHz	*	2472	90.84	-	-	75.1	27.63	18.37	30.26	360	360	P	H
	*	2472	82.81	-	-	67.07	27.63	18.37	30.26	360	360	A	H
		2483.64	62.25	-11.75	74	46.46	27.66	18.38	30.25	360	360	P	H
		2483.52	50.75	-3.25	54	34.96	27.66	18.38	30.25	360	360	A	H
													H
													H
	*	2472	90.39	-	-	74.65	27.63	18.37	30.26	273	82	P	V
	*	2472	81.9	-	-	66.16	27.63	18.37	30.26	273	82	A	V
		2483.6	61.58	-12.42	74	45.79	27.66	18.38	30.25	273	82	P	V
		2483.52	49.79	-4.21	54	34	27.66	18.38	30.25	273	82	A	V
													V
													V
Remark	1. No other spurious found.												
	2. All results are PASS against Peak and Average limit line.												



2.4GHz 2400~2483.5MHz

WIFI 802.11g (Harmonic @ 3m)

WIFI	Note	Frequency	Level	Over	Limit	Read	Antenna	Path	Preamp	Ant	Table	Peak	Pol.	
Ant.				Limit	Line	Level	Factor	Loss	Factor	Pos	Pos	Avg.		
1+2		(MHz)	(dBμV/m)	(dB)	(dBμV/m)	(dBμV)	(dB/m)	(dB)	(dB)	(cm)	(deg)	(P/A)	(H/V)	
802.11g CH 01 2412MHz		4824	39.42	-34.58	74	51.24	32.45	13.84	58.11	100	0	P	H	
													H	
													H	
													H	
			4824	38.78	-35.22	74	50.6	32.45	13.84	58.11	100	0	P	V
														V
														V
802.11g CH 06 2437MHz		4874	39.1	-34.9	74	50.75	32.55	13.92	58.12	100	0	P	H	
		7311	43.38	-30.62	74	48.39	37.24	15.25	57.5	100	0	P	H	
													H	
													H	
			4874	39.45	-34.55	74	51.1	32.55	13.92	58.12	100	0	P	V
			7311	42.65	-31.35	74	47.66	37.24	15.25	57.5	100	0	P	V
														V
802.11g CH 11 2462MHz		4924	39.67	-34.33	74	51.14	32.65	14.01	58.13	100	0	P	H	
		7386	42.69	-31.31	74	47.58	37.34	15.17	57.4	100	0	P	H	
													H	
													H	
			4924	40.15	-33.85	74	51.62	32.65	14.01	58.13	100	0	P	V
			7386	42.69	-31.31	74	47.58	37.34	15.17	57.4	100	0	P	V
														V
Remark	1. No other spurious found.													
	2. All results are PASS against Peak and Average limit line.													



WIFI	Note	Frequency	Level	Over	Limit	Read	Antenna	Path	Preamp	Ant	Table	Peak	Pol.
Ant. 1+2		(MHz)	(dBμV/m)	(dB)	(dBμV/m)	(dBμV)	(dB/m)	(dB)	(dB)	(cm)	(deg)	(P/A)	(H/V)
802.11g CH 12 2467MHz		4934	39.11	-34.89	74	50.57	32.67	14.01	58.14	100	0	P	H
		7401	43.44	-30.56	74	48.3	37.36	15.16	57.38	100	0	P	H
													H
													H
		4934	38.93	-35.07	74	50.39	32.67	14.01	58.14	100	0	P	V
		7401	43.2	-30.8	74	48.06	37.36	15.16	57.38	100	0	P	V
													V
													V
802.11g CH 13 2472MHz		4944	40.5	-33.5	74	51.92	32.69	14.03	58.14	100	0	P	H
		7416	43.08	-30.92	74	47.85	37.38	15.21	57.36	100	0	P	H
													H
													H
		4944	40.07	-33.93	74	51.49	32.69	14.03	58.14	100	0	P	V
		7416	43.27	-30.73	74	48.04	37.38	15.21	57.36	100	0	P	V
													V
													V
Remark	1. No other spurious found. 2. All results are PASS against Peak and Average limit line.												



2.4GHz 2400~2483.5MHz

WIFI 802.11n HT20 (Band Edge @ 3m)

WIFI Ant.	Note	Frequency	Level	Over Limit	Limit Line	Read Level	Antenna Factor	Path Loss	Preamp Factor	Ant Pos	Table Pos	Peak Avg.	Pol.	
1+2		(MHz)	(dBμV/m)	(dB)	(dBμV/m)	(dBμV)	(dB/m)	(dB)	(dB)	(cm)	(deg)	(P/A)	(H/V)	
802.11n HT20 CH 01 2412MHz		2354.94	56.52	-17.48	74	41.23	27.32	18.26	30.29	115	19	P	H	
		2389.17	43.68	-10.32	54	28.24	27.41	18.31	30.28	115	19	A	H	
	*	2412	96.38	-	-	80.85	27.47	18.34	30.28	115	19	P	H	
	*	2412	88.16	-	-	72.63	27.47	18.34	30.28	115	19	A	H	
													H	
														H
			2333.835	56.1	-17.9	74	40.9	27.27	18.23	30.3	356	106	P	V
			2389.17	43.69	-10.31	54	28.25	27.41	18.31	30.28	356	106	A	V
	*		2412	92.31	-	-	76.78	27.47	18.34	30.28	356	106	P	V
	*		2412	84.34	-	-	68.81	27.47	18.34	30.28	356	106	A	V
													V	
													V	
802.11n HT20 CH 06 2437MHz		2380.42	57.42	-16.58	74	42.02	27.39	18.3	30.29	113	21	P	H	
		2389.66	43.87	-10.13	54	28.42	27.41	18.32	30.28	113	21	A	H	
	*	2437	105.96	-	-	90.34	27.54	18.35	30.27	113	21	P	H	
	*	2437	97.3	-	-	81.68	27.54	18.35	30.27	113	21	A	H	
			2499.23	57.32	-16.68	74	41.48	27.7	18.39	30.25	113	21	P	H
			2486.35	44.52	-9.48	54	28.73	27.66	18.38	30.25	113	21	A	H
			2384.9	56.73	-17.27	74	41.3	27.4	18.31	30.28	349	106	P	V
			2389.52	43.71	-10.29	54	28.27	27.41	18.31	30.28	349	106	A	V
	*		2437	100.99	-	-	85.37	27.54	18.35	30.27	349	106	P	V
	*		2437	92.7	-	-	77.08	27.54	18.35	30.27	349	106	A	V
		2498.32	56.71	-17.29	74	40.87	27.7	18.39	30.25	349	106	P	V	
		2486.98	44.25	-9.75	54	28.45	27.67	18.38	30.25	349	106	A	V	



802.11n HT20 CH 11 2462MHz	*	2462	105.65	-	-	89.94	27.6	18.37	30.26	131	26	P	H
	*	2462	98.19	-	-	82.48	27.6	18.37	30.26	131	26	A	H
		2484.56	58.1	-15.9	74	42.31	27.66	18.38	30.25	131	26	P	H
		2483.52	46.91	-7.09	54	31.12	27.66	18.38	30.25	131	26	A	H
													H
													H
	*	2462	101.49	-	-	85.78	27.6	18.37	30.26	344	103	P	V
	*	2462	93	-	-	77.29	27.6	18.37	30.26	344	103	A	V
		2496.2	56.9	-17.1	74	41.07	27.69	18.39	30.25	344	103	P	V
		2483.52	45.11	-8.89	54	29.32	27.66	18.38	30.25	344	103	A	V
													V
													V
Remark	1. No other spurious found. 2. All results are PASS against Peak and Average limit line.												



WIFI	Note	Frequency	Level	Over	Limit	Read	Antenna	Path	Preamp	Ant	Table	Peak	Pol.	
Ant. 1+2		(MHz)	(dBµV/m)	(dB)	Line (dBµV/m)	Level (dBµV)	Factor (dB/m)	Loss (dB)	Factor (dB)	Pos (cm)	Pos (deg)	Avg. (P/A)	(H/V)	
802.11n HT20 CH 12 2467MHz	*	2467	102.36	-	-	86.64	27.61	18.37	30.26	106	22	P	H	
	*	2467	94.16	-	-	78.44	27.61	18.37	30.26	106	22	A	H	
		2483.64	63.47	-10.53	74	47.68	27.66	18.38	30.25	106	22	P	H	
		2483.52	50.79	-3.21	54	35	27.66	18.38	30.25	106	22	A	H	
													H	
														H
	*	2467	97.29	-	-	81.57	27.61	18.37	30.26	340	105	P	V	
	*	2467	89.14	-	-	73.42	27.61	18.37	30.26	340	105	A	V	
		2483.76	59.01	-14.99	74	43.22	27.66	18.38	30.25	340	105	P	V	
		2483.52	47.01	-6.99	54	31.22	27.66	18.38	30.25	340	105	A	V	
													V	
													V	
802.11n HT20 CH 13 2472MHz	*	2472	89.16	-	-	73.42	27.63	18.37	30.26	109	316	P	H	
	*	2472	81.49	-	-	65.75	27.63	18.37	30.26	109	316	A	H	
		2483.68	62.57	-11.43	74	46.78	27.66	18.38	30.25	109	316	P	H	
		2483.52	50.78	-3.22	54	34.99	27.66	18.38	30.25	109	316	A	H	
													H	
														H
	*	2472	87.23	-	-	71.49	27.63	18.37	30.26	101	4	P	V	
	*	2472	79.08	-	-	63.34	27.63	18.37	30.26	101	4	A	V	
		2483.56	61.82	-12.18	74	46.03	27.66	18.38	30.25	101	4	P	V	
		2483.52	49.28	-4.72	54	33.49	27.66	18.38	30.25	101	4	A	V	
													V	
													V	
Remark	1. No other spurious found.													
	2. All results are PASS against Peak and Average limit line.													



2.4GHz 2400~2483.5MHz

WIFI 802.11n HT20 (Harmonic @ 3m)

WIFI	Note	Frequency	Level	Over	Limit	Read	Antenna	Path	Preamp	Ant	Table	Peak	Pol.	
Ant.				Limit	Line	Level	Factor	Loss	Factor	Pos	Pos	Avg.		
1+2		(MHz)	(dBμV/m)	(dB)	(dBμV/m)	(dBμV)	(dB/m)	(dB)	(dB)	(cm)	(deg)	(P/A)	(H/V)	
802.11n HT20 CH 01 2412MHz		4824	38.91	-35.09	74	50.73	32.45	13.84	58.11	100	0	P	H	
													H	
													H	
													H	
			4824	39.43	-34.57	74	51.25	32.45	13.84	58.11	100	0	P	V
														V
														V
802.11n HT20 CH 06 2437MHz		4874	39.45	-34.55	74	51.1	32.55	13.92	58.12	100	0	P	H	
		7311	42.7	-31.3	74	47.71	37.24	15.25	57.5	100	0	P	H	
													H	
													H	
			4874	39.52	-34.48	74	51.17	32.55	13.92	58.12	100	0	P	V
			7311	42.79	-31.21	74	47.8	37.24	15.25	57.5	100	0	P	V
														V
802.11n HT20 CH 11 2462MHz		4924	39.58	-34.42	74	51.05	32.65	14.01	58.13	100	0	P	H	
		7386	42.93	-31.07	74	47.82	37.34	15.17	57.4	100	0	P	H	
													H	
													H	
			4924	39.31	-34.69	74	50.78	32.65	14.01	58.13	100	0	P	V
			7386	42.98	-31.02	74	47.87	37.34	15.17	57.4	100	0	P	V
														V
Remark	1. No other spurious found.													
	2. All results are PASS against Peak and Average limit line.													



WIFI	Note	Frequency	Level	Over	Limit	Read	Antenna	Path	Preamp	Ant	Table	Peak	Pol.
Ant. 1+2		(MHz)	(dBμV/m)	(dB)	Line (dBμV/m)	Level (dBμV)	Factor (dB/m)	Loss (dB)	Factor (dB)	Pos (cm)	Pos (deg)	Avg. (P/A)	(H/V)
802.11n HT20 CH 12 2467MHz		4934	40.8	-33.2	74	52.26	32.67	14.01	58.14	100	0	P	H
		7401	43.2	-30.8	74	48.06	37.36	15.16	57.38	100	0	P	H
													H
													H
		4934	39.55	-34.45	74	51.01	32.67	14.01	58.14	100	0	P	V
		7401	42.19	-31.81	74	47.05	37.36	15.16	57.38	100	0	P	V
802.11n HT20 CH 13 2472MHz		4944	40.23	-33.77	74	51.65	32.69	14.03	58.14	100	0	P	H
		7416	42.67	-31.33	74	47.44	37.38	15.21	57.36	100	0	P	H
													H
													H
		4944	39.36	-34.64	74	50.78	32.69	14.03	58.14	100	0	P	V
		7416	43.69	-30.31	74	48.46	37.38	15.21	57.36	100	0	P	V
Remark	1. No other spurious found.												
	2. All results are PASS against Peak and Average limit line.												



Emission below 1GHz

2.4GHz WIFI 802.11n HT20 (LF)

WIFI Ant.	Note	Frequency	Level	Over Limit	Limit Line	Read Level	Antenna Factor	Path Loss	Preamp Factor	Ant Pos	Table Pos	Peak Avg.	Pol.	
1+2		(MHz)	(dBμV/m)	(dB)	(dBμV/m)	(dBμV)	(dB/m)	(dB)	(dB)	(cm)	(deg)	(P/A)	(H/V)	
2.4GHz 802.11n HT20 LF		32.91	20.9	-19.1	40	30.03	23.05	0.27	32.45	-	-	P	H	
		212.36	25.08	-18.42	43.5	40.4	15.15	1.89	32.36	-	-	P	H	
		418.97	23.96	-22.04	46	30.67	22.61	3.2	32.52	-	-	P	H	
		709	28.9	-17.1	46	30.47	26.77	4.17	32.51	-	-	P	H	
		863.23	32.34	-13.66	46	30.58	29.11	4.65	32	100	0	P	H	
		987.39	34.49	-19.51	54	29.43	30.73	5.35	31.02	-	-	P	H	
														H
														H
														H
														H
														H
			38.73	23.64	-16.36	40	35.81	19.84	0.43	32.44	-	-	P	V
			177.44	23.74	-19.76	43.5	39.31	15.16	1.62	32.35	-	-	P	V
			432.55	24.06	-21.94	46	30.55	22.85	3.19	32.53	-	-	P	V
			683.78	29.16	-16.84	46	31.15	26.48	4.08	32.55	-	-	P	V
			763.32	31.76	-14.24	46	31.47	28.23	4.48	32.42	-	-	P	V
			953.44	33.97	-12.03	46	29.78	30.83	4.68	31.32	100	0	P	V
														V
													V	
													V	
													V	
													V	
													V	
Remark	1. No other spurious found. 2. All results are PASS against limit line.													



Note symbol

*	Fundamental Frequency which can be ignored. However, the level of any unwanted emissions shall not exceed the level of the fundamental frequency.
!	Test result is over limit line.
P/A	Peak or Average
H/V	Horizontal or Vertical



A calculation example for radiated spurious emission is shown as below:

WIFI	Note	Frequency	Level	Over	Limit	Read	Antenna	Path	Preamp	Ant	Table	Peak	Pol.
Ant.				Limit	Line	Level	Factor	Loss	Factor	Pos	Pos	Avg.	
1+2		(MHz)	(dBμV/m)	(dB)	(dBμV/m)	(dBμV)	(dB/m)	(dB)	(dB)	(cm)	(deg)	(P/A)	(H/V)
802.11b		2390	55.45	-18.55	74	54.51	32.22	4.58	35.86	103	308	P	H
CH 01													
2412MHz		2390	43.54	-10.46	54	42.6	32.22	4.58	35.86	103	308	A	H

1. Path Loss(dB) = Cable loss(dB) + Filter loss(dB) + Attenuator loss(dB)
2. Level(dBμV/m) =
Antenna Factor(dB/m) + Path Loss(dB) + Read Level(dBμV) - Preamp Factor(dB)
3. Over Limit(dB) = Level(dBμV/m) – Limit Line(dBμV/m)

For Peak Limit @ 2390MHz:

1. Level(dBμV/m)
= Antenna Factor(dB/m) + Path Loss(dB) + Read Level(dBμV) - Preamp Factor(dB)
= 32.22(dB/m) + 4.58(dB) + 54.51(dBμV) – 35.86 (dB)
= 55.45 (dBμV/m)
2. Over Limit(dB)
= Level(dBμV/m) – Limit Line(dBμV/m)
= 55.45(dBμV/m) – 74(dBμV/m)
= -18.55(dB)

For Average Limit @ 2390MHz:

1. Level(dBμV/m)
= Antenna Factor(dB/m) + Path Loss(dB) + Read Level(dBμV) - Preamp Factor(dB)
= 32.22(dB/m) + 4.58(dB) + 42.6(dBμV) – 35.86 (dB)
= 43.54 (dBμV/m)
2. Over Limit(dB)
= Level(dBμV/m) – Limit Line(dBμV/m)
= 43.54(dBμV/m) – 54(dBμV/m)
= -10.46(dB)

Both peak and average measured complies with the limit line, so test result is “PASS”.



Appendix D. Radiated Spurious Emission Plots

Test Engineer :	Jacky Hung, Austin LI, CR Liro, and Peter	Temperature :	20~25°C
	Liao	Relative Humidity :	50~60%

Note symbol

-L	Low channel location
-R	High channel location



2.4GHz 2400~2483.5MHz
WIFI 802.11b (Band Edge @ 3m)

WIFI	2.4GHz 2400~2483.5MHz Band Edge @ 3m	
ANT	802.11b CH01 2412MHz	
1+2	Horizontal	Fundamental
Peak	<p>Site : 03CH16-HY Condition : PEAK_BE_74 3m 91200_1522 HORIZONTAL Detector : Peak Project : 940905-02</p>	<p>Site : 03CH16-HY Condition : PEAK_74 3m 91200_1522 HORIZONTAL Detector : Peak Project : 940905-02</p>
Avg.	<p>Site : 03CH16-HY Condition : AVG_BE_54 3m 91200_1522 HORIZONTAL Detector : Peak Project : 940905-02</p>	<p>Site : 03CH16-HY Condition : AVG_54 3m 91200_1522 HORIZONTAL Detector : Peak Project : 940905-02</p>



WIFI	2.4GHz 2400~2483.5MHz Band Edge @ 3m	
ANT	802.11b CH01 2412MHz	
1+2	Vertical	Fundamental
<p>Peak</p>	<p>Site : 03CH16-HY Condition : PEAK_BE_74 3m 91200_1522 VERTICAL Detector : Peak Project : 940905-02</p>	<p>Site : 03CH16-HY Condition : PEAK_74 3m 91200_1522 VERTICAL Detector : Peak Project : 940905-02</p>
<p>Avg.</p>	<p>Site : 03CH16-HY Condition : AVG_BE_54 3m 91200_1522 VERTICAL Detector : Peak Project : 940905-02</p>	<p>Site : 03CH16-HY Condition : AVG_54 3m 91200_1522 VERTICAL Detector : Peak Project : 940905-02</p>

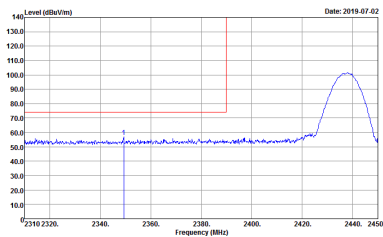
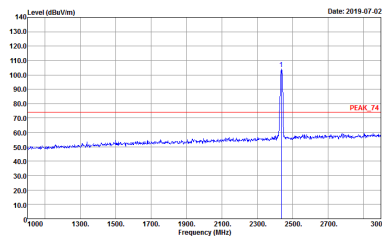
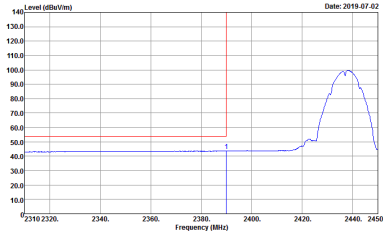
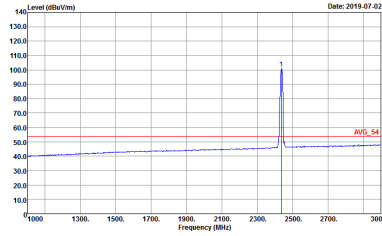

WIFI	2.4GHz 2400~2483.5MHz Band Edge @ 3m	
ANT	802.11b CH06 2437MHz - L	
1+2	Horizontal	Fundamental
<p>Peak</p>	 <p>Site : 03CH16-HY Condition : PEAK_BE_74 3m 91200_1522 HORIZONTAL RBW:1000.000kHz VBW:3000.000kHz SWT:Auto Detector : Peak Project : 940905-02</p>	 <p>Site : 03CH16-HY Condition : PEAK_74 3m 91200_1522 HORIZONTAL RBW:1000.000kHz VBW:3000.000kHz SWT:Auto Detector : Peak Project : 940905-02</p>
<p>Avg.</p>	 <p>Site : 03CH16-HY Condition : AVG_BE_54 3m 91200_1522 HORIZONTAL RBW:1000.000kHz VBW:0.010kHz SWT:Auto Detector : Peak Project : 940905-02</p>	 <p>Site : 03CH16-HY Condition : AVG_54 3m 91200_1522 HORIZONTAL RBW:1000.000kHz VBW:0.010kHz SWT:Auto Detector : Peak Project : 940905-02</p>

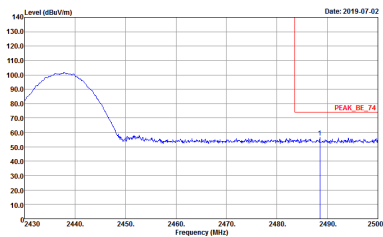
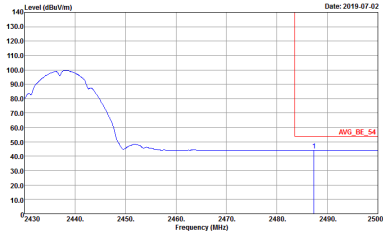

WIFI	2.4GHz 2400~2483.5MHz Band Edge @ 3m	
ANT	802.11b CH06 2437MHz - R	
1+2	Horizontal	Fundamental
<p>Peak</p>	 <p>Site : 03CH16-HY Condition : PEAK_BE_74 3m 91200_1522 HORIZONTAL Detector : Peak Project : 940905-02</p>	<p>Left blank</p>
<p>Avg.</p>	 <p>Site : 03CH16-HY Condition : AVG_BE_54 3m 91200_1522 HORIZONTAL Detector : Peak Project : 940905-02</p>	<p>Left blank</p>

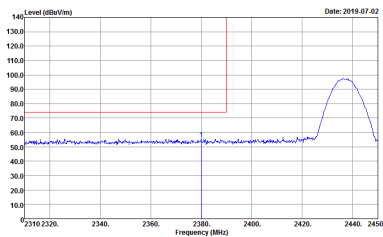
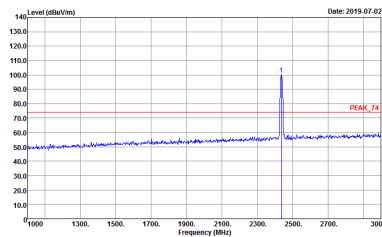
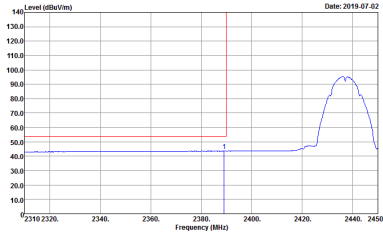
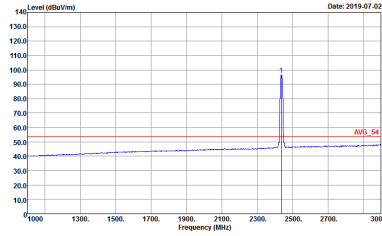

WIFI	2.4GHz 2400~2483.5MHz Band Edge @ 3m	
ANT	802.11b CH06 2437MHz - L	
1+2	Vertical	Fundamental
Peak	 <p>Site : 03CH16-HY Condition : PEAK_BE_74 3m 91200_1522 VERTICAL : RBW:1000.000KHz VBW:3000.000KHz SWT:Auto Detector : Peak Project : 940905-02</p>	 <p>Site : 03CH16-HY Condition : PEAK_74 3m 91200_1522 VERTICAL : RBW:1000.000KHz VBW:3000.000KHz SWT:Auto Detector : Peak Project : 940905-02</p>
Avg.	 <p>Site : 03CH16-HY Condition : AVG_BE_54 3m 91200_1522 VERTICAL : RBW:1000.000KHz VBW:0.010KHz SWT:Auto Detector : Peak Project : 940905-02</p>	 <p>Site : 03CH16-HY Condition : AVG_54 3m 91200_1522 VERTICAL : RBW:1000.000KHz VBW:0.010KHz SWT:Auto Detector : Peak Project : 940905-02</p>

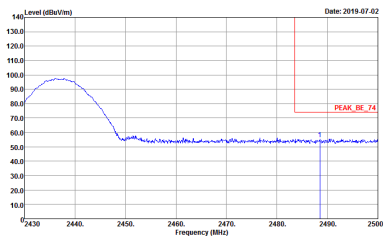
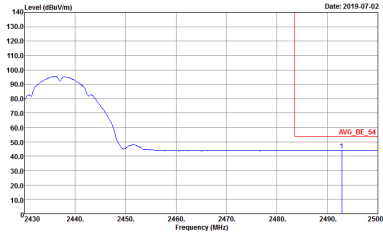

WIFI	2.4GHz 2400~2483.5MHz Band Edge @ 3m	
ANT	802.11b CH06 2437MHz - R	
1+2	Vertical	Fundamental
<p>Peak</p>	 <p>Date: 2019-07-02</p> <p>Site : 03CH16-HY Condition : PEAK_BE_74 3m 91200_1522 VERTICAL RBW:1000.000kHz VBW:3000.000kHz SWT:Auto Detector : Peak Project : 940905-02</p>	<p>Left blank</p>
<p>Avg.</p>	 <p>Date: 2019-07-02</p> <p>Site : 03CH16-HY Condition : AVG_BE_54 3m 91200_1522 VERTICAL RBW:1000.000kHz VBW:3.010kHz SWT:Auto Detector : Peak Project : 940905-02</p>	<p>Left blank</p>

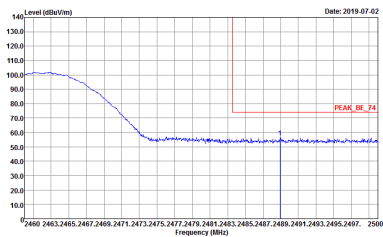
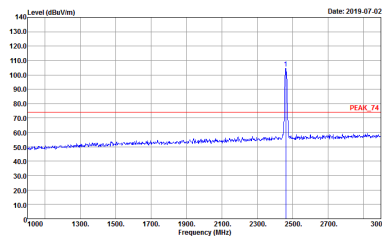
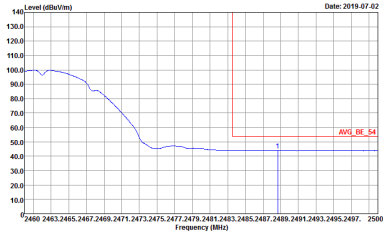
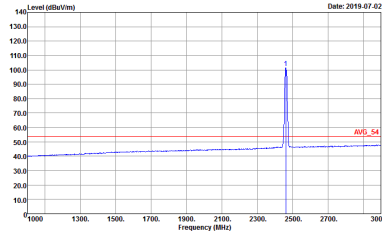

WIFI	2.4GHz 2400~2483.5MHz Band Edge @ 3m	
ANT	802.11b CH11 2462MHz	
1+2	Horizontal	Fundamental
Peak	 <p>Date: 2019-07-02</p> <p>Site : 03CH16-HY Condition : PEAK_BE_74 3m 91200_1522 HORIZONTAL : RBW:1000.000KHz VBW:3000.000KHz SWT:Auto Detector : Peak Project : 940905-02</p>	 <p>Date: 2019-07-02</p> <p>Site : 03CH16-HY Condition : PEAK_74 3m 91200_1522 HORIZONTAL : RBW:1000.000KHz VBW:3000.000KHz SWT:Auto Detector : Peak Project : 940905-02</p>
Avg.	 <p>Date: 2019-07-02</p> <p>Site : 03CH16-HY Condition : AVG_BE_54 3m 91200_1522 HORIZONTAL : RBW:1000.000KHz VBW:0.010KHz SWT:Auto Detector : Peak Project : 940905-02</p>	 <p>Date: 2019-07-02</p> <p>Site : 03CH16-HY Condition : AVG_54 3m 91200_1522 HORIZONTAL : RBW:1000.000KHz VBW:0.010KHz SWT:Auto Detector : Peak Project : 940905-02</p>

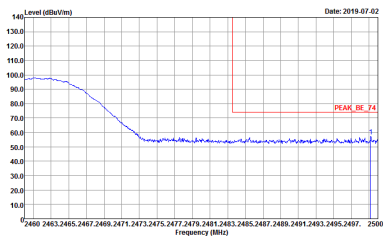
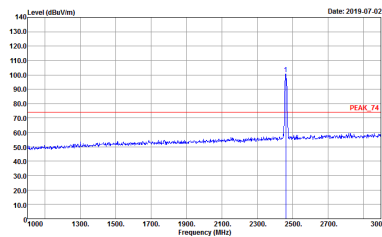
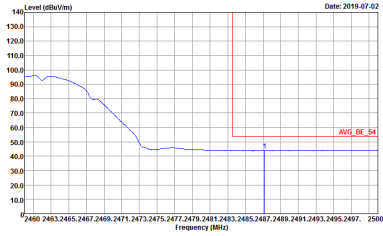
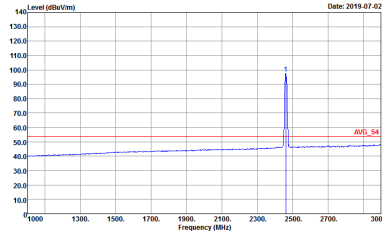

WIFI	2.4GHz 2400~2483.5MHz Band Edge @ 3m	
ANT	802.11b CH11 2462MHz	
1+2	Vertical	Fundamental
<p>Peak</p>	 <p>Site : 03CH16-HY Condition : PEAK_BE_74 3m 91200_1522 VERTICAL RBW:1000.000KHz VBW:3000.000KHz SWT:Auto Detector : Peak Project : 940905-02</p>	 <p>Site : 03CH16-HY Condition : PEAK_74 3m 91200_1522 VERTICAL RBW:1000.000KHz VBW:3000.000KHz SWT:Auto Detector : Peak Project : 940905-02</p>
<p>Avg.</p>	 <p>Site : 03CH16-HY Condition : AVG_BE_54 3m 91200_1522 VERTICAL RBW:1000.000KHz VBW:0.010KHz SWT:Auto Detector : Peak Project : 940905-02</p>	 <p>Site : 03CH16-HY Condition : AVG_54 3m 91200_1522 VERTICAL RBW:1000.000KHz VBW:0.010KHz SWT:Auto Detector : Peak Project : 940905-02</p>

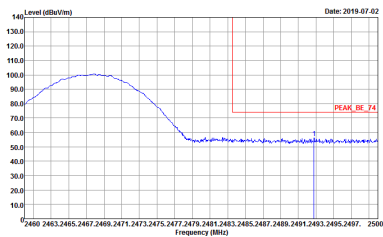
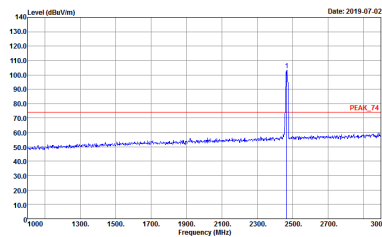
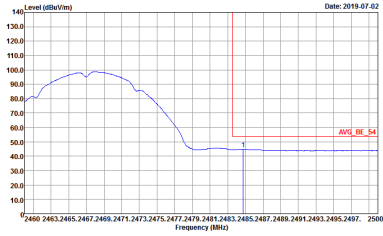
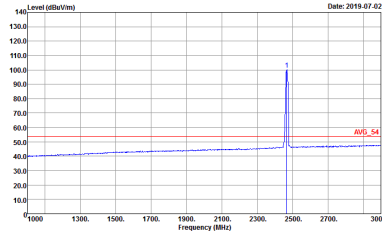

WIFI	2.4GHz 2400~2483.5MHz Band Edge @ 3m	
ANT	802.11b CH12 2467MHz	
1+2	Horizontal	Fundamental
<p>Peak</p>	 <p>Date: 2019-07-02</p> <p>Site : 03CH16-HY Condition : PEAK_BE_74 3m 91200_1522 HORIZONTAL : RBW:1000.000KHz VBW:3000.000KHz SWT:Auto Detector : Peak Project : 940905-02</p>	 <p>Date: 2019-07-02</p> <p>Site : 03CH16-HY Condition : PEAK_74 3m 91200_1522 HORIZONTAL : RBW:1000.000KHz VBW:3000.000KHz SWT:Auto Detector : Peak Project : 940905-02</p>
<p>Avg.</p>	 <p>Date: 2019-07-02</p> <p>Site : 03CH16-HY Condition : AVG_BE_54 3m 91200_1522 HORIZONTAL : RBW:1000.000KHz VBW:0.010KHz SWT:Auto Detector : Peak Project : 940905-02</p>	 <p>Date: 2019-07-02</p> <p>Site : 03CH16-HY Condition : AVG_54 3m 91200_1522 HORIZONTAL : RBW:1000.000KHz VBW:0.010KHz SWT:Auto Detector : Peak Project : 940905-02</p>

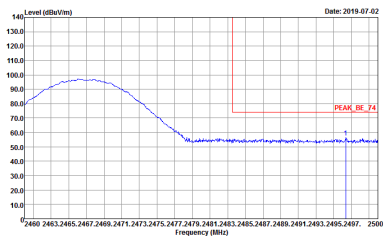
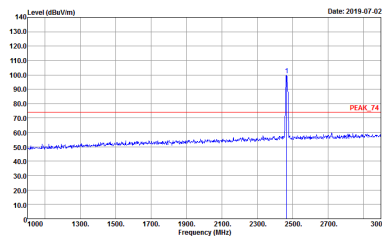
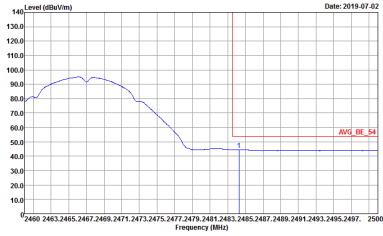
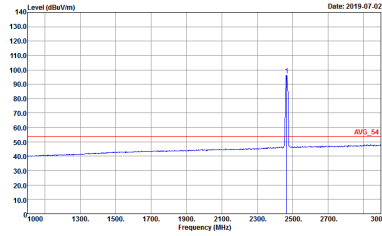

WIFI	2.4GHz 2400~2483.5MHz Band Edge @ 3m	
ANT	802.11b CH12 2467MHz	
1+2	Vertical	Fundamental
Peak	 <p>Site : 03CH16-HY Condition : PEAK_BE_74 3m 91200_1522 VERTICAL : RBW:1000.000KHz VBW:3000.000KHz SWT:Auto Detector : Peak Project : 940905-02</p>	 <p>Site : 03CH16-HY Condition : PEAK_74 3m 91200_1522 VERTICAL : RBW:1000.000KHz VBW:3000.000KHz SWT:Auto Detector : Peak Project : 940905-02</p>
Avg.	 <p>Site : 03CH16-HY Condition : AVG_BE_54 3m 91200_1522 VERTICAL : RBW:1000.000KHz VBW:0.010KHz SWT:Auto Detector : Peak Project : 940905-02</p>	 <p>Site : 03CH16-HY Condition : AVG_54 3m 91200_1522 VERTICAL : RBW:1000.000KHz VBW:0.010KHz SWT:Auto Detector : Peak Project : 940905-02</p>

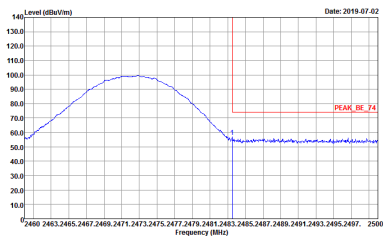
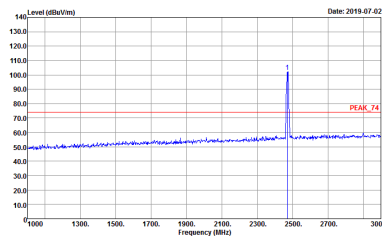
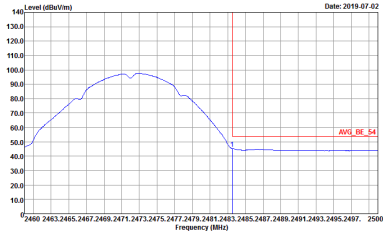
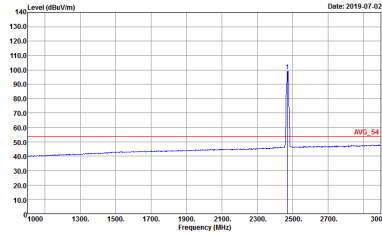

WIFI	2.4GHz 2400~2483.5MHz Band Edge @ 3m	
ANT	802.11b CH13 2472MHz	
1+2	Horizontal	Fundamental
Peak	 <p>Site : 03CH16-HY Condition : PEAK_BE_74 3m 91200_1522 HORIZONTAL Detector : Peak Project : 940905-02</p>	 <p>Site : 03CH16-HY Condition : PEAK_74 3m 91200_1522 HORIZONTAL Detector : Peak Project : 940905-02</p>
Avg.	 <p>Site : 03CH16-HY Condition : AVG_BE_54 3m 91200_1522 HORIZONTAL Detector : Peak Project : 940905-02</p>	 <p>Site : 03CH16-HY Condition : AVG_54 3m 91200_1522 HORIZONTAL Detector : Peak Project : 940905-02</p>

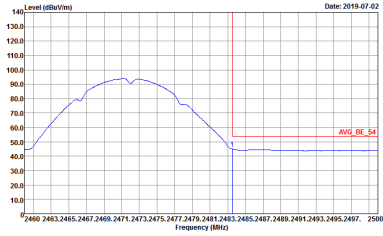
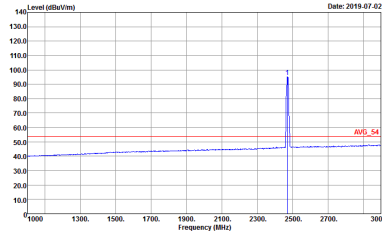

WIFI	2.4GHz 2400~2483.5MHz Band Edge @ 3m	
ANT	802.11b CH13 2472MHz	
1+2	Vertical	Fundamental
Peak	 <p>Site : 03CH16-HY Condition : PEAK_BE_74 3m 91200_1522 VERTICAL RBW:1000.000KHz VBW:3000.000KHz SWT:Auto Detector : Peak Project : 940905-02</p>	 <p>Site : 03CH16-HY Condition : PEAK_74 3m 91200_1522 VERTICAL RBW:1000.000KHz VBW:3000.000KHz SWT:Auto Detector : Peak Project : 940905-02</p>
Avg.	 <p>Site : 03CH16-HY Condition : AVG_BE_54 3m 91200_1522 VERTICAL RBW:1000.000KHz VBW:0.010KHz SWT:Auto Detector : Peak Project : 940905-02</p>	 <p>Site : 03CH16-HY Condition : AVG_54 3m 91200_1522 VERTICAL RBW:1000.000KHz VBW:0.010KHz SWT:Auto Detector : Peak Project : 940905-02</p>

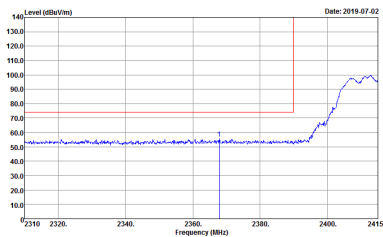
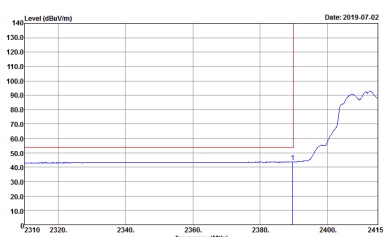
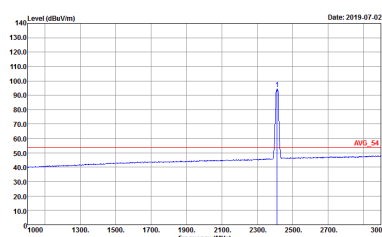

2.4GHz 2400~2483.5MHz
WIFI 802.11g (Band Edge @ 3m)

WIFI	2.4GHz 2400~2483.5MHz Band Edge @ 3m	
ANT	802.11g CH01 2412MHz	
1+2	Horizontal	Fundamental
Peak	 <p>Site : 03CH16-HY Condition : PEAK_BE_74 3m 91200_1522 HORIZONTAL Detector : Peak Project : 940905-02</p>	 <p>Site : 03CH16-HY Condition : PEAK_74 3m 91200_1522 HORIZONTAL Detector : Peak Project : 940905-02</p>
Avg.	 <p>Site : 03CH16-HY Condition : AVG_BE_54 3m 91200_1522 HORIZONTAL Detector : Peak Project : 940905-02</p>	 <p>Site : 03CH16-HY Condition : AVG_54 3m 91200_1522 HORIZONTAL Detector : Peak Project : 940905-02</p>



WIFI	2.4GHz 2400~2483.5MHz Band Edge @ 3m	
ANT	802.11g CH01 2412MHz	
1+2	Vertical	Fundamental
<p>Peak</p>	<p>Site : 03CH16-HY Condition : PEAK_BE_74 3m 91200_1522 VERTICAL Detector : Peak Project : 940905-02</p>	<p>Site : 03CH16-HY Condition : PEAK_74 3m 91200_1522 VERTICAL Detector : Peak Project : 940905-02</p>
<p>Avg.</p>	<p>Site : 03CH16-HY Condition : AVG_BE_54 3m 91200_1522 VERTICAL Detector : Peak Project : 940905-02</p>	<p>Site : 03CH16-HY Condition : AVG_54 3m 91200_1522 VERTICAL Detector : Peak Project : 940905-02</p>

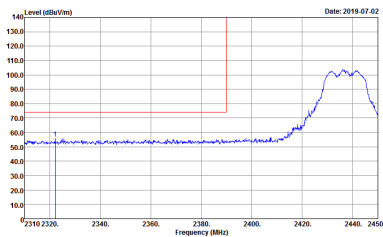
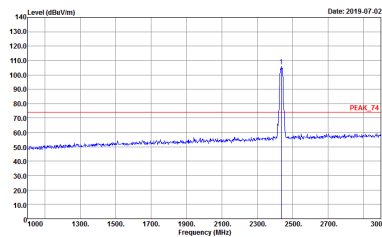
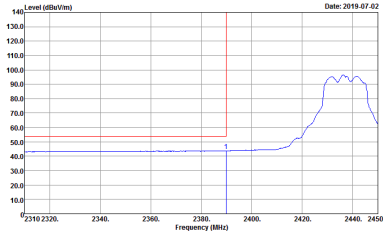
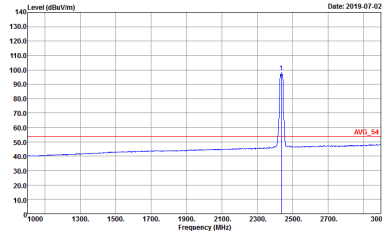

WIFI	2.4GHz 2400~2483.5MHz Band Edge @ 3m	
ANT	802.11g CH06 2437MHz - L	
1+2	Horizontal	Fundamental
<p>Peak</p>	 <p>Site : 03CH16-HY Condition : PEAK_BE_74 3m 91200_1522 HORIZONTAL Detector : Peak Project : 940905-02</p>	 <p>Site : 03CH16-HY Condition : PEAK_74 3m 91200_1522 HORIZONTAL Detector : Peak Project : 940905-02</p>
<p>Avg.</p>	 <p>Site : 03CH16-HY Condition : AVG_BE_54 3m 91200_1522 HORIZONTAL Detector : Peak Project : 940905-02</p>	 <p>Site : 03CH16-HY Condition : AVG_54 3m 91200_1522 HORIZONTAL Detector : Peak Project : 940905-02</p>

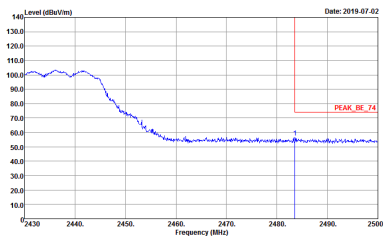
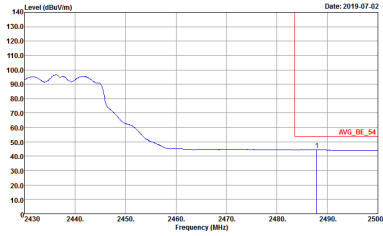

WIFI	2.4GHz 2400~2483.5MHz Band Edge @ 3m	
ANT	802.11g CH06 2437MHz - R	
1+2	Horizontal	Fundamental
<p>Peak</p>	 <p>Site : 03CH16-HY Condition : PEAK_BE_74 3m 91200_1522 HORIZONTAL Detector : Peak Project : 940905-02</p>	<p>Left blank</p>
<p>Avg.</p>	 <p>Site : 03CH16-HY Condition : AVG_BE_54 3m 91200_1522 HORIZONTAL Detector : Peak Project : 940905-02</p>	<p>Left blank</p>

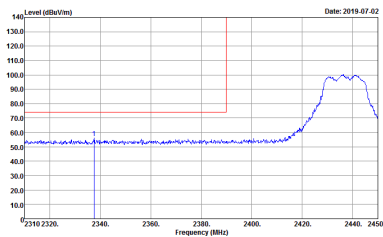
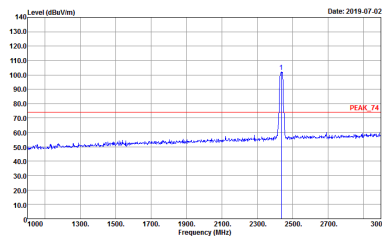
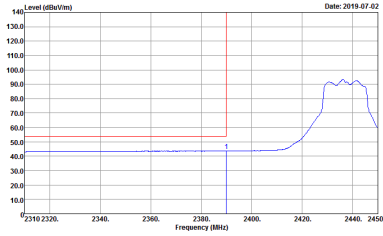
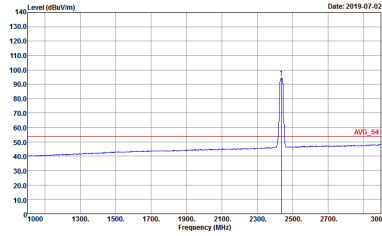

WIFI	2.4GHz 2400~2483.5MHz Band Edge @ 3m	
ANT	802.11g CH06 2437MHz - L	
1+2	Vertical	Fundamental
Peak	 <p>Site : 03CH16-HY Condition : PEAK_BE_74 3m 91200_1522 VERTICAL Detector : Peak Project : 940905-02</p>	 <p>Site : 03CH16-HY Condition : PEAK_74 3m 91200_1522 VERTICAL Detector : Peak Project : 940905-02</p>
Avg.	 <p>Site : 03CH16-HY Condition : AVG_BE_54 3m 91200_1522 VERTICAL Detector : Peak Project : 940905-02</p>	 <p>Site : 03CH16-HY Condition : AVG_54 3m 91200_1522 VERTICAL Detector : Peak Project : 940905-02</p>



WIFI	2.4GHz 2400~2483.5MHz Band Edge @ 3m	
ANT	802.11g CH06 2437MHz - R	
1+2	Vertical	Fundamental
Peak	<p>Site : 03CH16-HY Condition : PEAK_BE_74 3m 91200_1522 VERTICAL Detector : Peak Project : 940905-02</p>	Left Blank
Avg.	<p>Site : 03CH16-HY Condition : AVG_BE_54 3m 91200_1522 VERTICAL Detector : Peak Project : 940905-02</p>	Left Blank

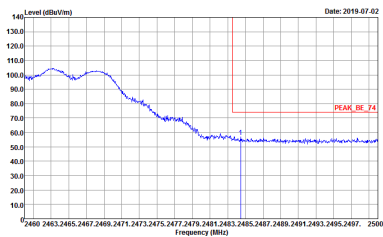
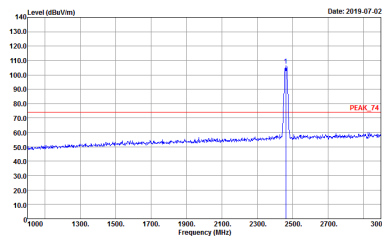
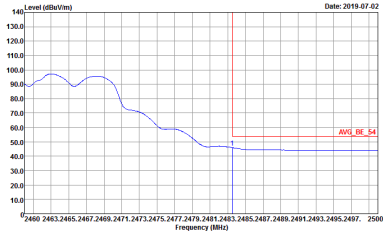
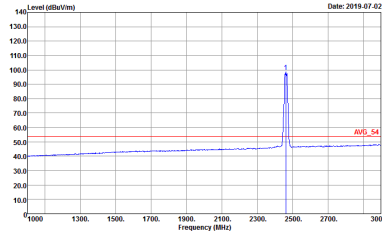

WIFI	2.4GHz 2400~2483.5MHz Band Edge @ 3m	
ANT	802.11g CH11 2462MHz	
1+2	Horizontal	Fundamental
<p>Peak</p>	 <p>Date: 2019-07-02</p> <p>Site : 03CH16-HY Condition : PEAK_BE_74 3m 91200_1522 HORIZONTAL : RBW:1000.000KHz VBW:3000.000KHz SWT:Auto Detector : Peak Project : 940905-02</p>	 <p>Date: 2019-07-02</p> <p>Site : 03CH16-HY Condition : PEAK_74 3m 91200_1522 HORIZONTAL : RBW:1000.000KHz VBW:3000.000KHz SWT:Auto Detector : Peak Project : 940905-02</p>
<p>Avg.</p>	 <p>Date: 2019-07-02</p> <p>Site : 03CH16-HY Condition : AVG_BE_54 3m 91200_1522 HORIZONTAL : RBW:1000.000KHz VBW:0.010KHz SWT:Auto Detector : Peak Project : 940905-02</p>	 <p>Date: 2019-07-02</p> <p>Site : 03CH16-HY Condition : AVG_54 3m 91200_1522 HORIZONTAL : RBW:1000.000KHz VBW:0.010KHz SWT:Auto Detector : Peak Project : 940905-02</p>

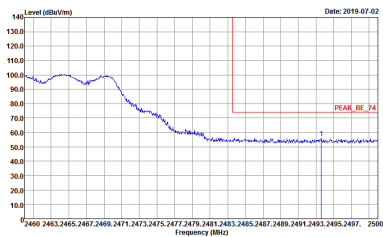
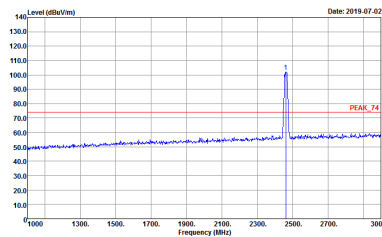
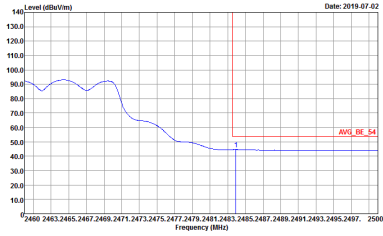
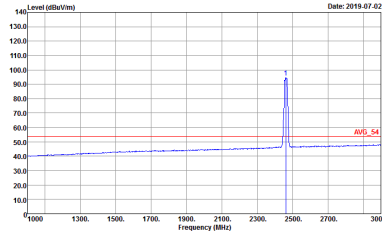

WIFI	2.4GHz 2400~2483.5MHz Band Edge @ 3m	
ANT	802.11g CH11 2462MHz	
1+2	Vertical	Fundamental
Peak	 <p>Site : 03CH16-HY Condition : PEAK_BE_74 3m 91200_1522 VERTICAL RBW:1000.000KHz VBW:3000.000KHz SWT:Auto Detector : Peak Project : 940905-02</p>	 <p>Site : 03CH16-HY Condition : PEAK_74 3m 91200_1522 VERTICAL RBW:1000.000KHz VBW:3000.000KHz SWT:Auto Detector : Peak Project : 940905-02</p>
Avg.	 <p>Site : 03CH16-HY Condition : AVG_BE_54 3m 91200_1522 VERTICAL RBW:1000.000KHz VBW:0.010KHz SWT:Auto Detector : Peak Project : 940905-02</p>	 <p>Site : 03CH16-HY Condition : AVG_54 3m 91200_1522 VERTICAL RBW:1000.000KHz VBW:0.010KHz SWT:Auto Detector : Peak Project : 940905-02</p>

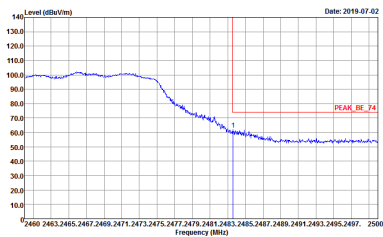
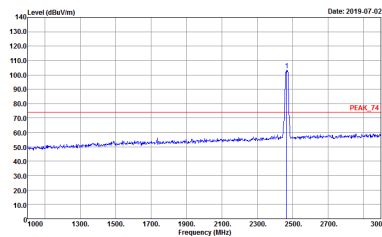
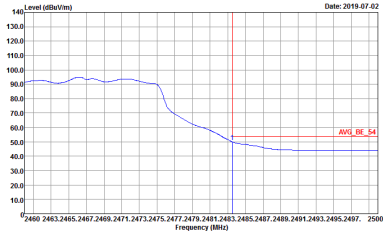
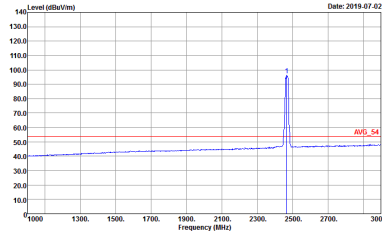

WIFI	2.4GHz 2400~2483.5MHz Band Edge @ 3m	
ANT	802.11g CH12 2467MHz	
1+2	Horizontal	Fundamental
<p>Peak</p>	 <p>Date: 2019-07-02</p> <p>Site : 03CH16-HY Condition : PEAK_BE_74 3m 91200_1522 HORIZONTAL : RBW:1000.000KHz VBW:3000.000KHz SWT:Auto Detector : Peak Project : 940905-02</p>	 <p>Date: 2019-07-02</p> <p>Site : 03CH16-HY Condition : PEAK_74 3m 91200_1522 HORIZONTAL : RBW:1000.000KHz VBW:3000.000KHz SWT:Auto Detector : Peak Project : 940905-02</p>
<p>Avg.</p>	 <p>Date: 2019-07-02</p> <p>Site : 03CH16-HY Condition : AVG_BE_54 3m 91200_1522 HORIZONTAL : RBW:1000.000KHz VBW:0.010KHz SWT:Auto Detector : Peak Project : 940905-02</p>	 <p>Date: 2019-07-02</p> <p>Site : 03CH16-HY Condition : AVG_54 3m 91200_1522 HORIZONTAL : RBW:1000.000KHz VBW:0.010KHz SWT:Auto Detector : Peak Project : 940905-02</p>

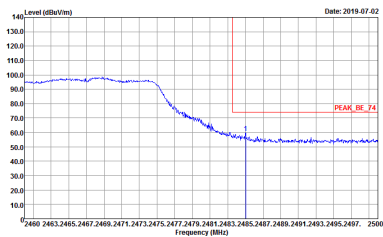
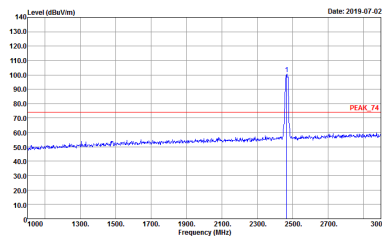
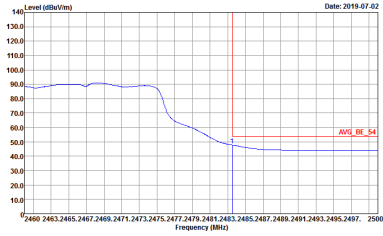
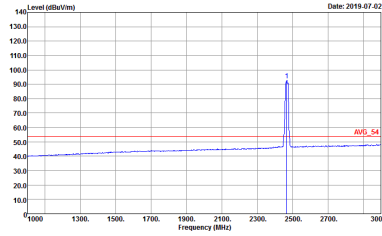

WIFI	2.4GHz 2400~2483.5MHz Band Edge @ 3m	
ANT	802.11g CH12 2467MHz	
1+2	Vertical	Fundamental
Peak	 <p>Site : 03CH16-HY Condition : PEAK_BE_74 3m 91200_1522 VERTICAL : RBW:1000.000KHz VBW:3000.000KHz SWT:Auto Detector : Peak Project : 940905-02</p>	 <p>Site : 03CH16-HY Condition : PEAK_74 3m 91200_1522 VERTICAL : RBW:1000.000KHz VBW:3000.000KHz SWT:Auto Detector : Peak Project : 940905-02</p>
Avg.	 <p>Site : 03CH16-HY Condition : AVG_BE_54 3m 91200_1522 VERTICAL : RBW:1000.000KHz VBW:0.010KHz SWT:Auto Detector : Peak Project : 940905-02</p>	 <p>Site : 03CH16-HY Condition : AVG_54 3m 91200_1522 VERTICAL : RBW:1000.000KHz VBW:0.010KHz SWT:Auto Detector : Peak Project : 940905-02</p>

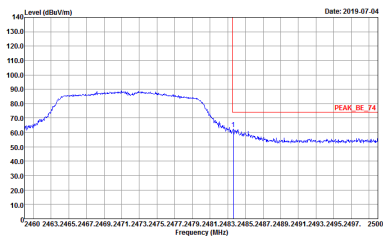
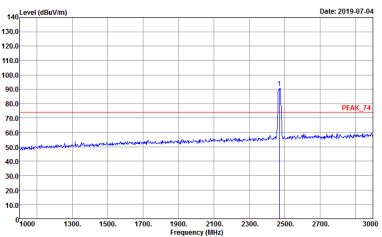
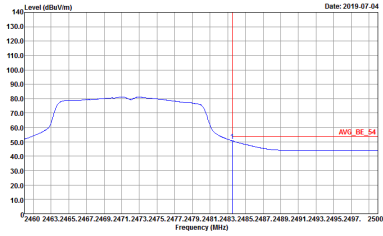
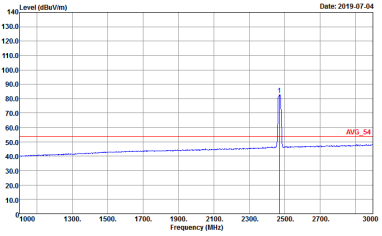

WIFI	2.4GHz 2400~2483.5MHz Band Edge @ 3m	
ANT	802.11g CH13 2472MHz	
1+2	Horizontal	Fundamental
Peak	 <p>Date: 2019-07-04</p> <p>Site : 03CH16-HY Condition : PEAK_BE_74 3m 91200_1522 HORIZONTAL RBW:1000.000KHz VBW:3000.000KHz SWT:Auto Detector : Peak Project : 940905-02 Setting : 0x02</p>	 <p>Date: 2019-07-04</p> <p>Site : 03CH16-HY Condition : PEAK_74 3m 91200_1522 HORIZONTAL RBW:1000.000KHz VBW:3000.000KHz SWT:Auto Detector : Peak Project : 940905-02 Setting : 0x02</p>
Avg.	 <p>Date: 2019-07-04</p> <p>Site : 03CH16-HY Condition : AVG_BE_54 3m 91200_1522 HORIZONTAL RBW:1000.000KHz VBW:0.010KHz SWT:Auto Detector : Peak Project : 940905-02 Setting : 0x02</p>	 <p>Date: 2019-07-04</p> <p>Site : 03CH16-HY Condition : AVG_54 3m 91200_1522 HORIZONTAL RBW:1000.000KHz VBW:0.010KHz SWT:Auto Detector : Peak Project : 940905-02 Setting : 0x02</p>



WIFI	2.4GHz 2400~2483.5MHz Band Edge @ 3m	
ANT	802.11g CH13 2472MHz	
1+2	Vertical	Fundamental
Peak	<p>Site : 03CH16-HY Condition : PEAK_BE_74 3m 91200_1522 VERTICAL Detector : Peak Project : 940905-02 Setting : 0x02</p>	<p>Site : 03CH16-HY Condition : PEAK_74 3m 91200_1522 VERTICAL Detector : Peak Project : 940905-02 Setting : 0x02</p>
Avg.	<p>Site : 03CH16-HY Condition : AVG_BE_54 3m 91200_1522 VERTICAL Detector : Peak Project : 940905-02 Setting : 0x02</p>	<p>Site : 03CH16-HY Condition : AVG_54 3m 91200_1522 VERTICAL Detector : Peak Project : 940905-02 Setting : 0x02</p>

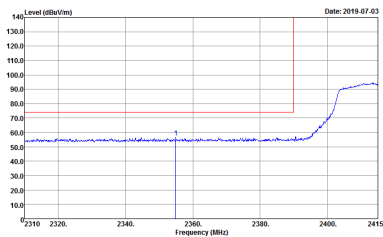
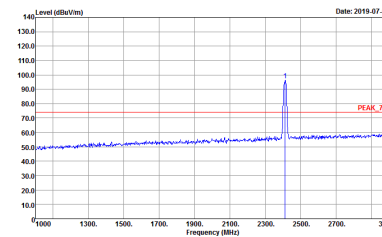
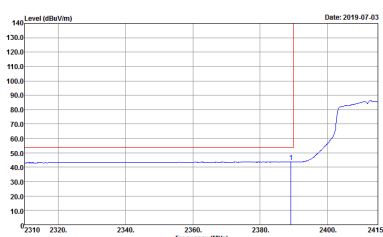
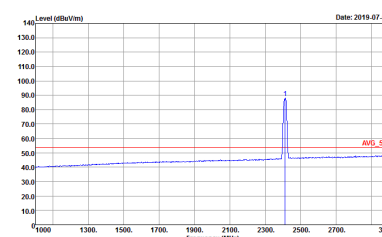

2.4GHz 2400~2483.5MHz
WIFI 802.11n HT20 (Band Edge @ 3m)

WIFI	2.4GHz 2400~2483.5MHz Band Edge @ 3m	
ANT	802.11n HT20 CH01 2412MHz	
1+2	Horizontal	Fundamental
Peak	 <p>Site : 03CH16-HY Condition : PEAK_BE_74 3m 91200_1522 HORIZONTAL RBW:1000.000KHz VBW:3000.000KHz SWT:Auto Detector : Peak Project : 940905-02</p>	 <p>Site : 03CH16-HY Condition : PEAK_74 3m 91200_1522 HORIZONTAL RBW:1000.000KHz VBW:3000.000KHz SWT:Auto Detector : Peak Project : 940905-02</p>
Avg.	 <p>Site : 03CH16-HY Condition : AVG_BE_54 3m 91200_1522 HORIZONTAL RBW:1000.000KHz VBW:0.010KHz SWT:Auto Detector : Peak Project : 940905-02</p>	 <p>Site : 03CH16-HY Condition : AVG_54 3m 91200_1522 HORIZONTAL RBW:1000.000KHz VBW:0.010KHz SWT:Auto Detector : Peak Project : 940905-02</p>

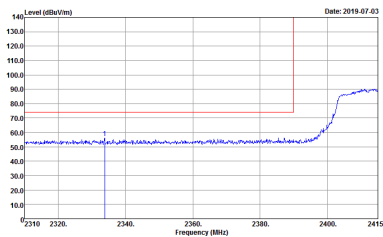
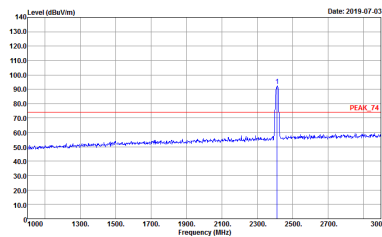
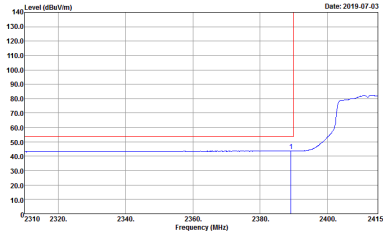
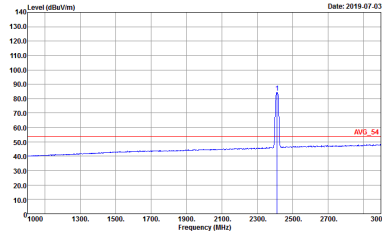

WIFI	2.4GHz 2400~2483.5MHz Band Edge @ 3m	
ANT	802.11n HT20 CH01 2412MHz	
1+2	Vertical	Fundamental
Peak	 <p>Site : 03CH16-HY Condition : PEAK_BE_74 3m 91200_1522 VERTICAL Detector : Peak Project : 940905-02</p>	 <p>Site : 03CH16-HY Condition : PEAK_74 3m 91200_1522 VERTICAL Detector : Peak Project : 940905-02</p>
Avg.	 <p>Site : 03CH16-HY Condition : AVG_BE_54 3m 91200_1522 VERTICAL Detector : Peak Project : 940905-02</p>	 <p>Site : 03CH16-HY Condition : AVG_54 3m 91200_1522 VERTICAL Detector : Peak Project : 940905-02</p>

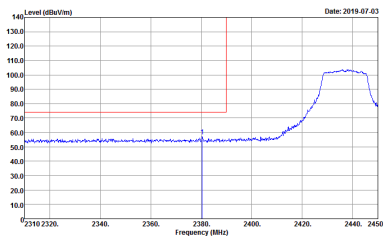
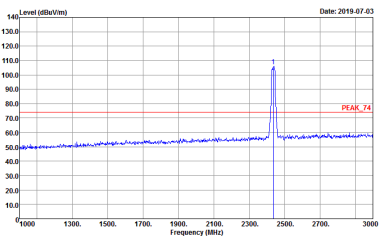
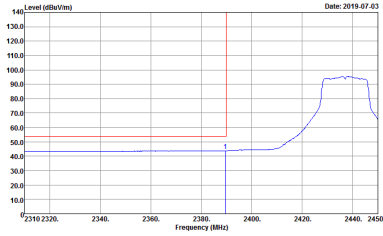
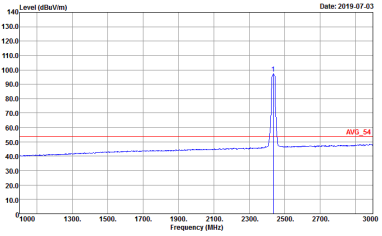

WIFI	2.4GHz 2400~2483.5MHz Band Edge @ 3m	
ANT	802.11n HT20 CH06 2437MHz - L	
1+2	Horizontal	Fundamental
Peak	 <p>Site : 03CH16-HY Condition : PEAK_BE_74 3m 91200_1522 HORIZONTAL RBW:1000.000KHz VBW:3000.000KHz SWT:Auto Detector : Peak Project : 940905-02</p>	 <p>Site : 03CH16-HY Condition : PEAK_74 3m 91200_1522 HORIZONTAL RBW:1000.000KHz VBW:3000.000KHz SWT:Auto Detector : Peak Project : 940905-02</p>
Avg.	 <p>Site : 03CH16-HY Condition : AVG_BE_54 3m 91200_1522 HORIZONTAL RBW:1000.000KHz VBW:3000.000KHz SWT:Auto Detector : Peak Project : 940905-02</p>	 <p>Site : 03CH16-HY Condition : AVG_54 3m 91200_1522 HORIZONTAL RBW:1000.000KHz VBW:3000.000KHz SWT:Auto Detector : Peak Project : 940905-02</p>

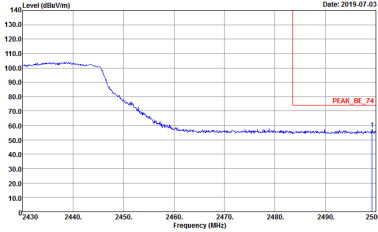
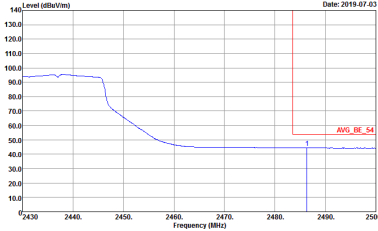

WIFI	2.4GHz 2400~2483.5MHz Band Edge @ 3m	
ANT	802.11n HT20 CH06 2437MHz - R	
1+2	Horizontal	Fundamental
<p>Peak</p>	 <p>Site : 03CH16-HY Condition : PEAK_BE_74 3m 91200_1522 HORIZONTAL Detector : Peak Project : 940905-02</p>	<p>Left blank</p>
<p>Avg.</p>	 <p>Site : 03CH16-HY Condition : AVG_BE_54 3m 91200_1522 HORIZONTAL Detector : Peak Project : 940905-02</p>	<p>Left blank</p>



WIFI	2.4GHz 2400~2483.5MHz Band Edge @ 3m	
ANT	802.11n HT20 CH06 2437MHz - L	
1+2	Vertical	Fundamental
Peak	<p>Site : 03CH16-HY Condition : PEAK_BE_74 3m 91200_1522 VERTICAL : RBW:1000.000KHz VBW:3000.000KHz SWT:Auto Detector : Peak Project : 940905-02</p>	<p>Site : 03CH16-HY Condition : PEAK_74 3m 91200_1522 VERTICAL : RBW:1000.000KHz VBW:3000.000KHz SWT:Auto Detector : Peak Project : 940905-02</p>
Avg.	<p>Site : 03CH16-HY Condition : AVG_BE_54 3m 91200_1522 VERTICAL : RBW:1000.000KHz VBW:3000.000KHz SWT:Auto Detector : Peak Project : 940905-02</p>	<p>Site : 03CH16-HY Condition : AVG_54 3m 91200_1522 VERTICAL : RBW:1000.000KHz VBW:3000.000KHz SWT:Auto Detector : Peak Project : 940905-02</p>

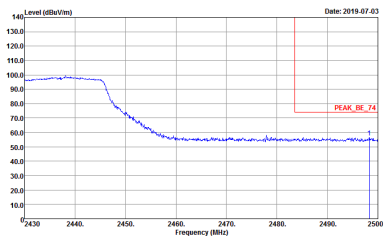
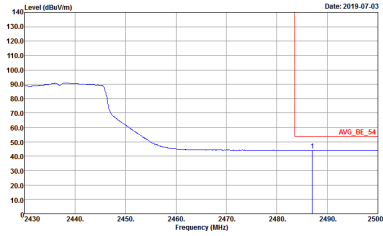

WIFI	2.4GHz 2400~2483.5MHz Band Edge @ 3m	
ANT	802.11n HT20 CH06 2437MHz - R	
1+2	Vertical	Fundamental
<p>Peak</p>	 <p>Site : 03CH16-HY Condition : PEAK_BE_74 3m 91200_1522 VERTICAL Detector : Peak Project : 940905-02</p>	<p>Left Blank</p>
<p>Avg.</p>	 <p>Site : 03CH16-HY Condition : AVG_BE_54 3m 91200_1522 VERTICAL Detector : Peak Project : 940905-02</p>	<p>Left Blank</p>

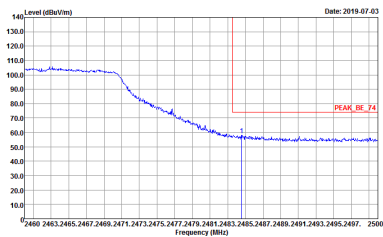
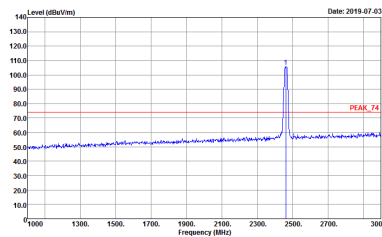
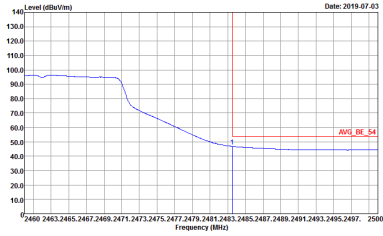
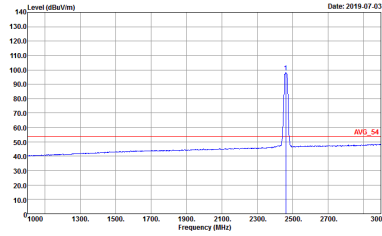

WIFI	2.4GHz 2400~2483.5MHz Band Edge @ 3m	
ANT	802.11n HT20 CH11 2462MHz	
1+2	Horizontal	Fundamental
Peak	 <p>Site : 03CH16-HY Condition : PEAK_BE_74 3m 91200_1522 HORIZONTAL : RBW:1000.000KHz VBW:3000.000KHz SWT:Auto Detector : Peak Project : 940905-02</p>	 <p>Site : 03CH16-HY Condition : PEAK_74 3m 91200_1522 HORIZONTAL : RBW:1000.000KHz VBW:3000.000KHz SWT:Auto Detector : Peak Project : 940905-02</p>
Avg.	 <p>Site : 03CH16-HY Condition : AVG_BE_54 3m 91200_1522 HORIZONTAL : RBW:1000.000KHz VBW:0.010KHz SWT:Auto Detector : Peak Project : 940905-02</p>	 <p>Site : 03CH16-HY Condition : AVG_54 3m 91200_1522 HORIZONTAL : RBW:1000.000KHz VBW:0.010KHz SWT:Auto Detector : Peak Project : 940905-02</p>

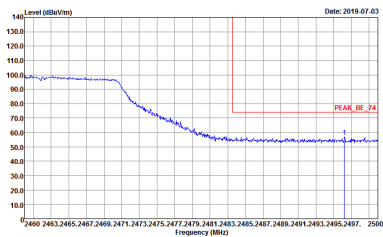
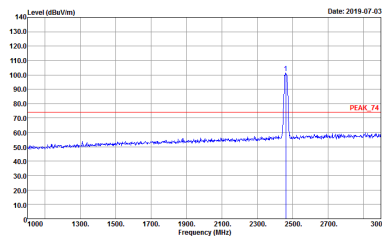
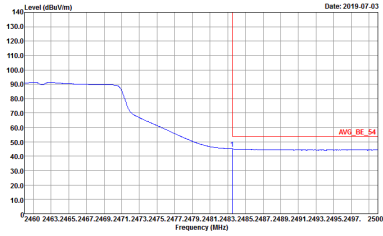
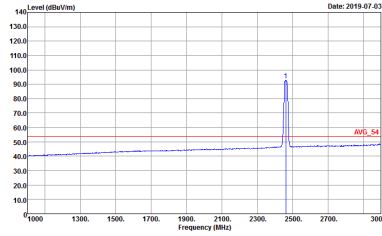

WIFI	2.4GHz 2400~2483.5MHz Fundamental @ 3m	
ANT	802.11n HT20 CH11 2462MHz	
1+2	Vertical	Fundamental
Peak	 <p>Site : 03CH16-HY Condition : PEAK_BE_74 3m 91200_1522 VERTICAL RBW:1000.000KHz VBW:3000.000KHz SWT:Auto Detector : Peak Project : 940905-02</p>	 <p>Site : 03CH16-HY Condition : PEAK_74 3m 91200_1522 VERTICAL RBW:1000.000KHz VBW:3000.000KHz SWT:Auto Detector : Peak Project : 940905-02</p>
Avg.	 <p>Site : 03CH16-HY Condition : AVG_BE_54 3m 91200_1522 VERTICAL RBW:1000.000KHz VBW:0.010KHz SWT:Auto Detector : Peak Project : 940905-02</p>	 <p>Site : 03CH16-HY Condition : AVG_54 3m 91200_1522 VERTICAL RBW:1000.000KHz VBW:0.010KHz SWT:Auto Detector : Peak Project : 940905-02</p>

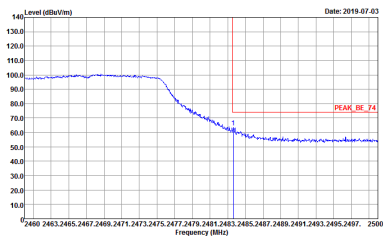
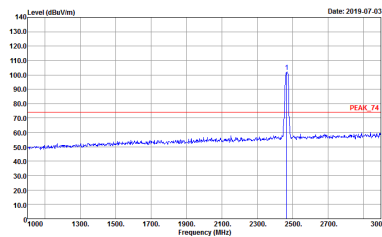
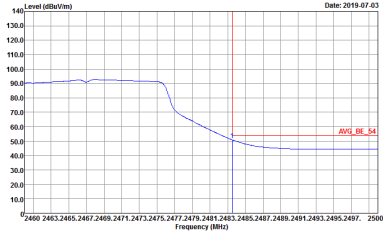
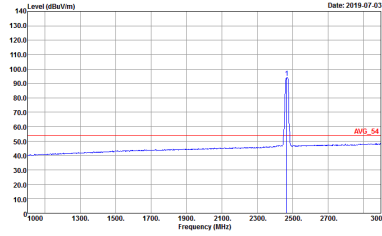

WIFI	2.4GHz 2400~2483.5MHz Band Edge @ 3m	
ANT	802.11n HT20 CH12 2467MHz	
1+2	Horizontal	Fundamental
Peak	 <p>Site : 03CH16-HY Condition : PEAK_BE_74 3m 91200_1522 HORIZONTAL RBW:1000.000KHz VBW:3000.000KHz SWT:Auto Detector : Peak Project : 940905-02</p>	 <p>Site : 03CH16-HY Condition : PEAK_74 3m 91200_1522 HORIZONTAL RBW:1000.000KHz VBW:3000.000KHz SWT:Auto Detector : Peak Project : 940905-02</p>
Avg.	 <p>Site : 03CH16-HY Condition : AVG_BE_54 3m 91200_1522 HORIZONTAL RBW:1000.000KHz VBW:0.010KHz SWT:Auto Detector : Peak Project : 940905-02</p>	 <p>Site : 03CH16-HY Condition : AVG_54 3m 91200_1522 HORIZONTAL RBW:1000.000KHz VBW:0.010KHz SWT:Auto Detector : Peak Project : 940905-02</p>

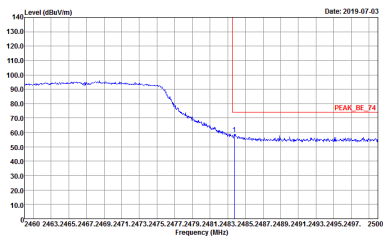
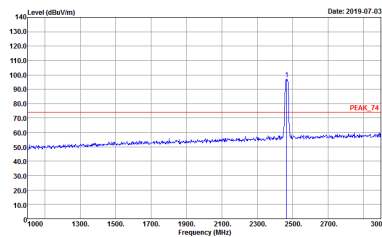
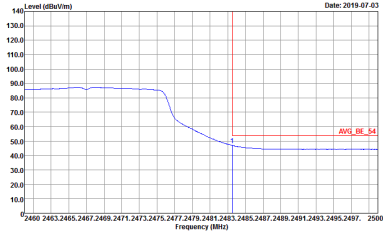
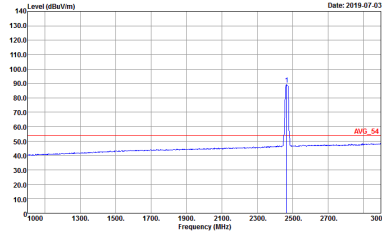

WIFI	2.4GHz 2400~2483.5MHz Band Edge @ 3m	
ANT	802.11n HT20 CH12 2467MHz	
1+2	Vertical	Fundamental
Peak	 <p>Site : 03CH16-HY Condition : PEAK_BE_74 3m 91200_1522 VERTICAL RBW:1000.000KHz VBW:3000.000KHz SWT:Auto Detector : Peak Project : 940905-02</p>	 <p>Site : 03CH16-HY Condition : PEAK_74 3m 91200_1522 VERTICAL RBW:1000.000KHz VBW:3000.000KHz SWT:Auto Detector : Peak Project : 940905-02</p>
Avg.	 <p>Site : 03CH16-HY Condition : AVG_BE_54 3m 91200_1522 VERTICAL RBW:1000.000KHz VBW:0.010KHz SWT:Auto Detector : Peak Project : 940905-02</p>	 <p>Site : 03CH16-HY Condition : AVG_54 3m 91200_1522 VERTICAL RBW:1000.000KHz VBW:0.010KHz SWT:Auto Detector : Peak Project : 940905-02</p>

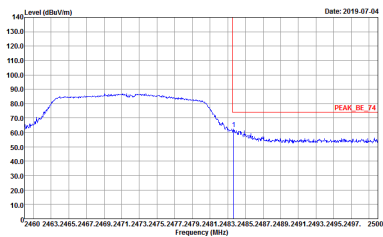
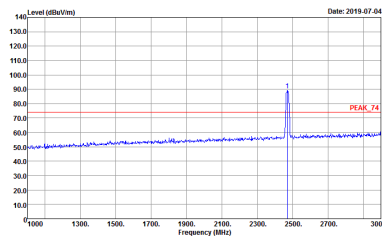
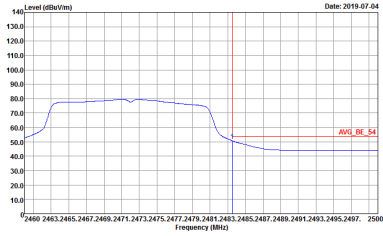
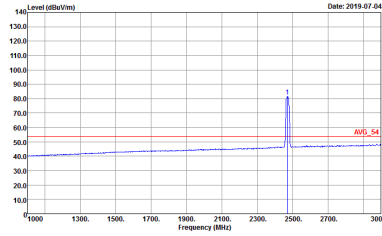

WIFI	2.4GHz 2400~2483.5MHz Band Edge @ 3m	
ANT	802.11n HT20 CH13 2472MHz	
1+2	Horizontal	Fundamental
<p>Peak</p>	 <p>Site : 03CH16-HY Condition : PEAK_BE_74 3m 91200_1522 HORIZONTAL RBW:1000.000KHz VBW:3000.000KHz SWT:Auto Detector : Peak Project : 940905-02 Setting : 0x03</p>	 <p>Site : 03CH16-HY Condition : PEAK_74 3m 91200_1522 HORIZONTAL RBW:1000.000KHz VBW:3000.000KHz SWT:Auto Detector : Peak Project : 940905-02 Setting : 0x03</p>
<p>Avg.</p>	 <p>Site : 03CH16-HY Condition : AVG_BE_54 3m 91200_1522 HORIZONTAL RBW:1000.000KHz VBW:0.010KHz SWT:Auto Detector : Peak Project : 940905-02 Setting : 0x03</p>	 <p>Site : 03CH16-HY Condition : AVG_54 3m 91200_1522 HORIZONTAL RBW:1000.000KHz VBW:0.010KHz SWT:Auto Detector : Peak Project : 940905-02 Setting : 0x03</p>

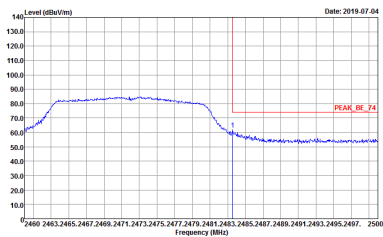
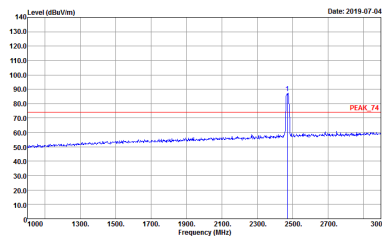
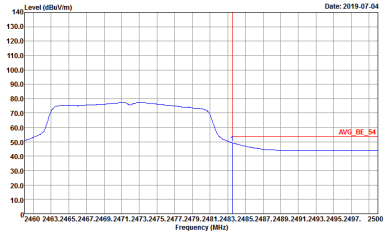
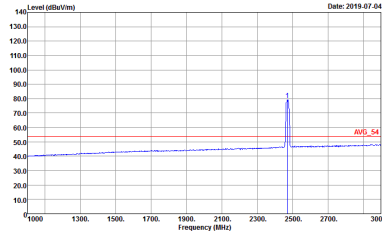

WIFI	2.4GHz 2400~2483.5MHz Band Edge @ 3m	
ANT	802.11n HT20 CH13 2472MHz	
1+2	Vertical	Fundamental
Peak	 <p>Date: 2019-07-04</p> <p>Site : 03CH16-HY Condition : PEAK_BE_74 3m 91200_1522 VERTICAL RBW:1000.000KHz VBW:3000.000KHz SWT:Auto Detector : Peak Project : 940905-02 Setting : 0x03</p>	 <p>Date: 2019-07-04</p> <p>Site : 03CH16-HY Condition : PEAK_74 3m 91200_1522 VERTICAL RBW:1000.000KHz VBW:3000.000KHz SWT:Auto Detector : Peak Project : 940905-02 Setting : 0x03</p>
Avg.	 <p>Date: 2019-07-04</p> <p>Site : 03CH16-HY Condition : AVG_BE_54 3m 91200_1522 VERTICAL RBW:1000.000KHz VBW:0.010KHz SWT:Auto Detector : Peak Project : 940905-02 Setting : 0x03</p>	 <p>Date: 2019-07-04</p> <p>Site : 03CH16-HY Condition : AVG_54 3m 91200_1522 VERTICAL RBW:1000.000KHz VBW:0.010KHz SWT:Auto Detector : Peak Project : 940905-02 Setting : 0x03</p>



2.4GHz 2400~2483.5MHz
WIFI 802.11b (Harmonic @ 3m)

WIFI	2.4GHz 2400~2483.5MHz Harmonic @ 3m	
ANT	802.11b CH01 2412MHz	
1+2	Horizontal	Vertical
Peak Avg.	<p>Site : 03CH16-11Y Condition : PEAK_74 3m 9120D_1522 HORIZONTAL Detector : Peak Project : 940905-02</p>	<p>Site : 03CH16-11Y Condition : PEAK_74 3m 9120D_1522 VERTICAL Detector : Peak Project : 940905-02</p>

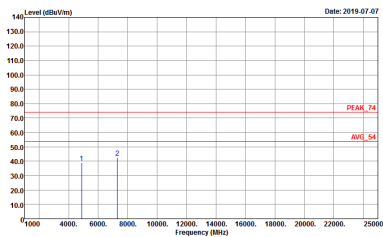
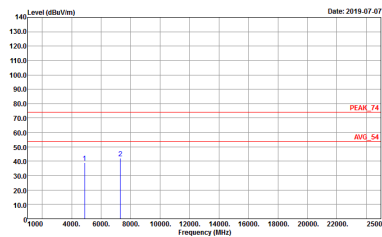

WIFI	2.4GHz 2400~2483.5MHz Harmonic @ 3m	
ANT	802.11b CH06 2437MHz	
1+2	Horizontal	Vertical
<p>Peak</p> <p>Avg.</p>	 <p>Site : 03CH16-11Y Condition : PEAK_74 3m 91200_1522 HORIZONTAL Detector : Peak Project : 940905-02</p>	 <p>Site : 03CH16-11Y Condition : PEAK_74 3m 91200_1522 VERTICAL Detector : Peak Project : 940905-02</p>



WIFI	2.4GHz 2400~2483.5MHz Harmonic @ 3m	
ANT	802.11b CH11 2462MHz	
1+2	Horizontal	Vertical
Peak Avg.	<p>Site : 03CH16-11Y Condition : PEAK_74 3m 91200_1522 HORIZONTAL Detector : Peak Project : 940905-02</p>	<p>Site : 03CH16-11Y Condition : PEAK_74 3m 91200_1522 VERTICAL Detector : Peak Project : 940905-02</p>



WIFI	2.4GHz 2400~2483.5MHz Harmonic @ 3m	
ANT	802.11b CH12 2467MHz	
1+2	Horizontal	Vertical
Peak Avg.	<p>Site : 03CH16-11Y Condition : PEAK_74 3m 91200_1522 HORIZONTAL Detector : Peak Project : 940905-02</p>	<p>Site : 03CH16-11Y Condition : PEAK_74 3m 91200_1522 VERTICAL Detector : Peak Project : 940905-02</p>



WIFI	2.4GHz 2400~2483.5MHz Harmonic @ 3m	
ANT	802.11b CH13 2472MHz	
1+2	Horizontal	Vertical
Peak Avg.	<p>Site : 03CH16-11Y Condition : PEAK_74 3m 91200_1522 HORIZONTAL Detector : Peak Project : 940905-02</p>	<p>Site : 03CH16-11Y Condition : PEAK_74 3m 91200_1522 VERTICAL Detector : Peak Project : 940905-02</p>



2.4GHz 2400~2483.5MHz
WIFI 802.11g (Harmonic @ 3m)

WIFI	2.4GHz 2400~2483.5MHz Harmonic @ 3m	
ANT	802.11g CH01 2412MHz	
1+2	Horizontal	Vertical
Peak Avg.	<p>Site : 03CH16-11Y Condition : PEAK_74 3m 9120D_1522 HORIZONTAL Detector : Peak Project : 940905-02</p>	<p>Site : 03CH16-11Y Condition : PEAK_74 3m 9120D_1522 VERTICAL Detector : Peak Project : 940905-02</p>



WIFI	2.4GHz 2400~2483.5MHz Harmonic @ 3m	
ANT	802.11g CH06 2437MHz	
1+2	Horizontal	Vertical
Peak Avg.	<p>Site : 03CH16-11Y Condition : PEAK_74 3m 91200_1522 HORIZONTAL Detector : Peak Project : 940905-02</p>	<p>Site : 03CH16-11Y Condition : PEAK_74 3m 91200_1522 VERTICAL Detector : Peak Project : 940905-02</p>



WIFI	2.4GHz 2400~2483.5MHz Harmonic @ 3m	
ANT	802.11g CH11 2462MHz	
1+2	Horizontal	Vertical
Peak Avg.	<p>Site : 03CH16-11Y Condition : PEAK_74 3m 91200_1522 HORIZONTAL Detector : Peak Project : 940905-02</p>	<p>Site : 03CH16-11Y Condition : PEAK_74 3m 91200_1522 VERTICAL Detector : Peak Project : 940905-02</p>



WIFI	2.4GHz 2400~2483.5MHz Harmonic @ 3m	
ANT	802.11g CH12 2467MHz	
1+2	Horizontal	Vertical
Peak Avg.	<p>Site : 03CH16-11Y Condition : PEAK_74 3m 91200_1522 HORIZONTAL Detector : Peak Project : 940905-02</p>	<p>Site : 03CH16-11Y Condition : PEAK_74 3m 91200_1522 VERTICAL Detector : Peak Project : 940905-02</p>



WIFI	2.4GHz 2400~2483.5MHz Harmonic @ 3m	
ANT	802.11g CH13 2472MHz	
1+2	Horizontal	Vertical
Peak Avg.	<p>Site : 03CH16-11Y Condition : PEAK_74 3m 91200_1522 HORIZONTAL Detector : Peak Project : 940905-02</p>	<p>Site : 03CH16-11Y Condition : PEAK_74 3m 91200_1522 VERTICAL Detector : Peak Project : 940905-02</p>



2.4GHz 2400~2483.5MHz
WIFI 802.11n HT20 (Harmonic @ 3m)

WIFI	2.4GHz 2400~2483.5MHz Harmonic @ 3m	
ANT	802.11n HT20 CH01 2412MHz	
1+2	Horizontal	Vertical
Peak Avg.	<p>Site : 03CH16-11Y Condition : PEAK_74 3m 9120D_1522 HORIZONTAL Detector : Peak Project : 940905-02</p>	<p>Site : 03CH16-11Y Condition : PEAK_74 3m 9120D_1522 VERTICAL Detector : Peak Project : 940905-02</p>



WIFI	2.4GHz 2400~2483.5MHz Harmonic @ 3m	
ANT	802.11n HT20 CH06 2437MHz	
1+2	Horizontal	Vertical
Peak Avg.	<p>Site : 03CH16-11Y Condition : PEAK_74 3m 91200_1522 HORIZONTAL Detector : Peak Project : 940905-02</p>	<p>Site : 03CH16-11Y Condition : PEAK_74 3m 91200_1522 VERTICAL Detector : Peak Project : 940905-02</p>

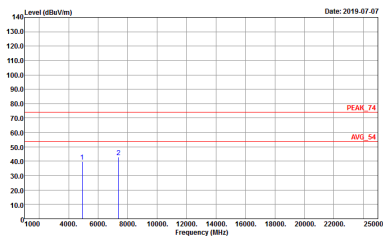
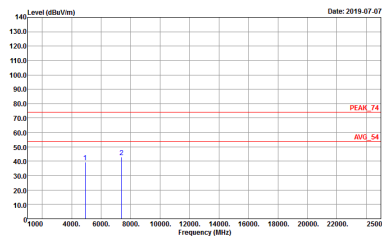

WIFI	2.4GHz 2400~2483.5MHz Harmonic @ 3m	
ANT	802.11n HT20 CH11 2462MHz	
1+2	Horizontal	Vertical
<p>Peak</p> <p>Avg.</p>	 <p>Site : 03CH16-11Y Condition : PEAK_74 3m 91200_1522 HORIZONTAL Detector : Peak Project : 940905-02</p>	 <p>Site : 03CH16-11Y Condition : PEAK_74 3m 91200_1522 VERTICAL Detector : Peak Project : 940905-02</p>



WIFI	2.4GHz 2400~2483.5MHz Harmonic @ 3m	
ANT	802.11n HT20 CH12 2462MHz	
1+2	Horizontal	Vertical
Peak	<p>Site : 03CH16-11Y Condition : PEAK_74 3m 91200_1522 HORIZONTAL Detector : Peak Project : 940905-02</p>	<p>Site : 03CH16-11Y Condition : PEAK_74 3m 91200_1522 VERTICAL Detector : Peak Project : 940905-02</p>
Avg.		



WIFI	2.4GHz 2400~2483.5MHz Harmonic @ 3m	
ANT	802.11n HT20 CH13 2472MHz	
1+2	Horizontal	Vertical
Peak Avg.	<p>Site : 03CH16-11Y Condition : PEAK_74 3m 91200_1522 HORIZONTAL Detector : Peak Project : 940905-02</p>	<p>Site : 03CH16-11Y Condition : PEAK_74 3m 91200_1522 VERTICAL Detector : Peak Project : 940905-02</p>



Emission below 1GHz
2.4GHz WIFI 802.11n HT20 (LF)

WIFI	2.4GHz 2400~2483.5MHz	
ANT	802.11n HT20 LF	
1+2	Horizontal	Vertical
QP / Peak	<p>Site : 03CH16-HY Condition : QP 3m BIL06_47020606 HORIZONTAL Detector : Peak Project : 940905-02 Setting : 0x3</p>	<p>Site : 03CH16-HY Condition : QP 3m BIL06_47020606 VERTICAL Detector : Peak Project : 940905-02 Setting : 0x3</p>



Appendix E. Duty Cycle Plots

Antenna	Band	Duty Cycle(%)	T(us)	1/T(kHz)	VBW Setting	Duty Factor(dB)
1	802.11b	99.51	-	-	10Hz	0.02
2	802.11b	99.19	-	-	10Hz	0.04
1+2	802.11b for Ant. 1	99.39	-	-	10Hz	0.03
1+2	802.11b for Ant. 2	99.11	-	-	10Hz	0.04
1	802.11g	98.06	-	-	10Hz	0.09
2	802.11g	98.06	-	-	10Hz	0.09
1+2	802.11g for Ant. 1	98.31	-	-	10Hz	0.07
1+2	802.11g for Ant. 2	98.06	-	-	10Hz	0.09
1	2.4GHz 802.11n HT20	98.62	-	-	10Hz	0.06
2	2.4GHz 802.11n HT20	98.62	-	-	10Hz	0.06
1+2	2.4GHz 802.11n HT20 for Ant. 1	99.62	-	-	10Hz	0.02
1+2	2.4GHz 802.11n HT20 for Ant. 2	99.30	-	-	10Hz	0.03



<Ant. 1>

802.11b

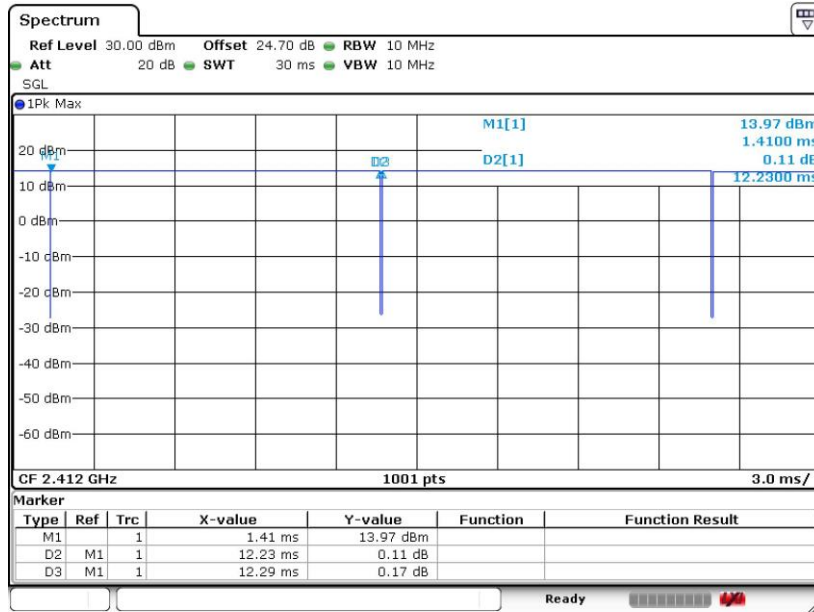

Date: 17 JUN 2019 18:54:28

802.11g

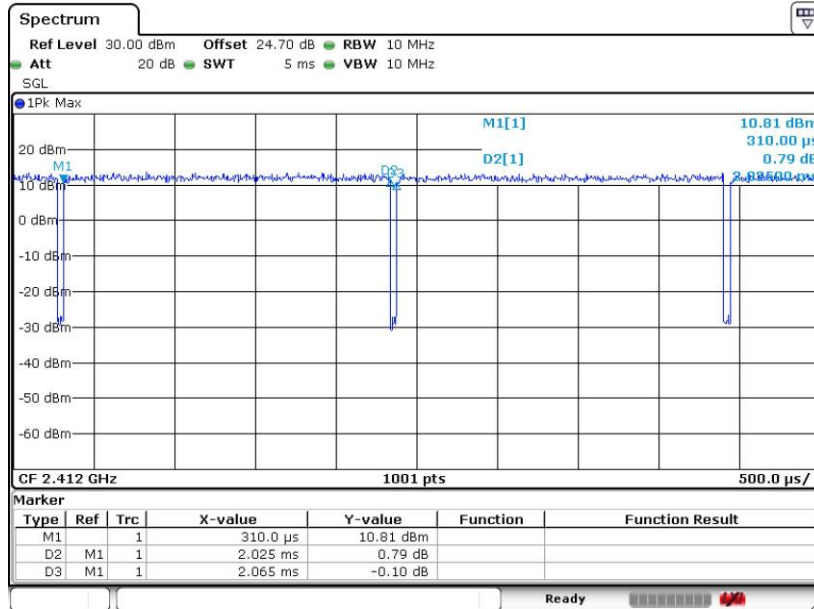

Date: 17 JUN 2019 19:09:34



802.11n HT20

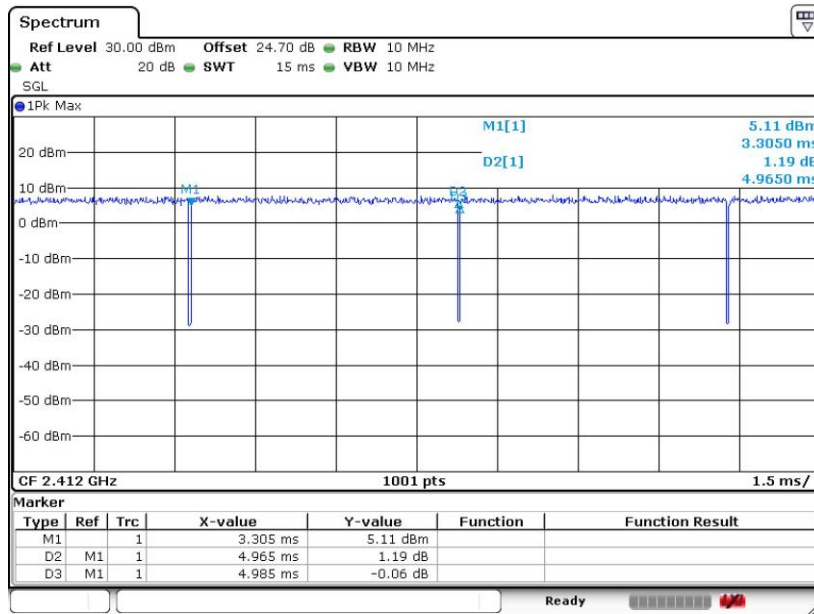

Date: 17 JUN 2019 19:34:35

<Ant. 2>

802.11b

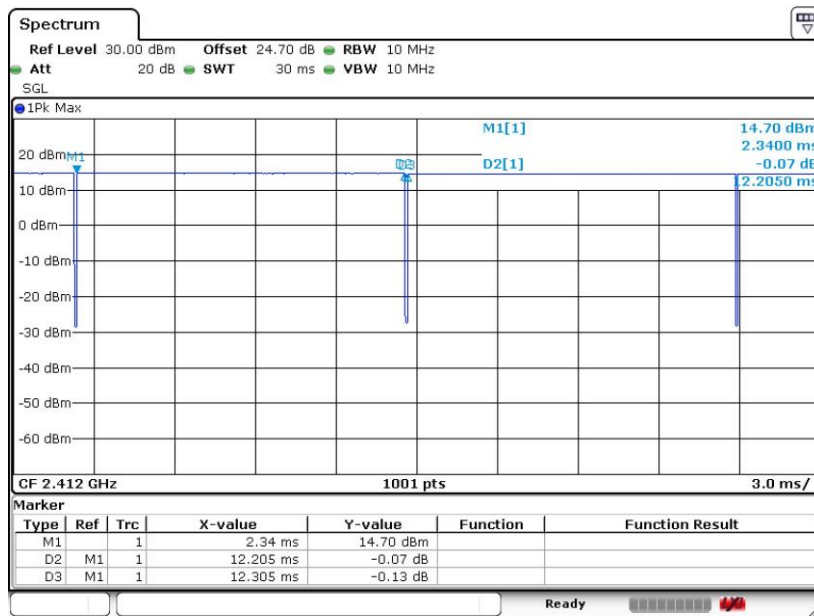

Date: 17 JUN 2019 18:55:34



802.11g

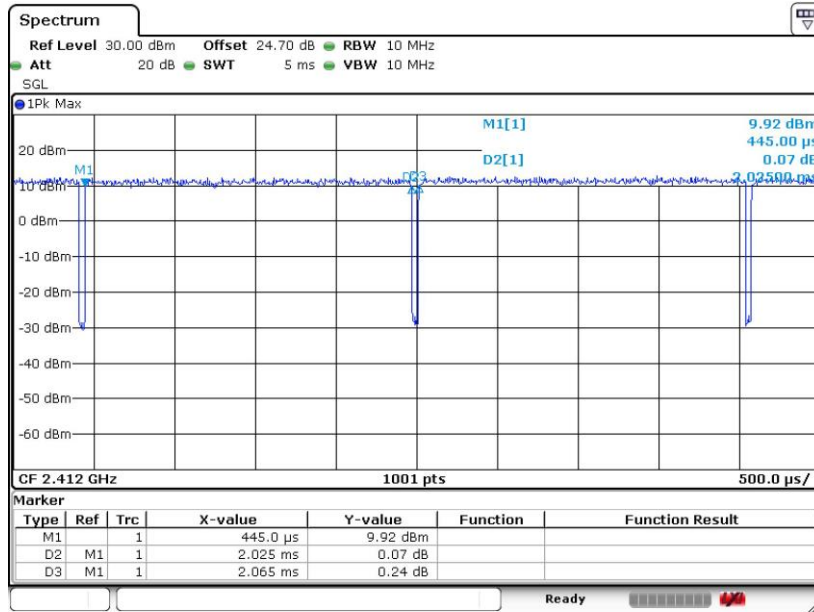

Date: 17 JUN 2019 19:26:18

802.11n HT20

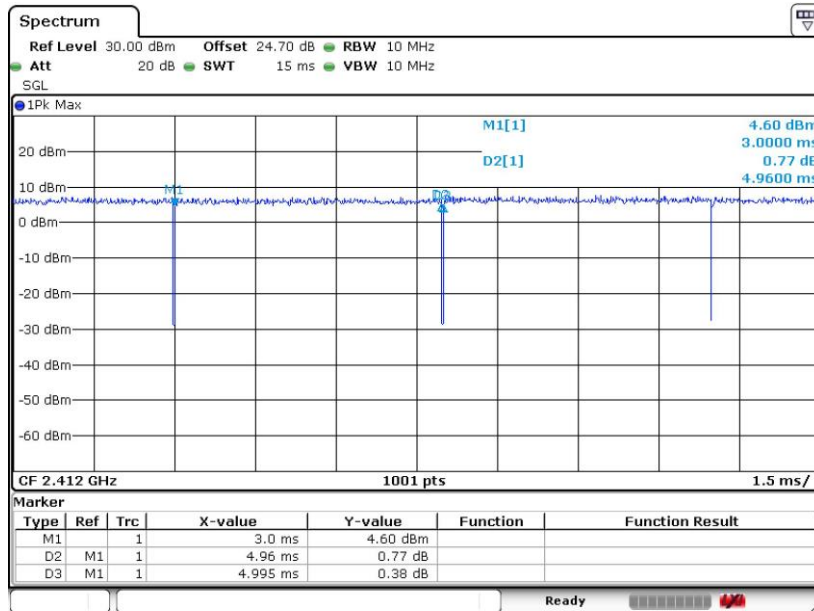

Date: 17 JUN 2019 19:35:46



MIMO <Ant. 1>

802.11b

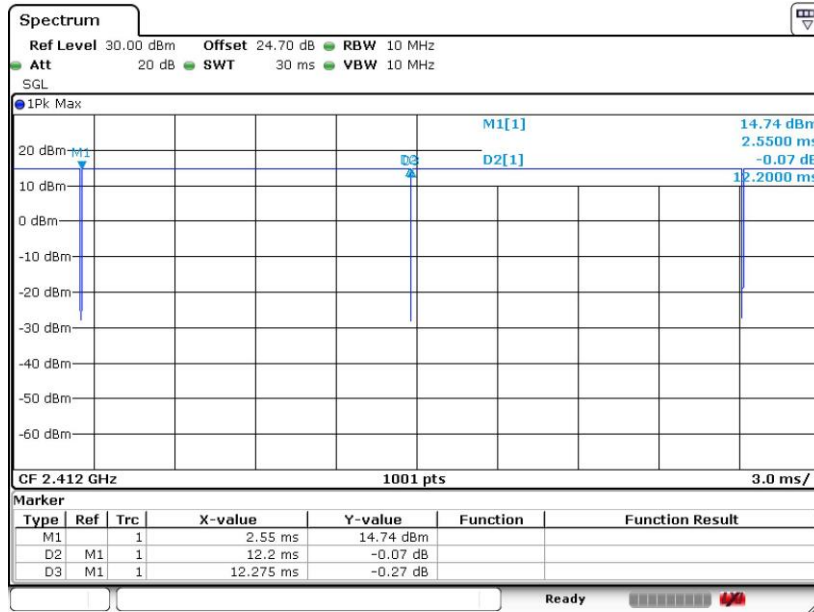

Date: 17 JUN 2019 18:56:38

802.11g

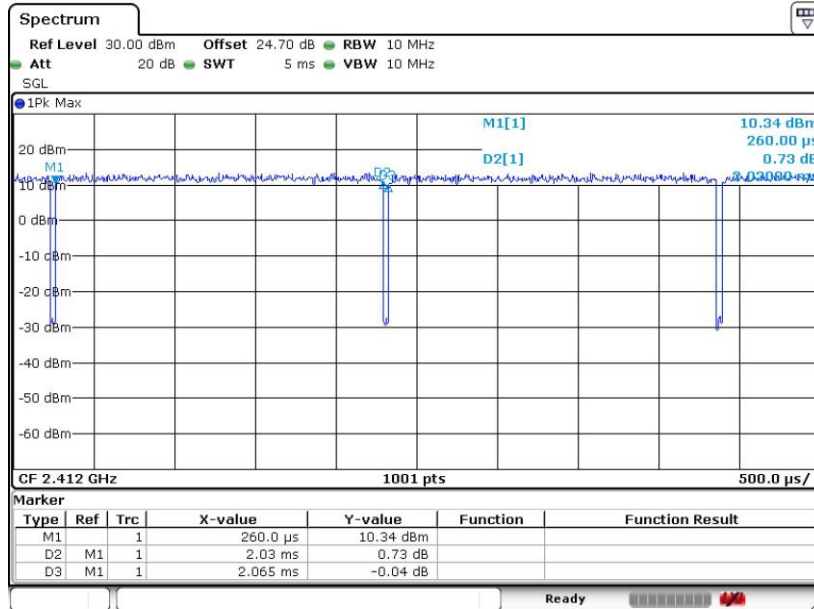

Date: 17 JUN 2019 19:29:08



802.11n HT20

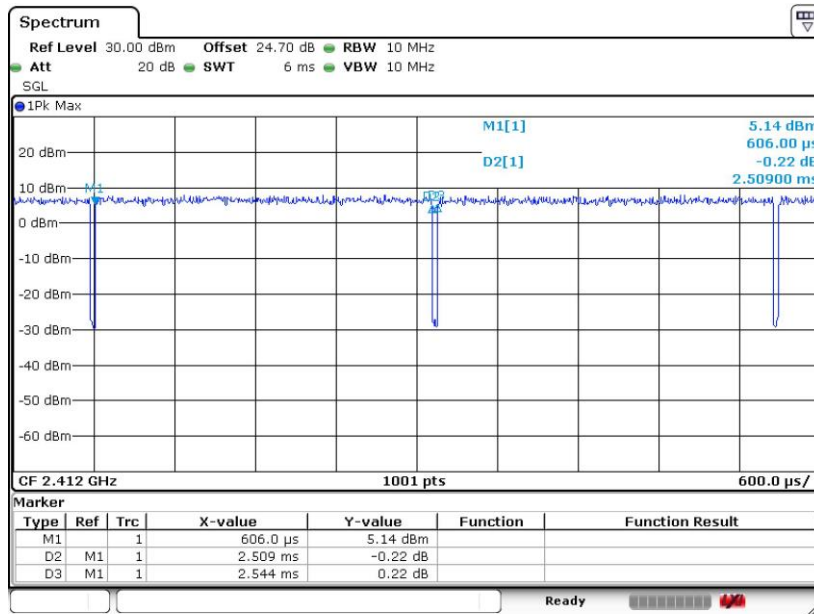

Date: 17 JUN 2019 19:31:59

MIMO <Ant. 2>

802.11b

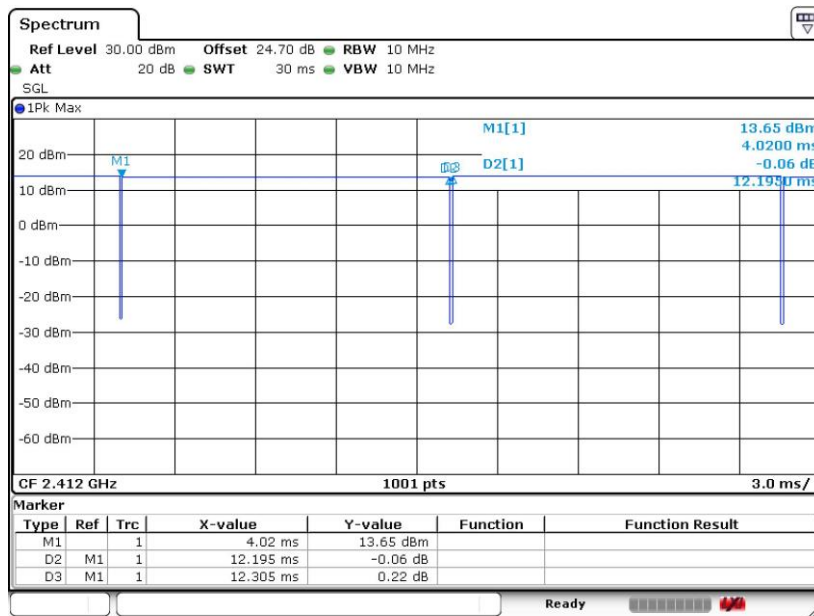

Date: 17 JUN 2019 19:02:03



802.11g

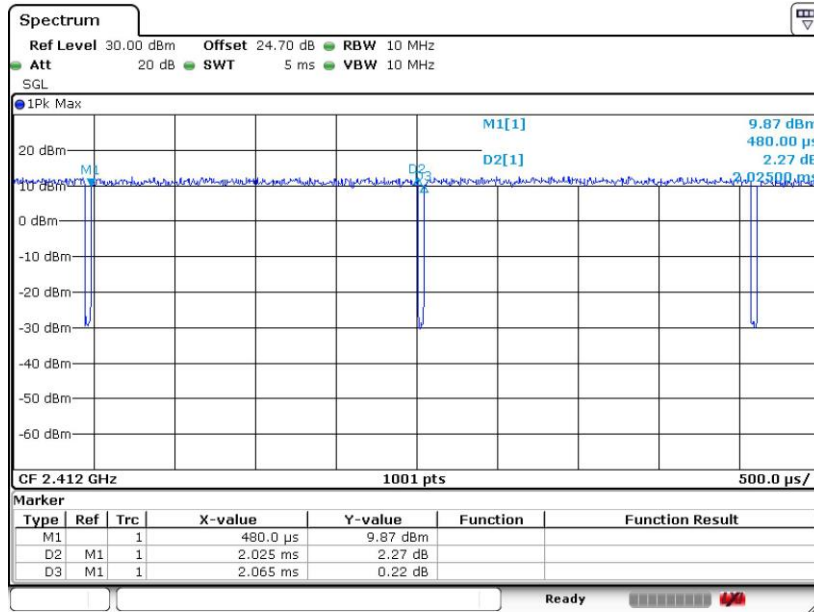

Date: 17 JUN 2019 19:30:32

802.11n HT20

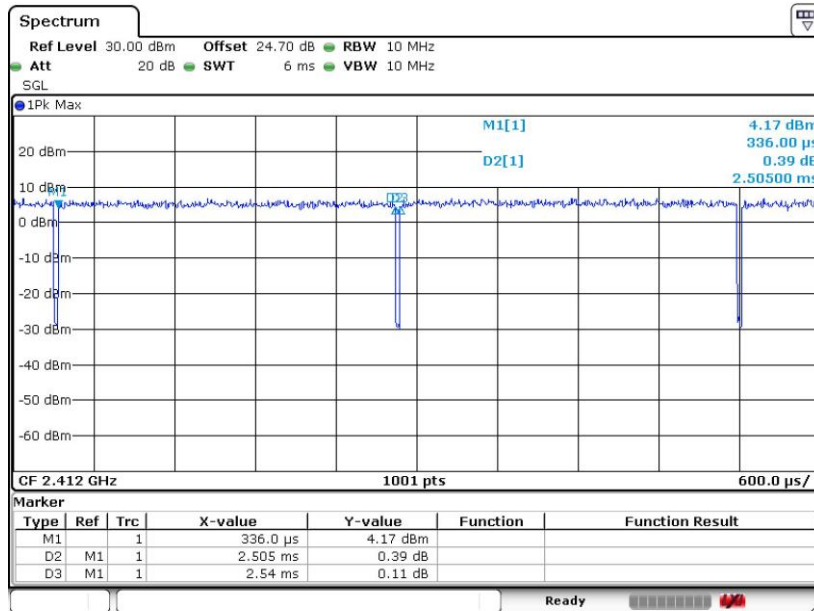

Date: 17 JUN 2019 19:33:10

—————THE END—————