



FCC RADIO TEST REPORT

FCC ID : PY7-01875J
Equipment : GSM/WCDMA/LTE Phone with BT, DTS/UNII
a/b/g/n/ac, GPS and NFC
Brand Name : Sony
Applicant : Sony Mobile Communications Inc.
4-12-3 Higashi-Shinagawa, Shinagawa-ku,
Tokyo, 140-0002, Japan
Manufacturer : Sony Mobile Communications Inc.
4-12-3 Higashi-Shinagawa, Shinagawa-ku,
Tokyo, 140-0002, Japan
Standard : FCC Part 15 Subpart C §15.247

The product was received on Jun. 04, 2019 and testing was started from Jun. 30, 2019 and completed on Jul. 12, 2019. We, SPORTON INTERNATIONAL INC. EMC & Wireless Communications Laboratory, would like to declare that the tested sample has been evaluated in accordance with the test procedures and has been in compliance with the applicable technical standards.

The report must not be used by the client to claim product certification, approval, or endorsement by TAF or any agency of government.

The test results in this spot check data report apply exclusively to the tested model / sample. Without written approval of SPORTON INTERNATIONAL INC. EMC & Wireless Communications Laboratory, the test report shall not be reproduced except in full.

Approved by: Jones Tsai

SPORTON INTERNATIONAL INC. EMC & Wireless Communications Laboratory
No. 52, Huaya 1st Rd., Guishan Dist., Taoyuan City, Taiwan (R.O.C.)



Table of Contents

History of this test report3

Summary of Test Result4

1 General Description5

 1.1 Product Feature of Equipment Under Test.....5

 1.2 Modification of EUT.....5

 1.3 Testing Location.....6

 1.4 Applicable Standards6

2 Test Configuration of Equipment Under Test7

 2.1 Carrier Frequency and Channel7

 2.2 Test Mode7

 2.3 Connection Diagram of Test System.....8

 2.4 EUT Operation Test Setup8

3 Test Result.....9

 3.1 Output Power Measurement.....9

 3.2 Radiated Band Edges and Spurious Emission Measurement10

 3.3 Antenna Requirements14

4 List of Measuring Equipment15

5 Uncertainty of Evaluation17

Appendix A. Conducted Test Results

Appendix B. Radiated Spurious Emission

Appendix C. Radiated Spurious Emission Plots

Appendix D. Duty Cycle Plots



Summary of Test Result

Report Clause	Ref Std. Clause	Test Items	Result (PASS/FAIL)	Remark
-	15.247(a)(2)	6dB Bandwidth	Not Required	-
-	2.1049	99% Occupied Bandwidth	Not Required	-
3.1	15.247(b)	Power Output Measurement	Pass	-
-	15.247(e)	Power Spectral Density	Not Required	-
-	15.247(d)	Conducted Band Edges	Not Required	-
		Conducted Spurious Emission	Not Required	-
3.2	15.247(d)	Radiated Band Edges and Radiated Spurious Emission	Pass	Under limit 3.76 dB at 2483.520 MHz
-	15.207	AC Conducted Emission	Not Required	-
3.3	15.203 & 15.247(b)	Antenna Requirement	Pass	-

Remark:

1. Not required means after assessing, test items are not necessary to carry out.
2. This is a spot check data report and data performed in appendix of this report are chosen from the worst case of the original FCC ID report. All the test cases were performed on original report which can be referred to Sporton Report Number FR940905-02C.

Declaration of Conformity:

The test results with all measurement uncertainty excluded are presented in accordance with the regulation limits or requirements declared by manufacturers.

Comments and Explanations:

The declared of product specification for EUT presented in the report are provided by the manufacturer, and the manufacturer takes all the responsibilities for the accuracy of product specification.

Reviewed by: Wii Chang

Report Producer: Yimin Ho



1 General Description

1.1 Product Feature of Equipment Under Test

GSM/WCDMA/LTE, Bluetooth, DTS/UNII a/b/g/n/ac, NFC, and GNSS.

Standards-related Product Specification	
Antenna Type / Gain	<Ant. 1>: Loop Antenna with gain -2.1 dBi <Ant. 2>: Monopole Antenna with gain -6.8 dBi

EUT Information List			
HW Version	SW Version	S/N	Performed Test Item
A	0_77003_A_28_2	BH9300AMH4	RF conducted measurement
	1.25	BH9300FYH4	Radiated Spurious Emission

Accessory List	
AC Adapter	Model Name : UCH32
	S/N: 6218W30200106
Earphone	Model Name.: MH750
	S/N : N/A
USB Cable	Model Name.: UCB24
	S/N : N/A
2 in 1 USB Audio Cable	Model Name.: EC270
	S/N : N/A

Note:

1. Above EUT list used are electrically identical per declared by manufacturer.
2. Above the accessories list are used to exercise the EUT during test, and the serial number of each type of accessories is listed in each section of this report. .
3. For other wireless features of this EUT, test report will be issued separately.
4. The antenna 1 and antenna 2 in this test report are equivalent to WLAN chain 0 and chain 1 in Antenna Specification by manufacturer.
5. The firmware installed in the EUT during testing was 0_77003_A_28_2.

1.2 Modification of EUT

No modifications are made to the EUT during all test items.



1.3 Testing Location

Test Site	SPORTON INTERNATIONAL INC. EMC & Wireless Communications Laboratory
Test Site Location	No.52, Huaya 1st Rd., Guishan Dist., Taoyuan City, Taiwan (R.O.C.) TEL: +886-3-327-3456 FAX: +886-3-328-4978
Test Site No.	Sporton Site No.
	TH05-HY

Note: The test site complies with ANSI C63.4 2014 requirement.

Test Site	SPORTON INTERNATIONAL INC. EMC & Wireless Communications Laboratory
Test Site Location	No.58, Aly. 75, Ln. 564, Wenhua 3rd, Rd., Guishan Dist., Taoyuan City, Taiwan (R.O.C.) TEL: +886-3-327-0868 FAX: +886-3-327-0855
Test Site No.	Sporton Site No.
	03CH16-HY

Note: The test site complies with ANSI C63.4 2014 requirement.

FCC Designation No.: TW1190 and TW0007

1.4 Applicable Standards

According to the specifications of the manufacturer, the EUT must comply with the requirements of the following standards:

- ♦ FCC Part 15 Subpart C §15.247
- ♦ FCC KDB Publication No. 558074 D01 DTS Meas. Guidance v05r02
- ♦ FCC KDB 414788 D01 Radiated Test Site v01r01.
- ♦ FCC KDB 662911 D01 Multiple Transmitter Output v02r01.
- ♦ ANSI C63.10-2013

Remark:

1. All test items were verified and recorded according to the standards and without any deviation during the test.
2. This EUT has also been tested and complied with the requirements of FCC Part 15, Subpart B, recorded in a separate test report.



2 Test Configuration of Equipment Under Test

- a. The EUT has been associated with peripherals and configuration operated in a manner tended to maximize its emission characteristics in a typical application. Frequency range investigated: radiation emission (9 kHz to the 10th harmonic of the highest fundamental frequency or to 40 GHz, whichever is lower). For radiated measurement, pre-scanned in three orthogonal panels, X, Y, Z and Accessory. The worst cases (X plane with Adapter) were recorded in this report.

2.1 Carrier Frequency and Channel

Frequency Band	Channel	Freq. (MHz)	Channel	Freq. (MHz)
2400-2483.5 MHz	1	2412	8	2447
	2	2417	9	2452
	3	2422	10	2457
	4	2427	11	2462
	5	2432	12	2467
	6	2437	13	2472
	7	2442		

2.2 Test Mode

Final test modes are considering the modulation and worse data rates as below table.

Modulation	Data Rate
802.11b	1 Mbps
802.11n HT20	MCS0

2.3 Connection Diagram of Test System

<WLAN Tx Mode>

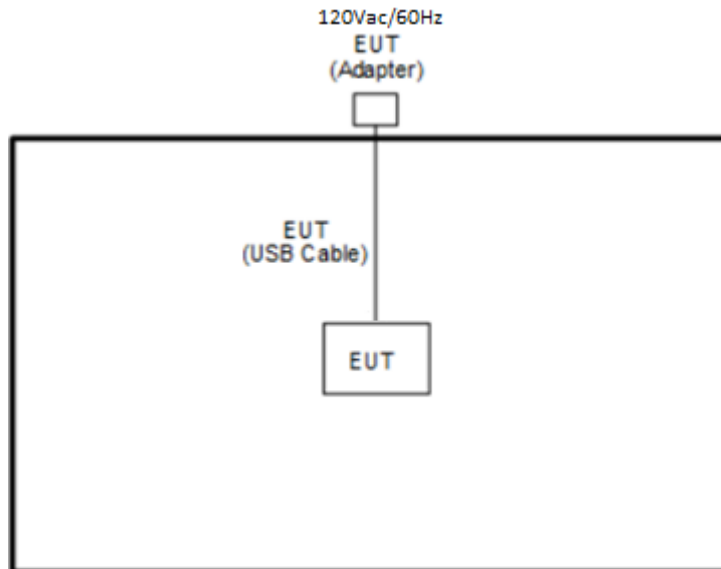

2.4 EUT Operation Test Setup

The RF test items, utility “Tera Term” was installed in Notebook which was programmed in order to make the EUT get into the engineering modes to provide channel selection, power level, data rate and the application type and for continuous transmitting signals.

3 Test Result

3.1 Output Power Measurement

3.1.1 Limit of Output Power

For systems using digital modulation in the 2400-2483.5MHz, the limit for peak output power is 30dBm. If transmitting antenna with directional gain greater than 6dBi is used, the peak output power from the intentional radiator shall be reduced below the above stated value by the amount in dB that the directional gain of the antenna exceeds 6 dBi. In case of point-to-point operation, the limit has to be reduced by 1dB for every 3dB that the directional gain of the antenna exceeds 6dBi.

3.1.2 Measuring Instruments

See list of measuring equipment of this test report.

3.1.3 Test Procedures

1. For Average Power, the testing follows ANSI C63.10 Section 11.9.2.3.2 Method AVGPM-G.
2. The RF output of EUT was connected to the power meter by RF cable and attenuator. The path loss was compensated to the results for each measurement.
3. Set to the maximum power setting and enable the EUT transmit continuously.
4. Measure the conducted output power and record the results in the test report.
5. For MIMO mode, calculation method follows FCC KDB 662911 D01 Multiple Transmitter Output v02r01.

3.1.4 Test Setup

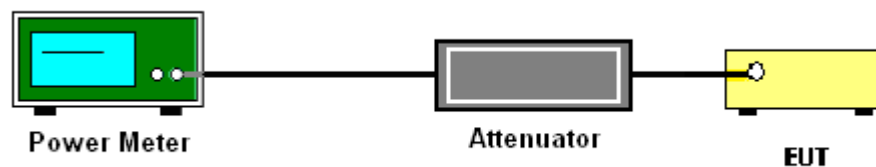

3.1.5 Test Result of Average output Power

Please refer to Appendix A.



3.2 Radiated Band Edges and Spurious Emission Measurement

3.2.1 Limit of Radiated band edge and Spurious Emission Measurement

In any 100 kHz bandwidth outside the intentional radiator frequency band, all harmonics/spurious must be at least 20 dB below the highest emission level within the authorized band. If the output power of this device was measured by spectrum analyzer, the attenuation under this paragraph shall be 30 dB instead of 20 dB. In addition, radiated emissions which fall in the restricted bands must also comply with the limits as below.

Frequency (MHz)	Field Strength (microvolts/meter)	Measurement Distance (meters)
0.009 – 0.490	2400/F(kHz)	300
0.490 – 1.705	24000/F(kHz)	30
1.705 – 30.0	30	30
30 – 88	100	3
88 – 216	150	3
216 - 960	200	3
Above 960	500	3

3.2.2 Measuring Instruments

See list of measuring equipment of this test report.



3.2.3 Test Procedures

1. The testing follows the ANSI C63.10 Section 11.12.1 Radiated emission measurements.
2. The EUT was arranged to its worst case and then tune the antenna tower (from 1 m to 4 m) and turntable (from 0 degree to 360 degrees) to find the maximum reading. A pre-amp and a high pass filter are used for the test in order to get better signal level.
3. The EUT was placed on a turntable with 0.8 meter for frequency below 1GHz and 1.5 meter for frequency above 1GHz respectively above ground.
4. The EUT was set 3 meters from the interference receiving antenna, which was mounted on the top of a variable height antenna tower.
5. Corrected Reading: Antenna Factor + Cable Loss + Read Level - Preamp Factor = Level
6. For testing below 1GHz, if the emission level of the EUT in peak mode was 3 dB lower than the limit specified, then peak values of EUT will be reported, otherwise, the emissions will be repeated one by one using the CISPR quasi-peak method and reported.
7. For testing above 1GHz, the emission level of the EUT in peak mode was 20dB lower than average limit (that means the emission level in average mode also complies with the limit in average mode), then peak values of EUT will be reported, otherwise, the emissions will be measured in average mode again and reported.
8. Use the following spectrum analyzer settings:
 - (1) Span shall wide enough to fully capture the emission being measured;
 - (2) Set RBW=100 kHz for $f < 1$ GHz; VBW \geq RBW; Sweep = auto; Detector function = peak; Trace = max hold;
 - (3) Set RBW = 1 MHz, VBW= 3MHz for $f \geq 1$ GHz for peak measurement.
For average measurement:
 - VBW = 10 Hz, when duty cycle is no less than 98 percent.
 - VBW $\geq 1/T$, when duty cycle is less than 98 percent where T is the minimum transmission duration over which the transmitter is on and is transmitting at its maximum power control level for the tested mode of operation.

3.2.4 Test Setup

For radiated emissions below 30MHz

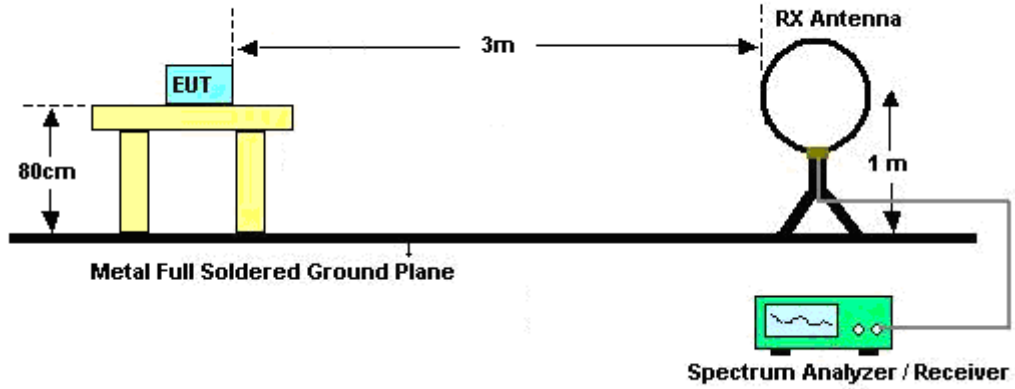

For radiated emissions from 30MHz to 1GHz

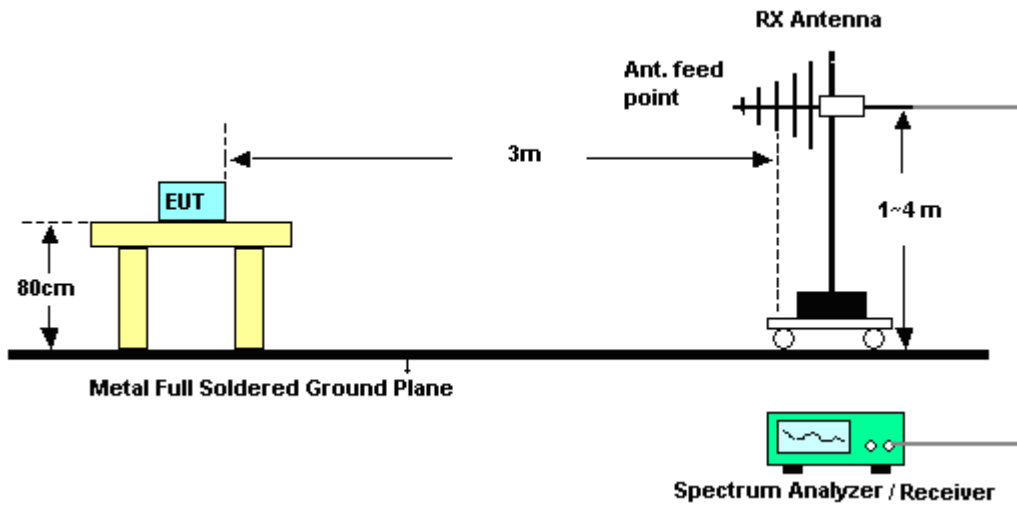

For radiated emissions above 1GHz

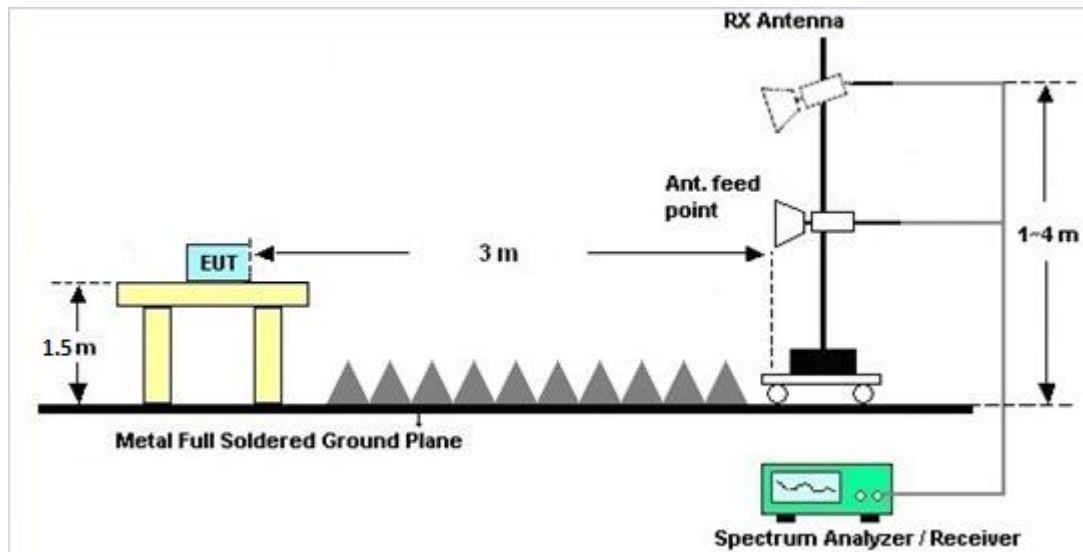

3.2.5 Test Results of Radiated Spurious Emissions (9kHz ~ 30MHz)

The low frequency, which started from 9 kHz to 30MHz, was pre-scanned and the result which was 20dB lower than the limit line was not reported.

There is a comparison data of both open-field test site and alternative test site - semi-Anechoic chamber according to 414788 D01 Radiated Test Site v01r01, and the result came out very similar.

3.2.6 Test Result of Radiated Spurious at Band Edges

Please refer to Appendix B and C.

3.2.7 Duty Cycle

Please refer to Appendix D.

3.2.8 Test Result of Radiated Spurious Emission (30MHz ~ 10th Harmonic)

Please refer to Appendix B and C.



3.3 Antenna Requirements

3.3.1 Standard Applicable

If directional gain of transmitting Antennas is greater than 6dBi, the power shall be reduced by the same level in dB comparing to gain minus 6dBi. The use of a permanently attached Antenna or of an Antenna that uses a unique coupling to the intentional radiator shall be considered sufficient to comply with the rule.

3.3.2 Antenna Anti-Replacement Construction

An embedded-in antenna design is used.

3.3.3 Antenna Gain

<CDD Modes >

FCC KDB 662911 D01 Multiple Transmitter Output v02r01

For CDD transmissions, directional gain is calculated as

Directional gain = G_{ANT} + Array Gain, where Array Gain is as follows.

For power spectral density (PSD) measurements on all devices,

Array Gain = $10 \log(N_{ANT}/N_{SS}=1)$ dB.

For power measurements on IEEE 802.11 devices,

Array Gain = 0 dB (i.e., no array gain) for $N_{ANT} \leq 4$.

Directional gain may be calculated by using the formulas applicable to equal gain antennas with G_{ANT} set equal to the gain of the antenna having the highest gain;

The EUT supports CDD mode.

For power, the directional gain G_{ANT} is set equal to the antenna having the highest gain, i.e., F)2)f)i).

For PSD, the directional gain calculation is following F)2)f)ii) of KDB 662911 D01 v02r01.

The power and PSD limit should be modified if the directional gain of EUT is over 6 dBi,

The directional gain "DG" is calculated as following table.

<CDD Modes>						
			DG	DG	Power	PSD
			for	for	Limit	Limit
	Ant. 1	Ant. 2	Power	PSD	Reduction	Reduction
	(dBi)	(dBi)	(dBi)	(dBi)	(dB)	(dB)
2.4 GHz	-2.10	-6.80	-2.10	-1.13	0.00	0.00

$Power\ Limit\ Reduction = DG(Power) - 6dBi, (min = 0)$

$PSD\ Limit\ Reduction = DG(PSD) - 6dBi, (min = 0)$



4 List of Measuring Equipment

Instrument	Manufacturer	Model No.	Serial No.	Characteristics	Calibration Date	Test Date	Due Date	Remark
Hygrometer	Testo	DTM-303A	TP157075	N/A	Nov. 05, 2018	Jun. 30, 2019	Nov. 04, 2019	Conducted (TH05-HY)
Power Sensor	DARE	RPR3006W	13I00030SN O32	9kHz~6GHz	Dec. 03, 2018	Jun. 30, 2019	Dec. 02, 2019	Conducted (TH05-HY)
Spectrum Analyzer	Rohde & Schwarz	FSV40	101397	10Hz~40GHz	Nov. 13, 2018	Jun. 30, 2019	Nov. 12, 2019	Conducted (TH05-HY)
Switch Box & RF Cable	EM	EMSW18	SW1070903	N/A	Dec. 19, 2018	Jun. 30, 2019	Dec. 18, 2019	Conducted (TH05-HY)
Loop Antenna	Rohde & Schwarz	HFH2-Z2	100315	9 kHz~30 MHz	Jan. 11, 2019	Jul. 11, 2019~ Jul. 12, 2019	Jan. 10, 2020	Radiation (03CH16-HY)
Bilog Antenna	TESEQ	CBL6111D& 00802N1D0 1N-06	47020&06	30MHz to 1GHz	Oct. 13, 2018	Jul. 11, 2019~ Jul. 12, 2019	Oct. 12, 2019	Radiation (03CH16-HY)
Horn Antenna	SCHWARZBE CK	BBHA 9120 D	9120D-1522	1G~18GHz	Sep. 07, 2018	Jul. 11, 2019~ Jul. 12, 2019	Sep. 06, 2019	Radiation (03CH16-HY)
SHF-EHF Horn Antenna	SCHWARZBE CK	BBHA 9170	BBHA91702 51	18GHz ~ 40GHz	Nov. 20, 2018	Jul. 11, 2019~ Jul. 12, 2019	Nov. 19, 2019	Radiation (03CH16-HY)
Amplifier	SONOMA	310N	371607	9kHz~1000MHz	Oct. 02, 2018	Jul. 11, 2019~ Jul. 12, 2019	Oct. 01, 2019	Radiation (03CH16-HY)
Preamplifier	Jet-Power	JPA0118-55- 303	1710001800 055007	1GHz~18GHz	Apr. 01, 2019	Jul. 11, 2019~ Jul. 12, 2019	Mar. 31, 2020	Radiation (03CH16-HY)
Preamplifier	Keysight	83017A	MY5327026 4	1GHz~26.5GHz	Dec. 12, 2018	Jul. 11, 2019~ Jul. 12, 2019	Dec. 11, 2019	Radiation (03CH16-HY)
Amplifier	MITEQ	TTA1840-35- HG	1871923	18GHz~40GHz, VSWR : 2.5:1 max	Jul. 16, 2018	Jul. 11, 2019~ Jul. 12, 2019	Jul. 15, 2019	Radiation (03CH16-HY)
EMI Test Receiver	Keysight	N9038A (MXE)	MY57290111	3Hz~26.5GHz	Nov. 29, 2018	Jul. 11, 2019~ Jul. 12, 2019	Nov. 28, 2019	Radiation (03CH16-HY)
Spectrum Analyzer	Agilent	N9010A	MY5420048 6	10Hz~44GHz	Oct. 19, 2018	Jul. 11, 2019~ Jul. 12, 2019	Oct. 18, 2019	Radiation (03CH16-HY)
Hygrometer	TECPEL	DTM-303B	TP162965	N/A	Oct. 22, 2018	Jul. 11, 2019~ Jul. 12, 2019	Oct. 21, 2019	Radiation (03CH16-HY)
Filter	Wainwright	WLK4-1000- 1530-8000-4 0SS	SN11	1G Low Pass	Sep. 16, 2018	Jul. 11, 2019~ Jul. 12, 2019	Sep. 15, 2019	Radiation (03CH16-HY)
Filter	Wainwright	WHKX8-587 2.5-6750-18 000-40ST	SN3	6.75 GHz Highpass	Sep. 16, 2018	Jul. 11, 2019~ Jul. 12, 2019	Sep. 15, 2019	Radiation (03CH16-HY)
RF Cable	HUBER + SUHNER	SUCOFLEX 126E	MY1082/26E A	30M-18G	Oct. 15, 2018	Jul. 11, 2019~ Jul. 12, 2019	Oct. 14, 2019	Radiation (03CH16-HY)
RF Cable	HUBER + SUHNER	SUCOFLEX 104	MY15539/4	30M-18G	Feb. 26, 2019	Jul. 11, 2019~ Jul. 12, 2019	Feb. 25, 2020	Radiation (03CH16-HY)
RF Cable	HUBER + SUHNER	SUCOFLEX 104	MY36980/4	30M~18GHz	Apr. 15, 2019	Jul. 11, 2019~ Jul. 12, 2019	Apr. 14, 2020	Radiation (03CH16-HY)



Instrument	Manufacturer	Model No.	Serial No.	Characteristics	Calibration Date	Test Date	Due Date	Remark
Controller	ChainTek	3000-1	N/A	Control Turn table & Ant Mast	N/A	Jul. 11, 2019~ Jul. 12, 2019	N/A	Radiation (03CH16-HY)
Antenna Mast	ChainTek	MBS-520-1	N/A	1m~4m	N/A	Jul. 11, 2019~ Jul. 12, 2019	N/A	Radiation (03CH16-HY)
Turn Table	ChainTek	T-200-S-1	N/A	0~360 Degree	N/A	Jul. 11, 2019~ Jul. 12, 2019	N/A	Radiation (03CH16-HY)
Software	Audix	E3 6.2009-8-24	RK-001136	N/A	N/A	Jul. 11, 2019~ Jul. 12, 2019	N/A	Radiation (03CH16-HY)



5 Uncertainty of Evaluation

Uncertainty of Radiated Emission Measurement (30 MHz ~ 1000 MHz)

Measuring Uncertainty for a Level of Confidence of 95% ($U = 2Uc(y)$)	4.90
---	------

Uncertainty of Radiated Emission Measurement (1000 MHz ~ 18000 MHz)

Measuring Uncertainty for a Level of Confidence of 95% ($U = 2Uc(y)$)	5.80
---	------

Uncertainty of Radiated Emission Measurement (18000 MHz ~ 40000 MHz)

Measuring Uncertainty for a Level of Confidence of 95% ($U = 2Uc(y)$)	3.90
---	------

Appendix A. Test Result of Conducted Test Items

Test Engineer:	CreedWu	Temperature:	21~25	°C
Test Date:	2019/6/30	Relative Humidity:	51~54	%

TEST RESULTS DATA
Average Output Power

2.4GHz Band																
Mod.	Data Rate	N _{TX}	CH.	Freq. (MHz)	Average Conducted Power (dBm)			Conducted Power Limit (dBm)		DG (dBi)		EIRP Power (dBm)		EIRP Power Limit (dBm)		Pass /Fail
					Ant 1	Ant 2	SUM	Ant 1	Ant 2	Ant 1	Ant 2	Ant 1	Ant 2	Ant 1	Ant 2	
11b	1Mbps	1	1	2412	12.30	13.00		30.00	30.00	-2.10	-6.80	10.20	6.20	36.00	36.00	Pass
11b	1Mbps	1	6	2437	12.50	13.00		30.00	30.00	-2.10	-6.80	10.40	6.20	36.00	36.00	Pass
11b	1Mbps	1	11	2462	12.40	13.10		30.00	30.00	-2.10	-6.80	10.30	6.30	36.00	36.00	Pass
11b	1Mbps	1	12	2467	12.20	13.00		30.00	30.00	-2.10	-6.80	10.10	6.20	36.00	36.00	Pass
11b	1Mbps	1	13	2472	10.30	10.60		30.00	30.00	-2.10	-6.80	8.20	3.80	36.00	36.00	Pass
11g	6Mbps	1	1	2412	8.60	8.40		30.00	30.00	-2.10	-6.80	6.50	1.60	36.00	36.00	Pass
11g	6Mbps	1	6	2437	12.20	13.10		30.00	30.00	-2.10	-6.80	10.10	6.30	36.00	36.00	Pass
11g	6Mbps	1	11	2462	12.20	13.30	-	30.00	30.00	-2.10	-6.80	10.10	6.50	36.00	36.00	Pass
11g	6Mbps	1	12	2467	11.10	11.30		30.00	30.00	-2.10	-6.80	9.00	4.50	36.00	36.00	Pass
11g	6Mbps	1	13	2472	0.30	0.10		30.00	30.00	-2.10	-6.80	-1.80	-6.70	36.00	36.00	Pass
HT20	MCS0	1	1	2412	3.10	3.00		30.00	30.00	-2.10	-6.80	1.00	-3.80	36.00	36.00	Pass
HT20	MCS0	1	6	2437	12.40	12.90		30.00	30.00	-2.10	-6.80	10.30	6.10	36.00	36.00	Pass
HT20	MCS0	1	11	2462	12.50	13.00		30.00	30.00	-2.10	-6.80	10.40	6.20	36.00	36.00	Pass
HT20	MCS0	1	12	2467	9.00	9.10		30.00	30.00	-2.10	-6.80	6.90	2.30	36.00	36.00	Pass
HT20	MCS0	1	13	2472	0.10	0.10		30.00	30.00	-2.10	-6.80	-2.00	-6.70	36.00	36.00	Pass
11b	1Mbps	2	1	2412	12.50	13.40	15.98	30.00		-2.10		13.88		36.00		Pass
11b	1Mbps	2	6	2437	12.60	13.40	16.03	30.00		-2.10		13.93		36.00		Pass
11b	1Mbps	2	11	2462	12.60	13.40	16.03	30.00		-2.10		13.93		36.00		Pass
11b	1Mbps	2	12	2467	12.30	13.10	15.73	30.00		-2.10		13.63		36.00		Pass
11b	1Mbps	2	13	2472	10.60	10.70	13.66	30.00		-2.10		11.56		36.00		Pass
11g	6Mbps	2	1	2412	8.90	8.60	11.76	30.00		-2.10		9.66		36.00		Pass
11g	6Mbps	2	6	2437	12.60	13.30	15.97	30.00		-2.10		13.87		36.00		Pass
11g	6Mbps	2	11	2462	12.30	13.40	15.90	30.00		-2.10		13.80		36.00		Pass
11g	6Mbps	2	12	2467	11.40	11.40	14.41	30.00		-2.10		12.31		36.00		Pass
11g	6Mbps	2	13	2472	0.40	0.40	3.41	30.00		-2.10		1.31		36.00		Pass
HT20	MCS0	2	1	2412	3.40	3.40	6.41	30.00		-2.10		4.31		36.00		Pass
HT20	MCS0	2	6	2437	12.50	13.10	15.82	30.00		-2.10		13.72		36.00		Pass
HT20	MCS0	2	11	2462	12.60	13.30	15.97	30.00		-2.10		13.87		36.00		Pass
HT20	MCS0	2	12	2467	9.10	9.20	12.16	30.00		-2.10		10.06		36.00		Pass
HT20	MCS0	2	13	2472	0.20	0.30	3.26	30.00		-2.10		1.16		36.00		Pass

Note: Measured power (dBm) has offset with cable loss.



Appendix B. Radiated Spurious Emission

Test Engineer :	Jacky Hung, Austin LI, CR Liro	Temperature :	20~25°C
		Relative Humidity :	50~60%

2.4GHz 2400~2483.5MHz

WIFI 802.11b (Band Edge @ 3m)

WIFI Ant.	Note	Frequency (MHz)	Level (dBμV/m)	Over Limit (dB)	Limit Line (dBμV/m)	Read Level (dBμV)	Antenna Factor (dB/m)	Path Loss (dB)	Preamp Factor (dB)	Ant Pos (cm)	Table Pos (deg)	Peak Avg. (P/A)	Pol. (H/V)
802.11b CH 13 2472MHz	*	2472	102.82	-	-	87.08	27.63	18.37	30.26	136	34	P	H
	*	2472	99.74	-	-	84	27.63	18.37	30.26	136	34	A	H
		2490.04	57.12	-16.88	74	41.32	27.67	18.38	30.25	136	34	P	H
		2483.52	45.51	-8.49	54	29.72	27.66	18.38	30.25	136	34	A	H
													H
													H
	*	2472	97.72	-	-	81.98	27.63	18.37	30.26	298	95	P	V
	*	2472	94.53	-	-	78.79	27.63	18.37	30.26	298	95	A	V
		2498.6	56.45	-17.55	74	40.61	27.7	18.39	30.25	298	95	P	V
		2483.52	45.53	-8.47	54	29.74	27.66	18.38	30.25	298	95	A	V
													V
													V
Remark	1. No other spurious found. 2. All results are PASS against Peak and Average limit line.												



2.4GHz 2400~2483.5MHz

WIFI 802.11b (Harmonic @ 3m)

WIFI	Note	Frequency	Level	Over	Limit	Read	Antenna	Path	Preamp	Ant	Table	Peak	Pol.
Ant.				Limit	Line	Level	Factor	Loss	Factor	Pos	Pos	Avg.	
1		(MHz)	(dBμV/m)	(dB)	(dBμV/m)	(dBμV)	(dB/m)	(dB)	(dB)	(cm)	(deg)	(P/A)	(H/V)
802.11b CH 13 2472MHz		4944	40.04	-33.96	74	51.46	32.69	14.03	58.14	100	0	P	H
		7416	44.05	-29.95	74	48.82	37.38	15.21	57.36	100	0	P	H
													H
													H
		4944	39.79	-34.21	74	51.21	32.69	14.03	58.14	100	0	P	V
		7416	44.19	-29.81	74	48.96	37.38	15.21	57.36	100	0	P	V
													V
													V

Remark

- No other spurious found.
- All results are PASS against Peak and Average limit line.



2.4GHz 2400~2483.5MHz

WIFI 802.11n HT20 (Band Edge @ 3m)

WIFI Ant.	Note	Frequency	Level	Over Limit	Limit Line	Read Level	Antenna Factor	Path Loss	Preamp Factor	Ant Pos	Table Pos	Peak Avg.	Pol.
1		(MHz)	(dBμV/m)	(dB)	(dBμV/m)	(dBμV)	(dB/m)	(dB)	(dB)	(cm)	(deg)	(P/A)	(H/V)
802.11n HT20 CH 12 2467MHz	*	2467	101.88	-	-	86.16	27.61	18.37	30.26	108	350	P	H
	*	2467	94.18	-	-	78.46	27.61	18.37	30.26	108	350	A	H
		2483.68	62.24	-11.76	74	46.45	27.66	18.38	30.25	108	350	P	H
		2483.52	50.24	-3.76	54	34.45	27.66	18.38	30.25	108	350	A	H
													H
													H
	*	2467	98.92	-	-	83.2	27.61	18.37	30.26	303	105	P	V
	*	2467	90.38	-	-	74.66	27.61	18.37	30.26	303	105	A	V
		2483.76	57.55	-16.45	74	41.76	27.66	18.38	30.25	303	105	P	V
		2483.52	47.51	-6.49	54	31.72	27.66	18.38	30.25	303	105	A	V
												V	
												V	



2.4GHz 2400~2483.5MHz

WIFI 802.11n HT20 (Harmonic @ 3m)

WIFI	Note	Frequency	Level	Over	Limit	Read	Antenna	Path	Preamp	Ant	Table	Peak	Pol.
Ant.				Limit	Line	Level	Factor	Loss	Factor	Pos	Pos	Avg.	
1		(MHz)	(dBμV/m)	(dB)	(dBμV/m)	(dBμV)	(dB/m)	(dB)	(dB)	(cm)	(deg)	(P/A)	(H/V)
802.11n		4934	40.75	-33.25	74	52.21	32.67	14.01	58.14	100	0	P	H
		7401	43.44	-30.56	74	48.3	37.36	15.16	57.38	100	0	P	H
HT20													H
CH 12		4934	40.59	-33.41	74	52.05	32.67	14.01	58.14	100	0	P	V
2467MHz		7401	43.67	-30.33	74	48.53	37.36	15.16	57.38	100	0	P	V
													V
													V



Emission below 1GHz

2.4GHz WIFI 802.11n HT20 (LF)

WIFI Ant.	Note	Frequency	Level	Over Limit	Limit Line	Read Level	Antenna Factor	Path Loss	Preamp Factor	Ant Pos	Table Pos	Peak Avg.	Pol.	
1		(MHz)	(dBμV/m)	(dB)	(dBμV/m)	(dBμV)	(dB/m)	(dB)	(dB)	(cm)	(deg)	(P/A)	(H/V)	
2.4GHz 802.11n HT20 LF		183.26	24.27	-19.23	43.5	40.05	14.91	1.66	32.35	-	-	P	H	
		360.77	23.16	-22.84	46	31.99	20.74	2.9	32.47	-	-	P	H	
		461.65	24.38	-21.62	46	30.4	23.33	3.2	32.55	-	-	P	H	
		529.55	25.82	-20.18	46	30.84	24.12	3.47	32.61	-	-	P	H	
		713.85	29.04	-16.96	46	30.42	26.92	4.21	32.51	-	-	P	H	
		857.41	31.69	-14.31	46	29.94	29.12	4.66	32.03	100	0	P	H	
													H	
													H	
													H	
													H	
													H	
													H	
			44.55	23.89	-16.11	40	38.8	16.88	0.65	32.44	-	-	P	V
			181.32	22.57	-20.93	43.5	38.3	14.98	1.64	32.35	-	-	P	V
			377.26	21.73	-24.27	46	30.12	21.05	3.04	32.48	-	-	P	V
			559.62	26.66	-19.34	46	29.39	26.27	3.64	32.64	-	-	P	V
			753.62	30.21	-15.79	46	29.96	28.18	4.51	32.44	-	-	P	V
			916.58	31.95	-14.05	46	29.46	29.5	4.63	31.64	100	0	P	V
												V		
												V		
												V		
												V		
												V		
												V		
Remark	1. No other spurious found. 2. All results are PASS against limit line.													



Note symbol

*	Fundamental Frequency which can be ignored. However, the level of any unwanted emissions shall not exceed the level of the fundamental frequency.
!	Test result is over limit line.
P/A	Peak or Average
H/V	Horizontal or Vertical



A calculation example for radiated spurious emission is shown as below:

WIFI	Note	Frequency	Level	Over	Limit	Read	Antenna	Path	Preamp	Ant	Table	Peak	Pol.
Ant.				Limit	Line	Level	Factor	Loss	Factor	Pos	Pos	Avg.	
1		(MHz)	(dBμV/m)	(dB)	(dBμV/m)	(dBμV)	(dB/m)	(dB)	(dB)	(cm)	(deg)	(P/A)	(H/V)
802.11b		2390	55.45	-18.55	74	54.51	32.22	4.58	35.86	103	308	P	H
CH 01													
2412MHz		2390	43.54	-10.46	54	42.6	32.22	4.58	35.86	103	308	A	H

1. Path Loss(dB) = Cable loss(dB) + Filter loss(dB) + Attenuator loss(dB)
2. Level(dBμV/m) =
Antenna Factor(dB/m) + Path Loss(dB) + Read Level(dBμV) - Preamp Factor(dB)
3. Over Limit(dB) = Level(dBμV/m) – Limit Line(dBμV/m)

For Peak Limit @ 2390MHz:

1. Level(dBμV/m)
= Antenna Factor(dB/m) + Path Loss(dB) + Read Level(dBμV) - Preamp Factor(dB)
= 32.22(dB/m) + 4.58(dB) + 54.51(dBμV) – 35.86 (dB)
= 55.45 (dBμV/m)
2. Over Limit(dB)
= Level(dBμV/m) – Limit Line(dBμV/m)
= 55.45(dBμV/m) – 74(dBμV/m)
= -18.55(dB)

For Average Limit @ 2390MHz:

1. Level(dBμV/m)
= Antenna Factor(dB/m) + Path Loss(dB) + Read Level(dBμV) - Preamp Factor(dB)
= 32.22(dB/m) + 4.58(dB) + 42.6(dBμV) – 35.86 (dB)
= 43.54 (dBμV/m)
2. Over Limit(dB)
= Level(dBμV/m) – Limit Line(dBμV/m)
= 43.54(dBμV/m) – 54(dBμV/m)
= -10.46(dB)

Both peak and average measured complies with the limit line, so test result is “PASS”.



Appendix C. Radiated Spurious Emission Plots

Test Engineer :	Jacky Hung, Austin LI, CR Liro	Temperature :	20~25°C
		Relative Humidity :	50~60%

Note symbol

-L	Low channel location
-R	High channel location



2.4GHz 2400~2483.5MHz
WIFI 802.11b (Band Edge @ 3m)

WIFI	2.4GHz 2400~2483.5MHz Band Edge @ 3m	
ANT	802.11b CH13 2472MHz	
1	Horizontal	Fundamental
Peak	<p>Site : 03CH16-HY Condition : PEAK_BE_74 3m 91200_1522 HORIZONTAL RBW:1000.000KHz VBW:3000.000KHz SWT:Auto Detector : Peak Project : 940907-03 Setting : 0x13</p>	<p>Site : 03CH16-HY Condition : PEAK_74 3m 91200_1522 HORIZONTAL RBW:1000.000KHz VBW:3000.000KHz SWT:Auto Detector : Peak Project : 940907-03 Setting : 0x13</p>
Avg.	<p>Site : 03CH16-HY Condition : AVG_BE_54 3m 91200_1522 HORIZONTAL RBW:1000.000KHz VBW:0.010KHz SWT:Auto Detector : Peak Project : 940907-03 Setting : 0x13</p>	<p>Site : 03CH16-HY Condition : AVG_54 3m 91200_1522 HORIZONTAL RBW:1000.000KHz VBW:0.010KHz SWT:Auto Detector : Peak Project : 940907-03 Setting : 0x13</p>

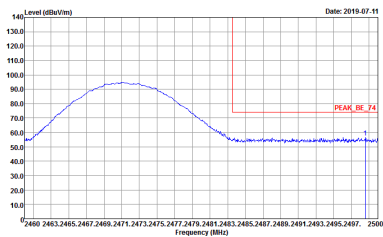
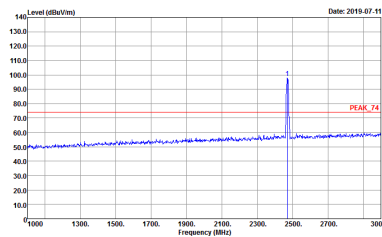
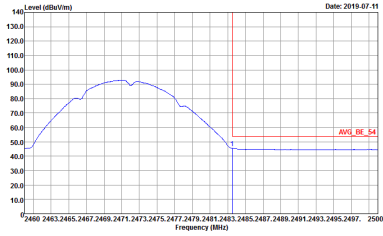
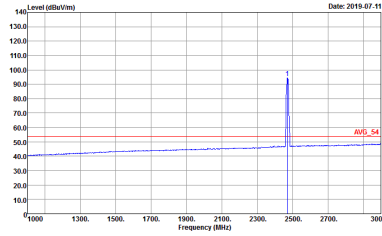

WIFI	2.4GHz 2400~2483.5MHz Band Edge @ 3m	
ANT	802.11b CH13 2472MHz	
1	Vertical	Fundamental
Peak	 <p>Site : 03CH16-HY Condition : PEAK_BE_74 3m 91200_1522 VERTICAL RBW:1000.000KHz VBW:3000.000KHz SWT:Auto Detector : Peak Project : 940907-03 Setting : 0x13</p>	 <p>Site : 03CH16-HY Condition : PEAK_74 3m 91200_1522 VERTICAL RBW:1000.000KHz VBW:3000.000KHz SWT:Auto Detector : Peak Project : 940907-03 Setting : 0x13</p>
Avg.	 <p>Site : 03CH16-HY Condition : AVG_BE_54 3m 91200_1522 VERTICAL RBW:1000.000KHz VBW:0.010KHz SWT:Auto Detector : Peak Project : 940907-03 Setting : 0x13</p>	 <p>Site : 03CH16-HY Condition : AVG_54 3m 91200_1522 VERTICAL RBW:1000.000KHz VBW:0.010KHz SWT:Auto Detector : Peak Project : 940907-03 Setting : 0x13</p>



2.4GHz 2400~2483.5MHz

WIFI 802.11n HT20 (Band Edge @ 3m)

WIFI	2.4GHz 2400~2483.5MHz Band Edge @ 3m	
ANT	802.11n HT20 CH12 2467MHz	
1	Horizontal	Fundamental
Peak	<p>Site : 03CH16-HY Condition : PEAK_BE_74 3m 91200_1522 HORIZONTAL RBW:1000.000KHz VBW:3000.000KHz SWT:Auto Detector : Peak Project : 940907-03 Setting : 0x14</p>	<p>Site : 03CH16-HY Condition : PEAK_74 3m 91200_1522 HORIZONTAL RBW:1000.000KHz VBW:3000.000KHz SWT:Auto Detector : Peak Project : 940907-03 Setting : 0x14</p>
Avg.	<p>Site : 03CH16-HY Condition : AVG_BE_54 3m 91200_1522 HORIZONTAL RBW:1000.000KHz VBW:0.010KHz SWT:Auto Detector : Peak Project : 940907-03 Setting : 0x14</p>	<p>Site : 03CH16-HY Condition : AVG_54 3m 91200_1522 HORIZONTAL RBW:1000.000KHz VBW:0.010KHz SWT:Auto Detector : Peak Project : 940907-03 Setting : 0x14</p>

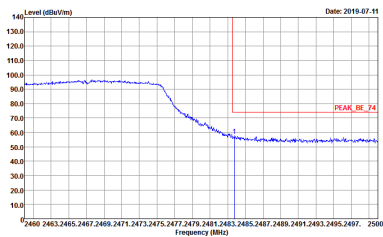
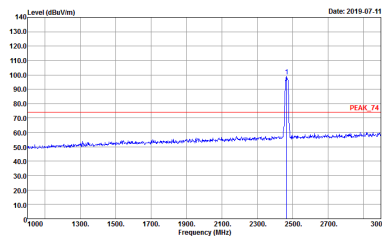
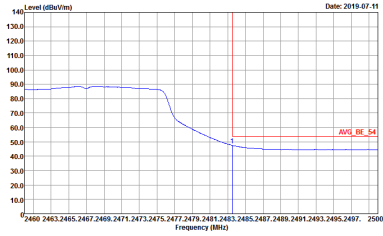
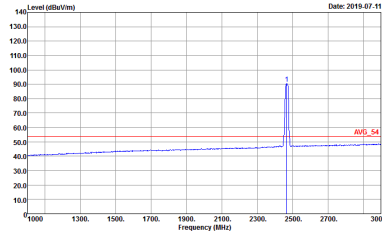

WIFI	2.4GHz 2400~2483.5MHz Band Edge @ 3m	
ANT	802.11n HT20 CH12 2467MHz	
1	Vertical	Fundamental
Peak	 <p>Site : 03CH16-HY Condition : PEAK_BE_74 3m 91200_1522 VERTICAL RBW:1000.000KHz VBW:3000.000KHz SWT:Auto Detector : Peak Project : 940907-03 Setting : 0x14</p>	 <p>Site : 03CH16-HY Condition : PEAK_74 3m 91200_1522 VERTICAL RBW:1000.000KHz VBW:3000.000KHz SWT:Auto Detector : Peak Project : 940907-03 Setting : 0x14</p>
Avg.	 <p>Site : 03CH16-HY Condition : AVG_BE_54 3m 91200_1522 VERTICAL RBW:1000.000KHz VBW:0.010KHz SWT:Auto Detector : Peak Project : 940907-03 Setting : 0x14</p>	 <p>Site : 03CH16-HY Condition : AVG_54 3m 91200_1522 VERTICAL RBW:1000.000KHz VBW:0.010KHz SWT:Auto Detector : Peak Project : 940907-03 Setting : 0x14</p>



2.4GHz 2400~2483.5MHz
WIFI 802.11b (Harmonic @ 3m)

WIFI	2.4GHz 2400~2483.5MHz Harmonic @ 3m	
ANT	802.11b CH13 2472MHz	
1	Horizontal	Vertical
Peak Avg.	<p>Site : 03CH16-HY Condition : PEAK_74 3m 9120D_1522 HORIZONTAL Detector : Peak Project : 940907-03</p>	<p>Site : 03CH16-HY Condition : PEAK_74 3m 9120D_1522 VERTICAL Detector : Peak Project : 940907-03</p>



2.4GHz 2400~2483.5MHz
WIFI 802.11n HT20 (Harmonic @ 3m)

WIFI	2.4GHz 2400~2483.5MHz Harmonic @ 3m	
ANT	802.11n HT20 CH12 2462MHz	
1	Horizontal	Vertical
Peak Avg.	<p>Site : 03CH16-HY Condition : PEAK_74 3m 9120D_1522 HORIZONTAL Detector : Peak Project : 940907-03</p>	<p>Site : 03CH16-HY Condition : PEAK_74 3m 9120D_1522 VERTICAL Detector : Peak Project : 940907-03</p>



Emission below 1GHz
2.4GHz WIFI 802.11n HT20 (LF)

WIFI	2.4GHz 2400~2483.5MHz	
ANT	802.11n HT20 LF	
1	Horizontal	Vertical
QP / Peak	<p>Site : 03CH16-HY Condition : QP 3m BIL06_47020606 HORIZONTAL Detector : Peak Project : 940907-03</p>	<p>Site : 03CH16-HY Condition : QP 3m BIL06_47020606 VERTICAL Detector : Peak Project : 940907-03</p>



Appendix D. Duty Cycle Plots

Antenna	Band	Duty Cycle(%)	T(us)	1/T(kHz)	VBW Setting	Duty Factor(dB)
1+2	802.11b for Ant. 1	98.98	-	-	10Hz	0.04
1+2	802.11b for Ant. 2	98.70	-	-	10Hz	0.06
1+2	2.4GHz 802.11n HT20 for Ant. 1	98.43	-	-	10Hz	0.07
1+2	2.4GHz 802.11n HT20 for Ant. 2	97.65	2495	0.40	1kHz	0.10



MIMO <Ant. 1>

802.11b

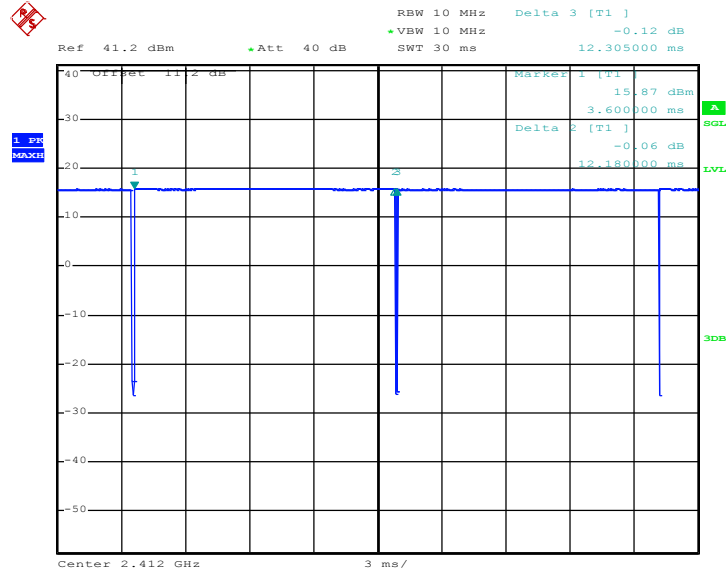

Date: 30.JUN.2019 14:16:48

802.11n HT20

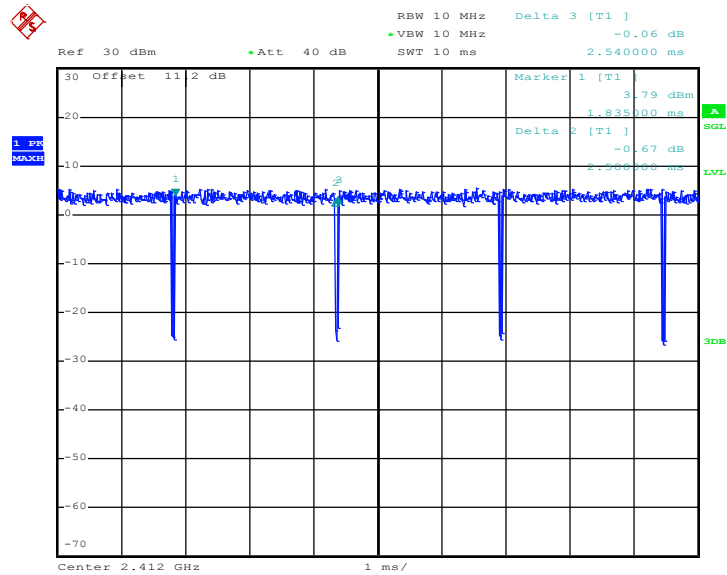

Date: 30.JUN.2019 14:32:10



MIMO <Ant. 2>

802.11b

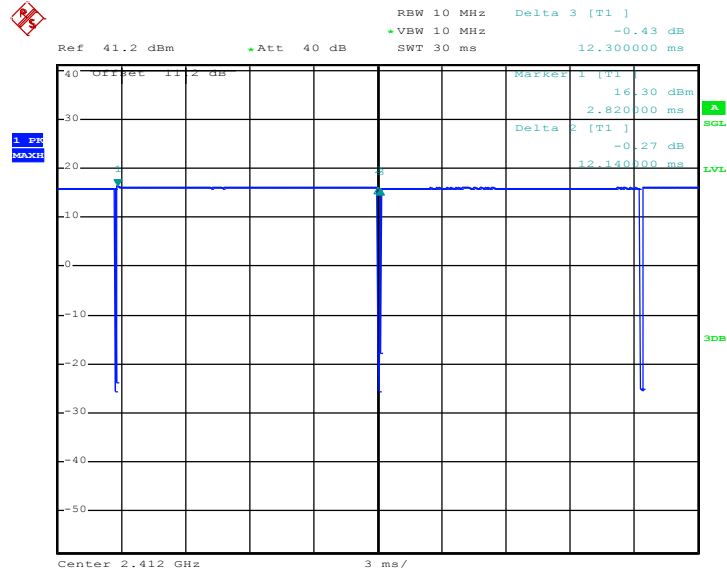

Date: 30.JUN.2019 14:18:05

802.11n HT20

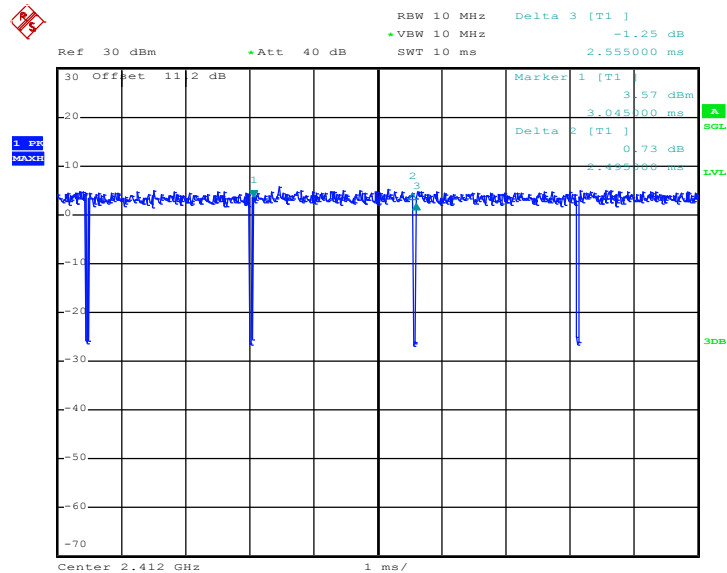

Date: 30.JUN.2019 14:34:20

THE END