



CERTIFICATION TEST REPORT

Report Number. : 12073310-E2V2

Applicant : SONY MOBILE COMMUNICATIONS INC.
4-12-3 HIGASHI-SHINAGAWA, SHINAGAWA-KU
TOKYO, 140-0002, JAPAN

FCC ID : PY7-21831A

EUT Description : GSM/WCDMA/LTE PHONE with BT, DTS/UNII a/b/g/n/ac & NFC

Test Standard(s) : FCC 47 CFR PART 15 SUBPART C

Date Of Issue:

JANUARY 16, 2018

Prepared by:

UL Verification Services Inc.
47173 Benicia Street
Fremont, CA 94538, U.S.A.
TEL: (510) 771-1000
FAX: (510) 661-0888



Revision History

<u>Rev.</u>	<u>Issue Date</u>	<u>Revisions</u>	<u>Revised By</u>
V1	1/8/18	Initial Issue	Dan Corona
V2	1/16/18	Section 1 removed "Reviewed By", updated numbering of sub-section of Section 5	Dan Corona

TABLE OF CONTENTS

1. ATTESTATION OF TEST RESULTS	5
2. TEST METHODOLOGY	6
3. FACILITIES AND ACCREDITATION	6
4. CALIBRATION AND UNCERTAINTY	7
4.1. MEASURING INSTRUMENT CALIBRATION	7
4.2. SAMPLE CALCULATION	7
4.3. MEASUREMENT UNCERTAINTY	7
5. EQUIPMENT UNDER TEST	8
5.1. DESCRIPTION OF EUT	8
5.2. MAXIMUM OUTPUT POWER	8
5.3. DESCRIPTION OF AVAILABLE ANTENNAS	8
5.4. SOFTWARE AND FIRMWARE	8
5.5. WORST-CASE CONFIGURATION AND MODE	9
5.6. DESCRIPTION OF TEST SETUP	10
6. TEST AND MEASUREMENT EQUIPMENT	13
7. ANTENNA PORT TEST RESULTS	14
7.1. BASIC DATA RATE GFSK MODULATION	15
7.1.1. 20 dB BANDWIDTH	15
7.1.2. 99% BANDWIDTH	18
7.1.3. HOPPING FREQUENCY SEPARATION	21
7.1.4. NUMBER OF HOPPING CHANNELS	22
7.1.5. AVERAGE TIME OF OCCUPANCY	25
7.1.6. OUTPUT POWER	29
7.1.7. AVERAGE POWER	30
7.1.8. CONDUCTED BANDEDGE AND SPURIOUS EMISSIONS	31
7.2. ENHANCED DATA RATE 8PSK MODULATION	35
7.2.1. 20 dB BANDWIDTH	35
7.2.1. 99% BANDWIDTH	38
7.2.2. HOPPING FREQUENCY SEPARATION	41
7.2.3. NUMBER OF HOPPING CHANNELS	42
7.2.4. AVERAGE TIME OF OCCUPANCY	45
7.2.5. OUTPUT POWER	49
7.2.6. AVERAGE POWER	50
7.2.7. CONDUCTED BANDEDGE AND SPURIOUS EMISSIONS	51

8. RADIATED TEST RESULTS	55
8.1. LIMITS AND PROCEDURE	55
8.2. BASIC DATA RATE GFSK MODULATION.....	56
8.2.1. RESTRICTED BANDEDGE (LOW CHANNEL).....	56
8.2.2. AUTHORIZED BANDEDGE (HIGH CHANNEL)	58
8.2.3. HARMONICS AND SPURIOUS EMISSIONS	60
8.3. ENHANCED DATA RATE 8PSK MODULATION.....	66
8.3.1. RESTRICTED BANDEDGE (LOW CHANNEL).....	66
8.3.2. AUTHORIZED BANDEDGE (HIGH CHANNEL)	68
8.3.3. HARMONICS AND SPURIOUS EMISSIONS	70
8.4. WORST-CASE BELOW 30 MHz.....	76
8.5. WORST-CASE BELOW 1 GHz.....	77
8.6. WORST-CASE ABOVE 18 GHz.....	79
9. AC POWER LINE CONDUCTED EMISSIONS	81
10. SETUP PHOTOS	84

1. ATTESTATION OF TEST RESULTS

COMPANY NAME: SONY MOBILE COMMUNICATIONS INC.
4-12-3 HIGASHI-SHINAGAWA, SHINAGAWA-KU
TOKYO, 140-0002, JAPAN

EUT DESCRIPTION: GSM/WCDMA/LTE PHONE with BT, DTS/UNII a/b/g/n/ac, & NFC

SERIAL NUMBER: QV70003P12 (RADIATED)
QV7000SD15 (CONDUCTED)

DATE TESTED: DECEMBER 7-15, 2017

APPLICABLE STANDARDS	
STANDARD	TEST RESULTS
CFR 47 Part 15 Subpart C	Complies

UL Verification Services Inc. tested the above equipment in accordance with the requirements set forth in the above standards. All indications of Pass/Fail in this report are opinions expressed by UL Verification Services Inc. based on interpretations and/or observations of test results. Measurement Uncertainties were not taken into account and are published for informational purposes only. The test results show that the equipment tested is capable of demonstrating compliance with the requirements as documented in this report.

Note: The results documented in this report apply only to the tested sample, under the conditions and modes of operation as described herein. This document may not be altered or revised in any way unless done so by UL Verification Services Inc. and all revisions are duly noted in the revisions section. Any alteration of this document not carried out by UL Verification Services Inc. will constitute fraud and shall nullify the document. This report must not be used by the client to claim product certification, approval, or endorsement by NVLAP, NIST, any agency of the Federal Government, or any agency of any government.

Approved & Released For
UL Verification Services Inc By



Dan Corona
Operations Leader
UL Verification Services Inc.

Prepared By:



Kiya Kedida
Project Engineer
UL Verification Services Inc.

2. TEST METHODOLOGY

The tests documented in this report were performed in accordance with FCC CFR 47 Part 2, FCC CFR 47 Part 15 and ANSI C63.10-2013.

3. FACILITIES AND ACCREDITATION

The test sites and measurement facilities used to collect data are located at 47173 and 47266 Benicia Street, Fremont, California, USA. Line conducted emissions are measured only at the 47173 address. The following table identifies which facilities were utilized for radiated emission measurements documented in this report. Specific facilities are also identified in the test results sections.

47173 Benicia Street	47266 Benicia Street
<input checked="" type="checkbox"/> Chamber A(IC: 2324B-1)	<input type="checkbox"/> Chamber D(IC: 22541-1)
<input checked="" type="checkbox"/> Chamber B(IC: 2324B-2)	<input type="checkbox"/> Chamber E(IC: 22541-2)
<input checked="" type="checkbox"/> Chamber C(IC: 2324B-3)	<input type="checkbox"/> Chamber F(IC: 22541-3)
	<input type="checkbox"/> Chamber G(IC: 22541-4)
	<input type="checkbox"/> Chamber H(IC: 22541-5)

The above test sites and facilities are covered under FCC Test Firm Registration # 208313. UL Verification Services Inc. is accredited by NVLAP, Laboratory Code 200065-0. Chambers A through C are covered under Industry Canada company address code 2324B with site numbers 2324B -1 through 2324B-3, respectively. Chambers D through H are covered under Industry Canada company address code 22541 with site numbers 22541 -1 through 22541-5, respectively.

4. CALIBRATION AND UNCERTAINTY

4.1. MEASURING INSTRUMENT CALIBRATION

The measuring equipment utilized to perform the tests documented in this report has been calibrated in accordance with the manufacturer's recommendations, and is traceable to recognized national standards.

4.2. SAMPLE CALCULATION

Where relevant, the following sample calculation is provided:

$$\begin{aligned} \text{Field Strength (dBuV/m)} &= \text{Measured Voltage (dBuV)} + \text{Antenna Factor (dB/m)} + \\ &\text{Cable Loss (dB)} - \text{Preamp Gain (dB)} \\ 36.5 \text{ dBuV} + 18.7 \text{ dB/m} + 0.6 \text{ dB} - 26.9 \text{ dB} &= 28.9 \text{ dBuV/m} \end{aligned}$$

4.3. MEASUREMENT UNCERTAINTY

Where relevant, the following measurement uncertainty levels have been estimated for tests performed on the apparatus:

PARAMETER	UNCERTAINTY
Conducted Disturbance, 0.15 to 30 MHz	3.84 dB
Conducted Disturbance, 0.15 to 30 MHz	3.65 dB
Radiated Disturbance, 9KHz to 30 MHz	3.15 dB
Radiated Disturbance, 30 to 1000 MHz	5.36 dB
Radiated Disturbance, 1000 to 18000 MHz	4.32 dB
Radiated Disturbance, 18000 to 26000 MHz	4.45 dB
Radiated Disturbance, 26000 to 40000 MHz	5.24 dB

Uncertainty figures are valid to a confidence level of 95%.

5. EQUIPMENT UNDER TEST

5.1. DESCRIPTION OF EUT

The EUT is a GSM/WCDMA/LTE Phone with BT, DTS/UNII a/b/g/n/ac, & NFC.

5.2. MAXIMUM OUTPUT POWER

The transmitter has a maximum peak conducted output power as follows:

Frequency Range (MHz)	Mode	Output Power (dBm)	Output Power (mW)
2402 - 2480	Basic GFSK	11.13	12.97
2402 - 2480	Enhanced 8PSK	8.98	7.91

5.3. DESCRIPTION OF AVAILABLE ANTENNAS

The radio utilizes Loop Type antennas, with the following maximum gains

Frequency Band (GHz)	Antenna Gain (dBi)
2402-2480	-0.60

5.4. SOFTWARE AND FIRMWARE

The firmware installed in the EUT during testing was s_atp_XXX_0_00333_A_11.
The test utility software used during testing was Tera Term Ver 4.79.

5.5. WORST-CASE CONFIGURATION AND MODE

Radiated band edge, harmonics, and spurious emissions from 1 GHz to 18GHz were performed with the EUT was set to transmit at the Low/Middle/High channels.

Radiated emission below 30MHz, below 1GHz, above 18GHz, and power line conducted emission were performed with the EUT was set to transmit at the channel with highest output power as worst-case scenario.

The fundamental of the EUT was investigated in three orthogonal orientations X, Y, & Z, and it was determined that X-Axis with AC/DC Adapter was worst-case orientation; therefore, all final radiated testing was performed with the EUT in X-Axis with AC/DC Adapter orientation.

Worst-case data rates were:

GFSK mode: DH5
8PSK mode: 3-DH5

5.6. DESCRIPTION OF TEST SETUP

SUPPORT EQUIPMENT

Support Equipment List				
Description	Manufacturer	Model	Serial Number	FCC ID
Laptop	Lenovo	20B7S0A200	PC015REW	NA
AC Adapter	SONY	UCH12	4016W40310044	NA
DC Power Supply	Ametek	XT 15-4	T463	N/A

I/O CABLES (CONDUCTED TEST)

I/O Cable List						
Cable No	Port	# of identical ports	Connector Type	Cable Type	Cable Length (m)	Remarks
1	Antenna	1	RF	Shielded	0.2	To spectrum Analyzer
2	USB	1	USB	Shielded	1	N/A
3	DC	1	DC	Shielded	0.3	N/A

I/O CABLES (RADIATED AND CONDUCTED EMISSIONS)

I/O Cable List						
Cable No	Port	# of identical ports	Connector Type	Cable Type	Cable Length (m)	Remarks
1	USB	1	USB	Shielded	3	N/A

CONDCUTED TEST SETUP DIAGRAM

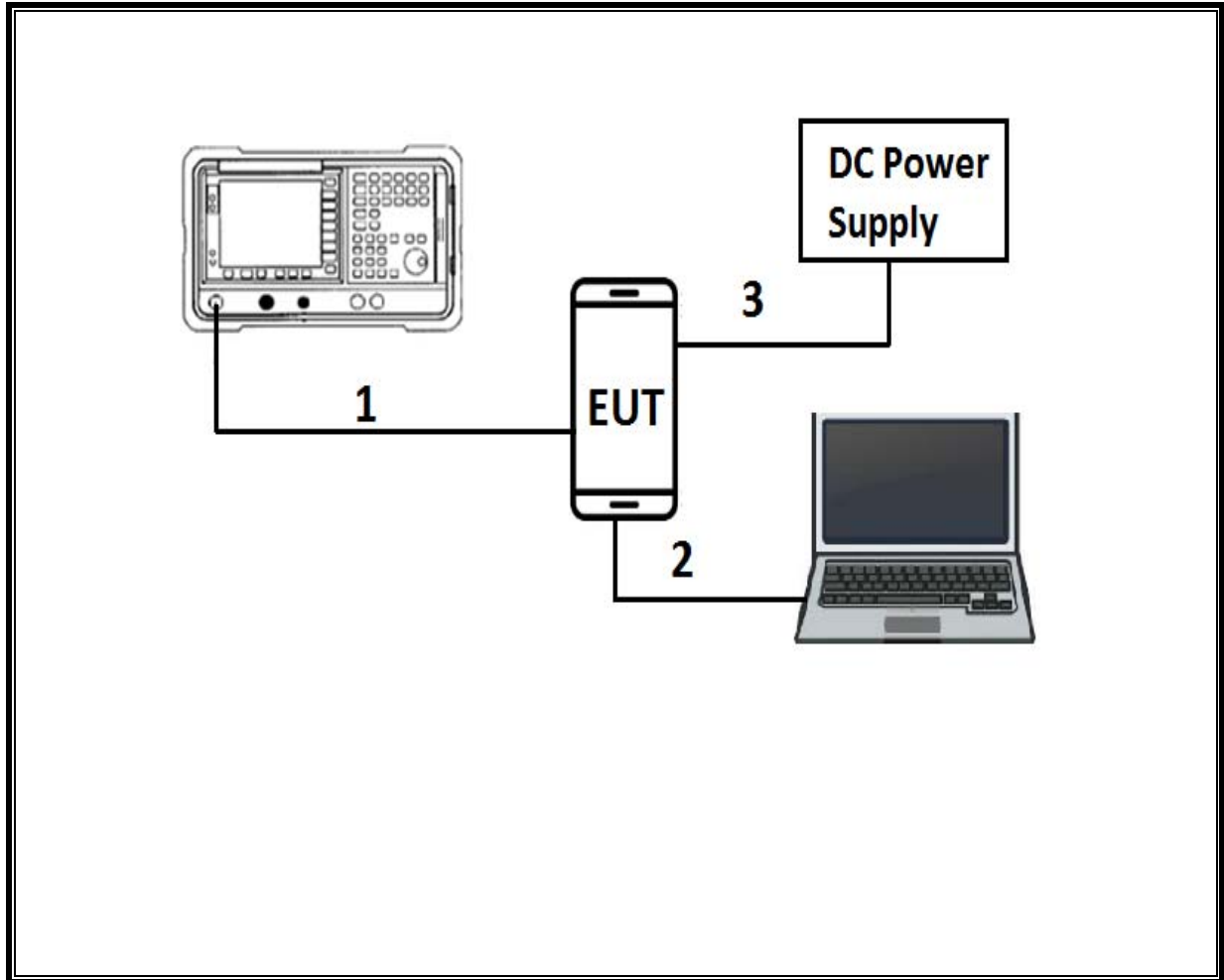

RADIATED AND AC LINE CONDUCTED EMISSIONS SETUP DIAGRAM

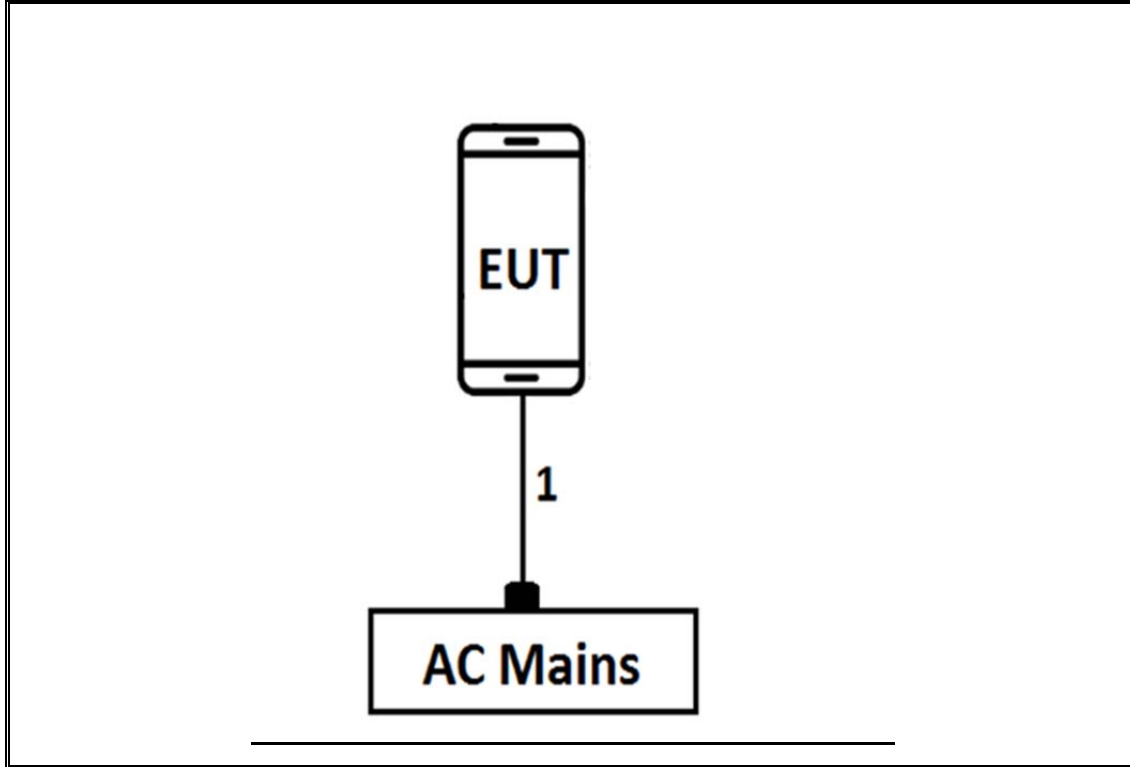

6. TEST AND MEASUREMENT EQUIPMENT

Description	Manufacturer	Model	ID Num	Cal Due
Spectrum Analyzer	Keysight	E4446A	T146	07/17/18
Spectrum Analyzer	Keysight	N9030A	T1466	04/11/18
Antenna, Biconolog, 30MHz – 1GHz	Sunol Sciences	JB3	T899	06/15/18
Antenna, Horn, 1-18GHz	ETS Lindgren	3117	T862	06/09/18
Antenna, Horn, 1-18GHz	ETS Lindgren	3117	T712	01/30/18
RF Preamplifier, 10kHz - 1GHz	Sonoma	310N	T300	12/11/18
RF Preamplifier, 1 - 18GHz	Miteq	AFS42-00101800-25-S-42	T1165	06/24/18
RF Preamplifier, 1 - 18GHz	Miteq	AFS42-00101800-25-S-42	T493	02/15/18
Spectrum Analyzer	Keysight	N9030A	T907	01/23/18
RF Preamplifier, 1 - 18GHz	Miteq	AFS42-00101800-25-S-42	T931	06/21/18
Spectrum Analyzer	Keysight	N9030A	T905	01/11/18
Spectrum Analyzer	Keysight	N9030A	T1454	12/31/17
Antenna, Horn, 18-26-GHz	ARA	MWH-1826	T449	6/12/18
Antenna, Active Loop 9KHz to 30MHz	COM-POWER	AL-130R	T1866	10/10/18
RF Preamplifier, 1-26GHz	Agilent	8449B	T404	07/23/18
Power Meter	Keysight	N1911A	T1271	07/17/18
Power Sensor	Keysight	N1921A	T413	06/22/18
EMI Receiver	Rohde & Schwarz	ESR	T1436	01/06/18
LISN	Fischer Custom Communications	FCC-LISN-50/250-25-2-01	T1310	06/15/18

Test Software List			
Description	Manufacturer	Model	Version
Radiated Software	UL	UL EMC	Ver 9.5, Apr 26, 2016
Conducted Software	UL	UL EMC	Ver 9.5, May 26, 2015
Antenna Port Software	UL	UL RF	Ver 5.1.1, July 15, 2016

7. ANTENNA PORT TEST RESULTS

ON TIME AND DUTY CYCLE

LIMITS

None; for reporting purposes only.

PROCEDURE

KDB 558074 Zero-Span Spectrum Analyzer Method.

ON TIME AND DUTY CYCLE RESULTS

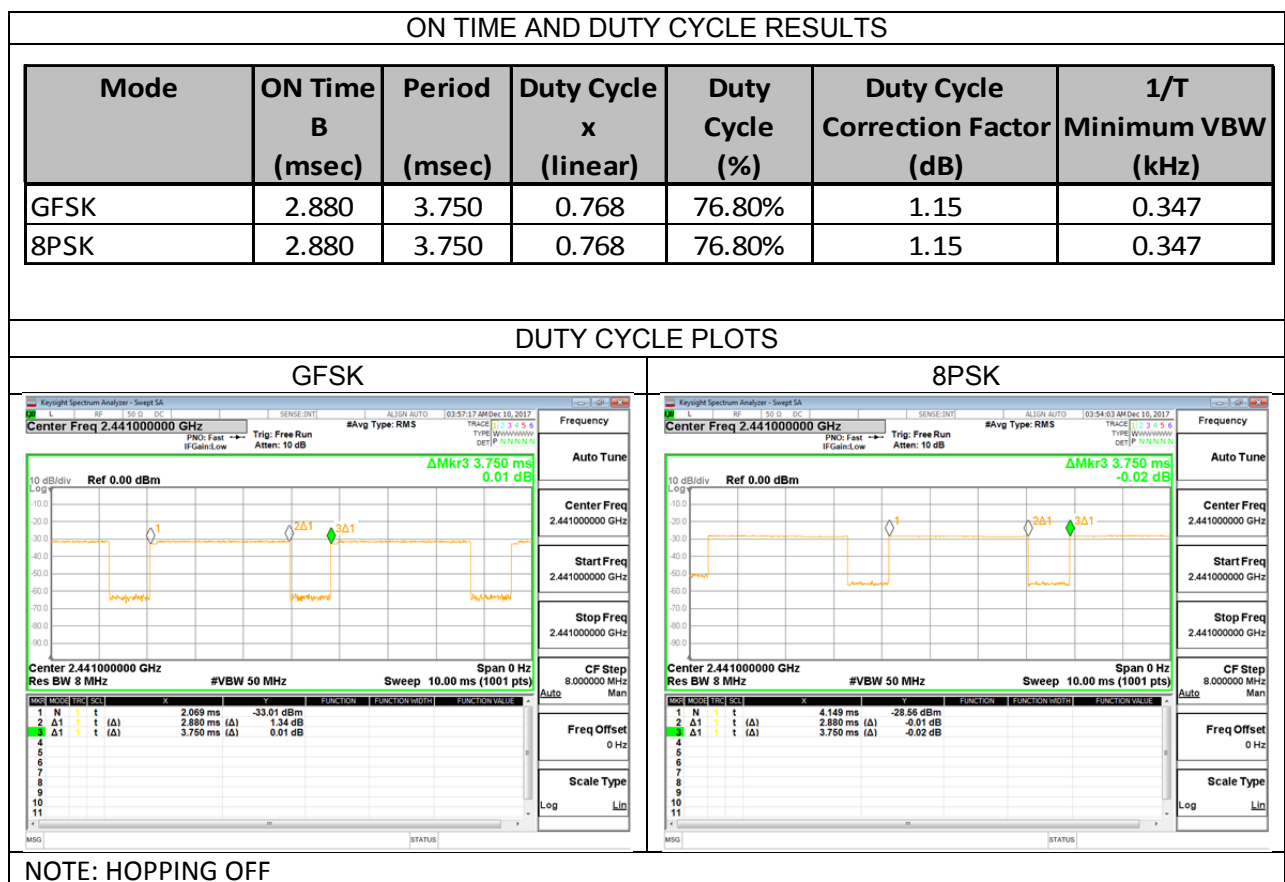

7.1. BASIC DATA RATE GFSK MODULATION

7.1.1. 20 dB BANDWIDTH

LIMITS

None; for reporting purposes only.

TEST PROCEDURE

The transmitter output is connected to a spectrum analyzer. The RBW is set to $\geq 1\%$ of the 20 dB bandwidth. The VBW is set to \geq RBW. The sweep time is coupled.

RESULTS

Channel	Frequency (MHz)	20 dB Bandwidth (KHz)
Low	2402	926
Middle	2441	930
High	2480	882

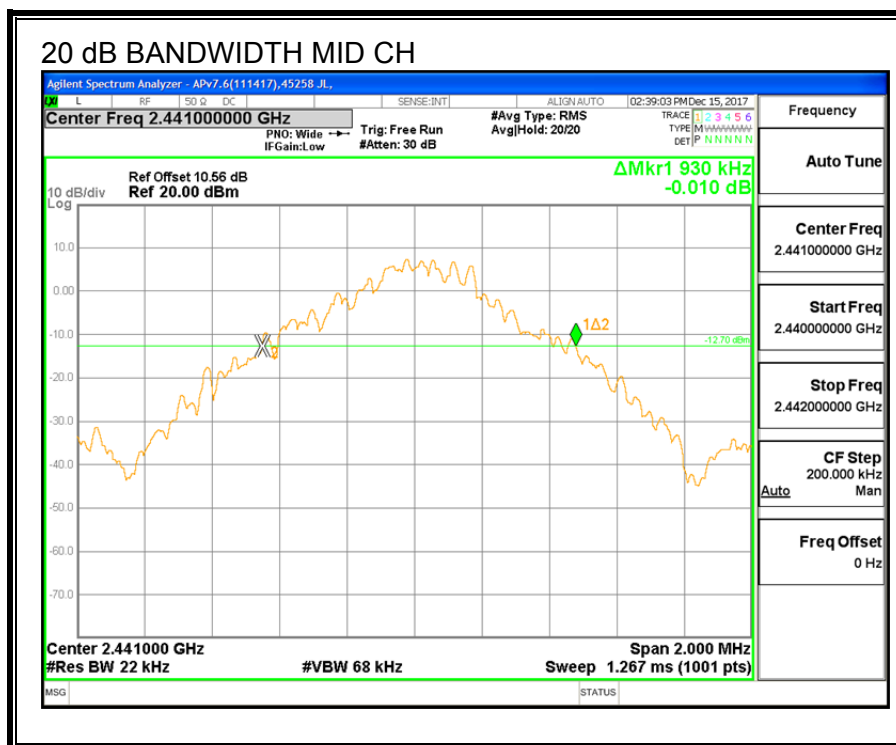
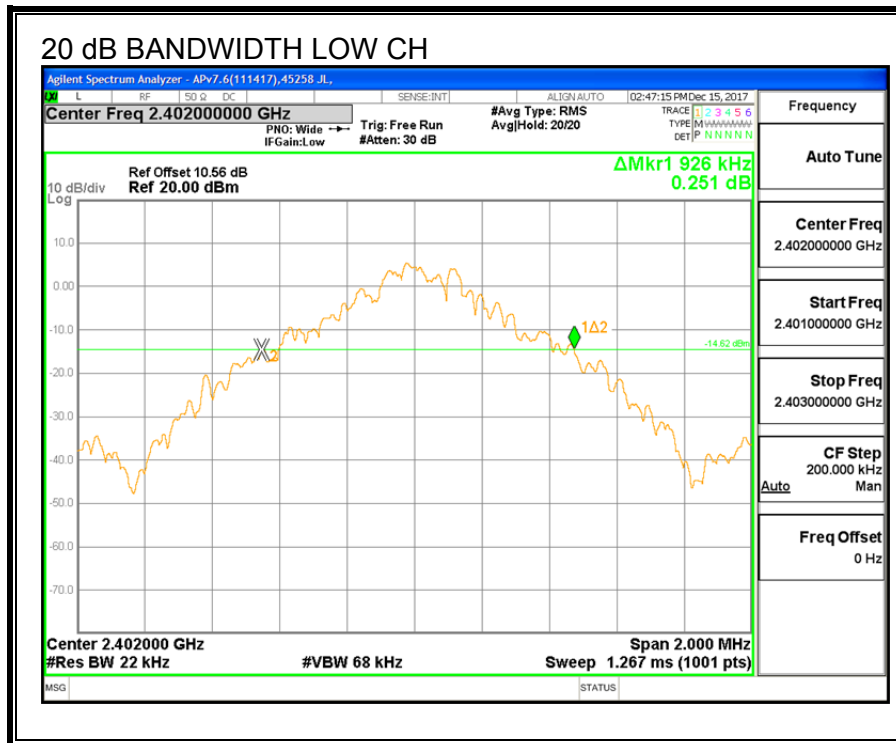

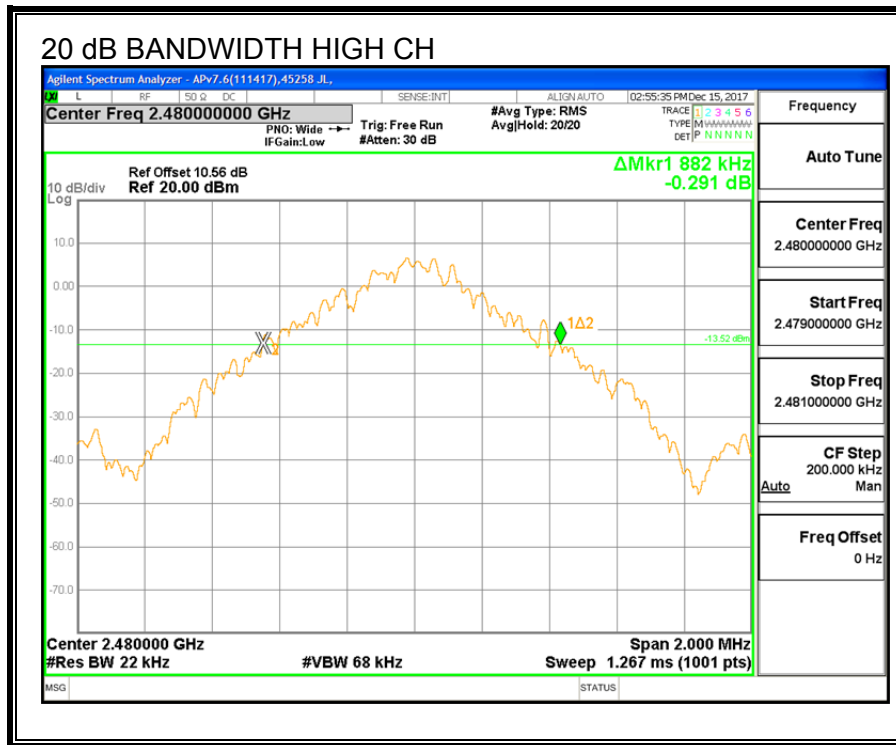

7.1.2. 99% BANDWIDTH

LIMITS

None; for reporting purposes only.

TEST PROCEDURE

The transmitter output is connected to a spectrum analyzer. The RBW is set to 1%-5% the OBW. The VBW is set to ≥ 3 times RBW. The sweep time is coupled.

RESULTS

Channel	Frequency (MHz)	99% Bandwidth (KHz)
Low	2402	829.97
Middle	2441	830.57
High	2480	833.42

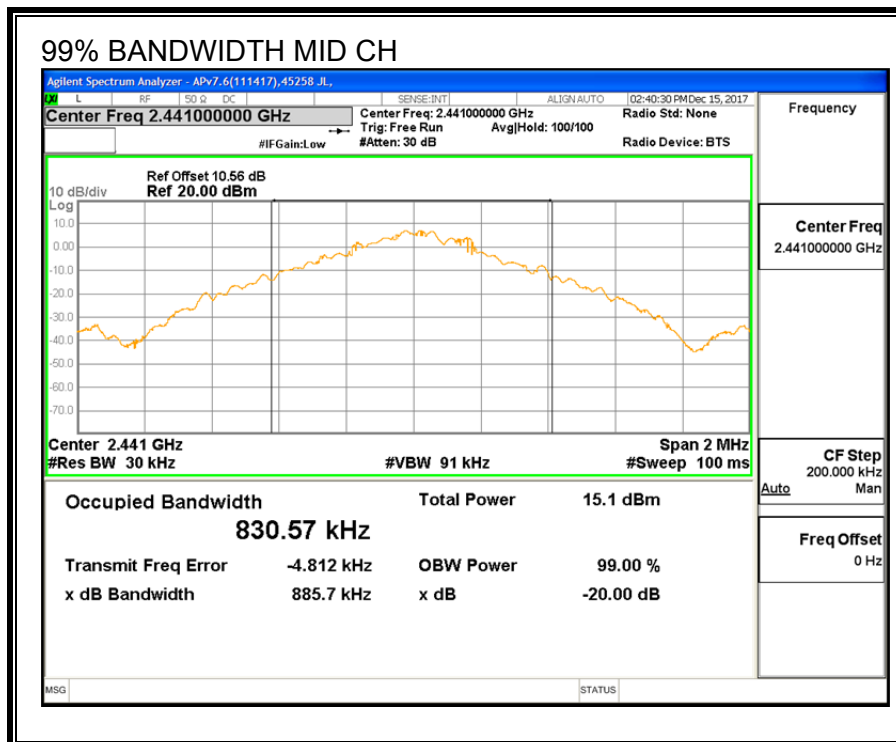
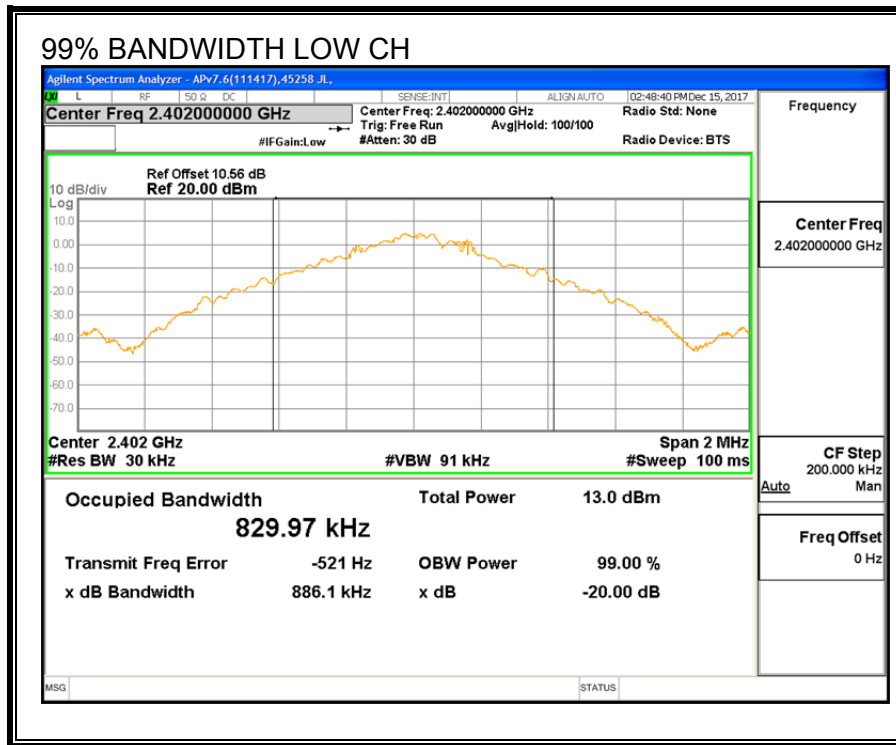

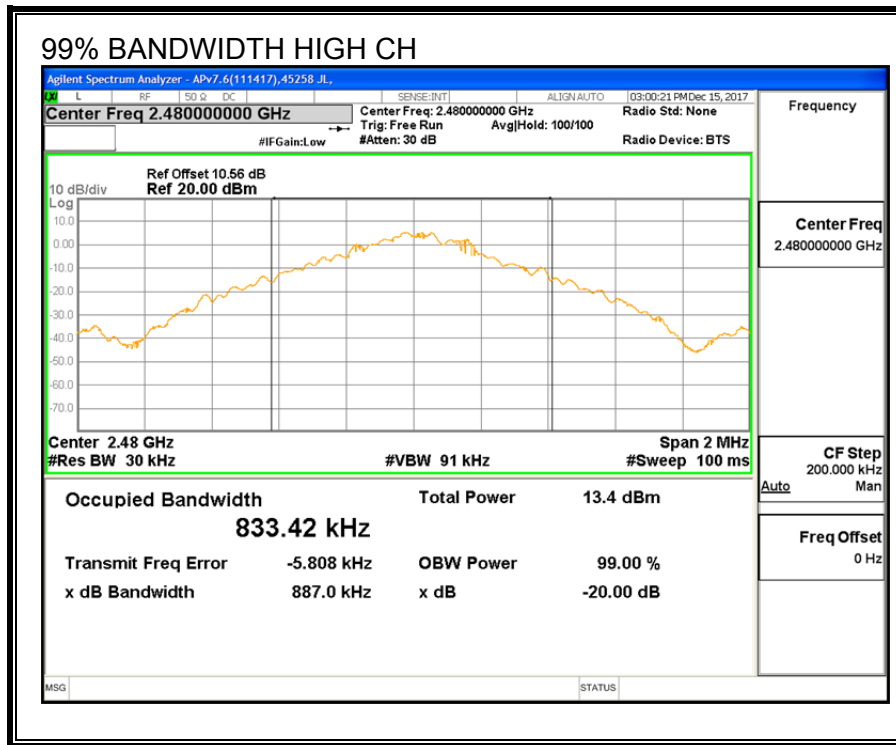

7.1.3. HOPPING FREQUENCY SEPARATION

LIMITS

FCC §15.247 (a) (1)

Frequency hopping systems shall have hopping channel carrier frequencies separated by a minimum of 25 kHz or the 20 dB bandwidth of the hopping channel, whichever is greater.

Alternatively, frequency hopping systems operating in the 2400-2483.5 MHz band may have hopping channel carrier frequencies that are separated by 25 kHz or two-thirds of the 20 dB bandwidth of the hopping channel, whichever is greater, provided the systems operate with an output power no greater than 125 mW.

TEST PROCEDURE

The transmitter output is connected to a spectrum analyzer. The RBW is set to 300 kHz and the VBW is set to 910 kHz. The sweep time is coupled.

RESULTS

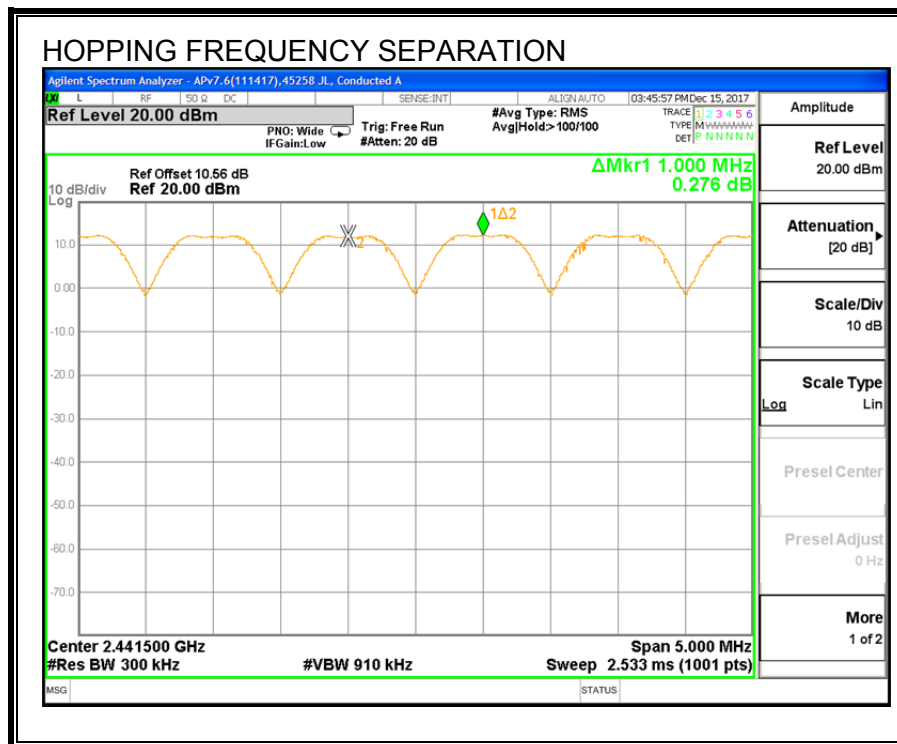

7.1.4. NUMBER OF HOPPING CHANNELS

LIMITS

FCC §15.247 (a) (1) (iii)

Frequency hopping systems in the 2400 – 2483.5 MHz band shall use at least 15 non-overlapping channels.

TEST PROCEDURE

The transmitter output is connected to a spectrum analyzer. The span is set to cover the entire authorized band, in either a single sweep or in multiple contiguous sweeps. The RBW is set to a maximum of 1 % of the span. The analyzer is set to Max Hold.

RESULTS

Normal Mode: 79 Channels observed.

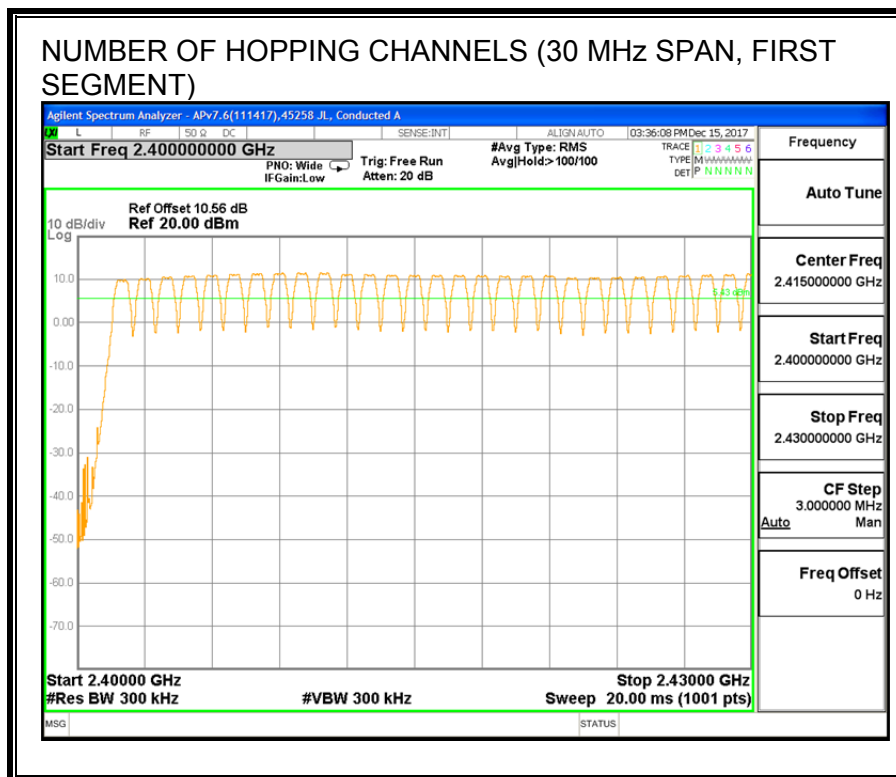
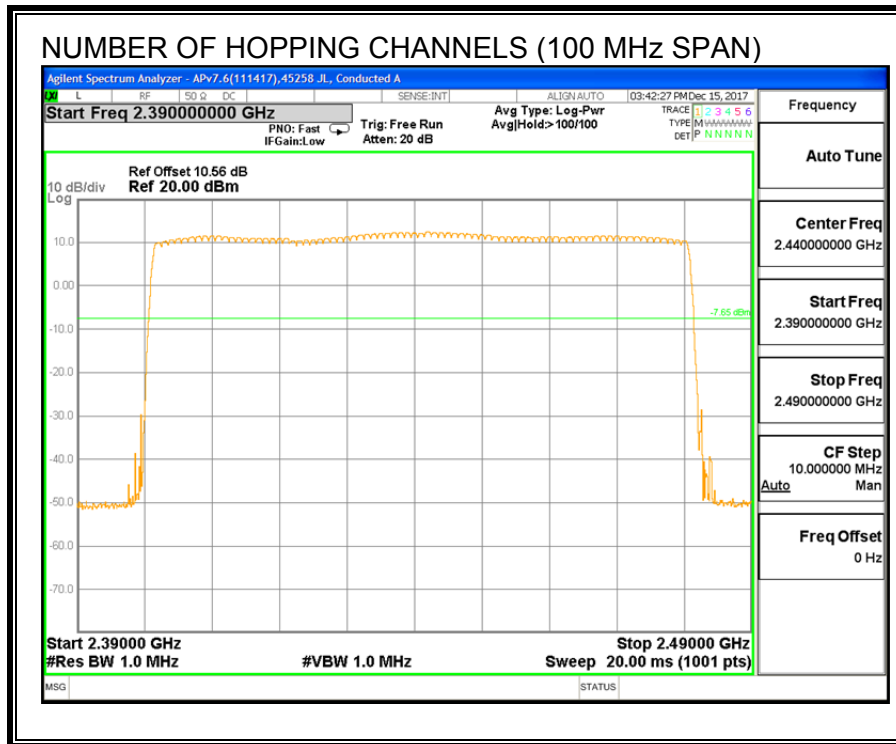

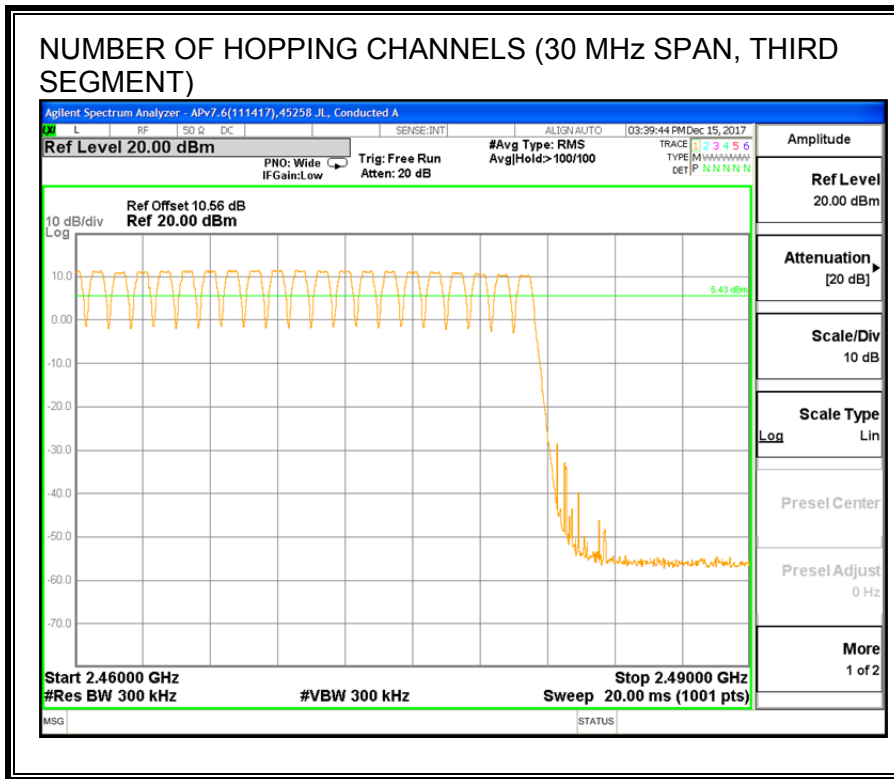
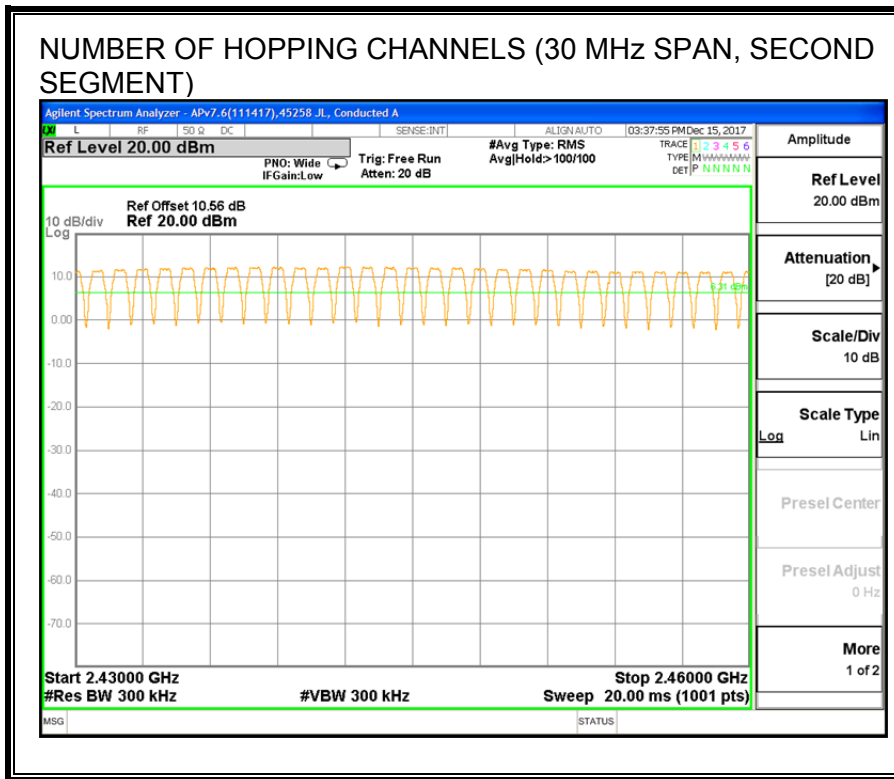

7.1.5. AVERAGE TIME OF OCCUPANCY

LIMITS

FCC §15.247 (a) (1) (iii)

The average time of occupancy on any channel shall not be greater than 0.4 seconds within a period of 0.4 seconds multiplied by the number of hopping channels employed.

TEST PROCEDURE

The transmitter output is connected to a spectrum analyzer. The span is set to 0 Hz, centered on a single, selected hopping channel. The width of a single pulse is measured in a fast scan. The number of pulses is measured in a 3.16 second scan, to enable resolution of each occurrence.

The average time of occupancy in the specified 31.6 second period (79 channels * 0.4 s) is equal to $10 * (\# \text{ of pulses in } 3.16 \text{ s}) * \text{ pulse width}$.

For AFH mode, the average time of occupancy in the specified 8 second period (20 channels * 0.4 seconds) is equal to $10 * (\# \text{ of pulses in } 0.8 \text{ s}) * \text{ pulse width}$.

RESULTS

AVERAGE TIME OF OCCUPANCY					
DH Packet	Pulse Width (msec)	Number of Pulses in 3.16 seconds	Average Time of Occupancy (sec)	Limit (sec)	Margin (sec)
GFSK Normal Mode					
DH1	0.382	32	0.1222	0.4	-0.2778
DH3	1.639	15	0.2459	0.4	-0.1542
DH5	2.887	13	0.3753	0.4	-0.0247
DH Packet	Pulse Width (sec)	Number of Pulses in 0.8 seconds	Average Time of Occupancy (sec)	Limit (sec)	Margin (sec)
GFSK AFH Mode					
DH1	0.382	8	0.03056	0.4	-0.3694
DH3	1.639	3.75	0.06146	0.4	-0.3385
DH5	2.887	3.25	0.09383	0.4	-0.3062
NOTE: --					

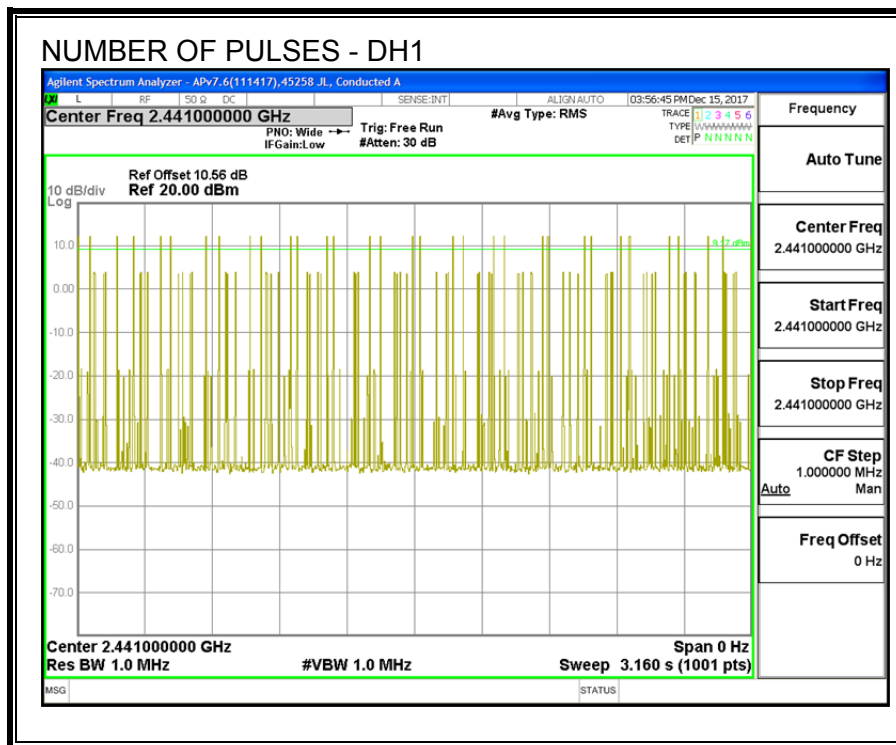
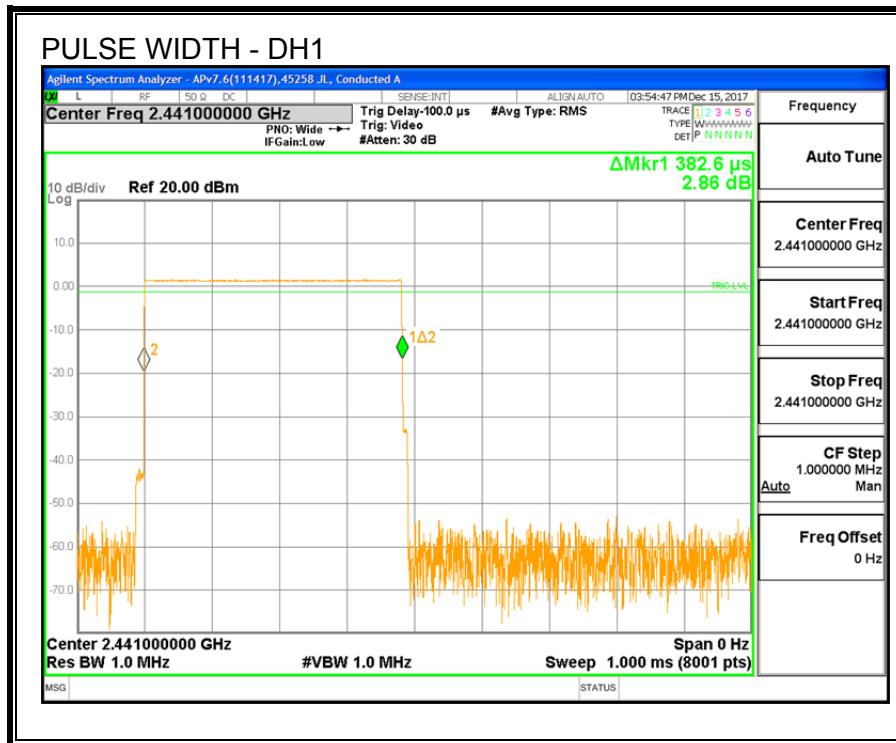

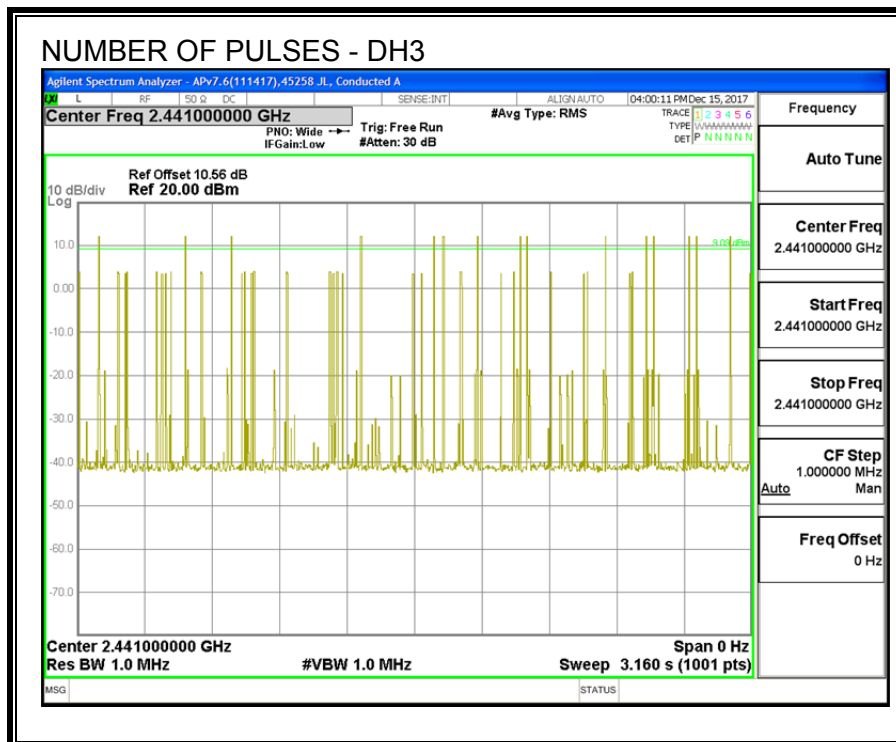
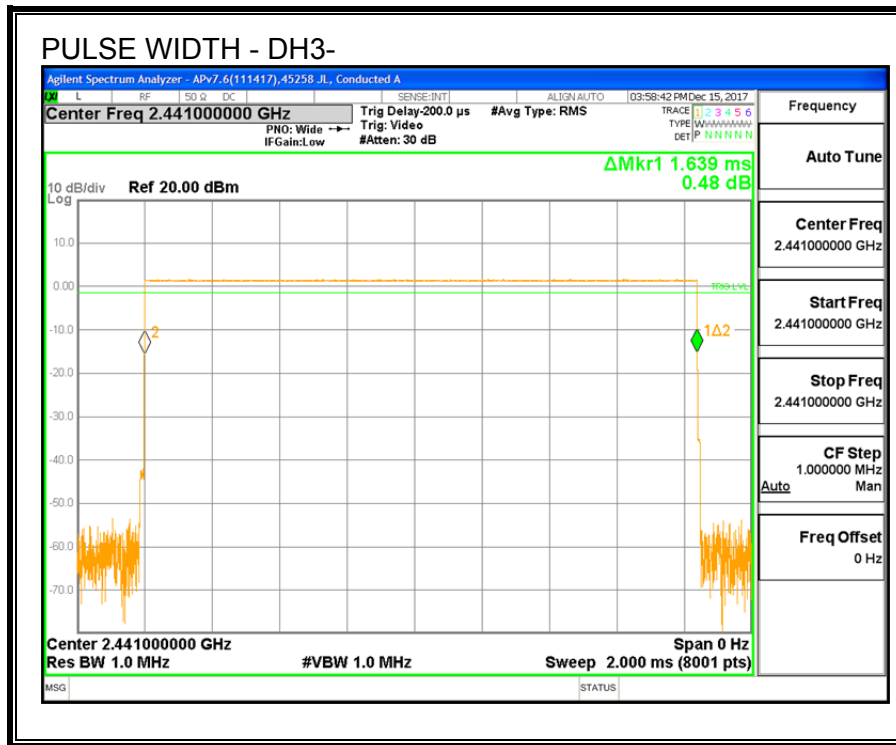

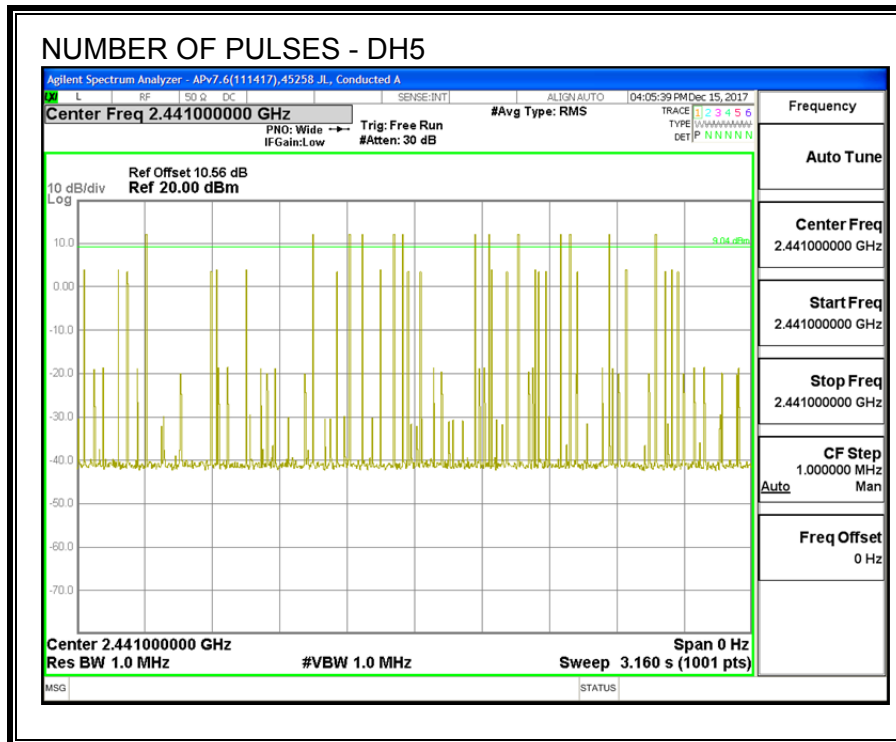
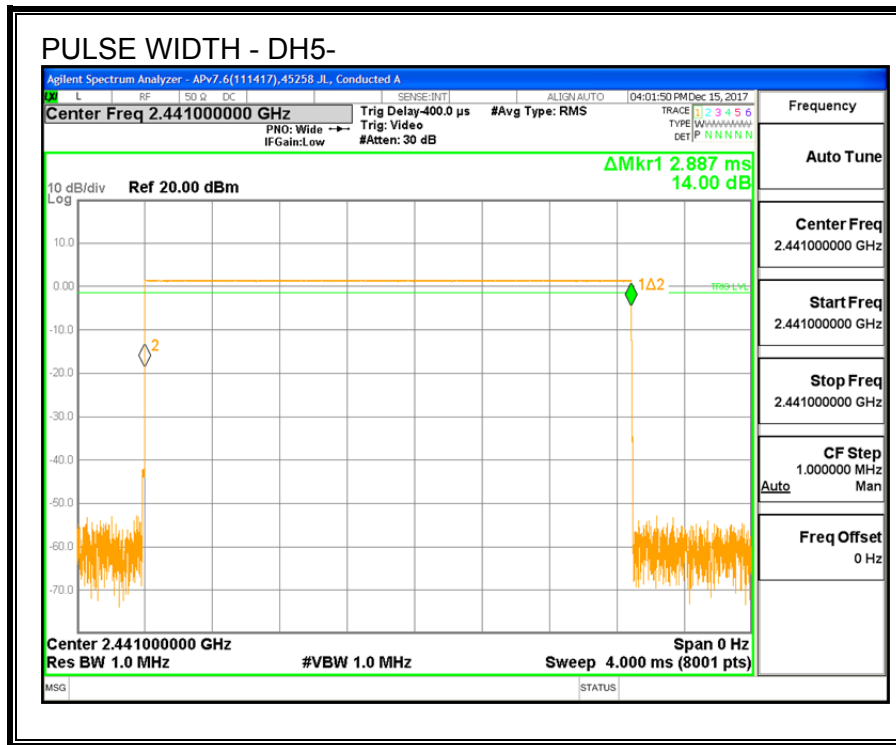

7.1.6. OUTPUT POWER

LIMITS

§15.247 (b) (1)

The maximum antenna gain is less than or equal to 6 dBi, therefore the limit is 30 dBm.

TEST PROCEDURE

The transmitter output is connected to a power meter.

The cable assembly insertion loss of 10.6 dB (consisting of 10 dB pad and 0.6 dB cable) is entered as an offset in the power meter to enable direct reading of the power. The power meter is gated to measure peak power during the ON time of the transmitter.

RESULTS

TEST ENGINEER:	29435 TC	Date:	12/7/2017
-----------------------	----------	--------------	-----------

Channel	Frequency (MHz)	Output Power (dBm)	Limit (dBm)	Margin (dB)
Low	2402	10.00	30	-20
Middle	2441	11.13	30	-18.87
High	2480	9.43	30	-20.57

7.1.7. AVERAGE POWER

LIMITS

None; for reporting purposes only.

TEST PROCEDURE

The transmitter output is connected to a power meter.

The cable assembly insertion loss of 10.6 dB (consisting of 10 dB pad and 0.6 dB cable) is entered as an offset in the power meter to enable direct reading of the power. The power meter is gated to measure average power during the ON time of the transmitter.

RESULTS

TEST ENGINEER:	29435 TC	Date:	12/7/2017
-----------------------	----------	--------------	-----------

Channel	Frequency (MHz)	Average Power (dBm)
Low	2402	9.84
Middle	2441	10.88
High	2480	9.24

7.1.8. CONDUCTED BANDEDGE AND SPURIOUS EMISSIONS

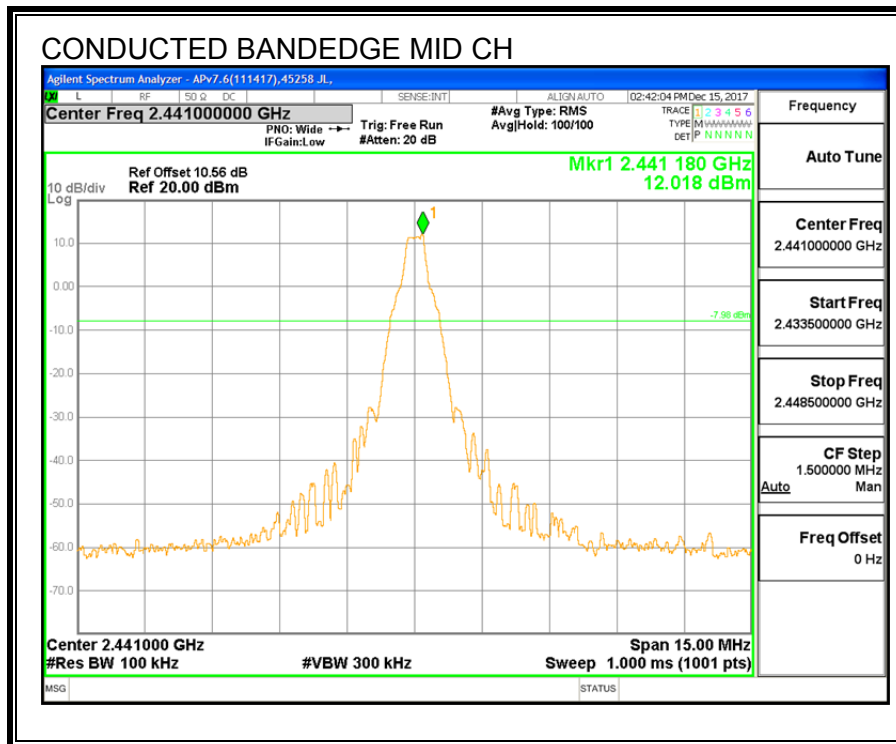
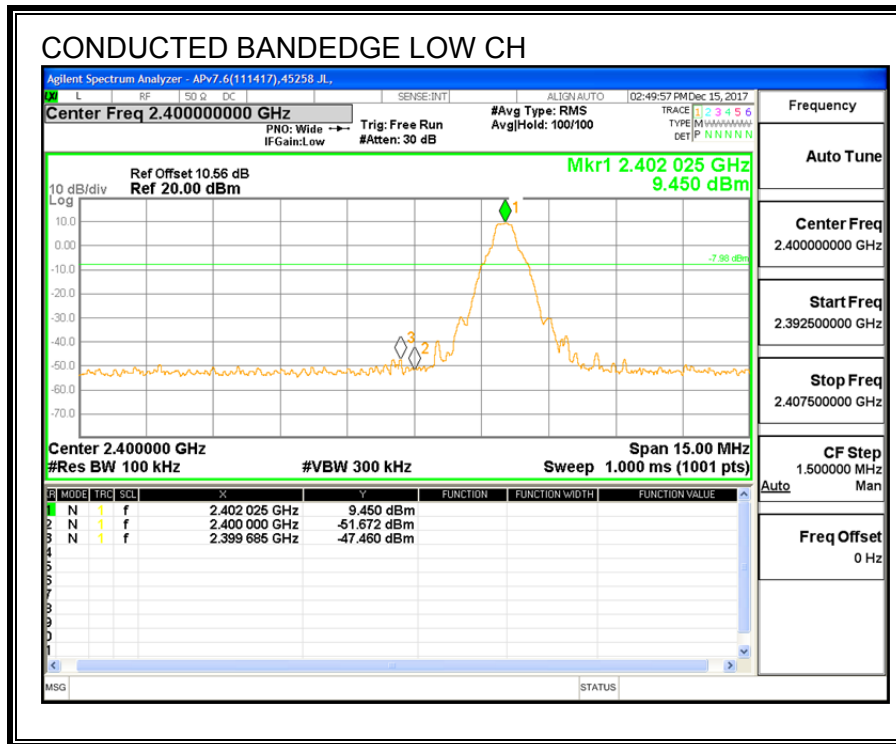

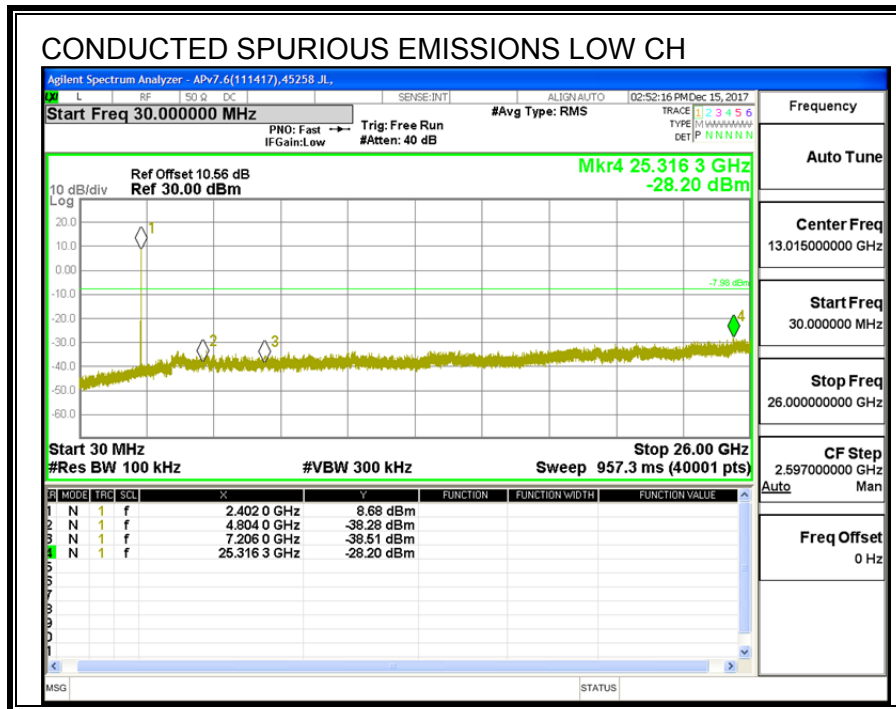
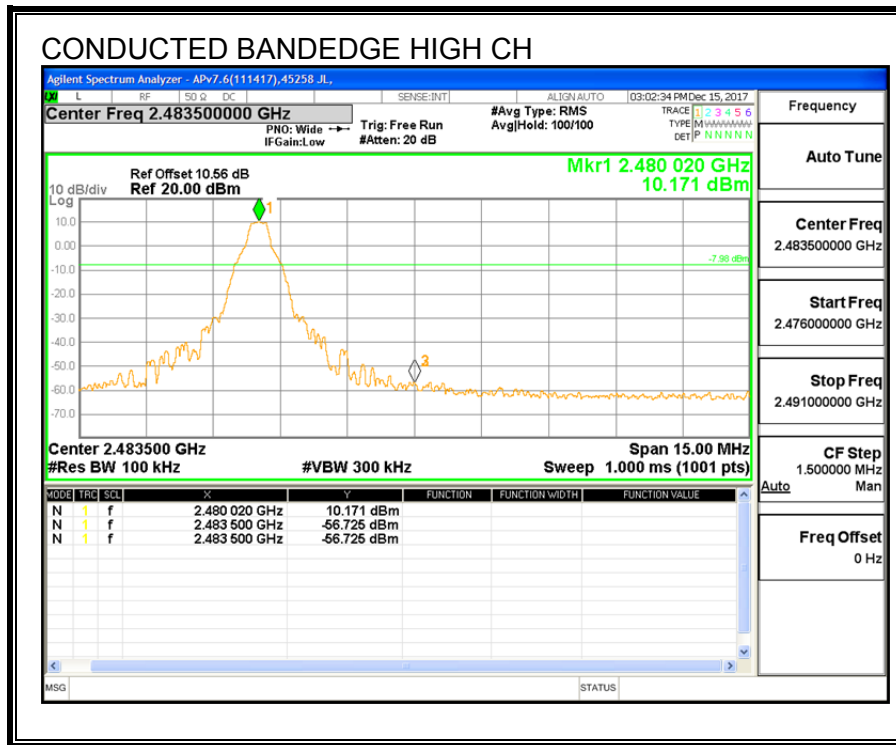

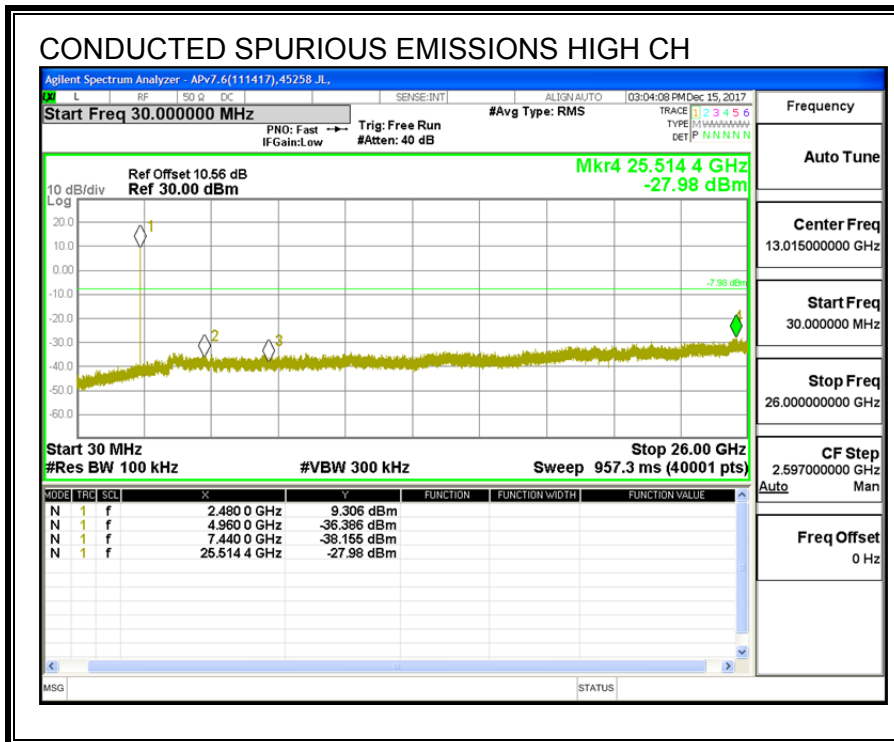
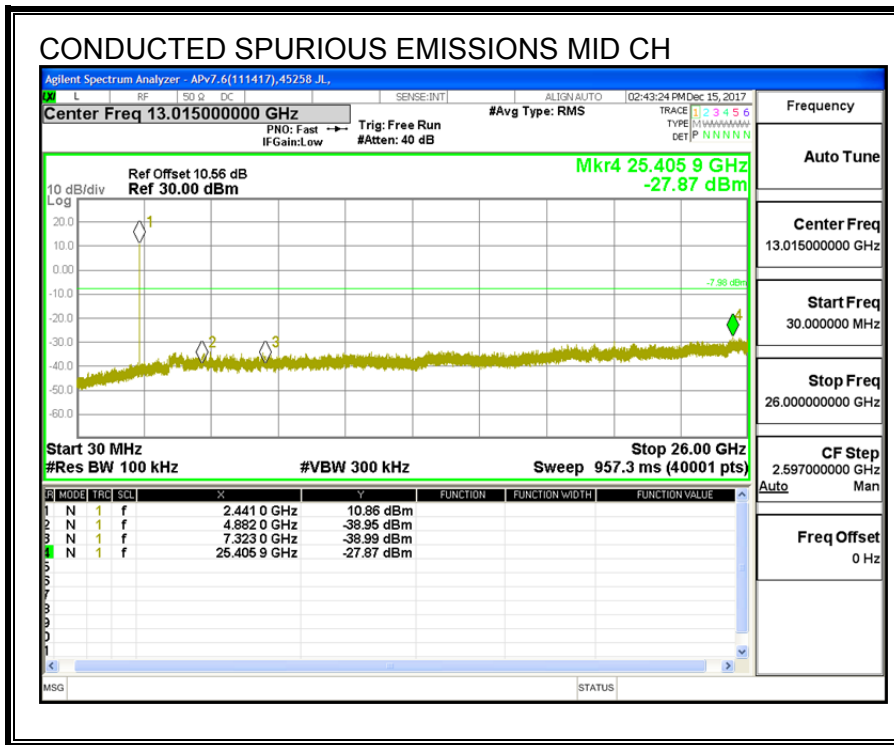

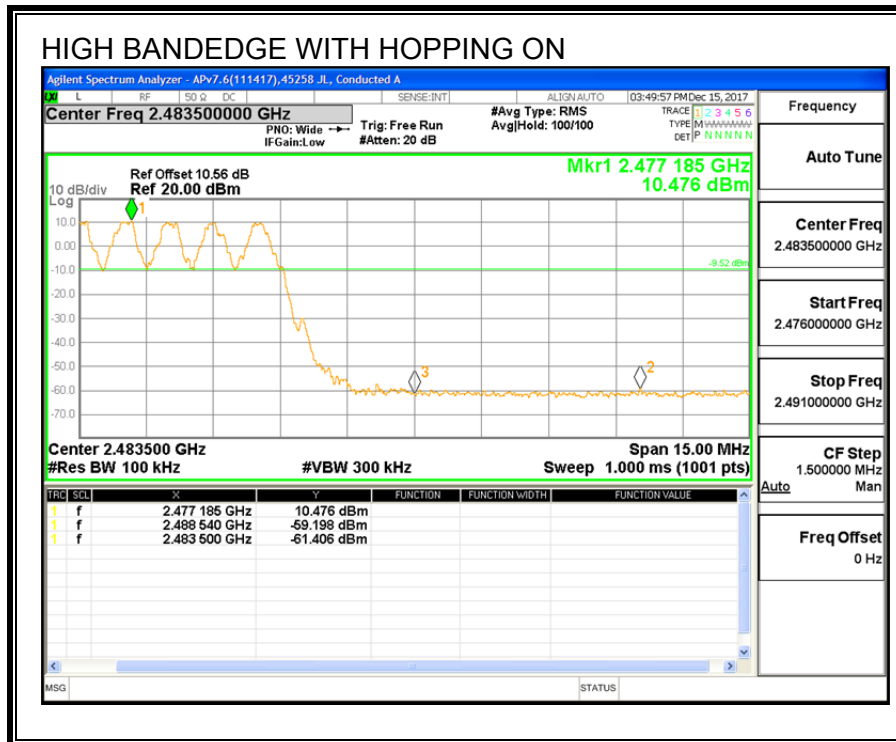
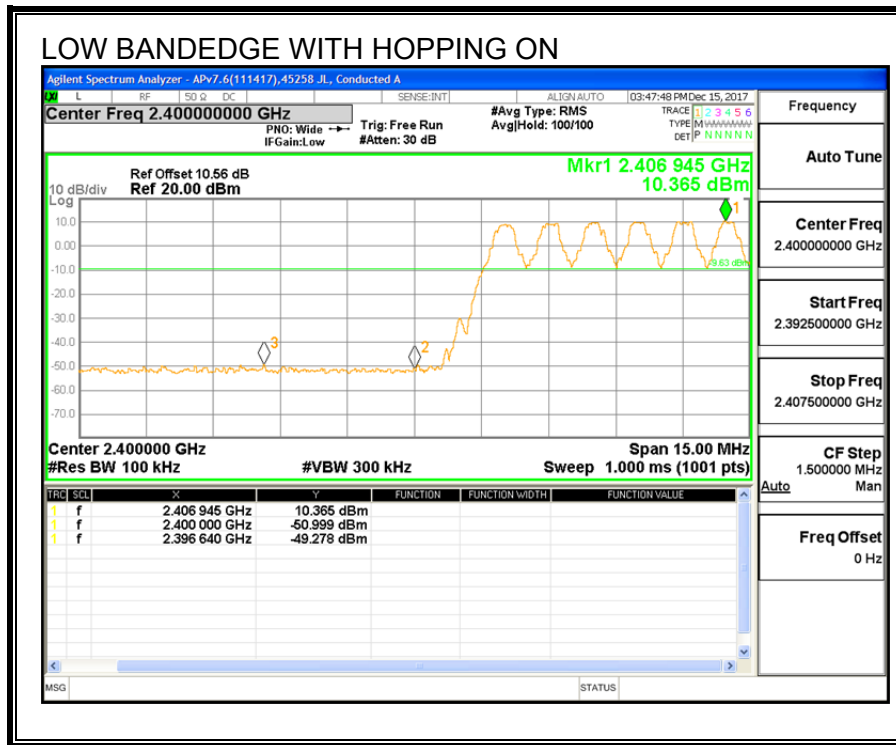

7.2. ENHANCED DATA RATE 8PSK MODULATION

7.2.1. 20 dB BANDWIDTH

LIMITS

None; for reporting purposes only.

TEST PROCEDURE

The transmitter output is connected to a spectrum analyzer. The RBW is set to $\geq 1\%$ of the 20 dB bandwidth. The VBW is set to \geq RBW. The sweep time is coupled.

RESULTS

Channel	Frequency (MHz)	20 dB Bandwidth (MHz)
Low	2402	1.340
Middle	2441	1.364
High	2480	1.332

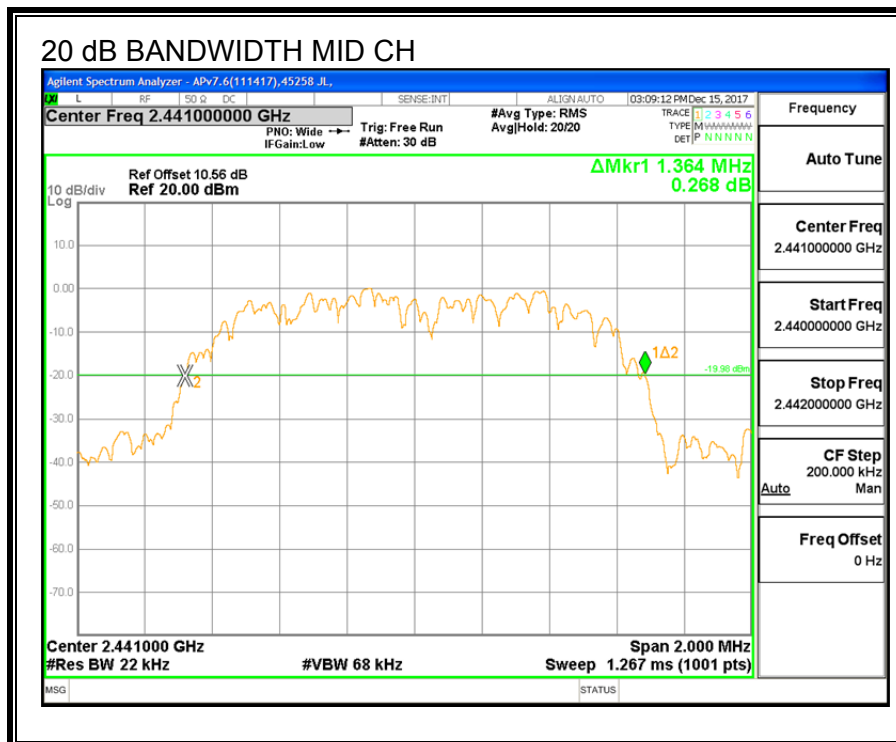
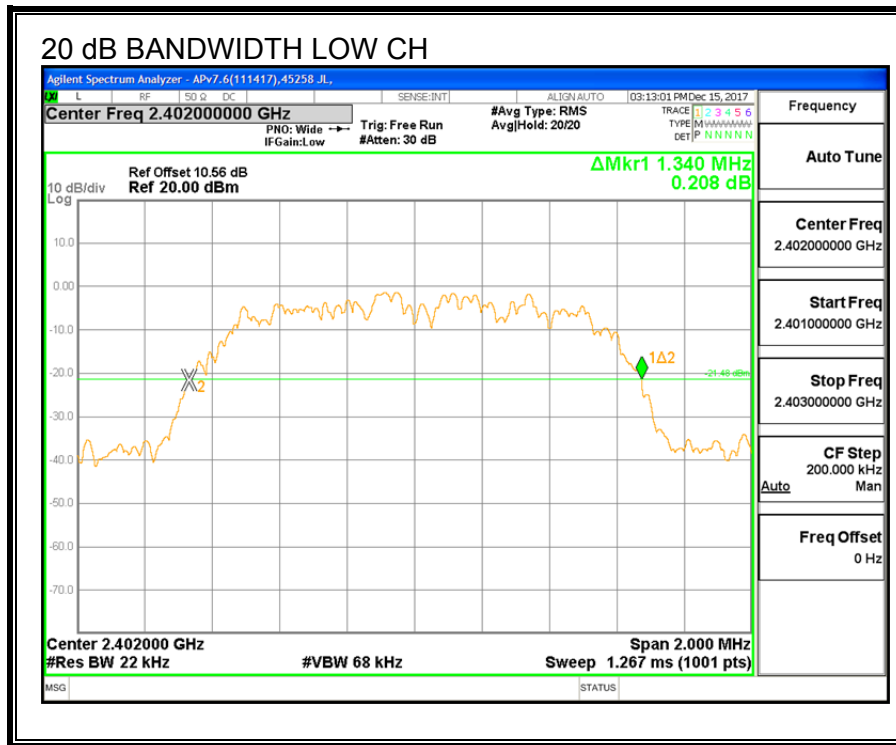

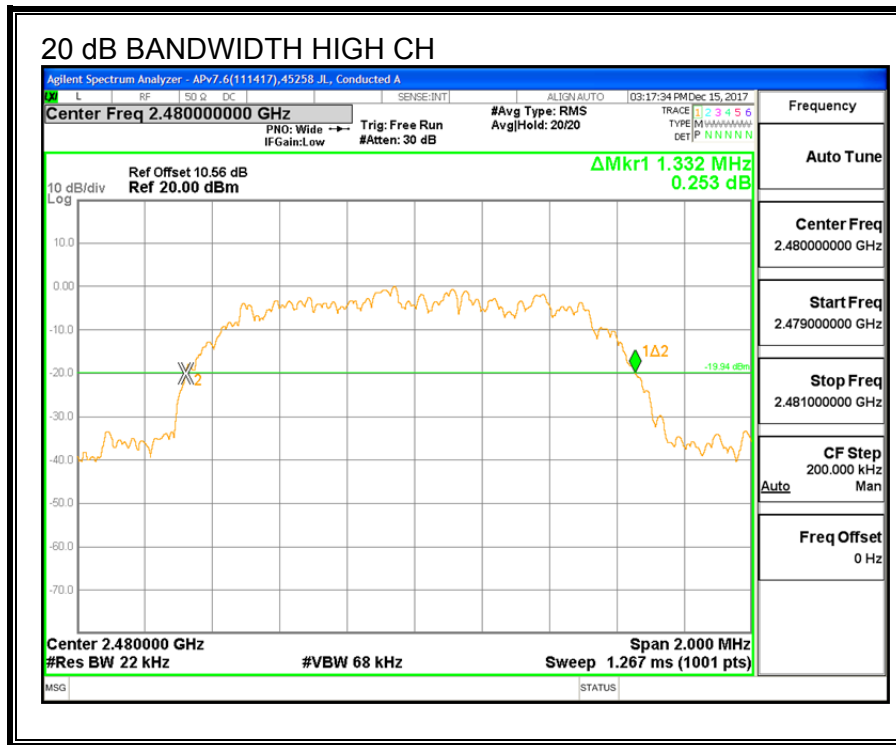

7.2.1. 99% BANDWIDTH

LIMITS

None; for reporting purposes only.

TEST PROCEDURE

The transmitter output is connected to a spectrum analyzer. The RBW is set to 1%-5% the OBW. The VBW is set to ≥ 3 times RBW. The sweep time is coupled.

RESULTS

Channel	Frequency (MHz)	99% Bandwidth (MHz)
Low	2402	1.1903
Middle	2441	1.1915
High	2480	1.1955

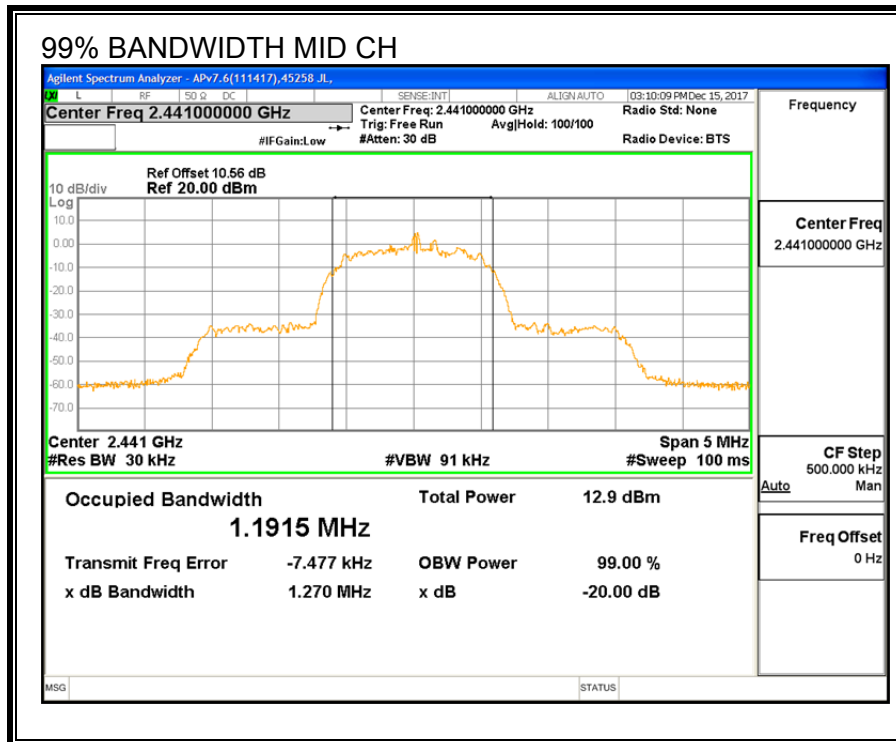
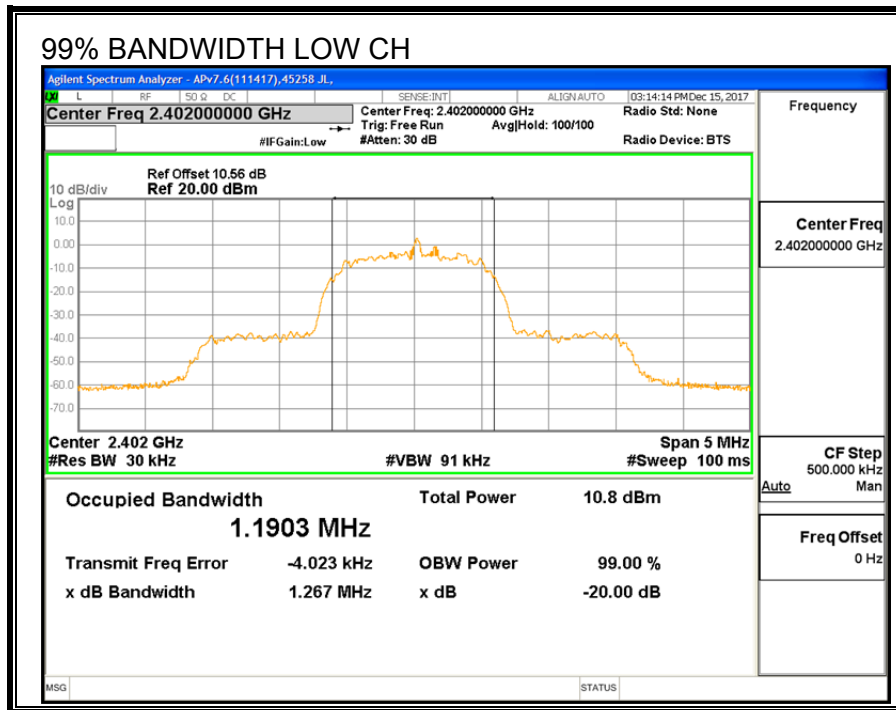

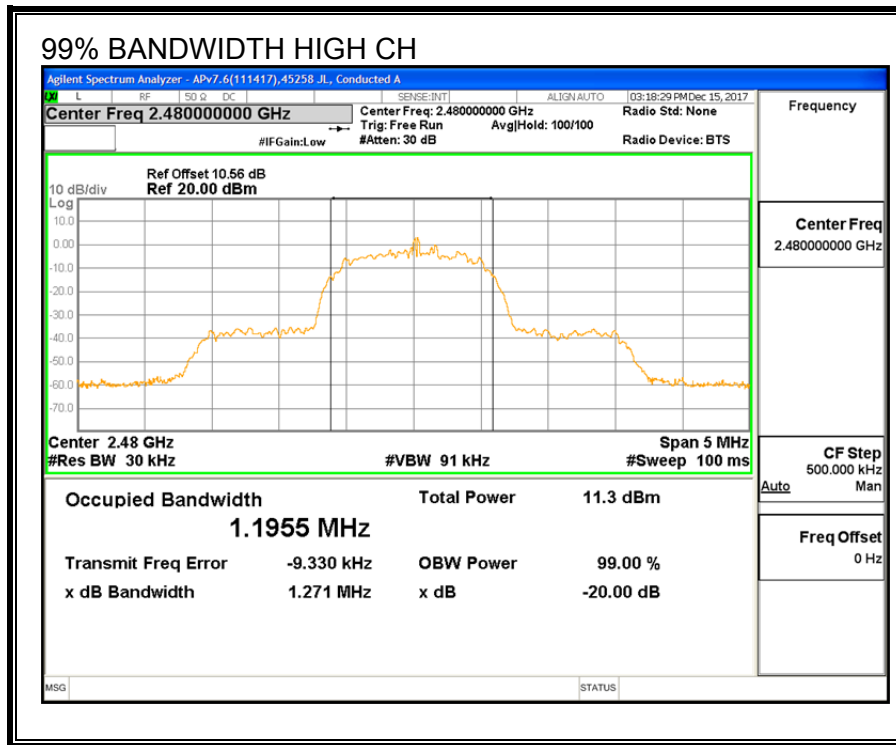

7.2.2. HOPPING FREQUENCY SEPARATION

LIMITS

FCC §15.247 (a) (1)

Frequency hopping systems shall have hopping channel carrier frequencies separated by a minimum of 25 kHz or the 20 dB bandwidth of the hopping channel, whichever is greater.

Alternatively, frequency hopping systems operating in the 2400-2483.5 MHz band may have hopping channel carrier frequencies that are separated by 25 kHz or two-thirds of the 20 dB bandwidth of the hopping channel, whichever is greater, provided the systems operate with an output power no greater than 125 mW.

TEST PROCEDURE

The transmitter output is connected to a spectrum analyzer. The RBW is set to 300 kHz and the VBW is set to 910 kHz. The sweep time is coupled.

RESULTS

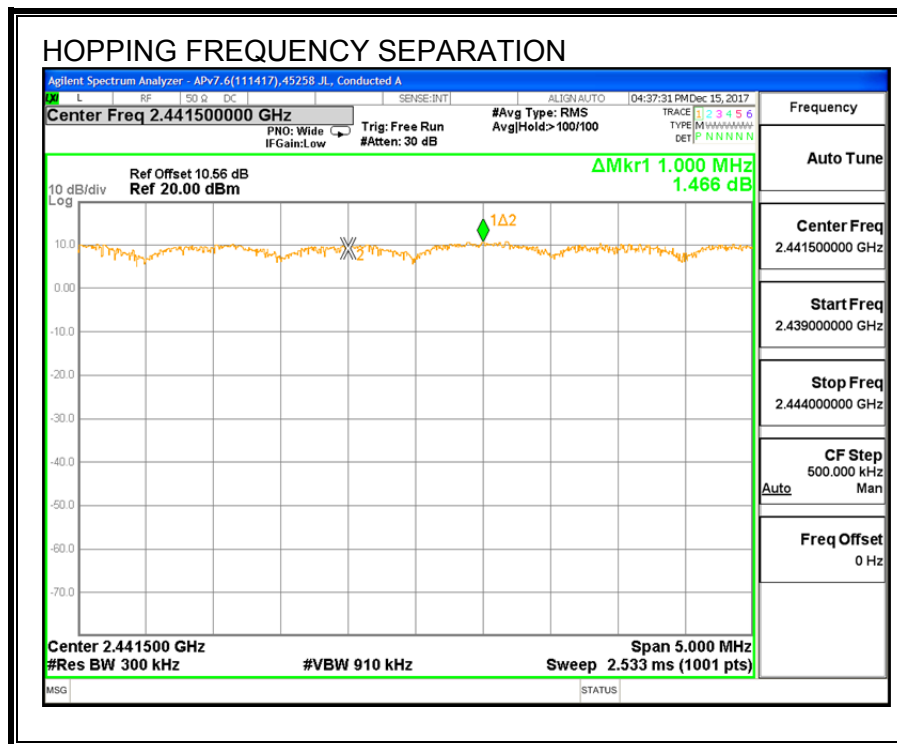

7.2.3. NUMBER OF HOPPING CHANNELS

LIMITS

FCC §15.247 (a) (1) (iii)

Frequency hopping systems in the 2400 – 2483.5 MHz band shall use at least 15 non-overlapping channels.

TEST PROCEDURE

The transmitter output is connected to a spectrum analyzer. The span is set to cover the entire authorized band, in either a single sweep or in multiple contiguous sweeps. The RBW is set to a maximum of 1 % of the span. The analyzer is set to Max Hold.

RESULTS

Normal Mode: 79 Channels observed.

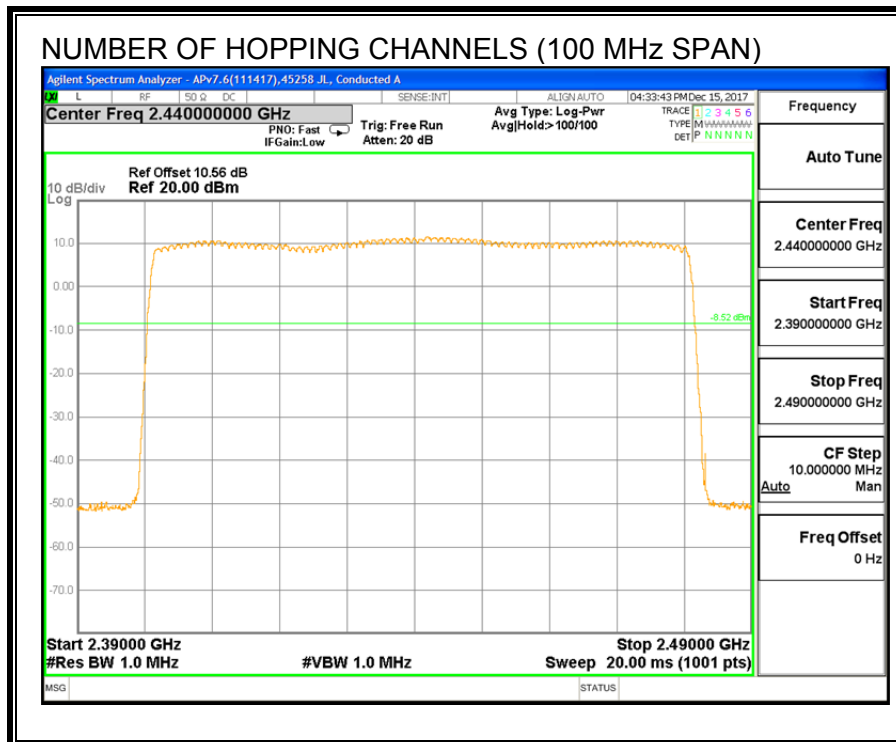

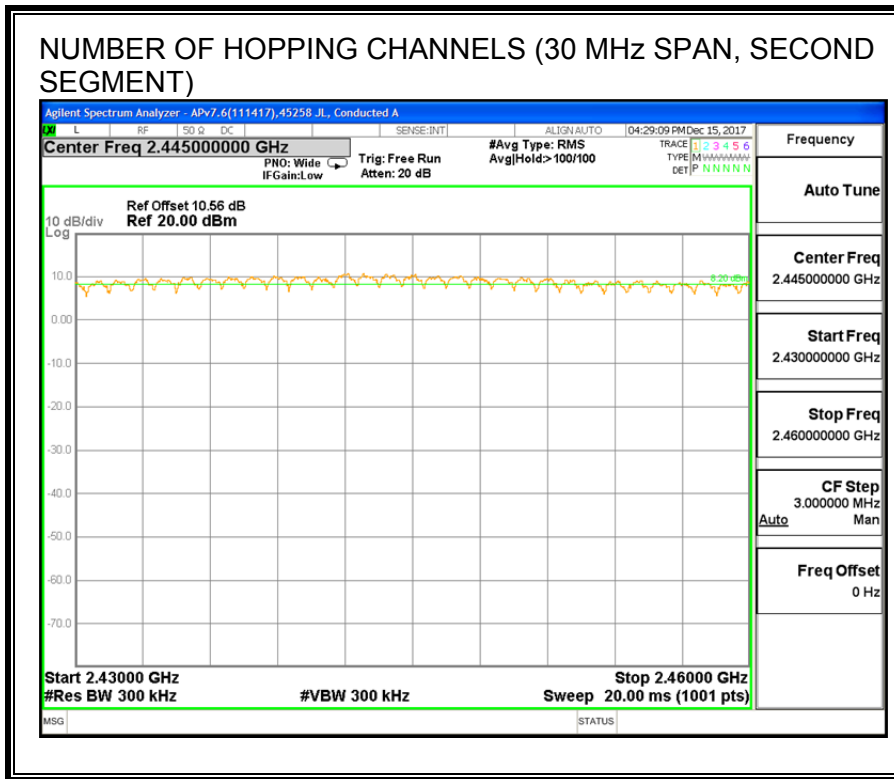
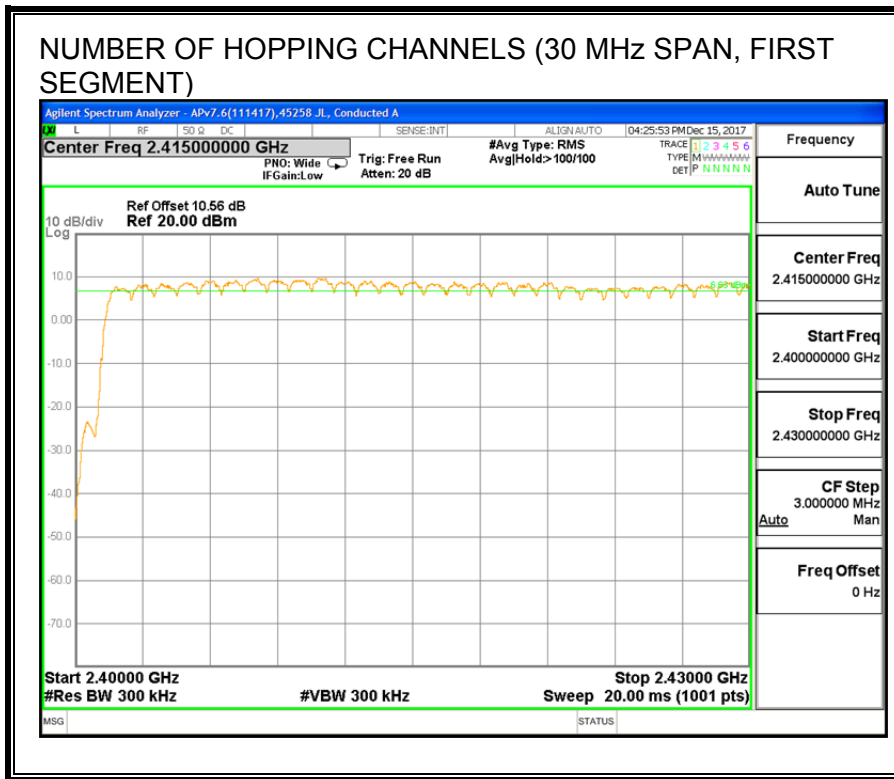

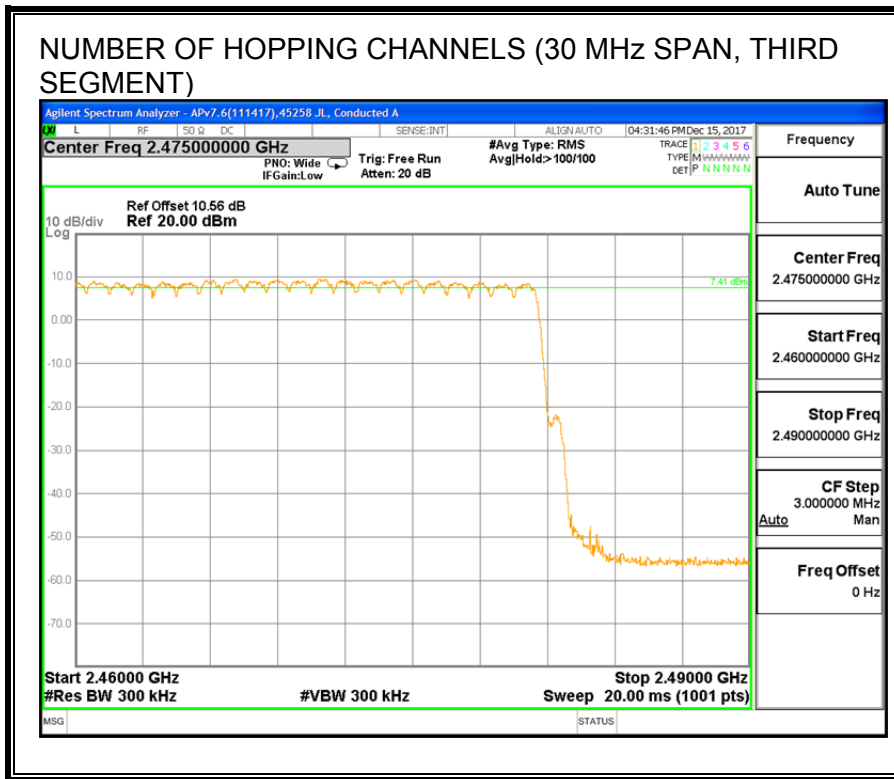

7.2.4. AVERAGE TIME OF OCCUPANCY

LIMITS

FCC §15.247 (a) (1) (iii)

The average time of occupancy on any channel shall not be greater than 0.4 seconds within a period of 0.4 seconds multiplied by the number of hopping channels employed.

TEST PROCEDURE

The transmitter output is connected to a spectrum analyzer. The span is set to 0 Hz, centered on a single, selected hopping channel. The width of a single pulse is measured in a fast scan. The number of pulses is measured in a 3.16 second scan, to enable resolution of each occurrence.

The average time of occupancy in the specified 31.6 second period (79 channels * 0.4 s) is equal to $10 * (\# \text{ of pulses in } 3.16 \text{ s}) * \text{ pulse width}$.

For AFH mode, the average time of occupancy in the specified 8 second period (20 channels * 0.4 seconds) is equal to $10 * (\# \text{ of pulses in } 0.8 \text{ s}) * \text{ pulse width}$.

RESULTS

AVERAGE TIME OF OCCUPANCY					
DH Packet	Pulse Width (msec)	Number of Pulses in 3.16 seconds	Average Time of Occupancy (sec)	Limit (sec)	Margin (sec)
8PSK Normal Mode					
3-DH1	0.388	32	0.1243	0.4	-0.2757
3-DH3	1.640	15	0.2460	0.4	-0.1540
3-DH5	2.891	12	0.3469	0.4	-0.0531
DH Packet	Pulse Width (sec)	Number of Pulses in 0.8 seconds	Average Time of Occupancy (sec)	Limit (sec)	Margin (sec)
8PSK AFH Mode					
DH1	0.388	8	0.03106	0.4	-0.3689
DH3	1.640	3.75	0.06150	0.4	-0.3385
DH5	2.891	3	0.08673	0.4	-0.3133
NOTE: --					

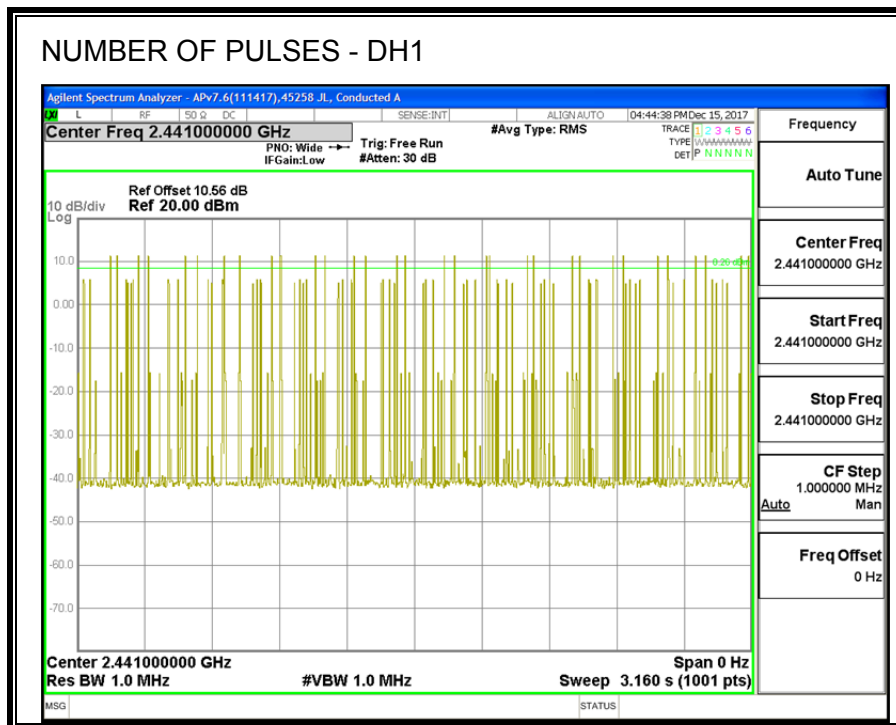
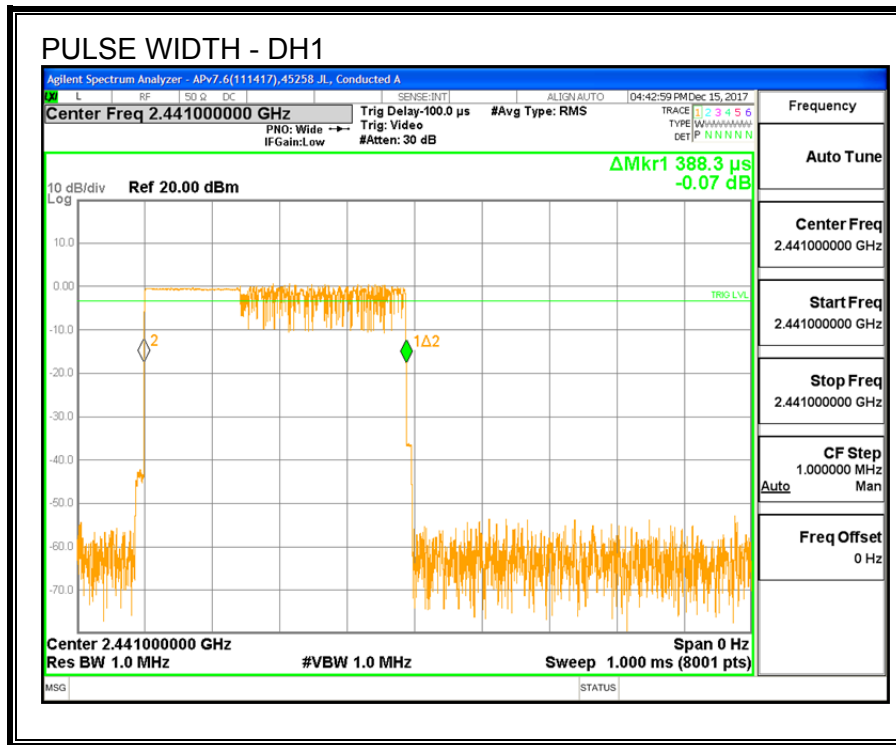

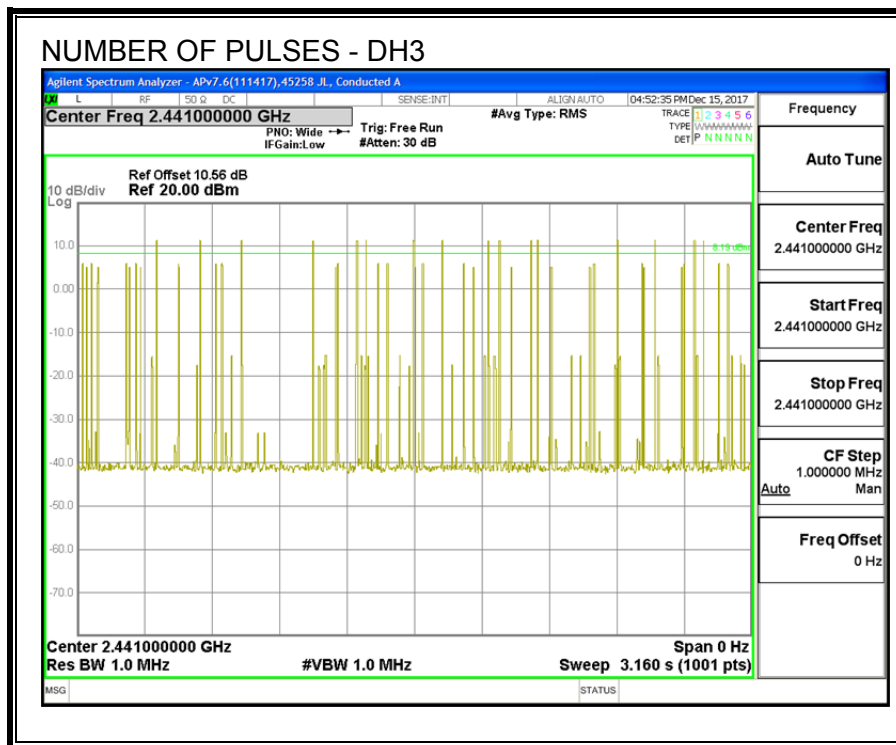
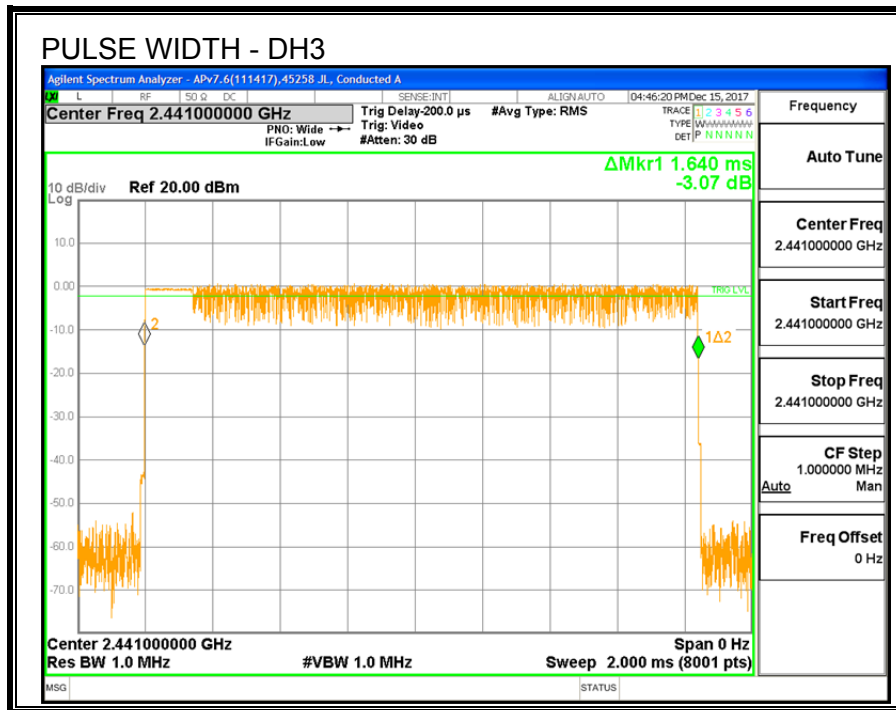

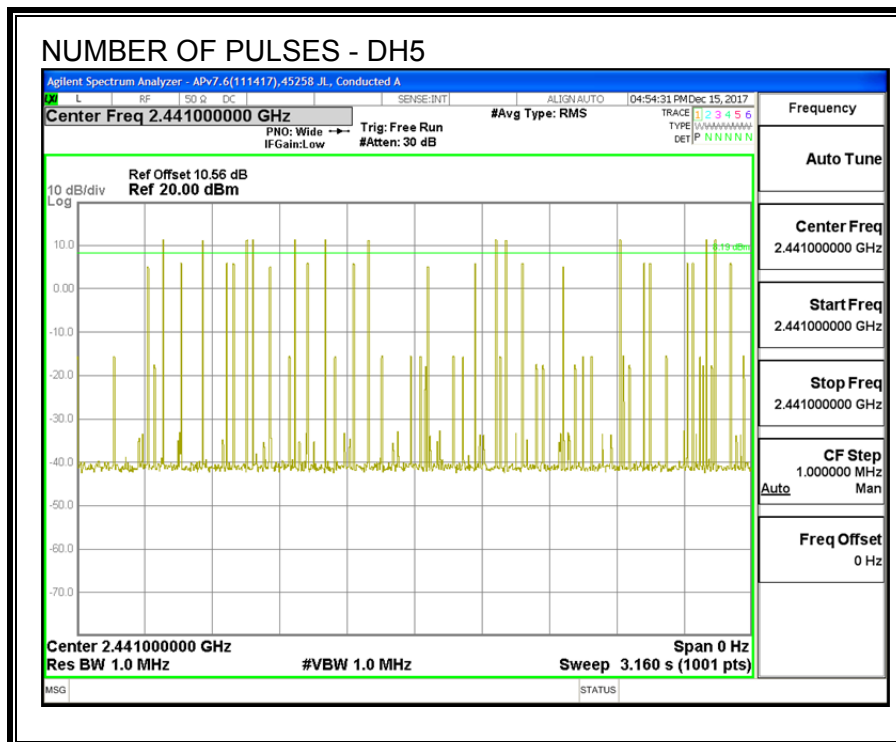
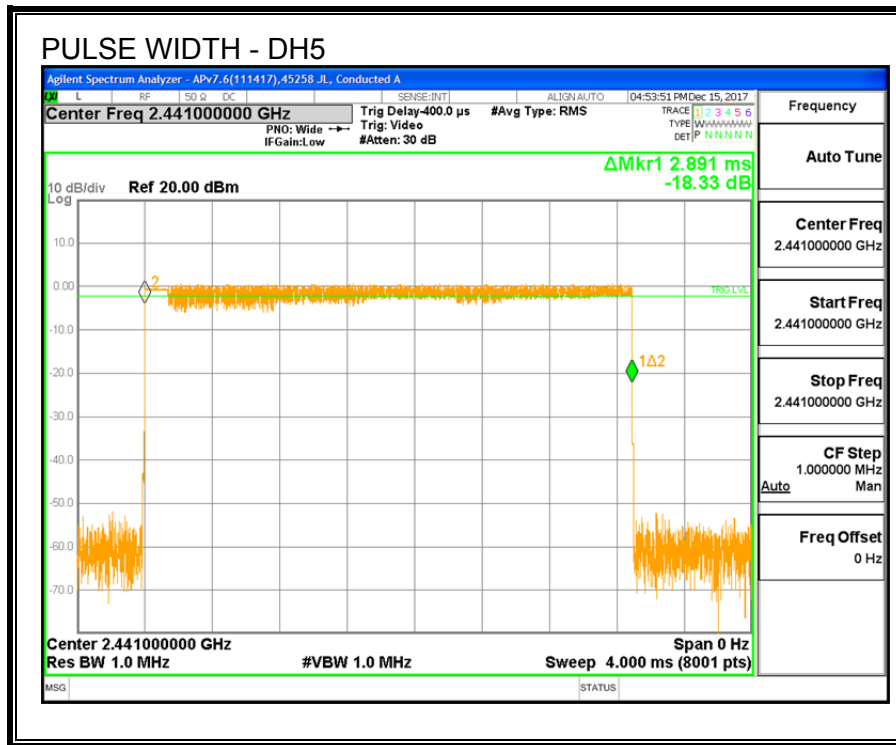

7.2.5. OUTPUT POWER

LIMITS

§15.247 (b) (1)

The maximum antenna gain is less than 6 dBi, therefore the limit is 30 dBm.

TEST PROCEDURE

The transmitter output is connected to a power meter.

The cable assembly insertion loss of 10.6 dB (consisting of 10 dB pad and 0.6 dB cable) is entered as an offset in the power meter to enable direct reading of the power. The power meter is gated to measure peak power during the ON time of the transmitter.

RESULTS

TEST ENGINEER:	29435 TC	Date:	12/7/2017
-----------------------	----------	--------------	-----------

Channel	Frequency (MHz)	Output Power (dBm)	Limit (dBm)	Margin (dB)
Low	2402	7.83	30	-22.17
Middle	2441	8.98	30	-21.02
High	2480	7.52	30	-22.48

7.2.6. AVERAGE POWER

LIMITS

None; for reporting purposes only.

TEST PROCEDURE

The transmitter output is connected to a power meter.

The cable assembly insertion loss of 10.6 dB (consisting of 10 dB pad and 0.6 dB cable) is entered as an offset in the power meter to enable direct reading of the power. The power meter is gated to measure average power during the ON time of the transmitter.

RESULTS

TEST ENGINEER:	29435 TC	Date:	12/7/2017
-----------------------	----------	--------------	-----------

Channel	Frequency (MHz)	Average Power (dBm)
Low	2402	7.58
Middle	2441	8.75
High	2480	7.27