

FCC TEST REPORT

according to

FCC Rules and Regulations

Part 15 Subpart C

Applicant	Netgear Inc.
Address	4500 Great America Parkway Santa Clara California 95054 USA
Equipment	54 Mbps Wireless Game Adapter
Model No.	WGE111
FCC ID	PY3WGE111
Trade Name	Netgear

- The test result refers exclusively to the test presented test model / sample.,
- Without written approval of *Exclusive Certification Corp.* the test report shall not be reproduced except in full.

Contents

1.	Report of Measurements and Examinations	4
1.1.	List of Measurements and Examinations	4
1.2.	Antenna Requirements	5
1.3.	Test of Conducted Emission.....	6
1.4.	Test of Radiated Emission	8
1.5.	6dB Bandwidth	9
1.6.	Maximum Peak Output Power.....	9
1.7.	Band Edges Measurement	10
1.8.	Power Spectral Density	10
1.9.	Restricted Bands of Operation	11
1.10.	Labeling Requirement	11
1.11.	RF Exposure	12
2.	Test Configuration of Equipment under Test	14
2.1.	Test Mode and Test Software.....	14
2.2.	Description of Test System	14
2.3.	Connection Diagram of Test System.....	14
2.4.	Feature of Equipment under Test	15
2.5.	History of this test report	15
3.	General Information of Test.....	16
4.	Test Result and Data.....	17
4.1.	Antenna Requirement	17
4.2.	Test Result of Conducted Emission	18
4.3.	RF Portion.....	33
4.4.	6dB Bandwidth Measurement Data	49
4.5.	Peak Output Power Measurement Data.....	53
4.6.	Band Edges Measurement Data	57
4.7.	Power Spectral Density Measurement Data	70
4.8.	Test Result of RF Exposure Evaluation	74
5.	List of Measuring Equipment Used.....	75
	Appendix A. Photographs of EUT.....	A1 ~ A5

CERTIFICATE OF COMPLIANCE

according to

FCC Rules and Regulations

Part 15 Subpart C

Applicant	Netgear Inc.
Address	4500 Great America Parkway Santa Clara California 95054 USA
Equipment	54 Mbps Wireless Game Adapter
Model No.	WGE111
FCC ID	PY3WGE111

I HEREBY CERTIFY THAT :

The measurements shown in this test report were made in accordance with the procedures given in **ANSI C63.4**. The equipment was **passed** the test performed according to **FCC Rules and Regulations Part 15 Subpart C (2002)**. The test was carried out on Jun. 26, 2004 at *Exclusive Certification Corp.*

Signature

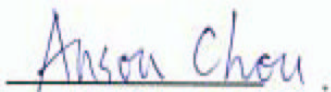

Anson Chou / Manager

1. Report of Measurements and Examinations

1.1. List of Measurements and Examinations

FCC Rule	Description of Test	Result
15.203	. Antenna Requirement	Pass
15.207	. Conducted Emission	Pass
15.209	. Radiated Emission	Pass
15.247(a)(2)	. 6dB Bandwidth	Pass
15.247(b)	. Maximum Peak Output Power	Pass
15.247(c)	. 100kHz Bandwidth of Frequency Band Edges	Pass
15.247(d)	. Power Spectral Density	Pass
1.1307 1.1310 2.1091 2.1093	. RF Exposure Compliance	Pass

Test by: Jerry

1.2. Antenna Requirements

1.2.1. Standard Applicable

For intentional device, according to FCC 47 CFR Section 15.203, an intentional radiator shall be designed to ensure that no antenna other than that furnished by the responsible party shall be used with the device.

And according to FCC 47 CFR Section 15.247 (b), if transmitting antennas of directional gain greater than 6dBi are used, the power shall be reduced by the amount in dB that the directional gain of the antenna exceeds 6dBi.

1.3. Test of Conducted Emission

Conducted Emissions were measured from 150 kHz to 30 MHz with a bandwidth of 9 KHz on the 115 VAC power and return leads of the EUT according to the methods defined in ANSI C63.4-1992 Section 3.1. The EUT was placed on a nonmetallic stand in a shielded room 0.8 meters above the ground plane as shown in section 2.2. The interface cables and equipment positioning were varied within limits of reasonable applications to determine the position produced maximum conducted emissions.

1.3.1. Test Procedures

- a. The EUT was placed 0.4 meter from the conducting wall of the shielding room was kept at least 80 centimeters from any other grounded conducting surface.
- b. Connect EUT to the power mains through a line impedance stabilization network (LISN).
- c. All the support units are connecting to the other LISN.
- d. The LISN provides 50 ohm coupling impedance for the measuring instrument.
- e. The FCC states that a 50 ohm, 50 microhenry LISN should be used.
- f. Both sides of AC line were checked for maximum conducted interference.
- g. The frequency range from 150 kHz to 30 MHz was searched.
- h. Set the test-receiver system to Peak Detect Function and Specified Bandwidth with Maximum Hold Mode.

1.3.2. Typical Test Setup Layout of Conducted Emission

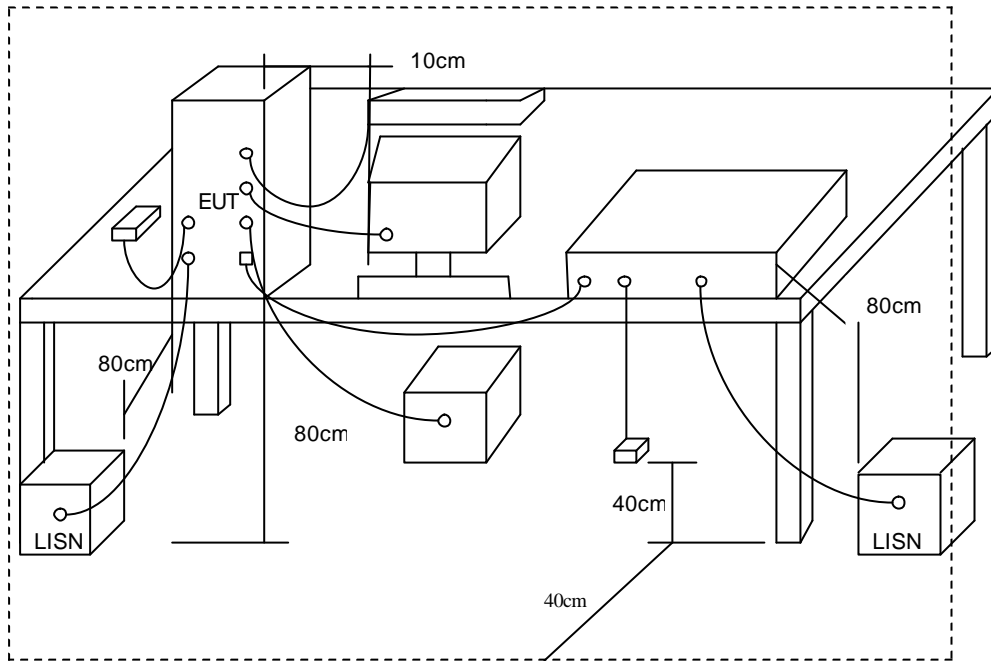

1.3.3. Conducted Emission Requirement

Except for A digital devices, for equipment that is designed to be connected to the public utility (AC) power line on any frequency voltage that is conducted back onto the AC power line on ant frequency or frequencies within the band 150KHz to 30MHz shall not exceed the limits in the following table, as measured using a 50μH/50 ohms line impeddance stabilization network (LISN). Compliance with the provisions of this paragraph shall be based on the measurement of the Radio frequency voltage between each power line and ground at the power terminal. The lower limit applies at the band edges.

Frequency (MHz)	Quasi Peak (dB μ V)	Average (dB μ V)
0.15 – 0.5	66-56*	56-46*
0.5 – 5.0	56	46
5.0 – 30.0	60	50

*Decreases with the logarithm of the frequency.

1.4. Test of Radiated Emission

Radiated emissions from 30 MHz to 25 GHz were measured according to the methods defines in ANSI C63.4-2001. The EUT was placed, 0.8 meter above the ground plane, as shown in section 5.6.3. The interface cables and equipment positions were varied within limits of reasonable applications to determine the positions producing maximum radiated emissions

1.4.1. Test Procedures

1. The EUT was placed on a rotatable table top 0.8 meter above ground.
2. The EUT was set 3 meters from the interference receiving antenna which was mounted on the top of a variable height antenna tower.
3. The table was rotated 360 degrees to determine the position of the highest radiation.
4. The antenna is a broadband antenna and its height is varied between one meter and four meters above ground to find the maximum value of the field strength both horizontal polarization and vertical polarization of the antenna are set to make the measurement.
5. For each suspected emission the EUT was arranged to its worst case and then tune the antenna tower (from 1 M to 4 M) and turn table (from 0 degree to 360 degrees) to find the maximum reading.
6. Set the test-receiver system to Peak or CISPR quasi-peak Detect Function and specified bandwidth with Maximum Hold Mode.
7. If the emission level of the EUT in peak mode was 3 dB lower than the limit specified, then testing will be stopped and peak values of EUT will be reported, otherwise, the emissions which do not have 3 dB margin will be repeated one by one using the quasi-peak method and reported.
8. For testing above 1GHz, the emission level of the EUT in peak mode was 20dB lower than average limit (that means the emission level in peak mode also complies with the limit in average mode), then testing will be stopped and peak values of EUT will be reported, otherwise, the emissions will be measured in average mode again and reported.

1.4.2. Typical Test Setup Layout of Radiated Emission

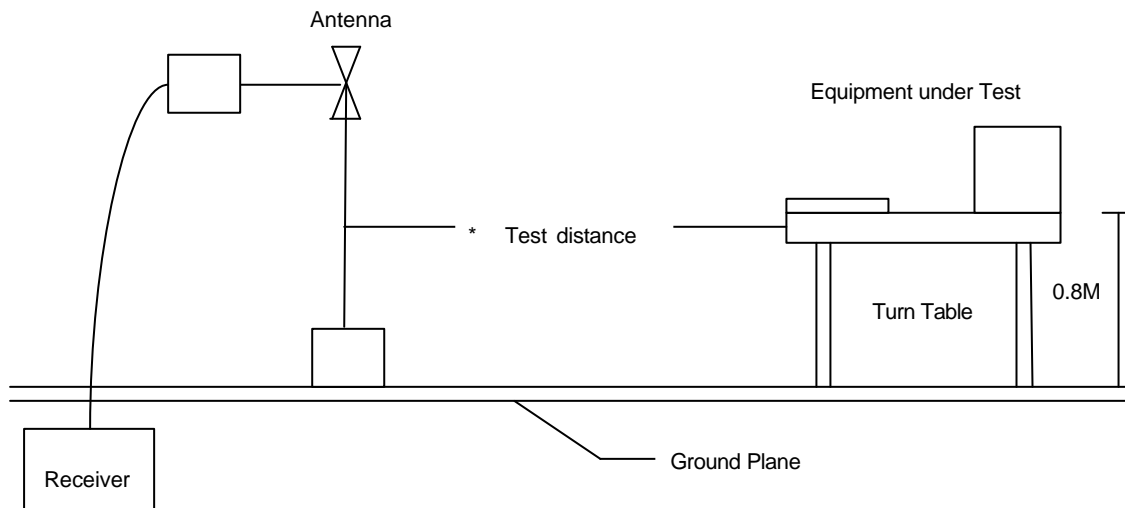

1.5. 6dB Bandwidth

1.5.1. Test Procedure :

1. The transmitter output was connected to the spectrum analyzer.
2. Set RBW of spectrum analyzer to 100 KHz and VBW to 100 KHz.
3. The 6 dB bandwidth is defined as the total spectrum the power of which is higher than peak power minus 6 dB.

1.5.2. Test Setup Layout :

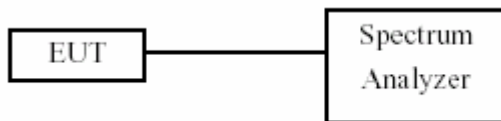

1.6. Maximum Peak Output Power

1.6.1. Test Procedure :

The antenna port (RF output) of the EUT was connected to the input (RF input) of a spectrum analyzer. Power was read directly from the spectrum analyzer and cable loss connection was added to the reading to obtain power at the EUT antenna terminal. The EUT Output Power was set to maximum to produce the worse case test result.

1.6.2. Test Setup Layout :

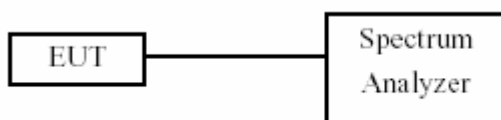

1.7. Band Edges Measurement

1.7.1. Test Procedure :

1. The transmitter output was connected to the spectrum analyzer via a low lose cable.
2. Set both RBW and VBW of spectrum analyzer to 100 KHz with convenient frequency span including 100 MHz bandwidth from band edge.
3. The band edges was measured and recorded.

1.8. Power Spectral Density

1.8.1. Test Procedure :

1. The transmitter output was connected to spectrum analyzer.
2. The spectrum analyzer' s resolution bandwidth were set at 3KHz RBW and 30KHz VBW as that of the fundamental frequency. Set the sweep time=span/3KHz.
3. The power spectral density was measured and recorded.
4. The Sweep time is allowed to be longer than span/3KHz for a full response of the mixer in the spectrum analyzer.

1.8.2. Test Setup Layout :

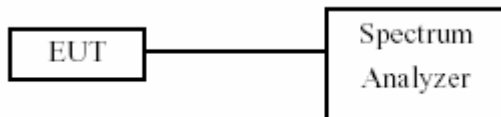

1.9. Restricted Bands of Operation

Only spurious emissions are permitted in any of the frequency bands listed below:

MHz	MHz	MHz	GHz
0.09000 – 0.11000	16.42000 – 16.42300	399.9 – 410.0	4.500 – 5.250
0.49500 – 0.505**	16.69475 – 16.69525	608.0 – 614.0	5.350 – 5.460
2.17350 – 2.19050	16.80425 – 16.80475	960.0 – 1240.0	7.250 – 7.750
4.12500 – 4.12800	25.50000 – 25.67000	1300.0 – 1427.0	8.025 – 8.500
4.17725 – 4.17775	37.50000 – 38.25000	1435.0 – 1626.5	9.000 – 9.200
4.20725 – 4.20775	73.00000 – 74.60000	1645.5 – 1646.5	9.300 – 9.500
6.21500 – 6.21800	74.80000 – 75.20000	1660.0 – 1710.0	10.600 – 12.700
6.26775 – 6.26825	108.00000 – 121.94000	1718.8 – 1722.2	13.250 – 13.400
6.31175 – 6.31225	123.00000 – 138.00000	2200.0 – 2300.0	14.470 – 14.500
8.29100 – 8.29400	149.90000 – 150.05000	2310.0 – 2390.0	15.350 – 16.200
8.36200 – 8.36600	156.52475 – 156.52525	2483.5 – 2500.0	17.700 – 21.400
8.37625 – 8.38675	156.70000 – 156.90000	2655.0 – 2900.0	22.010 – 23.120
8.41425 – 8.41475	162.01250 – 167.17000	3260.0 – 3267.0	23.600 – 24.000
12.29000 – 12.29300	167.72000 – 173.20000	3332.0 – 3339.0	31.200 – 31.800
12.51975 – 12.52025	240.00000 – 285.00000	3345.8 – 3358.0	36.430 – 36.500
12.57675 – 12.57725	322.00000 – 335.40000	3600.0 – 4400.0	Above 38.6
13.36000 – 13.41000			

** : Until February 1, 1999, this restricted band shall be 0.490-0.510 MHz

1.10. Labeling Requirement

The device shall bear the following statement in a conspicuous location on the device:

This device complies with part 15 of the FCC Rules. Operation is subject to the following two conditions: (1) This device may not cause harmful interference, and (2) this device must accept any interference received, including interference that may cause undesired operation.

1.11. RF Exposure

FCC Rules and Regulations Part 1.1307, 1.1310, 2.1091, 2.1093:
RF Exposure Compliance

1.11.1. Limit For Maximum Permissible Exposure (MPE)

(A) Limits for Occupational / Controlled Exposure

Frequency Range (MHz)	Electric Field Strength (E) (V/m)	Magnetic Field Strength (H) (A/m)	Power Density (S) (mW/ cm ²)	Averaging Time E ² , H ² or S (minutes)
0.3-3.0	614	1.63	(100)*	6
3.0-30	1842/f	4.89/f	(900/f)*	6
30-300	61.4	0.163	1.0	6
300-1500			F/300	6
1500-100,000			5	6

(B) Limits for General Population / Uncontrolled Exposure

Frequency Range (MHz)	Electric Field Strength (E) (V/m)	Magnetic Field Strength (H) (A/m)	Power Density (S) (mW/cm ²)	Averaging Time E ² , H ² or S (minutes)
0.3-1.34	614	1.63	(100)*	30
1.34-30	824/f	2.19/f	(180/f)*	30
30-300	27.5	0.073	0.2	30
300-1500			F/1500	30
1500-100,000			1.0	30

F=frequency in MHz

*Plane-wave equivalent power density

1.11.2. MPE Calculations

$$S = (P \times G) / (4 \pi \times d^2)$$

Where:

S = power density

P = transmitter conducted power in (mW)

G = antenna numeric gain

d = distance to radiation center (m) or (.02²) = 0.20 cm

1.11.3. FCC Radiation Exposure Statement

This equipment complies with FCC radiation exposure limits set forth for an uncontrolled environment. In order to avoid the possibility of exceeding the FCC radio frequency exposure limits, human proximity to the antenna shall not be less than 20cm (8 inches) during normal operation. Proposed RF exposure safety information to include in User' s Manual.

2. Test Configuration of Equipment under Test

2.1. Test Mode and Test Software

The following test mode and test software was performed for conduction and radiation test:

- 802.11b (CH LO: 2412MHz) • 802.11b (CH MID: 2437MHz) • 802.11b (CH HI: 2462MHz)
- 802.11g (CH LO: 2412MHz) • 802.11g (CH MID: 2437MHz) • 802.11g (CH HI: 2462MHz)
- An executive programs, "DUTAPIDLL" Application under WIN XP.
- Link Mode (The function of EUT is data transmitting which can be operated by connecting with two hosts through UTP cable and wireless .)
- During the test, "Ping. exe" was executive under WinXP to link with the remote workstation to transmitting data by UTP cable and wireless.

2.2. Description of Test System

Device	Model No.	Manufacturer	Description
PC (Remote site)	IGV	IBM	Power Cord, Unshielding, 1.8m
Monitor (Remote site)	510A	SlimAGE	Power Cord, Unshielding, 1.8m Data Cable, Shielding, 1.35m
Keyboard (Remote site)	KB-0225	IBM	Data Cable, Shielding, 1.85m
Mouse (Remote site)	MO28VO	IBM	Data Cable, Shielding, 1.85m
AP Router(Remote site)	ARM804	Abocom	Power Cord, Unshielding, 1.8m

Use Cable:

Cable	Description
RJ-45	Unshielding, 10m

2.3. Connection Diagram of Test System

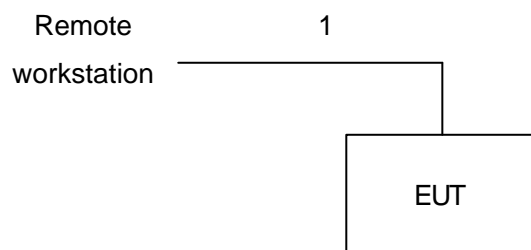

1. The TP cable is connected from remote workstation to the EUT.

2.4. Feature of Equipment under Test

Type of Modulation	BPSK, QPSK, CCK-OFDM, OFDM
Number of Channels	USA/Canada: 11 European: 13 Japan: 13, 14
Frequency Band	2412MHz~2484MHz
Carrier Frequency of each channel	2412, 2417, 2422, 2427, 2432, 2437, 2442, 2447, 2452, 2457, 2462, 2467, 2472, 2484MHz
Bandwidth of each channel	16MHz / 802.11g, 22MHz / 802.11b
Maximum Output Power to Antenna	20dBm
IF & L.O. frequency	374MHz
Antenna Type / Class and Gain	1.8dBi
Function Type	Transceiver
Power Rating (DC/AC, Voltage)	DC5V, 2A
Basic function of product	IEEE 802.11g/b Wireless Game Adapter
Temperature Range (Operating)	Normal 0~40

2.5. History of this test report

ORIGINAL.

3. General Information of Test

Test Site:	Exclusive Certification Corp. 4F-2, No. 28, Lane 78, Xing-Ai Rd. Nei-hu, Taipei City 114 Taiwan R.O.C.
Test Site Location (OATS1-SD):	No.68-1, Shihbachongsi, shihding Township, Taipei County 223, Taiwan, R.O.C.
Test Voltage:	AC 110V/ 60Hz
Test in Compliance with:	ANSI C63.4-1992 FCC Part 15 Subpart C
Frequency Range Investigated:	Conduction: from 150kHz to 30 MHz Radiation: from 30 MHz to 24620MHz
Test Distance:	The test distance of radiated emission from antenna to EUT is 10 M.

4. Test Result and Data

4.1. Antenna Requirement

4.1.1. Antenna Construction and Directional Gain

Antenna type: Integral antenna; the Maximum antenna gain 1.8 dBi

4.2. Test Result of Conducted Emission

EUT : W0E111
 Power : 110V 60Hz
 Test Mode : LINK
 Memo :
 Pol/Phase : NEUTRAL
 Temperature : 26 °C
 Humidity : 59 %

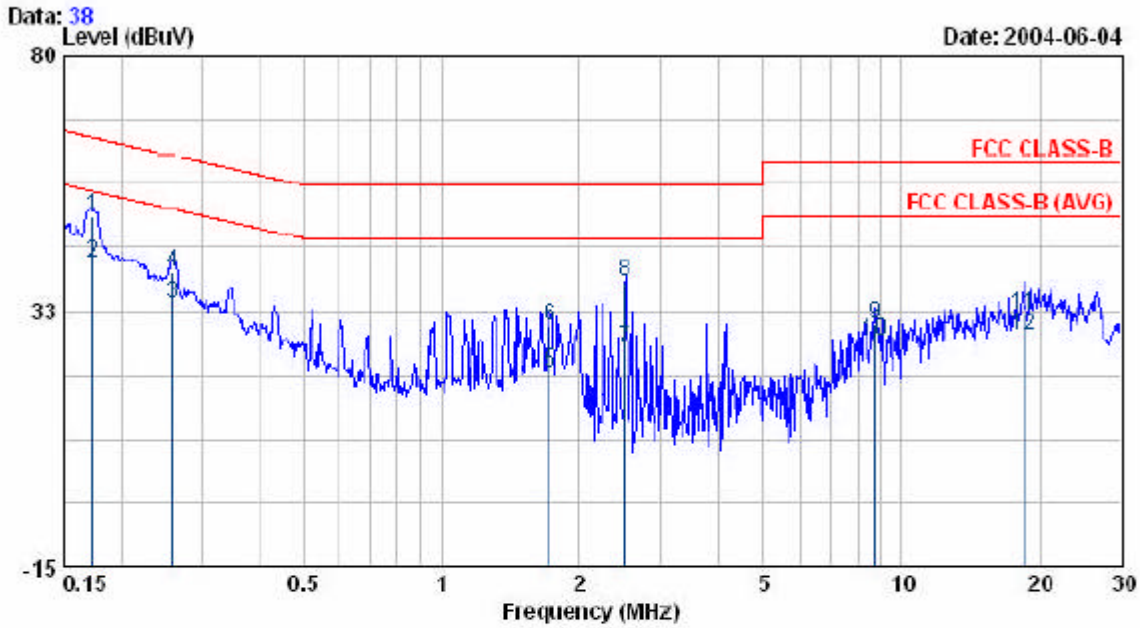

Freq	Read Level	Factor	Level	Limit	Over Limit	Remark
MHz	dBuV	dB	dBuV	dBuV	dBuV	
0.173	49.66	0.41	50.07	64.81	-14.74	QP
0.173	40.97	0.41	41.38	54.81	-13.43	AVERAGE
0.259	33.30	0.43	33.73	51.48	-17.75	AVERAGE
0.259	39.37	0.43	39.80	61.48	-21.68	QP
1.721	20.64	0.54	21.18	46.00	-24.82	AVERAGE
1.721	20.99	0.54	29.53	56.00	-26.47	QP
2.509	24.88	0.55	25.43	46.00	-20.57	AVERAGE
2.509	37.34	0.55	37.89	56.00	-18.11	QP
8.749	29.21	0.70	29.91	60.00	-30.09	QP
8.749	25.94	0.70	26.64	50.00	-23.36	AVERAGE
18.439	30.74	0.84	31.58	60.00	-28.42	QP
18.439	26.94	0.84	27.78	50.00	-22.22	AVERAGE

EUT : W0E111
 Power : 110V 60Hz
 Test Mode : LINK
 Memo :

Pol/Phase : LINE
 Temperature : 26 °C
 Humidity : 59 %

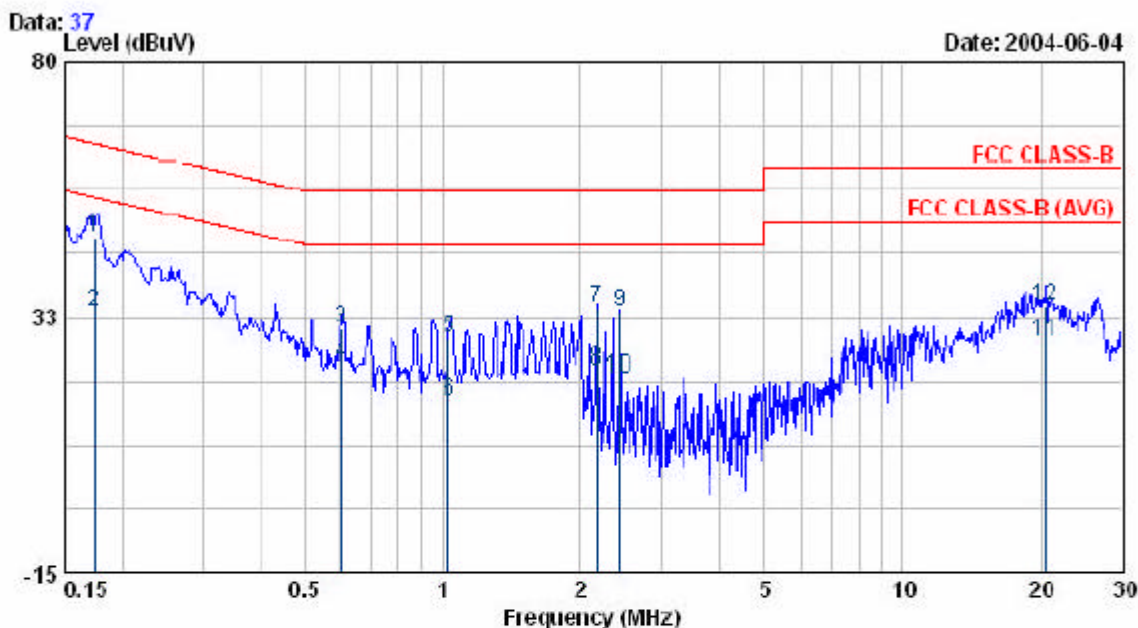

Freq	Read Level	Factor	Level	Limit	Over Limit	Remark
MHz	dBuV	dB	dBuV	dBuV	dBuV	
0.174	46.93	0.41	47.34	64.79	-17.45	QP
0.174	32.97	0.41	33.38	54.79	-21.41	AVERAGE
0.604	29.81	0.48	30.29	56.00	-25.71	QP
0.604	23.17	0.48	23.65	46.00	-22.35	AVERAGE
1.033	28.15	0.51	28.66	56.00	-27.34	QP
1.033	16.43	0.51	16.94	46.00	-29.06	AVERAGE
2.169	33.44	0.55	33.99	56.00	-22.01	QP
2.169	22.13	0.55	22.68	46.00	-23.32	AVERAGE
2.430	32.94	0.55	33.49	56.00	-22.51	QP
2.430	20.47	0.55	21.02	46.00	-24.98	AVERAGE
20.459	26.97	0.91	27.88	50.00	-22.12	AVERAGE
20.459	33.67	0.91	34.58	60.00	-25.42	QP

EUT : W0E111
 Power : 110V 60Hz
 Test Mode : 802.11b CH LO
 Memo :

Pol/Phase : NEUTRAL
 Temperature : 26 °C
 Humidity : 59 %

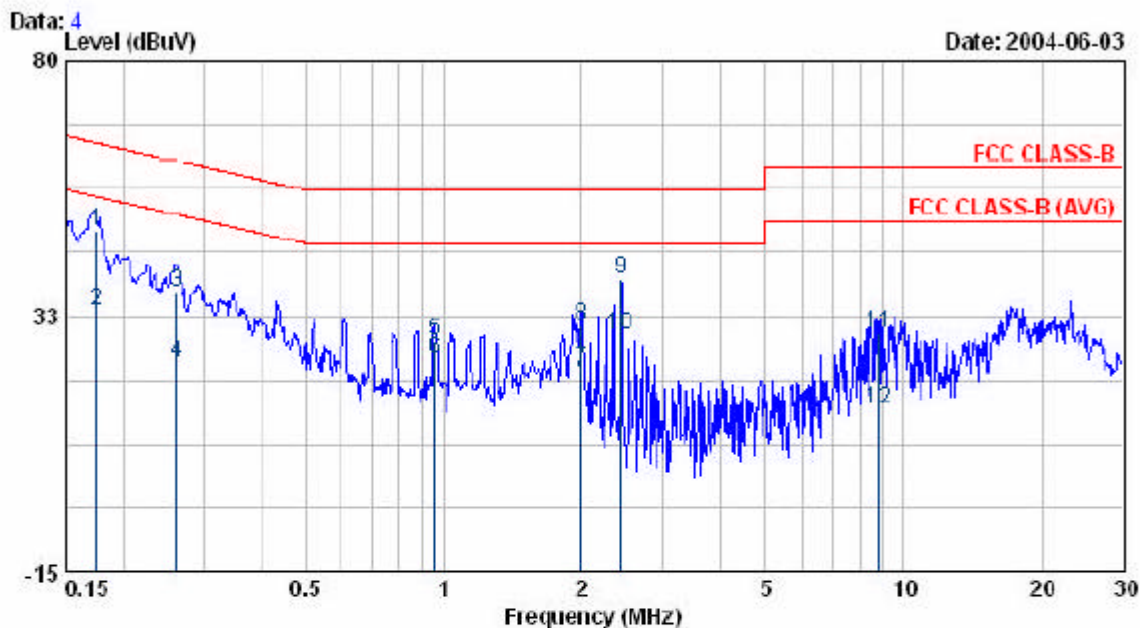

Freq	Read Level	Factor	Level	Limit	Over Limit	Remark
MHz	dBuV	dB	dBuV	dBuV	dBuV	
0.174	47.76	0.41	48.17	64.75	-16.58	QP
0.174	33.10	0.41	33.51	54.75	-21.24	AVERAGE
0.261	36.40	0.43	36.83	61.40	-24.57	QP
0.261	23.13	0.43	23.56	51.40	-27.84	AVERAGE
0.957	27.46	0.51	27.97	56.00	-28.03	QP
0.957	23.65	0.51	24.16	46.00	-21.84	AVERAGE
2.003	21.75	0.54	22.29	46.00	-23.71	AVERAGE
2.003	30.14	0.54	30.68	56.00	-25.32	QP
2.435	38.64	0.55	39.19	56.00	-16.81	QP
2.435	28.24	0.55	28.79	46.00	-17.21	AVERAGE
8.854	28.38	0.70	29.08	60.00	-30.92	QP
8.854	14.57	0.70	15.27	50.00	-34.73	AVERAGE

EUT : WGE111
 Power : 110V 60Hz
 Test Mode : 802.11b CH LO
 Memo :
 Pol/Phase : LINE
 Temperature : 26 °C
 Humidity : 59 %

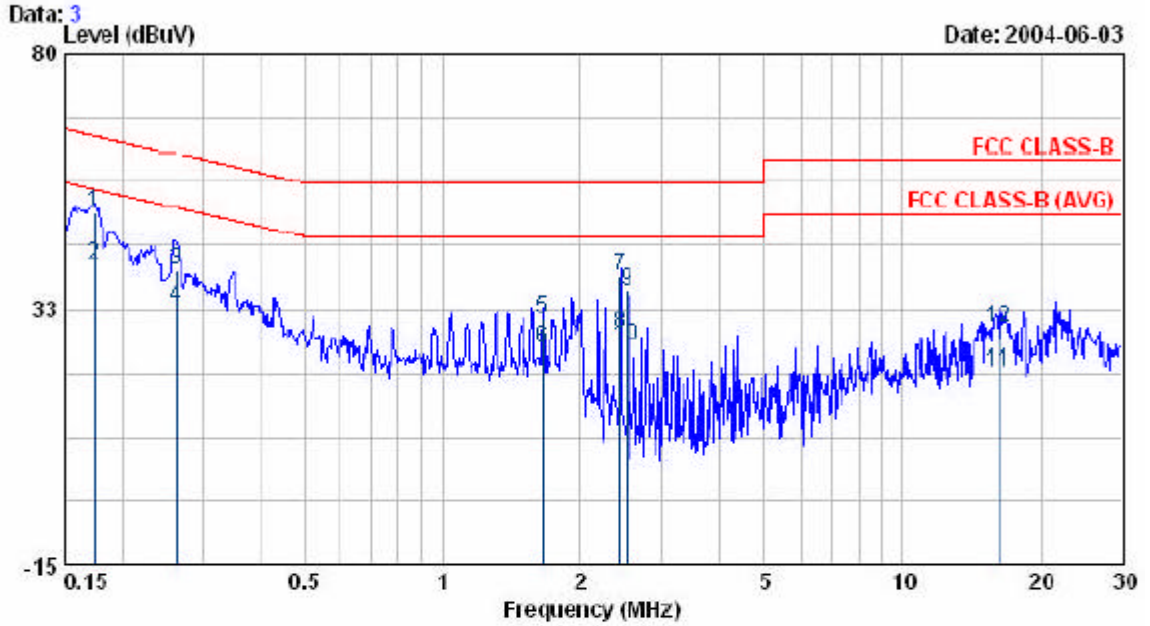

Freq	Read Level	Factor	Level	Limit	Over Limit	Remark
MHz	dBuV	dB	dBuV	dBuV	dBuV	
0.174	49.95	0.41	50.36	64.78	-14.42	QP
0.174	40.29	0.41	40.70	54.78	-14.08	AVERAGE
0.262	39.24	0.43	39.67	61.36	-21.69	QP
0.262	32.13	0.43	32.56	51.36	-18.80	AVERAGE
1.651	29.98	0.53	30.51	56.00	-25.49	QP
1.651	24.54	0.53	25.07	46.00	-20.93	AVERAGE
2.435	37.94	0.55	38.49	56.00	-17.51	QP
2.435	27.32	0.55	27.87	46.00	-18.13	AVERAGE
2.525	35.09	0.55	35.64	56.00	-20.36	QP
2.525	24.77	0.55	25.32	46.00	-20.68	AVERAGE
16.166	19.92	0.78	20.70	50.00	-29.30	AVERAGE
16.166	28.07	0.78	28.85	60.00	-31.15	QP

EUT : W0E111
 Power : 110V 60Hz
 Test Mode : 802.11b CH MID
 Memo :

Pol/Phase : NEUTRAL
 Temperature : 26 °C
 Humidity : 59 %

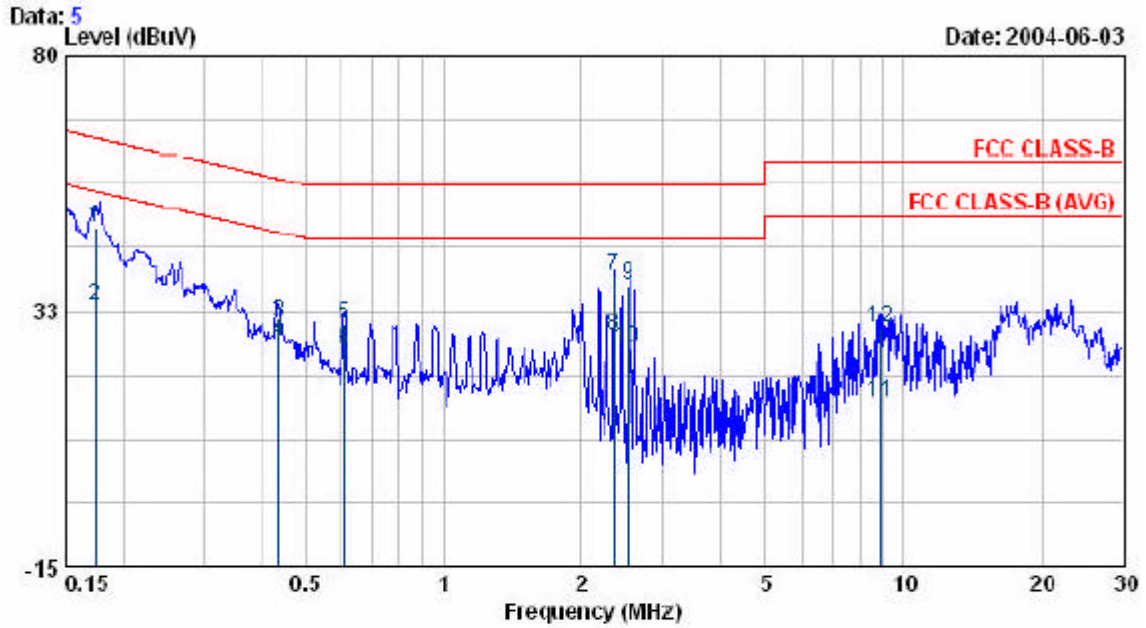

Freq	Read Level	Factor	Level	Limit	Over Limit	Remark
MHz	dBuV	dB	dBuV	dBuV	dBuV	
0.174	47.61	0.41	48.02	64.79	-16.77	QP
0.174	33.04	0.41	33.45	54.79	-21.34	AVERAGE
0.436	29.92	0.46	30.38	57.14	-26.76	QP
0.436	26.40	0.46	26.86	47.14	-20.28	AVERAGE
0.608	29.27	0.48	29.75	56.00	-26.25	QP
0.608	24.43	0.48	24.91	46.00	-21.09	AVERAGE
2.354	38.32	0.55	38.87	56.00	-17.13	QP
2.354	27.21	0.55	27.76	46.00	-18.24	AVERAGE
2.526	36.67	0.55	37.22	56.00	-18.78	QP
2.526	24.78	0.55	25.33	46.00	-20.67	AVERAGE
8.864	14.82	0.70	15.52	50.00	-34.48	AVERAGE
8.864	28.55	0.70	29.25	60.00	-30.75	QP

EUT : W0E111
 Power : 110V 60Hz
 Test Mode : 802.11b CH MID
 Memo :

Pol/Phase : LINE
 Temperature : 26 °C
 Humidity : 59 %

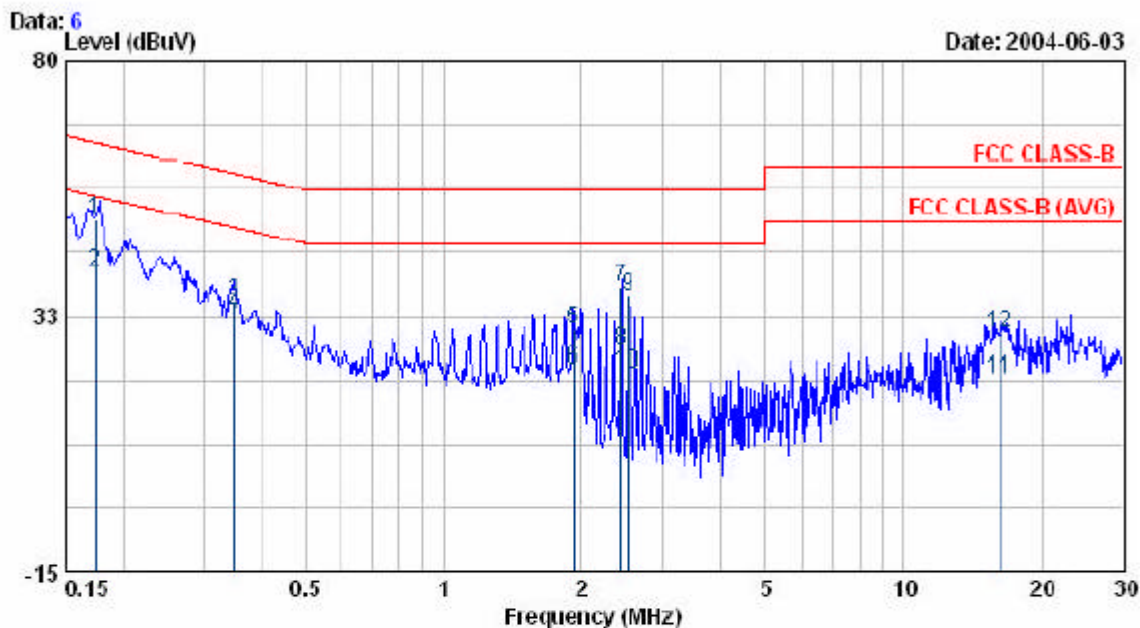

Freq	Read Level	Factor	Level	Limit	Over Limit	Remark
MHz	dBuV	dB	dBuV	dBuV	dBuV	
0.173	49.90	0.41	50.31	64.80	-14.49	QP
0.173	40.11	0.41	40.52	54.80	-14.28	AVERAGE
0.349	34.79	0.45	35.24	59.00	-23.76	QP
0.349	32.38	0.45	32.83	49.00	-16.17	AVERAGE
1.916	29.23	0.54	29.77	56.00	-26.23	QP
1.916	22.21	0.54	22.75	46.00	-23.25	AVERAGE
2.436	37.40	0.55	37.95	56.00	-18.05	QP
2.436	25.53	0.55	26.08	46.00	-19.92	AVERAGE
2.531	35.43	0.55	35.98	56.00	-20.02	QP
2.531	21.41	0.55	21.96	46.00	-24.04	AVERAGE
16.231	20.16	0.79	20.95	50.00	-29.05	AVERAGE
16.231	28.35	0.79	29.14	60.00	-30.86	QP

EUT : W0E111
 Power : 110V 60Hz
 Test Mode : 802.11b CH HI
 Memo :

Pol/Phase : NEUTRAL
 Temperature : 26 °C
 Humidity : 59 %

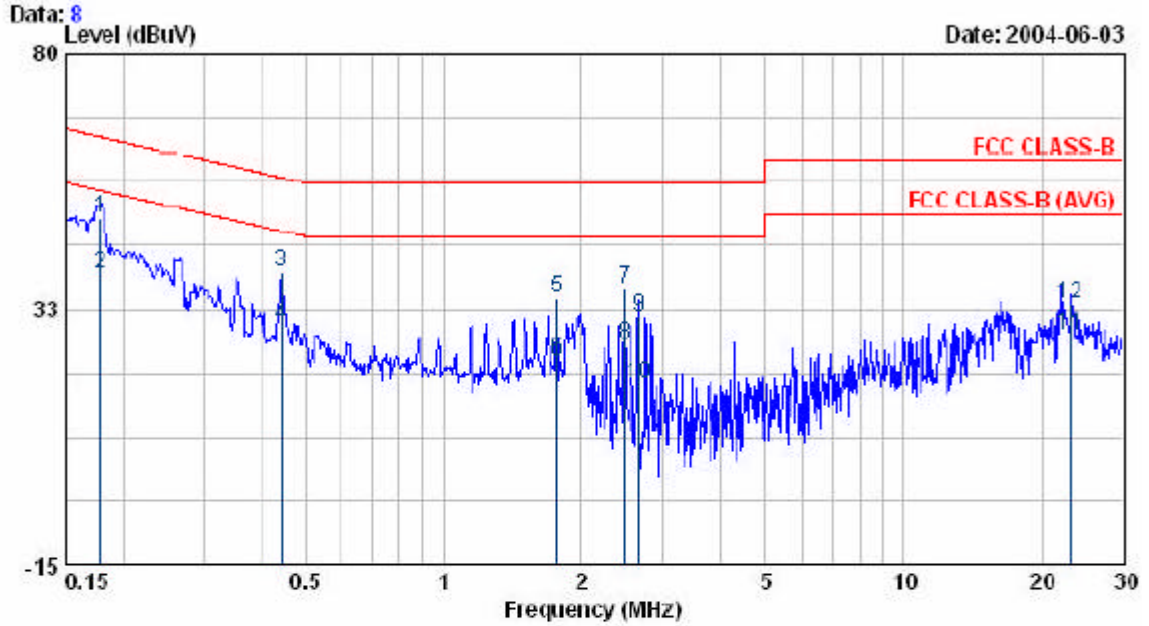

Freq	Read Level	Factor	Level	Limit	Over Limit	Remark
MHz	dBuV	dB	dBuV	dBuV	dBuV	
0.178	49.05	0.41	49.46	64.59	-15.13	QP
0.178	38.59	0.41	39.00	54.59	-15.59	AVERAGE
0.442	38.89	0.46	39.35	57.02	-17.66	QP
0.442	28.84	0.46	29.30	47.02	-17.71	AVERAGE
1.771	33.73	0.54	34.27	56.00	-21.73	QP
1.771	22.50	0.54	23.04	46.00	-22.96	AVERAGE
2.486	35.48	0.55	36.03	56.00	-19.97	QP
2.486	25.30	0.55	25.85	46.00	-20.15	AVERAGE
2.668	30.51	0.56	31.07	56.00	-24.93	QP
2.668	18.29	0.56	18.85	46.00	-27.15	AVERAGE
23.130	26.60	0.95	27.55	50.00	-22.45	AVERAGE
23.130	32.32	0.95	33.27	60.00	-26.73	QP

EUT : WGE111
 Power : 110V 60Hz
 Test Mode : 802.11b CH HI
 Memo :

Pol/Phase : LINE
 Temperature : 26 °C
 Humidity : 59 %

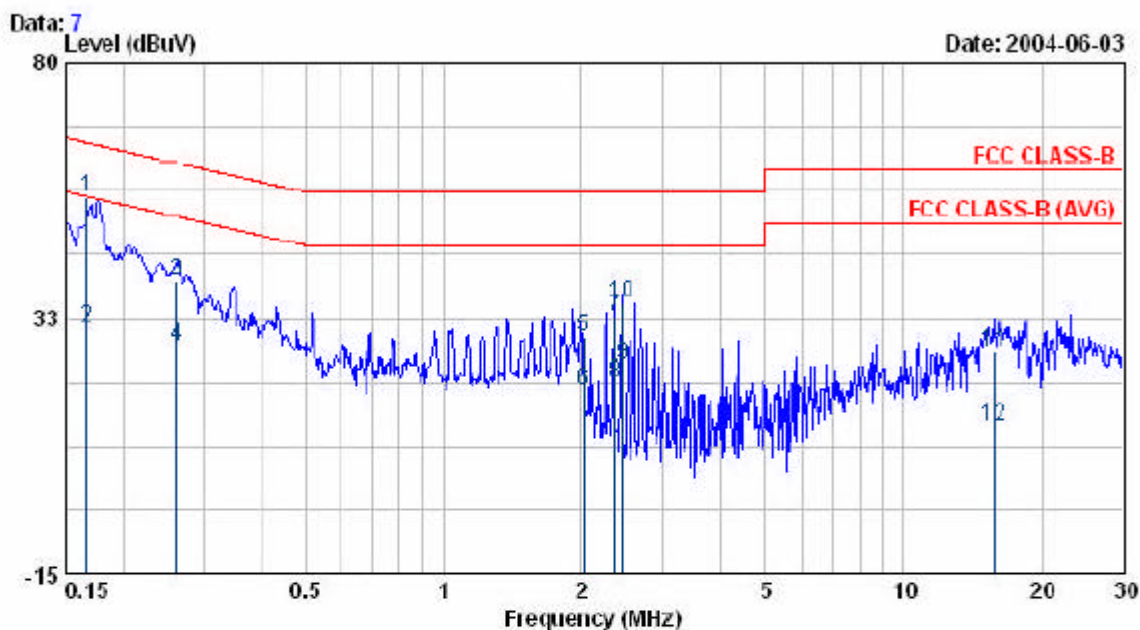

Freq	Read Level	Factor	Level	Limit	Over Limit	Remark
MHz	dBuV	dB	dBuV	dBuV	dBuV	
0.167	54.63	0.41	55.04	65.11	-10.07	QP
0.167	30.30	0.41	30.71	55.11	-24.40	AVERAGE
0.261	38.97	0.43	39.40	61.39	-21.98	QP
0.261	26.83	0.43	27.26	51.39	-24.12	AVERAGE
2.029	28.25	0.54	28.79	56.00	-27.21	QP
2.029	18.70	0.54	19.24	46.00	-26.76	AVERAGE
2.370	32.14	0.55	32.69	56.00	-23.31	QP
2.370	19.93	0.55	20.48	46.00	-25.52	AVERAGE
2.458	23.01	0.55	23.56	46.00	-22.44	AVERAGE
2.458	34.63	0.55	35.18	56.00	-20.82	QP
15.727	25.45	0.77	26.22	60.00	-33.78	QP
15.727	11.78	0.77	12.55	50.00	-37.45	AVERAGE