



SPORTON International Inc.

No. 52, Hwa Ya 1st Rd., Kwei-Shan Hsiang, TaoYuan Hsien, Taiwan, R.O.C.
Ph: 886-3-327-3456 / FAX: 886-3-327-0973 / www.sporton.com.tw

FCC RADIO TEST REPORT

Applicant's company	NETGEAR, Inc.
Applicant Address	350 East Plumeria Drive, San Jose, California 95134, USA
FCC ID	PY3UPWL6031H5
Manufacturer's company	PEGATRON CORPORATION
Manufacturer Address	5F., NO. 76, LIGONG ST., BEITOU DISTRICT, TAIPEI CITY 112 Taiwan

Product Name	Wireless module
Brand Name	NETGEAR
Model No.	UPWL6031H5
Test Rule Part(s)	47 CFR FCC Part 15 Subpart E § 15.407
Test Freq. Range	5150 ~ 5250MHz
Received Date	Apr. 18, 2013
Final Test Date	May 15, 2013
Submission Type	Original Equipment
Operating Mode	Client (without radar detection function)

Statement

Test result included is for the IEEE 802.11n and IEEE 802.11a (5150 ~ 5250MHz) of the product.

The test result in this report refers exclusively to the presented test model / sample.

Without written approval of SPORTON International Inc., the test report shall not be reproduced except in full.

The measurements and test results shown in this test report were made in accordance with the procedures and found in compliance with the limit given in **ANSI C63.10-2009**,

47 CFR FCC Part 15 Subpart E, KDB 789033 D01 v01r03 and **KDB 662911 D01 v01r02**.

The test equipment used to perform the test is calibrated and traceable to NML/ROC.



Table of Contents

1. CERTIFICATE OF COMPLIANCE	1
2. SUMMARY OF THE TEST RESULT	2
3. GENERAL INFORMATION	3
3.1. Product Details	3
3.2. Accessories	4
3.3. Table for Filed Antenna	5
3.4. Table for Carrier Frequencies	5
3.5. Table for Test Modes	6
3.6. Table for Testing Locations.....	6
3.7. Table for Supporting Units	7
3.8. Table for Parameters of Test Software Setting	7
3.9. EUT Operation during Test.....	7
3.10. Duty Cycle.....	8
3.11. Test Configurations.....	10
4. TEST RESULT	12
4.1. AC Power Line Conducted Emissions Measurement	12
4.2. 26dB Bandwidth & 99% Occupied Bandwidth Measurement.....	16
4.3. Maximum Conducted Output Power Measurement.....	25
4.4. Power Spectral Density Measurement.....	28
4.5. Peak Excursion Measurement	34
4.6. Radiated Emissions Measurement.....	39
4.7. Band Edge Emissions Measurement.....	53
4.8. Frequency Stability Measurement.....	58
4.9. Antenna Requirements	60
5. LIST OF MEASURING EQUIPMENTS	61
6. TEST LOCATION	63
APPENDIX A. TEST PHOTOS	A1 ~ A8
APPENDIX B. MAXIMUM PERMISSIBLE EXPOSURE	B1 ~ B3



History of This Test Report

REPORT NO.	VERSION	DESCRIPTION	ISSUED DATE
FR341860AB	Rev. 01	Initial issue of report	May 21, 2013



1. CERTIFICATE OF COMPLIANCE

Product Name : Wireless module
Brand Name : NETGEAR
Model No. : UPWL6031H5
Applicant : NETGEAR, Inc.
Test Rule Part(s) : 47 CFR FCC Part 15 Subpart E § 15.407

Sporton International as requested by the applicant to evaluate the EMC performance of the product sample received on Apr. 18, 2013 would like to declare that the tested sample has been evaluated and found to be in compliance with the tested rule parts. The data recorded as well as the test configuration specified is true and accurate for showing the sample's EMC nature.

A handwritten signature in blue ink that reads 'Sam Chen' is written over a horizontal line.

Sam Chen

SPORTON INTERNATIONAL INC.

2. SUMMARY OF THE TEST RESULT

Applied Standard: 47 CFR FCC Part 15 Subpart E				
Part	Rule Section	Description of Test	Result	Under Limit
4.1	15.207	AC Power Line Conducted Emissions	Complies	18.82 dB
4.2	15.407(a)	26dB Spectrum Bandwidth & 99% Occupied Bandwidth	Complies	-
4.3	15.407(a)	Maximum Conducted Output Power	Complies	0.36 dB
4.4	15.407(a)	Power Spectral Density	Complies	0.16 dB
4.5	15.407(a)	Peak Excursion	Complies	1.29 dB
4.6	15.407(b)	Radiated Emissions	Complies	5.87 dB
4.7	15.407(b)	Band Edge Emissions	Complies	0.12 dB
4.8	15.407(g)	Frequency Stability	Complies	-
4.9	15.203	Antenna Requirements	Complies	-

Test Items	Uncertainty	Remark
AC Power Line Conducted Emissions	±2.3dB	Confidence levels of 95%
Maximum Conducted Output Power	±0.5dB	Confidence levels of 95%
Power Spectral Density	±0.5dB	Confidence levels of 95%
Peak Excursion	±0.5dB	Confidence levels of 95%
26dB Spectrum Bandwidth / Frequency Stability	±8.5×10 ⁻⁸	Confidence levels of 95%
Radiated Emissions (9kHz~30MHz)	±0.8dB	Confidence levels of 95%
Radiated Emissions (30MHz~1000MHz)	±1.9dB	Confidence levels of 95%
Radiated / Band Edge Emissions (1GHz~18GHz)	±1.9dB	Confidence levels of 95%
Radiated Emissions (18GHz~40GHz)	±1.9dB	Confidence levels of 95%
Temperature	±0.7°C	Confidence levels of 95%
Humidity	±3.2%	Confidence levels of 95%
DC / AC Power Source	±1.4%	Confidence levels of 95%

3. GENERAL INFORMATION

3.1. Product Details

IEEE 802.11n

Items	Description
Product Type	WLAN (3TX, 3RX)
Radio Type	Intentional Transceiver
Power Type	From host system
Modulation	see the below table for IEEE 802.11n
Data Modulation	OFDM (BPSK / QPSK / 16QAM / 64QAM)
Data Rate (Mbps)	see the below table for IEEE 802.11n
Frequency Range	5150 ~ 5250MHz
Channel Number	4 for 20MHz bandwidth ; 2 for 40MHz bandwidth
Channel Band Width (99%)	MCS0 (20MHz): 17.60 MHz ; MCS0 (40MHz): 36.16 MHz
Maximum Conducted Output Power	MCS0 (20MHz): 15.55 dBm ; MCS0 (40MHz): 16.64 dBm
Carrier Frequencies	Please refer to section 3.4
Antenna	Please refer to section 3.3

IEEE 802.11a

Items	Description
Product Type	WLAN (3TX, 3RX)
Radio Type	Intentional Transceiver
Power Type	From host system
Modulation	OFDM for IEEE 802.11a
Data Modulation	OFDM (BPSK / QPSK / 16QAM / 64QAM)
Data Rate (Mbps)	OFDM (6/9/12/18/24/36/48/54)
Frequency Range	5150 ~ 5250MHz
Channel Number	4
Channel Band Width (99%)	17.28 MHz
Maximum Conducted Output Power	15.57 dBm
Carrier Frequencies	Please refer to section 3.4
Antenna	Please refer to section 3.3

Antenna & Band width

Antenna	Three (TX)	
Band width Mode	20 MHz	40 MHz
IEEE 802.11a	V	X
IEEE 802.11n	V	V

IEEE 11n Spec.

Protocol	Number of Transmit Chains (NTX)	Data Rate / MCS
802.11n (HT20)	3	MCS 0-23
802.11n (HT40)	3	MCS 0-23

Note 1: IEEE Std. 802.11n modulation consists of HT20 and HT40 (HT: High Throughput). Then EUT support HT20 and HT40.

Note 2: Modulation modes consist of below configuration:
HT20/HT40: IEEE 802.11n

3.2. Accessories

N/A

3.3. Table for Filed Antenna

Ant.	Brand	Model No.	Antenna Type	Connector	Gain (dBi)	
					5GHz Band 1	5GHz Band 4
1	WNC	81.EZY15.GJM	PCB Antenna	I-PEX	2.7	3.2
2	WNC	81.EZY15.GJN	PCB Antenna	I-PEX	2.7	3.2
3	WNC	81.EZY15.GJP	PCB Antenna	I-PEX	2.7	3.2

Note: The EUT has three antennas

Chain 1, Chain 2 and Chain 3 could transmit/receive simultaneously.

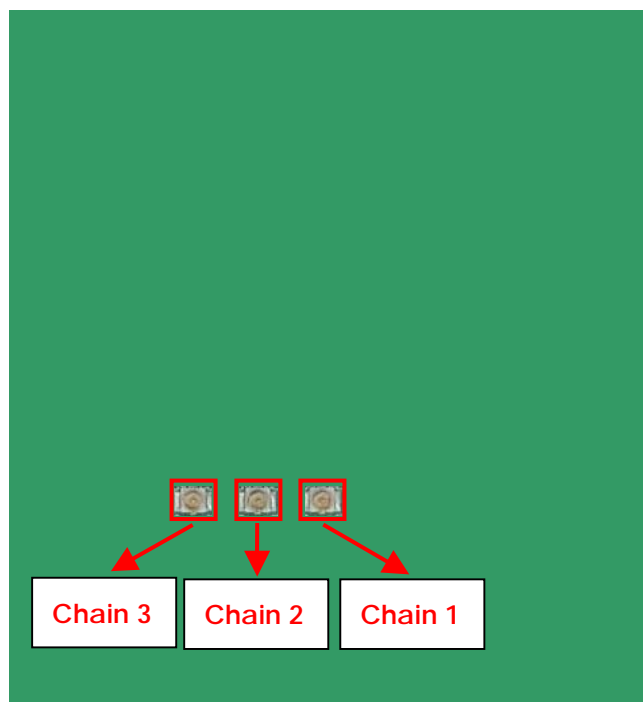

3.4. Table for Carrier Frequencies

The EUT has two bandwidth system.

For 20MHz bandwidth systems, use Channel 36, 40, 44, 48.

For 40MHz bandwidth systems, use Channel 38, 46.

Frequency Band	Channel No.	Frequency	Channel No.	Frequency
5150~5250 MHz Band 1	36	5180 MHz	44	5220 MHz
	38	5190 MHz	46	5230 MHz
	40	5200 MHz	48	5240 MHz

3.5. Table for Test Modes

Preliminary tests were performed in different data rate to find the worst radiated emission. The data rate shown in the table below is the worst-case rate with respect to the specific test item. Investigation has been done on all the possible configurations for searching the worst cases. The following table is a list of the test modes shown in this test report.

Test Items	Mode		Data Rate	Channel	Chain
AC Power Conducted Emission	CTX		-	-	-
Max. Conducted Output Power	11n 20MHz	Band 1	MCS0	36/40/48	1+2+3
	11n 40MHz	Band 1	MCS0	38/46	1+2+3
	11a/BPSK	Band 1	6Mbps	36/40/48	1+2+3
Power Spectral Density	11n 20MHz	Band 1	MCS0	36/40/48	1+2+3
	11n 40MHz	Band 1	MCS0	38/46	1+2+3
	11a/BPSK	Band 1	6Mbps	36/40/48	1+2+3
26dB Spectrum Bandwidth 99% Occupied Bandwidth Measurement Peak Excursion	11n 20MHz	Band 1	MCS0	36/40/48	1+2+3
	11n 40MHz	Band 1	MCS0	38/46	1+2+3
	11a/BPSK	Band 1	6Mbps	36/40/48	1+2+3
Radiated Emission Below 1GHz	CTX		-	-	-
Radiated Emission Above 1GHz	11n 20MHz	Band 1	MCS0	36/40/48	1+2+3
	11n 40MHz	Band 1	MCS0	38/46	1+2+3
	11a/BPSK	Band 1	6Mbps	36/40/48	1+2+3
Band Edge Emission	11n 20MHz	Band 1	MCS0	36/40/48	1+2+3
	11n 40MHz	Band 1	MCS0	38/46	1+2+3
	11a/BPSK	Band 1	6Mbps	36/40/48	1+2+3
Frequency Stability	Un-modulation		-	40	N/A

3.6. Table for Testing Locations

Test Site No.	Site Category	Location	FCC Reg. No.	IC File No.	VCCI Reg. No
03CH01-CB	SAC	Hsin Chu	262045	IC 4086D	-
CO01-CB	Conduction	Hsin Chu	262045	IC 4086D	-
TH01-CB	OVEN Room	Hsin Chu	-	-	-

Open Area Test Site (OATS); Semi Anechoic Chamber (SAC).

Please refer section 6 for Test Site Address.

3.7. Table for Supporting Units

Support Unit	Brand	Model	FCC ID
Notebook	DELL	E6220	QDS-BRCM1049LE
Fixture	PEGATRON	B83G R2.01	N/A

3.8. Table for Parameters of Test Software Setting

During testing, Channel & Power Controlling Software provided by the customer was used to control the operating channel as well as the output power level. The RF output power selection is for the setting of RF output power expected by the customer and is going to be fixed on the firmware of the final end product.

Power Parameters of IEEE 802.11n MCS0 20MHz / Chain 1 + Chain 2 + Chain 3

Test Software Version	Manual Tool Version : 2.0.0.3		
Frequency	5180 MHz	5200 MHz	5240 MHz
MCS0 20MHz	62	62	62

Power Parameters of IEEE 802.11n MCS0 40MHz / Chain 1 + Chain 2 + Chain 3

Test Software Version	Manual Tool Version : 2.0.0.3	
Frequency	5190 MHz	5230 MHz
MCS0 40MHz	56	68

Power Parameters of IEEE 802.11a / Chain 1 + Chain 2 + Chain 3

Test Software Version	Manual Tool Version : 2.0.0.3		
Frequency	5180 MHz	5200 MHz	5240 MHz
IEEE 802.11a	62	62	62

3.9. EUT Operation during Test

The EUT was programmed to be in continuously transmitting mode.

3.10. Duty Cycle

IEEE 802.11n MCS0 20MHz

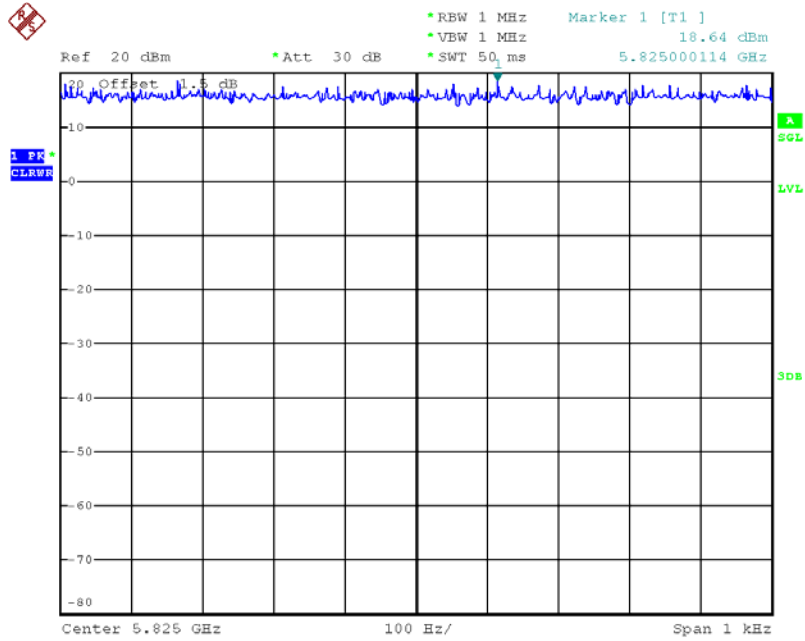

Date: 15.MAY.2013 00:45:31

IEEE 802.11n MCS0 40MHz

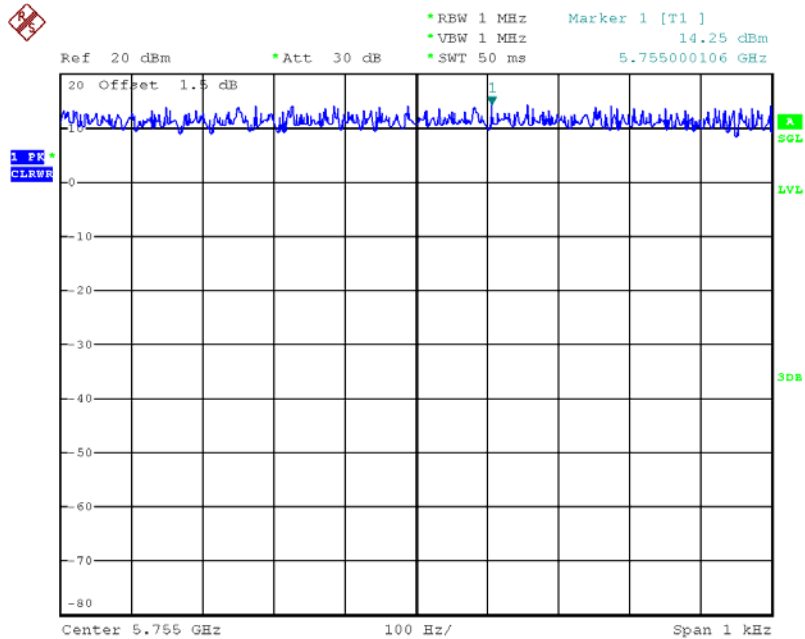

Date: 15.MAY.2013 00:46:03

IEEE 802.11a

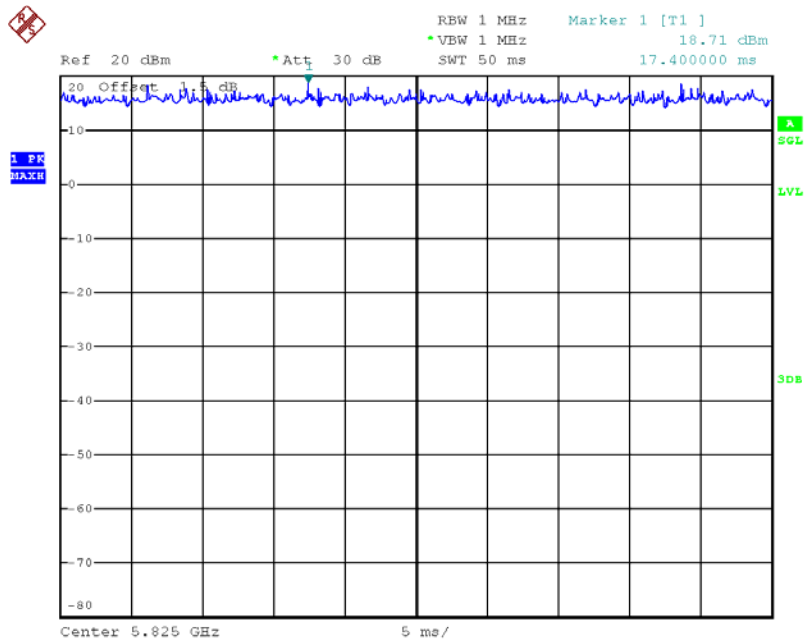

Date: 15.MAY.2013 00:33:44

3.11. Test Configurations

3.11.1. AC Power Line Conduction Emissions Test Configuration

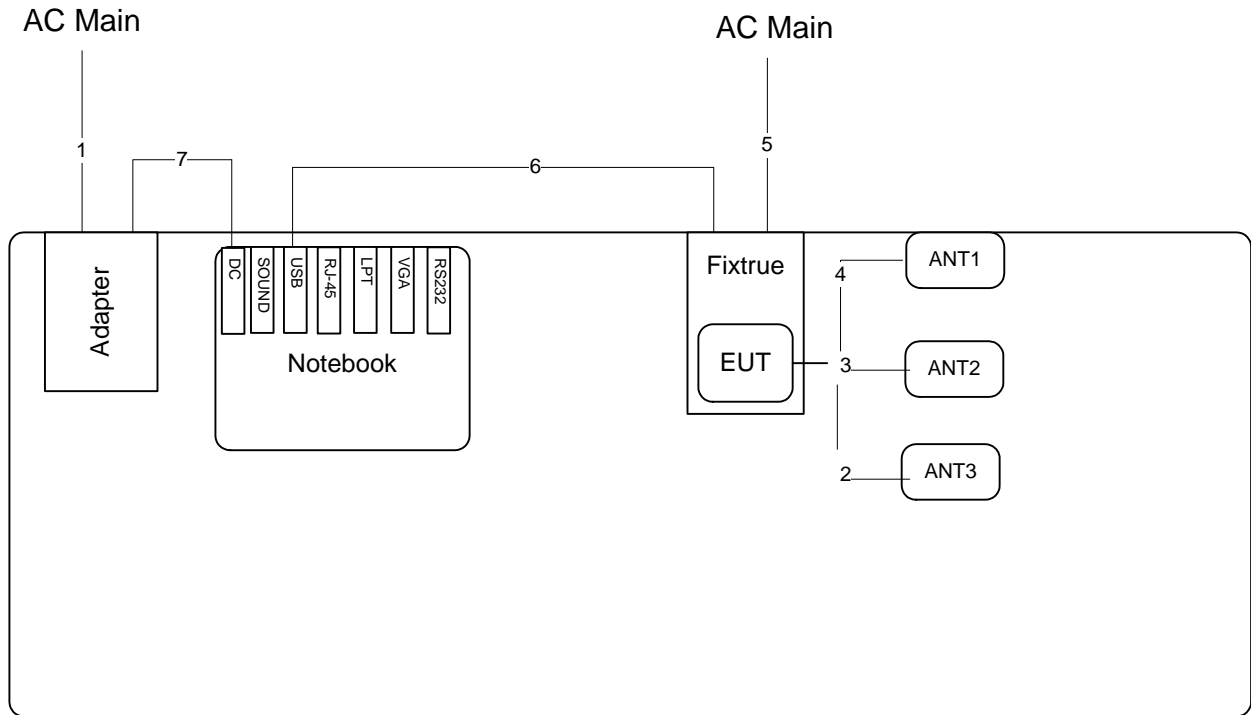

Item	Connection	Shield	Length
1	AC Power Cable	No	1.8m
2	Ant. Cable	Yes	0.8m
3	Ant. Cable	Yes	0.12m
4	Ant. Cable	Yes	0.10m
5	Power Cable	No	1.8m
6	UART to USB Cable	Yes	1.9m
7	DC Power Cable	No	0.8m

3.11.2. Radiation Emissions Test Configuration

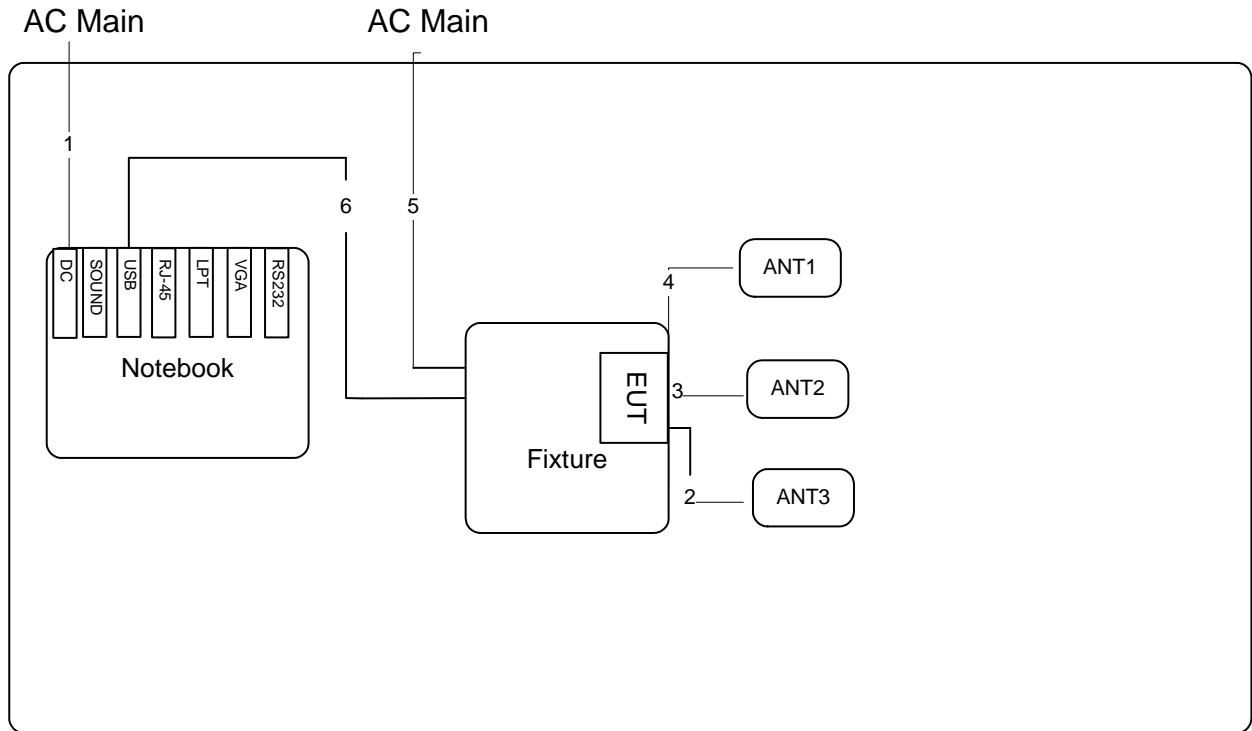

Item	Connection	Shield	Length
1	Power Cable	No	2.6m
2	Ant. Cable	Yes	0.8m
3	Ant. Cable	Yes	0.12m
4	Ant. Cable	Yes	0.10m
5	Power Cable	No	1.8m
6	UART TO USB Cable	Yes	1.9m

4. TEST RESULT

4.1. AC Power Line Conducted Emissions Measurement

4.1.1. Limit

For this product that is designed to connect to the AC power line, the radio frequency voltage that is conducted back onto the AC power line on any frequency or frequencies within the band 150 kHz to 30 MHz shall not exceed below limits table.

Frequency (MHz)	QP Limit (dBuV)	AV Limit (dBuV)
0.15~0.5	66~56	56~46
0.5~5	56	46
5~30	60	50

4.1.2. Measuring Instruments and Setting

Please refer to section 5 of equipments list in this report. The following table is the setting of the receiver.

Receiver Parameters	Setting
Attenuation	10 dB
Start Frequency	0.15 MHz
Stop Frequency	30 MHz
IF Bandwidth	9 KHz

4.1.3. Test Procedures

1. Configure the EUT according to ANSI C63.10. The EUT or host of EUT has to be placed 0.4 meter far from the conducting wall of the shielding room and at least 80 centimeters from any other grounded conducting surface.
2. Connect EUT or host of EUT to the power mains through a line impedance stabilization network (LISN).
3. All the support units are connected to the other LISNs. The LISN should provide 50uH/50ohms coupling impedance.
4. The frequency range from 150 KHz to 30 MHz was searched.
5. Set the test-receiver system to Peak Detect Function and Specified Bandwidth with Maximum Hold Mode.
6. The measurement has to be done between each power line and ground at the power terminal.

4.1.4. Test Setup Layout

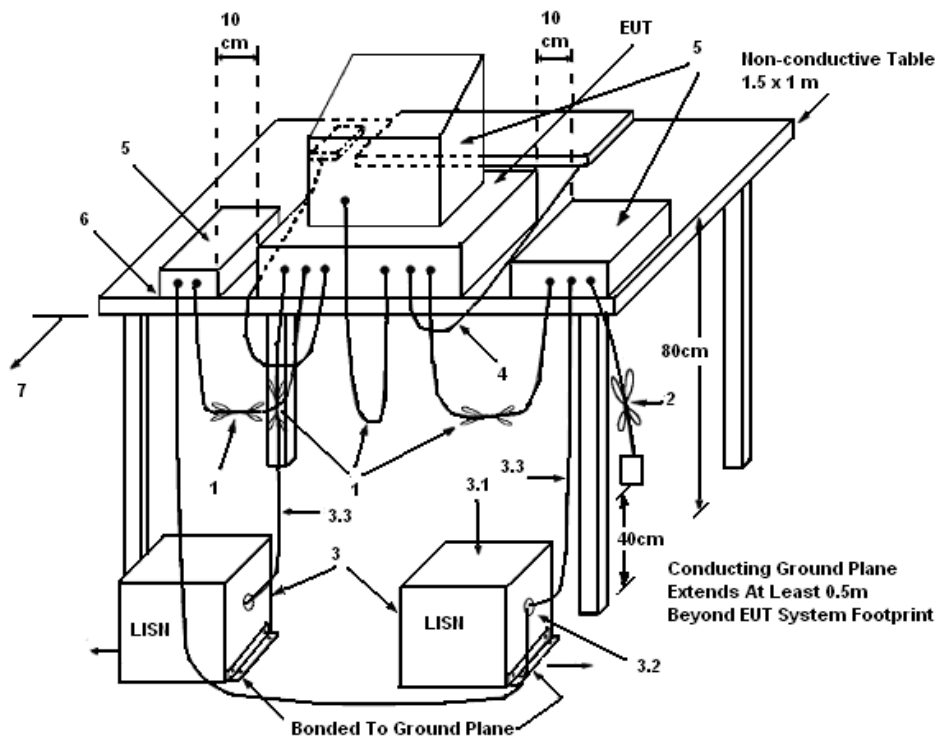

LEGEND:

- (1) Interconnecting cables that hang closer than 40 cm to the ground plane shall be folded back and forth in the center forming a bundle 30 to 40 cm long.
- (2) I/O cables that are not connected to a peripheral shall be bundled in the center. The end of the cable may be terminated, if required, using the correct terminating impedance. The overall length shall not exceed 1 m.
- (3) EUT connected to one LISN. Unused LISN measuring port connectors shall be terminated in 50 Ω . LISN can be placed on top of, or immediately beneath, reference ground plane.
 - (3.1) All other equipment powered from additional LISN(s).
 - (3.2) Multiple outlet strip can be used for multiple power cords of non-EUT equipment.
 - (3.3) LISN at least 80 cm from nearest part of EUT chassis.
- (4) Cables of hand-operated devices, such as keyboards, mice, etc., shall be placed as for normal use.
- (5) Non-EUT components of EUT system being tested.
- (6) Rear of EUT, including peripherals, shall all be aligned and flush with rear of tabletop.
- (7) Rear of tabletop shall be 40 cm removed from a vertical conducting plane that is bonded to the ground plane.

4.1.5. Test Deviation

There is no deviation with the original standard.

4.1.6. EUT Operation during Test

The EUT was placed on the test table and programmed in normal function.

4.1.7. Results of AC Power Line Conducted Emissions Measurement

Temperature	24°C	Humidity	48%
Test Engineer	Hank Yang	Phase	Line
Configuration	CTX		

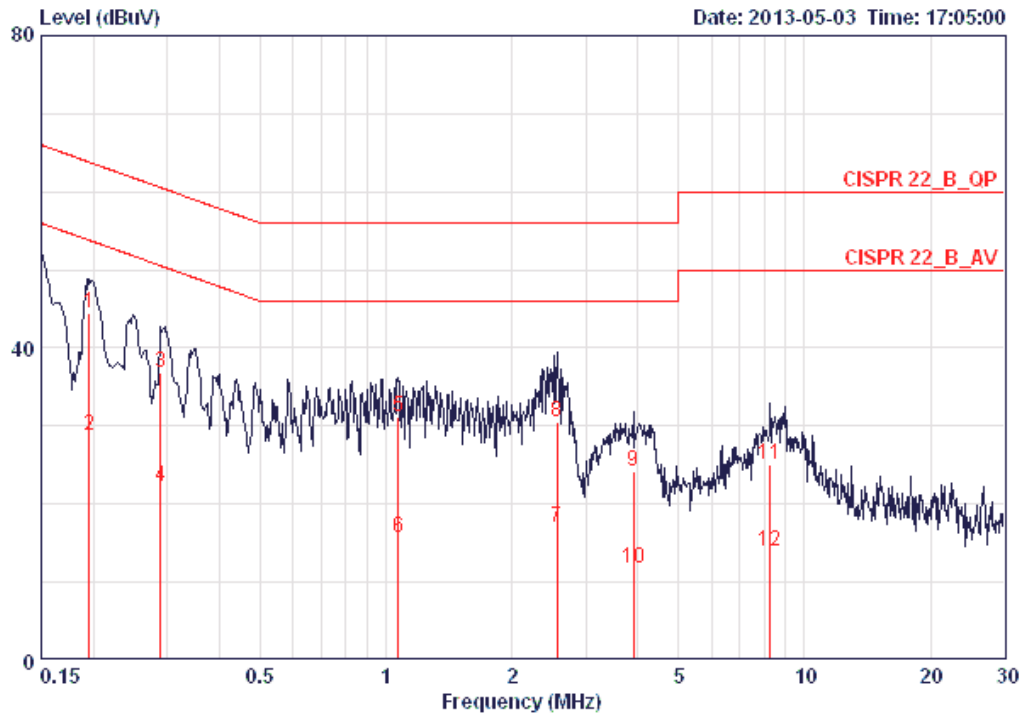

	Freq	Level	Over Limit	Limit Line	Read Level	LISN Factor	Cable Loss	Pol/Phase	Remark
	MHz	dBuV	dB	dBuV	dBuV	dB	dB		
1	0.19550	44.45	-19.35	63.80	44.10	0.15	0.20	LINE	QP
2	0.19550	28.67	-25.13	53.80	28.32	0.15	0.20	LINE	AVERAGE
3	0.28935	36.85	-23.69	60.54	36.50	0.15	0.20	LINE	QP
4	0.28935	22.19	-28.35	50.54	21.84	0.15	0.20	LINE	AVERAGE
5	1.071	31.10	-24.90	56.00	30.73	0.17	0.20	LINE	QP
6	1.071	15.66	-30.34	46.00	15.29	0.17	0.20	LINE	AVERAGE
7	2.567	17.08	-28.92	46.00	16.64	0.20	0.24	LINE	AVERAGE
8	2.567	30.42	-25.58	56.00	29.98	0.20	0.24	LINE	QP
9	3.901	24.13	-31.87	56.00	23.62	0.22	0.30	LINE	QP
10	3.901	11.84	-34.16	46.00	11.33	0.22	0.30	LINE	AVERAGE
11	8.279	25.12	-34.88	60.00	24.51	0.31	0.30	LINE	QP
12	8.279	13.92	-36.08	50.00	13.31	0.31	0.30	LINE	AVERAGE

Temperature	24°C	Humidity	48%
Test Engineer	Hank Yang	Phase	Neutral
Configuration	CTX		

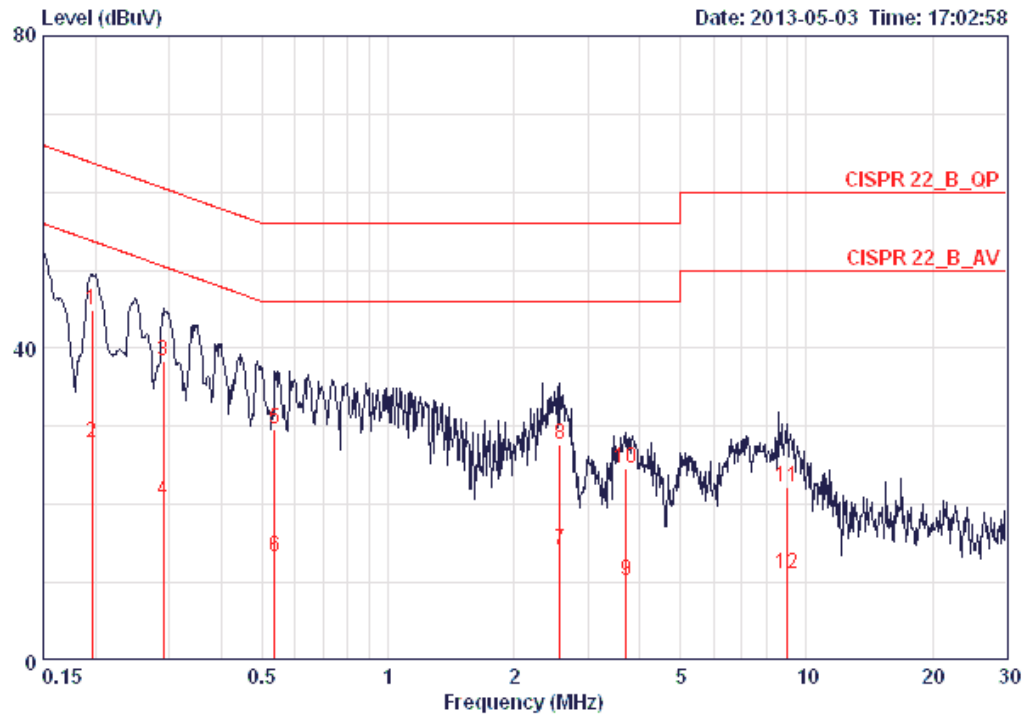

	Freq	Level	Over	Limit	Read	LISN	Cable	Pol/Phase	Remark
	MHz	dBuV	Limit	Line	Level	Factor	Loss		
			dB	dBuV	dBuV	dB	dB		
1	0.19654	44.94	-18.82	63.76	44.66	0.08	0.20	NEUTRAL	QP
2	0.19654	27.99	-25.77	53.76	27.71	0.08	0.20	NEUTRAL	AVERAGE
3	0.29088	38.32	-22.18	60.50	38.04	0.08	0.20	NEUTRAL	QP
4	0.29088	20.43	-30.07	50.50	20.15	0.08	0.20	NEUTRAL	AVERAGE
5	0.53498	29.54	-26.46	56.00	29.26	0.08	0.20	NEUTRAL	QP
6	0.53498	13.20	-32.80	46.00	12.92	0.08	0.20	NEUTRAL	AVERAGE
7	2.581	14.23	-31.77	46.00	13.87	0.12	0.24	NEUTRAL	AVERAGE
8	2.581	27.75	-28.25	56.00	27.39	0.12	0.24	NEUTRAL	QP
9	3.700	10.15	-35.85	46.00	9.74	0.13	0.29	NEUTRAL	AVERAGE
10	3.700	24.69	-31.31	56.00	24.28	0.13	0.29	NEUTRAL	QP
11	8.964	22.19	-37.81	60.00	21.67	0.22	0.30	NEUTRAL	QP
12	8.964	11.10	-38.90	50.00	10.58	0.22	0.30	NEUTRAL	AVERAGE

Note:

Level = Read Level + LISN Factor + Cable Loss

4.2. 26dB Bandwidth & 99% Occupied Bandwidth Measurement

4.2.1. Limit

No restriction limits.

4.2.2. Measuring Instruments and Setting

Please refer to section 5 of equipments list in this report. The following table is the setting of the spectrum analyzer.

26dB Bandwidth	
Spectrum Parameters	Setting
Attenuation	Auto
Span Frequency	> 26dB Bandwidth
RB	Approximately 1% of the emission bandwidth
VB	VBW > RBW
Detector	Peak
Trace	Max Hold
Sweep Time	Auto
99% Occupied Bandwidth	
Spectrum Parameters	Setting
Span	1.5 times to 5.0 times the OBW
RB	1 % to 5 % of the OBW
VB	$\geq 3 \times \text{RBW}$
Detector	Peak
Trace	Max Hold

4.2.3. Test Procedures

1. The transmitter output (antenna port) was connected to the spectrum analyzer in peak hold mode.
2. Measure the maximum width of the emission that is 26 dB down from the peak of the emission. Compare this with the RBW setting of the analyzer. Readjust RBW and repeat measurement as needed until the RBW/EBW ratio is approximately 1%.

4.2.4. Test Setup Layout

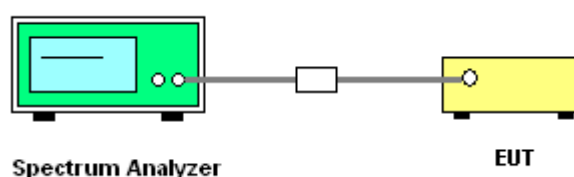

4.2.5. Test Deviation

There is no deviation with the original standard.

4.2.6. EUT Operation during Test

The EUT was programmed to be in continuously transmitting mode.

4.2.7. Test Result of 26dB Bandwidth & 99% Occupied Bandwidth

Temperature	25°C	Humidity	56%
Test Engineer	Sean Ku	Configurations	IEEE 802.11n

Configuration IEEE 802.11n MCS0 20MHz / Chain 1 + Chain 2 + Chain 3

Channel	Frequency	26dB Bandwidth (MHz)	99% Occupied Bandwidth (MHz)
36	5180 MHz	20.00	17.60
40	5200 MHz	20.16	17.44
48	5240 MHz	20.00	17.60

Configuration IEEE 802.11n MCS0 40MHz / Chain 1 + Chain 2 + Chain 3

Channel	Frequency	26dB Bandwidth (MHz)	99% Occupied Bandwidth (MHz)
38	5190 MHz	34.80	35.84
46	5230 MHz	38.40	36.16

Temperature	25°C	Humidity	56%
Test Engineer	Sean Ku	Configurations	IEEE 802.11a

Configuration IEEE 802.11a / Chain 1 + Chain 2 + Chain 3

Channel	Frequency	26dB Bandwidth (MHz)	99% Occupied Bandwidth (MHz)
36	5180 MHz	19.84	16.96
40	5200 MHz	19.84	17.28
48	5240 MHz	20.16	16.96

26dB Bandwidth & 99% Occupied Bandwidth Plot on Configuration IEEE 802.11n MCS0 20MHz / Chain 1 + Chain 2 + Chain 3 / 5180 MHz

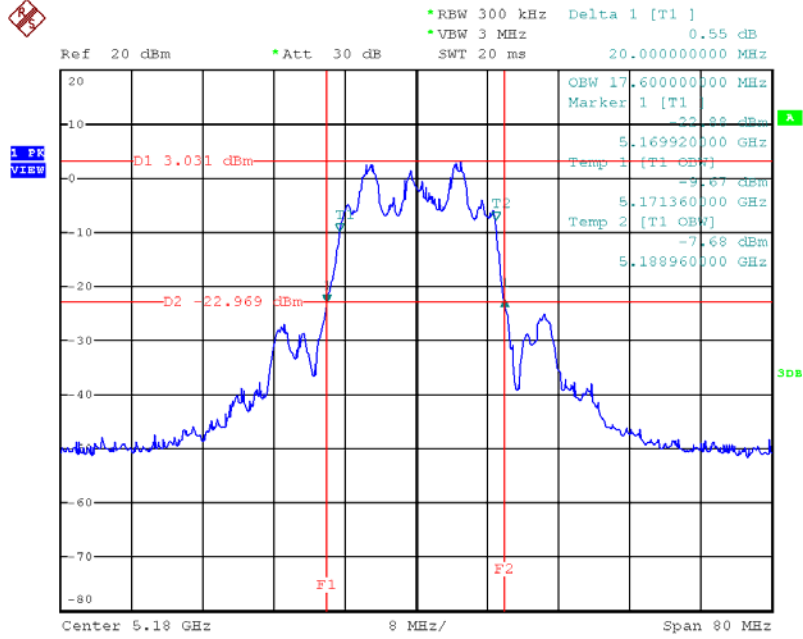

Date: 14.MAY.2013 22:57:17

26dB Bandwidth & 99% Occupied Bandwidth Plot on Configuration IEEE 802.11n MCS0 20MHz / Chain 1 + Chain 2 + Chain 3 / 5200 MHz

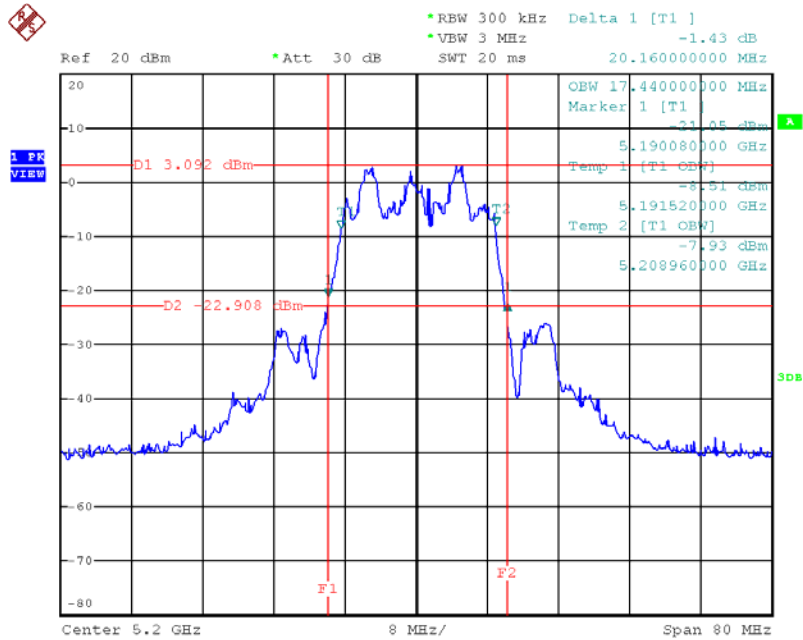

Date: 14.MAY.2013 22:57:59

26dB Bandwidth & 99% Occupied Bandwidth Plot on Configuration IEEE 802.11n MCS0 20MHz / Chain 1 + Chain 2 + Chain 3 / 5240 MHz

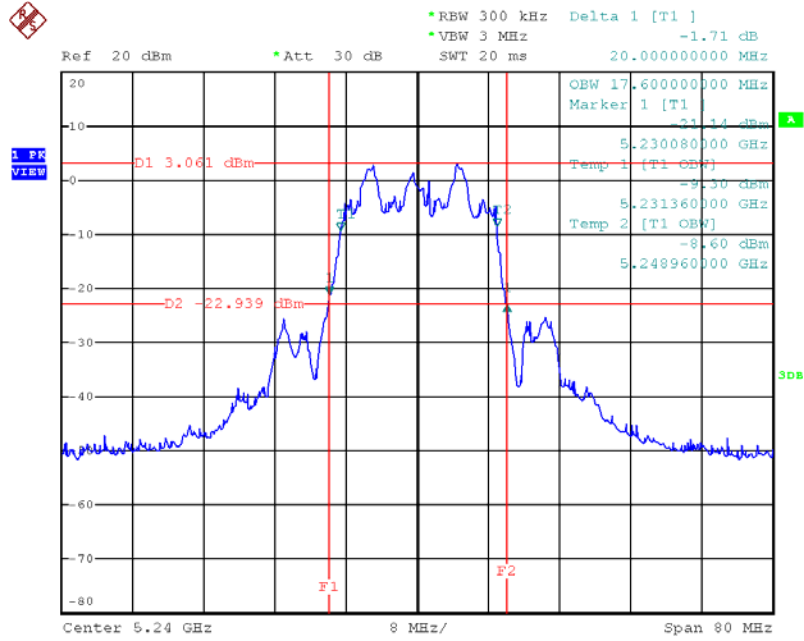

Date: 14.MAY.2013 22:58:48

26dB Bandwidth & 99% Occupied Bandwidth Plot on Configuration IEEE 802.11n MCS0 40MHz / Chain 1 + Chain 2 + Chain 3 / 5190 MHz

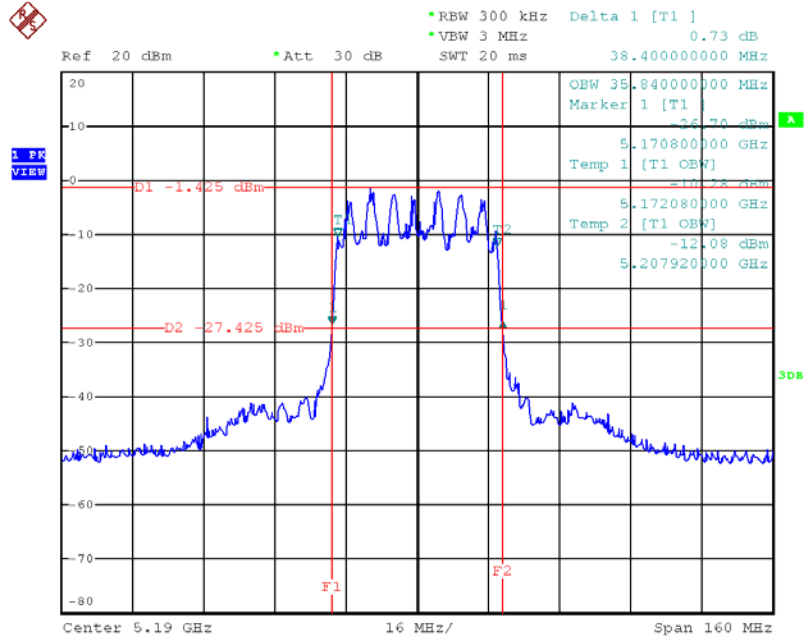

Date: 14.MAY.2013 23:00:15

26dB Bandwidth & 99% Occupied Bandwidth Plot on Configuration IEEE 802.11n MCS0 40MHz / Chain 1 + Chain 2 + Chain 3 / 5230 MHz

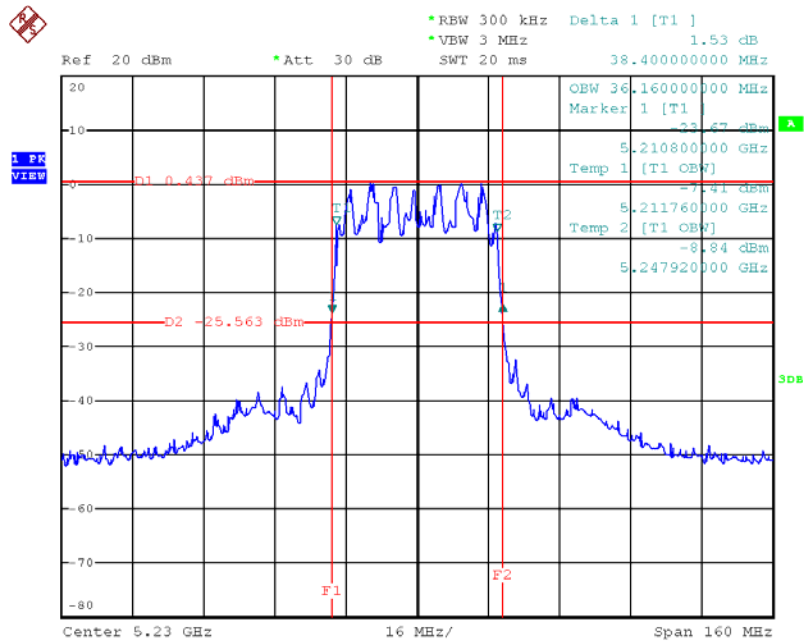

Date: 14.MAY.2013 23:02:29

26dB Bandwidth & 99% Occupied Bandwidth Plot on Configuration IEEE 802.11a / Chain 1 + Chain 2 + Chain 3 / 5180 MHz

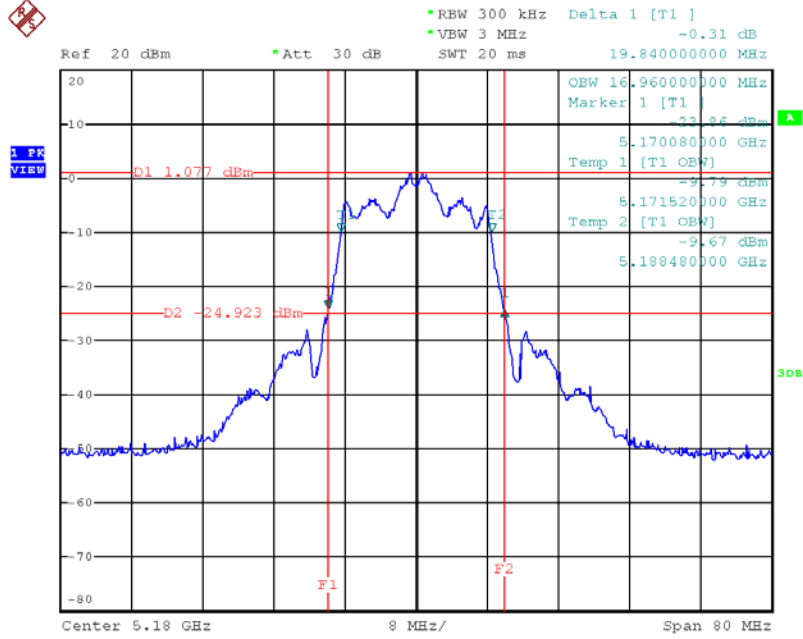

Date: 14.MAY.2013 22:53:45

26dB Bandwidth & 99% Occupied Bandwidth Plot on Configuration IEEE 802.11a / Chain 1 + Chain 2 + Chain 3 / 5200 MHz

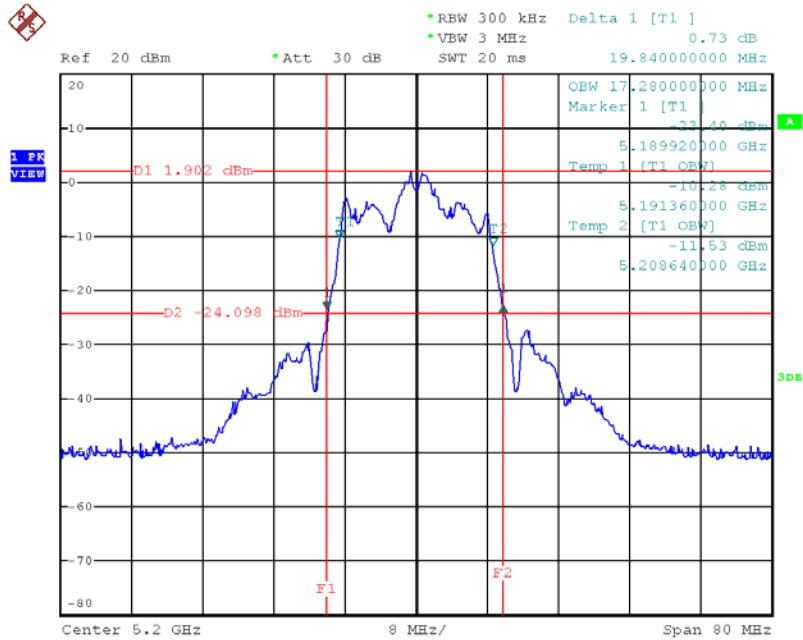

Date: 14.MAY.2013 22:54:49

26dB Bandwidth & 99% Occupied Bandwidth Plot on Configuration IEEE 802.11a / Chain 1 + Chain 2 + Chain 3 / 5240 MHz

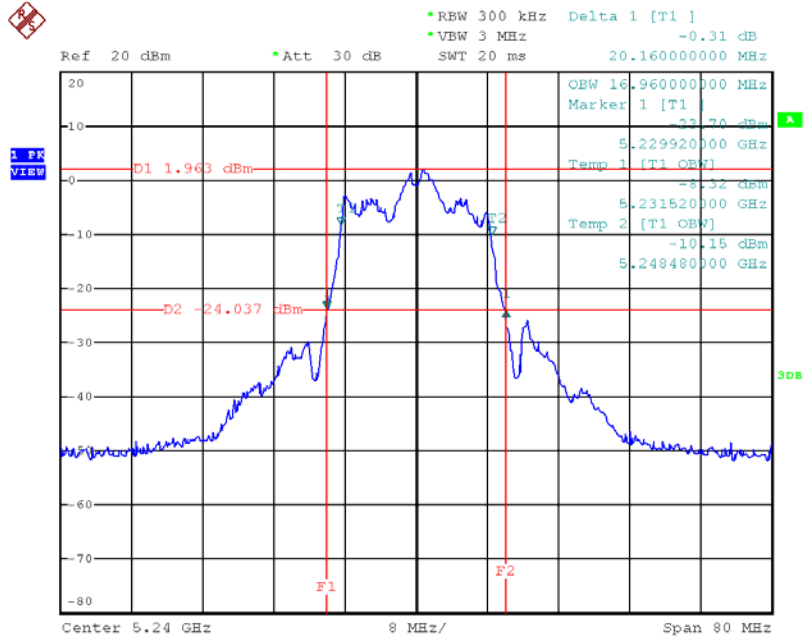

Date: 14.MAY.2013 22:55:30

4.3. Maximum Conducted Output Power Measurement

4.3.1. Limit

For the band 5.15~5.25 GHz, the maximum conducted output power over the frequency band of operation shall not exceed the lesser of 50 mW (17dBm) or $4 \text{ dBm} + 10\log B$, where B is the 26 dB emissions bandwidth in MHz. If transmitting antennas of directional gain greater than 6 dBi are used, both the maximum conducted output power and the peak power spectral density shall be reduced by the amount in dB that the directional gain of the antenna exceeds 6 dBi.

4.3.2. Measuring Instruments and Setting

The following table is the setting of the peak power meter.

Power Meter Parameter	Setting
Bandwidth	50MHz bandwidth is greater than the EUT emission bandwidth
Detector	AVERAGE

4.3.3. Test Procedures

1. The transmitter output (antenna port) was connected to the power meter.
2. Test was performed in accordance with KDB 789033 D01 v01r03 for Compliance Testing of Unlicensed National Information Infrastructure (U-NII) Devices - Part 15, Subpart E, section (E) Maximum conducted output power =>(3) Method PM (Measurement using an RF average power meter) Multiple antenna systems was performed in accordance with KDB 662911 D01 v01r02 Emissions Testing of Transmitters with Multiple Outputs in the Same Band.
3. When measuring maximum conducted output power with multiple antenna systems, add every result of the values by mathematic formula.

4.3.4. Test Setup Layout

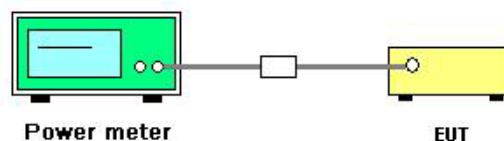

4.3.5. Test Deviation

There is no deviation with the original standard.

4.3.6. EUT Operation during Test

The EUT was programmed to be in continuously transmitting mode.

4.3.7. Test Result of Maximum Conducted Output Power

Temperature	25°C	Humidity	56%
Test Engineer	Sean Ku	Configurations	IEEE 802.11n
Test Date	May 14, 2013		

Configuration IEEE 802.11n MCS0 20MHz / Chain 1 + Chain 2 + Chain 3

Channel	Frequency	Conducted Power (dBm)			Total Conducted Power (dBm)	Max. Limit (dBm)	Result
		Chain 1	Chain 2	Chain 3			
36	5180 MHz	10.06	11.24	10.21	15.31	17.00	Complies
40	5200 MHz	10.05	11.46	10.67	15.54	17.00	Complies
48	5240 MHz	9.78	11.70	10.63	15.55	17.00	Complies

Configuration IEEE 802.11n MCS0 40MHz / Chain 1 + Chain 2 + Chain 3

Channel	Frequency	Conducted Power (dBm)			Total Conducted Power (dBm)	Max. Limit (dBm)	Result
		Chain 1	Chain 2	Chain 3			
38	5190 MHz	8.78	10.14	9.02	14.13	17.00	Complies
46	5230 MHz	11.11	12.63	11.73	16.64	17.00	Complies

Temperature	25°C	Humidity	56%
Test Engineer	Sean Ku	Configurations	IEEE 802.11a
Test Date	May 14, 2013		

Configuration IEEE 802.11a / Chain 1 + Chain 2 + Chain 3

Channel	Frequency	Conducted Power (dBm)			Total Conducted Power (dBm)	Max. Limit (dBm)	Result
		Chain 1	Chain 2	Chain 3			
36	5180 MHz	9.82	11.59	9.88	15.28	16.98	Complies
40	5200 MHz	10.14	11.88	10.12	15.57	16.98	Complies
48	5240 MHz	10.46	11.58	10.05	15.52	17.00	Complies

Note: Power Limit= $4+10*\log(B)$ or 17dBm; $4+10*\log(19.84)=16.98\text{dBm}<17\text{dBm}$, so power limit=16.98dBm

4.4. Power Spectral Density Measurement

4.4.1. Limit

The power spectral density is defined as the highest level of power in dBm per MHz generated by the transmitter within the power envelope. The following table is power spectral density limits and decrease power density limit rule refer to section 4.3.1.

Frequency Range	Power Spectral Density limit (dBm/MHz)
5.15–5.25 GHz	4

4.4.2. Measuring Instruments and Setting

Please refer to section 5 of equipments list in this report. The following table is the setting of the spectrum analyzer.

Spectrum Parameter	Setting
Attenuation	Auto
Span Frequency	Encompass the entire emissions bandwidth (EBW) of the signal
RB	1000 kHz
VB	3000 kHz
Detector	RMS
Trace	AVERAGE
Sweep Time	Auto
Trace Average	100 times

4.4.3. Test Procedures

1. The transmitter output (antenna port) was connected RF switch to the spectrum analyzer.
2. Test was performed in accordance with KDB 789033 D01 v01r03 for Compliance Testing of Unlicensed National Information Infrastructure (U-NII) Devices - Part 15, Subpart E, section (C) Maximum conducted output power => (d) Method SA-2 (trace averaging across on and off times of the EUT transmissions, followed by duty cycle correction).
3. Multiple antenna systems was performed in accordance with KDB 662911 D01 v01r02 in-Band Power Spectral Density (PSD) Measurements (1) Measure and sum the spectra across the outputs.
4. When measuring first spectral bin of output 1 is summed with that in the first spectral bin of output 2 and that from the first spectral bin of output 3 and so on up to the Nth output to obtain the value for the first frequency bin of the summed spectrum. The summed spectrum value for each of the other frequency bins is computed in the same way.

4.4.4. Test Setup Layout

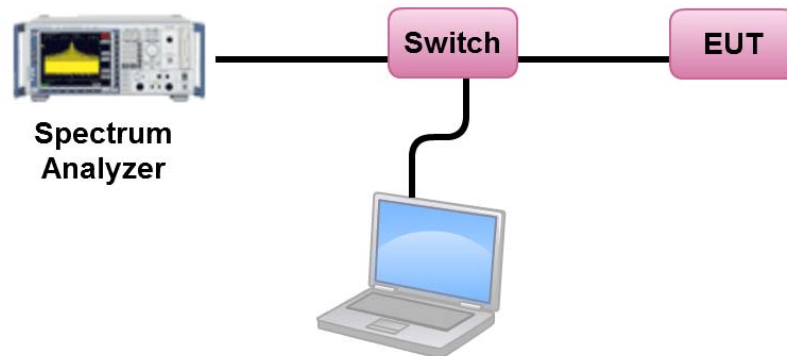

4.4.5. Test Deviation

There is no deviation with the original standard.

4.4.6. EUT Operation during Test

The EUT was programmed to be in continuously transmitting mode.

4.4.7. Test Result of Power Spectral Density

Temperature	25°C	Humidity	56%
Test Engineer	Sean Ku	Configurations	IEEE 802.11n
Test Date	May 14, 2013		

Configuration IEEE 802.11n MCS0 20MHz / Chain 1 + Chain 2 + Chain 3

Channel	Frequency	Total Power Density (dBm/MHz)	Max. Limit (dBm/MHz)	Result
36	5180 MHz	2.13	2.53	Complies
40	5200 MHz	2.19	2.53	Complies
48	5240 MHz	2.23	2.53	Complies

Note: Directional gain=GANT+10log(NANT/Nss)=7.47dBi >6dBi, so limit = 4 - (7.47 - 6) = 2.53dBm/MHz.

Configuration IEEE 802.11n MCS0 40MHz / Chain 1 + Chain 2 + Chain 3

Channel	Frequency	Total Power Density (dBm/MHz)	Max. Limit (dBm/MHz)	Result
38	5190 MHz	-0.86	2.53	Complies
46	5230 MHz	1.50	2.53	Complies

Note: Directional gain=GANT+10log(NANT/Nss)=7.47dBi >6dBi, so limit = 4 - (7.47 - 6) = 2.53dBm/MHz.

Temperature	25°C	Humidity	56%
Test Engineer	Sean Ku	Configurations	IEEE 802.11a
Test Date	May 14, 2013		

Configuration IEEE 802.11a / Chain 1 + Chain 2 + Chain 3

Channel	Frequency	Total Power Density (dBm/MHz)	Max. Limit (dBm/MHz)	Result
36	5180 MHz	2.36	2.53	Complies
40	5200 MHz	2.35	2.53	Complies
48	5240 MHz	2.37	2.53	Complies

Note: Directional gain=GANT+10log(NANT/Nss)=7.47dBi >6dBi, so limit = 4 - (7.47 - 6) = 2.53dBm/MHz.

Note: All the test values were listed in the report.

For plots, only the channel with maximum results was shown.

Power Density Plot on Configuration IEEE 802.11n MCS0 20MHz / Chain 1 + Chain 2 + Chain 3 / 5240 MHz

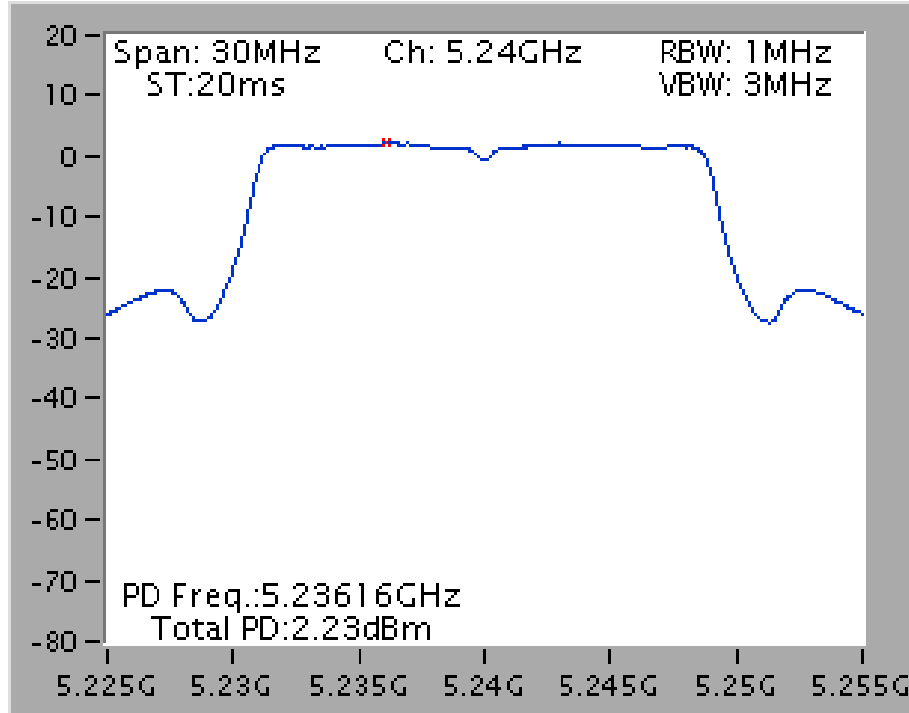

Power Density Plot on Configuration IEEE 802.11n MCS0 40MHz / Chain 1 + Chain 2 + Chain 3 / 5230 MHz

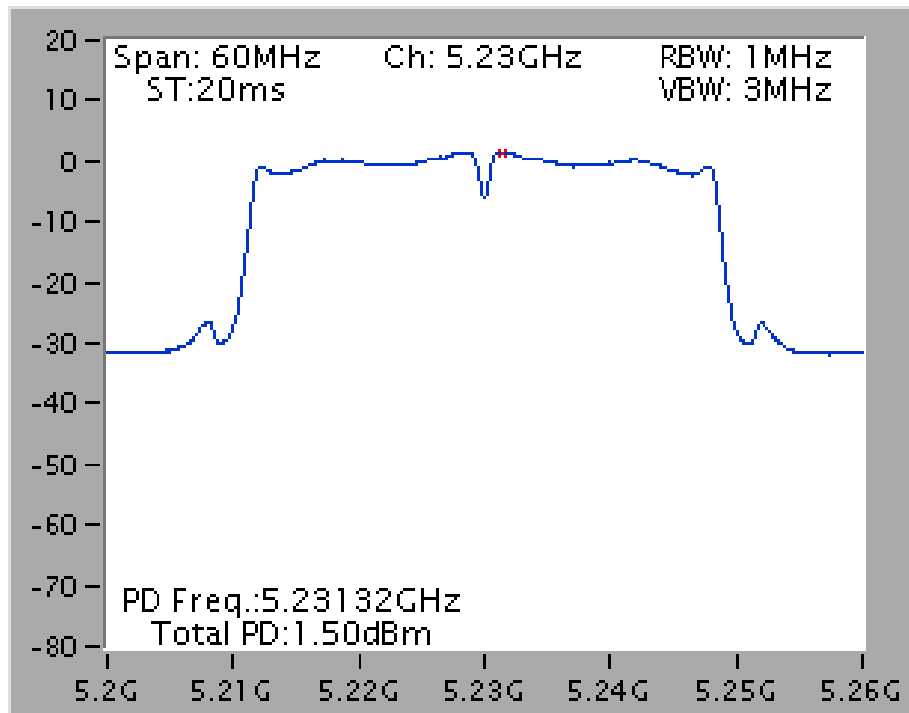

Power Density Plot on Configuration IEEE 802.11a / Chain 1 + Chain 2 + Chain 3 / 5240 MHz

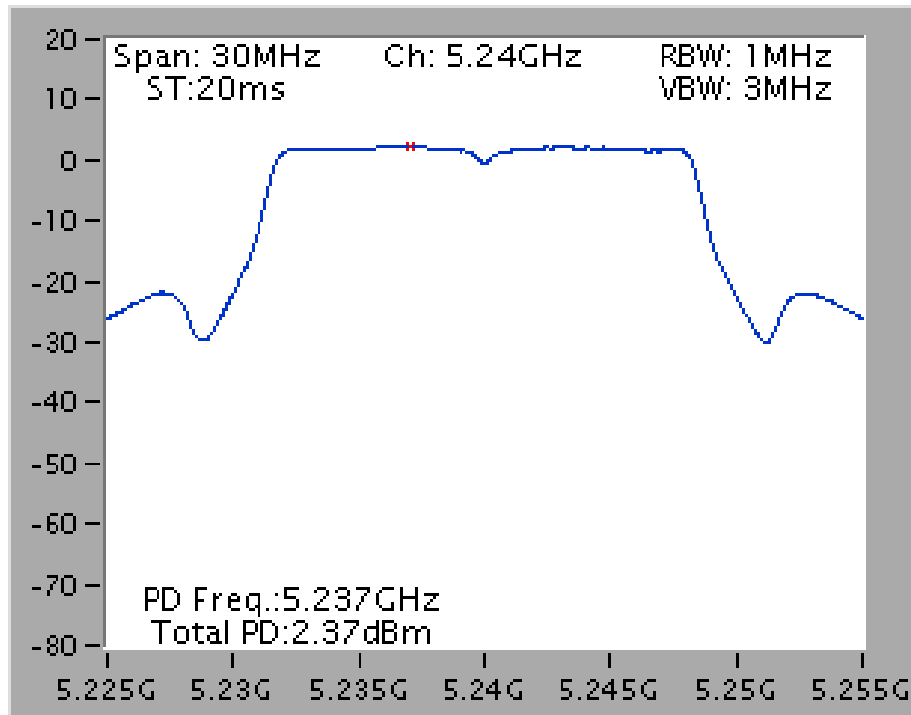

4.5. Peak Excursion Measurement

4.5.1. Limit

The ratio of the peak excursion of the modulation envelope (measured using a peak hold function) to the maximum conducted output power (measured as specified above) shall not exceed 13 dB across any 1 MHz bandwidth or the emissions bandwidth whichever is less.

4.5.2. Measuring Instruments and Setting

Please refer to section 5 of equipments list in this report. The following table is the setting of the spectrum analyzer.

Spectrum Parameter	Setting
Attenuation	Auto
Span Frequency	Encompass the entire emissions bandwidth (EBW) of the signal
RB	1MHz (Peak Trace) / 1MHz (Average Trace)
VB	≥ 3MHz (Peak Trace) / ≥ 3MHz (Average Trace)
Detector	Peak (Peak Trace) / RMS (Average Trace)
Trace	Trace: Max hold (Peak Trace) / Trace Average Sweep Count 100 (Average Trace)
Sweep Time	AUTO

4.5.3. Test Procedures

1. The test procedure is the same as section 4.4.4.
2. Trace A, Set RBW = 1MHz, VBW = 3MHz, Span >26dB bandwidth, Max. hold.
3. Delta Mark trace A Maximum frequency and trace B same frequency.
4. Repeat the above procedure until measurements for all frequencies were complete.
5. Testing each modulation mode on a single channel in single operating band at single output port. All signal types need test (DSSS, OFDM). All modulation types need test (BPSK, QPSK, 16-QAM, 64-QAM, 256-QAM). All bandwidth modes need test.

4.5.4. Test Setup Layout

This test setup layout is the same as that shown in section 4.4.4.

4.5.5. Test Deviation

There is no deviation with the original standard.

4.5.6. EUT Operation during Test

The EUT was programmed to be in continuously transmitting mode.

4.5.7. Test Result of Peak Excursion

Temperature	25°C	Humidity	56%
Test Engineer	Sean Ku	Configurations	IEEE 802.11n

Configuration IEEE 802.11n MCS0 20MHz / Chain 1 + Chain 2 + Chain 3

Modulation	Frequency	Peak Excursion (dB)	Max. Limit (dB)	Result
BSPK(MCS0)	5240MHz	9.82	13	Complies
QPSK(MCS1)	5240MHz	10.44	13	Complies
16QAM(MCS3)	5240MHz	11.71	13	Complies
64QAM(MCS5)	5240MHz	11.05	13	Complies

Configuration IEEE 802.11n MCS0 40MHz / Chain 1 + Chain 2 + Chain 3

Modulation	Frequency	Peak Excursion (dB)	Max. Limit (dB)	Result
BSPK(MCS0)	5230MHz	9.41	13	Complies
QPSK(MCS1)	5230MHz	9.69	13	Complies
16QAM(MCS3)	5230MHz	10.22	13	Complies
64QAM(MCS5)	5230MHz	10.57	13	Complies

Temperature	25°C	Humidity	56%
Test Engineer	Sean Ku	Configurations	IEEE 802.11a

Configuration IEEE 802.11a / Chain 1 + Chain 2 + Chain 3

Modulation	Frequency	Peak Excursion (dB)	Max. Limit (dB)	Result
BSPK(6Mbps)	5200MHz	9.53	13	Complies
QPSK(12Mbps)	5200MHz	10.26	13	Complies
16QAM(24Mbps)	5200MHz	10.18	13	Complies
64QAM(48Mbps)	5200MHz	10.89	13	Complies

Note: All the test values were listed in the report.

For plots, only the channel with maximum results was shown.

Peak Excursion Plot on Configuration IEEE 802.11n MCS0 20MHz / Chain 1 + Chain 2 + Chain 3 / 16QAM(MCS3) / 5240 MHz

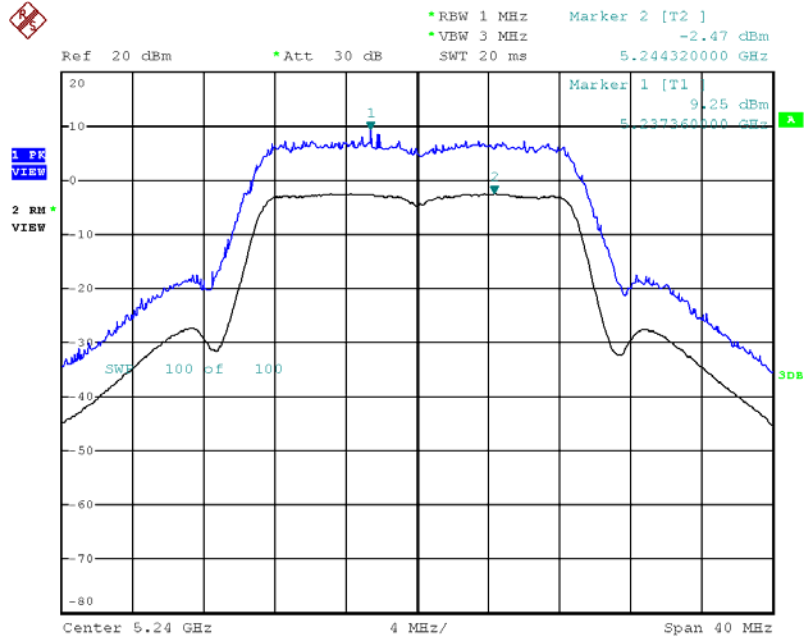

Date: 14.MAY.2013 23:25:39

Peak Excursion Plot on Configuration IEEE 802.11n MCS0 40MHz / Chain 1 + Chain 2 + Chain 3 / 64QAM(MCS5) / 5230 MHz

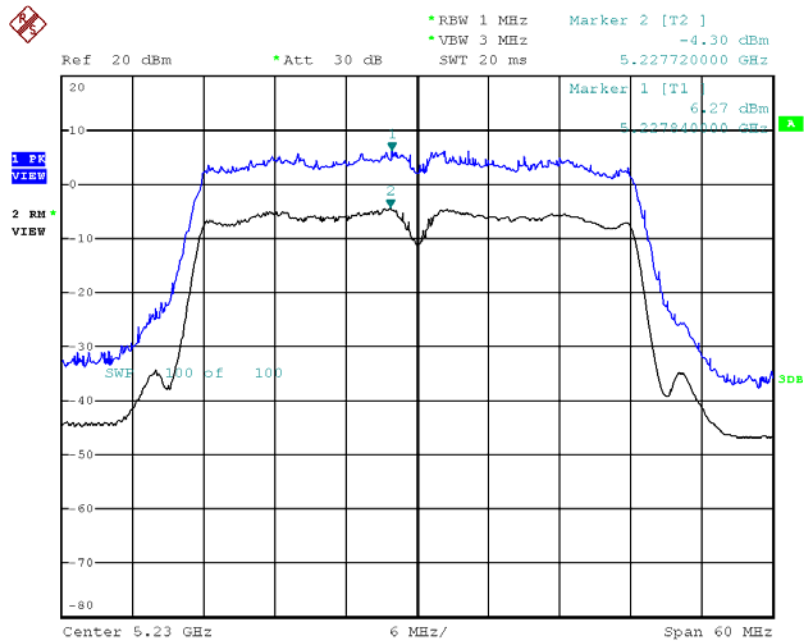

Date: 14.MAY.2013 23:37:33

Peak Excursion Plot on Configuration IEEE 802.11a / Chain 1 + Chain 2 + Chain 3 / 64QAM(48Mbps) / 5200 MHz

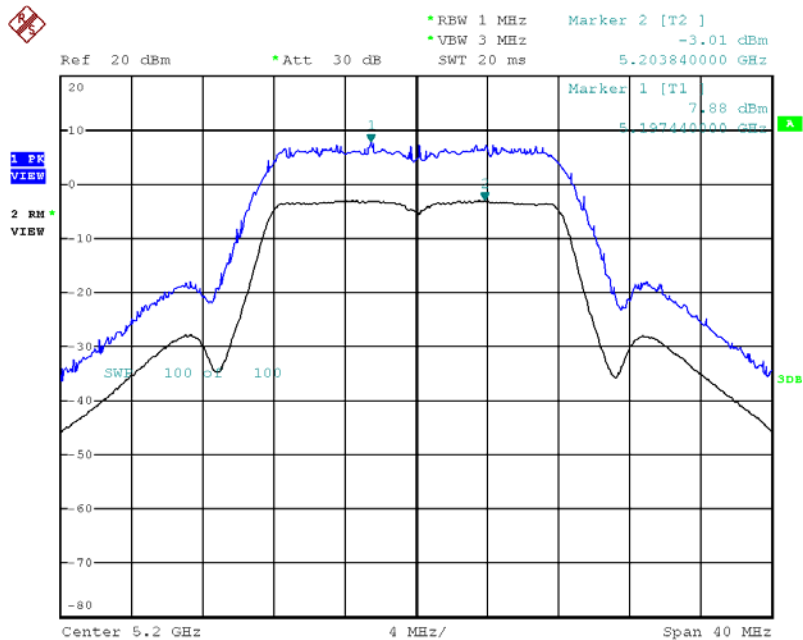

Date: 14.MAY.2013 23:20:35

4.6. Radiated Emissions Measurement

4.6.1. Limit

For transmitters operating in the 5.15-5.35 GHz band: all emissions outside of the 5.15-5.35 GHz band shall not exceed a -27dBm peak limit or average 54dBuV/m and peak 74dBuV/m limits. In addition, In case the emission fall within the restricted band specified on 15.205(a), then the 15.209(a) limit in the table below has to be followed.

Frequencies (MHz)	Field Strength (micorvolts/meter)	Measurement Distance (meters)
0.009~0.490	2400/F(KHz)	300
0.490~1.705	24000/F(KHz)	30
1.705~30.0	30	30
30~88	100	3
88~216	150	3
216~960	200	3
Above 960	500	3

4.6.2. Measuring Instruments and Setting

Please refer to section 5 of equipments list in this report. The following table is the setting of spectrum analyzer and receiver.

Spectrum Parameter	Setting
Attenuation	Auto
Start Frequency	1000 MHz
Stop Frequency	40 GHz
RB / VB (Emission in restricted band)	1MHz / 3MHz for Peak, 1 MHz / 10Hz for Average
RB / VB (Emission in non-restricted band)	1MHz / 3MHz for peak

Receiver Parameter	Setting
Attenuation	Auto
Start ~ Stop Frequency	9kHz~150kHz / RB 200Hz for QP
Start ~ Stop Frequency	150kHz~30MHz / RB 9kHz for QP
Start ~ Stop Frequency	30MHz~1000MHz / RB 120kHz for QP

4.6.3. Test Procedures

1. Configure the EUT according to ANSI C63.10. The EUT was placed on the top of the turntable 0.8 meter above ground. The phase center of the receiving antenna mounted on the top of a height-variable antenna tower was placed 3 meters far away from the turntable.
2. Power on the EUT and all the supporting units. The turntable was rotated by 360 degrees to determine the position of the highest radiation.
3. The height of the broadband receiving antenna was varied between one meter and four meters above ground to find the maximum emissions field strength of both horizontal and vertical polarization.
4. For each suspected emissions, the antenna tower was scan (from 1 M to 4 M) and then the turntable was rotated (from 0 degree to 360 degrees) to find the maximum reading.
5. Set the test-receiver system to Peak or CISPR quasi-peak Detect Function with specified bandwidth under Maximum Hold Mode.
6. For emissions above 1GHz, use 1MHz VBW and RBW for peak reading. Then 1MHz RBW and 10Hz VBW for average reading in spectrum analyzer.
7. When the radiated emissions limits are expressed in terms of the average value of the emissions, and pulsed operation is employed, the measurement field strength shall be determined by averaging over one complete pulse train, including blanking intervals, as long as the pulse train does not exceed 0.1 seconds. As an alternative (provided the transmitter operates for longer than 0.1 seconds) or in cases where the pulse train exceeds 0.1 seconds, the measured field strength shall be determined from the average absolute voltage during a 0.1 second interval during which the field strength is at its maximum value.
8. If the emissions level of the EUT in peak mode was 3 dB lower than the average limit specified, then testing will be stopped and peak values of EUT will be reported, otherwise, the emissions which do not have 3 dB margin will be repeated one by one using the quasi-peak method for below 1GHz.
9. For testing above 1GHz, the emissions level of the EUT in peak mode was lower than average limit (that means the emissions level in peak mode also complies with the limit in average mode), then testing will be stopped and peak values of EUT will be reported, otherwise, the emissions will be measured in average mode again and reported.
10. In case the emission is lower than 30MHz, loop antenna has to be used for measurement and the recorded data should be QP measured by receiver. High – Low scan is not required in this case.

4.6.4. Test Setup Layout

For radiated emissions below 1GHz

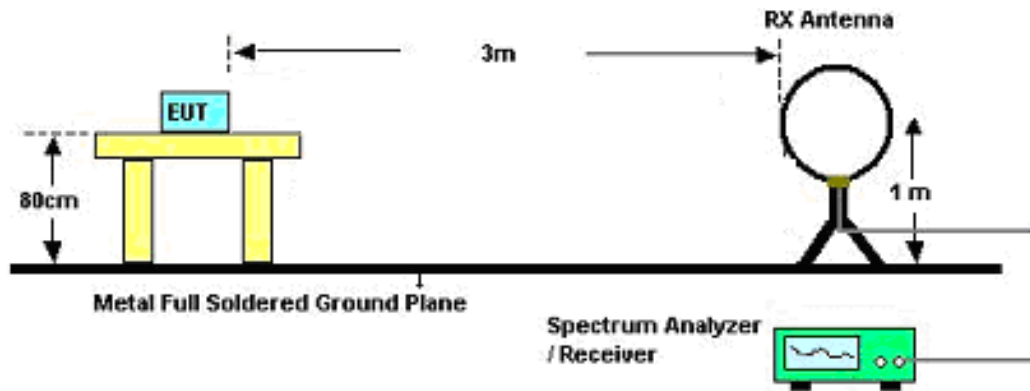

For radiated emissions above 1GHz

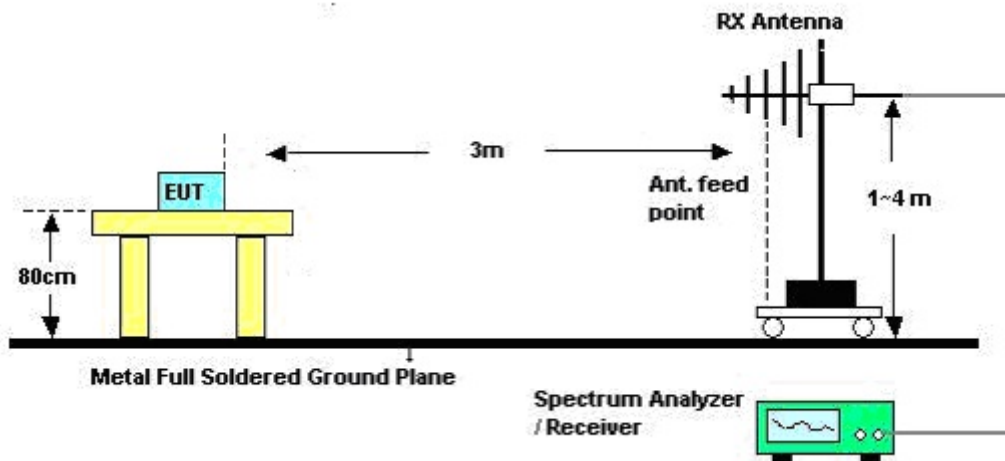

4.6.5. Test Deviation

There is no deviation with the original standard.

4.6.6. EUT Operation during Test

The EUT was programmed to be in continuously transmitting mode.

4.6.7. Results of Radiated Emissions (9kHz~30MHz)

Temperature	26°C	Humidity	60%
Test Engineer	Serway Li	Test Mode	CTX
Test Date	May 14, 2013		

Freq. (MHz)	Level (dBuV)	Over Limit (dB)	Limit Line (dBuV)	Remark
-	-	-	-	See Note

Note:

The amplitude of spurious emissions that are attenuated by more than 20dB below the permissible value has no need to be reported.

Distance extrapolation factor = $40 \log(\text{specific distance} / \text{test distance})$ (dB);

Limit line = specific limits (dBuV) + distance extrapolation factor.

4.6.8. Results of Radiated Emissions (30MHz~1GHz)

Temperature	26°C	Humidity	60%
Test Engineer	Serway Li	Test Mode	CTX

Horizontal

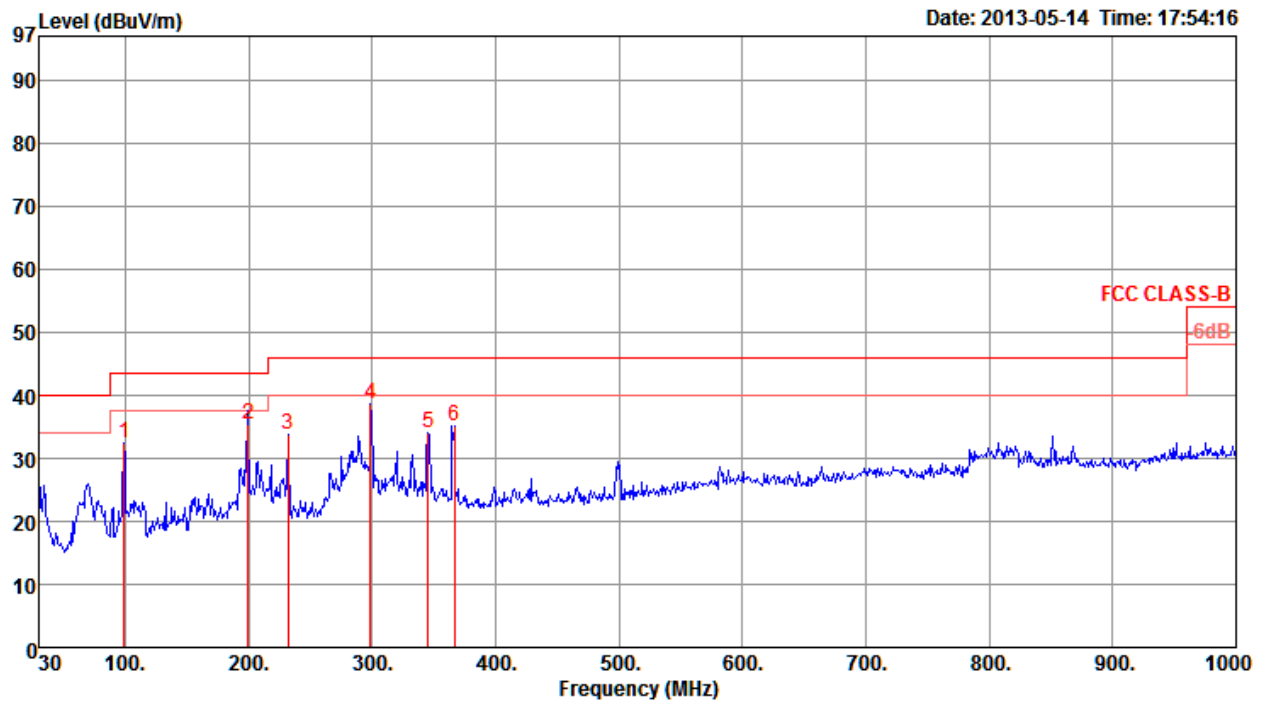

	Freq	Level	Limit	Over	Read	Cable	Preamp	Antenna	Remark	T/Pos	A/Pos	Pol/Phase
	MHz	dBuV/m	dBuV/m	dB	dBuV	Loss	Factor	Factor		deg	cm	
1	98.87	32.33	43.50	-11.17	47.47	1.49	27.82	11.19	Peak	0	100	HORIZONTAL
2	199.75	35.47	43.50	-8.03	50.23	2.09	27.25	10.40	Peak	0	100	HORIZONTAL
3	231.76	33.85	46.00	-12.15	47.12	2.29	27.02	11.46	Peak	0	100	HORIZONTAL
4 p	298.69	38.77	46.00	-7.23	49.29	2.51	26.83	13.80	Peak	0	100	HORIZONTAL
5	345.25	33.92	46.00	-12.08	43.03	2.77	27.04	15.16	Peak	0	100	HORIZONTAL
6	366.59	35.19	46.00	-10.81	43.82	2.86	27.19	15.70	Peak	0	100	HORIZONTAL

Vertical

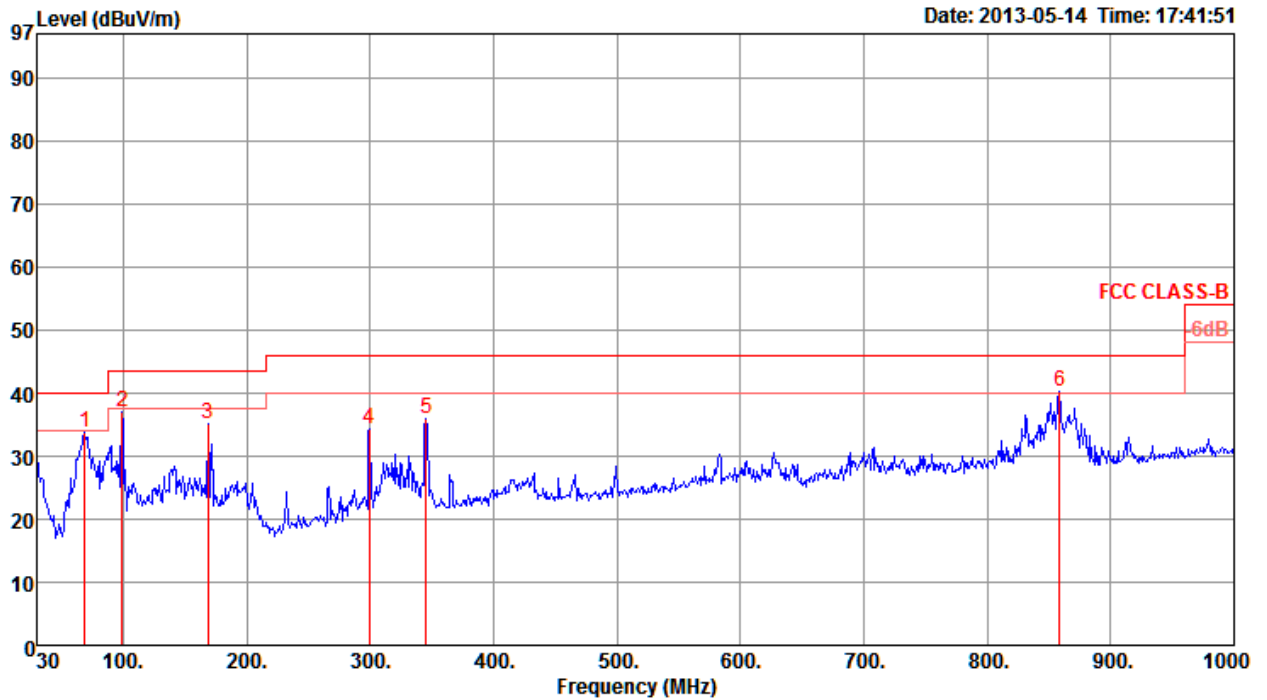

	Freq	Level	Limit	Over	Read	Cable	Preamp	Antenna	Remark	T/Pos	A/Pos	Pol/Phase
	MHz	dBuV/m	dBuV/m	dB	dBuV	dB	dB	dB/m		deg	cm	
1	68.80	33.88	40.00	-6.12	53.75	1.26	27.94	6.81	Peak	0	400	VERTICAL
2	98.87	37.02	43.50	-6.48	52.16	1.49	27.82	11.19	Peak	0	400	VERTICAL
3	168.71	35.11	43.50	-8.39	50.25	1.94	27.41	10.33	Peak	0	400	VERTICAL
4	299.66	34.44	46.00	-11.56	44.96	2.51	26.83	13.80	Peak	0	400	VERTICAL
5	345.25	36.05	46.00	-9.95	45.16	2.77	27.04	15.16	Peak	0	400	VERTICAL
6 p	858.38	40.13	46.00	-5.87	41.31	4.46	26.89	21.25	Peak	0	400	VERTICAL

Note:

The amplitude of spurious emissions that are attenuated by more than 20dB below the permissible value has no need to be reported.

Emission level (dBuV/m) = 20 log Emission level (uV/m).

Corrected Reading: Antenna Factor + Cable Loss + Read Level - Preamp Factor = Level.

4.6.9. Results for Radiated Emissions (1GHz~40GHz)

Temperature	26°C	Humidity	60%
Test Engineer	Serway Li	Configurations	IEEE 802.11n MCS0 20MHz CH 36 / Chain 1 + Chain 2 + Chain 3
Test Date	May 14, 2013		

Horizontal

	Freq	Level	Limit	Over	Read	Cable	Preamp	Antenna	Remark	T/Pos	A/Pos	Pol/Phase
	MHz	dBuV/m	dBuV/m	dB	dBuV	dB	dB	dB/m		deg	cm	
1 p	15538.28	54.94	74.00	-19.06	43.39	7.85	34.79	38.49	Peak	222	100	HORIZONTAL
2 a	15538.80	42.30	54.00	-11.70	30.75	7.85	34.79	38.49	Average	222	100	HORIZONTAL

Vertical

	Freq	Level	Limit	Over	Read	Cable	Preamp	Antenna	Remark	T/Pos	A/Pos	Pol/Phase
	MHz	dBuV/m	dBuV/m	dB	dBuV	dB	dB	dB/m		deg	cm	
1 a	15546.32	42.28	54.00	-11.72	30.72	7.86	34.79	38.49	Average	134	100	VERTICAL
2 p	15548.80	55.10	74.00	-18.90	43.56	7.86	34.81	38.49	Peak	134	100	VERTICAL

Temperature	26°C	Humidity	60%
Test Engineer	Serway Li	Configurations	IEEE 802.11n MCS0 20MHz CH 40 / Chain 1 + Chain 2 + Chain 3
Test Date	May 14, 2013		

Horizontal

	Freq	Level	Limit	Over	Read	Cable	Preamp	Antenna	Remark	T/Pos	A/Pos	Pol/Phase
	MHz	dBuV/m	dBuV/m	dB	dBuV	dB	dB	dB/m		deg	cm	
1 p	15601.60	55.31	74.00	-18.69	43.81	7.88	34.86	38.48	Peak	218	100	HORIZONTAL
2 a	15610.00	41.41	54.00	-12.59	29.91	7.88	34.86	38.48	Average	218	100	HORIZONTAL

Vertical

	Freq	Level	Limit	Over	Read	Cable	Preamp	Antenna	Remark	T/Pos	A/Pos	Pol/Phase
	MHz	dBuV/m	dBuV/m	dB	dBuV	dB	dB	dB/m		deg	cm	
1 a	15590.08	41.81	54.00	-12.19	30.29	7.87	34.83	38.48	Average	64	100	VERTICAL
2 p	15607.16	54.55	74.00	-19.45	43.05	7.88	34.86	38.48	Peak	64	100	VERTICAL



Temperature	26°C	Humidity	60%
Test Engineer	Serway Li	Configurations	IEEE 802.11n MCS0 20MHz CH 48 / Chain 1 + Chain 2 + Chain 3
Test Date	May 14, 2013		

Horizontal

	Freq	Level	Limit Line	Over Limit	Read Level	Cable Loss	Preamp Factor	Antenna Factor	Remark	T/Pos	A/Pos	Pol/Phase
	MHz	dBuV/m	dBuV/m	dB	dBuV	dB	dB	dB/m		deg	cm	
1 p	15710.00	52.85	74.00	-21.15	41.42	7.91	34.94	38.46	Peak	343	100	HORIZONTAL
2 a	15710.00	40.95	54.00	-13.05	29.52	7.91	34.94	38.46	Average	343	100	HORIZONTAL

Vertical

	Freq	Level	Limit Line	Over Limit	Read Level	Cable Loss	Preamp Factor	Antenna Factor	Remark	T/Pos	A/Pos	Pol/Phase
	MHz	dBuV/m	dBuV/m	dB	dBuV	dB	dB	dB/m		deg	cm	
1 p	15710.00	52.88	74.00	-21.12	41.45	7.91	34.94	38.46	Peak	262	100	VERTICAL
2 a	15710.00	41.39	54.00	-12.61	29.96	7.91	34.94	38.46	Average	262	100	VERTICAL



Temperature	26°C	Humidity	60%
Test Engineer	Serway Li	Configurations	IEEE 802.11n MCS0 40MHz CH 38 / Chain 1 + Chain 2 + Chain 3
Test Date	May 14, 2013		

Horizontal

	Freq	Level	Limit	Over	Read	Cable	Preamp	Antenna	Remark	T/Pos	A/Pos	Pol/Phase
	MHz	dBuV/m	dBuV/m	dB	dBuV	dB	dB	dB/m		deg	cm	
1 a	15560.88	42.10	54.00	-11.90	30.56	7.86	34.81	38.49	Average	0	100	HORIZONTAL
2 p	15574.40	55.13	74.00	-18.87	43.61	7.86	34.83	38.49	Peak	0	100	HORIZONTAL

Vertical

	Freq	Level	Limit	Over	Read	Cable	Preamp	Antenna	Remark	T/Pos	A/Pos	Pol/Phase
	MHz	dBuV/m	dBuV/m	dB	dBuV	dB	dB	dB/m		deg	cm	
1 p	15574.40	53.57	74.00	-20.43	42.05	7.86	34.83	38.49	Peak	360	100	VERTICAL
2 a	15574.40	41.79	54.00	-12.21	30.27	7.86	34.83	38.49	Average	360	100	VERTICAL



Temperature	26°C	Humidity	60%
Test Engineer	Serway Li	Configurations	IEEE 802.11n MCS0 40MHz CH 46 / Chain 1 + Chain 2 + Chain 3
Test Date	May 14, 2013		

Horizontal

	Freq	Level	Limit Line	Over Limit	Read Level	Cable Loss	Preamp Factor	Antenna Factor	Remark	T/Pos	A/Pos	Pol/Phase
	MHz	dBuV/m	dBuV/m	dB	dBuV	dB	dB	dB/m		deg	cm	
1 a	15682.68	41.60	54.00	-12.40	30.16	7.90	34.92	38.46	Average	183	100	HORIZONTAL
2 p	15694.32	54.79	74.00	-19.21	43.35	7.90	34.92	38.46	Peak	183	100	HORIZONTAL

Vertical

	Freq	Level	Limit Line	Over Limit	Read Level	Cable Loss	Preamp Factor	Antenna Factor	Remark	T/Pos	A/Pos	Pol/Phase
	MHz	dBuV/m	dBuV/m	dB	dBuV	dB	dB	dB/m		deg	cm	
1 a	15689.52	41.68	54.00	-12.32	30.24	7.90	34.92	38.46	Average	152	100	VERTICAL
2 p	15690.36	54.21	74.00	-19.79	42.77	7.90	34.92	38.46	Peak	152	100	VERTICAL



Temperature	26°C	Humidity	60%
Test Engineer	Serway Li	Configurations	IEEE 802.11a CH 36 / Chain 1 + Chain 2 + Chain 3
Test Date	May 14, 2013		

Horizontal

	Freq	Level	Limit	Over	Read	Cable	Preamp	Antenna	Remark	T/Pos	A/Pos	Pol/Phase
	MHz	dBuV/m	dBuV/m	dB	dBuV	dB	dB	dB/m		deg	cm	
1 p	15539.83	54.97	74.00	-19.03	43.42	7.85	34.79	38.49	Peak	62	100	HORIZONTAL
2 a	15540.32	42.38	54.00	-11.62	30.83	7.85	34.79	38.49	Average	62	100	HORIZONTAL

Vertical

	Freq	Level	Limit	Over	Read	Cable	Preamp	Antenna	Remark	T/Pos	A/Pos	Pol/Phase
	MHz	dBuV/m	dBuV/m	dB	dBuV	dB	dB	dB/m		deg	cm	
1 p	15540.13	55.17	74.00	-18.83	43.62	7.85	34.79	38.49	Peak	158	100	VERTICAL
2 a	15540.21	42.35	54.00	-11.65	30.80	7.85	34.79	38.49	Average	158	100	VERTICAL

Temperature	26°C	Humidity	60%
Test Engineer	Serway Li	Configurations	IEEE 802.11a CH 40 / Chain 1 + Chain 2 + Chain 3
Test Date	May 14, 2013		

Horizontal

	Freq	Level	Limit	Over	Read	Cable	Preamp	Antenna	Remark	T/Pos	A/Pos	Pol/Phase
	MHz	dBuV/m	dBuV/m	dB	dBuV	dB	dB	dB/m		deg	cm	
1 p	15599.77	54.48	74.00	-19.52	42.98	7.88	34.86	38.48	Peak	182	100	HORIZONTAL
2 a	15599.81	41.82	54.00	-12.18	30.32	7.88	34.86	38.48	Average	182	100	HORIZONTAL

Vertical

	Freq	Level	Limit	Over	Read	Cable	Preamp	Antenna	Remark	T/Pos	A/Pos	Pol/Phase
	MHz	dBuV/m	dBuV/m	dB	dBuV	dB	dB	dB/m		deg	cm	
1 a	15599.91	41.80	54.00	-12.20	30.30	7.88	34.86	38.48	Average	310	100	VERTICAL
2 p	15600.40	54.66	74.00	-19.34	43.16	7.88	34.86	38.48	Peak	310	100	VERTICAL



Temperature	26°C	Humidity	60%
Test Engineer	Serway Li	Configurations	IEEE 802.11a CH 48 / Chain 1 + Chain 2 + Chain 3
Test Date	May 14, 2013		

Horizontal

	Freq	Level	Limit	Over	Read	Cable	Preamp	Antenna	Remark	T/Pos	A/Pos	Pol/Phase
	MHz	dBuV/m	dBuV/m	dB	dBuV	dB	dB	dB/m		deg	cm	
1 a	15719.94	41.15	54.00	-12.85	29.71	7.92	34.94	38.46	Average	247	100	HORIZONTAL
2 p	15720.09	53.73	74.00	-20.27	42.29	7.92	34.94	38.46	Peak	247	100	HORIZONTAL

Vertical

	Freq	Level	Limit	Over	Read	Cable	Preamp	Antenna	Remark	T/Pos	A/Pos	Pol/Phase
	MHz	dBuV/m	dBuV/m	dB	dBuV	dB	dB	dB/m		deg	cm	
1 a	15719.85	41.03	54.00	-12.97	29.59	7.92	34.94	38.46	Average	169	100	VERTICAL
2 p	15720.39	54.12	74.00	-19.88	42.68	7.92	34.94	38.46	Peak	169	100	VERTICAL

Note:

The amplitude of spurious emissions that are attenuated by more than 20dB below the permissible value has no need to be reported.

Emission level (dBuV/m) = 20 log Emission level (uV/m).

Corrected Reading: Antenna Factor + Cable Loss + Read Level - Preamp Factor = Level.

4.7. Band Edge Emissions Measurement

4.7.1. Limit

For transmitters operating in the 5.15-5.35 GHz band: all emissions outside of the 5.15-5.35 GHz band shall not exceed a -27dBm peak limit or average 54dBuV/m and peak 74dBuV/m limits. In addition, In case the emission fall within the restricted band specified on 15.205(a), then the 15.209(a) limit in the table below has to be followed.

Frequencies (MHz)	Field Strength (micorvolts/meter)	Measurement Distance (meters)
0.009~0.490	2400/F(KHz)	300
0.490~1.705	24000/F(KHz)	30
1.705~30.0	30	30
30~88	100	3
88~216	150	3
216~960	200	3
Above 960	500	3

4.7.2. Measuring Instruments and Setting

Please refer to section 5 of equipments list in this report. The following table is the setting of the spectrum analyzer.

Spectrum Parameter	Setting
Attenuation	Auto
Span Frequency	100 MHz
RB / VB (Emission in restricted band)	1MHz / 3MHz for Peak, 1 MHz / 10Hz for Average
RB / VB (Emission in non-restricted band)	1MHz / 3MHz for Peak

4.7.3. Test Procedures

1. The test procedure is the same as section 4.6.3, only the frequency range investigated is limited to 100MHz around bandedges.

4.7.4. Test Setup Layout

This test setup layout is the same as that shown in section 4.6.4.

4.7.5. Test Deviation

There is no deviation with the original standard.

4.7.6. EUT Operation during Test

The EUT was programmed to be in continuously transmitting mode.

4.7.7. Test Result of Band Edge and Fundamental Emissions

Temperature	26°C	Humidity	60%
Test Engineer	Serway Li	Configurations	IEEE 802.11n MCS0 20MHz Ch 36, 40, 48 / Chain 1 + Chain 2 + Chain 3
Test Date	May 14, 2013		

Channel 36

	Freq	Level	Limit Line	Over Limit	Read Level	Cable Loss	Antenna Factor	Preamp Factor	A/Pos	T/Pos	Pol/Phase	Remark
	MHz	dBuV/m	dBuV/m	dB	dBuV	dB	dB/m	dB	cm	deg		
1	5104.40	64.81	74.00	-9.19	25.86	5.97	32.98	0.00	164	255	HORIZONTAL	Peak
2 !	5104.80	53.40	54.00	-0.60	14.45	5.97	32.98	0.00	164	255	HORIZONTAL	Average
3 pp	5184.80	105.42			66.37	6.01	33.04	0.00	164	255	HORIZONTAL	Average
4 pk	5184.80	116.18			77.13	6.01	33.04	0.00	164	255	HORIZONTAL	Peak

Item 3, 4 are the fundamental frequency at 5180 MHz.

Channel 40

	Freq	Level	Limit Line	Over Limit	Read Level	Cable Loss	Preamp Factor	Antenna Factor	Remark	T/Pos	A/Pos	Pol/Phase
	MHz	dBuV/m	dBuV/m	dB	dBuV	dB	dB	dB/m		deg	cm	
1	5121.20	60.54	74.00	-13.46	23.13	4.32	0.00	33.09	Peak	103	181	HORIZONTAL
2 !	5125.20	48.37	54.00	-5.63	10.93	4.33	0.00	33.11	Average	103	181	HORIZONTAL
3 a	5195.60	101.94			64.35	4.37	0.00	33.22	Average	103	181	HORIZONTAL
4 p	5205.20	115.31			77.72	4.37	0.00	33.22	Peak	103	181	HORIZONTAL

Item 3, 4 are the fundamental frequency at 5200 MHz.

Channel 48

	Freq	Level	Limit Line	Over Limit	Read Level	Cable Loss	Preamp Factor	Antenna Factor	Remark	T/Pos	A/Pos	Pol/Phase
	MHz	dBuV/m	dBuV/m	dB	dBuV	dB	dB	dB/m		deg	cm	
1	5142.20	59.35	74.00	-14.65	21.87	4.34	0.00	33.14	Peak	103	173	HORIZONTAL
2	5150.00	46.10	54.00	-7.90	8.62	4.34	0.00	33.14	Average	103	173	HORIZONTAL
3 a	5245.40	103.37			65.67	4.40	0.00	33.30	Average	103	173	HORIZONTAL
4 p	5246.00	116.57			78.87	4.40	0.00	33.30	Peak	103	173	HORIZONTAL
5	5350.00	57.18	74.00	-16.82	19.25	4.47	0.00	33.46	Peak	103	173	HORIZONTAL
6	5350.00	45.65	54.00	-8.35	7.72	4.47	0.00	33.46	Average	103	173	HORIZONTAL

Item 3, 4 are the fundamental frequency at 5240 MHz.

Temperature	26°C	Humidity	60%
Test Engineer	Serway Li	Configurations	IEEE 802.11n MCS0 40MHz Ch 38, 46 / Chain 1 + Chain 2 + Chain 3
Test Date	May 14, 2013		

Channel 38

	Freq	Level	Limit	Over	Read	CableAntenna	Preamp	A/Pos	T/Pos	Pol/Phase	Remark
	MHz	dBuV/m	Line	Limit	Level	Loss	Factor				
			dBuV/m	dB	dBuV	dB	dB/m	dB	cm	deg	
1 !	5148.40	53.51	54.00	-0.49	14.50	5.99	33.02	0.00	154	269	HORIZONTAL Average
2	5148.80	66.39	74.00	-7.61	27.38	5.99	33.02	0.00	154	269	HORIZONTAL Peak
3 pp	5188.00	96.79			57.72	6.02	33.05	0.00	154	269	HORIZONTAL Average
4 pk	5188.00	108.37			69.30	6.02	33.05	0.00	154	269	HORIZONTAL Peak

Item 3, 4 are the fundamental frequency at 5190 MHz.

Channel 46

	Freq	Level	Limit	Over	Read	CableAntenna	Preamp	A/Pos	T/Pos	Pol/Phase	Remark
	MHz	dBuV/m	Line	Limit	Level	Loss	Factor				
			dBuV/m	dB	dBuV	dB	dB/m	dB	cm	deg	
1 !	5000.00	50.48	54.00	-3.52	11.68	5.90	32.90	0.00	145	267	HORIZONTAL Average
2	5150.00	60.56	74.00	-13.44	21.55	5.99	33.02	0.00	145	267	HORIZONTAL Peak
3 pp	5228.00	104.00			64.88	6.04	33.08	0.00	145	267	HORIZONTAL Average
4 pk	5233.00	113.86			74.73	6.04	33.09	0.00	145	267	HORIZONTAL Peak

Item 3, 4 are the fundamental frequency at 5230 MHz.

Temperature	26°C	Humidity	60%
Test Engineer	Serway Li	Configurations	IEEE 802.11a Ch 36, 40, 48 / Chain 1 + Chain 2 + Chain 3
Test Date	May 14, 2013		

Channel 36

	Freq	Level	Limit	Over	Read	CableAntenna	Preamp	A/Pos	T/Pos	Pol/Phase	Remark
	MHz	dBuV/m	dBuV/m	dB	dBuV	dB	dB/m	dB	cm	deg	
1 !	5106.80	53.80	54.00	-0.20	14.85	5.97	32.98	0.00	147	75	HORIZONTAL Average
2	5148.00	65.51	74.00	-8.49	26.50	5.99	33.02	0.00	147	75	HORIZONTAL Peak
3 pp	5177.60	108.08			69.03	6.01	33.04	0.00	147	75	HORIZONTAL Average
4 pk	5177.60	117.36			78.31	6.01	33.04	0.00	147	75	HORIZONTAL Peak

Item 3, 4 are the fundamental frequency at 5180 MHz.

Channel 40

	Freq	Level	Limit	Over	Read	CableAntenna	Preamp	A/Pos	T/Pos	Pol/Phase	Remark
	MHz	dBuV/m	dBuV/m	dB	dBuV	dB	dB/m	dB	cm	deg	
1 !	5125.80	53.88	54.00	-0.12	14.91	5.98	32.99	0.00	157	78	HORIZONTAL Average
2	5126.80	65.23	74.00	-8.77	26.26	5.98	32.99	0.00	157	78	HORIZONTAL Peak
3 pk	5196.00	117.87			78.80	6.02	33.05	0.00	157	78	HORIZONTAL Peak
4 pp	5196.40	107.22			68.15	6.02	33.05	0.00	157	78	HORIZONTAL Average

Item 3, 4 are the fundamental frequency at 5200 MHz.

Channel 48

	Freq	Level	Limit	Over	Read	CableAntenna	Preamp	A/Pos	T/Pos	Pol/Phase	Remark
	MHz	dBuV/m	dBuV/m	dB	dBuV	dB	dB/m	dB	cm	deg	
1 !	5000.00	52.62	54.00	-1.38	13.82	5.90	32.90	0.00	150	267	HORIZONTAL Average
2 !	5150.00	48.14	54.00	-5.86	9.13	5.99	33.02	0.00	150	267	HORIZONTAL Average
3	5150.00	60.77	74.00	-13.23	21.76	5.99	33.02	0.00	150	267	HORIZONTAL Peak
4 pk	5233.00	117.30			78.17	6.04	33.09	0.00	150	267	HORIZONTAL Peak
5 pp	5243.00	106.86			67.72	6.05	33.09	0.00	150	267	HORIZONTAL Average

Item 4, 5 are the fundamental frequency at 5240 MHz.

Note:

Emission level (dBuV/m) = 20 log Emission level (uV/m)

Corrected Reading: Antenna Factor + Cable Loss + Read Level - Preamp Factor = Level

4.8. Frequency Stability Measurement

4.8.1. Limit

In-band emission is maintained within the band of operation under all conditions of normal operation as specified in the user’s manual.

The transmitter center frequency tolerance shall be ± 20 ppm maximum for the 5 GHz band (IEEE 802.11n specification).

4.8.2. Measuring Instruments and Setting

Please refer to section 5 of equipments list in this report. The following table is the setting of the spectrum analyzer.

Spectrum Parameter	Setting
Attenuation	Auto
Span Frequency	Entire absence of modulation emissions bandwidth
RB	10 kHz
VB	10 kHz
Sweep Time	Auto

4.8.3. Test Procedures

1. The transmitter output (antenna port) was connected to the spectrum analyzer.
2. EUT have transmitted absence of modulation signal and fixed channelize.
3. Set the spectrum analyzer span to view the entire absence of modulation emissions bandwidth.
4. Set RBW = 10 kHz, VBW = 10 kHz with peak detector and maxhold settings.
5. f_c is declaring of channel frequency. Then the frequency error formula is $(f_c - f) / f_c \times 10^6$ ppm and the limit is less than ± 20 ppm (IEEE 802.11n specification).
6. The test extreme voltage is to change the primary supply voltage from 85 to 115 percent of the nominal value
7. Extreme temperature rule is $-30^\circ\text{C} \sim 50^\circ\text{C}$.

4.8.4. Test Setup Layout

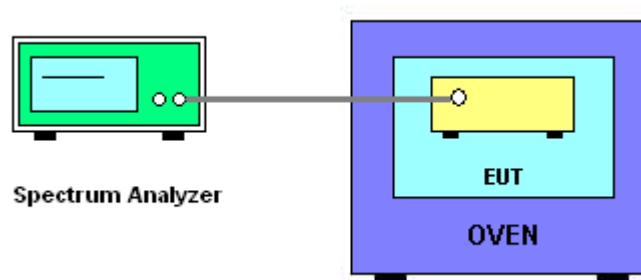

4.8.5. Test Deviation

There is no deviation with the original standard.

4.8.6. EUT Operation during Test

The EUT was programmed to be in continuously un-modulation transmitting mode.

4.8.7. Test Result of Frequency Stability

Voltage vs. Frequency Stability

Voltage	Measurement Frequency (MHz)
(V)	5200
126.50	5200.0523
110.00	5200.0668
93.50	5200.0752
Max. Deviation (MHz)	0.075200
Max. Deviation (ppm)	14.46

Temperature vs. Frequency Stability

Temperature	Measurement Frequency (MHz)
(°C)	5200
-30	5200.0399
-20	5200.0398
-10	5200.0398
0	5200.0332
10	5200.0344
20	5200.0262
30	5200.0243
40	5200.0242
50	5200.0214
Max. Deviation (MHz)	0.039900
Max. Deviation (ppm)	7.67

4.9. Antenna Requirements

4.9.1. Limit

Except for special regulations, the Low-power Radio-frequency Devices must not be equipped with any jacket for installing an antenna with extension cable. An intentional radiator shall be designed to ensure that no antenna other than that furnished by the responsible party shall be used with the device. The use of a permanently attached antenna or of an antenna that uses a unique coupling to the intentional radiator shall be considered sufficient to comply with the provisions of this Section. The manufacturer may design the unit so that the user can replace a broken antenna, but the use of a standard antenna jack or electrical connector is prohibited. Further, this requirement does not apply to intentional radiators that must be professionally installed.

4.9.2. Antenna Connector Construction

Please refer to section 3.3 in this test report; antenna connector complied with the requirements.

5. LIST OF MEASURING EQUIPMENTS

Instrument	Manufacturer	Model No.	Serial No.	Characteristics	Calibration Date	Remark
EMI Test Receiver	R&S	ESCS 30	100377	9kHz ~ 2.75GHz	Oct. 23, 2012	Conduction (CO01-CB)
LISN	F.C.C.	FCC-LISN-50-16-2	04083	150kHz ~ 100MHz	Nov. 26, 2012	Conduction (CO01-CB)
V- LISN	Schwarzbeck	NSLK 8127	8127-478	9kHz ~ 30MHz	Jun. 22, 2012	Conduction (CO01-CB)
Impulsbegrenzer Pulse Limiter	Rohde&Schwarz	ESH3-Z2	100430	9kHz-30MHz	Feb. 21, 2013	Conduction (CO01-CB)
COND Cable	Woken	Cable	01	0.15MHz-30MHz	Dec. 04, 2012	Conduction (CO01-CB)
Software	Audix	E3	5.410e	-	-	Conduction (CO01-CB)
BILOG ANTENNA	Schaffner	CBL6112D	22021	20MHz ~ 2GHz	Apr. 16, 2013	Radiation (03CH01-CB)
Loop Antenna	Teseq	HLA 6120	24155	9 kHz - 30 MHz	Nov. 05, 2012*	Radiation (03CH01-CB)
Horn Antenna	EMCO	3115	00075790	750MHz-18GHz	Nov. 27, 2012	Radiation (03CH01-CB)
Horn Antenna	SCHWARZBEAK	BBHA 9170	BBHA9170252	15GHz ~ 40GHz	Nov. 23, 2012	Radiation (03CH01-CB)
Pre-Amplifier	Agilent	8447D	2944A10991	0.1MHz ~ 1.3GHz	Nov. 27, 2012	Radiation (03CH01-CB)
Pre-Amplifier	Agilent	8449B	3008A02310	1GHz ~ 26.5GHz	Nov. 23, 2012	Radiation (03CH01-CB)
Pre-Amplifier	WM	TF-130N-R1	923365	26.5GHz ~ 40GHz	Jul. 31, 2012	Radiation (03CH01-CB)
Spectrum analyzer	R&S	FSP40	100056	9KHz-40GHz	Nov. 16, 2012	Radiation (03CH01-CB)
EMI Test Receiver	R&S	ESCS 30	100355	9KHz ~ 2.75GHz	Apr. 15, 2013	Radiation (03CH01-CB)
Turn Table	INN CO	CO 2000	N/A	0 ~ 360 degree	N.C.R	Radiation (03CH01-CB)
Antenna Mast	INN CO	CO2000	N/A	1 m - 4 m	N.C.R	Radiation (03CH01-CB)
RF Cable-low	Woken	Low Cable-1	N/A	30 MHz - 1 GHz	Nov. 18, 2012	Radiation (03CH01-CB)
RF Cable-high	Woken	High Cable-1	N/A	1 GHz ~ 26.5 GHz	Nov. 18, 2012	Radiation (03CH01-CB)
RF Cable-high	Woken	High Cable-2	N/A	1 GHz ~ 26.5 GHz	Nov. 18, 2012	Radiation (03CH01-CB)
RF Cable-high	Woken	High Cable-3	N/A	1 GHz - 40 GHz	Nov. 18, 2012	Radiation (03CH01-CB)
RF Cable-high	Woken	High Cable-4	N/A	1 GHz - 40 GHz	Nov. 18, 2012	Radiation (03CH01-CB)
Signal analyzer	R&S	FSV40	100979	9KHz-40GHz	Oct. 08, 2012	Conducted (TH01-CB)
Temp. and Humidity Chamber	Ten Billion	TTH-D3SP	TBN-931011	-30~100 degree	Jun. 05, 2012	Conducted (TH01-CB)
RF Power Divider	Woken	3 Way	MDC2366	2GHz ~ 18GHz	Nov. 18, 2012	Conducted (TH01-CB)
RF Cable-high	Woken	High Cable-7	-	1 GHz ~ 26.5 GHz	Nov. 19, 2012	Conducted (TH01-CB)



Instrument	Manufacturer	Model No.	Serial No.	Characteristics	Calibration Date	Remark
RF Cable-high	Woken	High Cable-8	-	1 GHz – 26.5 GHz	Nov. 19, 2012	Conducted (TH01-CB)
RF Cable-high	Woken	High Cable-9	-	1 GHz – 26.5 GHz	Nov. 19, 2012	Conducted (TH01-CB)
RF Cable-high	Woken	High Cable-10	-	1 GHz – 26.5 GHz	Nov. 19, 2012	Conducted (TH01-CB)
RF Cable-high	Woken	High Cable-11	-	1 GHz – 26.5 GHz	Nov. 19, 2012	Conducted (TH01-CB)
Power Sensor	Anritsu	MA2411B	0917223	300MHz~40GHz	Nov. 28, 2012	Conducted (TH01-CB)
Power Meter	Anritsu	ML2495A	1035008	300MHz~40GHz	Nov. 27, 2012	Conducted (TH01-CB)

Note: Calibration Interval of instruments listed above is one year.

*** Calibration Interval of instruments listed above is two years.

N.C.R. means Non-Calibration required.

6. TEST LOCATION

SHIJR	ADD : 6Fl., No. 106, Sec. 1, Shintai 5th Rd., Shijr City, Taipei, Taiwan 221, R.O.C. TEL : 886-2-2696-2468 FAX : 886-2-2696-2255
HWA YA	ADD : No. 52, Hwa Ya 1st Rd., Kwei-Shan Hsiang, Tao Yuan Hsien, Taiwan, R.O.C. TEL : 886-3-327-3456 FAX : 886-3-318-0055
LINKOU	ADD : No. 30-2, Dingfu Tsuen, Linkou Shiang, Taipei, Taiwan 244, R.O.C TEL : 886-2-2601-1640 FAX : 886-2-2601-1695
DUNGHU	ADD : No. 3, Lane 238, Kangle St., Neihu Chiu, Taipei, Taiwan 114, R.O.C. TEL : 886-2-2631-4739 FAX : 886-2-2631-9740
JUNGHE	ADD : 7Fl., No. 758, Jungjeng Rd., Junghe City, Taipei, Taiwan 235, R.O.C. TEL : 886-2-8227-2020 FAX : 886-2-8227-2626
NEIHU	ADD : 4Fl., No. 339, Hsin Hu 2 nd Rd., Taipei 114, Taiwan, R.O.C. TEL : 886-2-2794-8886 FAX : 886-2-2794-9777
JHUBEI	ADD : No.8, Lane 724, Bo-ai St., Jhubei City, HsinChu County 302, Taiwan, R.O.C. TEL : 886-3-656-9065 FAX : 886-3-656-9085