

## FCC Test Report

**Report No.:** RF141008E07D-1

**FCC ID:** PY3DC112A

**Test Model:** DC112A

**Received Date:** Oct. 19, 2016

**Test Date:** Nov. 03 to 24, 2016

**Issued Date:** Dec. 02, 2016

**Applicant:** NETGEAR, Inc.

**Address:** 350 East Plumeria Drive San Jose, CA 95134

**Issued By:** Bureau Veritas Consumer Products Services (H.K.) Ltd., Taoyuan Branch  
Hsin Chu Laboratory

**Lab Address:** E-2, No.1, Li Hsin 1st Road, Hsinchu Science Park, Hsinchu City 300,  
Taiwan R.O.C.

**Test Location (1):** E-2, No.1, Li Hsin 1st Road, Hsinchu Science Park, Hsinchu City 300,  
Taiwan R.O.C.

**Test Location (2):** No. 49, Ln. 206, Wende Rd., Shangshan Tsuen, Chiung Lin Hsiang, Hsin  
Chu Hsien 307, Taiwan R.O.C.



This report is for your exclusive use. Any copying or replication of this report to or for any other person or entity, or use of our name or trademark, is permitted only with our prior written permission. This report sets forth our findings solely with respect to the test samples identified herein. The results set forth in this report are not indicative or representative of the quality or characteristics of the lot from which a test sample was taken or any similar or identical product unless specifically and expressly noted. Our report includes all of the tests requested by you and the results thereof based upon the information that you provided to us. You have 60 days from date of issuance of this report to notify us of any material error or omission caused by our negligence, provided, however, that such notice shall be in writing and shall specifically address the issue you wish to raise. A failure to raise such issue within the prescribed time shall constitute your unqualified acceptance of the completeness of this report, the tests conducted and the correctness of the report contents. Unless specific mention, the uncertainty of measurement has been explicitly taken into account to declare the compliance or non-compliance to the specification. The report must not be used by the client to claim product certification, approval, or endorsement by TAF or any government agencies.

## Table of Contents

<b>Release Control Record</b> .....	<b>4</b>
<b>1 Certificate of Conformity</b> .....	<b>5</b>
<b>2 Summary of Test Results</b> .....	<b>6</b>
2.1 Measurement Uncertainty .....	6
2.2 Modification Record .....	6
<b>3 General Information</b> .....	<b>7</b>
3.1 General Description of EUT .....	7
3.2 Description of Test Modes .....	9
3.2.1 Test Mode Applicability and Tested Channel Detail .....	11
3.3 Duty Cycle of Test Signal .....	13
3.4 Description of Support Units .....	14
3.4.1 Configuration of System under Test .....	15
3.5 General Description of Applied Standard .....	16
<b>4 Test Types and Results</b> .....	<b>17</b>
4.1 Radiated Emission and Bandedge Measurement .....	17
4.1.1 Limits of Radiated Emission and Bandedge Measurement .....	17
4.1.2 Test Instruments .....	18
4.1.3 Test Procedure .....	20
4.1.4 Deviation from Test Standard .....	20
4.1.5 Test Setup .....	21
4.1.6 EUT Operating Condition .....	23
4.1.7 Test Results .....	24
4.2 Conducted Emission Measurement .....	43
4.2.1 Limits of Conducted Emission Measurement .....	43
4.2.2 Test Instruments .....	43
4.2.3 Test Procedure .....	44
4.2.4 Deviation from Test Standard .....	44
4.2.5 Test Setup .....	44
4.2.6 EUT Operating Condition .....	44
4.2.7 Test Results (Mode 1) .....	45
4.2.8 Test Results (Mode 2) .....	47
4.3 Transmit Power Measurement .....	49
4.3.1 Limits of Transmit Power Measurement .....	49
4.3.2 Test Setup .....	50
4.3.3 Test Instruments .....	50
4.3.4 Test Procedure .....	50
4.3.5 Deviation from Test Standard .....	50
4.3.6 EUT Operating Condition .....	50
4.3.7 Test Result .....	51
4.4 Occupied Bandwidth Measurement .....	53
4.4.1 Test Setup .....	53
4.4.2 Test Instruments .....	53
4.4.3 Test Procedure .....	53
4.4.4 Test Results .....	54
4.5 Peak Power Spectral Density Measurement .....	59
4.5.1 Limits of Peak Power Spectral Density Measurement .....	59
4.5.2 Test Setup .....	59
4.5.3 Test Instruments .....	59
4.5.4 Test Procedure .....	60
4.5.5 Deviation from Test Standard .....	60
4.5.6 EUT Operating Condition .....	60
4.5.7 Test Results .....	61
4.6 Frequency Stability Measurement .....	67

4.6.1	Limits of Frequency Stability Measurement .....	67
4.6.2	Test Setup.....	67
4.6.3	Test Instruments .....	67
4.6.4	Test Procedure .....	67
4.6.5	Deviation from Test Standard .....	67
4.6.6	EUT Operating Condition .....	67
4.6.7	Test Results .....	68
4.7	6dB Bandwidth Measurement .....	69
4.7.1	Limits of 6dB Bandwidth Measurement.....	69
4.7.2	Test Setup.....	69
4.7.3	Test Instruments .....	69
4.7.4	Test Procedure .....	69
4.7.5	Deviation from Test Standard .....	69
4.7.6	EUT Operating Condition .....	69
4.7.7	Test Results .....	70
<b>5</b>	<b>Pictures of Test Arrangements.....</b>	<b>72</b>
	<b>Annex A- Radiated Out of Band Emission (OOBE) Measurement (For U-NII-3 band) .....</b>	<b>73</b>
	<b>Appendix – Information on the Testing Laboratories .....</b>	<b>76</b>

### Release Control Record

Issue No.	Description	Date Issued
RF141008E07D-1	Original release.	Dec. 02, 2016



## 2 Summary of Test Results

47 CFR FCC Part 15, Subpart E (Section 15.407)			
FCC Clause	Test Item	Result	Remarks
15.407(b)(6)	AC Power Conducted Emissions	Pass	Meet the requirement of limit. Minimum passing margin is -9.74 dB at 0.48594 MHz.
15.407(b) (1/2/3/4(i/ii)/6)	Radiated Emissions & Band Edge Measurement*	Pass	Meet the requirement of limit. Minimum passing margin is -0.1 dB at 5150.00MHz.
15.407(a)(1/2/3)	Max Average Transmit Power	Pass	Meet the requirement of limit.
---	Occupied Bandwidth Measurement	-	Reference only.
15.407(a)(1/2/3)	Peak Power Spectral Density	Pass	Meet the requirement of limit.
15.407(e)	6dB bandwidth	Pass	Meet the requirement of limit. (U-NII-3 Band only)
15.407(g)	Frequency Stability	Pass	Meet the requirement of limit.
15.203	Antenna Requirement	Pass	Antenna connector is R-SMA not a standard connector.

\*For U-NII-3 band compliance with rule part 15.407(b)(4)(i), the OOB test plots were recorded in Annex A.

### 2.1 Measurement Uncertainty

Where relevant, the following measurement uncertainty levels have been estimated for tests performed on the EUT as specified in CISPR 16-4-2:

Measurement	Frequency	Expanded Uncertainty (k=2) (±)
Conducted Emissions at mains ports	150kHz ~ 30MHz	1.83 dB
Radiated Emissions up to 1 GHz	30MHz ~ 1GHz	5.36 dB
Radiated Emissions above 1 GHz	1GHz ~ 6GHz	3.47 dB
	6GHz ~ 18GHz	3.75 dB
	18GHz ~ 40GHz	3.30 dB

### 2.2 Modification Record

There were no modifications required for compliance.

### 3 General Information

#### 3.1 General Description of EUT

Product	AirCard Smart Cradle
Brand	NETGEAR
Test Model	DC112A
Status of EUT	ENGINEERING SAMPLE
Power Supply Rating	DC 12V from power adapter
Modulation Type	CCK, DQPSK, DBPSK for DSSS 64QAM, 16QAM, QPSK, BPSK for OFDM 256QAM for OFDM in 11ac mode only
Modulation Technology	DSSS, OFDM
Transfer Rate	802.11b: up to 11Mbps 802.11a/g: up to 54Mbps 802.11n: up to 300Mbps 802.11ac: up to 866.7Mbps
Operating Frequency	<b>2.4GHz:</b> 2.412 ~ 2.462GHz <b>5GHz:</b> 5.18 ~ 5.24GHz and 5.745 ~ 5.825GHz
Number of Channel	<b>2.4GHz:</b> 802.11b, 802.11g, 802.11n (HT20): 11 802.11n (HT40): 7 <b>5GHz:</b> 802.11a, 802.11n (HT20), 802.11ac (VHT20): 9 802.11n (HT40), 802.11ac (VHT40): 4 802.11ac (VHT80): 2
Output Power	<b>2.4GHz:</b> 996.75mW <b>5GHz:</b> <b>5.18GHz ~ 5.24GHz:</b> <b>CDD Mode:</b> 457.13 mW <b>Beamforming Mode:</b> 498.389mW <b>5.745GHz ~ 5.825GHz:</b> <b>CDD Mode:</b> 786.257mW <b>Beamforming Mode:</b> 791.595mW
Antenna Type	Refer to Note
Antenna Connector	Refer to Note
Accessory Device	Adapter x 1
Data Cable Supplied	NA

**Note:**

1. Simultaneously transmission condition.

Condition	Technology	
1	WLAN (2.4GHz)	WLAN (5GHz)

**Note:** The emission of the simultaneous operation has been evaluated and no non-compliance was found.

2. The EUT must be supplied with a power adapter as following table:

Adapter	Brand	Model No.	Spec.	P/N
1	NETGEAR	2ABL030F 1 NA	Input: 100-120V, 1.0A, 50/60Hz Output: 12.0V, 2.5A DC output cable(1.8m, unshielded)	332-10758-01
2		AD2067F10	Input: 100-120V, 1.0A, 50/60Hz Output: 12.0V, 2.5mA DC output cable(1.8m, unshielded)	332-10797-01

From above adapters, the radiated emission worst case was found in **Adapter 2**. Therefore only the test data of the modes were recorded in this report individually.

3. The antennas provided to the EUT, please refer to the following table:

Antenna NO.	PCB Chain NO.	Brand	Model No.	Ant. Gain(dBi) <Excluding cable loss>	Frequency range (MHz to MHz)	Ant. Type	Connector Type	Cable Loss(dB)		
1	Chain 0	Master Wave	98619PRSX006	2.48	2400~2500	Dipole	R-SMA	1		
				2.96	5150~5850			1.9		
2	Chain 1	Master Wave	98619PRSX006	2.48	2400~2500			PCB	i-pex	0.7
				2.96	5150~5850					1.5
3	WWAN_chain_0	Master Wav	9 8P2RZIPF000	2.5	703~960	PCB	i-pex	NA		
				4.4	1700~ 2170					
				4.5	2300~ 2700					
4	WWAN_chain_1	Master Wav	9 8P2RZIPF000	2.5	703~960	PCB	i-pex	NA		
				4.4	1700~ 2170					
				4.5	2300~ 2700					



4. The EUT incorporates a MIMO function.

2.4GHz Band			
MODULATION MODE	DATA RATE (MCS)	TX & RX CONFIGURATION	
802.11b	1 ~ 11Mbps	1TX diversity	2RX
802.11g	6 ~ 54Mbps	2TX	2RX
802.11n (VHT20)	MCS 0~7	2TX	2RX
	MCS 8~15	2TX	2RX
802.11n (HT40)	MCS 0~7	2TX	2RX
	MCS 8~15	2TX	2RX
5GHz Band			
MODULATION MODE	DATA RATE (MCS)	TX & RX CONFIGURATION	
802.11a	6 ~ 54Mbps	2TX	2RX
802.11n (VHT20)	MCS 0~7	2TX	2RX
	MCS 8~15	2TX	2RX
802.11n (HT40)	MCS 0~7	2TX	2RX
	MCS 8~15	2TX	2RX
802.11ac (VHT20)	MCS0~8 Nss=1	2TX	2RX
	MCS0~8 Nss=2	2TX	2RX
802.11ac (VHT40)	MCS0~9 Nss=1	2TX	2RX
	MCS0~9 Nss=2	2TX	2RX
802.11ac (VHT80)	MCS0~9 Nss=1	2TX	2RX
	MCS0~9 Nss=2	2TX	2RX

Note:

1. All of modulation mode support beamforming function except 802.11a modulation mode and 2.4GHz band.
2. For 802.11b mode will select ant\_2 for the final test.
3. The modulation and bandwidth are similar for 802.11n mode for 20MHz (40MHz) and 802.11ac mode for 20MHz (40MHz), therefore investigated worst case to representative mode in test report. (Final test mode refer section 3.2.1)

5. The above EUT information is declared by manufacturer and for more detailed features description, please refer to the manufacturer's specifications or user's manual.

### 3.2 Description of Test Modes

#### FOR 5180 ~ 5240MHz

4 channels are provided for 802.11a, 802.11n (HT20), 802.11ac (VHT20):

Channel	Frequency	Channel	Frequency
36	5180 MHz	44	5220 MHz
40	5200 MHz	48	5240 MHz

2 channels are provided for 802.11n (HT40), 802.11ac (VHT40):

Channel	Frequency	Channel	Frequency
38	5190 MHz	46	5230 MHz

1 channel is provided for 802.11ac (VHT80):

Channel	Frequency
42	5210MHz

**FOR 5745 ~ 5825MHz:**

5 channels are provided for 802.11a, 802.11n (HT20), 802.11ac (VHT20):

Channel	Frequency	Channel	Frequency
149	5745MHz	161	5805MHz
153	5765MHz	165	5825MHz
157	5785MHz		

2 channels are provided for 802.11n (HT40), 802.11ac (VHT40):

Channel	Frequency	Channel	Frequency
151	5755MHz	159	5795MHz

1 channel is provided for 802.11ac (VHT80):

Channel	Frequency
155	5775MHz

### 3.2.1 Test Mode Applicability and Tested Channel Detail

EUT Configure Mode	Applicable To				Description
	RE $\geq$ 1G	RE<1G	PLC	APCM	
1	-	-	√	-	With adapter 1
2	√	√	√	-	With adapter 2

Where **RE $\geq$ 1G**: Radiated Emission above 1GHz      **RE<1G**: Radiated Emission below 1GHz  
**PLC**: Power Line Conducted Emission      **APCM**: Antenna Port Conducted Measurement

#### **Radiated Emission Test (Above 1GHz):**

- Pre-Scan has been conducted to determine the worst-case mode from all possible combinations between available modulations, data rates and antenna ports (if EUT with antenna diversity architecture).
- Following channel(s) was (were) selected for the final test as listed below.

CDD Mode						
Mode	FREQ. Band (MHz)	Available Channel	Tested Channel	Modulation Technology	Modulation Type	Data Rate (Mbps)
802.11a	5180-5240	36 to 48	36, 40, 48	OFDM	BPSK	6
802.11a	5745-5825	149 to 165	149, 157, 165	OFDM	BPSK	6
Beamforming Mode						
Mode	FREQ. Band (MHz)	Available Channel	Tested Channel	Modulation Technology	Modulation Type	Data Rate (Mbps)
802.11ac (VHT20)	5180-5240	36 to 48	36, 40, 48	OFDM	BPSK	6.5
802.11ac (VHT40)		38 to 46	38, 46	OFDM	BPSK	13.5
802.11ac (VHT80)		42	42	OFDM	BPSK	29.3
802.11ac (VHT20)	5745-5825	149 to 165	149, 157, 165	OFDM	BPSK	6.5
802.11ac (VHT40)		151 to 159	151, 159	OFDM	BPSK	13.5
802.11ac (VHT80)		155	155	OFDM	BPSK	29.3

#### **Radiated Emission Test (Below 1GHz):**

- Pre-Scan has been conducted to determine the worst-case mode from all possible combinations between available modulations, data rates and antenna ports (if EUT with antenna diversity architecture).
- Following channel(s) was (were) selected for the final test as listed below.

CDD Mode						
Mode	FREQ. Band (MHz)	Available Channel	Tested Channel	Modulation Technology	Modulation Type	Data Rate (Mbps)
802.11ac (VHT20)	5745-5825	149 to 165	157	OFDM	BPSK	6.5

### Power Line Conducted Emission Test:

- Pre-Scan has been conducted to determine the worst-case mode from all possible combinations between available modulations, data rates and antenna ports (if EUT with antenna diversity architecture).
- Following channel(s) was (were) selected for the final test as listed below.

CDD Mode						
Mode	FREQ. Band (MHz)	Available Channel	Tested Channel	Modulation Technology	Modulation Type	Data Rate (Mbps)
802.11ac (VHT20)	5745-5825	149 to 165	157	OFDM	BPSK	6.5

### Antenna Port Conducted Measurement:

- This item includes all test value of each mode, but only includes spectrum plot of worst value of each mode.
- Pre-Scan has been conducted to determine the worst-case mode from all possible combinations between available modulations, data rates and antenna ports (if EUT with antenna diversity architecture).
- Following channel(s) was (were) selected for the final test as listed below.

CDD Mode						
Mode	FREQ. Band (MHz)	Available Channel	Tested Channel	Modulation Technology	Modulation Type	Data Rate (Mbps)
802.11a	5180-5240	36 to 48	36, 40, 48	OFDM	BPSK	6
802.11a	5745-5825	149 to 165	149, 157, 165	OFDM	BPSK	6
Beamforming Mode						
Mode	FREQ. Band (MHz)	Available Channel	Tested Channel	Modulation Technology	Modulation Type	Data Rate (Mbps)
802.11ac (VHT20)	5180-5240	36 to 48	36, 40, 48	OFDM	BPSK	6.5
802.11ac (VHT40)		38 to 46	38, 46	OFDM	BPSK	13.5
802.11ac (VHT80)		42	42	OFDM	BPSK	29.3
802.11ac (VHT20)	5745-5825	149 to 165	149, 157, 165	OFDM	BPSK	6.5
802.11ac (VHT40)		151 to 159	151, 159	OFDM	BPSK	13.5
802.11ac (VHT80)		155	155	OFDM	BPSK	29.3

### Test Condition:

Applicable To	Environmental Conditions	Input Power	Tested By
RE $\geq$ 1G	22deg. C, 67%RH	120Vac, 60Hz	Robert Cheng
RE $<$ 1G	25deg. C, 63%RH	120Vac, 60Hz	Jyunchun Lin
PLC	25deg. C, 75%RH	120Vac, 60Hz	Andy Ho
APCM	25deg. C, 60%RH	120Vac, 60Hz	Gary Cheng

### 3.3 Duty Cycle of Test Signal

If duty cycle of test signal is  $\geq 98\%$ , duty factor is not required.

If duty cycle of test signal is  $< 98\%$ , duty factor shall be considered.

**802.11a:** Duty cycle =  $2.062/2.082 = 0.99$

**802.11ac (VHT20):** Duty cycle =  $1.925/1.948 = 0.988$

**802.11ac (VHT40):** Duty cycle =  $0.951/0.97 = 0.98$

**802.11ac (VHT80):** Duty cycle =  $0.46/0.478 = 0.962$ , Duty factor =  $10 * \log(1/0.962) = 0.17$

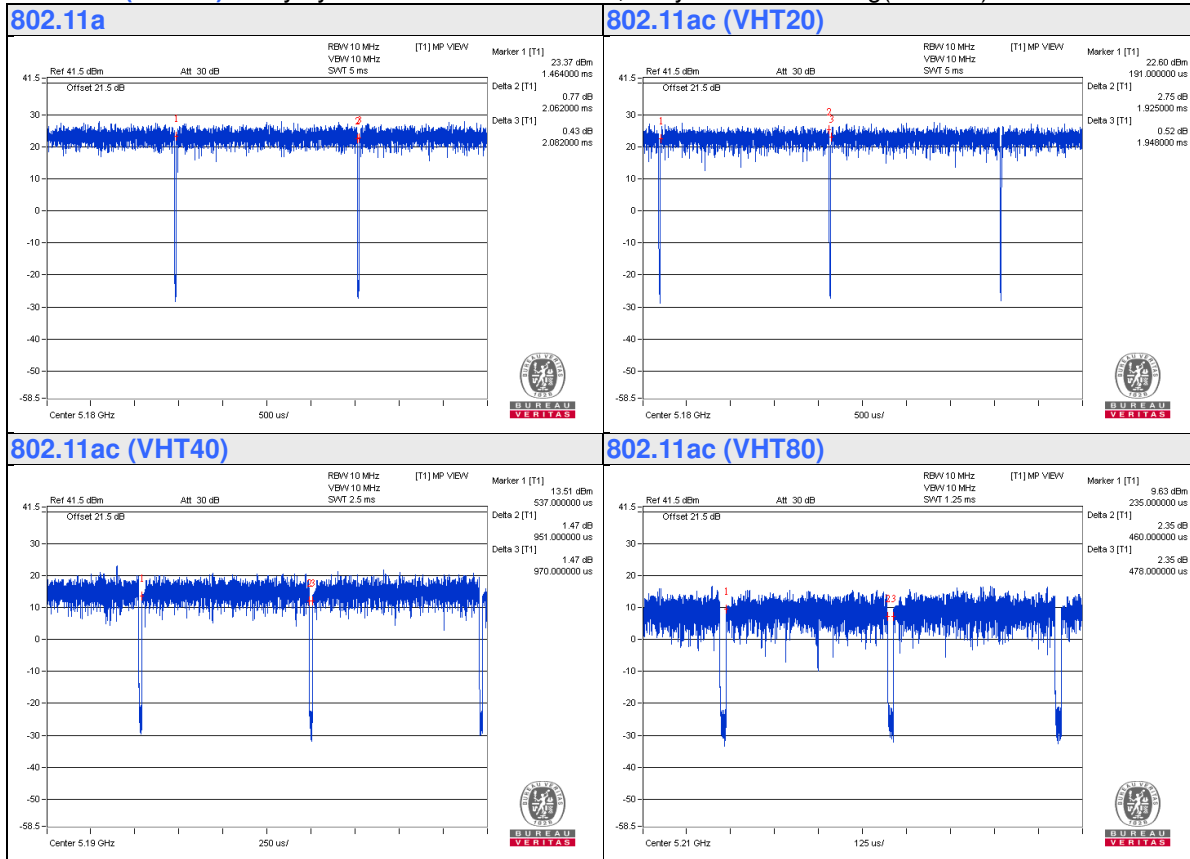

### 3.4 Description of Support Units

The EUT has been tested as an independent unit together with other necessary accessories or support units. The following support units or accessories were used to form a representative test configuration during the tests.

ID	Product	Brand	Model No.	Serial No.	FCC ID	Remarks
A.	Laptop	DELL Notebook	DELL	E5430	4YV4VY1	Provided by Lab
B.	Laptop	DELL Notebook	E5430	HYV4VY1	NA	Provided by Lab
C.	HUB	ZyXEL	ES-116P	S060H02000215	FCC DoC	Provided by Lab
D.	Dongole	Transcend	NA	NA	NA	Provided by Lab
E.	Mobile Hotspot	NETGEAR	Aircard 779S	NA	PY3AC779S	Supplied by client

Note:

1. All power cords of the above support units are non-shielded (1.8m).

ID	Descriptions	Qty.	Length (m)	Shielding (Yes/No)	Cores (Qty.)	Remarks
1.	RJ-45 Cable	1	10	No	0	Provided by Lab
2.	RJ-45 Cable	1	10	No	0	Provided by Lab
3.	RJ-45 Cable	3	10	No	0	Provided by Lab
4.	DC Cable	1	1.8	No	0	Supplied by client

### 3.4.1 Configuration of System under Test

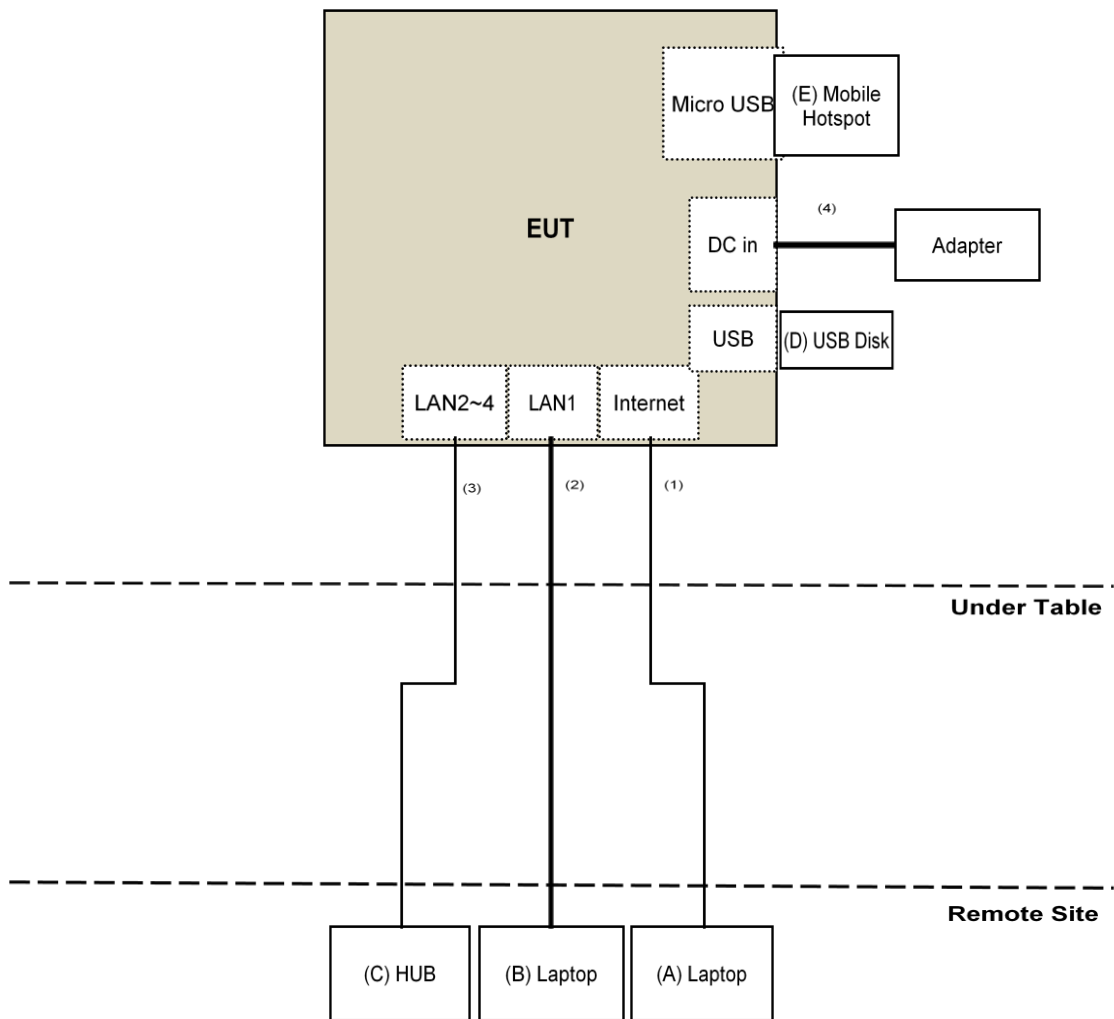

### 3.5 General Description of Applied Standard

The EUT is a RF Product. According to the specifications of the manufacturer, it must comply with the requirements of the following standards:

**FCC Part 15, Subpart E (15.407)**  
**KDB 789033 D02 General UNII Test Procedure New Rules v01r03**  
**KDB 662911 D01 Multiple Transmitter Output v02r01**  
**ANSI C63.10-2013**

All test items have been performed and recorded as per the above standards.



## 4 Test Types and Results

### 4.1 Radiated Emission and Bandedge Measurement

#### 4.1.1 Limits of Radiated Emission and Bandedge Measurement

Radiated emissions which fall in the restricted bands must comply with the radiated emission limits specified as below table.

Frequencies (MHz)	Field Strength (microvolts/meter)	Measurement Distance (meters)
0.009 ~ 0.490	2400/F(kHz)	300
0.490 ~ 1.705	24000/F(kHz)	30
1.705 ~ 30.0	30	30
30 ~ 88	100	3
88 ~ 216	150	3
216 ~ 960	200	3
Above 960	500	3

#### NOTE:

1. The lower limit shall apply at the transition frequencies.
2. Emission level (dBuV/m) = 20 log Emission level (uV/m).
3. For frequencies above 1000MHz, the field strength limits are based on average detector, however, the peak field strength of any emission shall not exceed the maximum permitted average limits, specified above by more than 20dB under any condition of modulation.

Limits of unwanted emission out of the restricted bands

Applicable To		Limit	
789033 D02 General UNII Test Procedure New Rules v01r03		Field Strength at 3m	
		PK:74 (dBμV/m)	AV:54 (dBμV/m)
Frequency Band	Applicable To	EIRP Limit	Equivalent Field Strength at 3m
5150~5250 MHz	15.407(b)(1)	PK:-27 (dBm/MHz)	PK:68.2(dBμV/m)
5250~5350 MHz	15.407(b)(2)		
5470~5725 MHz	15.407(b)(3)		
5725~5850 MHz	<input checked="" type="checkbox"/> 15.407(b)(4)(i)	PK:-27 (dBm/MHz) <sup>*1</sup> PK:10 (dBm/MHz) <sup>*2</sup> PK:15.6 (dBm/MHz) <sup>*3</sup> PK:27 (dBm/MHz) <sup>*4</sup>	PK: 68.2(dBμV/m) <sup>*1</sup> PK:105.2 (dBμV/m) <sup>*2</sup> PK: 110.8(dBμV/m) <sup>*3</sup> PK:122.2 (dBμV/m) <sup>*4</sup>
	<input type="checkbox"/> 15.407(b)(4)(ii)	Emission limits in section 15.247(d)	
<sup>*1</sup> beyond 75 MHz or more above of the band edge.		<sup>*2</sup> below the band edge increasing linearly to 10 dBm/MHz at 25 MHz above.	
<sup>*3</sup> below the band edge increasing linearly to a level of 15.6 dBm/MHz at 5 MHz above.		<sup>*4</sup> from 5 MHz above or below the band edge increasing linearly to a level of 27 dBm/MHz at the band edge.	

#### Note:

The following formula is used to convert the equipment isotropic radiated power (eirp) to field strength:

$$E = \frac{1000000\sqrt{30P}}{3} \mu\text{V/m, where } P \text{ is the eirp (Watts).}$$

## 4.1.2 Test Instruments

DESCRIPTION & MANUFACTURER	MODEL NO.	SERIAL NO.	CALIBRATED DATE	CALIBRATED UNTIL
Test Receiver Agilent	N9038A	MY50010156	Aug. 18, 2016	Aug. 17, 2017
Pre-Amplifier <sup>(*)</sup> EMCI	EMC001340	980142	Jan. 20, 2016	Jan. 19, 2018
Loop Antenna <sup>(*)</sup> Electro-Metrics	EM-6879	264	Dec. 16, 2014	Dec. 15, 2016
RF Cable	NA	LOOPCAB-001 LOOPCAB-002	Jan. 18, 2016	Jan. 17, 2017
Pre-Amplifier Mini-Circuits	ZFL-1000VH2B	AMP-ZFL-05	May 07, 2016	May 06, 2017
Trilog Broadband Antenna SCHWARZBECK	VULB 9168	9168-156	Jan. 04, 2016	Jan. 03, 2017
RF Cable	8D	966-3-1 966-3-2 966-3-3	Apr. 02, 2016	Apr. 01, 2017
Fixed attenuator Mini-Circuits	UNAT-5+	PAD-3m-3-01	Oct. 05, 2016	Oct. 04, 2017
Horn Antenna SCHWARZBECK	BBHA9120-D	9120D-406	Jan. 20, 2016	Jan. 19, 2017
Pre-Amplifier Agilent	8449B	3008A02465	Apr. 05, 2016	Apr. 04, 2017
RF Cable	EMC104-SM-SM-2000 EMC104-SM-SM-5000 EMC104-SM-SM-5000	150317 150321 150322	Mar. 30, 2016	Mar. 29, 2017
Spectrum Analyzer Keysight	N9030A	MY54490520	July 29, 2016	July 28, 2017
Pre-Amplifier EMCI	EMC184045	980143	Jan. 15, 2016	Jan. 14, 2017
Horn Antenna SCHWARZBECK	BBHA 9170	BBHA9170608	Jan. 08, 2016	Jan. 07, 2017
RF Cable	SUCOFLEX 102	36432/2 36441/2	Jan. 16, 2016	Jan. 15, 2017
Software	ADT_Radiated_V8.7.08	NA	NA	NA
Antenna Tower & Turn Table Max-Full	MF-7802	MF780208406	NA	NA
Boresight Antenna Fixture	FBA-01	FBA-SIP01	NA	NA
Spectrum Analyzer R&S	FSv40	100964	June 28, 2016	June 27, 2017
Power meter Anritsu	ML2495A	1014008	May 5, 2016	May 4, 2017
Power sensor Anritsu	MA2411B	0917122	May 5, 2016	May 4, 2017
AC Power Source Extech Electronics	6205	1440452	NA	NA
Temperature & Humidity Chamber Giant Force	GTH-150-40-SP-AR	MAA0812-008	Jan. 15, 2016	Jan. 14, 2017
Digital Multimeter FLUKE	87III	73680266	Nov. 10, 2016	Nov. 09, 2017

**Note:**

1. The calibration interval of the above test instruments is 12 months and the calibrations are traceable to NML/ROC and NIST/USA.
2. \*The calibration interval of the above test instruments is 24 months and the calibrations are traceable to NML/ROC and NIST/USA.
3. The test was performed in 966 Chamber No. 3.
4. The FCC Site Registration No. is 147459
- 5 Loop antenna was used for all emissions below 30 MHz.
6. The CANADA Site Registration No. is 20331-1
8. Tested Date: Nov. 22, 2016

#### 4.1.3 Test Procedure

##### **For Radiated emission below 30MHz**

- a. The EUT was placed on the top of a rotating table 0.8 meters above the ground at a 3 meter chamber room. The table was rotated 360 degrees to determine the position of the highest radiation.
- b. The EUT was set 3 meters away from the interference-receiving antenna, which was mounted on the top of a variable-height antenna tower.
- c. Both X and Y axes of the antenna are set to make the measurement.
- d. For each suspected emission, the EUT was arranged to its worst case and the rotatable table was turned from 0 degrees to 360 degrees to find the maximum reading.
- e. The test-receiver system was set to Quasi-Peak Detect Function and Specified Bandwidth with Maximum Hold Mode.

##### **NOTE:**

1. The resolution bandwidth and video bandwidth of test receiver/spectrum analyzer is 9kHz at frequency below 30MHz.

##### **For Radiated emission above 30MHz**

- a. The EUT was placed on the top of a rotating table 0.8 meters (for 30MHz ~ 1GHz) / 1.5 meters (for above 1GHz) above the ground at 3 meter chamber room for test. The table was rotated 360 degrees to determine the position of the highest radiation.
- b. The EUT was set 3 meters away from the interference-receiving antenna, which was mounted on the top of a variable-height antenna tower.
- c. The height of antenna is varied from one meter to four meters above the ground to determine the maximum value of the field strength. Both horizontal and vertical polarizations of the antenna are set to make the measurement.
- d. For each suspected emission, the EUT was arranged to its worst case and then the antenna was tuned to heights from 1 meter to 4 meters and the rotatable table was turned from 0 degrees to 360 degrees to find the maximum reading.
- e. The test-receiver system was set to quasi-peak detect function and specified bandwidth with maximum hold mode when the test frequency is below 1 GHz.
- f. The test-receiver system was set to peak and average detect function and specified bandwidth with maximum hold mode when the test frequency is above 1 GHz. If the peak reading value also meets average limit, measurement with the average detector is unnecessary.

##### **Note:**

1. The resolution bandwidth and video bandwidth of test receiver/spectrum analyzer is 120kHz for Quasi-peak detection (QP) at frequency below 1GHz.
2. The resolution bandwidth of test receiver/spectrum analyzer is 1 MHz and the video bandwidth is 3 MHz for Peak detection (PK) at frequency above 1GHz.
3. The resolution bandwidth of test receiver/spectrum analyzer is 1MHz and the video bandwidth is  $\geq 1/T$  (Duty cycle < 98%) or 10Hz (Duty cycle  $\geq 98\%$ ) for Average detection (AV) at frequency above 1GHz.
4. All modes of operation were investigated and the worst-case emissions are reported.

#### 4.1.4 Deviation from Test Standard

No deviation.

#### 4.1.5 Test Setup

##### For Radiated emission below 30MHz

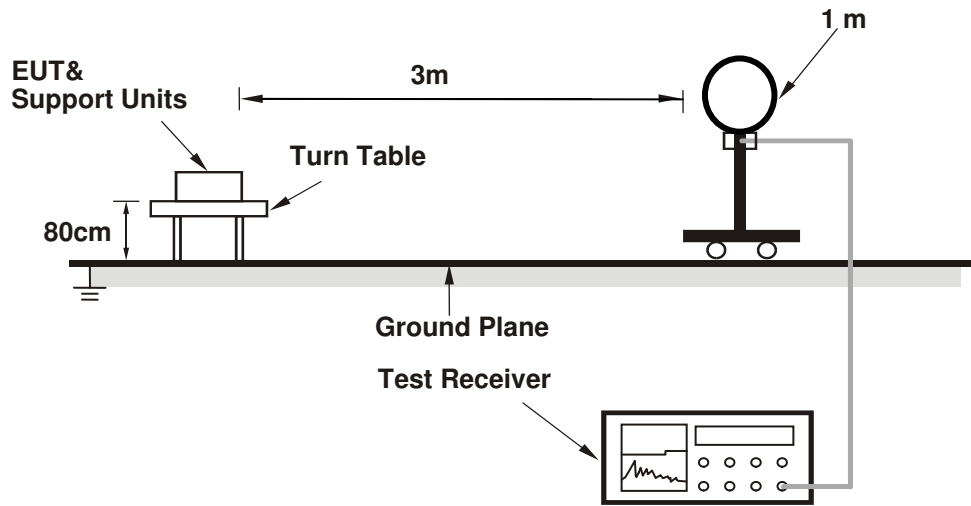

##### For Radiated emission 30MHz to 1GHz

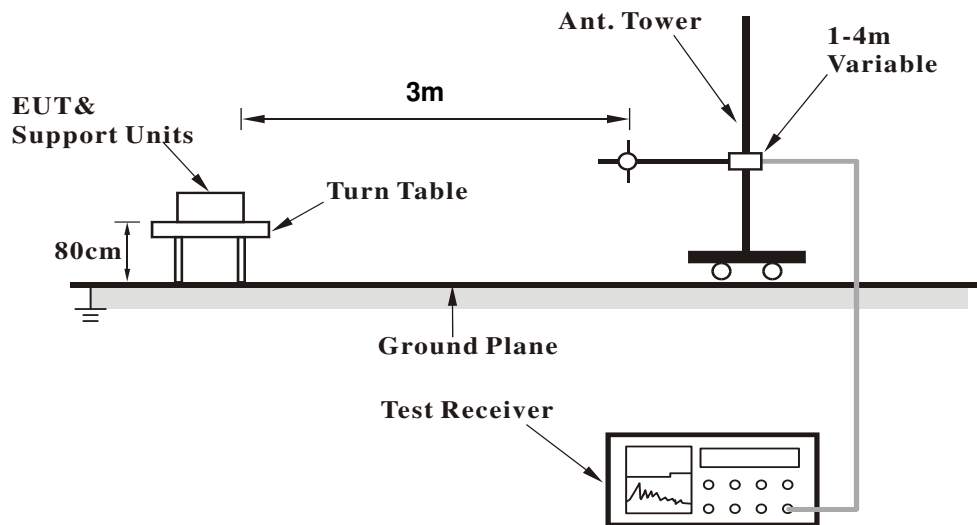

### For Radiated emission above 1GHz

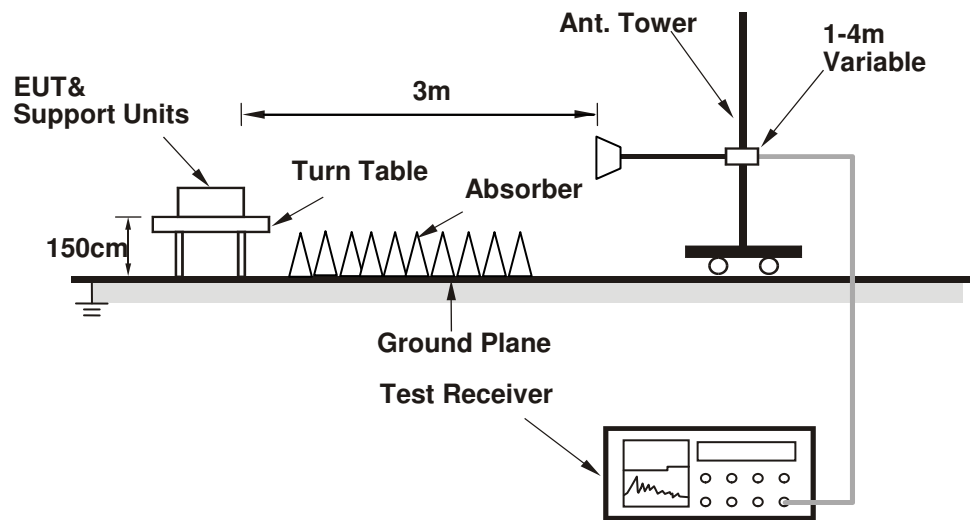

For the actual test configuration, please refer to the attached file (Test Setup Photo).

#### 4.1.6 EUT Operating Condition

- a. Connected the EUT with the laptop which is placed on remote site.
- b. Contorlling software (Mtool 2.0.1.0.exe) has been activated to set the EUT on specific status.

4.1.7 Test Results

Above 1GHz Data:

802.11a

<b>CHANNEL</b>	TX Channel 36	<b>DETECTOR FUNCTION</b>	Peak (PK)
<b>FREQUENCY RANGE</b>	1GHz ~ 40GHz		Average (AV)

**ANTENNA POLARITY & TEST DISTANCE: HORIZONTAL AT 3 M**

NO.	FREQ. (MHz)	EMISSION LEVEL (dBuV/m)	LIMIT (dBuV/m)	MARGIN (dB)	ANTENNA HEIGHT (m)	TABLE ANGLE (Degree)	RAW VALUE (dBuV)	CORRECTION FACTOR (dB/m)
1	5102.00	53.2 PK	74.0	-20.8	1.34 H	145	50.4	2.8
2	5102.00	43.3 AV	54.0	-10.7	1.34 H	145	40.5	2.8
3	5150.00	62.5 PK	74.0	-11.5	1.34 H	145	59.5	3.0
4	5150.00	43.7 AV	54.0	-10.3	1.34 H	145	40.7	3.0
5	*5180.00	108.3 PK			1.34 H	145	105.2	3.1
6	*5180.00	99.2 AV			1.34 H	145	96.1	3.1
7	5396.00	53.2 PK	74.0	-20.8	1.34 H	145	49.5	3.7
8	5396.00	40.3 AV	54.0	-13.7	1.34 H	145	36.6	3.7
9	#10360.00	61.1 PK	74.0	-12.9	2.01 H	274	47.5	13.6
10	#10360.00	48.1 AV	54.0	-5.9	2.01 H	274	34.5	13.6
11	15540.00	63.1 PK	74.0	-10.9	2.02 H	344	47.4	15.7
12	15540.00	46.2 AV	54.0	-7.8	2.02 H	344	30.5	15.7

**ANTENNA POLARITY & TEST DISTANCE: VERTICAL AT 3 M**

NO.	FREQ. (MHz)	EMISSION LEVEL (dBuV/m)	LIMIT (dBuV/m)	MARGIN (dB)	ANTENNA HEIGHT (m)	TABLE ANGLE (Degree)	RAW VALUE (dBuV)	CORRECTION FACTOR (dB/m)
1	5102.00	63.0 PK	74.0	-11.0	1.50 V	72	60.2	2.8
2	5102.00	51.2 AV	54.0	-2.8	1.50 V	72	48.4	2.8
3	5150.00	73.4 PK	74.0	-0.6	1.50 V	72	70.4	3.0
4	5150.00	53.7 AV	54.0	-0.3	1.50 V	72	50.7	3.0
5	*5180.00	119.5 PK			1.77 V	80	116.4	3.1
6	*5180.00	109.0 AV			1.77 V	80	105.9	3.1
7	5396.00	59.5 PK	74.0	-14.5	1.50 V	72	55.8	3.7
8	5396.00	51.8 AV	54.0	-2.2	1.50 V	72	48.1	3.7
9	#10360.00	63.8 PK	74.0	-10.2	2.28 V	185	50.2	13.6
10	#10360.00	50.3 AV	54.0	-3.7	2.28 V	185	36.7	13.6
11	15540.00	65.2 PK	74.0	-8.8	2.55 V	316	49.5	15.7
12	15540.00	48.9 AV	54.0	-5.1	2.55 V	316	33.2	15.7

**REMARKS:**

1. Emission Level(dBuV/m) = Raw Value(dBuV) + Correction Factor(dB/m)
2. Correction Factor(dB/m) = Antenna Factor(dB/m) + Cable Factor(dB) – Pre-Amplifier Factor(dB)
3. The other emission levels were very low against the limit.
4. Margin value = Emission Level – Limit value
5. " \* ": Fundamental frequency.
6. " # ": The radiated frequency is out of the restricted band.



<b>CHANNEL</b>	TX Channel 40	<b>DETECTOR FUNCTION</b>	Peak (PK)
<b>FREQUENCY RANGE</b>	1GHz ~ 40GHz		Average (AV)

**ANTENNA POLARITY & TEST DISTANCE: HORIZONTAL AT 3 M**

NO.	FREQ. (MHz)	EMISSION LEVEL (dBuV/m)	LIMIT (dBuV/m)	MARGIN (dB)	ANTENNA HEIGHT (m)	TABLE ANGLE (Degree)	RAW VALUE (dBuV)	CORRECTION FACTOR (dB/m)
1	5118.00	62.3 PK	74.0	-11.7	1.30 H	143	59.4	2.9
2	5118.00	43.8 AV	54.0	-10.2	1.30 H	143	40.9	2.9
3	*5200.00	110.7 PK			1.30 H	143	107.6	3.1
4	*5200.00	101.4 AV			1.30 H	143	98.3	3.1
5	#10400.00	63.7 PK	74.0	-10.3	1.96 H	262	50.1	13.6
6	#10400.00	50.6 AV	54.0	-3.4	1.96 H	262	37.0	13.6
7	15600.00	67.0 PK	74.0	-7.0	1.98 H	333	51.3	15.7
8	15600.00	51.1 AV	54.0	-2.9	1.98 H	333	35.4	15.7

**ANTENNA POLARITY & TEST DISTANCE: VERTICAL AT 3 M**

NO.	FREQ. (MHz)	EMISSION LEVEL (dBuV/m)	LIMIT (dBuV/m)	MARGIN (dB)	ANTENNA HEIGHT (m)	TABLE ANGLE (Degree)	RAW VALUE (dBuV)	CORRECTION FACTOR (dB/m)
1	5118.00	65.8 PK	74.0	-8.2	1.81 V	80	62.9	2.9
2	5118.00	53.0 AV	54.0	-1.0	1.81 V	80	50.1	2.9
3	*5200.00	121.4 PK			1.81 V	80	118.3	3.1
4	*5200.00	110.7 AV			1.81 V	80	107.6	3.1
5	#10400.00	67.0 PK	74.0	-7.0	2.22 V	203	53.4	13.6
6	#10400.00	53.2 AV	54.0	-0.8	2.22 V	203	39.6	13.6
7	15600.00	69.2 PK	74.0	-4.8	2.43 V	334	53.5	15.7
8	15600.00	53.9 AV	54.0	-0.1	2.43 V	334	38.2	15.7

**REMARKS:**

1. Emission Level(dBuV/m) = Raw Value(dBuV) + Correction Factor(dB/m)
2. Correction Factor(dB/m) = Antenna Factor(dB/m) + Cable Factor(dB) – Pre-Amplifier Factor(dB)
3. The other emission levels were very low against the limit.
4. Margin value = Emission Level – Limit value
5. " \* ": Fundamental frequency.
6. " # ": The radiated frequency is out of the restricted band.

<b>CHANNEL</b>	TX Channel 48	<b>DETECTOR FUNCTION</b>	Peak (PK)
<b>FREQUENCY RANGE</b>	1GHz ~ 40GHz		Average (AV)

**ANTENNA POLARITY & TEST DISTANCE: HORIZONTAL AT 3 M**

NO.	FREQ. (MHz)	EMISSION LEVEL (dBuV/m)	LIMIT (dBuV/m)	MARGIN (dB)	ANTENNA HEIGHT (m)	TABLE ANGLE (Degree)	RAW VALUE (dBuV)	CORRECTION FACTOR (dB/m)
1	*5240.00	108.2 PK			1.27 H	131	105.0	3.2
2	*5240.00	99.1 AV			1.27 H	131	95.9	3.2
3	5460.00	62.1 PK	74.0	-11.9	1.27 H	131	58.4	3.7
4	5460.00	43.3 AV	54.0	-10.7	1.27 H	131	39.6	3.7
5	#10480.00	63.7 PK	74.0	-10.3	1.94 H	263	49.7	14.0
6	#10480.00	50.6 AV	54.0	-3.4	1.94 H	263	36.6	14.0
7	15720.00	66.9 PK	74.0	-7.1	1.96 H	329	51.5	15.4
8	15720.00	50.7 AV	54.0	-3.3	1.96 H	329	35.3	15.4

**ANTENNA POLARITY & TEST DISTANCE: VERTICAL AT 3 M**

NO.	FREQ. (MHz)	EMISSION LEVEL (dBuV/m)	LIMIT (dBuV/m)	MARGIN (dB)	ANTENNA HEIGHT (m)	TABLE ANGLE (Degree)	RAW VALUE (dBuV)	CORRECTION FACTOR (dB/m)
1	*5240.00	120.3 PK			1.70 V	77	117.1	3.2
2	*5240.00	109.4 AV			1.70 V	77	106.2	3.2
3	5460.00	63.0 PK	74.0	-11.0	1.70 V	67	59.3	3.7
4	5460.00	51.3 AV	54.0	-2.7	1.70 V	67	47.6	3.7
5	#10480.00	66.0 PK	74.0	-8.0	2.20 V	204	52.0	14.0
6	#10480.00	52.0 AV	54.0	-2.0	2.20 V	204	38.0	14.0
7	15720.00	68.2 PK	74.0	-5.8	2.45 V	327	52.8	15.4
8	15720.00	53.5 AV	54.0	-0.5	2.45 V	327	38.1	15.4

**REMARKS:**

1. Emission Level(dBuV/m) = Raw Value(dBuV) + Correction Factor(dB/m)
2. Correction Factor(dB/m) = Antenna Factor(dB/m) + Cable Factor(dB) – Pre-Amplifier Factor(dB)
3. The other emission levels were very low against the limit.
4. Margin value = Emission Level – Limit value
5. " \* ": Fundamental frequency.
6. " # ": The radiated frequency is out of the restricted band.

<b>CHANNEL</b>	TX Channel 149	<b>DETECTOR FUNCTION</b>	Peak (PK)
<b>FREQUENCY RANGE</b>	1GHz ~ 40GHz		Average (AV)

**ANTENNA POLARITY & TEST DISTANCE: HORIZONTAL AT 3 M**

NO.	FREQ. (MHz)	EMISSION LEVEL (dBuV/m)	LIMIT (dBuV/m)	MARGIN (dB)	ANTENNA HEIGHT (m)	TABLE ANGLE (Degree)	RAW VALUE (dBuV)	CORRECTION FACTOR (dB/m)
1	#5622.91	56.3 PK	68.2	-11.9	1.30 H	130	52.3	4.0
2	*5745.00	111.5 PK			1.30 H	130	107.3	4.2
3	*5745.00	101.2 AV			1.30 H	130	97.0	4.2
4	#5980.01	56.6 PK	68.2	-11.6	1.30 H	130	52.1	4.5
5	11490.00	61.1 PK	74.0	-12.9	2.06 H	279	45.9	15.2
6	11490.00	48.4 AV	54.0	-5.6	2.06 H	279	33.2	15.2
7	#17235.00	63.1 PK	74.0	-10.9	2.02 H	337	43.1	20.0
8	#17235.00	46.2 AV	54.0	-7.8	2.02 H	337	26.2	20.0

**ANTENNA POLARITY & TEST DISTANCE: VERTICAL AT 3 M**

NO.	FREQ. (MHz)	EMISSION LEVEL (dBuV/m)	LIMIT (dBuV/m)	MARGIN (dB)	ANTENNA HEIGHT (m)	TABLE ANGLE (Degree)	RAW VALUE (dBuV)	CORRECTION FACTOR (dB/m)
1	#5661.62	69.7 PK	76.8	-7.1	1.77 V	71	65.7	4.0
2	*5745.00	122.0 PK			1.77 V	71	117.8	4.2
3	*5745.00	111.5 AV			1.77 V	71	107.3	4.2
4	#5987.48	61.4 PK	68.2	-6.8	1.77 V	71	56.9	4.5
5	11490.00	65.3 PK	74.0	-8.7	2.10 V	326	50.1	15.2
6	11490.00	51.6 AV	54.0	-2.4	2.10 V	326	36.4	15.2
7	#17235.00	65.5 PK	74.0	-8.5	2.56 V	26	45.5	20.0
8	#17235.00	50.3 AV	54.0	-3.7	2.56 V	26	30.3	20.0

**REMARKS:**

1. Emission Level(dBuV/m) = Raw Value(dBuV) + Correction Factor(dB/m)
2. Correction Factor(dB/m) = Antenna Factor(dB/m) + Cable Factor(dB) – Pre-Amplifier Factor(dB)
3. The other emission levels were very low against the limit.
4. Margin value = Emission Level – Limit value
5. " \* ": Fundamental frequency.
6. " # ": The radiated frequency is out of the restricted band.

<b>CHANNEL</b>	TX Channel 157	<b>DETECTOR FUNCTION</b>	Peak (PK)
<b>FREQUENCY RANGE</b>	1GHz ~ 40GHz		Average (AV)

**ANTENNA POLARITY & TEST DISTANCE: HORIZONTAL AT 3 M**

NO.	FREQ. (MHz)	EMISSION LEVEL (dBuV/m)	LIMIT (dBuV/m)	MARGIN (dB)	ANTENNA HEIGHT (m)	TABLE ANGLE (Degree)	RAW VALUE (dBuV)	CORRECTION FACTOR (dB/m)
1	#5608.95	56.5 PK	68.2	-11.7	1.38 H	131	52.6	3.9
2	*5785.00	110.2 PK			1.38 H	131	106.1	4.1
3	*5785.00	100.0 AV			1.38 H	131	95.9	4.1
4	#5959.90	56.8 PK	68.2	-11.4	1.38 H	131	52.3	4.5
5	11570.00	61.6 PK	74.0	-12.4	2.00 H	278	46.5	15.1
6	11570.00	48.8 AV	54.0	-5.2	2.00 H	278	33.7	15.1
7	#17355.00	63.5 PK	74.0	-10.5	1.97 H	340	43.0	20.5
8	#17355.00	46.6 AV	54.0	-7.4	1.97 H	340	26.1	20.5

**ANTENNA POLARITY & TEST DISTANCE: VERTICAL AT 3 M**

NO.	FREQ. (MHz)	EMISSION LEVEL (dBuV/m)	LIMIT (dBuV/m)	MARGIN (dB)	ANTENNA HEIGHT (m)	TABLE ANGLE (Degree)	RAW VALUE (dBuV)	CORRECTION FACTOR (dB/m)
1	#5626.95	62.0 PK	68.2	-6.2	1.77 V	71	58.0	4.0
2	*5785.00	121.2 PK			1.77 V	71	117.1	4.1
3	*5785.00	111.0 AV			1.77 V	71	106.9	4.1
4	#5946.62	64.1 PK	68.2	-4.1	1.77 V	71	59.7	4.4
5	11570.00	64.4 PK	74.0	-9.6	2.15 V	334	49.3	15.1
6	11570.00	51.0 AV	54.0	-3.0	2.15 V	334	35.9	15.1
7	#17355.00	65.1 PK	74.0	-8.9	2.68 V	13	44.6	20.5
8	#17355.00	50.1 AV	54.0	-3.9	2.68 V	13	29.6	20.5

**REMARKS:**

1. Emission Level(dBuV/m) = Raw Value(dBuV) + Correction Factor(dB/m)
2. Correction Factor(dB/m) = Antenna Factor(dB/m) + Cable Factor(dB) – Pre-Amplifier Factor(dB)
3. The other emission levels were very low against the limit.
4. Margin value = Emission Level – Limit value
5. " \* ": Fundamental frequency.
6. " # ": The radiated frequency is out of the restricted band.

<b>CHANNEL</b>	TX Channel 165	<b>DETECTOR FUNCTION</b>	Peak (PK)
<b>FREQUENCY RANGE</b>	1GHz ~ 40GHz		Average (AV)

**ANTENNA POLARITY & TEST DISTANCE: HORIZONTAL AT 3 M**

NO.	FREQ. (MHz)	EMISSION LEVEL (dBuV/m)	LIMIT (dBuV/m)	MARGIN (dB)	ANTENNA HEIGHT (m)	TABLE ANGLE (Degree)	RAW VALUE (dBuV)	CORRECTION FACTOR (dB/m)
1	#5564.27	55.8 PK	68.2	-12.4	1.43 H	131	51.9	3.9
2	*5825.00	109.0 PK			1.43 H	131	104.8	4.2
3	*5825.00	98.8 AV			1.43 H	131	94.6	4.2
4	#5965.39	56.7 PK	68.2	-11.5	1.43 H	131	52.2	4.5
5	11650.00	61.8 PK	74.0	-12.2	2.11 H	263	46.8	15.0
6	11650.00	48.8 AV	54.0	-5.2	2.11 H	263	33.8	15.0
7	#17475.00	62.5 PK	74.0	-11.5	2.07 H	342	41.4	21.1
8	#17475.00	45.7 AV	54.0	-8.3	2.07 H	342	24.6	21.1

**ANTENNA POLARITY & TEST DISTANCE: VERTICAL AT 3 M**

NO.	FREQ. (MHz)	EMISSION LEVEL (dBuV/m)	LIMIT (dBuV/m)	MARGIN (dB)	ANTENNA HEIGHT (m)	TABLE ANGLE (Degree)	RAW VALUE (dBuV)	CORRECTION FACTOR (dB/m)
1	#5581.35	61.4 PK	68.2	-6.8	1.77 V	66	57.5	3.9
2	*5825.00	121.3 PK			1.77 V	66	117.1	4.2
3	*5825.00	111.0 AV			1.77 V	66	106.8	4.2
4	#5985.57	63.4 PK	68.2	-4.8	1.77 V	66	58.9	4.5
5	11650.00	62.3 PK	74.0	-11.7	2.10 V	318	47.3	15.0
6	11650.00	48.8 AV	54.0	-5.2	2.10 V	318	33.8	15.0
7	#17475.00	61.9 PK	74.0	-12.1	2.57 V	23	40.8	21.1
8	#17475.00	48.5 AV	54.0	-5.5	2.57 V	23	27.4	21.1

**REMARKS:**

1. Emission Level(dBuV/m) = Raw Value(dBuV) + Correction Factor(dB/m)
2. Correction Factor(dB/m) = Antenna Factor(dB/m) + Cable Factor(dB) – Pre-Amplifier Factor(dB)
3. The other emission levels were very low against the limit.
4. Margin value = Emission Level – Limit value
5. " \* ": Fundamental frequency.
6. " # ": The radiated frequency is out of the restricted band.

**802.11ac (VHT20)**

<b>CHANNEL</b>	TX Channel 36	<b>DETECTOR FUNCTION</b>	Peak (PK)
<b>FREQUENCY RANGE</b>	1GHz ~ 40GHz		Average (AV)

**ANTENNA POLARITY & TEST DISTANCE: HORIZONTAL AT 3 M**

NO.	FREQ. (MHz)	EMISSION LEVEL (dBuV/m)	LIMIT (dBuV/m)	MARGIN (dB)	ANTENNA HEIGHT (m)	TABLE ANGLE (Degree)	RAW VALUE (dBuV)	CORRECTION FACTOR (dB/m)
1	5101.00	53.4 PK	74.0	-20.6	1.32 H	158	50.6	2.8
2	5101.00	43.6 AV	54.0	-10.4	1.32 H	158	40.8	2.8
3	5150.00	63.0 PK	74.0	-11.0	1.32 H	158	60.0	3.0
4	5150.00	44.2 AV	54.0	-9.8	1.32 H	158	41.2	3.0
5	*5180.00	108.3 PK			1.32 H	158	105.2	3.1
6	*5180.00	97.6 AV			1.32 H	158	94.5	3.1
7	#10360.00	61.2 PK	74.0	-12.8	1.97 H	265	47.6	13.6
8	#10360.00	48.5 AV	54.0	-5.5	1.97 H	265	34.9	13.6
9	15540.00	62.9 PK	74.0	-11.1	1.91 H	308	47.2	15.7
10	15540.00	45.9 AV	54.0	-8.1	1.91 H	308	30.2	15.7

**ANTENNA POLARITY & TEST DISTANCE: VERTICAL AT 3 M**

NO.	FREQ. (MHz)	EMISSION LEVEL (dBuV/m)	LIMIT (dBuV/m)	MARGIN (dB)	ANTENNA HEIGHT (m)	TABLE ANGLE (Degree)	RAW VALUE (dBuV)	CORRECTION FACTOR (dB/m)
1	5101.00	62.4 PK	74.0	-11.6	1.77 V	78	59.6	2.8
2	5101.00	50.2 AV	54.0	-3.8	1.77 V	78	47.4	2.8
3	5150.00	72.3 PK	74.0	-1.7	1.77 V	78	69.3	3.0
4	5150.00	53.7 AV	54.0	-0.3	1.77 V	78	50.7	3.0
5	*5180.00	118.0 PK			1.77 V	78	114.9	3.1
6	*5180.00	107.2 AV			1.77 V	78	104.1	3.1
7	#10360.00	64.1 PK	74.0	-9.9	2.34 V	201	50.5	13.6
8	#10360.00	50.4 AV	54.0	-3.6	2.34 V	201	36.8	13.6
9	15540.00	65.2 PK	74.0	-8.8	2.57 V	322	49.5	15.7
10	15540.00	49.0 AV	54.0	-5.0	2.57 V	322	33.3	15.7

**REMARKS:**

- Emission Level(dBuV/m) = Raw Value(dBuV) + Correction Factor(dB/m)
- Correction Factor(dB/m) = Antenna Factor(dB/m) + Cable Factor(dB) – Pre-Amplifier Factor(dB)
- The other emission levels were very low against the limit.
- Margin value = Emission Level – Limit value
- " \* ": Fundamental frequency.
- " # ": The radiated frequency is out of the restricted band.

<b>CHANNEL</b>	TX Channel 40	<b>DETECTOR FUNCTION</b>	Peak (PK)
<b>FREQUENCY RANGE</b>	1GHz ~ 40GHz		Average (AV)

**ANTENNA POLARITY & TEST DISTANCE: HORIZONTAL AT 3 M**

NO.	FREQ. (MHz)	EMISSION LEVEL (dBuV/m)	LIMIT (dBuV/m)	MARGIN (dB)	ANTENNA HEIGHT (m)	TABLE ANGLE (Degree)	RAW VALUE (dBuV)	CORRECTION FACTOR (dB/m)
1	5121.00	61.8 PK	74.0	-12.2	1.27 H	132	58.9	2.9
2	5121.00	43.4 AV	54.0	-10.6	1.27 H	132	40.5	2.9
3	*5200.00	107.9 PK			1.27 H	132	104.8	3.1
4	*5200.00	97.6 AV			1.27 H	132	94.5	3.1
5	#10400.00	63.5 PK	74.0	-10.5	1.91 H	268	49.9	13.6
6	#10400.00	50.2 AV	54.0	-3.8	1.91 H	268	36.6	13.6
7	15600.00	66.8 PK	74.0	-7.2	1.92 H	322	51.1	15.7
8	15600.00	51.0 AV	54.0	-3.0	1.92 H	322	35.3	15.7

**ANTENNA POLARITY & TEST DISTANCE: VERTICAL AT 3 M**

NO.	FREQ. (MHz)	EMISSION LEVEL (dBuV/m)	LIMIT (dBuV/m)	MARGIN (dB)	ANTENNA HEIGHT (m)	TABLE ANGLE (Degree)	RAW VALUE (dBuV)	CORRECTION FACTOR (dB/m)
1	5121.00	62.3 PK	74.0	-11.7	1.77 V	78	59.4	2.9
2	5121.00	51.0 AV	54.0	-3.0	1.77 V	78	48.1	2.9
3	*5200.00	118.8 PK			1.77 V	78	115.7	3.1
4	*5200.00	108.0 AV			1.77 V	78	104.9	3.1
5	#10400.00	66.6 PK	74.0	-7.4	2.23 V	203	53.0	13.6
6	#10400.00	52.6 AV	54.0	-1.4	2.23 V	203	39.0	13.6
7	15600.00	69.3 PK	74.0	-4.7	2.53 V	327	53.6	15.7
8	15600.00	53.9 AV	54.0	-0.1	2.53 V	327	38.2	15.7

**REMARKS:**

1. Emission Level(dBuV/m) = Raw Value(dBuV) + Correction Factor(dB/m)
2. Correction Factor(dB/m) = Antenna Factor(dB/m) + Cable Factor(dB) – Pre-Amplifier Factor(dB)
3. The other emission levels were very low against the limit.
4. Margin value = Emission Level – Limit value
5. " \* ": Fundamental frequency.
6. " # ": The radiated frequency is out of the restricted band.

<b>CHANNEL</b>	TX Channel 48	<b>DETECTOR FUNCTION</b>	Peak (PK)
<b>FREQUENCY RANGE</b>	1GHz ~ 40GHz		Average (AV)

**ANTENNA POLARITY & TEST DISTANCE: HORIZONTAL AT 3 M**

NO.	FREQ. (MHz)	EMISSION LEVEL (dBuV/m)	LIMIT (dBuV/m)	MARGIN (dB)	ANTENNA HEIGHT (m)	TABLE ANGLE (Degree)	RAW VALUE (dBuV)	CORRECTION FACTOR (dB/m)
1	*5240.00	108.2 PK			1.32 H	131	105.0	3.2
2	*5240.00	97.8 AV			1.32 H	131	94.6	3.2
3	5456.00	51.1 PK	74.0	-22.9	1.32 H	131	47.4	3.7
4	5456.00	40.1 AV	54.0	-13.9	1.32 H	131	36.4	3.7
5	#10480.00	62.8 PK	74.0	-11.2	1.97 H	264	48.8	14.0
6	#10480.00	49.2 AV	54.0	-4.8	1.97 H	264	35.2	14.0
7	15720.00	67.6 PK	74.0	-6.4	2.00 H	334	52.2	15.4
8	15720.00	51.5 AV	54.0	-2.5	2.00 H	334	36.1	15.4

**ANTENNA POLARITY & TEST DISTANCE: VERTICAL AT 3 M**

NO.	FREQ. (MHz)	EMISSION LEVEL (dBuV/m)	LIMIT (dBuV/m)	MARGIN (dB)	ANTENNA HEIGHT (m)	TABLE ANGLE (Degree)	RAW VALUE (dBuV)	CORRECTION FACTOR (dB/m)
1	*5240.00	118.3 PK			1.77 V	80	115.1	3.2
2	*5240.00	107.7 AV			1.77 V	80	104.5	3.2
3	5456.00	59.2 PK	74.0	-14.8	1.77 V	80	55.5	3.7
4	5456.00	47.5 AV	54.0	-6.5	1.77 V	80	43.8	3.7
5	#10480.00	65.0 PK	74.0	-9.0	2.34 V	203	51.0	14.0
6	#10480.00	51.5 AV	54.0	-2.5	2.34 V	203	37.5	14.0
7	15720.00	69.7 PK	74.0	-4.3	2.53 V	327	54.3	15.4
8	15720.00	53.7 AV	54.0	-0.3	2.53 V	327	38.3	15.4

**REMARKS:**

1. Emission Level(dBuV/m) = Raw Value(dBuV) + Correction Factor(dB/m)
2. Correction Factor(dB/m) = Antenna Factor(dB/m) + Cable Factor(dB) – Pre-Amplifier Factor(dB)
3. The other emission levels were very low against the limit.
4. Margin value = Emission Level – Limit value
5. " \* ": Fundamental frequency.
6. " # ": The radiated frequency is out of the restricted band.



<b>CHANNEL</b>	TX Channel 149	<b>DETECTOR FUNCTION</b>	Peak (PK)
<b>FREQUENCY RANGE</b>	1GHz ~ 40GHz		Average (AV)

**ANTENNA POLARITY & TEST DISTANCE: HORIZONTAL AT 3 M**

NO.	FREQ. (MHz)	EMISSION LEVEL (dBuV/m)	LIMIT (dBuV/m)	MARGIN (dB)	ANTENNA HEIGHT (m)	TABLE ANGLE (Degree)	RAW VALUE (dBuV)	CORRECTION FACTOR (dB/m)
1	#5644.68	55.3 PK	68.2	-12.9	1.30 H	131	51.3	4.0
2	*5745.00	109.8 PK			1.30 H	131	105.6	4.2
3	*5745.00	99.4 AV			1.30 H	131	95.2	4.2
4	#6014.76	56.0 PK	68.2	-12.2	1.30 H	131	51.5	4.5
5	11490.00	61.9 PK	74.0	-12.1	1.96 H	272	46.7	15.2
6	11490.00	49.0 AV	54.0	-5.0	1.96 H	272	33.8	15.2
7	#17235.00	62.2 PK	74.0	-11.8	1.89 H	302	42.2	20.0
8	#17235.00	45.4 AV	54.0	-8.6	1.89 H	302	25.4	20.0

**ANTENNA POLARITY & TEST DISTANCE: VERTICAL AT 3 M**

NO.	FREQ. (MHz)	EMISSION LEVEL (dBuV/m)	LIMIT (dBuV/m)	MARGIN (dB)	ANTENNA HEIGHT (m)	TABLE ANGLE (Degree)	RAW VALUE (dBuV)	CORRECTION FACTOR (dB/m)
1	#5658.30	68.6 PK	74.4	-5.8	1.77 V	71	64.6	4.0
2	*5745.00	121.2 PK			1.77 V	71	117.0	4.2
3	*5745.00	110.7 AV			1.77 V	71	106.5	4.2
4	#5983.20	61.7 PK	68.2	-6.5	1.77 V	71	57.2	4.5
5	11490.00	65.0 PK	74.0	-9.0	2.14 V	328	49.8	15.2
6	11490.00	51.6 AV	54.0	-2.4	2.14 V	328	36.4	15.2
7	#17235.00	64.9 PK	74.0	-9.1	2.59 V	39	44.9	20.0
8	#17235.00	50.0 AV	54.0	-4.0	2.59 V	39	30.0	20.0

**REMARKS:**

1. Emission Level(dBuV/m) = Raw Value(dBuV) + Correction Factor(dB/m)
2. Correction Factor(dB/m) = Antenna Factor(dB/m) + Cable Factor(dB) – Pre-Amplifier Factor(dB)
3. The other emission levels were very low against the limit.
4. Margin value = Emission Level – Limit value
5. " \* ": Fundamental frequency.
6. " # ": The radiated frequency is out of the restricted band.

<b>CHANNEL</b>	TX Channel 157	<b>DETECTOR FUNCTION</b>	Peak (PK)
<b>FREQUENCY RANGE</b>	1GHz ~ 40GHz		Average (AV)

**ANTENNA POLARITY & TEST DISTANCE: HORIZONTAL AT 3 M**

NO.	FREQ. (MHz)	EMISSION LEVEL (dBuV/m)	LIMIT (dBuV/m)	MARGIN (dB)	ANTENNA HEIGHT (m)	TABLE ANGLE (Degree)	RAW VALUE (dBuV)	CORRECTION FACTOR (dB/m)
1	#5604.16	55.8 PK	68.2	-12.4	1.36 H	131	51.9	3.9
2	*5785.00	109.7 PK			1.36 H	131	105.6	4.1
3	*5785.00	99.1 AV			1.36 H	131	95.0	4.1
4	#6010.54	56.7 PK	68.2	-11.5	1.36 H	131	52.2	4.5
5	11570.00	61.9 PK	74.0	-12.1	2.02 H	276	46.8	15.1
6	11570.00	48.9 AV	54.0	-5.1	2.02 H	276	33.8	15.1
7	#17355.00	62.6 PK	74.0	-11.4	1.92 H	313	42.1	20.5
8	#17355.00	45.9 AV	54.0	-8.1	1.92 H	313	25.4	20.5

**ANTENNA POLARITY & TEST DISTANCE: VERTICAL AT 3 M**

NO.	FREQ. (MHz)	EMISSION LEVEL (dBuV/m)	LIMIT (dBuV/m)	MARGIN (dB)	ANTENNA HEIGHT (m)	TABLE ANGLE (Degree)	RAW VALUE (dBuV)	CORRECTION FACTOR (dB/m)
1	#5625.52	62.6 PK	68.2	-5.6	1.77 V	70	58.6	4.0
2	*5785.00	121.0 PK			1.77 V	70	116.9	4.1
3	*5785.00	110.3 AV			1.77 V	70	106.2	4.1
4	#5945.68	62.8 PK	68.2	-5.4	1.77 V	70	58.4	4.4
5	11570.00	64.6 PK	74.0	-9.4	2.11 V	328	49.5	15.1
6	11570.00	51.4 AV	54.0	-2.6	2.11 V	328	36.3	15.1
7	#17355.00	64.7 PK	74.0	-9.3	2.64 V	28	44.2	20.5
8	#17355.00	49.8 AV	54.0	-4.2	2.64 V	28	29.3	20.5

**REMARKS:**

1. Emission Level(dBuV/m) = Raw Value(dBuV) + Correction Factor(dB/m)
2. Correction Factor(dB/m) = Antenna Factor(dB/m) + Cable Factor(dB) – Pre-Amplifier Factor(dB)
3. The other emission levels were very low against the limit.
4. Margin value = Emission Level – Limit value
5. " \* ": Fundamental frequency.
6. " # ": The radiated frequency is out of the restricted band.

<b>CHANNEL</b>	TX Channel 165	<b>DETECTOR FUNCTION</b>	Peak (PK)
<b>FREQUENCY RANGE</b>	1GHz ~ 40GHz		Average (AV)

**ANTENNA POLARITY & TEST DISTANCE: HORIZONTAL AT 3 M**

NO.	FREQ. (MHz)	EMISSION LEVEL (dBuV/m)	LIMIT (dBuV/m)	MARGIN (dB)	ANTENNA HEIGHT (m)	TABLE ANGLE (Degree)	RAW VALUE (dBuV)	CORRECTION FACTOR (dB/m)
1	#5582.74	56.3 PK	68.2	-11.9	1.46 H	132	52.4	3.9
2	*5825.00	109.0 PK			1.46 H	132	104.8	4.2
3	*5825.00	97.7 AV			1.46 H	132	93.5	4.2
4	#5993.77	57.1 PK	68.2	-11.1	1.46 H	132	52.6	4.5
5	11650.00	61.2 PK	74.0	-12.8	1.92 H	261	46.2	15.0
6	11650.00	48.3 AV	54.0	-5.7	1.92 H	261	33.3	15.0
7	#17475.00	62.8 PK	74.0	-11.2	1.95 H	308	41.7	21.1
8	#17475.00	45.7 AV	54.0	-8.3	1.95 H	308	24.6	21.1

**ANTENNA POLARITY & TEST DISTANCE: VERTICAL AT 3 M**

NO.	FREQ. (MHz)	EMISSION LEVEL (dBuV/m)	LIMIT (dBuV/m)	MARGIN (dB)	ANTENNA HEIGHT (m)	TABLE ANGLE (Degree)	RAW VALUE (dBuV)	CORRECTION FACTOR (dB/m)
1	#5586.57	63.1 PK	68.2	-5.1	1.79 V	71	59.2	3.9
2	*5825.00	121.2 PK			1.79 V	71	117.0	4.2
3	*5825.00	110.0 AV			1.79 V	71	105.8	4.2
4	#5983.68	63.6 PK	68.2	-4.6	1.79 V	71	59.1	4.5
5	11650.00	62.9 PK	74.0	-11.1	2.14 V	329	47.9	15.0
6	11650.00	49.2 AV	54.0	-4.8	2.14 V	329	34.2	15.0
7	#17475.00	62.2 PK	74.0	-11.8	2.59 V	37	41.1	21.1
8	#17475.00	48.8 AV	54.0	-5.2	2.59 V	37	27.7	21.1

**REMARKS:**

1. Emission Level(dBuV/m) = Raw Value(dBuV) + Correction Factor(dB/m)
2. Correction Factor(dB/m) = Antenna Factor(dB/m) + Cable Factor(dB) – Pre-Amplifier Factor(dB)
3. The other emission levels were very low against the limit.
4. Margin value = Emission Level – Limit value
5. " \* ": Fundamental frequency.
6. " # ": The radiated frequency is out of the restricted band.

**802.11ac (VHT40)**

<b>CHANNEL</b>	TX Channel 38	<b>DETECTOR FUNCTION</b>	Peak (PK)
<b>FREQUENCY RANGE</b>	1GHz ~ 40GHz		Average (AV)

**ANTENNA POLARITY & TEST DISTANCE: HORIZONTAL AT 3 M**

NO.	FREQ. (MHz)	EMISSION LEVEL (dBuV/m)	LIMIT (dBuV/m)	MARGIN (dB)	ANTENNA HEIGHT (m)	TABLE ANGLE (Degree)	RAW VALUE (dBuV)	CORRECTION FACTOR (dB/m)
1	5150.00	62.6 PK	74.0	-11.4	1.27 H	143	59.6	3.0
2	5150.00	43.8 AV	54.0	-10.2	1.27 H	143	40.8	3.0
3	*5190.00	100.3 PK			1.27 H	143	97.2	3.1
4	*5190.00	89.2 AV			1.27 H	143	86.1	3.1
5	#10380.00	56.2 PK	74.0	-17.8	2.02 H	268	42.5	13.7
6	#10380.00	43.1 AV	54.0	-10.9	2.02 H	268	29.4	13.7
7	15570.00	59.3 PK	74.0	-14.7	1.88 H	313	43.7	15.6
8	15570.00	44.1 AV	54.0	-9.9	1.88 H	313	28.5	15.6

**ANTENNA POLARITY & TEST DISTANCE: VERTICAL AT 3 M**

NO.	FREQ. (MHz)	EMISSION LEVEL (dBuV/m)	LIMIT (dBuV/m)	MARGIN (dB)	ANTENNA HEIGHT (m)	TABLE ANGLE (Degree)	RAW VALUE (dBuV)	CORRECTION FACTOR (dB/m)
1	5150.00	71.5 PK	74.0	-2.5	1.77 V	80	68.5	3.0
2	5150.00	53.8 AV	54.0	-0.2	1.77 V	80	50.8	3.0
3	*5190.00	110.8 PK			1.77 V	80	107.7	3.1
4	*5190.00	99.8 AV			1.77 V	80	96.7	3.1
5	#10380.00	59.4 PK	74.0	-14.6	2.40 V	207	45.7	13.7
6	#10380.00	46.1 AV	54.0	-7.9	2.40 V	207	32.4	13.7
7	15570.00	63.1 PK	74.0	-10.9	2.56 V	314	47.5	15.6
8	15570.00	47.2 AV	54.0	-6.8	2.56 V	314	31.6	15.6

**REMARKS:**

- Emission Level(dBuV/m) = Raw Value(dBuV) + Correction Factor(dB/m)
- Correction Factor(dB/m) = Antenna Factor(dB/m) + Cable Factor(dB) – Pre-Amplifier Factor(dB)
- The other emission levels were very low against the limit.
- Margin value = Emission Level – Limit value
- " \* ": Fundamental frequency.
- " # ": The radiated frequency is out of the restricted band.

<b>CHANNEL</b>	TX Channel 46	<b>DETECTOR FUNCTION</b>	Peak (PK)
<b>FREQUENCY RANGE</b>	1GHz ~ 40GHz		Average (AV)

**ANTENNA POLARITY & TEST DISTANCE: HORIZONTAL AT 3 M**

NO.	FREQ. (MHz)	EMISSION LEVEL (dBuV/m)	LIMIT (dBuV/m)	MARGIN (dB)	ANTENNA HEIGHT (m)	TABLE ANGLE (Degree)	RAW VALUE (dBuV)	CORRECTION FACTOR (dB/m)
1	5150.00	62.7 PK	74.0	-11.3	1.32 H	146	59.7	3.0
2	5150.00	43.9 AV	54.0	-10.1	1.32 H	146	40.9	3.0
3	*5230.00	106.3 PK			1.32 H	146	103.1	3.2
4	*5230.00	94.9 AV			1.32 H	146	91.7	3.2
5	5350.00	51.1 PK	74.0	-22.9	1.32 H	146	47.6	3.5
6	5350.00	40.2 AV	54.0	-13.8	1.32 H	146	36.7	3.5
7	#10460.00	59.2 PK	74.0	-14.8	2.03 H	268	45.3	13.9
8	#10460.00	45.7 AV	54.0	-8.3	2.03 H	268	31.8	13.9
9	15690.00	64.2 PK	74.0	-9.8	1.97 H	296	48.6	15.6
10	15690.00	48.3 AV	54.0	-5.7	1.97 H	296	32.7	15.6

**ANTENNA POLARITY & TEST DISTANCE: VERTICAL AT 3 M**

NO.	FREQ. (MHz)	EMISSION LEVEL (dBuV/m)	LIMIT (dBuV/m)	MARGIN (dB)	ANTENNA HEIGHT (m)	TABLE ANGLE (Degree)	RAW VALUE (dBuV)	CORRECTION FACTOR (dB/m)
1	5150.00	68.7 PK	74.0	-5.3	1.77 V	80	65.7	3.0
2	5150.00	52.7 AV	54.0	-1.3	1.77 V	80	49.7	3.0
3	*5230.00	117.0 PK			1.77 V	80	113.8	3.2
4	*5230.00	105.1 AV			1.77 V	80	101.9	3.2
5	5350.00	58.8 PK	74.0	-15.2	1.77 V	80	55.3	3.5
6	5350.00	47.0 AV	54.0	-7.0	1.77 V	80	43.5	3.5
7	#10460.00	62.3 PK	74.0	-11.7	2.34 V	200	48.4	13.9
8	#10460.00	48.3 AV	54.0	-5.7	2.34 V	200	34.4	13.9
9	15690.00	68.7 PK	74.0	-5.3	2.53 V	326	53.1	15.6
10	15690.00	53.8 AV	54.0	-0.2	2.53 V	326	38.2	15.6

**REMARKS:**

- Emission Level(dBuV/m) = Raw Value(dBuV) + Correction Factor(dB/m)
- Correction Factor(dB/m) = Antenna Factor(dB/m) + Cable Factor(dB) – Pre-Amplifier Factor(dB)
- The other emission levels were very low against the limit.
- Margin value = Emission Level – Limit value
- " \* ": Fundamental frequency.
- " # ": The radiated frequency is out of the restricted band.

<b>CHANNEL</b>	TX Channel 151	<b>DETECTOR FUNCTION</b>	Peak (PK)
<b>FREQUENCY RANGE</b>	1GHz ~ 40GHz		Average (AV)

**ANTENNA POLARITY & TEST DISTANCE: HORIZONTAL AT 3 M**

NO.	FREQ. (MHz)	EMISSION LEVEL (dBuV/m)	LIMIT (dBuV/m)	MARGIN (dB)	ANTENNA HEIGHT (m)	TABLE ANGLE (Degree)	RAW VALUE (dBuV)	CORRECTION FACTOR (dB/m)
1	#5629.04	56.2 PK	68.2	-12.0	1.46 H	132	52.2	4.0
2	*5755.00	107.2 PK			1.46 H	132	103.0	4.2
3	*5755.00	95.5 AV			1.46 H	132	91.3	4.2
4	#6006.30	57.4 PK	68.2	-10.8	1.46 H	132	52.9	4.5
5	11510.00	56.4 PK	74.0	-17.6	1.94 H	268	41.3	15.1
6	11510.00	43.2 AV	54.0	-10.8	1.94 H	268	28.1	15.1
7	#17265.00	56.2 PK	74.0	-17.8	1.96 H	325	36.3	19.9
8	#17265.00	42.7 AV	54.0	-11.3	1.96 H	325	22.8	19.9

**ANTENNA POLARITY & TEST DISTANCE: VERTICAL AT 3 M**

NO.	FREQ. (MHz)	EMISSION LEVEL (dBuV/m)	LIMIT (dBuV/m)	MARGIN (dB)	ANTENNA HEIGHT (m)	TABLE ANGLE (Degree)	RAW VALUE (dBuV)	CORRECTION FACTOR (dB/m)
1	#5657.35	67.2 PK	73.7	-6.5	1.80 V	71	63.2	4.0
2	*5755.00	118.5 PK			1.80 V	71	114.3	4.2
3	*5755.00	107.3 AV			1.80 V	71	103.1	4.2
4	#5984.62	60.4 PK	68.2	-7.8	1.80 V	71	55.9	4.5
5	11510.00	61.1 PK	74.0	-12.9	2.13 V	324	46.0	15.1
6	11510.00	47.1 AV	54.0	-6.9	2.13 V	324	32.0	15.1
7	#17265.00	60.9 PK	74.0	-13.1	2.67 V	27	41.0	19.9
8	#17265.00	46.2 AV	54.0	-7.8	2.67 V	27	26.3	19.9

**REMARKS:**

1. Emission Level(dBuV/m) = Raw Value(dBuV) + Correction Factor(dB/m)
2. Correction Factor(dB/m) = Antenna Factor(dB/m) + Cable Factor(dB) – Pre-Amplifier Factor(dB)
3. The other emission levels were very low against the limit.
4. Margin value = Emission Level – Limit value
5. " \* ": Fundamental frequency.
6. " # ": The radiated frequency is out of the restricted band.

<b>CHANNEL</b>	TX Channel 159	<b>DETECTOR FUNCTION</b>	Peak (PK)
<b>FREQUENCY RANGE</b>	1GHz ~ 40GHz		Average (AV)

**ANTENNA POLARITY & TEST DISTANCE: HORIZONTAL AT 3 M**

NO.	FREQ. (MHz)	EMISSION LEVEL (dBuV/m)	LIMIT (dBuV/m)	MARGIN (dB)	ANTENNA HEIGHT (m)	TABLE ANGLE (Degree)	RAW VALUE (dBuV)	CORRECTION FACTOR (dB/m)
1	#5586.80	56.7 PK	68.2	-11.5	1.46 H	131	52.8	3.9
2	*5795.00	105.7 PK			1.46 H	131	101.6	4.1
3	*5795.00	94.5 AV			1.46 H	131	90.4	4.1
4	#5944.77	57.1 PK	68.2	-11.1	1.46 H	131	52.7	4.4
5	11590.00	56.9 PK	74.0	-17.1	1.97 H	267	41.8	15.1
6	11590.00	43.6 AV	54.0	-10.4	1.97 H	267	28.5	15.1
7	#17385.00	56.6 PK	74.0	-17.4	2.01 H	337	36.0	20.6
8	#17385.00	43.4 AV	54.0	-10.6	2.01 H	337	22.8	20.6

**ANTENNA POLARITY & TEST DISTANCE: VERTICAL AT 3 M**

NO.	FREQ. (MHz)	EMISSION LEVEL (dBuV/m)	LIMIT (dBuV/m)	MARGIN (dB)	ANTENNA HEIGHT (m)	TABLE ANGLE (Degree)	RAW VALUE (dBuV)	CORRECTION FACTOR (dB/m)
1	#5599.40	62.1 PK	68.2	-6.1	1.81 V	72	58.2	3.9
2	*5795.00	117.8 PK			1.81 V	72	113.7	4.1
3	*5795.00	107.0 AV			1.81 V	72	102.9	4.1
4	#5950.90	62.5 PK	68.2	-5.7	1.81 V	72	58.1	4.4
5	11590.00	60.5 PK	74.0	-13.5	2.18 V	330	45.4	15.1
6	11590.00	46.8 AV	54.0	-7.2	2.18 V	330	31.7	15.1
7	#17385.00	61.3 PK	74.0	-12.7	2.63 V	15	40.7	20.6
8	#17385.00	46.6 AV	54.0	-7.4	2.63 V	15	26.0	20.6

**REMARKS:**

1. Emission Level(dBuV/m) = Raw Value(dBuV) + Correction Factor(dB/m)
2. Correction Factor(dB/m) = Antenna Factor(dB/m) + Cable Factor(dB) – Pre-Amplifier Factor(dB)
3. The other emission levels were very low against the limit.
4. Margin value = Emission Level – Limit value
5. " \* ": Fundamental frequency.
6. " # ": The radiated frequency is out of the restricted band.

**802.11ac (VHT80)**

<b>CHANNEL</b>	TX Channel 42	<b>DETECTOR FUNCTION</b>	Peak (PK)
<b>FREQUENCY RANGE</b>	1GHz ~ 40GHz		Average (AV)

**ANTENNA POLARITY & TEST DISTANCE: HORIZONTAL AT 3 M**

NO.	FREQ. (MHz)	EMISSION LEVEL (dBuV/m)	LIMIT (dBuV/m)	MARGIN (dB)	ANTENNA HEIGHT (m)	TABLE ANGLE (Degree)	RAW VALUE (dBuV)	CORRECTION FACTOR (dB/m)
1	5150.00	62.2 PK	74.0	-11.8	1.24 H	129	59.2	3.0
2	5150.00	43.2 AV	54.0	-10.8	1.24 H	129	40.2	3.0
3	*5210.00	95.2 PK			1.24 H	129	92.0	3.2
4	*5210.00	87.0 AV			1.24 H	129	83.8	3.2
5	5350.00	51.0 PK	74.0	-23.0	1.24 H	129	47.5	3.5
6	5350.00	40.3 AV	54.0	-13.7	1.24 H	129	36.8	3.5
7	#10420.00	50.1 PK	74.0	-23.9	1.91 H	262	36.3	13.8
8	#10420.00	37.3 AV	54.0	-16.7	1.91 H	262	23.5	13.8
9	15630.00	54.3 PK	74.0	-19.7	1.96 H	328	38.6	15.7
10	15630.00	39.2 AV	54.0	-14.8	1.96 H	328	23.5	15.7

**ANTENNA POLARITY & TEST DISTANCE: VERTICAL AT 3 M**

NO.	FREQ. (MHz)	EMISSION LEVEL (dBuV/m)	LIMIT (dBuV/m)	MARGIN (dB)	ANTENNA HEIGHT (m)	TABLE ANGLE (Degree)	RAW VALUE (dBuV)	CORRECTION FACTOR (dB/m)
1	5150.00	69.4 PK	74.0	-4.6	1.77 V	80	66.4	3.0
2	<b>5150.00</b>	<b>53.9 AV</b>	<b>54.0</b>	<b>-0.1</b>	<b>1.77 V</b>	<b>80</b>	<b>50.9</b>	<b>3.0</b>
3	*5210.00	106.6 PK			1.77 V	80	103.4	3.2
4	*5210.00	97.1 AV			1.77 V	80	93.9	3.2
5	5350.00	58.5 PK	74.0	-15.5	1.77 V	80	55.0	3.5
6	5350.00	46.8 AV	54.0	-7.2	1.77 V	80	43.3	3.5
7	#10420.00	53.1 PK	74.0	-20.9	2.38 V	203	39.3	13.8
8	#10420.00	40.2 AV	54.0	-13.8	2.38 V	203	26.4	13.8
9	15630.00	55.8 PK	74.0	-18.2	2.61 V	302	40.1	15.7
10	15630.00	40.3 AV	54.0	-13.7	2.61 V	302	24.6	15.7

**REMARKS:**

- Emission Level(dBuV/m) = Raw Value(dBuV) + Correction Factor(dB/m)
- Correction Factor(dB/m) = Antenna Factor(dB/m) + Cable Factor(dB) – Pre-Amplifier Factor(dB)
- The other emission levels were very low against the limit.
- Margin value = Emission Level – Limit value
- " \* ": Fundamental frequency.
- " # ": The radiated frequency is out of the restricted band.



<b>CHANNEL</b>	TX Channel 155	<b>DETECTOR FUNCTION</b>	Peak (PK)
<b>FREQUENCY RANGE</b>	1GHz ~ 40GHz		Average (AV)

**ANTENNA POLARITY & TEST DISTANCE: HORIZONTAL AT 3 M**

NO.	FREQ. (MHz)	EMISSION LEVEL (dBuV/m)	LIMIT (dBuV/m)	MARGIN (dB)	ANTENNA HEIGHT (m)	TABLE ANGLE (Degree)	RAW VALUE (dBuV)	CORRECTION FACTOR (dB/m)
1	#5617.08	58.1 PK	68.2	-10.1	1.46 H	132	54.2	3.9
2	*5775.00	102.3 PK			1.46 H	132	98.1	4.2
3	*5775.00	92.3 AV			1.46 H	132	88.1	4.2
4	#5929.81	58.2 PK	68.2	-10.0	1.46 H	132	53.8	4.4
5	11550.00	51.2 PK	74.0	-22.8	1.96 H	253	36.0	15.2
6	11550.00	38.3 AV	54.0	-15.7	1.96 H	253	23.1	15.2
7	#17325.00	56.2 PK	74.0	-17.8	1.97 H	345	35.9	20.3
8	#17325.00	43.0 AV	54.0	-11.0	1.97 H	345	22.7	20.3

**ANTENNA POLARITY & TEST DISTANCE: VERTICAL AT 3 M**

NO.	FREQ. (MHz)	EMISSION LEVEL (dBuV/m)	LIMIT (dBuV/m)	MARGIN (dB)	ANTENNA HEIGHT (m)	TABLE ANGLE (Degree)	RAW VALUE (dBuV)	CORRECTION FACTOR (dB/m)
1	#5646.90	67.9 PK	68.2	-0.3	1.81 V	69	63.9	4.0
2	*5775.00	114.7 PK			1.81 V	69	110.5	4.2
3	*5775.00	104.9 AV			1.81 V	69	100.7	4.2
4	#5932.85	66.4 PK	68.2	-1.8	1.81 V	69	62.0	4.4
5	11550.00	56.1 PK	74.0	-17.9	2.10 V	332	40.9	15.2
6	11550.00	43.1 AV	54.0	-10.9	2.10 V	332	27.9	15.2
7	#17325.00	55.8 PK	74.0	-18.2	2.71 V	18	35.5	20.3
8	#17325.00	43.4 AV	54.0	-10.6	2.71 V	18	23.1	20.3

**REMARKS:**

1. Emission Level(dBuV/m) = Raw Value(dBuV) + Correction Factor(dB/m)
2. Correction Factor(dB/m) = Antenna Factor(dB/m) + Cable Factor(dB) – Pre-Amplifier Factor(dB)
3. The other emission levels were very low against the limit.
4. Margin value = Emission Level – Limit value
5. " \* ": Fundamental frequency.
6. " # ": The radiated frequency is out of the restricted band.

**Below 1GHz Data:**

**802.11ac(VHT20)**

<b>CHANNEL</b>	TX Channel 157	<b>DETECTOR FUNCTION</b>	Quasi-Peak (QP)
<b>FREQUENCY RANGE</b>	9KHz ~ 1GHz		

<b>ANTENNA POLARITY &amp; TEST DISTANCE: HORIZONTAL AT 3 M</b>								
NO.	FREQ. (MHz)	EMISSION LEVEL (dBuV/m)	LIMIT (dBuV/m)	MARGIN (dB)	ANTENNA HEIGHT (m)	TABLE ANGLE (Degree)	RAW VALUE (dBuV)	CORRECTION FACTOR (dB/m)
1	61.77	28.9 QP	40.0	-11.1	1.45 H	100	38.2	-9.3
2	83.72	32.1 QP	40.0	-7.9	1.54 H	124	45.6	-13.5
3	105.34	32.1 QP	43.5	-11.4	1.65 H	302	44.2	-12.1
4	159.86	33.1 QP	43.5	-10.4	1.24 H	244	41.5	-8.4
5	177.85	30.8 QP	43.5	-12.7	1.65 H	321	40.2	-9.4
6	221.85	30.1 QP	46.0	-15.9	1.65 H	88	41.4	-11.3

<b>ANTENNA POLARITY &amp; TEST DISTANCE: VERTICAL AT 3 M</b>								
NO.	FREQ. (MHz)	EMISSION LEVEL (dBuV/m)	LIMIT (dBuV/m)	MARGIN (dB)	ANTENNA HEIGHT (m)	TABLE ANGLE (Degree)	RAW VALUE (dBuV)	CORRECTION FACTOR (dB/m)
1	33.21	31.4 QP	40.0	-8.6	1.24 V	310	41.1	-9.7
2	41.65	33.1 QP	40.0	-6.9	1.34 V	214	42.0	-8.9
3	67.34	31.4 QP	40.0	-8.6	1.42 V	311	41.4	-10.0
4	96.75	31.4 QP	43.5	-12.1	1.45 V	211	44.8	-13.4
5	157.88	30.1 QP	43.5	-13.4	1.36 V	314	38.4	-8.3
6	243.99	30.2 QP	46.0	-15.8	1.65 V	311	39.8	-9.6

**REMARKS:**

1. Emission Level(dBuV/m) = Raw Value(dBuV) + Correction Factor(dB/m)
2. Correction Factor(dB/m) = Antenna Factor(dB/m) + Cable Factor(dB) – Pre-Amplifier Factor(dB)
3. The other emission levels were very low against the limit.
4. Margin value = Emission Level – Limit value

## 4.2 Conducted Emission Measurement

### 4.2.1 Limits of Conducted Emission Measurement

Frequency (MHz)	Conducted Limit (dBuV)	
	Quasi-peak	Average
0.15 - 0.5	66 - 56	56 - 46
0.50 - 5.0	56	46
5.0 - 30.0	60	50

Note: 1. The lower limit shall apply at the transition frequencies.

2. The limit decreases in line with the logarithm of the frequency in the range of 0.15 to 0.50MHz.

### 4.2.2 Test Instruments

DESCRIPTION & MANUFACTURER	MODEL NO.	SERIAL NO.	CALIBRATED DATE	CALIBRATED UNTIL
Test Receiver R&S	ESCS 30	847124/029	Oct. 24, 2016	Oct. 23, 2017
Line-Impedance Stabilization Network (for EUT) R&S	ESH3-Z5	848773/004	Oct. 26, 2016	Oct. 25, 2017
Line-Impedance Stabilization Network (for Peripheral) R&S	ENV216	100072	June 13, 2016	June 12, 2017
RF Cable	5D-FB	COACAB-002	Mar. 04, 2016	Mar. 03, 2017
10 dB PAD Mini-Circuits	HAT-10+	CONATT-004	Jun. 20, 2016	Jun. 19, 2017
Software BVADT	BVADT_Cond_ V7.3.7.4	NA	NA	NA

#### Note:

1. The calibration interval of the above test instruments are 12 months and the calibrations are traceable to NML/ROC and NIST/USA.
2. The test was performed in Shielded Room No. 1.
- 3 Tested Date: Nov. 23, 2016

#### 4.2.3 Test Procedure

- The EUT was placed 0.4 meters from the conducting wall of the shielded room with EUT being connected to the power mains through a line impedance stabilization network (LISN). Other support units were connected to the power mains through another LISN. The two LISNs provide 50 ohm/ 50uH of coupling impedance for the measuring instrument.
- Both lines of the power mains connected to the EUT were checked for maximum conducted interference.
- The frequency range from 150kHz to 30MHz was searched. Emission levels under (Limit - 20dB) was not recorded.

**NOTE:** All modes of operation were investigated and the worst-case emissions are reported.

#### 4.2.4 Deviation from Test Standard

No deviation.

#### 4.2.5 Test Setup

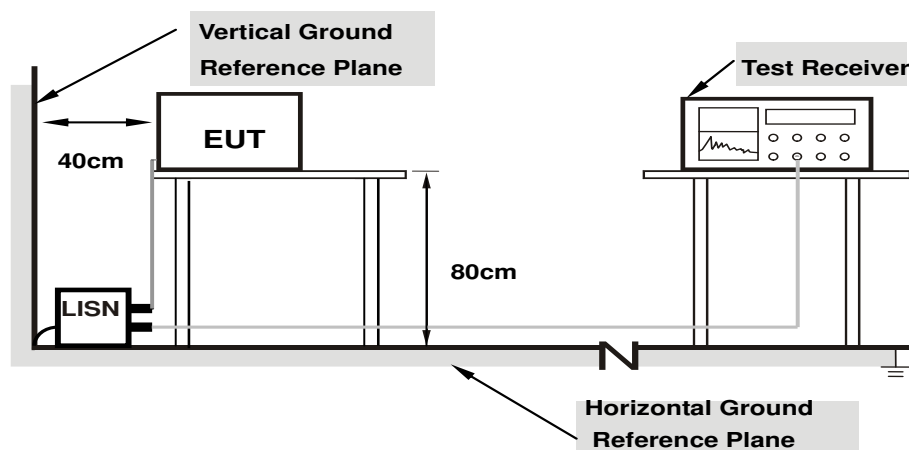

**Note: 1.Support units were connected to second LISN.**

For the actual test configuration, please refer to the attached file (Test Setup Photo).

#### 4.2.6 EUT Operating Condition

Same as 4.1.6.

#### 4.2.7 Test Results (Mode 1)

Phase	Line (L)	Detector Function	Quasi-Peak (QP) / Average (AV)
-------	----------	-------------------	--------------------------------

Phase Of Power : Line (L)										
No	Frequency (MHz)	Correction Factor (dB)	Reading Value (dBuV)		Emission Level (dBuV)		Limit (dBuV)		Margin (dB)	
			Q.P.	AV.	Q.P.	AV.	Q.P.	AV.	Q.P.	AV.
1	0.15000	10.20	37.04	24.35	47.24	34.55	66.00	56.00	-18.76	-21.45
2	0.18125	10.20	30.14	16.85	40.34	27.05	64.43	54.43	-24.09	-27.38
3	0.29453	10.22	30.83	23.29	41.05	33.51	60.40	50.40	-19.35	-16.89
4	0.37266	10.23	18.65	10.52	28.88	20.75	58.44	48.44	-29.56	-27.69
5	6.55859	10.49	1.67	-4.31	12.16	6.18	60.00	50.00	-47.84	-43.82
6	10.37500	10.77	8.36	5.10	19.13	15.87	60.00	50.00	-40.87	-34.13

**Remarks:**

1. Q.P. and AV. are abbreviations of quasi-peak and average individually.
2. The emission levels of other frequencies were very low against the limit.
3. Margin value = Emission level – Limit value
4. Correction factor = Insertion loss + Cable loss
5. Emission Level = Correction Factor + Reading Value

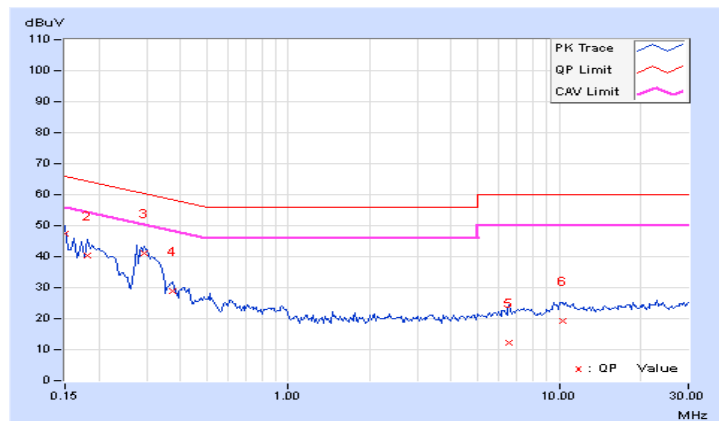

Phase	Neutral (N)	Detector Function	Quasi-Peak (QP) / Average (AV)
-------	-------------	-------------------	--------------------------------

Phase Of Power : Neutral (N)										
No	Frequency (MHz)	Correction Factor (dB)	Reading Value (dBuV)		Emission Level (dBuV)		Limit (dBuV)		Margin (dB)	
			Q.P.	AV.	Q.P.	AV.	Q.P.	AV.	Q.P.	AV.
1	0.15000	10.19	35.39	23.17	45.58	33.36	66.00	56.00	-20.42	-22.64
2	0.17344	10.18	30.94	18.19	41.12	28.37	64.79	54.79	-23.67	-26.42
3	0.20078	10.17	28.32	15.88	38.49	26.05	63.58	53.58	-25.09	-27.53
4	0.29453	10.20	28.21	20.21	38.41	30.41	60.40	50.40	-21.99	-19.99
5	2.00781	10.31	3.99	1.86	14.30	12.17	56.00	46.00	-41.70	-33.83
6	10.47266	10.67	8.90	5.67	19.57	16.34	60.00	50.00	-40.43	-33.66

**Remarks:**

1. Q.P. and AV. are abbreviations of quasi-peak and average individually.
2. The emission levels of other frequencies were very low against the limit.
3. Margin value = Emission level – Limit value
4. Correction factor = Insertion loss + Cable loss
5. Emission Level = Correction Factor + Reading Value

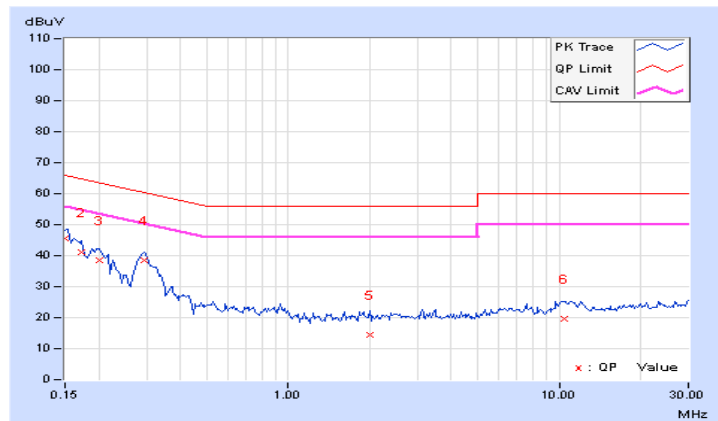

#### 4.2.8 Test Results (Mode 2)

Phase	Line (L)	Detector Function	Quasi-Peak (QP) / Average (AV)
-------	----------	-------------------	--------------------------------

Phase Of Power : Line (L)										
No	Frequency (MHz)	Correction Factor (dB)	Reading Value (dBuV)		Emission Level (dBuV)		Limit (dBuV)		Margin (dB)	
			Q.P.	AV.	Q.P.	AV.	Q.P.	AV.	Q.P.	AV.
1	0.15000	10.20	35.16	18.22	45.36	28.42	66.00	56.00	-20.64	-27.58
2	0.17344	10.20	36.20	27.98	46.40	38.18	64.79	54.79	-18.39	-16.61
3	0.29844	10.22	24.23	20.07	34.45	30.29	60.29	50.29	-25.84	-20.00
<b>4</b>	<b>0.48594</b>	<b>10.25</b>	<b>30.76</b>	<b>26.25</b>	<b>41.01</b>	<b>36.50</b>	<b>56.24</b>	<b>46.24</b>	<b>-15.23</b>	<b>-9.74</b>
5	9.36719	10.69	29.17	24.13	39.86	34.82	60.00	50.00	-20.14	-15.18
6	14.01563	11.19	23.96	18.58	35.15	29.77	60.00	50.00	-24.85	-20.23

#### Remarks:

1. Q.P. and AV. are abbreviations of quasi-peak and average individually.
2. The emission levels of other frequencies were very low against the limit.
3. Margin value = Emission level – Limit value
4. Correction factor = Insertion loss + Cable loss
5. Emission Level = Correction Factor + Reading Value

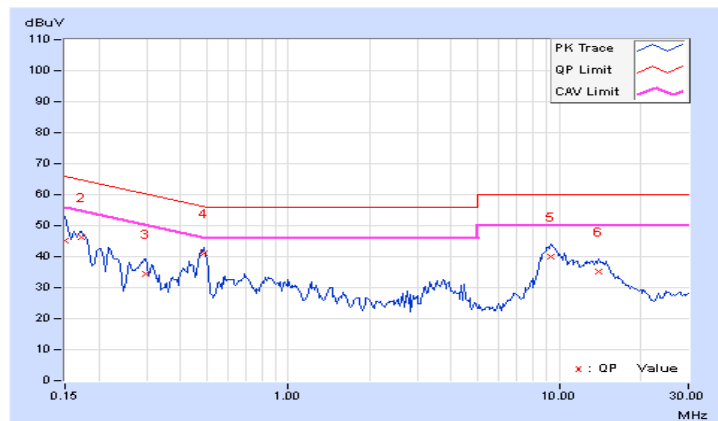

Phase	Neutral (N)	Detector Function	Quasi-Peak (QP) / Average (AV)
-------	-------------	-------------------	--------------------------------

Phase Of Power : Neutral (N)										
No	Frequency (MHz)	Correction Factor (dB)	Reading Value (dBuV)		Emission Level (dBuV)		Limit (dBuV)		Margin (dB)	
			Q.P.	AV.	Q.P.	AV.	Q.P.	AV.	Q.P.	AV.
1	0.15000	10.19	39.74	26.10	49.93	36.29	66.00	56.00	-16.07	-19.71
2	0.18125	10.18	33.66	16.38	43.84	26.56	64.43	54.43	-20.59	-27.87
3	0.29063	10.20	27.67	22.63	37.87	32.83	60.51	50.51	-22.64	-17.68
4	0.48594	10.24	30.42	23.98	40.66	34.22	56.24	46.24	-15.58	-12.02
5	3.74219	10.23	18.33	8.55	28.56	18.78	56.00	46.00	-27.44	-27.22
6	9.03906	10.56	27.93	22.71	38.49	33.27	60.00	50.00	-21.51	-16.73

**Remarks:**

1. Q.P. and AV. are abbreviations of quasi-peak and average individually.
2. The emission levels of other frequencies were very low against the limit.
3. Margin value = Emission level – Limit value
4. Correction factor = Insertion loss + Cable loss
5. Emission Level = Correction Factor + Reading Value

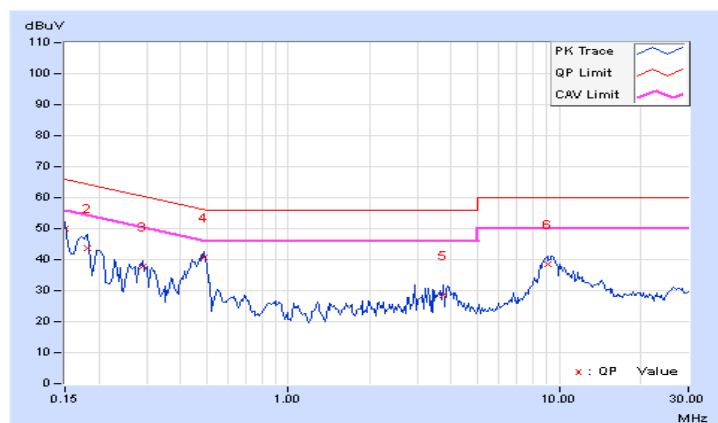



### 4.3 Transmit Power Measurement

#### 4.3.1 Limits of Transmit Power Measurement

Operation Band	EUT Category		Limit
U-NII-1		Outdoor Access Point	1 Watt (30 dBm) (Max. e.i.r.p $\leq$ 125mW(21 dBm) at any elevation angle above 30 degrees as measured from the horizon)
		Fixed point-to-point Access Point	1 Watt (30 dBm)
	√	Indoor Access Point	1 Watt (30 dBm)
		Mobile and Portable client device	250mW (24 dBm)
U-NII-2A	---		250mW (24 dBm) or 11 dBm+10 log B*
U-NII-2C	---		250mW (24 dBm) or 11 dBm+10 log B*
U-NII-3	√		1 Watt (30 dBm)

\*B is the 26 dB emission bandwidth in megahertz

Per KDB 662911 Method of conducted output power measurement on IEEE 802.11 devices,

Array Gain = 0 dB (i.e., no array gain) for  $N_{ANT} \leq 4$ ;

Array Gain = 0 dB (i.e., no array gain) for channel widths  $\geq 40$  MHz for any  $N_{ANT}$ ;

Array Gain =  $5 \log(N_{ANT}/N_{SS})$  dB or 3 dB, whichever is less for 20-MHz channel widths with  $N_{ANT} \geq 5$ .

For power measurements on all other devices: Array Gain =  $10 \log(N_{ANT}/N_{SS})$  dB.

#### 4.3.2 Test Setup

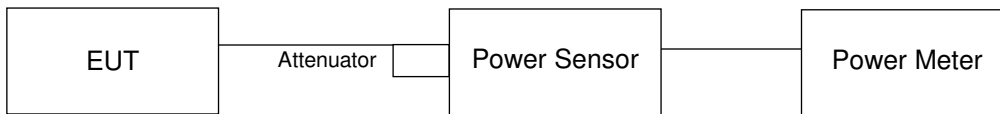

#### 4.3.3 Test Instruments

Refer to section 4.1.2 to get information of above instrument.

#### 4.3.4 Test Procedure

##### **For Average Power Measurement**

Method PM is used to perform output power measurement, trigger and gating function of wide band power meter is enabled to measure max output power of TX on burst. Duty factor is not added to measured value.

#### 4.3.5 Deviation from Test Standard

No deviation.

#### 4.3.6 EUT Operating Condition

The software provided by client to enable the EUT under transmission condition continuously at lowest, middle and highest channel frequencies individually.

#### 4.3.7 Test Result

##### CDD Mode

##### 802.11a

Chan.	Chan. Freq. (MHz)	Maximum Conducted Power (dBm)		Total Power (mW)	Total Power (dBm)	Limit (dBm)	Pass / Fail
		Chain 0	Chain 1				
36	5180	22.27	21.82	320.71	25.06	30.00	Pass
40	5200	23.62	23.56	457.13	26.60	30.00	Pass
48	5240	22.46	23.22	386.092	25.87	30.00	Pass
149	5745	25.89	26.00	786.257	28.96	30.00	Pass
157	5785	24.75	25.65	665.82	28.23	30.00	Pass
165	5825	23.87	25.47	596.152	27.75	30.00	Pass

## Beamforming Mode

### 802.11ac (VHT20)

Chan.	Chan. Freq. (MHz)	Maximum Conducted Power (dBm)		Total Power (mW)	Total Power (dBm)	Limit (dBm)	Pass / Fail
		Chain 0	Chain 1				
36	5180	21.62	22.03	304.799	24.84	30.00	Pass
40	5200	23.17	23.52	432.396	26.36	30.00	Pass
48	5240	22.94	23.23	407.167	26.10	30.00	Pass
149	5745	25.84	26.06	787.352	28.96	30.00	Pass
157	5785	25.39	26.49	791.595	28.99	30.00	Pass
165	5825	24.47	25.91	669.84	28.26	30.00	Pass

Note: Directional gain =  $10 \log[(10^{G1/20} + 10^{G2/20})^2 / 2]$  = 4.27dBi < 6dBi so the power limit shall not be reduced.

### 802.11ac (VHT40)

Chan.	Chan. Freq. (MHz)	Maximum Conducted Power (dBm)		Total Power (mW)	Total Power (dBm)	Limit (dBm)	Pass / Fail
		Chain 0	Chain 0				
38	5190	18.29	18.29	134.906	21.30	30.00	Pass
46	5230	23.47	24.41	498.389	26.98	30.00	Pass
151	5755	25.25	25.58	696.375	28.43	30.00	Pass
159	5795	24.62	25.56	649.483	28.13	30.00	Pass

Note: Directional gain =  $10 \log[(10^{G1/20} + 10^{G2/20})^2 / 2]$  = 4.27dBi < 6dBi so the power limit shall not be reduced.

### 802.11ac (VHT80)

Chan.	Chan. Freq. (MHz)	Maximum Conducted Power (dBm)		Total Power (mW)	Total Power (dBm)	Limit (dBm)	Pass / Fail
		Chain 0	Chain 1				
42	5210	16.37	17.06	94.167	19.74	30.00	Pass
155	5775	23.62	23.87	473.925	26.76	30.00	Pass

Note: Directional gain =  $10 \log[(10^{G1/20} + 10^{G2/20})^2 / 2]$  = 4.27dBi < 6dBi so the power limit shall not be reduced.

## 4.4 Occupied Bandwidth Measurement

### 4.4.1 Test Setup

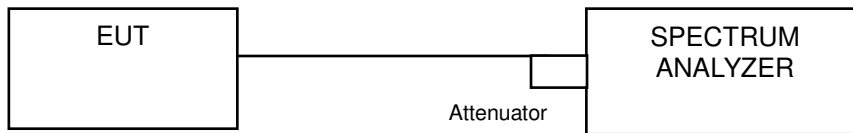

### 4.4.2 Test Instruments

Refer to section 4.1.2 to get information of above instrument.

### 4.4.3 Test Procedure

The transmitter output was connected to the spectrum analyzer through an attenuator. The bandwidth of the fundamental frequency was measured by spectrum analyzer with resolution bandwidth in the range of 1% to 5% of the anticipated emission bandwidth, and a video bandwidth at least 3x the resolution bandwidth and set the detector to SAMPLE. The width of a frequency band such that, below the lower and above the upper frequency limits, the mean powers emitted are each equal to a specified percentage 0.5 %of the total mean power of a given emission.

#### 4.4.4 Test Results

##### CDD Mode

##### 802.11a

Channel	Channel Frequency (MHz)	Occupied Bandwidth (MHz)	
		CHAIN 0	CHAIN 1
36	5180	16.80	18.00
40	5200	17.40	18.72
48	5240	17.16	18.36
149	5745	16.80	18.24
157	5785	17.16	18.48
164	5825	17.16	18.72

##### Beamforming Mode

##### 802.11ac (VHT20)

Channel	Channel Frequency (MHz)	Occupied Bandwidth (MHz)	
		CHAIN 0	CHAIN 1
36	5180	17.88	18.00
40	5200	18.12	18.24
48	5240	18.12	18.36
149	5745	18.00	18.60
157	5785	18.00	18.48
164	5825	18.24	18.96

**802.11ac (VHT40)**

Channel	Channel Frequency (MHz)	Occupied Bandwidth (MHz)	
		CHAIN 0	CHAIN 1
38	5190	36.48	36.48
46	5230	37.20	37.44
151	5755	36.96	36.96
159	5795	36.96	37.44

**802.11ac (VHT80)**

Channel	Channel Frequency (MHz)	Occupied Bandwidth (MHz)	
		CHAIN 0	CHAIN 1
42	5210	75.84	75.84
155	5775	76.32	76.32

### Spectrum Plot of Worst Value

**802.11a\_Chain1 / CH165**

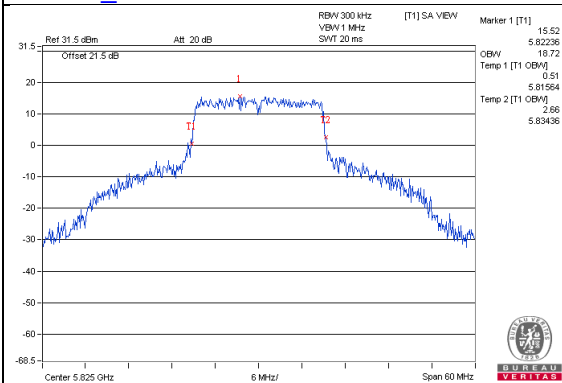

**802.11ac (VHT20)\_Chain1 / CH165**

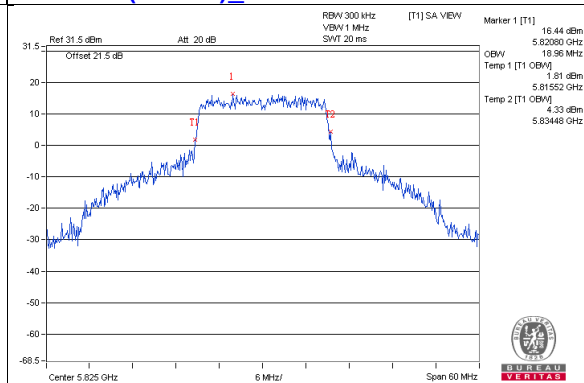

**802.11ac (VHT40)\_Chain1 / CH159**

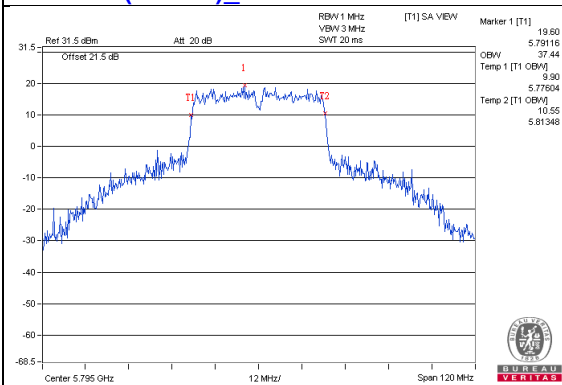

**802.11ac (VHT80)\_Chain1 / CH155**

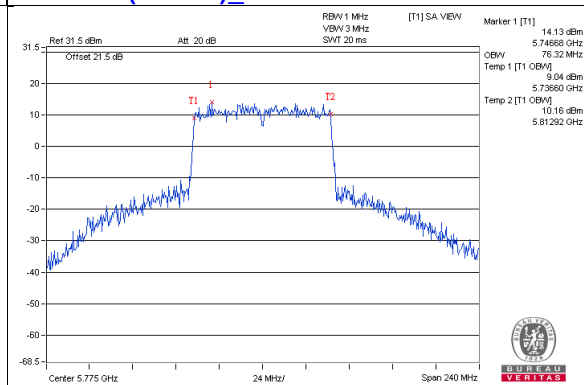



### Spectrum Plot for near by DFS band (DFS is required, if 99% OCP straddle into U-NII-2A band)

**802.11a\_Chain0 / CH48**

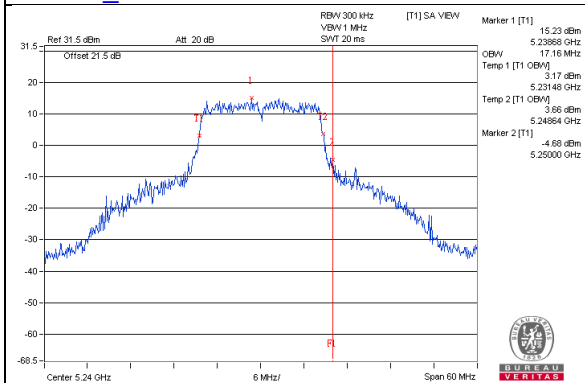

**802.11a\_Chain1 / CH48**

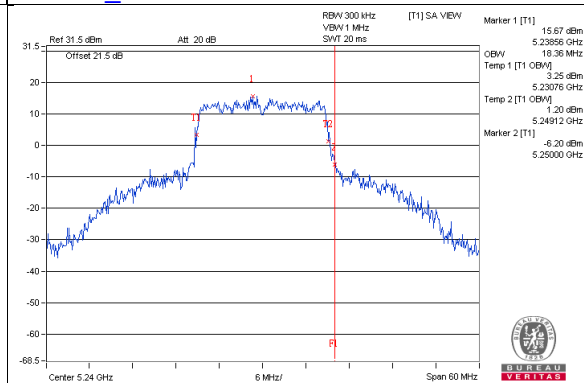

**802.11ac(VHT20)\_Chain0 / CH48**

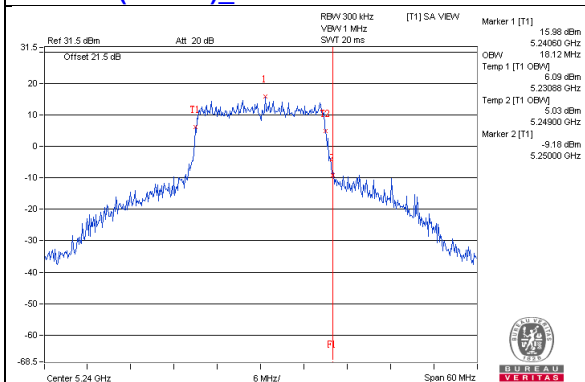

**802.11ac(VHT20)\_Chain1 / CH48**

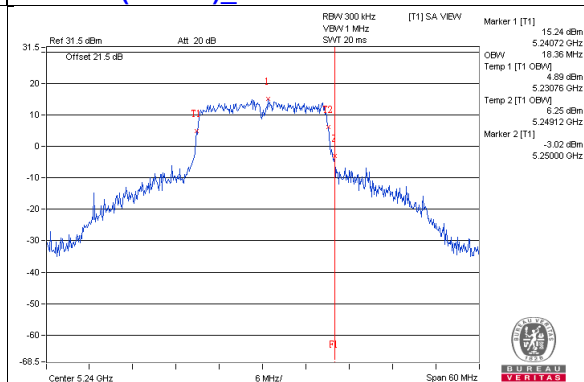

**802.11ac(VHT40)\_Chain0 / CH46**

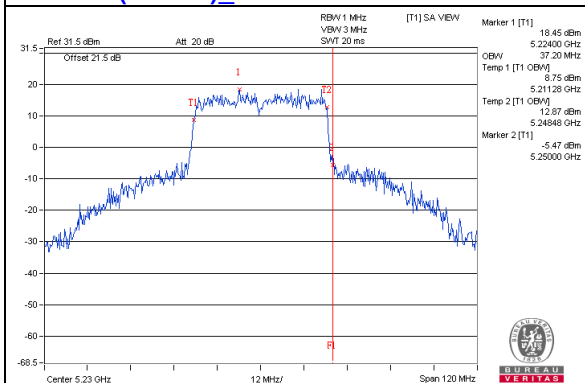

**802.11ac(VHT40)\_Chain1 / CH46**

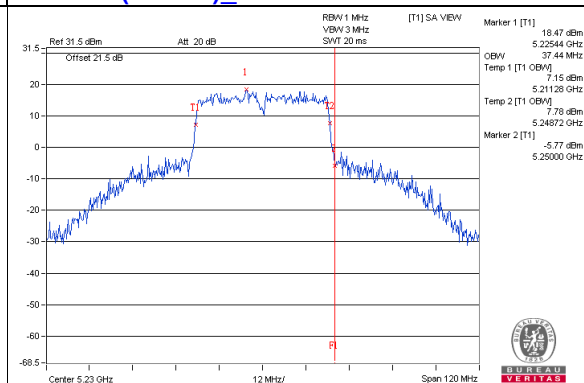

**802.11ac(VHT80)\_Chain0 / CH42**

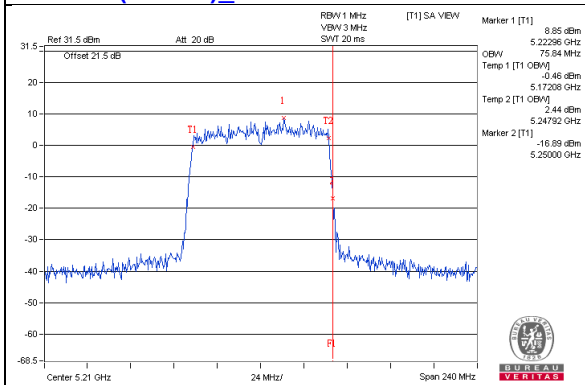

**802.11ac(VHT80)\_Chain1 / CH42**

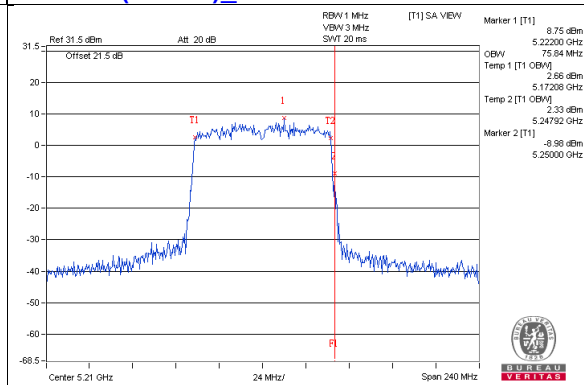

**Spectrum Plot for near by DFS band  
(DFS is required, if 99% OCP straddle into U-NII-2C band)**

**802.11a\_Chain0 / CH149**

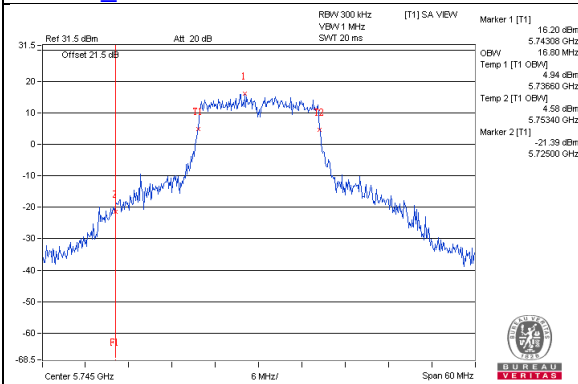

**802.11a\_Chain1 / CH149**

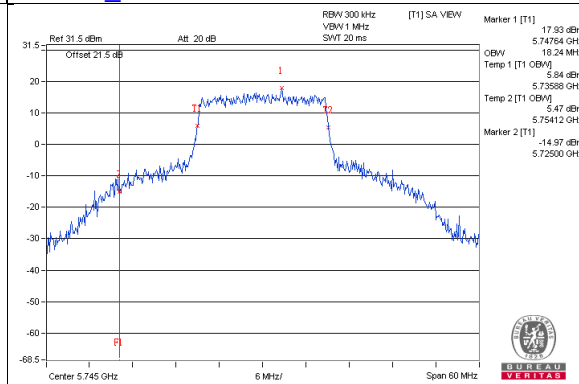

**802.11ac(VHT20)\_Chain0 / CH149**

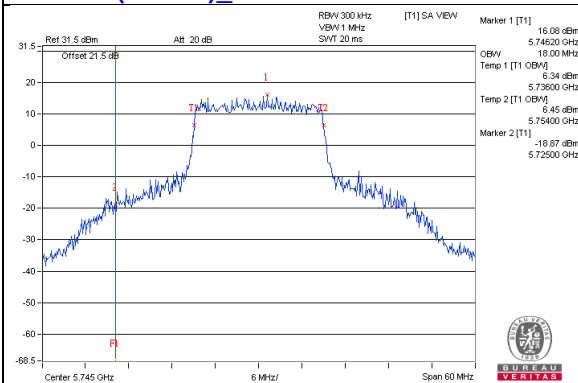

**802.11ac(VHT20)\_Chain1 / CH149**

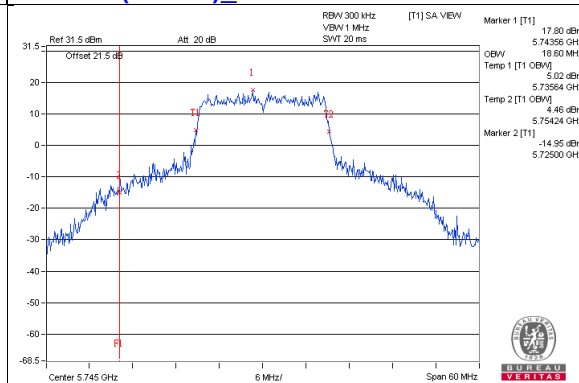

**802.11ac(VHT40)\_Chain0 / CH151**

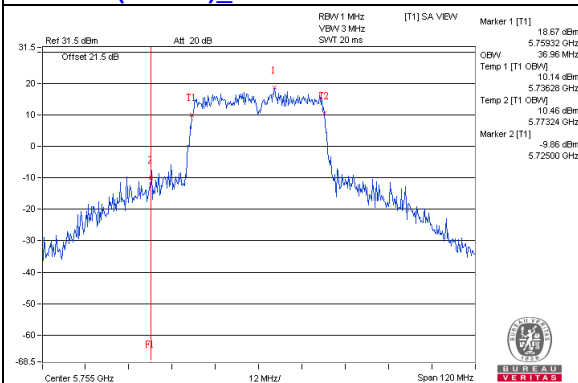

**802.11ac(VHT40)\_Chain1 / CH151**

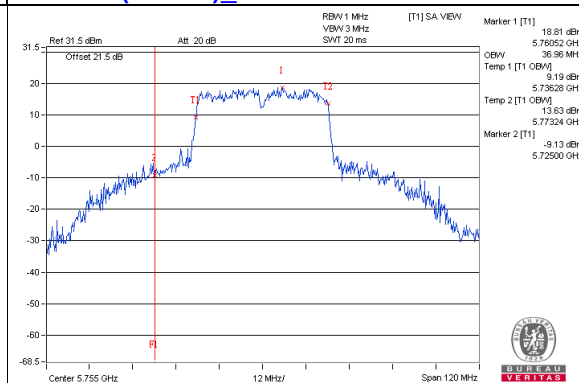

**802.11ac(VHT80)\_Chain0 / CH155**

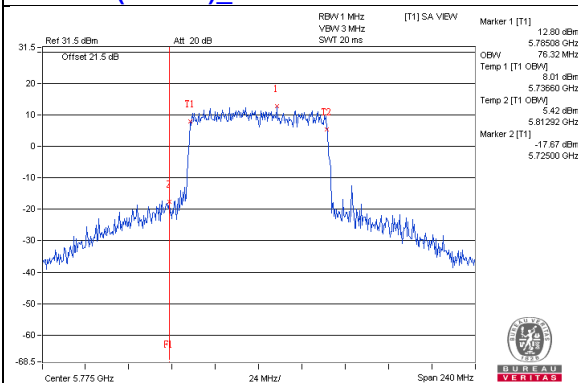

**802.11ac(VHT80)\_Chain1 / CH155**

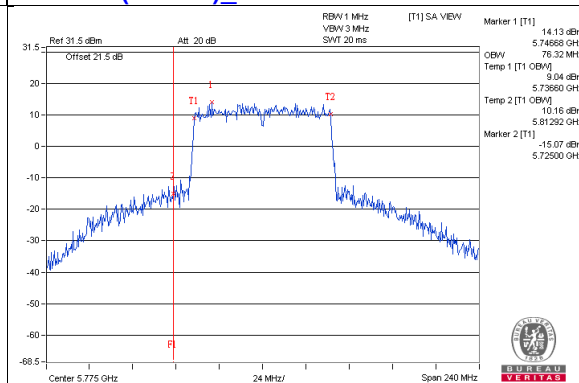

## 4.5 Peak Power Spectral Density Measurement

### 4.5.1 Limits of Peak Power Spectral Density Measurement

Operation Band	EUT Category		Limit
U-NII-1		Outdoor Access Point	17dBm/ MHz
		Fixed point-to-point Access Point	
	√	Indoor Access Point	
		Mobile and Portable client device	11dBm/ MHz
U-NII-2A	---		11dBm/ MHz
U-NII-2C	---		11dBm/ MHz
U-NII-3	√		30dBm/ 500kHz

### 4.5.2 Test Setup

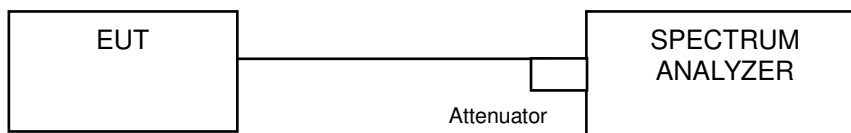

### 4.5.3 Test Instruments

Refer to section 4.1.2 to get information of above instrument.

#### 4.5.4 Test Procedure

##### **802.11a, 802.11ac (VHT20), 802.11ac (VHT40)**

##### **For U-NII-1:**

Using method SA-1

1. Set span to encompass the entire emission bandwidth (EBW) of the signal.
2. Set RBW = 1 MHz, Set VBW  $\geq$  3 MHz, Detector = RMS
3. Sweep time = auto, trigger set to "free run".
4. Trace average at least 100 traces in power averaging mode.
5. Record the max value

##### **For U-NII-3:**

1. Set span to encompass the entire emission bandwidth (EBW) of the signal.
2. Set RBW = 300 kHz, Set VBW  $\geq$  1 MHz, Detector = RMS
3. Use the peak marker function to determine the maximum power level in any 300 kHz band segment within the fundamental EBW.
4. Scale the observed power level to an equivalent value in 500 kHz by adjusting (reducing) the measured power by a bandwidth correction factor (BWCF) where  $BWCF = 10\log(500 \text{ kHz}/300\text{kHz})$
5. Sweep time = auto, trigger set to "free run".
6. Trace average at least 100 traces in power averaging mode.
7. Record the max value

##### **802.11ac (VHT80)**

##### **For U-NII-1:**

Using method SA-2

1. Set span to encompass the entire emission bandwidth (EBW) of the signal.
2. Set RBW = 1 MHz, Set VBW  $\geq$  3 MHz, Detector = RMS
3. Sweep time = auto, trigger set to "free run".
4. Trace average at least 100 traces in power averaging mode.
5. Record the max value and add 10 log (1/duty cycle)

##### **For U-NII-3:**

1. Set span to encompass the entire emission bandwidth (EBW) of the signal.
2. Set RBW = 300 kHz, Set VBW  $\geq$  1 MHz, Detector = RMS
3. Use the peak marker function to determine the maximum power level in any 300 kHz band segment within the fundamental EBW.
4. Scale the observed power level to an equivalent value in 500 kHz by adjusting (reducing) the measured power by a bandwidth correction factor (BWCF) where  $BWCF = 10\log(500 \text{ kHz}/300\text{kHz})$
5. Sweep time = auto, trigger set to "free run".
6. Trace average at least 100 traces in power averaging mode.
7. Record the max value and add 10 log (1/duty cycle)

#### 4.5.5 Deviation from Test Standard

No deviation.

#### 4.5.6 EUT Operating Condition

Same as Item 4.3.6.

#### 4.5.7 Test Results

##### For U-NII-1:

##### CDD Mode

##### 802.11a

Chan.	Chan. Freq. (MHz)	PSD (dBm/MHz)		Total Power Density (dBm/MHz)	MAX. Limit (dBm/MHz)	Pass / Fail
		Chain 0	Chain 1			
36	5180	8.95	9.38	12.18	17.00	Pass
40	5200	11.02	11.47	14.26	17.00	Pass
48	5240	10.65	11.15	13.92	17.00	Pass

**Note:** 1. Method a) of power density measurement of KDB 662911 is using for calculating total power density. Total power density is summing entire spectra across corresponding frequency bins on the various outputs by computer.

2. Directional gain =  $10 \log[(10^{G1/20} + 10^{G2/20})^2 / 2] = 4.27\text{dBi} < 6\text{dBi}$  so the power density limit shall not be reduced.

##### Beamforming Mode

##### 802.11ac (VHT20)

Chan.	Chan. Freq. (MHz)	PSD (dBm/MHz)		Total Power Density (dBm/MHz)	MAX. Limit (dBm/MHz)	Pass / Fail
		Chain 0	Chain 1			
36	5180	8.55	9.40	12.01	17.00	Pass
40	5200	10.28	11.14	13.74	17.00	Pass
48	5240	10.38	10.88	13.65	17.00	Pass

**Note:** 1. Method a) of power density measurement of KDB 662911 is using for calculating total power density. Total power density is summing entire spectra across corresponding frequency bins on the various outputs by computer.

2. Directional gain =  $10 \log[(10^{G1/20} + 10^{G2/20})^2 / 2] = 4.27\text{dBi} < 6\text{dBi}$  so the power density limit shall not be reduced.

##### 802.11ac (VHT40)

Chan.	Chan. Freq. (MHz)	PSD (dBm/MHz)		Total Power Density (dBm/MHz)	MAX. Limit (dBm/MHz)	Pass / Fail
		Chain 0	Chain 1			
38	5190	2.14	2.91	5.55	17.00	Pass
46	5230	7.61	8.57	11.13	17.00	Pass

**Note:** 1. Method a) of power density measurement of KDB 662911 is using for calculating total power density. Total power density is summing entire spectra across corresponding frequency bins on the various outputs by computer.

2. Directional gain =  $10 \log[(10^{G1/20} + 10^{G2/20})^2 / 2] = 4.27\text{dBi} < 6\text{dBi}$  so the power density limit shall not be reduced.

**802.11ac (VHT80)**

Chan.	Chan. Freq. (MHz)	PSD W/O Duty Factor (dBm/MHz)		Duty Factor (dB)	Total PSD With Duty Factor (dBm/MHz)	MAX. Limit (dBm/MHz)	Pass / Fail
		Chain 0	Chain 1				
42	5210	-2.25	-1.80	0.17	1.16	17.00	Pass

- Note:**
- Method a) of power density measurement of KDB 662911 is using for calculating total power density. Total power density is summing entire spectra across corresponding frequency bins on the various outputs by computer.
  - Directional gain =  $10 \log[(10^{G1/20} + 10^{G2/20})^2 / 2] = 4.27\text{dBi} < 6\text{dBi}$  so the power density limit shall not be reduced.
  - Refer to section 3.3 for duty cycle spectrum plot.

### Spectrum Plot of Worst Value

**802.11a\_Chain 1 / CH40**

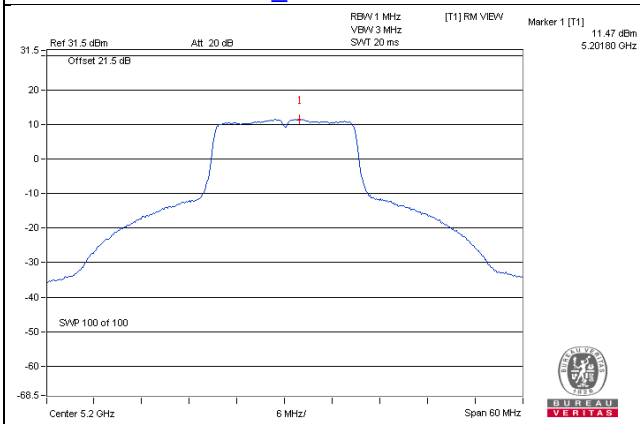

**802.11ac (VHT20)\_Chain 1 / CH40**

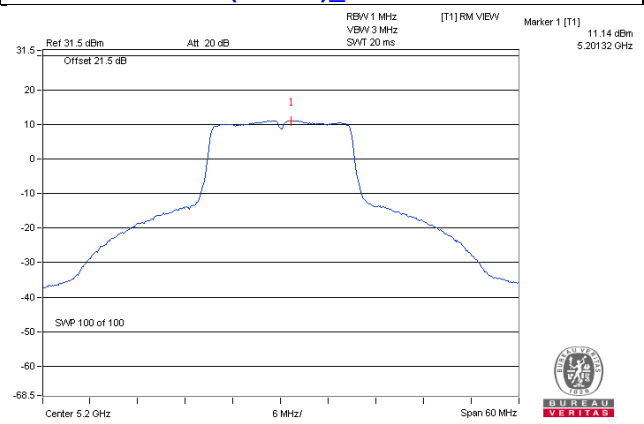

**802.11ac (VHT40)\_Chain 1 / CH46**

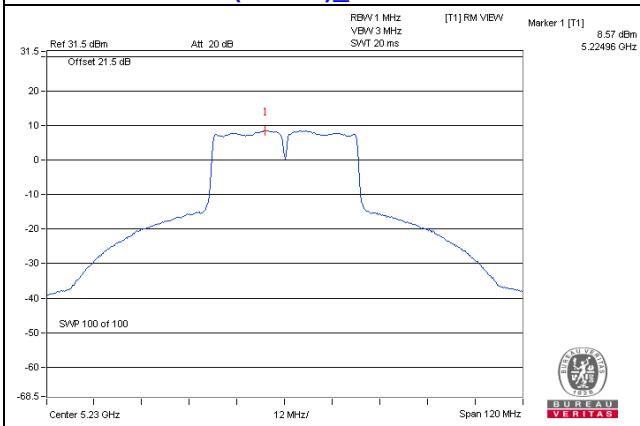

**802.11ac (VHT80)\_Chain 1 / CH42**

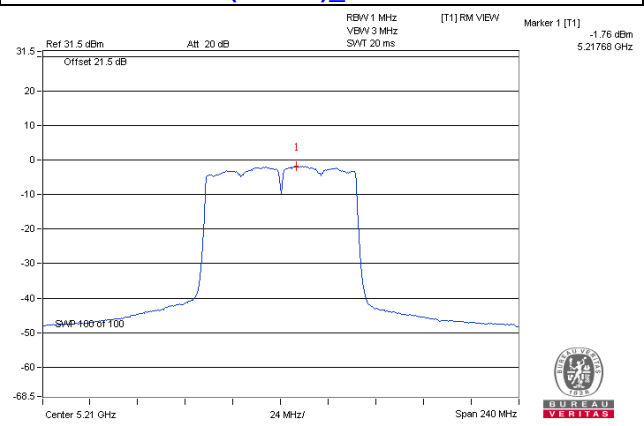

**For U-NII-3:**  
**CDD Mode**  
**802.11a**

TX chain	Channel	Freq. (MHz)	PSD (dBm/300kHz)	PSD (dBm/500kHz)	10 log (N=2) dB	Total PSD (dBm/500kHz)	Limit (dBm/500kHz)	Pass /Fail
0	149	5745	3.28	5.50	3.01	8.51	30.00	Pass
	157	5785	3.14	5.36	3.01	8.37	30.00	Pass
	165	5825	2.86	5.08	3.01	8.09	30.00	Pass
1	149	5745	4.87	7.09	3.01	10.10	30.00	Pass
	157	5785	4.58	6.80	3.01	9.81	30.00	Pass
	165	5825	4.22	6.44	3.01	9.45	30.00	Pass

Note: 1. Directional gain =  $10 \log[(10^{G1/20} + 10^{G2/20})^2 / 2] = 4.27\text{dBi} < 6\text{dBi}$  so the power density limit shall not be reduced.

**Beamforming Mode**  
**802.11ac (VHT20)**

TX chain	Channel	Freq. (MHz)	PSD (dBm/300kHz)	PSD (dBm/500kHz)	10 log (N=2) dB	Total PSD (dBm/500kHz)	Limit (dBm/500kHz)	Pass /Fail
0	149	5745	2.98	5.20	3.01	8.21	30.00	Pass
	157	5785	2.34	4.56	3.01	7.57	30.00	Pass
	165	5825	2.37	4.59	3.01	7.60	30.00	Pass
1	149	5745	5.16	7.38	3.01	10.39	30.00	Pass
	157	5785	4.50	6.72	3.01	9.73	30.00	Pass
	165	5825	4.10	6.32	3.01	9.33	30.00	Pass

Note: 1. Directional gain =  $10 \log[(10^{G1/20} + 10^{G2/20})^2 / 2] = 4.27\text{dBi} < 6\text{dBi}$  so the power density limit shall not be reduced.

**802.11ac (VHT40)**

TX chain	Channel	Freq. (MHz)	PSD (dBm/300kHz)	PSD (dBm/500kHz)	10 log (N=2) dB	Total PSD (dBm/500kHz)	Limit (dBm/500kHz)	Pass /Fail
0	151	5755	-0.76	1.46	3.01	4.47	30.00	Pass
	159	5795	-1.46	0.76	3.01	3.77	30.00	Pass
1	151	5755	1.11	3.33	3.01	6.34	30.00	Pass
	159	5795	0.52	2.74	3.01	5.75	30.00	Pass

Note: 1. Directional gain =  $10 \log[(10^{G1/20} + 10^{G2/20})^2 / 2] = 4.27\text{dBi} < 6\text{dBi}$  so the power density limit shall not be reduced.



### 802.11ac (VHT80)

TX chain	Chan.	Chan. Freq. (MHz)	PSD W/O Duty Factor		10 log (N=2) dB	Duty Factor (dB)	Total PSD With Duty Factor (dBm/500kHz)	Limit (dBm/500kHz)	Pass /Fail
			(dBm/300kHz)	(dBm/500kHz)					
0	155	5775	-6.22	-4.00	3.01	-0.82	30.00	-6.22	Pass
1	155	5775	-4.31	-2.09	3.01	1.09	30.00	-4.31	Pass

Note: 1. Directional gain =  $10 \log[(10^{G1/20} + 10^{G2/20})^2 / 2] = 4.27\text{dBi} < 6\text{dBi}$  so the power density limit shall not be reduced.

2. Refer to section 3.3 for duty cycle spectrum plot.

Spectrum Plot of Worst Value

802.11a – Chain 1: CH 149

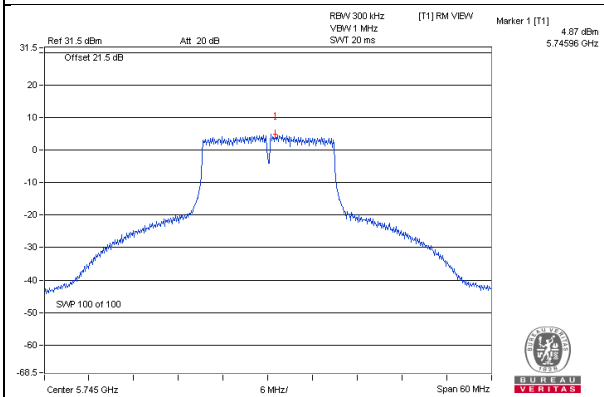

802.11ac (VHT20) – Chain 1: CH 149

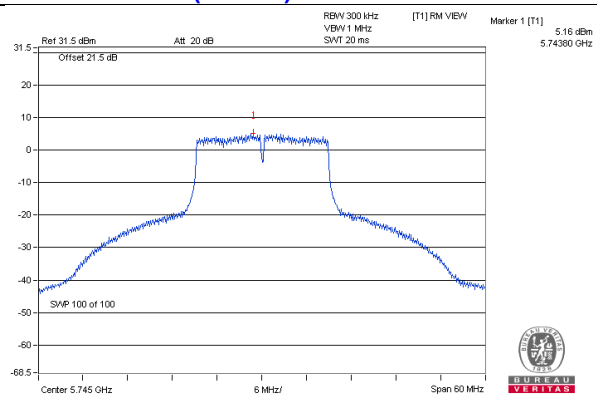

802.11ac (VHT40) – Chain 1: CH 151

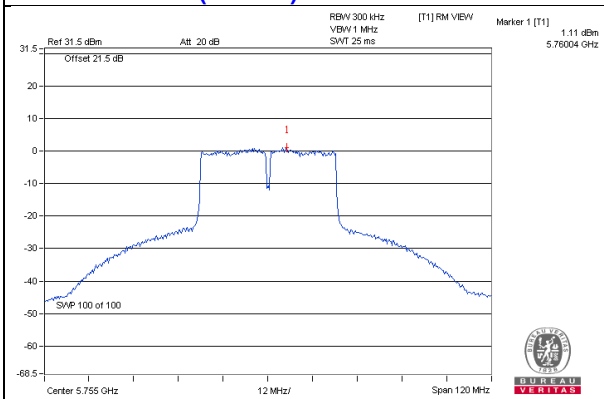

802.11ac (VHT80) – Chain 1: CH 155

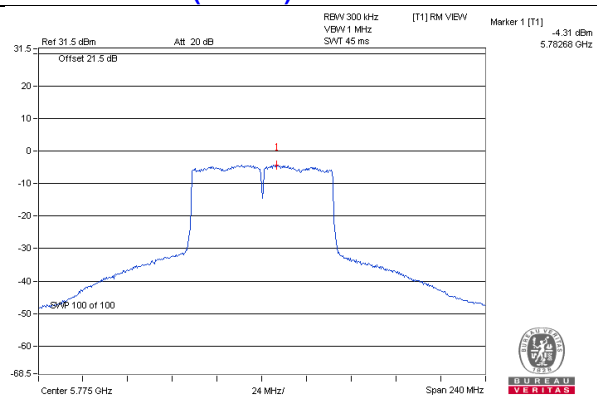

## 4.6 Frequency Stability Measurement

### 4.6.1 Limits of Frequency Stability Measurement

The frequency of the carrier signal shall be maintained within band of operation

### 4.6.2 Test Setup

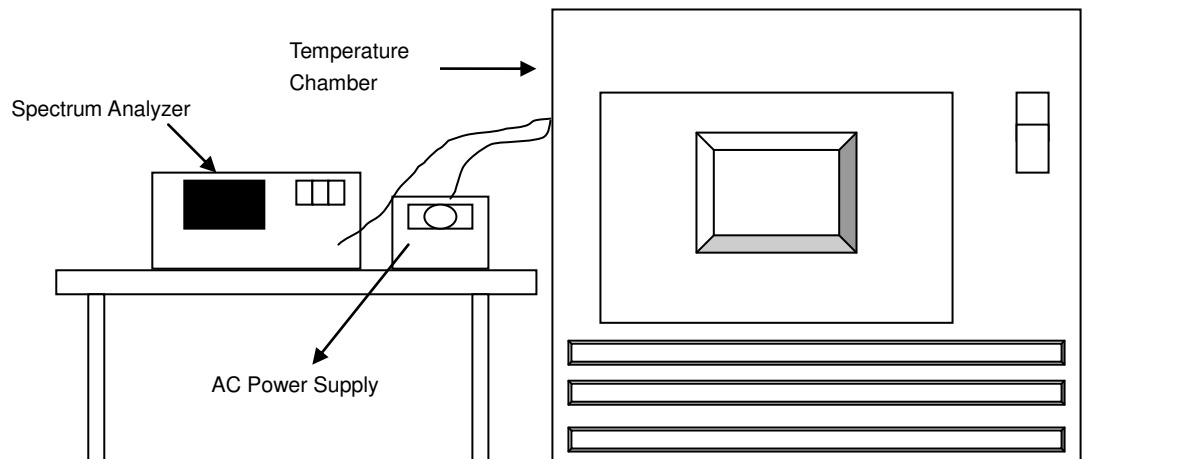

### 4.6.3 Test Instruments

Refer to section 4.1.2 to get information of above instrument.

### 4.6.4 Test Procedure

- The EUT was placed inside the environmental test chamber and powered by nominal AC voltage.
- Turn the EUT on and couple its output to a spectrum analyzer.
- Turn the EUT off and set the chamber to the highest temperature specified.
- Allow sufficient time (approximately 30 min) for the temperature of the chamber to stabilize, turn the EUT on and measure the operating frequency after 2, 5, and 10 Minutes.
- Repeat step 2 and 3 with the temperature chamber set to the lowest temperature.
- The test chamber was allowed to stabilize at +20 degree C for a minimum of 30 Minutes. The supply voltage was then adjusted on the EUT from 85% to 115% and the frequency record.

### 4.6.5 Deviation from Test Standard

No deviation.

### 4.6.6 EUT Operating Condition

Set the EUT transmit at un-modulation mode to test frequency stability.

## 4.6.7 Test Results

Frequency Stability Versus Temp.									
Operating Frequency: 5180 MHz									
TEMP. (°C)	Power Supply (Vac)	0 Minute		2 Minute		5 Minute		10 Minute	
		Measured Frequency (MHz)	Pass/Fail	Measured Frequency (MHz)	Pass/Fail	Measured Frequency (MHz)	Pass/Fail	Measured Frequency (MHz)	Pass/Fail
50	120	5180.0146	PASS	5180.013	PASS	5180.0136	PASS	5180.0153	PASS
40	120	5180.0225	PASS	5180.0248	PASS	5180.0235	PASS	5180.0231	PASS
30	120	5180.0101	PASS	5180.0125	PASS	5180.0084	PASS	5180.0102	PASS
20	120	5180.0019	PASS	5180.0014	PASS	5180.0028	PASS	5180.0037	PASS
10	120	5180.0081	PASS	5180.0081	PASS	5180.0051	PASS	5180.0088	PASS
0	120	5179.9759	PASS	5179.9747	PASS	5179.9746	PASS	5179.9777	PASS
-10	120	5179.9814	PASS	5179.9797	PASS	5179.9788	PASS	5179.982	PASS
-20	120	5179.996	PASS	5179.9964	PASS	5179.995	PASS	5179.9948	PASS
-30	120	5179.9739	PASS	5179.9743	PASS	5179.9779	PASS	5179.9745	PASS

Frequency Stability Versus Voltage									
Operating Frequency: 5180 MHz									
TEMP. (°C)	Power Supply (Vac)	0 Minute		2 Minute		5 Minute		10 Minute	
		Measured Frequency (MHz)	Pass/Fail	Measured Frequency (MHz)	Pass/Fail	Measured Frequency (MHz)	Pass/Fail	Measured Frequency (MHz)	Pass/Fail
20	138	5180.0017	PASS	5180.0017	PASS	5180.0035	PASS	5180.0036	PASS
	120	5180.0019	PASS	5180.0014	PASS	5180.0028	PASS	5180.0037	PASS
	102	5180.001	PASS	5180.0008	PASS	5180.0038	PASS	5180.0034	PASS

## 4.7 6dB Bandwidth Measurement

### 4.7.1 Limits of 6dB Bandwidth Measurement

The minimum of 6dB Bandwidth Measurement is 0.5MHz.

### 4.7.2 Test Setup

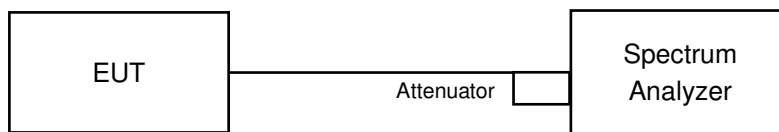

### 4.7.3 Test Instruments

Refer to section 4.1.2 to get information of above instrument.

### 4.7.4 Test Procedure

#### MEASUREMENT PROCEDURE REF

- a. Set resolution bandwidth (RBW) = 100kHz
- b. Set the video bandwidth (VBW)  $\geq 3 \times$  RBW, Detector = Peak.
- c. Trace mode = max hold.
- d. Sweep = auto couple.
- e. Measure the maximum width of the emission that is constrained by the frequencies associated with the two amplitude points (upper and lower) that are attenuated by 6 dB relative to the maximum level measured in the fundamental emission

### 4.7.5 Deviation from Test Standard

No deviation.

### 4.7.6 EUT Operating Condition

The software provided by client to enable the EUT under transmission condition continuously at lowest, middle and highest channel frequencies individually.

#### 4.7.7 Test Results

##### CDD Mode

###### 802.11a

Channel	Frequency (MHz)	6dB Bandwidth (MHz)		Minimum Limit (MHz)	Pass / Fail
		Chain 0	Chain 1		
149	5745	16.43	17.66	0.5	PASS
157	5785	16.42	17.65	0.5	PASS
165	5825	16.42	17.66	0.5	PASS

##### Beamforming Mode

###### 802.11ac (VHT20)

Channel	Frequency (MHz)	6dB Bandwidth (MHz)		Minimum Limit (MHz)	Pass / Fail
		Chain 0	Chain 1		
149	5745	17.68	17.65	0.5	PASS
157	5785	17.67	17.63	0.5	PASS
165	5825	17.68	17.65	0.5	PASS

###### 802.11ac (VHT40)

Channel	Frequency (MHz)	6dB Bandwidth (MHz)		Minimum Limit (MHz)	Pass / Fail
		Chain 0	Chain 1		
151	5755	36.40	36.19	0.5	PASS
159	5795	36.46	36.45	0.5	PASS

###### 802.11ac (VHT80)

Channel	Frequency (MHz)	6dB Bandwidth (MHz)		Minimum Limit (MHz)	Pass / Fail
		Chain 0	Chain 1		
155	5775	76.12	76.15	0.5	PASS

### Spectrum Plot of Worst Value

#### 802.11a\_Chain 0 / CH157

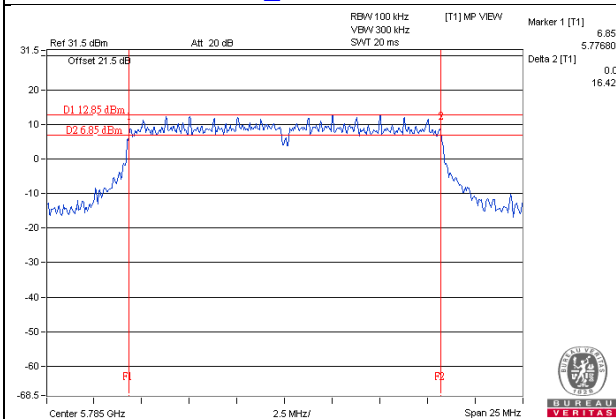

#### 802.11ac (VHT20)\_Chain 1 / CH157

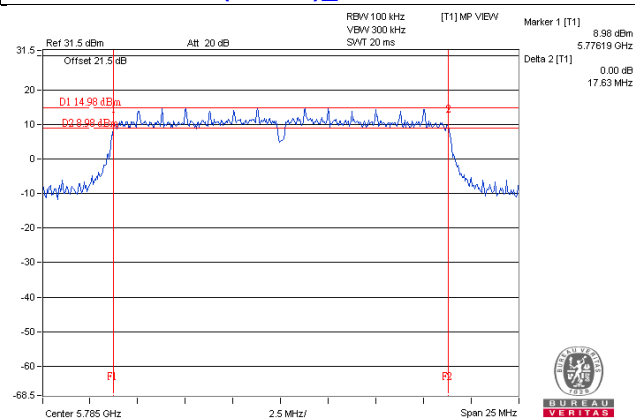

#### 802.11ac (VHT40)\_Chain 1 / CH151

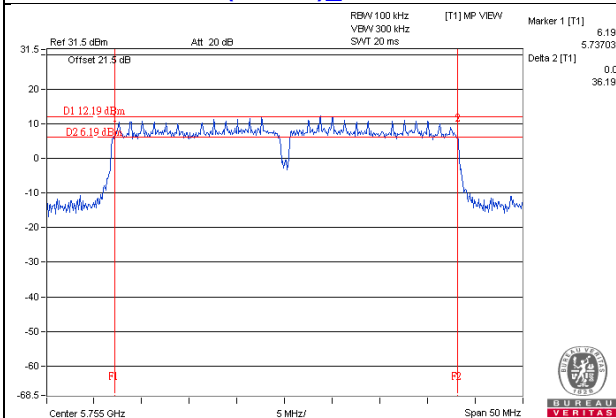

#### 802.11ac (VHT80)\_Chain 0 / CH155

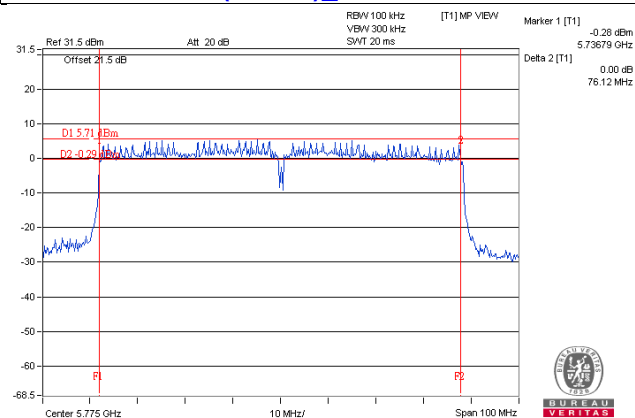

## 5 Pictures of Test Arrangements

Please refer to the attached file (Test Setup Photo).



### Annex A- Radiated Out of Band Emission (OOBE) Measurement (For U-NII-3 band)

802.11a

**CH 149 5745 MHz**

**Horizontal**

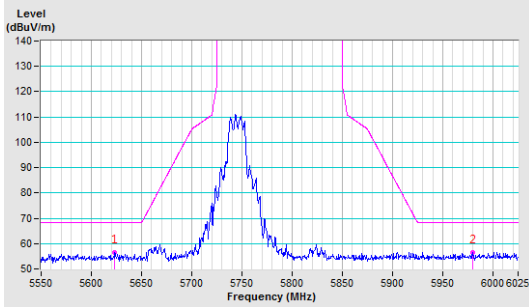

**Vertical**

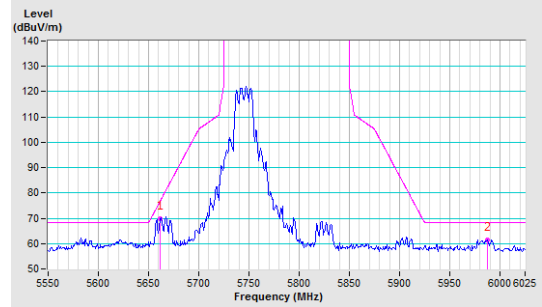

**CH 157 5785 MHz**

**Horizontal**

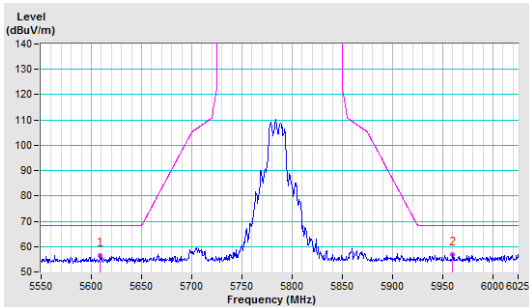

**Vertical**

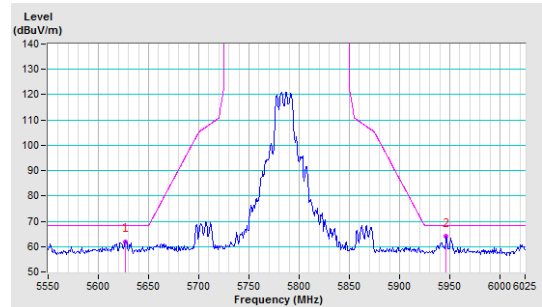

**CH 165 5825 MHz**

**Horizontal**

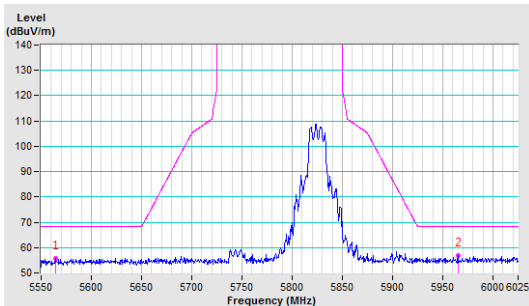

**Vertical**

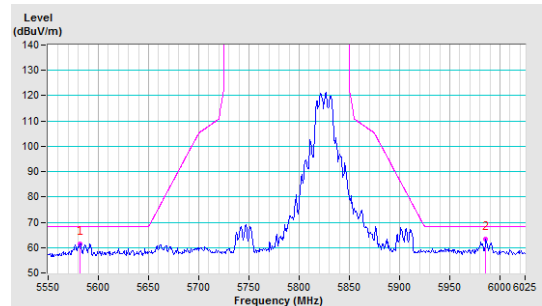

802.11ac (VHT20)

CH 149 5745 MHz

Horizontal

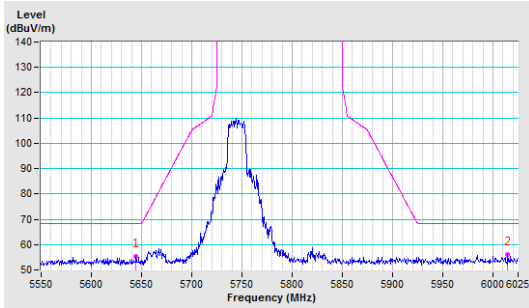

Vertical

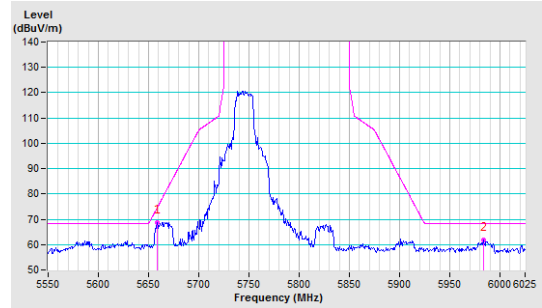

CH 157 5785 MHz

Horizontal

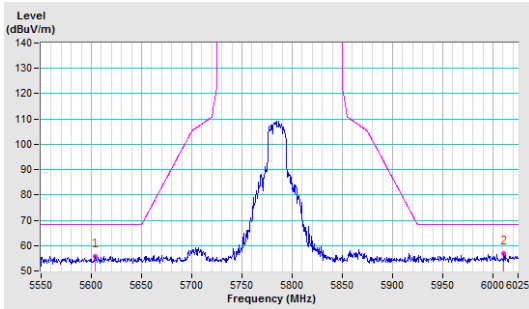

Vertical

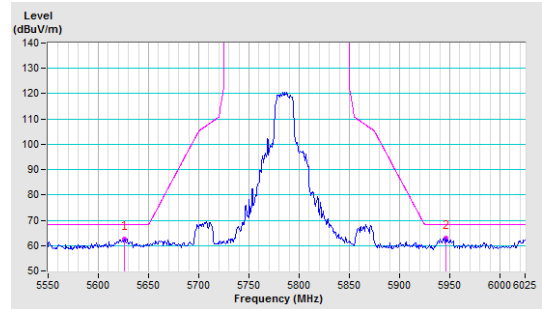

CH 165 5825 MHz

Horizontal

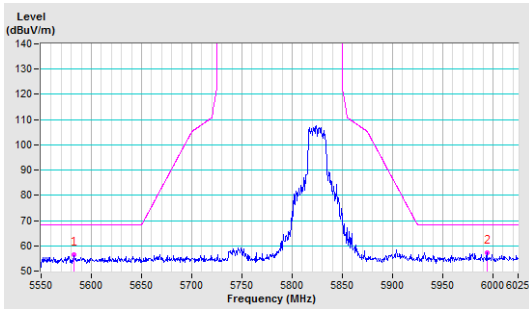

Vertical

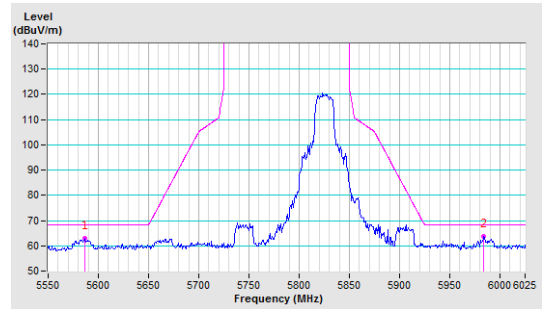

802.11ac (VHT40)

CH 151 5755 MHz

Horizontal

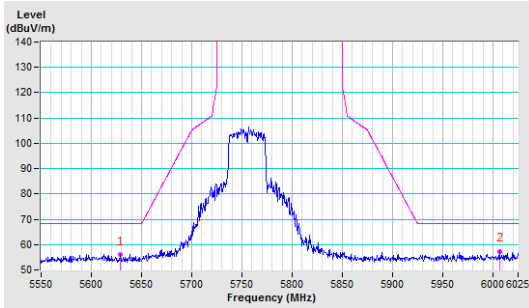

Vertical

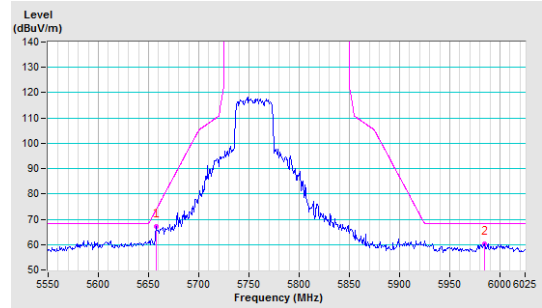

CH 159 5795 MHz

Horizontal

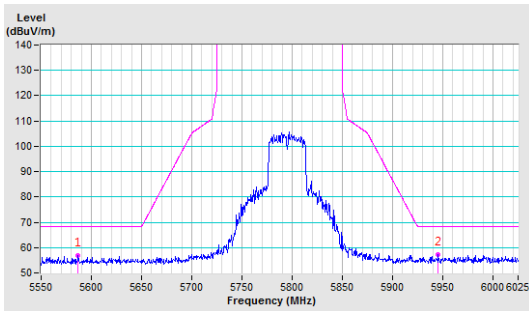

Vertical

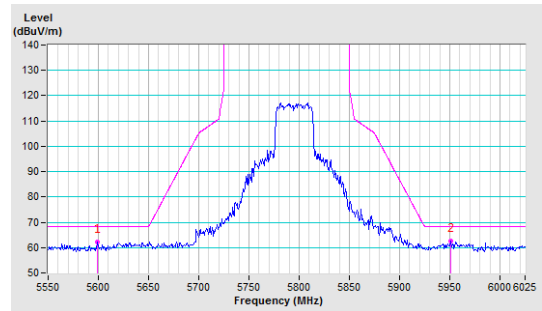

802.11ac (VHT80)

CH 155 5775 MHz

Horizontal

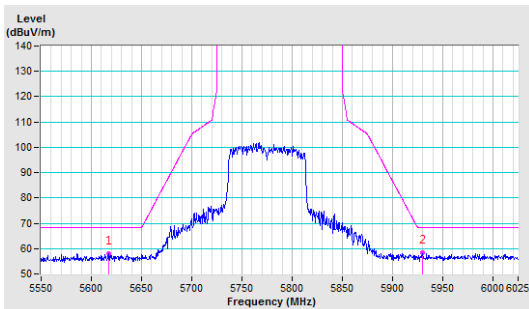

Vertical

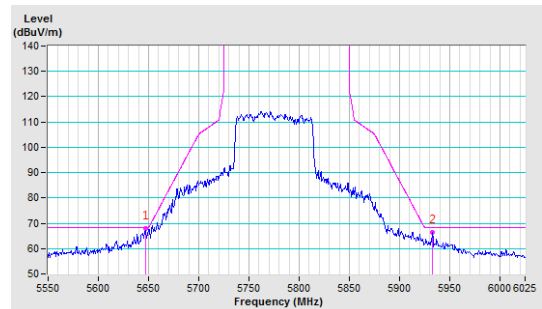

## Appendix – Information on the Testing Laboratories

We, Bureau Veritas Consumer Products Services (H.K.) Ltd., Taoyuan Branch, were founded in 1988 to provide our best service in EMC, Radio, Telecom and Safety consultation. Our laboratories are accredited and approved according to ISO/IEC 17025.

If you have any comments, please feel free to contact us at the following:

**Linko EMC/RF Lab**

Tel: 886-2-26052180

Fax: 886-2-26051924

**Hsin Chu EMC/RF/Telecom Lab**

Tel: 886-3-6668565

Fax: 886-3-6668323

**Hwa Ya EMC/RF/Safety Lab**

Tel: 886-3-3183232

Fax: 886-3-3270892

**Email:** [service.adt@tw.bureauveritas.com](mailto:service.adt@tw.bureauveritas.com)

**Web Site:** [www.bureauveritas-adt.com](http://www.bureauveritas-adt.com)

The address and road map of all our labs can be found in our web site also.

--- END ---