

FCC 47 CFR PART 15 SUBPART C RF Test Report

Applicant : Netgear Inc.
Applicant Address : 350 East Plumeria Drive, San Jose, CA 95134
Product Type : Mobile Hot Spot
Trade Name : NETGEAR
Model Number : AC791L
Applicable Standard : FCC 47 CFR PART 15 SUBPART C: Oct., 2014
ANSI C63.10-2009
Receive Date : Apr. 20, 2015
Test Period : May 05 ~ Jun. 24, 2015
Issue Date : Jun. 25, 2015

Issue by

A Test Lab Techno Corp.
No. 140-1, Changan Street, Bade City,
Taoyuan County 334, Taiwan R.O.C.
Tel : +886-3-2710188 / Fax : +886-3-2710190



Taiwan Accreditation Foundation accreditation number: 1330

Note: This report shall not be reproduced except in full, without the written approval of A Test Lab Techno Corp. This document may be altered or revised by A Test Lab Techno Corp. personnel only, and shall be noted in the revision section of the document. The client should not use it to claim product endorsement by TAF, or any government agencies. The test results in the report only apply to the tested sample.

Revision History

Rev.	Issue Date	Revisions	Revised By
00	Jun. 12, 2015	Initial Issue	
01	Jun. 25, 2015	Revised report information.	Peggy Chang

Verification of Compliance

Issued Date: 06/25/2015

Applicant : Netgear Inc.
Address Applicant : 350 East Plumeria Drive, San Jose, CA 95134
Product Type : Mobile Hot Spot
Trade Name : NETGEAR
Model Number : AC791L
FCC ID : PY3AC791L
EUT Rated Voltage : DC 5V, 1A
Test Voltage : 120 Vac / 60 Hz
Applicable Standard : FCC 47 CFR PART 15 SUBPART C: Oct., 2014
ANSI C63.10-2009
Test Result : Complied
Performing Lab. : A Test Lab Techno Corp.

No. 140-1, Changan Street, Bade City,
Taoyuan County 334, Taiwan R.O.C.
Tel : +886-3-2710188 / Fax : +886-3-2710190



Taiwan Accreditation Foundation accreditation number: 1330
<http://www.atl-lab.com.tw/e-index.htm>

A Test Lab Techno Corp. tested the above equipment in accordance with the requirements set forth in the above standards. All indications of Pass/Fail in this report are opinions expressed by A Test Lab Techno Corp. based on interpretations and/or observations of test results. Measurement Uncertainties were not taken into account and are published for informational purposes only. The test results show that the equipment tested is capable of demonstrating compliance with the requirements as documented in this report.

Approved By : Fly Lu Reviewed By : Eric Ou Yang
(Manager) (Fly Lu) (Testing Engineer) (Eric Ou Yang)

TABLE OF CONTENTS

1	General Information	6
2	EUT Description	7
3	Test Methodology	8
3.1.	Mode of Operation.....	8
3.2.	EUT Exercise Software	12
3.3.	Configuration of Test System Details	13
3.4.	Test Site Environment	13
4	Conducted Emission Measurement	14
4.1.	Limit	14
4.2.	Test Instruments	14
4.3.	Test Setup.....	14
4.4.	Test Procedure	15
4.5.	Test Result.....	16
5	Radiated Emission Measurement.....	18
5.1.	Limit	18
5.2.	Test Instruments	18
5.3.	Setup	19
5.4.	Test Procedure	20
5.5.	Test Result.....	22
6	Maximum Conducted Output Power Measurement.....	30
6.1.	Limit	30
6.2.	Test Setup.....	30
6.3.	Test Instruments	30
6.4.	Test Procedure	30
6.5.	Test Result.....	31
7	6dB RF Bandwidth Measurement.....	34
7.1.	Limit	34
7.2.	Test Setup.....	34
7.3.	Test Instruments	34
7.4.	Test Procedure	34
7.5.	Test Result.....	35
7.6.	Test Graphs	36
8	Maximum Power Density Measurement	42
8.1.	Limit	42
8.2.	Test Setup.....	42
8.3.	Test Instruments	42
8.4.	Test Procedure	42
8.5.	Test Result.....	43
8.6.	Test Graphs	44

9	Out of Band Conducted Emissions Measurement	50
9.1.	Limit	50
9.2.	Test Setup.....	50
9.3.	Test Instruments	50
9.4.	Test Procedure	50
9.5.	Test Graphs	51
10	Band Edges Measurement	69
10.1.	Limit	69
10.2.	Test Setup.....	69
10.3.	Test Instruments	69
10.4.	Test Procedure	70
10.5.	Test Result.....	71
11	Antenna Measurement.....	75
11.1.	Limit	75
11.2.	Antenna Connector Construction	75

1 General Information

1.1 Summary of Test Result

Standard	Item	Result	Remark
15.247			
15.207	AC Power Conducted Emission	PASS	----
----	99 % Occupied Bandwidth	PASS	----
Standard	Item	Result	Remark
15.247			
15.247(d)	Transmitter Radiated Emissions	PASS	----
15.247(b)(3)	Max. Output Power	PASS	----
15.247(a)(2)	6dB RF Bandwidth	PASS	----
15.247(e)	Power Spectral Density	PASS	----
15.247(d)	Out of Band Conducted Spurious Emission	PASS	----
15.247(d)	Band Edge Measurement	PASS	----
15.203	Antenna Requirement	PASS	----

The test results of this report relate only to the tested sample(s) identified in this report. Manufacturer or whom it may concern should recognize the pass or fail of the test result.

1.2 Measurement Uncertainty

Test Item	Frequency Range	Uncertainty (dB)	
Conducted Emission	9kHz ~ 30MHz	± 2.02	
Radiated Emission	30MHz ~ 1000MHz	Horizontal	± 3.98
		Vertical	± 3.62
	1000MHz ~ 18000MHz	Horizontal	± 3.11
		Vertical	± 3.07
	18000MHz ~ 40000MHz	Horizontal	± 3.66
		Vertical	± 3.54

2 EUT Description

Applicant	Netgear Inc.			
Applicant Address	350 East Plumeria Drive, San Jose, CA 95134			
Manufacturer	Netgear Inc.			
Manufacturer Address	350 East Plumeria Drive, San Jose, CA 95134			
Product Type	Mobile Hot Spot			
Trade Name	NETGEAR			
Model Number	AC791L			
FCC ID	PY3AC791L			
Operate Band	IEEE 802.11b / 802.11g / 802.11n 2.4GHz 20MHz & 40MHz			
Frequency Range	IEEE 802.11b / 802.11g / 802.11n 2.4GHz 20MHz: 2412 ~ 2462 MHz IEEE 802.11n 2.4GHz 40MHz: 2422 ~ 2452 MHz			
Modulation Type	IEEE 802.11b:DSSS IEEE 802.11g:DSSS + OFDM IEEE 802.11n 2.4GHz 20MHz: OFDM IEEE 802.11n 2.4GHz 40MHz: OFDM			
Antenna Delivery	IEEE 802.11b / g : 1TX + 1RX IEEE 802.11n 2.4GHz 20MHz / 40MHz : 2TX + 2RX			
Antenna Type	Internal IFA type			
Antenna Gain	1 dBi			
RF Output Power	IEEE 802.11b: 0.018 W / 12.61 dBm IEEE 802.11g: 0.048 W / 16.85 dBm IEEE 802.11n 2.4GHz 20MHz: 0.065 W / 18.13 dBm IEEE 802.11n 2.4GHz 40MHz: 0.065 W / 18.13 dBm			
Power adapter List				
Power adapter(1)	Trade Name	NETGEAR	Model Number	MU05BT050100-A1
	I/P: 100-240VAC, 50/60Hz, 0.15A O/P: 5VDC, 1A Cable out: Shielded, 1.0m, Detachable at Power Adapter			
Power adapter(2)	Trade Name	NETGEAR	Model Number	AD2038F20
	I/P: 100-240VAC, 50/60Hz, 0.13A O/P: 5VDC, 1A Cable out: Shielded, 1.0m, Detachable at Power Adapter			

3 Test Methodology

3.1. Mode of Operation

Decision of Test ATL has verified the construction and function in typical operation. All the test modes were carried out with the EUT in normal operation, which was shown in this test report and defined as:

Test Mode
Mode 1: Normal operation mode
Mode 2: IEEE 802.11b link mode
Mode 3: IEEE 802.11g link mode
Mode 4: IEEE 802.11n 2.4GHz 20MHz link mode
Mode 5: IEEE 802.11n 2.4GHz 40MHz link mode

Software used to control the EUT for staying in continuous transmitting mode was programmed.

After verification, all tests were carried out with the worst case test modes as shown below except radiated spurious emission below 1GHz and power line conducted emissions below 30MHz, which worst case was in normal link mode only.

The device used two models of adapter, adapter number: MU05BT050100-A1 is worst case to perform testing.

Test Mode	ANT-1	ANT-2	ANT-1+2
Mode 2: IEEE 802.11b link mode	V	V	--
Mode 3: IEEE 802.11g link mode	V	V	--
Mode 4: IEEE 802.11n 2.4GHz 20MHz link mode	V	V	V
Mode 5: IEEE 802.11n 2.4GHz 40MHz link mode	V	V	V

Test Mode	TX/RX Function	Test Channel	Data Rate
Mode 2: IEEE 802.11b link mode	1TX / 1RX	1, 6, 11	1
Mode 3: IEEE 802.11g link mode	1TX / 1RX	1, 6, 11	6
Mode 4: IEEE 802.11n 2.4GHz 20MHz link mode	2TX / 2RX	1, 6, 11	13
Mode 5: IEEE 802.11n 2.4GHz 40MHz link mode	2TX / 2RX	3, 6, 9	27

Duty cycle

Test Mode	Frequency (MHz)	on time (ms)	on+off time (ms)	Duty cycle (%)	Duty Factor (dB)	1/T Minimum VBW (kHz)
Mode 2: IEEE 802.11b link mode	2412.0	12.490	12.530	0.997	0.00	0.01
Mode 3: IEEE 802.11g link mode	2412.0	2.088	2.163	0.965	0.15	0.48
Mode 4: IEEE 802.11n 2.4GHz 20MHz link mode	2412.0	1.012	1.087	0.931	0.31	0.99
Mode 5: IEEE 802.11n 2.4GHz 40MHz link mode	2422.0	0.525	0.600	0.875	0.58	1.90

Duty Cycle Graphs

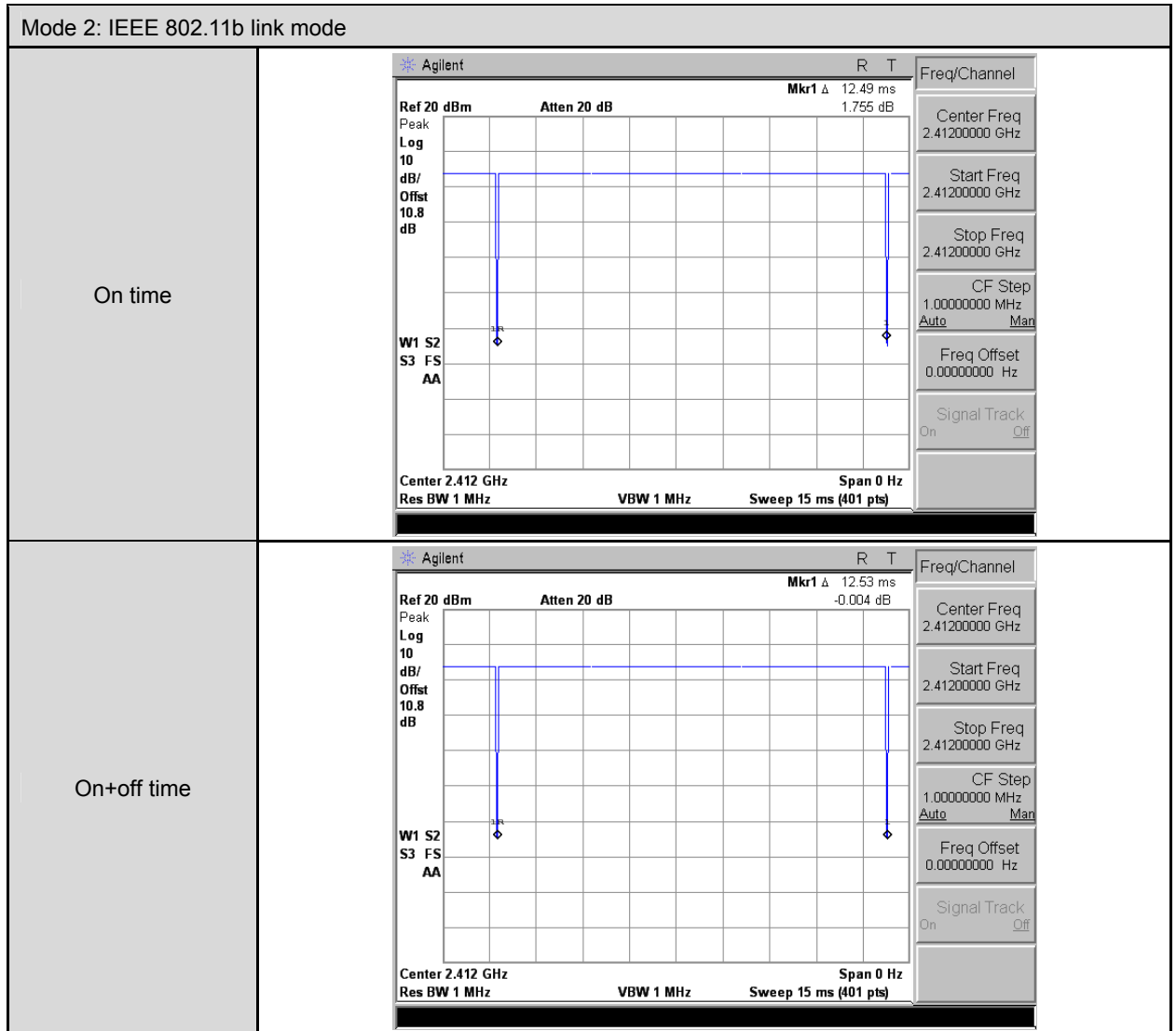

Mode 3: IEEE 802.11g Mode

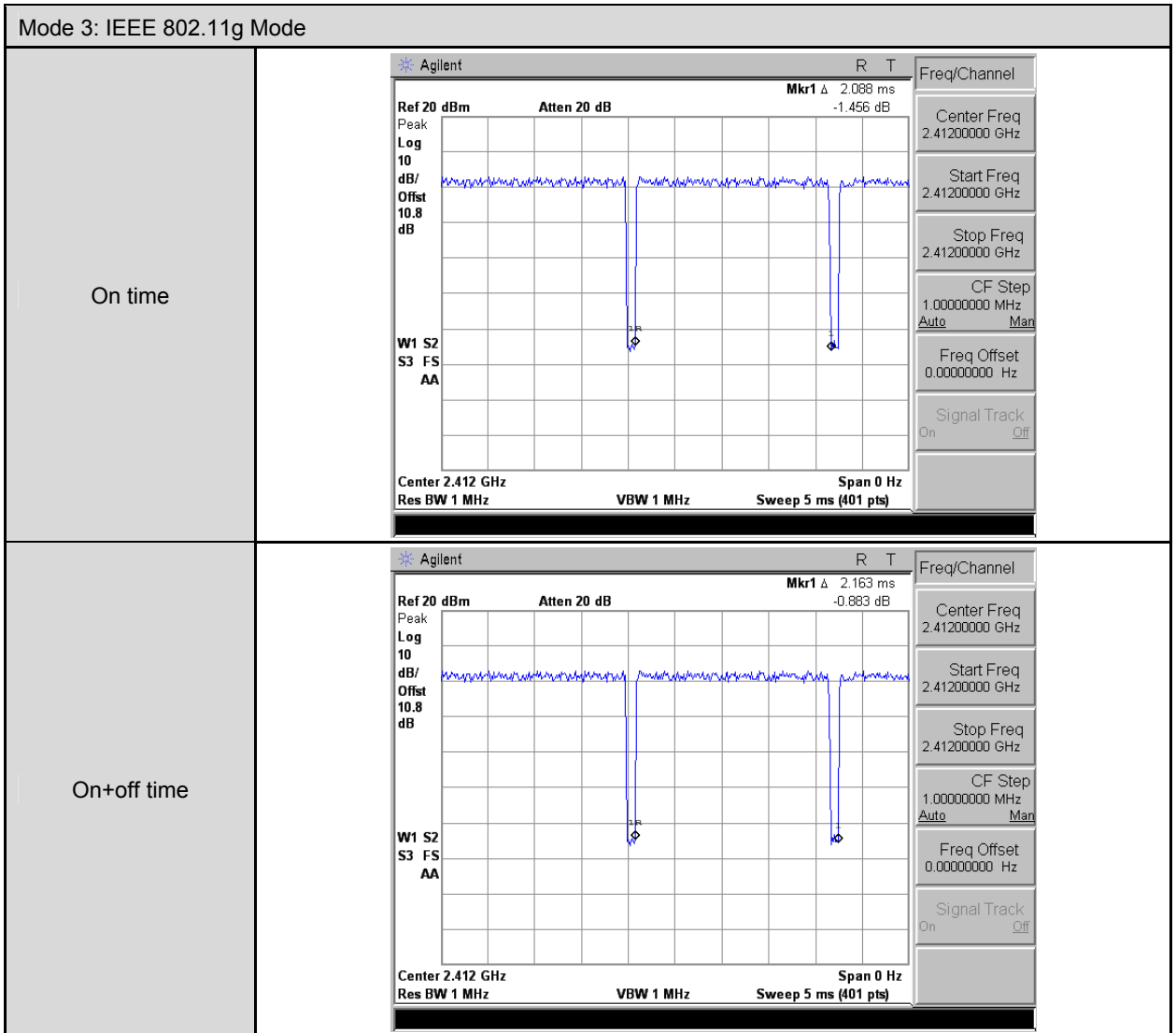

Mode 4: IEEE 802.11n 2.4GHz 20MHz Mode



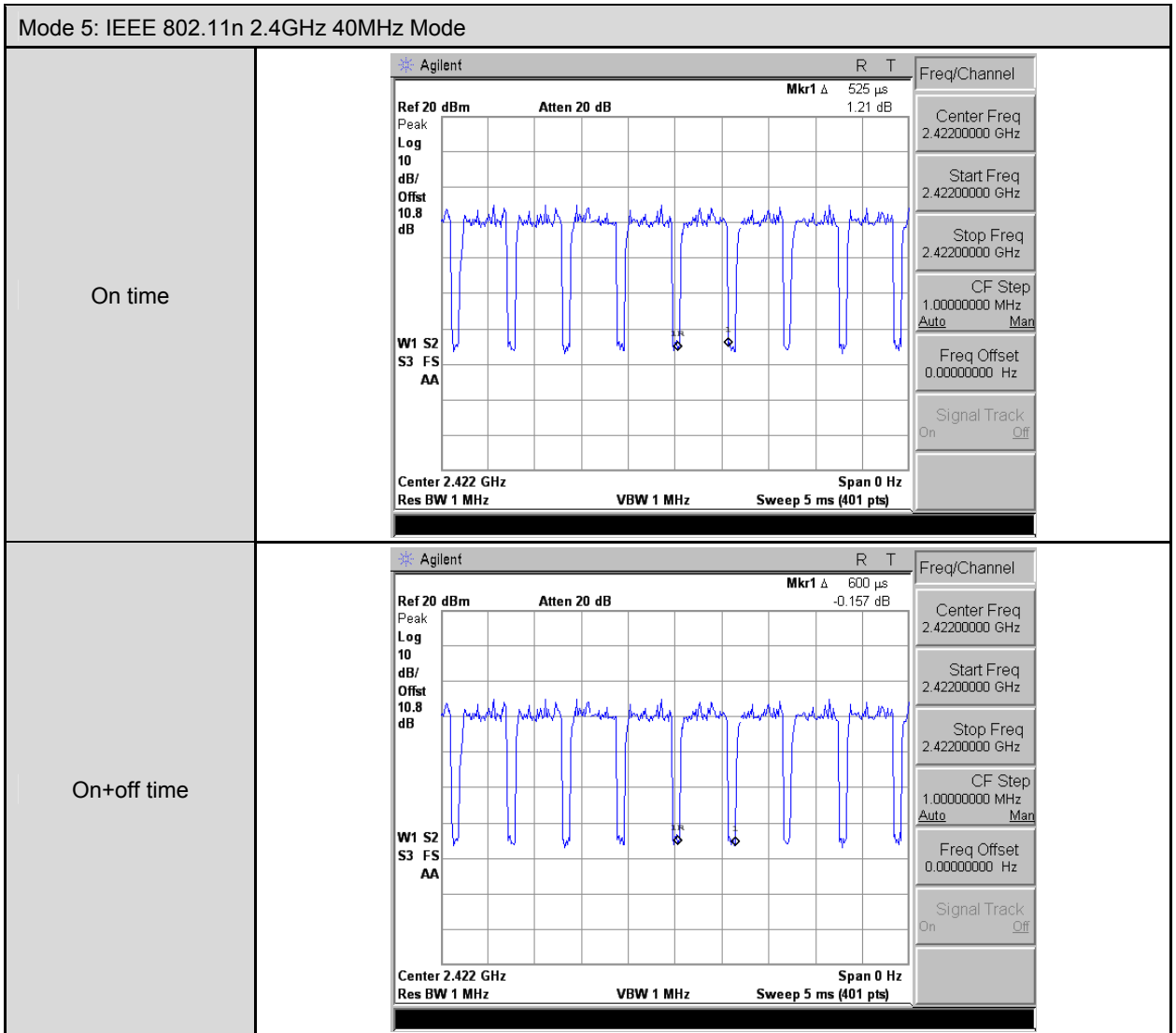

3.2. EUT Exercise Software

- | |
|--|
| 1. Setup the EUT shown on 3.3. |
| 2. Turn on the power of all equipment. |
| 3. Turn on Wi-Fi function. |
| 4. EUT run test program. |

3.3. Configuration of Test System Details

Conducted Emissions

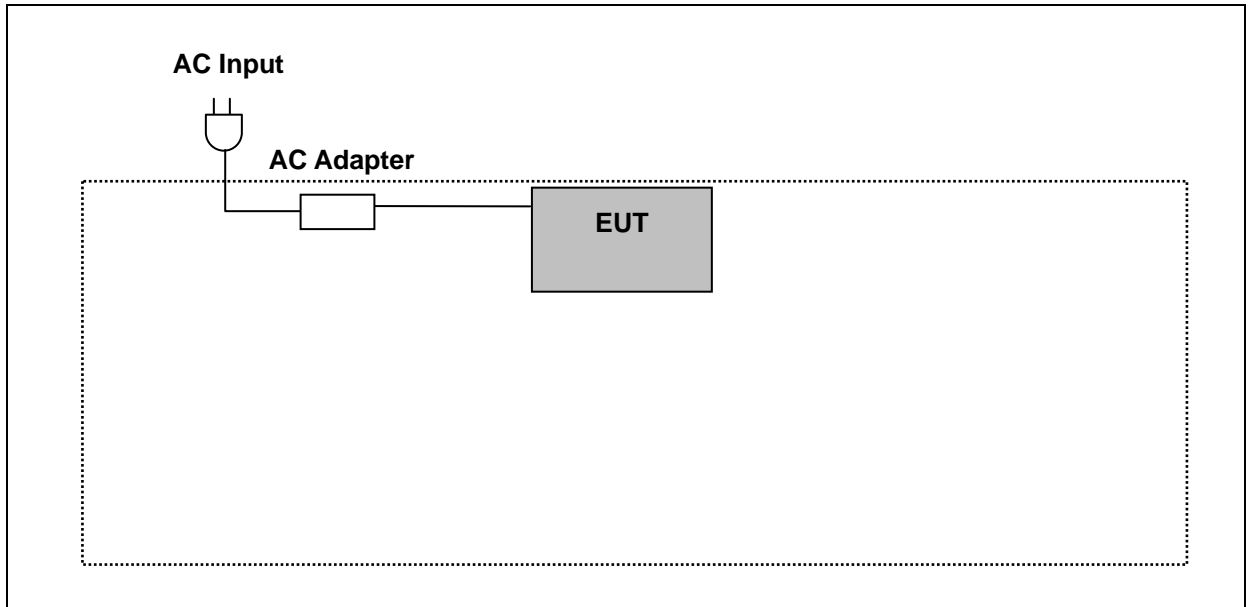

Radiated Emissions

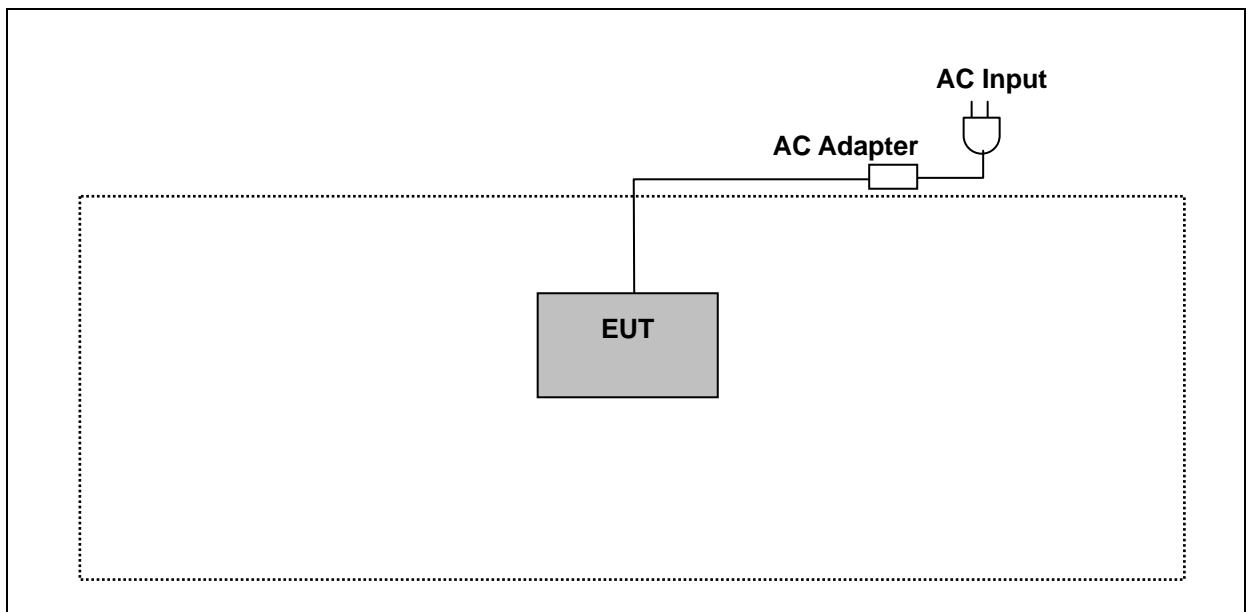

3.4. Test Site Environment

Items	Required (IEC 60068-1)	Actual
Temperature (°C)	15-35	26
Humidity (%RH)	25-75	60
Barometric pressure (mbar)	860-1060	950

4 Conducted Emission Measurement

4.1. Limit

Frequency (MHz)	Quasi-peak	Average
0.15 - 0.5	66 to 56	56 to 46
0.50 - 5.0	56	46
5.0 - 30.0	60	50

4.2. Test Instruments

Describe	Manufacturer	Model Number	Serial Number	Cal. Date	Remark
Test Receiver	R&S	ESCI	100367	06/12/2014	(1)
LISN	R&S	ENV216	101040	03/10/2015	(1)
LISN	R&S	ENV216	101041	03/06/2015	(1)
RF Cable	EMCI	RG 214/U	TE-02	06/30/2014	(1)
Test Site	ATL	TE02	TE02	N.C.R.	-----

Remark: (1) Calibration period 1 year. (2) Calibration period 2 years. (3) Calibration period 3 years.

Note: N.C.R. = No Calibration Request.

4.3. Test Setup

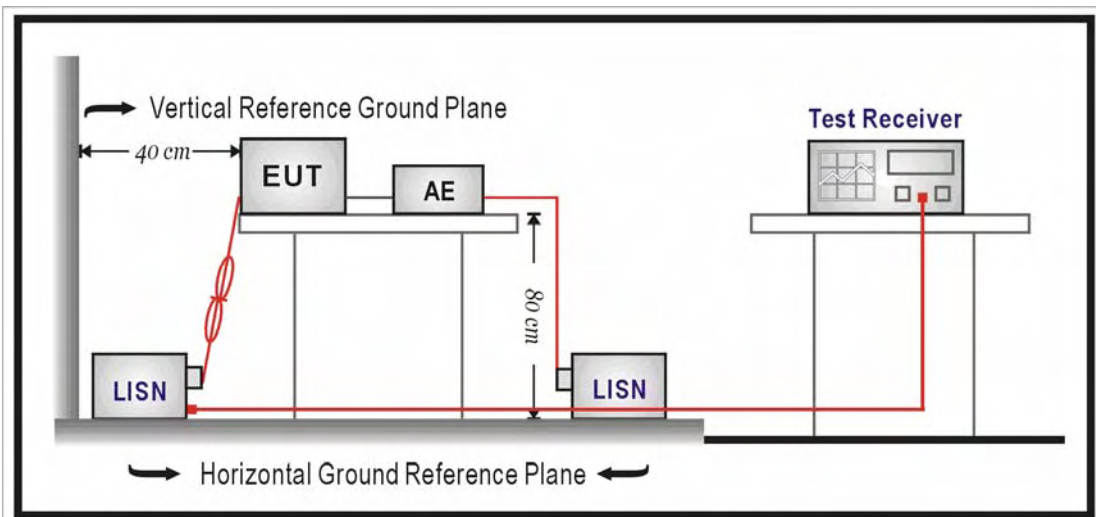

4.4. Test Procedure

The power line conducted emission measurements were performed in a shielded enclosure. The EUT was assembled on a wooden table which is 80 centimeters high, was placed 40 centimeters from the back wall and at least 1 meter from the sidewall.

Power was fed to the EUT from the public utility power grid through a line filter and EMCO Model 3162/2 SH Line Impedance Stabilization Networks (LISN). The LISN housing, measuring instrumentation case, ground plane, etc., were electrically bonded together at the same RF potential. The Spectrum analyzer was connected to the AC line through an isolation transformer. The 50-ohm output of the LISN was connected to the spectrum analyzer directly. Conducted emission levels were in the CISPR quasi-peak detection mode. The analyzer's 6 dB bandwidth was set to 9 KHz. No post-detector video filter was used.

The spectrum was scanned from 150 KHz to 30 MHz. The physical arrangement of the test system and associated cabling was varied (within the scope of arrangements likely to be encountered in actual use) to determine the effect on the unit's emanations in amplitude and frequency. All spurious emission frequencies were observed. The highest emission amplitudes relative to the appropriate limit were measured and have been recorded in paragraph 4.1.

4.5. Test Result

Standard:	FCC Part 15C	Line:	L1
Test item:	Conducted Emission	Power:	AC 120V/60Hz
Model Number:	AC791L	Temp.(°C)/Hum.(%RH):	26(°C)/60%RH
Mode:	Mode 1	Date:	05/05/2015
		Test By:	Eric Ou Yang
Description:		Adapter model:MU05BT050100-A1	

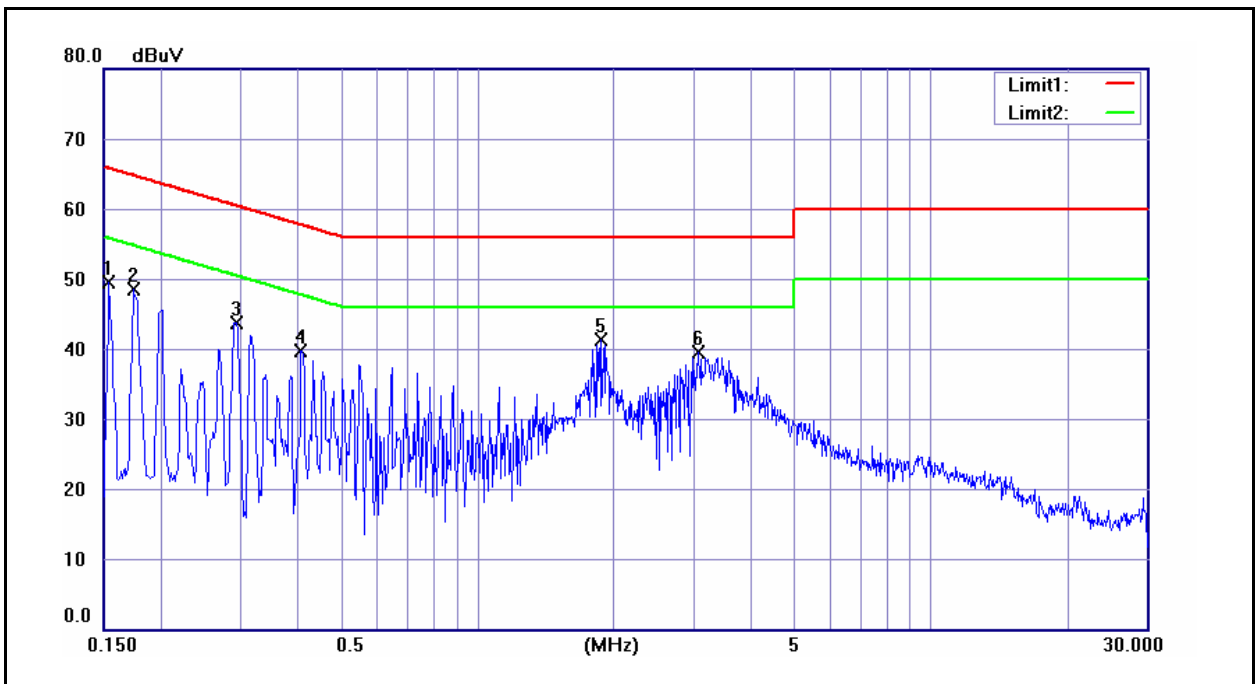

No.	Frequency (MHz)	QP reading (dBuV)	AVG reading (dBuV)	Correction factor (dB)	QP result (dBuV)	AVG result (dBuV)	QP limit (dBuV)	AVG limit (dBuV)	QP margin (dB)	AVG margin (dB)	Remark
1	0.1540	39.02	23.27	9.60	48.62	32.87	65.78	55.78	-17.16	-22.91	Pass
2	0.1740	39.50	26.18	9.60	49.10	35.78	64.77	54.77	-15.67	-18.99	Pass
3	0.2940	33.21	22.58	9.61	42.82	32.19	60.41	50.41	-17.59	-18.22	Pass
4	0.4100	26.62	16.37	9.61	36.23	25.98	57.65	47.65	-21.42	-21.67	Pass
5	1.8820	35.09	22.41	9.69	44.78	32.10	56.00	46.00	-11.22	-13.90	Pass
6	3.0780	23.95	10.46	9.74	33.69	20.20	56.00	46.00	-22.31	-25.80	Pass

Note: 1. Result (dBuV) = Correction factor (dB) + Reading(dBuV).

2. Correction factor (dB) = Cable loss (dB) + L.I.S.N. factor (dB).

Standard:	FCC Part 15C	Line:	N
Test item:	Conducted Emission	Power:	AC 120V/60Hz
Model Number:	AC791L	Temp.(°C)/Hum.(%RH):	26(°C)/60%RH
Mode:	Mode 1	Date:	05/05/2015
		Test By:	Eric Ou Yang
Description:		Adapter model:MU05BT050100-A1	

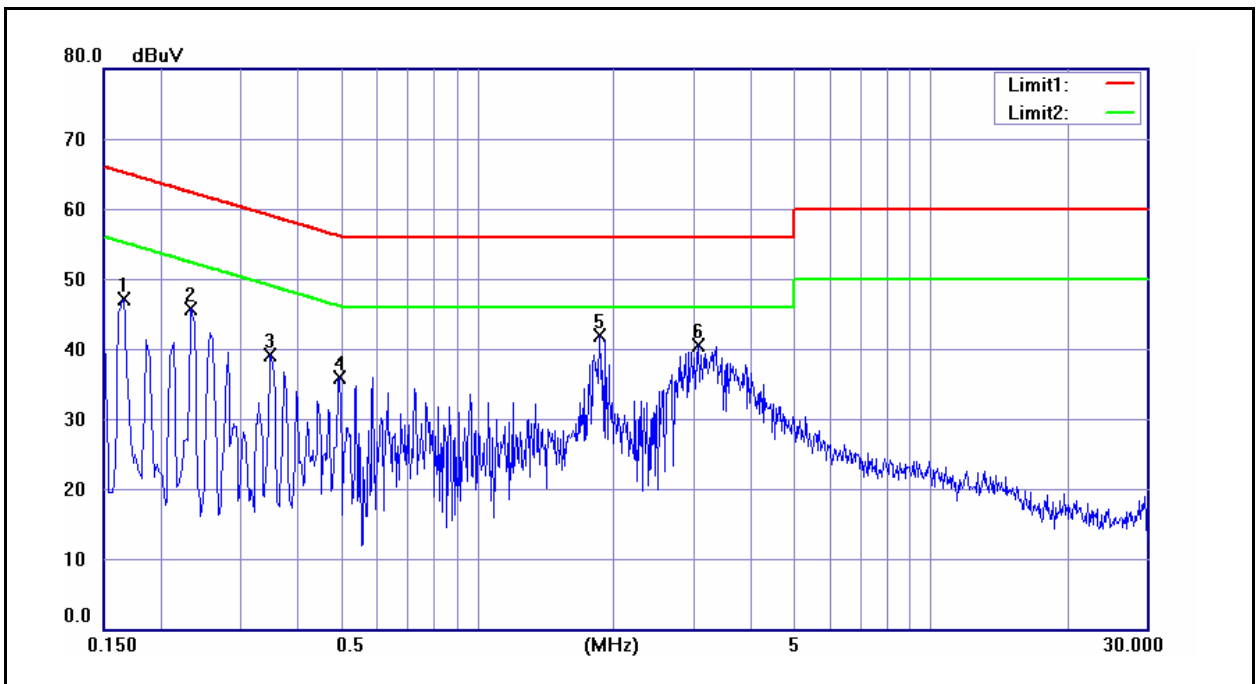

No.	Frequency (MHz)	QP reading (dBuV)	AVG reading (dBuV)	Correction factor (dB)	QP result (dBuV)	AVG result (dBuV)	QP limit (dBuV)	AVG limit (dBuV)	QP margin (dB)	AVG margin (dB)	Remark
1	0.1660	37.25	19.95	9.60	46.85	29.55	65.16	55.16	-18.31	-25.61	Pass
2	0.2340	35.03	22.64	9.60	44.63	32.24	62.31	52.31	-17.68	-20.07	Pass
3	0.3500	26.63	17.67	9.61	36.24	27.28	58.96	48.96	-22.72	-21.68	Pass
4	0.4980	23.00	12.93	9.62	32.62	22.55	56.03	46.03	-23.41	-23.48	Pass
5	1.8660	33.85	22.96	9.69	43.54	32.65	56.00	46.00	-12.46	-13.35	Pass
6	3.0900	28.30	12.44	9.76	38.06	22.20	56.00	46.00	-17.94	-23.80	Pass

Note: 1. Result (dBuV) = Correction factor (dB) + Reading(dBuV).

2. Correction factor (dB) = Cable loss (dB) + L.I.S.N. factor (dB).

5 Radiated Emission Measurement

5.1. Limit

According to §15.209(a), except as provided elsewhere in this subpart, the emissions from an intentional radiator shall not exceed the field strength levels specified in the following table:

Frequency (MHz)	Field Strength ($\mu\text{V}/\text{m}$ at meter)	Measurement Distance (meters)
0.009 – 0.490	2400 / F (kHz)	300
0.490 – 1.705	24000 / F (kHz)	30
1.705 – 30.0	30	30
30 - 88	100**	3
88-216	150**	3
216-960	200**	3
Above 960	500	3

** Except as provided in paragraph (g), fundamental emissions from intentional radiators operating under this Section shall not be located in the frequency bands 54-72 MHz, 76-88 MHz, 174-216 MHz or 470-806 MHz. However, operation within these frequency bands is permitted under other sections of this Part, e.g., Sections 15.231 and 15.241.

5.2. Test Instruments

3 Meter Chamber					
Equipment	Manufacturer	Model Number	Serial Number	Cal. Date	Remark
RF Pre-selector	Agilent	N9039A	MY46520256	01/06/2015	(1)
Spectrum Analyzer	Agilent	E4446A	MY46180578	01/06/2015	(1)
Pre Amplifier	Agilent	8449B	3008A02237	02/24/2015	(1)
Pre Amplifier	Agilent	8447D	2944A10961	02/24/2015	(1)
Broadband Antenna (30MHz~1GHz)	SCHWARZBECK MESS-ELEKTRONIK	VULB9163	9163-270	07/22/2014	(1)
Horn Antenna (1~18GHz)	SCHWARZBECK MESS-ELEKTRONIK	BBHA9120D	9120D-550	06/11/2014	(1)
Horn Antenna (18~40GHz)	SCHWARZBECK MESS-ELEKTRONIK	BBHA9170	9170-320	07/02/2014	(1)
Loop Antenna	COM-POWER CORPORATION	AL-130	121014	02/02/2015	(1)
Microwave Cable	EMCI	EMC-104-SM-S M-14000	140202	02/24/2015	(1)
Microwave Cable	EMCI	EMC104-SM-S M-600	140301	02/24/2015	(1)
Test Site	ATL	TE01	888001	08/28/2014	(1)

Remark: (1) Calibration period 1 year. (2) Calibration period 2 years. (3) Calibration period 3 years.

Note: N.C.R. = No Calibration Request.

5.3. Setup

9kHz ~ 30MHz

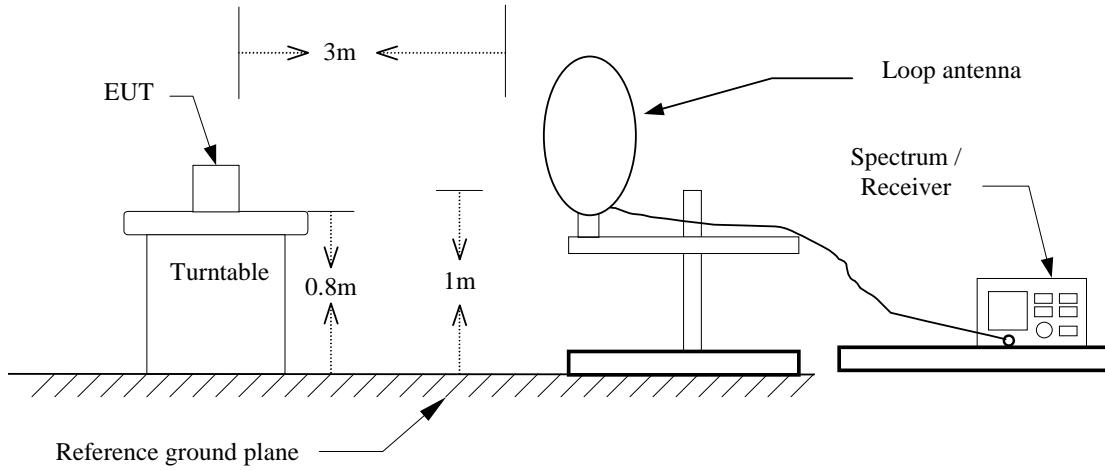

Below 1GHz

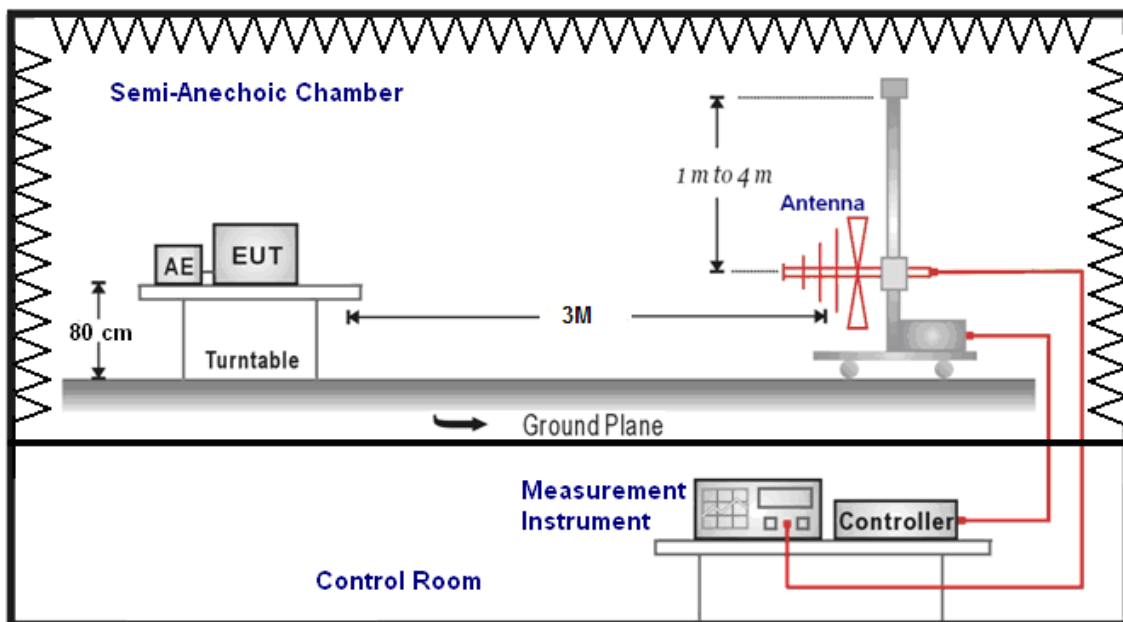

Above 1GHz

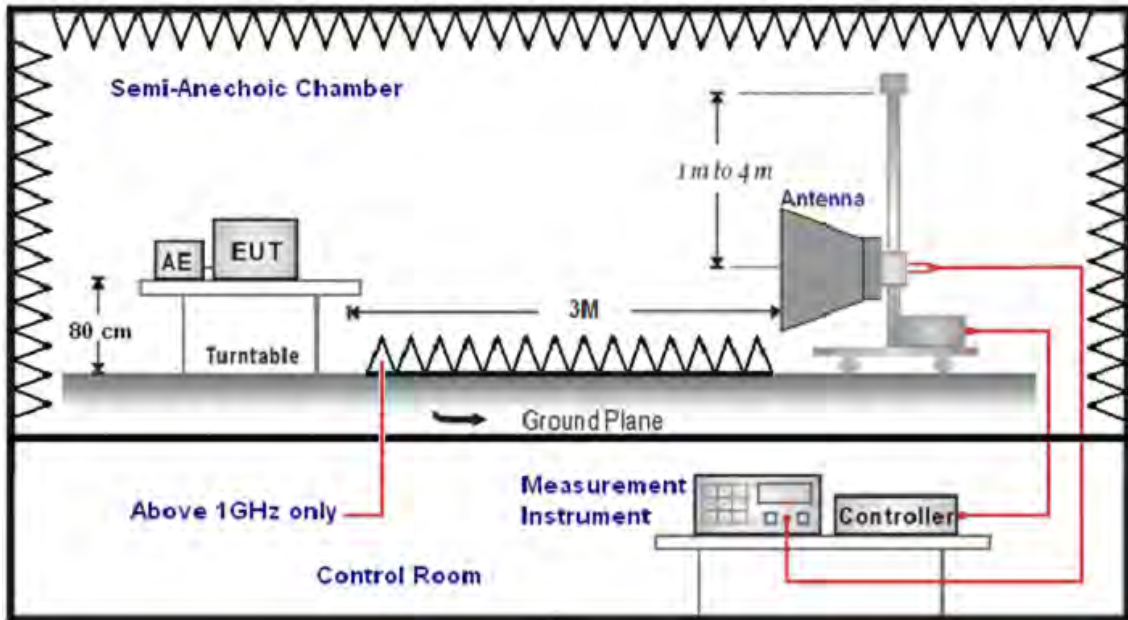

5.4. Test Procedure

Final radiation measurements were made on a three-meter, Semi Anechoic Chamber. The EUT system was placed on a nonconductive turntable which is 0.8 meters height, top surface 1.0 x 1.5 meter. The spectrum was examined from 250 MHz to 2.5 GHz in order to cover the whole spectrum below 10th harmonic which could generate from the EUT. During the test, EUT was set to transmit continuously & Measurements spectrum range from 9 kHz to 26.5 GHz is investigated.

For measurements below 1 GHz the resolution bandwidth is set to 100 kHz for peak detection measurements or 120 kHz for quasi-peak detection measurements. Peak detection is used unless otherwise noted as quasi-peak.

For measurements above 1 GHz the resolution bandwidth is set to 1 MHz, and then the video bandwidth is set to 1 MHz for peak measurements and 1/T for average measurements.

A nonconductive material surrounded the EUT to supporting the EUT for standing on three orthogonal planes. At each condition, the EUT was rotated 360 degrees, and the antenna was raised and lowered from one to four meters to find the maximum emission levels. Measurements were taken using both horizontal and vertical antenna polarization.

SCHWARZBECK MESS-ELEKTRONIK Biconilog Antenna (mode VULB9163) at 3 Meter and the SCHWARZBECK Double Ridged Guide Antenna (model BBHA9120D&9170) was used in frequencies 1 – 26.5 GHz at a distance of 1 meter. All test results were extrapolated to equivalent signal at 3 meters utilizing an inverse linear distance extrapolation Factor (20dB/decade).

For testing above 1GHz, the emission level of the EUT in peak mode was 20dB lower than average limit (that means the emission level in peak mode also complies with the limit in average mode), then testing will be stopped and peak values of EUT will be reported, otherwise, the emissions will be measured in average mode again and reported.

Appropriate preamplifiers were used for improving sensitivity and precautions were taken to avoid overloading or desensitizing the spectrum analyzer. No post – detector video filters were used in the test.

The spectrum analyzer's 6 dB bandwidth was set to 1 MHz, and the analyzer was operated in the peak detection mode, for frequencies both below and up 1 GHz. The average levels were obtained by subtracting the duty cycle correction factor from the peak readings.

The following procedures were used to convert the emission levels measured in decibels referenced to 1 microvolt (dBuV) into field intensity in micro volts pre meter (uV/m).

The actual field intensity in decibels referenced to 1 microvolt in to field intensity in micro volts per meter (dBuV/m).

The actual field intensity in decibels referenced to 1 microvolt per meter (dBuV/m) is determined by algebraically adding the measured reading in dBuV, the antenna factor (dB), and cable loss (dB) and Subtracting the gain of preamplifier (dB) is auto calculate in spectrum analyzer.

(1) $\text{Amplitude (dBuV/m)} = \text{FI (dBuV)} + \text{AF (dBuV)} + \text{CL (dBuV)} - \text{Gain (dB)}$

FI= Reading of the field intensity.

AF= Antenna factor.

CL= Cable loss.

P.S Amplitude is auto calculate in spectrum analyzer.

(2) $\text{Actual Amplitude (dBuV/m)} = \text{Amplitude (dBuV)} - \text{Dis (dB)}$

The FCC specified emission limits were calculated according the EUT operating frequency and by following linear interpolation equations:

(a) For fundamental frequency : Transmitter Output < +30dBm

(b) For spurious frequency : Spurious emission limits = fundamental emission limit /10

Data of measurement within this frequency range without mark in the table above means the reading of emissions are attenuated more than 20dB below the permissible limits or the field strength is too small to be measured.

5.5. Test Result

Below 1GHz

Standard:	FCC Part 15C	Test Distance:	3m
Test item:	Radiated Emission	Power:	AC 120V/60Hz
Model Number:	AC791L	Temp.(°C)/Hum.(%RH):	26(°C)/60%RH
Mode:	Mode 1	Date:	05/13/2015
		Test By:	Eric Ou Yang

Frequency (MHz)	Reading (dBuV)	Correct Factor (dB/m)	Result (dBuV/m)	Limit (dBuV/m)	Margin (dB)	Remark	Ant.Polar. H / V
194.0000	35.64	-13.42	22.22	43.50	-21.28	QP	H
306.0000	34.93	-9.30	25.63	46.00	-20.37	QP	H
436.0000	30.47	-6.60	23.87	46.00	-22.13	QP	H
570.5000	27.64	-3.94	23.70	46.00	-22.30	QP	H
672.0000	28.27	-2.06	26.21	46.00	-19.79	QP	H
878.0000	26.68	2.07	28.75	46.00	-17.25	QP	H
166.5000	28.37	-11.52	16.85	43.50	-26.65	QP	V
283.5000	26.39	-9.89	16.50	46.00	-29.50	QP	V
358.0000	27.40	-8.30	19.10	46.00	-26.90	QP	V
527.5000	26.68	-4.91	21.77	46.00	-24.23	QP	V
623.5000	27.21	-2.87	24.34	46.00	-21.66	QP	V
789.0000	26.60	0.29	26.89	46.00	-19.11	QP	V

Note: No emission found between lowest internal used/generated frequency to 30MHz (9kHz~30MHz).

Above 1GHz

Standard:	FCC Part 15C			Test Distance:	3m		
Test item:	Radiated Emission			Power:	AC 120V/60Hz		
Model Number:	AC791L			Temp.(°C)/Hum.(%RH):	26(°C)/60%RH		
Mode:	Mode 2			Date:	05/09/2015		
Frequency:	2412MHz			Test By:	Eric Ou Yang		
Frequency (MHz)	Reading (dBuV)	Correct Factor (dB/m)	Result (dBuV/m)	Limit (dBuV/m)	Margin (dB)	Remark	Ant.Polar. H / V
2953.000	38.03	1.55	39.58	74.00	-34.42	peak	H
4605.000	33.67	6.79	40.46	74.00	-33.54	peak	H
6663.000	34.05	11.94	45.99	74.00	-28.01	peak	H
3037.000	36.92	1.87	38.79	74.00	-35.21	peak	V
4619.000	33.59	6.83	40.42	74.00	-33.58	peak	V
6677.000	33.26	11.97	45.23	74.00	-28.77	peak	V

Standard:	FCC Part 15C			Test Distance:	3m		
Test item:	Radiated Emission			Power:	AC 120V/60Hz		
Model Number:	AC791L			Temp.(°C)/Hum.(%RH):	26(°C)/60%RH		
Mode:	Mode 2			Date:	05/09/2015		
Frequency:	2437MHz			Test By:	Eric Ou Yang		
Frequency (MHz)	Reading (dBuV)	Correct Factor (dB/m)	Result (dBuV/m)	Limit (dBuV/m)	Margin (dB)	Remark	Ant.Polar. H / V
3037.000	37.00	1.87	38.87	74.00	-35.13	peak	H
4633.000	33.04	6.88	39.92	74.00	-34.08	peak	H
6726.000	33.76	12.10	45.86	74.00	-28.14	peak	H
3009.000	36.32	1.75	38.07	74.00	-35.93	peak	V
4647.000	33.06	6.91	39.97	74.00	-34.03	peak	V
6663.000	33.86	11.94	45.80	74.00	-28.20	peak	V

Standard:	FCC Part 15C			Test Distance:	3m		
Test item:	Radiated Emission			Power:	AC 120V/60Hz		
Model Number:	AC791L			Temp.(°C)/Hum.(%RH):	26(°C)/60%RH		
Mode:	Mode 2			Date:	05/09/2015		
Frequency:	2462MHz			Test By:	Eric Ou Yang		
Frequency (MHz)	Reading (dBuV)	Correct Factor (dB/m)	Result (dBuV/m)	Limit (dBuV/m)	Margin (dB)	Remark	Ant.Polar. H / V
3009.000	36.46	1.75	38.21	74.00	-35.79	peak	H
4570.000	33.85	6.68	40.53	74.00	-33.47	peak	H
6677.000	34.15	11.97	46.12	74.00	-27.88	peak	H
3037.000	36.96	1.87	38.83	74.00	-35.17	peak	V
4626.000	33.62	6.85	40.47	74.00	-33.53	peak	V
6691.000	33.54	12.02	45.56	74.00	-28.44	peak	V

Standard:	FCC Part 15C			Test Distance:	3m		
Test item:	Radiated Emission			Power:	AC 120V/60Hz		
Model Number:	AC791L			Temp.(°C)/Hum.(%RH):	26(°C)/60%RH		
Mode:	Mode 3			Date:	05/09/2015		
Frequency:	2412MHz			Test By:	Eric Ou Yang		
Frequency (MHz)	Reading (dBuV)	Correct Factor (dB/m)	Result (dBuV/m)	Limit (dBuV/m)	Margin (dB)	Remark	Ant.Polar. H / V
3023.000	36.09	1.81	37.90	74.00	-36.10	peak	H
4619.000	34.10	6.83	40.93	74.00	-33.07	peak	H
6726.000	34.22	12.10	46.32	74.00	-27.68	peak	H
3023.000	37.05	1.81	38.86	74.00	-35.14	peak	V
4535.000	34.46	6.57	41.03	74.00	-32.97	peak	V
6670.000	34.09	11.96	46.05	74.00	-27.95	peak	V

Standard:	FCC Part 15C			Test Distance:	3m		
Test item:	Radiated Emission			Power:	AC 120V/60Hz		
Model Number:	AC791L			Temp.(°C)/Hum.(%RH):	26(°C)/60%RH		
Mode:	Mode 3			Date:	05/09/2015		
Frequency:	2437MHz			Test By:	Eric Ou Yang		
Frequency (MHz)	Reading (dBuV)	Correct Factor (dB/m)	Result (dBuV/m)	Limit (dBuV/m)	Margin (dB)	Remark	Ant.Polar. H / V
3023.000	37.20	1.81	39.01	74.00	-34.99	peak	H
4654.000	34.24	6.94	41.18	74.00	-32.82	peak	H
6698.000	33.94	12.03	45.97	74.00	-28.03	peak	H
2995.000	36.59	1.70	38.29	74.00	-35.71	peak	V
4647.000	33.59	6.91	40.50	74.00	-33.50	peak	V
6698.000	33.65	12.03	45.68	74.00	-28.32	peak	V

Standard:	FCC Part 15C			Test Distance:	3m		
Test item:	Radiated Emission			Power:	AC 120V/60Hz		
Model Number:	AC791L			Temp.(°C)/Hum.(%RH):	26(°C)/60%RH		
Mode:	Mode 3			Date:	05/09/2015		
Frequency:	2462MHz			Test By:	Eric Ou Yang		
Frequency (MHz)	Reading (dBuV)	Correct Factor (dB/m)	Result (dBuV/m)	Limit (dBuV/m)	Margin (dB)	Remark	Ant.Polar. H / V
3009.000	36.60	1.75	38.35	74.00	-35.65	peak	H
4605.000	33.95	6.79	40.74	74.00	-33.26	peak	H
6705.000	33.24	12.05	45.29	74.00	-28.71	peak	H
3023.000	37.62	1.81	39.43	74.00	-34.57	peak	V
4598.000	34.33	6.77	41.10	74.00	-32.90	peak	V
6691.000	34.66	12.02	46.68	74.00	-27.32	peak	V

Standard:	FCC Part 15C			Test Distance:	3m		
Test item:	Radiated Emission			Power:	AC 120V/60Hz		
Model Number:	AC791L			Temp.(°C)/Hum.(%RH):	26(°C)/60%RH		
Mode:	Mode 4			Date:	05/09/2015		
Frequency:	2412MHz			Test By:	Eric Ou Yang		
Frequency (MHz)	Reading (dBuV)	Correct Factor (dB/m)	Result (dBuV/m)	Limit (dBuV/m)	Margin (dB)	Remark	Ant.Polar. H / V
3030.000	37.78	1.85	39.63	74.00	-34.37	peak	H
4626.000	35.07	6.85	41.92	74.00	-32.08	peak	H
6698.000	34.42	12.03	46.45	74.00	-27.55	peak	H
2946.000	38.49	1.53	40.02	74.00	-33.98	peak	V
4633.000	34.62	6.88	41.50	74.00	-32.50	peak	V
6698.000	34.60	12.03	46.63	74.00	-27.37	peak	V

Standard:	FCC Part 15C			Test Distance:	3m		
Test item:	Radiated Emission			Power:	AC 120V/60Hz		
Model Number:	AC791L			Temp.(°C)/Hum.(%RH):	26(°C)/60%RH		
Mode:	Mode 4			Date:	05/09/2015		
Frequency:	2437MHz			Test By:	Eric Ou Yang		
Frequency (MHz)	Reading (dBuV)	Correct Factor (dB/m)	Result (dBuV/m)	Limit (dBuV/m)	Margin (dB)	Remark	Ant.Polar. H / V
3030.000	37.93	1.85	39.78	74.00	-34.22	peak	H
4605.000	34.64	6.79	41.43	74.00	-32.57	peak	H
6719.000	33.41	12.08	45.49	74.00	-28.51	peak	H
3030.000	37.49	1.85	39.34	74.00	-34.66	peak	V
4591.000	34.80	6.74	41.54	74.00	-32.46	peak	V
6719.000	34.47	12.08	46.55	74.00	-27.45	peak	V

Standard:	FCC Part 15C			Test Distance:	3m		
Test item:	Radiated Emission			Power:	AC 120V/60Hz		
Model Number:	AC791L			Temp.(°C)/Hum.(%RH):	26(°C)/60%RH		
Mode:	Mode 4			Date:	05/09/2015		
Frequency:	2462MHz			Test By:	Eric Ou Yang		
Frequency (MHz)	Reading (dBuV)	Correct Factor (dB/m)	Result (dBuV/m)	Limit (dBuV/m)	Margin (dB)	Remark	Ant.Polar. H / V
2974.000	37.72	1.62	39.34	74.00	-34.66	peak	H
4598.000	35.26	6.77	42.03	74.00	-31.97	peak	H
6733.000	34.24	12.11	46.35	74.00	-27.65	peak	H
3058.000	37.28	1.97	39.25	74.00	-34.75	peak	V
4626.000	34.22	6.85	41.07	74.00	-32.93	peak	V
6754.000	33.44	12.16	45.60	74.00	-28.40	peak	V

Standard:	FCC Part 15C			Test Distance:	3m		
Test item:	Radiated Emission			Power:	AC 120V/60Hz		
Model Number:	AC791L			Temp.(°C)/Hum.(%RH):	26(°C)/60%RH		
Mode:	Mode 5			Date:	05/09/2015		
Frequency:	2422MHz			Test By:	Eric Ou Yang		
Frequency (MHz)	Reading (dBuV)	Correct Factor (dB/m)	Result (dBuV/m)	Limit (dBuV/m)	Margin (dB)	Remark	Ant.Polar. H / V
3009.000	37.17	1.75	38.92	74.00	-35.08	peak	H
4598.000	34.67	6.77	41.44	74.00	-32.56	peak	H
6705.000	33.27	12.05	45.32	74.00	-28.68	peak	H
3051.000	38.92	1.94	40.86	74.00	-33.14	peak	V
4647.000	34.22	6.91	41.13	74.00	-32.87	peak	V
6691.000	34.85	12.02	46.87	74.00	-27.13	peak	V

Standard:	FCC Part 15C			Test Distance:	3m		
Test item:	Radiated Emission			Power:	AC 120V/60Hz		
Model Number:	AC791L			Temp.(°C)/Hum.(%RH):	26(°C)/60%RH		
Mode:	Mode 5			Date:	05/09/2015		
Frequency:	2437MHz			Test By:	Eric Ou Yang		
Frequency (MHz)	Reading (dBuV)	Correct Factor (dB/m)	Result (dBuV/m)	Limit (dBuV/m)	Margin (dB)	Remark	Ant.Polar. H / V
3023.000	39.24	1.81	41.05	74.00	-32.95	peak	H
4654.000	34.42	6.94	41.36	74.00	-32.64	peak	H
6705.000	33.70	12.05	45.75	74.00	-28.25	peak	H
3051.000	38.17	1.94	40.11	74.00	-33.89	peak	V
4577.000	34.08	6.69	40.77	74.00	-33.23	peak	V
6789.000	33.58	12.25	45.83	74.00	-28.17	peak	V

Standard:	FCC Part 15C			Test Distance:	3m		
Test item:	Radiated Emission			Power:	AC 120V/60Hz		
Model Number:	AC791L			Temp.(°C)/Hum.(%RH):	26(°C)/60%RH		
Mode:	Mode 5			Date:	05/09/2015		
Frequency:	2452MHz			Test By:	Eric Ou Yang		
Frequency (MHz)	Reading (dBuV)	Correct Factor (dB/m)	Result (dBuV/m)	Limit (dBuV/m)	Margin (dB)	Remark	Ant.Polar. H / V
3023.000	37.67	1.81	39.48	74.00	-34.52	peak	H
4591.000	34.66	6.74	41.40	74.00	-32.60	peak	H
6621.000	34.49	11.84	46.33	74.00	-27.67	peak	H
2974.000	37.16	1.62	38.78	74.00	-35.22	peak	V
4577.000	34.49	6.69	41.18	74.00	-32.82	peak	V
6677.000	33.34	11.97	45.31	74.00	-28.69	peak	V

Standard:	FCC Part 15C			Test Distance:	3m		
Test item:	Radiated Emission			Power:	AC 120V/60Hz		
Model Number:	AC791L			Temp.(°C)/Hum.(%RH):	26(°C)/60%RH		
Mode:	2.4GHz+5GHz			Date:	06/24/2015		
	Simultaneous Transmitting			Test By:	Eric Ou Yang		
Frequency (MHz)	Reading (dBuV)	Correct Factor (dB/m)	Result (dBuV/m)	Limit (dBuV/m)	Margin (dB)	Remark	Ant.Polar. H / V
2806.000	36.39	5.61	42.00	74.00	-32.00	peak	H
4577.000	32.85	9.87	42.72	74.00	-31.28	peak	H
7671.000	33.67	13.30	46.97	74.00	-27.03	peak	H
2813.000	34.10	5.62	39.72	74.00	-34.28	peak	V
4318.000	31.97	9.40	41.37	74.00	-32.63	peak	V
7650.000	31.80	13.27	45.07	74.00	-28.93	peak	V

6 Maximum Conducted Output Power Measurement

6.1. Limit

For systems using digital modulation in the 2400-2483.5MHz, the limit for maximum output power is 30dBm.

6.2. Test Setup

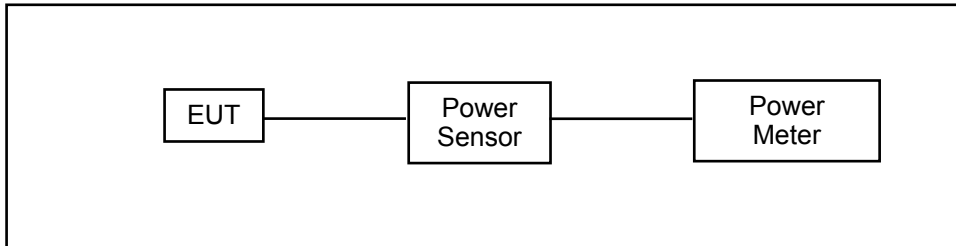

6.3. Test Instruments

Equipment	Manufacturer	Model Number	Serial Number	Cal. Date	Remark
Power Sensor	Anritsu	MA2411B	1126022	08/21/2014	(1)
Power Meter	Anritsu	ML2495A	1135009	08/21/2014	(1)
Test Site	ATL	TE05	TE05	N.C.R.	-----

Remark: (1) Calibration period 1 year. (2) Calibration period 2 years. (3) Calibration period 3 years.

Note: N.C.R. = No Calibration Request.

6.4. Test Procedure

The tests below are run with the EUT's transmitter set at high power in TX mode. The EUT is needed to force selection of output power level and channel number. While testing, EUT was set to transmit continuously. Remove the Subjective device's antenna and connect the RF output port to power sensor. The maximum output power shall not exceed 1 watt.

Use a direct connection between the antenna port of transmitter and the power sensor, for prevent the power sensor input attenuation 40-50 dB. Set the RBW Bandwidth of the emission or use a channel power meter mode.

For antennas with gains of 6 dBi or less, maximum allowed transmitter output is 1 watt (+30 dBm). For antennas with gains greater than 6 dBi, transmitter output level must be decreased by an amount equal to (GAIN - 6)/3 dBm.

The antenna port of the EUT was connected to the input of a power sensor. Power was read directly and cable loss correction was added to the reading to obtain power at the EUT antenna terminals.

6.5. Test Result

Model Number	AC791L									
Test Item	Maximum Conducted Output Power									
Test Mode	Mode 2: IEEE 802.11b link mode									
Date of Test	05/05/2015							Test Site		TE05
Frequency (MHz)	Data Rate	Average Output Power				Peak Output Power				Limit (dBm)
		ANT-1		ANT-2		ANT-1		ANT-2		
		(dBm)	(W)	(dBm)	(W)	(dBm)	(W)	(dBm)	(W)	
2412	1M	8.51	0.007	8.57	0.007	12.51	0.018	11.32	0.014	< 30
2437		9.77	0.009	7.95	0.006	12.38	0.017	10.51	0.011	< 30
2462		9.90	0.010	8.55	0.007	12.61	0.018	11.26	0.013	< 30
2437	2M	9.73	0.009	7.93	0.006	12.30	0.017	10.48	0.011	< 30
2437	5.5M	9.75	0.009	7.92	0.006	12.35	0.017	10.47	0.011	< 30
2437	11M	9.76	0.009	7.94	0.006	12.36	0.017	10.50	0.011	< 30

Model Number	AC791L									
Test Item	Maximum Conducted Output Power									
Test Mode	Mode 3: IEEE 802.11g link mode									
Date of Test	05/05/2015							Test Site		TE05
Frequency (MHz)	Data Rate	Average Output Power				Peak Output Power				Limit (dBm)
		ANT-1		ANT-2		ANT-1		ANT-2		
		(dBm)	(W)	(dBm)	(W)	(dBm)	(W)	(dBm)	(W)	
2412	6M	9.57	0.009	8.23	0.007	16.80	0.048	15.53	0.036	< 30
2437		9.70	0.009	7.91	0.006	16.85	0.048	14.86	0.031	< 30
2462		9.58	0.009	8.15	0.007	16.80	0.048	15.46	0.035	< 30
2437	9M	9.66	0.009	7.90	0.006	16.78	0.048	14.85	0.031	< 30
2437	12M	9.65	0.009	7.88	0.006	16.76	0.047	14.81	0.030	< 30
2437	18M	9.67	0.009	7.81	0.006	16.80	0.048	14.75	0.030	< 30
2437	24M	9.20	0.008	7.89	0.006	16.23	0.042	14.84	0.030	< 30
2437	36M	9.02	0.008	7.79	0.006	15.99	0.040	14.70	0.030	< 30
2437	48M	9.36	0.009	7.75	0.006	16.44	0.044	14.61	0.029	< 30
2437	54M	9.37	0.009	7.76	0.006	16.46	0.044	14.63	0.029	< 30

Model Number	AC791L										
Test Item	Maximum Conducted Output Power										
Test Mode	Mode 4: IEEE 802.11n 2.4GHz 20MHz link mode										
Date of Test	05/05/2015							Test Site		TE05	
Frequency (MHz)	Data Rate	Average Output Power				Peak Output Power				Limit (dBm)	
		ANT-1		ANT-2		ANT-1		ANT-2			
		(dBm)	(W)	(dBm)	(W)	(dBm)	(W)	(dBm)	(W)		
2412	13M	7.47	0.006	7.99	0.006	14.98	0.031	15.26	0.034	< 30	
2437		7.37	0.005	7.57	0.006	14.14	0.026	14.25	0.027	< 30	
2462		7.39	0.005	7.38	0.005	14.66	0.029	14.00	0.025	< 30	
2437	26M	7.16	0.005	7.29	0.005	13.84	0.024	13.82	0.024	< 30	
2437	39M	7.26	0.005	7.40	0.005	13.98	0.025	13.98	0.025	< 30	
2437	52M	6.94	0.005	7.29	0.005	13.58	0.023	13.84	0.024	< 30	
2437	78M	7.13	0.005	7.56	0.006	13.80	0.024	14.23	0.026	< 30	
2437	104M	7.17	0.005	7.54	0.006	13.85	0.024	14.20	0.026	< 30	
2437	117M	7.28	0.005	7.50	0.006	14.02	0.025	14.12	0.026	< 30	
2437	130M	7.32	0.005	7.45	0.006	14.09	0.026	14.05	0.025	< 30	

Model Number	AC791L										
Test Item	Maximum Conducted Output Power										
Test Mode	Mode 4: IEEE 802.11n 2.4GHz 20MHz link mode										
Date of Test	05/05/2015							Test Site		TE05	
Frequency (MHz)	Data Rate	Average Output Power				Peak Output Power				Limit (dBm)	
		ANT-1+2				ANT-1+2					
		(dBm)		(W)		(dBm)		(W)			
2412	13M	10.75		0.012		18.13		0.065		< 30	
2437		10.48		0.011		17.21		0.053		< 30	
2462		10.40		0.011		17.35		0.054		< 30	
2437	26M	10.24		0.011		16.84		0.048		< 30	
2437	39M	10.34		0.011		16.99		0.050		< 30	
2437	52M	10.13		0.010		16.72		0.047		< 30	
2437	78M	10.36		0.011		17.03		0.050		< 30	
2437	104M	10.37		0.011		17.04		0.051		< 30	
2437	117M	10.40		0.011		17.08		0.051		< 30	
2437	130M	10.40		0.011		17.08		0.051		< 30	

Model Number	AC791L									
Test Item	Maximum Conducted Output Power									
Test Mode	Mode 5: IEEE 802.11n 2.4GHz 40MHz link mode									
Date of Test	05/05/2015							Test Site		TE05
Frequency (MHz)	Data Rate	Average Output Power				Peak Output Power				Limit (dBm)
		ANT-1		ANT-2		ANT-1		ANT-2		
		(dBm)	(W)	(dBm)	(W)	(dBm)	(W)		(W)	
2422	27M	7.35	0.005	7.53	0.006	14.90	0.031	15.06	0.032	< 30
2437		7.88	0.006	8.04	0.006	15.16	0.033	15.08	0.032	< 30
2452		6.50	0.004	6.87	0.005	14.80	0.030	14.85	0.031	< 30
2437	54M	7.71	0.006	7.59	0.006	14.94	0.031	14.54	0.028	< 30
2437	81M	7.83	0.006	7.63	0.006	15.05	0.032	14.63	0.029	< 30
2437	108M	7.87	0.006	7.65	0.006	15.14	0.033	14.68	0.029	< 30
2437	162M	7.83	0.006	7.98	0.006	15.05	0.032	15.03	0.032	< 30
2437	216M	7.17	0.005	7.73	0.006	14.37	0.027	14.81	0.030	< 30
2437	243M	7.85	0.006	7.91	0.006	15.10	0.032	14.98	0.031	< 30
2437	270M	7.50	0.006	7.99	0.006	14.79	0.030	15.05	0.032	< 30

Model Number	AC791L									
Test Item	Maximum Conducted Output Power									
Test Mode	Mode 5: IEEE 802.11n 2.4GHz 40MHz link mode									
Date of Test	05/05/2015							Test Site		TE05
Frequency (MHz)	Data Rate	Average Output Power				Peak Output Power				Limit (dBm)
		ANT-1+2				ANT-1+2				
		(dBm)		(W)		(dBm)		(W)		
2422	27M	10.45		0.011		17.99		0.063		< 30
2437		10.97		0.013		18.13		0.065		< 30
2452		9.70		0.009		17.84		0.061		< 30
2437	54M	10.66		0.012		17.75		0.060		< 30
2437	81M	10.74		0.012		17.86		0.061		< 30
2437	108M	10.77		0.012		17.93		0.062		< 30
2437	162M	10.92		0.012		18.05		0.064		< 30
2437	216M	10.47		0.011		17.61		0.058		< 30
2437	243M	10.89		0.012		18.05		0.064		< 30
2437	270M	10.76		0.012		17.93		0.062		< 30

7 6dB RF Bandwidth Measurement

7.1. Limit

6dB RF Bandwidth: Systems using digital modulation techniques may operate in the 2400–2483.5 MHz bands. The minimum 6 dB band-width shall be at least 500 kHz.

7.2. Test Setup

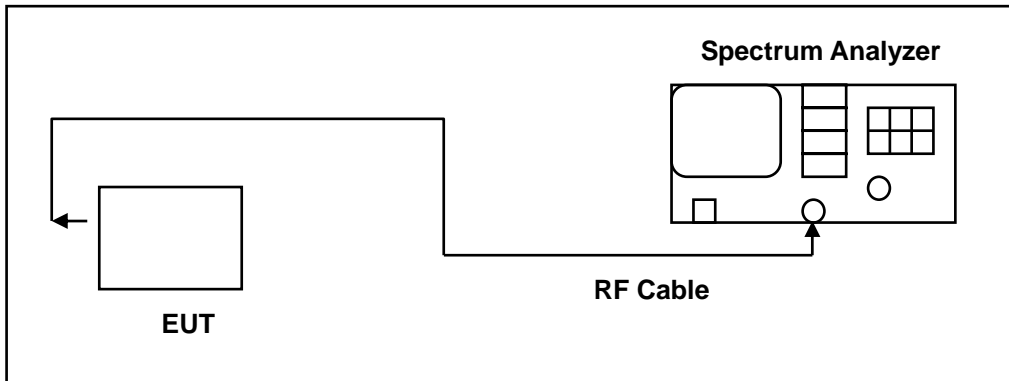

7.3. Test Instruments

Equipment	Manufacturer	Model Number	Serial Number	Cal. Date	Remark
Spectrum Analyzer	Agilent	E4445A	MY45300744	12/16/2014	(1)
Test Site	ATL	TE05	TE05	N.C.R.	-----

dRemark: (1) Calibration period 1 year. (2) Calibration period 2 years. (3) Calibration period 3 years.

Note: N.C.R. = No Calibration Request.

7.4. Test Procedure

The EUT tested to DTS test procedure of KDB558074D01 for compliance to FCC 47CFR 15.247 requirements.

6dB RF Bandwidth: The antenna port of the EUT was connected to the input of a spectrum analyzer. Analyzer RES BW was set to 100 kHz. For each RF output channel investigated, the spectrum analyzer center frequency was set to the channel carrier. A peak output reading was taken, a DISPLAY line was drawn 6 dB lower than peak level. The 6 dB bandwidth was determined from where the channel output spectrum intersected the display line.

The test was performed at 3 channels (Channel low, middle, high)

99 % Occupied Bandwidth: The transmitter shall be operated at its maximum carrier power measured under normal test conditions.

The video bandwidth shall be set to 3 times the resolution bandwidth. Video averaging is not permitted. Where practical, a sampling detector shall be used since a peak or, peak hold, may produce a wider bandwidth than actual.

The trace data points are recovered and are directly summed in linear terms. The recovered amplitude data points, beginning at the lowest frequency, are placed in a running sum until 0.5% of the total is reached and that frequency recorded. The process is repeated for the highest frequency data points. This frequency is recorded.

7.5. Test Result

Model Number	AC791L			
Test Item	6dB RF Bandwidth			
Test Mode	Mode 2: IEEE 802.11b link mode Mode 3: IEEE 802.11g link mode Mode 4: IEEE 802.11n 2.4GHz 20MHz link mode Mode 5: IEEE 802.11n 2.4GHz 40MHz link mode			
Date of Test	05/06/2015		Test Site	TE05
Test Mode	Frequency (MHz)	Measurement (MHz)		Limit (MHz)
		ANT-1	ANT-2	
Mode 2	2412	7.182	---	> 0.500
	2437	8.106	---	> 0.500
	2462	7.174	---	> 0.500
Mode 3	2412	14.107	---	> 0.500
	2437	15.513	---	> 0.500
	2462	13.177	---	> 0.500
Mode 4	2412	15.188	14.003	> 0.500
	2437	16.036	15.963	> 0.500
	2462	15.289	15.129	> 0.500
Mode 5	2422	35.118	32.634	> 0.500
	2437	35.696	35.502	> 0.500
	2452	27.592	27.604	> 0.500

7.6. Test Graphs

Mode 2: IEEE 802.11b link mode_ANT-1	
2412	
2437	
2462	

Mode 3: IEEE 802.11g link mode_ANT-1	
2412	<p>Agilent R T</p> <p>Ch Freq 2.412 GHz Trig Free</p> <p>Occupied Bandwidth</p> <p>Ref 20 dBm Atten 20 dB</p> <p>#Peak Log 10 dB/Offset 10.8 dB</p> <p>Center 2.412 GHz Span 30 MHz</p> <p>#Res BW 100 kHz #VBW 300 kHz Sweep 4 ms (401 pts)</p> <p>Occupied Bandwidth 16.0976 MHz</p> <p>Occ BW % Pwr 99.00 % x dB -6.00 dB</p> <p>Transmit Freq Error -59.550 kHz x dB Bandwidth 14.107 MHz</p> <p>Freq/Channel</p> <p>Center Freq 2.41200000 GHz</p> <p>Start Freq 2.39700000 GHz</p> <p>Stop Freq 2.42700000 GHz</p> <p>CF Step 3.00000000 MHz Auto Man</p> <p>Freq Offset 0.00000000 Hz</p> <p>Signal Track On Off</p>
2437	<p>Agilent R T</p> <p>Ch Freq 2.437 GHz Trig Free</p> <p>Occupied Bandwidth</p> <p>Ref 20 dBm Atten 20 dB</p> <p>#Peak Log 10 dB/Offset 10.8 dB</p> <p>Center 2.437 GHz Span 30 MHz</p> <p>#Res BW 100 kHz #VBW 300 kHz Sweep 4 ms (401 pts)</p> <p>Occupied Bandwidth 16.2362 MHz</p> <p>Occ BW % Pwr 99.00 % x dB -6.00 dB</p> <p>Transmit Freq Error 42.062 kHz x dB Bandwidth 15.513 MHz</p> <p>Freq/Channel</p> <p>Center Freq 2.43700000 GHz</p> <p>Start Freq 2.42200000 GHz</p> <p>Stop Freq 2.45200000 GHz</p> <p>CF Step 3.00000000 MHz Auto Man</p> <p>Freq Offset 0.00000000 Hz</p> <p>Signal Track On Off</p>
2462	<p>Agilent R T</p> <p>Ch Freq 2.462 GHz Trig Free</p> <p>Occupied Bandwidth</p> <p>Ref 20 dBm Atten 20 dB</p> <p>#Peak Log 10 dB/Offset 10.8 dB</p> <p>Center 2.462 GHz Span 30 MHz</p> <p>#Res BW 100 kHz #VBW 300 kHz Sweep 4 ms (401 pts)</p> <p>Occupied Bandwidth 16.0861 MHz</p> <p>Occ BW % Pwr 99.00 % x dB -6.00 dB</p> <p>Transmit Freq Error -76.481 kHz x dB Bandwidth 13.177 MHz</p> <p>Freq/Channel</p> <p>Center Freq 2.46200000 GHz</p> <p>Start Freq 2.44700000 GHz</p> <p>Stop Freq 2.47700000 GHz</p> <p>CF Step 3.00000000 MHz Auto Man</p> <p>Freq Offset 0.00000000 Hz</p> <p>Signal Track On Off</p>

Mode 4: IEEE 802.11n 2.4GHz 20MHz link mode_ANT-1	
2412	<p>Agilent R T</p> <p>Ch Freq 2.412 GHz Trig Free</p> <p>Occupied Bandwidth</p> <p>Ref 20 dBm Atten 20 dB</p> <p>#Peak Log 10 dB/Offset 10.8 dB</p> <p>Center 2.412 GHz Span 30 MHz</p> <p>#Res BW 100 kHz #VBW 300 kHz Sweep 4 ms (401 pts)</p> <p>Occupied Bandwidth 17.1589 MHz</p> <p>Occ BW % Pwr 99.00 % x dB -6.00 dB</p> <p>Transmit Freq Error -75.463 kHz x dB Bandwidth 15.188 MHz</p> <p>Freq/Channel</p> <p>Center Freq 2.41200000 GHz</p> <p>Start Freq 2.39700000 GHz</p> <p>Stop Freq 2.42700000 GHz</p> <p>CF Step 3.00000000 MHz Auto Man</p> <p>Freq Offset 0.00000000 Hz</p> <p>Signal Track On Off</p>
2437	<p>Agilent R T</p> <p>Ch Freq 2.437 GHz Trig Free</p> <p>Occupied Bandwidth</p> <p>Ref 20 dBm Atten 20 dB</p> <p>#Peak Log 10 dB/Offset 10.8 dB</p> <p>Center 2.437 GHz Span 30 MHz</p> <p>#Res BW 100 kHz #VBW 300 kHz Sweep 4 ms (401 pts)</p> <p>Occupied Bandwidth 17.3305 MHz</p> <p>Occ BW % Pwr 99.00 % x dB -6.00 dB</p> <p>Transmit Freq Error 49.747 kHz x dB Bandwidth 16.036 MHz</p> <p>Freq/Channel</p> <p>Center Freq 2.43700000 GHz</p> <p>Start Freq 2.42200000 GHz</p> <p>Stop Freq 2.45200000 GHz</p> <p>CF Step 3.00000000 MHz Auto Man</p> <p>Freq Offset 0.00000000 Hz</p> <p>Signal Track On Off</p>
2462	<p>Agilent R T</p> <p>Ch Freq 2.462 GHz Trig Free</p> <p>Occupied Bandwidth</p> <p>Ref 20 dBm Atten 20 dB</p> <p>#Peak Log 10 dB/Offset 10.8 dB</p> <p>Center 2.462 GHz Span 30 MHz</p> <p>#Res BW 100 kHz #VBW 300 kHz Sweep 4 ms (401 pts)</p> <p>Occupied Bandwidth 17.1700 MHz</p> <p>Occ BW % Pwr 99.00 % x dB -6.00 dB</p> <p>Transmit Freq Error -81.467 kHz x dB Bandwidth 15.289 MHz</p> <p>Freq/Channel</p> <p>Center Freq 2.46200000 GHz</p> <p>Start Freq 2.44700000 GHz</p> <p>Stop Freq 2.47700000 GHz</p> <p>CF Step 3.00000000 MHz Auto Man</p> <p>Freq Offset 0.00000000 Hz</p> <p>Signal Track On Off</p>

Mode 5: IEEE 802.11n 2.4GHz 40MHz link mode_ANT-1	
2422	<p>Agilent R T</p> <p>Ch Freq 2.422 GHz Trig Free</p> <p>Occupied Bandwidth</p> <p>Ref 20 dBm Atten 20 dB</p> <p>#Peak Log 10 dB/Offset 10.8 dB</p> <p>Center 2.422 GHz Span 50 MHz</p> <p>#Res BW 100 kHz #VBW 300 kHz Sweep 5.18 ms (401 pts)</p> <p>Occupied Bandwidth 35.5898 MHz</p> <p>Occ BW % Pwr 99.00 % x dB -6.00 dB</p> <p>Transmit Freq Error -131.511 kHz x dB Bandwidth 35.118 MHz</p> <p>Freq/Channel</p> <p>Center Freq 2.42200000 GHz</p> <p>Start Freq 2.39700000 GHz</p> <p>Stop Freq 2.44700000 GHz</p> <p>CF Step 5.00000000 MHz Auto Man</p> <p>Freq Offset 0.00000000 Hz</p> <p>Signal Track On Off</p>
2437	<p>Agilent R T</p> <p>Ch Freq 2.437 GHz Trig Free</p> <p>Occupied Bandwidth</p> <p>Ref 20 dBm Atten 20 dB</p> <p>#Peak Log 10 dB/Offset 10.8 dB</p> <p>Center 2.437 GHz Span 50 MHz</p> <p>#Res BW 100 kHz #VBW 300 kHz Sweep 5.18 ms (401 pts)</p> <p>Occupied Bandwidth 35.8366 MHz</p> <p>Occ BW % Pwr 99.00 % x dB -6.00 dB</p> <p>Transmit Freq Error 107.373 kHz x dB Bandwidth 35.696 MHz</p> <p>Freq/Channel</p> <p>Center Freq 2.43700000 GHz</p> <p>Start Freq 2.41200000 GHz</p> <p>Stop Freq 2.46200000 GHz</p> <p>CF Step 5.00000000 MHz Auto Man</p> <p>Freq Offset 0.00000000 Hz</p> <p>Signal Track On Off</p>
2452	<p>Agilent R T</p> <p>Ch Freq 2.452 GHz Trig Free</p> <p>Occupied Bandwidth</p> <p>Ref 20 dBm Atten 20 dB</p> <p>#Peak Log 10 dB/Offset 10.8 dB</p> <p>Center 2.452 GHz Span 50 MHz</p> <p>#Res BW 100 kHz #VBW 300 kHz Sweep 5.18 ms (401 pts)</p> <p>Occupied Bandwidth 35.0812 MHz</p> <p>Occ BW % Pwr 99.00 % x dB -6.00 dB</p> <p>Transmit Freq Error 55.339 kHz x dB Bandwidth 27.592 MHz</p> <p>Freq/Channel</p> <p>Center Freq 2.45200000 GHz</p> <p>Start Freq 2.42700000 GHz</p> <p>Stop Freq 2.47700000 GHz</p> <p>CF Step 5.00000000 MHz Auto Man</p> <p>Freq Offset 0.00000000 Hz</p> <p>Signal Track On Off</p>

Mode 4: IEEE 802.11n 2.4GHz 20MHz link mode_ANT-2	
2412	<p>Agilent R T</p> <p>Ch Freq 2.412 GHz Trig Free</p> <p>Occupied Bandwidth</p> <p>Ref 20 dBm Atten 20 dB</p> <p>#Peak Log 10 dB/Offset 10.8 dB</p> <p>Center 2.412 GHz Span 30 MHz</p> <p>#Res BW 100 kHz #VBW 300 kHz Sweep 4 ms (401 pts)</p> <p>Occupied Bandwidth 17.1854 MHz</p> <p>Occ BW % Pwr 99.00 % x dB -6.00 dB</p> <p>Transmit Freq Error -42.985 kHz x dB Bandwidth 14.003 MHz</p> <p>Freq/Channel</p> <p>Center Freq 2.41200000 GHz</p> <p>Start Freq 2.39700000 GHz</p> <p>Stop Freq 2.42700000 GHz</p> <p>CF Step 3.00000000 MHz Auto Man</p> <p>Freq Offset 0.00000000 Hz</p> <p>Signal Track On Off</p>
2437	<p>Agilent R T</p> <p>Ch Freq 2.437 GHz Trig Free</p> <p>Occupied Bandwidth</p> <p>Ref 20 dBm Atten 20 dB</p> <p>#Peak Log 10 dB/Offset 10.8 dB</p> <p>Center 2.437 GHz Span 30 MHz</p> <p>#Res BW 100 kHz #VBW 300 kHz Sweep 4 ms (401 pts)</p> <p>Occupied Bandwidth 17.3663 MHz</p> <p>Occ BW % Pwr 99.00 % x dB -6.00 dB</p> <p>Transmit Freq Error 41.539 kHz x dB Bandwidth 15.963 MHz</p> <p>Freq/Channel</p> <p>Center Freq 2.43700000 GHz</p> <p>Start Freq 2.42200000 GHz</p> <p>Stop Freq 2.45200000 GHz</p> <p>CF Step 3.00000000 MHz Auto Man</p> <p>Freq Offset 0.00000000 Hz</p> <p>Signal Track On Off</p>
2462	<p>Agilent R T</p> <p>Ch Freq 2.462 GHz Trig Free</p> <p>Occupied Bandwidth</p> <p>Ref 20 dBm Atten 20 dB</p> <p>#Peak Log 10 dB/Offset 10.8 dB</p> <p>Center 2.462 GHz Span 30 MHz</p> <p>#Res BW 100 kHz #VBW 300 kHz Sweep 4 ms (401 pts)</p> <p>Occupied Bandwidth 17.1755 MHz</p> <p>Occ BW % Pwr 99.00 % x dB -6.00 dB</p> <p>Transmit Freq Error -69.645 kHz x dB Bandwidth 15.129 MHz</p> <p>Freq/Channel</p> <p>Center Freq 2.46200000 GHz</p> <p>Start Freq 2.44700000 GHz</p> <p>Stop Freq 2.47700000 GHz</p> <p>CF Step 3.00000000 MHz Auto Man</p> <p>Freq Offset 0.00000000 Hz</p> <p>Signal Track On Off</p>

Mode 5: IEEE 802.11n 2.4GHz 40MHz link mode_ANT-2	
2422	<p>Agilent R T</p> <p>Ch Freq 2.422 GHz Trig Free</p> <p>Occupied Bandwidth</p> <p>Ref 20 dBm Atten 20 dB</p> <p>#Peak Log 10 dB/Offset 10.8 dB</p> <p>Center 2.422 GHz Span 50 MHz</p> <p>#Res BW 100 kHz #VBW 300 kHz Sweep 5.18 ms (401 pts)</p> <p>Occupied Bandwidth 35.4939 MHz</p> <p>Occ BW % Pwr 99.00 % x dB -6.00 dB</p> <p>Transmit Freq Error -142.365 kHz</p> <p>x dB Bandwidth 32.634 MHz</p> <p>Freq/Channel</p> <p>Center Freq 2.42200000 GHz</p> <p>Start Freq 2.39700000 GHz</p> <p>Stop Freq 2.44700000 GHz</p> <p>CF Step 5.00000000 MHz Auto Man</p> <p>Freq Offset 0.00000000 Hz</p> <p>Signal Track On Off</p>
2437	<p>Agilent R T</p> <p>Ch Freq 2.437 GHz Trig Free</p> <p>Occupied Bandwidth</p> <p>Ref 20 dBm Atten 20 dB</p> <p>#Peak Log 10 dB/Offset 10.8 dB</p> <p>Center 2.437 GHz Span 50 MHz</p> <p>#Res BW 100 kHz #VBW 300 kHz Sweep 5.18 ms (401 pts)</p> <p>Occupied Bandwidth 35.8605 MHz</p> <p>Occ BW % Pwr 99.00 % x dB -6.00 dB</p> <p>Transmit Freq Error 70.990 kHz</p> <p>x dB Bandwidth 35.502 MHz</p> <p>Freq/Channel</p> <p>Center Freq 2.43700000 GHz</p> <p>Start Freq 2.41200000 GHz</p> <p>Stop Freq 2.46200000 GHz</p> <p>CF Step 5.00000000 MHz Auto Man</p> <p>Freq Offset 0.00000000 Hz</p> <p>Signal Track On Off</p>
2452	<p>Agilent R T</p> <p>Ch Freq 2.452 GHz Trig Free</p> <p>Occupied Bandwidth</p> <p>Ref 20 dBm Atten 20 dB</p> <p>#Peak Log 10 dB/Offset 10.8 dB</p> <p>Center 2.452 GHz Span 50 MHz</p> <p>#Res BW 100 kHz #VBW 300 kHz Sweep 5.18 ms (401 pts)</p> <p>Occupied Bandwidth 35.1443 MHz</p> <p>Occ BW % Pwr 99.00 % x dB -6.00 dB</p> <p>Transmit Freq Error 76.547 kHz</p> <p>x dB Bandwidth 27.604 MHz</p> <p>Freq/Channel</p> <p>Center Freq 2.45200000 GHz</p> <p>Start Freq 2.42700000 GHz</p> <p>Stop Freq 2.47700000 GHz</p> <p>CF Step 5.00000000 MHz Auto Man</p> <p>Freq Offset 0.00000000 Hz</p> <p>Signal Track On Off</p>

8 Maximum Power Density Measurement

8.1. Limit

For digitally modulated systems, the power spectral density conducted from the intentional radiator to the antenna shall not be greater than 8 dBm in any 3 kHz band during any time interval of continuous transmission.

8.2. Test Setup

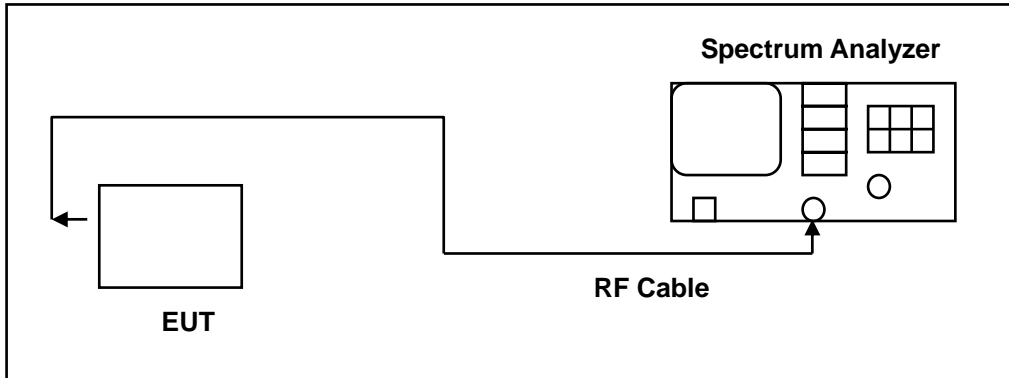

8.3. Test Instruments

Equipment	Manufacturer	Model Number	Serial Number	Cal. Date	Remark
Spectrum Analyzer	Agilent	E4445A	MY45300744	12/16/2014	(1)
Test Site	ATL	TE05	TE05	N.C.R.	-----

Remark: (1) Calibration period 1 year. (2) Calibration period 2 years. (3) Calibration period 3 years.

Note: N.C.R. = No Calibration Request.

8.4. Test Procedure

The EUT tested to DTS test procedure of KDB558074D01 for compliance to FCC 47CFR 15.247 requirements.

1. Set analyzer center frequency to DTS channel center frequency.
2. Set the span to 1.5 times the DTS bandwidth.
3. Set the RBW to: $3 \text{ kHz} \leq \text{RBW} \leq 100 \text{ kHz}$.
4. Set the VBW $\geq 3 \times \text{RBW}$.
5. Detector = peak.
6. Sweep time = auto couple.
7. Trace mode = max hold.
8. Allow trace to fully stabilize.
9. Use the peak marker function to determine the maximum amplitude level within the RBW.
10. If measured value exceeds limit, reduce RBW (no less than 3 kHz) and repeat.

8.5. Test Result

Model Number	AC791L				
Test Item	Maximum Power Density				
Test Mode	Mode 2: IEEE 802.11b link mode Mode 3: IEEE 802.11g link mode Mode 4: IEEE 802.11n 2.4GHz 20MHz link mode Mode 5: IEEE 802.11n 2.4GHz 40MHz link mode				
Date of Test	05/06/2015			Test Site	TE05
Test Mode	Frequency (MHz)	Measurement (dBm/3KHz)			Limit (dBm/3KHz)
		ANT-1	ANT-2	ANT-1+2	
Mode 2	2412	1.22	---	---	< 8
	2437	0.61	---	---	< 8
	2462	1.27	---	---	< 8
Mode 3	2412	-17.07	---	---	< 8
	2437	-17.20	---	---	< 8
	2462	-16.12	---	---	< 8
Mode 4	2412	-19.61	-19.88	-16.73	< 8
	2437	-20.11	-20.94	-17.49	< 8
	2462	-20.08	-19.58	-16.81	< 8
Mode 5	2422	-21.63	-21.55	-18.58	< 8
	2437	-21.96	-22.41	-19.17	< 8
	2452	-20.18	-21.35	-17.72	< 8

8.6. Test Graphs

Mode 2: IEEE 802.11b link mode_ANT-1	
2412	<p>Agilent R T Mkr1 2.41300 GHz 1.223 dBm</p> <p>Ref 10 dBm Atten 10 dB</p> <p>Peak Log 10 dB/ Offst 10.8 dB DI 8.0 dBm</p> <p>M1 S2 S3 FC AA</p> <p>Center 2.412 GHz Span 20 MHz #Res BW 3 kHz #VBW 10 kHz Sweep 2.287 s (401 pts)</p> <p>Freq/Channel Center Freq 2.41200000 GHz Start Freq 2.40200000 GHz Stop Freq 2.42200000 GHz CF Step 2.00000000 MHz Auto Man Freq Offset 0.00000000 Hz Signal Track On Off</p>
2437	<p>Agilent R T Mkr1 2.43900 GHz 0.61 dBm</p> <p>Ref 10 dBm Atten 10 dB</p> <p>Peak Log 10 dB/ Offst 10.8 dB DI 8.0 dBm</p> <p>M1 S2 S3 FC AA</p> <p>Center 2.437 GHz Span 20 MHz #Res BW 3 kHz #VBW 10 kHz Sweep 2.287 s (401 pts)</p> <p>Freq/Channel Center Freq 2.43700000 GHz Start Freq 2.42700000 GHz Stop Freq 2.44700000 GHz CF Step 2.00000000 MHz Auto Man Freq Offset 0.00000000 Hz Signal Track On Off</p>
2462	<p>Agilent R T Mkr1 2.46300 GHz 1.265 dBm</p> <p>Ref 10 dBm Atten 10 dB</p> <p>Peak Log 10 dB/ Offst 10.8 dB DI 8.0 dBm</p> <p>M1 S2 S3 FC AA</p> <p>Center 2.462 GHz Span 20 MHz #Res BW 3 kHz #VBW 10 kHz Sweep 2.287 s (401 pts)</p> <p>Freq/Channel Center Freq 2.46200000 GHz Start Freq 2.45200000 GHz Stop Freq 2.47200000 GHz CF Step 2.00000000 MHz Auto Man Freq Offset 0.00000000 Hz Signal Track On Off</p>

Mode 3: IEEE 802.11g link mode_ANT-1

<p>2412</p>	<p>Agilent R T</p> <p>Ref 10 dBm Atten 10 dB Mkr1 2.4095000 GHz -17.07 dBm</p> <p>Peak Log 10 dB/Offst 10.8 dB DI 8.0 dBm</p> <p>M1 S2 S3 FC AA</p> <p>Center 2.412 GHz Span 25 MHz #Res BW 3 kHz #VBW 10 kHz Sweep 2.859 s (401 pts)</p> <p>Freq/Channel</p> <p>Center Freq 2.41200000 GHz</p> <p>Start Freq 2.39950000 GHz</p> <p>Stop Freq 2.42450000 GHz</p> <p>CF Step 2.50000000 MHz Auto Man</p> <p>Freq Offset 0.00000000 Hz</p> <p>Signal Track On Off</p>
<p>2437</p>	<p>Agilent R T</p> <p>Ref 10 dBm Atten 10 dB Mkr1 2.4414375 GHz -17.2 dBm</p> <p>Peak Log 10 dB/Offst 10.8 dB DI 8.0 dBm</p> <p>M1 S2 S3 FC AA</p> <p>Center 2.437 GHz Span 25 MHz #Res BW 3 kHz #VBW 10 kHz Sweep 2.859 s (401 pts)</p> <p>Freq/Channel</p> <p>Center Freq 2.43700000 GHz</p> <p>Start Freq 2.42450000 GHz</p> <p>Stop Freq 2.44950000 GHz</p> <p>CF Step 2.50000000 MHz Auto Man</p> <p>Freq Offset 0.00000000 Hz</p> <p>Signal Track On Off</p>
<p>2462</p>	<p>Agilent R T</p> <p>Ref 10 dBm Atten 10 dB Mkr1 2.4585625 GHz -16.12 dBm</p> <p>Peak Log 10 dB/Offst 10.8 dB DI 8.0 dBm</p> <p>M1 S2 S3 FC AA</p> <p>Center 2.462 GHz Span 25 MHz #Res BW 3 kHz #VBW 10 kHz Sweep 2.859 s (401 pts)</p> <p>Freq/Channel</p> <p>Center Freq 2.46200000 GHz</p> <p>Start Freq 2.44950000 GHz</p> <p>Stop Freq 2.47450000 GHz</p> <p>CF Step 2.50000000 MHz Auto Man</p> <p>Freq Offset 0.00000000 Hz</p> <p>Signal Track On Off</p>

Mode 4: IEEE 802.11n 2.4GHz 20MHz link mode_ANT-1

<p>2412</p>	
<p>2437</p>	
<p>2462</p>	

Mode 5: IEEE 802.11n 2.4GHz 40MHz link mode_ANT-1

<p>2422</p>	<p>Agilent R T</p> <p>Ref 10 dBm Atten 10 dB Mkr1 2.409445 GHz 21.63 dBm</p> <p>Center 2.422 GHz Span 54 MHz #Res BW 3 kHz #VBW 10 kHz Sweep 6.176 s (401 pts)</p> <p>Center Freq: 2.42200000 GHz Start Freq: 2.39500000 GHz Stop Freq: 2.44900000 GHz CF Step: 5.40000000 MHz Freq Offset: 0.00000000 Hz Signal Track: On</p>
<p>2437</p>	<p>Agilent R T</p> <p>Ref 10 dBm Atten 10 dB Mkr1 2.445775 GHz 21.96 dBm</p> <p>Center 2.437 GHz Span 54 MHz #Res BW 3 kHz #VBW 10 kHz Sweep 6.176 s (401 pts)</p> <p>Center Freq: 2.43700000 GHz Start Freq: 2.41000000 GHz Stop Freq: 2.46400000 GHz CF Step: 5.40000000 MHz Freq Offset: 0.00000000 Hz Signal Track: On</p>
<p>2452</p>	<p>Agilent R T</p> <p>Ref 10 dBm Atten 10 dB Mkr1 2.455780 GHz 20.18 dBm</p> <p>Center 2.452 GHz Span 54 MHz #Res BW 3 kHz #VBW 10 kHz Sweep 6.176 s (401 pts)</p> <p>Center Freq: 2.45200000 GHz Start Freq: 2.42500000 GHz Stop Freq: 2.47900000 GHz CF Step: 5.40000000 MHz Freq Offset: 0.00000000 Hz Signal Track: On</p>

Mode 4: IEEE 802.11n 2.4GHz 20MHz link mode_ANT-2

<p>2412</p>	
<p>2437</p>	
<p>2462</p>	

Mode 5: IEEE 802.11n 2.4GHz 40MHz link mode_ANT-2

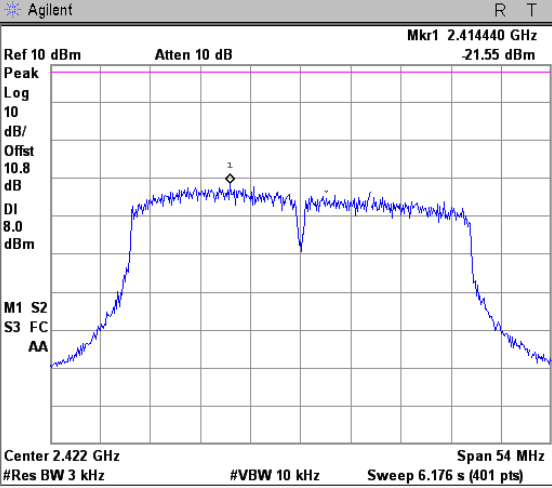
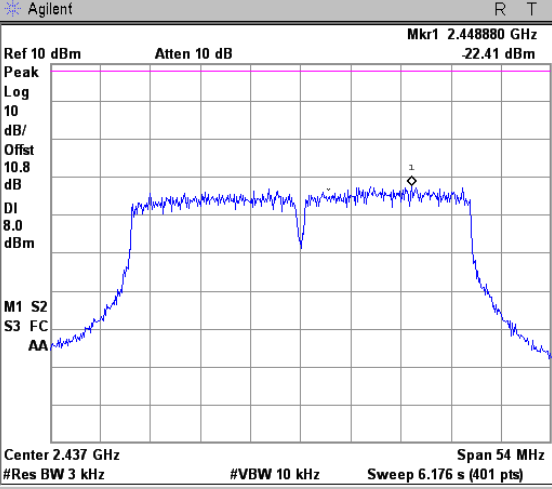
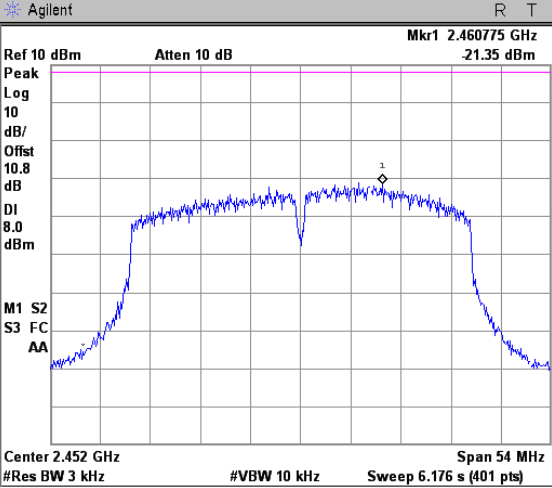
2422	 <p>Agilent R T</p> <p>Ref 10 dBm Atten 10 dB Mkr1 2.414440 GHz 21.55 dBm</p> <p>Peak Log 10 dB/Offst 10.8 dB DI 8.0 dBm</p> <p>M1 S2 S3 FC AA</p> <p>Center 2.422 GHz Span 54 MHz #Res BW 3 kHz #VBW 10 kHz Sweep 6.176 s (401 pts)</p> <p>Freq/Channel</p> <p>Center Freq 2.42200000 GHz</p> <p>Start Freq 2.39500000 GHz</p> <p>Stop Freq 2.44900000 GHz</p> <p>CF Step 5.40000000 MHz Auto Man</p> <p>Freq Offset 0.00000000 Hz</p> <p>Signal Track On Off</p>
2437	 <p>Agilent R T</p> <p>Ref 10 dBm Atten 10 dB Mkr1 2.448880 GHz 22.41 dBm</p> <p>Peak Log 10 dB/Offst 10.8 dB DI 8.0 dBm</p> <p>M1 S2 S3 FC AA</p> <p>Center 2.437 GHz Span 54 MHz #Res BW 3 kHz #VBW 10 kHz Sweep 6.176 s (401 pts)</p> <p>Freq/Channel</p> <p>Center Freq 2.43700000 GHz</p> <p>Start Freq 2.41000000 GHz</p> <p>Stop Freq 2.46400000 GHz</p> <p>CF Step 5.40000000 MHz Auto Man</p> <p>Freq Offset 0.00000000 Hz</p> <p>Signal Track On Off</p>
2452	 <p>Agilent R T</p> <p>Ref 10 dBm Atten 10 dB Mkr1 2.460775 GHz 21.35 dBm</p> <p>Peak Log 10 dB/Offst 10.8 dB DI 8.0 dBm</p> <p>M1 S2 S3 FC AA</p> <p>Center 2.452 GHz Span 54 MHz #Res BW 3 kHz #VBW 10 kHz Sweep 6.176 s (401 pts)</p> <p>Freq/Channel</p> <p>Center Freq 2.45200000 GHz</p> <p>Start Freq 2.42500000 GHz</p> <p>Stop Freq 2.47900000 GHz</p> <p>CF Step 5.40000000 MHz Auto Man</p> <p>Freq Offset 0.00000000 Hz</p> <p>Signal Track On Off</p>

9 Out of Band Conducted Emissions Measurement

9.1. Limit

In any 100 kHz bandwidth outside the frequency band in which the spread spectrum or digitally modulated intentional radiator is operating, the radio frequency power that is produced by the intentional radiator shall be at least 30 dB below that in the 100 kHz bandwidth within the band that contains the highest level of the desired power

9.2. Test Setup

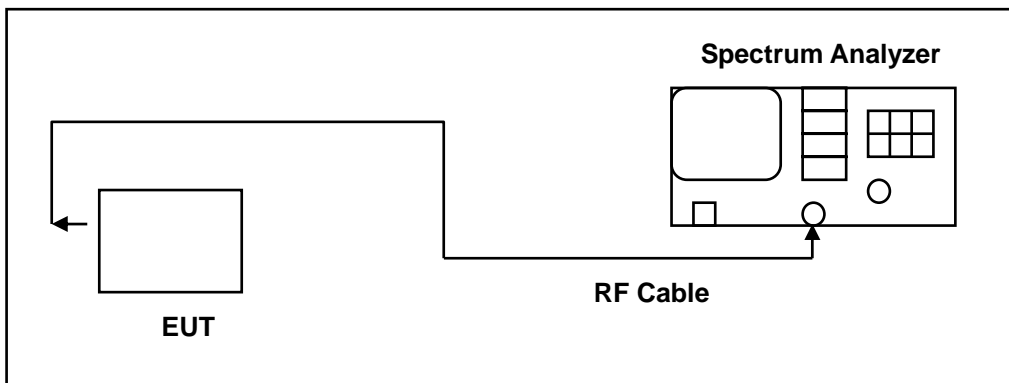

9.3. Test Instruments

Equipment	Manufacturer	Model Number	Serial Number	Cal. Date	Remark
Spectrum Analyzer	Agilent	E4445A	MY45300744	12/16/2014	(1)
Spectrum Analyzer	Agilent	E4408B	MY45107753	07/24/2014	(1)
Test Site	ATL	TE05	TE05	N.C.R.	-----

Remark: (1) Calibration period 1 year. (2) Calibration period 2 years. (3) Calibration period 3 years.

Note: N.C.R. = No Calibration Request.

9.4. Test Procedure

In any 100 kHz bandwidth outside the EUT pass band, the RF power produced by the modulation products of the spreading sequence, the information sequence, and the carrier frequency shall be at least 30 dB below that of the maximum in-band 100 kHz emission, antenna output of the EUT was coupled directly to spectrum analyzer; if an external attenuator and/or cable was used, these losses are compensated for with the analyzer OFFSET function.

All other types of emissions from the EUT shall meet the general limits for radiated frequencies outside the pass band.

The test was performed at 3 channels.

9.5. Test Graphs

Reference level

Mode 2: IEEE 802.11b link mode_ANT-1	
2412	
2437	
2462	

Mode 3: IEEE 802.11g link mode_ANT-1

2412	
2437	
2462	

Mode 4: IEEE 802.11n 2.4GHz 20MHz link mode_ANT-1

2412	<p>Agilent R T</p> <p>Ref 10 dBm Atten 10 dB Mkr1 2.408230 GHz 4.023 dBm</p> <p>Peak Log 10 dB/Offst 10.8 dB</p> <p>M1 S2 S3 FC AA</p> <p>Center 2.412 GHz Span 26 MHz #Res BW 100 kHz #VBW 300 kHz Sweep 4 ms (401 pts)</p> <p>Freq/Channel</p> <p>Center Freq 2.41200000 GHz</p> <p>Start Freq 2.39900000 GHz</p> <p>Stop Freq 2.42500000 GHz</p> <p>CF Step 2.60000000 MHz Auto Man</p> <p>Freq Offset 0.00000000 Hz</p> <p>Signal Track On Off</p>
2437	<p>Agilent R T</p> <p>Ref 10 dBm Atten 10 dB Mkr1 2.439535 GHz 4.431 dBm</p> <p>Peak Log 10 dB/Offst 10.8 dB</p> <p>M1 S2 S3 FC AA</p> <p>Center 2.437 GHz Span 26 MHz #Res BW 100 kHz #VBW 300 kHz Sweep 4 ms (401 pts)</p> <p>Freq/Channel</p> <p>Center Freq 2.43700000 GHz</p> <p>Start Freq 2.42400000 GHz</p> <p>Stop Freq 2.45000000 GHz</p> <p>CF Step 2.60000000 MHz Auto Man</p> <p>Freq Offset 0.00000000 Hz</p> <p>Signal Track On Off</p>
2462	<p>Agilent R T</p> <p>Ref 10 dBm Atten 10 dB Mkr1 2.458230 GHz 4.012 dBm</p> <p>Peak Log 10 dB/Offst 10.8 dB</p> <p>M1 S2 S3 FC AA</p> <p>Center 2.462 GHz Span 26 MHz #Res BW 100 kHz #VBW 300 kHz Sweep 4 ms (401 pts)</p> <p>Freq/Channel</p> <p>Center Freq 2.46200000 GHz</p> <p>Start Freq 2.44900000 GHz</p> <p>Stop Freq 2.47500000 GHz</p> <p>CF Step 2.60000000 MHz Auto Man</p> <p>Freq Offset 0.00000000 Hz</p> <p>Signal Track On Off</p>

Mode 5: IEEE 802.11n 2.4GHz 40MHz link mode_ANT-1

<p>2422</p>	<p>Agilent R T</p> <p>Ref 10 dBm Atten 10 dB Mkr1 2.413225 GHz 5.845 dBm</p> <p>Peak Log 10 dB/Offst 10.8 dB</p> <p>M1 S2 S3 FC AA</p> <p>Center 2.422 GHz Span 54 MHz #Res BW 100 kHz #VBW 300 kHz Sweep 5.594 ms (401 pts)</p> <p>Freq/Channel</p> <p>Center Freq 2.42200000 GHz</p> <p>Start Freq 2.39500000 GHz</p> <p>Stop Freq 2.44900000 GHz</p> <p>CF Step 5.40000000 MHz Auto Man</p> <p>Freq Offset 0.00000000 Hz</p> <p>Signal Track On Off</p>
<p>2437</p>	<p>Agilent R T</p> <p>Ref 10 dBm Atten 10 dB Mkr1 2.451985 GHz 5.474 dBm</p> <p>Peak Log 10 dB/Offst 10.8 dB</p> <p>M1 S2 S3 FC AA</p> <p>Center 2.437 GHz Span 54 MHz #Res BW 100 kHz #VBW 300 kHz Sweep 5.594 ms (401 pts)</p> <p>Freq/Channel</p> <p>Center Freq 2.43700000 GHz</p> <p>Start Freq 2.41000000 GHz</p> <p>Stop Freq 2.46400000 GHz</p> <p>CF Step 5.40000000 MHz Auto Man</p> <p>Freq Offset 0.00000000 Hz</p> <p>Signal Track On Off</p>
<p>2452</p>	<p>Agilent R T</p> <p>Ref 10 dBm Atten 10 dB Mkr1 2.456995 GHz 5.431 dBm</p> <p>Peak Log 10 dB/Offst 10.8 dB</p> <p>M1 S2 S3 FC AA</p> <p>Center 2.452 GHz Span 54 MHz #Res BW 100 kHz #VBW 300 kHz Sweep 5.594 ms (401 pts)</p> <p>Freq/Channel</p> <p>Center Freq 2.45200000 GHz</p> <p>Start Freq 2.42500000 GHz</p> <p>Stop Freq 2.47900000 GHz</p> <p>CF Step 5.40000000 MHz Auto Man</p> <p>Freq Offset 0.00000000 Hz</p> <p>Signal Track On Off</p>

Mode 4: IEEE 802.11n 2.4GHz 20MHz link mode_ANT-2

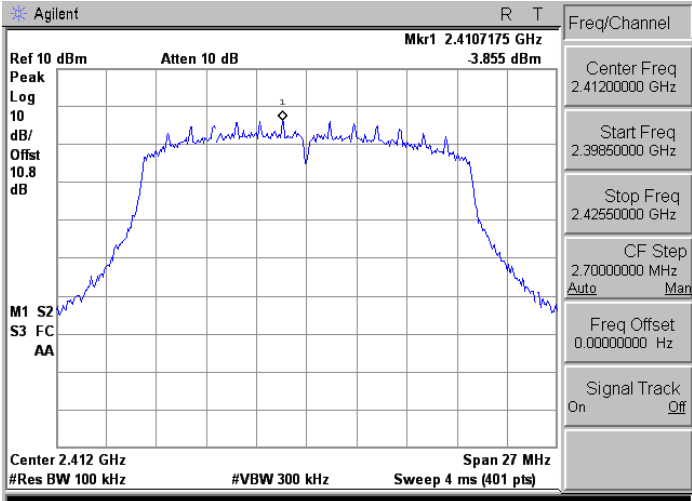
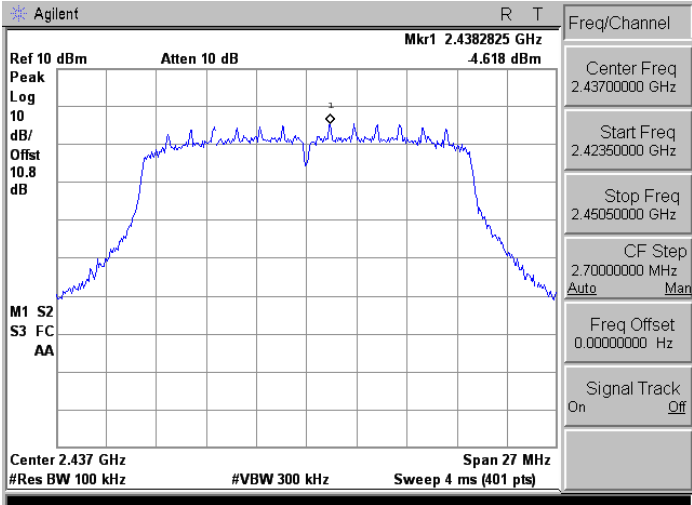
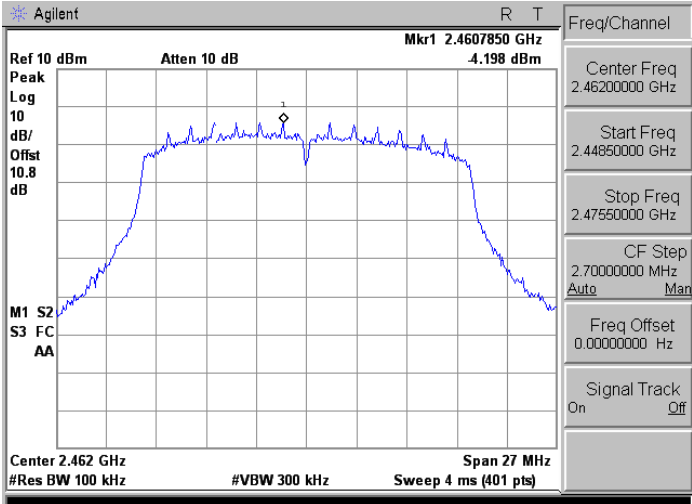
<p>2412</p>	 <p>Agilent R T</p> <p>Ref 10 dBm Atten 10 dB Mkr1 2.4107175 GHz 3.855 dBm</p> <p>Peak Log 10 dB/Offst 10.8 dB</p> <p>M1 S2 S3 FC AA</p> <p>Center 2.412 GHz Span 27 MHz #Res BW 100 kHz #VBW 300 kHz Sweep 4 ms (401 pts)</p> <p>Freq/Channel</p> <p>Center Freq 2.41200000 GHz</p> <p>Start Freq 2.39850000 GHz</p> <p>Stop Freq 2.42550000 GHz</p> <p>CF Step 2.70000000 MHz Auto Man</p> <p>Freq Offset 0.00000000 Hz</p> <p>Signal Track On Off</p>
<p>2437</p>	 <p>Agilent R T</p> <p>Ref 10 dBm Atten 10 dB Mkr1 2.4382825 GHz 4.618 dBm</p> <p>Peak Log 10 dB/Offst 10.8 dB</p> <p>M1 S2 S3 FC AA</p> <p>Center 2.437 GHz Span 27 MHz #Res BW 100 kHz #VBW 300 kHz Sweep 4 ms (401 pts)</p> <p>Freq/Channel</p> <p>Center Freq 2.43700000 GHz</p> <p>Start Freq 2.42350000 GHz</p> <p>Stop Freq 2.45050000 GHz</p> <p>CF Step 2.70000000 MHz Auto Man</p> <p>Freq Offset 0.00000000 Hz</p> <p>Signal Track On Off</p>
<p>2462</p>	 <p>Agilent R T</p> <p>Ref 10 dBm Atten 10 dB Mkr1 2.4607850 GHz 4.198 dBm</p> <p>Peak Log 10 dB/Offst 10.8 dB</p> <p>M1 S2 S3 FC AA</p> <p>Center 2.462 GHz Span 27 MHz #Res BW 100 kHz #VBW 300 kHz Sweep 4 ms (401 pts)</p> <p>Freq/Channel</p> <p>Center Freq 2.46200000 GHz</p> <p>Start Freq 2.44850000 GHz</p> <p>Stop Freq 2.47550000 GHz</p> <p>CF Step 2.70000000 MHz Auto Man</p> <p>Freq Offset 0.00000000 Hz</p> <p>Signal Track On Off</p>

Mode 5: IEEE 802.11n 2.4GHz 40MHz link mode_ANT-2

<p>2422</p>	<p>Agilent R T</p> <p>Ref 10 dBm Atten 10 dB Mkr1 2.414440 GHz 5.513 dBm</p> <p>Peak Log 10 dB/Offst 10.8 dB</p> <p>M1 S2 S3 FC AA</p> <p>Center 2.422 GHz Span 54 MHz #Res BW 100 kHz #VBW 300 kHz Sweep 5.594 ms (401 pts)</p> <p>Freq/Channel</p> <p>Center Freq 2.42200000 GHz</p> <p>Start Freq 2.39500000 GHz</p> <p>Stop Freq 2.44900000 GHz</p> <p>CF Step 5.40000000 MHz Auto Man</p> <p>Freq Offset 0.00000000 Hz</p> <p>Signal Track On Off</p>
<p>2437</p>	<p>Agilent R T</p> <p>Ref 10 dBm Atten 10 dB Mkr1 2.449555 GHz 6.79 dBm</p> <p>Peak Log 10 dB/Offst 10.8 dB</p> <p>M1 S2 S3 FC AA</p> <p>Center 2.437 GHz Span 54 MHz #Res BW 100 kHz #VBW 300 kHz Sweep 5.594 ms (401 pts)</p> <p>Freq/Channel</p> <p>Center Freq 2.43700000 GHz</p> <p>Start Freq 2.41000000 GHz</p> <p>Stop Freq 2.46400000 GHz</p> <p>CF Step 5.40000000 MHz Auto Man</p> <p>Freq Offset 0.00000000 Hz</p> <p>Signal Track On Off</p>
<p>2452</p>	<p>Agilent R T</p> <p>Ref 10 dBm Atten 10 dB Mkr1 2.456995 GHz 5.452 dBm</p> <p>Peak Log 10 dB/Offst 10.8 dB</p> <p>M1 S2 S3 FC AA</p> <p>Center 2.452 GHz Span 54 MHz #Res BW 100 kHz #VBW 300 kHz Sweep 5.594 ms (401 pts)</p> <p>Freq/Channel</p> <p>Center Freq 2.45200000 GHz</p> <p>Start Freq 2.42500000 GHz</p> <p>Stop Freq 2.47900000 GHz</p> <p>CF Step 5.40000000 MHz Auto Man</p> <p>Freq Offset 0.00000000 Hz</p> <p>Signal Track On Off</p>

Out of Band Conducted Emissions

Mode 2: IEEE 802.11b link mode_ANT-1

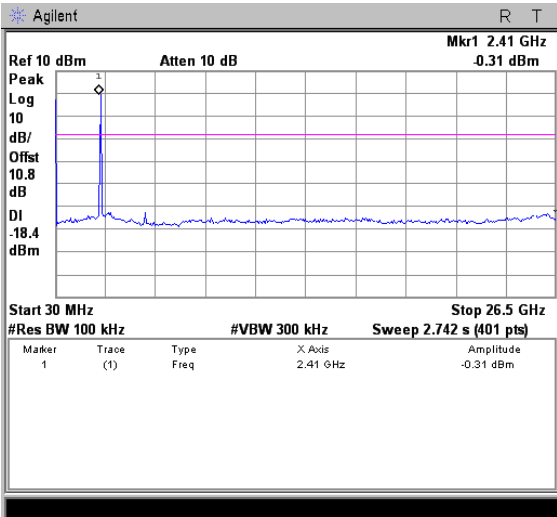
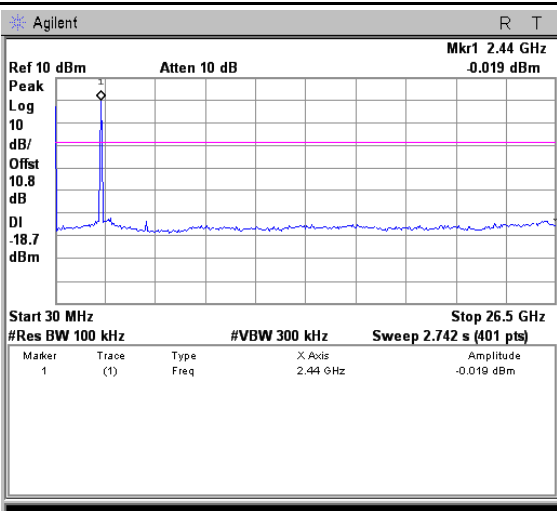
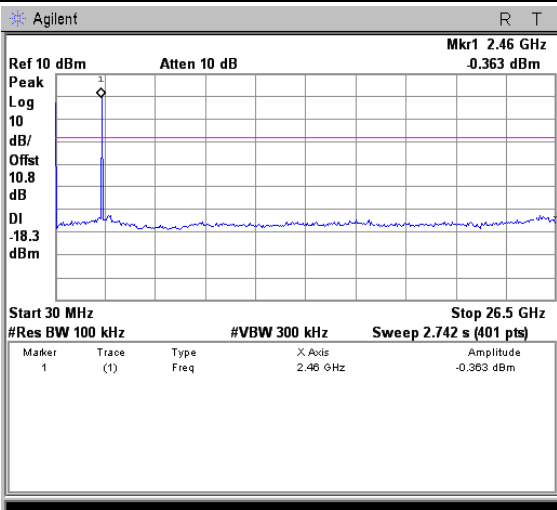
<p>2412</p>	 <p>Agilent R T Ref 10 dBm Atten 10 dB Mkr1 2.41 GHz Peak Log 10 dB/Offst 10.8 dB DI -18.4 dBm Amplitude: -0.31 dBm Start 30 MHz Stop 26.5 GHz #Res BW 100 kHz #VBW 300 kHz Sweep 2.742 s (401 pts) Marker 1 Trace (1) Type Freq X Axis 2.41 GHz Amplitude -0.31 dBm</p> <p>Freq/Channel Center Freq 13.2650000 GHz Start Freq 30.0000000 MHz Stop Freq 26.5000000 GHz CF Step 2.64700000 GHz Auto Man Freq Offset 0.00000000 Hz Signal Track On Off</p>
<p>2437</p>	 <p>Agilent R T Ref 10 dBm Atten 10 dB Mkr1 2.44 GHz Peak Log 10 dB/Offst 10.8 dB DI -18.7 dBm Amplitude: -0.019 dBm Start 30 MHz Stop 26.5 GHz #Res BW 100 kHz #VBW 300 kHz Sweep 2.742 s (401 pts) Marker 1 Trace (1) Type Freq X Axis 2.44 GHz Amplitude -0.019 dBm</p> <p>Freq/Channel Center Freq 13.2650000 GHz Start Freq 30.0000000 MHz Stop Freq 26.5000000 GHz CF Step 2.64700000 GHz Auto Man Freq Offset 0.00000000 Hz Signal Track On Off</p>
<p>2462</p>	 <p>Agilent R T Ref 10 dBm Atten 10 dB Mkr1 2.46 GHz Peak Log 10 dB/Offst 10.8 dB DI -18.3 dBm Amplitude: -0.363 dBm Start 30 MHz Stop 26.5 GHz #Res BW 100 kHz #VBW 300 kHz Sweep 2.742 s (401 pts) Marker 1 Trace (1) Type Freq X Axis 2.46 GHz Amplitude -0.363 dBm</p> <p>Freq/Channel Center Freq 13.2650000 GHz Start Freq 30.0000000 MHz Stop Freq 26.5000000 GHz CF Step 2.64700000 GHz Auto Man Freq Offset 0.00000000 Hz Signal Track On Off</p>

Mode 3: IEEE 802.11g link mode_ANT-1

<p>2412</p>	<p>Agilent R T</p> <p>Ref 10 dBm Atten 10 dB Mkr1 2.41 GHz 4.318 dBm</p> <p>Peak Log 10 dB/ Offst 10.8 dB DI -21.0 dBm</p> <p>Start 30 MHz Stop 26.5 GHz</p> <p>#Res BW 100 kHz #VBW 300 kHz Sweep 2.742 s (401 pts)</p> <table border="1"> <thead> <tr> <th>Marker</th> <th>Trace</th> <th>Type</th> <th>X Axis</th> <th>Amplitude</th> </tr> </thead> <tbody> <tr> <td>1</td> <td>(1)</td> <td>Freq</td> <td>2.41 GHz</td> <td>-4.318 dBm</td> </tr> </tbody> </table> <p>Freq/Channel</p> <p>Center Freq 13.2650000 GHz</p> <p>Start Freq 30.0000000 MHz</p> <p>Stop Freq 26.5000000 GHz</p> <p>CF Step 2.64700000 GHz Auto Man</p> <p>Freq Offset 0.00000000 Hz</p> <p>Signal Track On Off</p>	Marker	Trace	Type	X Axis	Amplitude	1	(1)	Freq	2.41 GHz	-4.318 dBm
Marker	Trace	Type	X Axis	Amplitude							
1	(1)	Freq	2.41 GHz	-4.318 dBm							
<p>2437</p>	<p>Agilent R T</p> <p>Ref 10 dBm Atten 10 dB Mkr1 2.44 GHz 3.782 dBm</p> <p>Peak Log 10 dB/ Offst 10.8 dB DI -21.3 dBm</p> <p>Start 30 MHz Stop 26.5 GHz</p> <p>#Res BW 100 kHz #VBW 300 kHz Sweep 2.742 s (401 pts)</p> <table border="1"> <thead> <tr> <th>Marker</th> <th>Trace</th> <th>Type</th> <th>X Axis</th> <th>Amplitude</th> </tr> </thead> <tbody> <tr> <td>1</td> <td>(1)</td> <td>Freq</td> <td>2.44 GHz</td> <td>-3.782 dBm</td> </tr> </tbody> </table> <p>Freq/Channel</p> <p>Center Freq 13.2650000 GHz</p> <p>Start Freq 30.0000000 MHz</p> <p>Stop Freq 26.5000000 GHz</p> <p>CF Step 2.64700000 GHz Auto Man</p> <p>Freq Offset 0.00000000 Hz</p> <p>Signal Track On Off</p>	Marker	Trace	Type	X Axis	Amplitude	1	(1)	Freq	2.44 GHz	-3.782 dBm
Marker	Trace	Type	X Axis	Amplitude							
1	(1)	Freq	2.44 GHz	-3.782 dBm							
<p>2462</p>	<p>Agilent R T</p> <p>Ref 10 dBm Atten 10 dB Mkr1 2.46 GHz 3.782 dBm</p> <p>Peak Log 10 dB/ Offst 10.8 dB DI -21.2 dBm</p> <p>Start 30 MHz Stop 26.5 GHz</p> <p>#Res BW 100 kHz #VBW 300 kHz Sweep 2.742 s (401 pts)</p> <table border="1"> <thead> <tr> <th>Marker</th> <th>Trace</th> <th>Type</th> <th>X Axis</th> <th>Amplitude</th> </tr> </thead> <tbody> <tr> <td>1</td> <td>(1)</td> <td>Freq</td> <td>2.46 GHz</td> <td>-3.782 dBm</td> </tr> </tbody> </table> <p>Freq/Channel</p> <p>Center Freq 13.2650000 GHz</p> <p>Start Freq 30.0000000 MHz</p> <p>Stop Freq 26.5000000 GHz</p> <p>CF Step 2.64700000 GHz Auto Man</p> <p>Freq Offset 0.00000000 Hz</p> <p>Signal Track On Off</p>	Marker	Trace	Type	X Axis	Amplitude	1	(1)	Freq	2.46 GHz	-3.782 dBm
Marker	Trace	Type	X Axis	Amplitude							
1	(1)	Freq	2.46 GHz	-3.782 dBm							

Mode 4: IEEE 802.11n 2.4GHz 20MHz link mode_ANT-1

<p>2412</p>	<p>Agilent R T</p> <p>Ref 10 dBm Atten 10 dB Mkr1 2.41 GHz -6.085 dBm</p> <p>Peak Log 10 dB/Offst 10.8 dB DI -24.0 dBm</p> <p>Start 30 MHz Stop 26.5 GHz</p> <table border="1"> <thead> <tr> <th>Marker</th> <th>Trace</th> <th>Type</th> <th>X Axis</th> <th>Amplitude</th> </tr> </thead> <tbody> <tr> <td>1</td> <td>(1)</td> <td>Freq</td> <td>2.41 GHz</td> <td>-6.085 dBm</td> </tr> </tbody> </table> <p>#Res BW 100 kHz #VBW 300 kHz Sweep 2.742 s (401 pts)</p> <p>Freq/Channel: Center Freq 13.2650000 GHz, Start Freq 30.0000000 MHz, Stop Freq 26.5000000 GHz, CF Step 2.64700000 GHz, Freq Offset 0.00000000 Hz, Signal Track On Off</p>	Marker	Trace	Type	X Axis	Amplitude	1	(1)	Freq	2.41 GHz	-6.085 dBm
Marker	Trace	Type	X Axis	Amplitude							
1	(1)	Freq	2.41 GHz	-6.085 dBm							
<p>2437</p>	<p>Agilent R T</p> <p>Ref 10 dBm Atten 10 dB Mkr1 2.44 GHz -7.954 dBm</p> <p>Peak Log 10 dB/Offst 10.8 dB DI -24.4 dBm</p> <p>Start 30 MHz Stop 26.5 GHz</p> <table border="1"> <thead> <tr> <th>Marker</th> <th>Trace</th> <th>Type</th> <th>X Axis</th> <th>Amplitude</th> </tr> </thead> <tbody> <tr> <td>1</td> <td>(1)</td> <td>Freq</td> <td>2.44 GHz</td> <td>-7.954 dBm</td> </tr> </tbody> </table> <p>#Res BW 100 kHz #VBW 300 kHz Sweep 2.742 s (401 pts)</p> <p>Freq/Channel: Center Freq 13.2650000 GHz, Start Freq 30.0000000 MHz, Stop Freq 26.5000000 GHz, CF Step 2.64700000 GHz, Freq Offset 0.00000000 Hz, Signal Track On Off</p>	Marker	Trace	Type	X Axis	Amplitude	1	(1)	Freq	2.44 GHz	-7.954 dBm
Marker	Trace	Type	X Axis	Amplitude							
1	(1)	Freq	2.44 GHz	-7.954 dBm							
<p>2462</p>	<p>Agilent R T</p> <p>Ref 10 dBm Atten 10 dB Mkr1 2.46 GHz -5.587 dBm</p> <p>Peak Log 10 dB/Offst 10.8 dB DI -24.0 dBm</p> <p>Start 30 MHz Stop 26.5 GHz</p> <table border="1"> <thead> <tr> <th>Marker</th> <th>Trace</th> <th>Type</th> <th>X Axis</th> <th>Amplitude</th> </tr> </thead> <tbody> <tr> <td>1</td> <td>(1)</td> <td>Freq</td> <td>2.46 GHz</td> <td>-5.587 dBm</td> </tr> </tbody> </table> <p>#Res BW 100 kHz #VBW 300 kHz Sweep 2.742 s (401 pts)</p> <p>Freq/Channel: Center Freq 13.2650000 GHz, Start Freq 30.0000000 MHz, Stop Freq 26.5000000 GHz, CF Step 2.64700000 GHz, Freq Offset 0.00000000 Hz, Signal Track On Off</p>	Marker	Trace	Type	X Axis	Amplitude	1	(1)	Freq	2.46 GHz	-5.587 dBm
Marker	Trace	Type	X Axis	Amplitude							
1	(1)	Freq	2.46 GHz	-5.587 dBm							

Mode 5: IEEE 802.11n 2.4GHz 40MHz link mode_ANT-1

<p>2422</p>	<p>Agilent R T</p> <p>Ref 10 dBm Atten 10 dB Mkr1 2.42 GHz -7.016 dBm</p> <p>Peak Log 10 dB/Offst 10.8 dB DI -25.8 dBm</p> <p>Start 30 MHz Stop 26.5 GHz</p> <table border="1"> <thead> <tr> <th>Marker</th> <th>Trace</th> <th>Type</th> <th>X Axis</th> <th>Amplitude</th> </tr> </thead> <tbody> <tr> <td>1</td> <td>(1)</td> <td>Freq</td> <td>2.42 GHz</td> <td>-7.016 dBm</td> </tr> </tbody> </table> <p>Freq/Channel</p> <p>Center Freq 13.2650000 GHz</p> <p>Start Freq 30.0000000 MHz</p> <p>Stop Freq 26.5000000 GHz</p> <p>CF Step 2.64700000 GHz Auto Man</p> <p>Freq Offset 0.00000000 Hz</p> <p>Signal Track On Off</p>	Marker	Trace	Type	X Axis	Amplitude	1	(1)	Freq	2.42 GHz	-7.016 dBm
Marker	Trace	Type	X Axis	Amplitude							
1	(1)	Freq	2.42 GHz	-7.016 dBm							
<p>2437</p>	<p>Agilent R T</p> <p>Ref 10 dBm Atten 10 dB Mkr1 2.44 GHz -8.314 dBm</p> <p>Peak Log 10 dB/Offst 10.8 dB DI -26.5 dBm</p> <p>Start 30 MHz Stop 26.5 GHz</p> <table border="1"> <thead> <tr> <th>Marker</th> <th>Trace</th> <th>Type</th> <th>X Axis</th> <th>Amplitude</th> </tr> </thead> <tbody> <tr> <td>1</td> <td>(1)</td> <td>Freq</td> <td>2.44 GHz</td> <td>-8.314 dBm</td> </tr> </tbody> </table> <p>Freq/Channel</p> <p>Center Freq 13.2650000 GHz</p> <p>Start Freq 30.0000000 MHz</p> <p>Stop Freq 26.5000000 GHz</p> <p>CF Step 2.64700000 GHz Auto Man</p> <p>Freq Offset 0.00000000 Hz</p> <p>Signal Track On Off</p>	Marker	Trace	Type	X Axis	Amplitude	1	(1)	Freq	2.44 GHz	-8.314 dBm
Marker	Trace	Type	X Axis	Amplitude							
1	(1)	Freq	2.44 GHz	-8.314 dBm							
<p>2452</p>	<p>Agilent R T</p> <p>Ref 10 dBm Atten 10 dB Mkr1 2.45 GHz -7.163 dBm</p> <p>Peak Log 10 dB/Offst 10.8 dB DI -25.4 dBm</p> <p>Start 30 MHz Stop 26.5 GHz</p> <table border="1"> <thead> <tr> <th>Marker</th> <th>Trace</th> <th>Type</th> <th>X Axis</th> <th>Amplitude</th> </tr> </thead> <tbody> <tr> <td>1</td> <td>(1)</td> <td>Freq</td> <td>2.45 GHz</td> <td>-7.163 dBm</td> </tr> </tbody> </table> <p>Freq/Channel</p> <p>Center Freq 13.2650000 GHz</p> <p>Start Freq 30.0000000 MHz</p> <p>Stop Freq 26.5000000 GHz</p> <p>CF Step 2.64700000 GHz Auto Man</p> <p>Freq Offset 0.00000000 Hz</p> <p>Signal Track On Off</p>	Marker	Trace	Type	X Axis	Amplitude	1	(1)	Freq	2.45 GHz	-7.163 dBm
Marker	Trace	Type	X Axis	Amplitude							
1	(1)	Freq	2.45 GHz	-7.163 dBm							

Mode 4: IEEE 802.11n 2.4GHz 20MHz link mode_ANT-2

<p>2412</p>	<p>Agilent R T</p> <p>Ref 10 dBm Atten 10 dB Mkr1 2.41 GHz -5.944 dBm</p> <p>Peak Log 10 dB/Offst 10.8 dB DI -23.9 dBm</p> <p>Start 30 MHz Stop 26.5 GHz</p> <table border="1"> <thead> <tr> <th>Marker</th> <th>Trace</th> <th>Type</th> <th>X Axis</th> <th>Amplitude</th> </tr> </thead> <tbody> <tr> <td>1</td> <td>(1)</td> <td>Freq</td> <td>2.41 GHz</td> <td>-5.944 dBm</td> </tr> </tbody> </table> <p>Freq/Channel</p> <p>Center Freq 13.2650000 GHz</p> <p>Start Freq 30.0000000 MHz</p> <p>Stop Freq 26.5000000 GHz</p> <p>CF Step 2.64700000 GHz</p> <p>Freq Offset 0.00000000 Hz</p> <p>Signal Track On Off</p>	Marker	Trace	Type	X Axis	Amplitude	1	(1)	Freq	2.41 GHz	-5.944 dBm
Marker	Trace	Type	X Axis	Amplitude							
1	(1)	Freq	2.41 GHz	-5.944 dBm							
<p>2437</p>	<p>Agilent R T</p> <p>Ref 10 dBm Atten 10 dB Mkr1 2.44 GHz -6.19 dBm</p> <p>Peak Log 10 dB/Offst 10.8 dB DI -24.2 dBm</p> <p>Start 30 MHz Stop 26.5 GHz</p> <table border="1"> <thead> <tr> <th>Marker</th> <th>Trace</th> <th>Type</th> <th>X Axis</th> <th>Amplitude</th> </tr> </thead> <tbody> <tr> <td>1</td> <td>(1)</td> <td>Freq</td> <td>2.44 GHz</td> <td>-6.19 dBm</td> </tr> </tbody> </table> <p>Freq/Channel</p> <p>Center Freq 13.2650000 GHz</p> <p>Start Freq 30.0000000 MHz</p> <p>Stop Freq 26.5000000 GHz</p> <p>CF Step 2.64700000 GHz</p> <p>Freq Offset 0.00000000 Hz</p> <p>Signal Track On Off</p>	Marker	Trace	Type	X Axis	Amplitude	1	(1)	Freq	2.44 GHz	-6.19 dBm
Marker	Trace	Type	X Axis	Amplitude							
1	(1)	Freq	2.44 GHz	-6.19 dBm							
<p>2462</p>	<p>Agilent R T</p> <p>Ref 10 dBm Atten 10 dB Mkr1 2.46 GHz -4.669 dBm</p> <p>Peak Log 10 dB/Offst 10.8 dB DI -24.6 dBm</p> <p>Start 30 MHz Stop 26.5 GHz</p> <table border="1"> <thead> <tr> <th>Marker</th> <th>Trace</th> <th>Type</th> <th>X Axis</th> <th>Amplitude</th> </tr> </thead> <tbody> <tr> <td>1</td> <td>(1)</td> <td>Freq</td> <td>2.46 GHz</td> <td>-4.669 dBm</td> </tr> </tbody> </table> <p>Freq/Channel</p> <p>Center Freq 13.2650000 GHz</p> <p>Start Freq 30.0000000 MHz</p> <p>Stop Freq 26.5000000 GHz</p> <p>CF Step 2.64700000 GHz</p> <p>Freq Offset 0.00000000 Hz</p> <p>Signal Track On Off</p>	Marker	Trace	Type	X Axis	Amplitude	1	(1)	Freq	2.46 GHz	-4.669 dBm
Marker	Trace	Type	X Axis	Amplitude							
1	(1)	Freq	2.46 GHz	-4.669 dBm							

Mode 5: IEEE 802.11n 2.4GHz 40MHz link mode_ANT-2

<p>2422</p>	<p>Agilent R T</p> <p>Ref 10 dBm Atten 10 dB Mkr1 2.42 GHz -7.799 dBm</p> <p>Peak Log 10 dB/ Offst 10.8 dB DI -26.5 dBm</p> <p>Start 30 MHz Stop 26.5 GHz</p> <table border="1"> <thead> <tr> <th>#Res</th> <th>BW</th> <th>Type</th> <th>X Axis</th> <th>Amplitude</th> </tr> </thead> <tbody> <tr> <td>1</td> <td>100 kHz</td> <td>Freq</td> <td>2.42 GHz</td> <td>-7.799 dBm</td> </tr> </tbody> </table> <p>Freq/Channel</p> <p>Center Freq 13.2650000 GHz</p> <p>Start Freq 30.0000000 MHz</p> <p>Stop Freq 26.5000000 GHz</p> <p>CF Step 2.64700000 GHz Auto Man</p> <p>Freq Offset 0.00000000 Hz</p> <p>Signal Track On Off</p>	#Res	BW	Type	X Axis	Amplitude	1	100 kHz	Freq	2.42 GHz	-7.799 dBm
#Res	BW	Type	X Axis	Amplitude							
1	100 kHz	Freq	2.42 GHz	-7.799 dBm							
<p>2437</p>	<p>Agilent R T</p> <p>Ref 10 dBm Atten 10 dB Mkr1 2.44 GHz -6.19 dBm</p> <p>Peak Log 10 dB/ Offst 10.8 dB DI -26.8 dBm</p> <p>Start 30 MHz Stop 26.5 GHz</p> <table border="1"> <thead> <tr> <th>#Res</th> <th>BW</th> <th>Type</th> <th>X Axis</th> <th>Amplitude</th> </tr> </thead> <tbody> <tr> <td>1</td> <td>100 kHz</td> <td>Freq</td> <td>2.44 GHz</td> <td>-6.19 dBm</td> </tr> </tbody> </table> <p>Freq/Channel</p> <p>Center Freq 13.2650000 GHz</p> <p>Start Freq 30.0000000 MHz</p> <p>Stop Freq 26.5000000 GHz</p> <p>CF Step 2.64700000 GHz Auto Man</p> <p>Freq Offset 0.00000000 Hz</p> <p>Signal Track On Off</p>	#Res	BW	Type	X Axis	Amplitude	1	100 kHz	Freq	2.44 GHz	-6.19 dBm
#Res	BW	Type	X Axis	Amplitude							
1	100 kHz	Freq	2.44 GHz	-6.19 dBm							
<p>2452</p>	<p>Agilent R T</p> <p>Ref 10 dBm Atten 10 dB Mkr1 2.45 GHz -6.966 dBm</p> <p>Peak Log 10 dB/ Offst 10.8 dB DI -25.5 dBm</p> <p>Start 30 MHz Stop 26.5 GHz</p> <table border="1"> <thead> <tr> <th>#Res</th> <th>BW</th> <th>Type</th> <th>X Axis</th> <th>Amplitude</th> </tr> </thead> <tbody> <tr> <td>1</td> <td>100 kHz</td> <td>Freq</td> <td>2.45 GHz</td> <td>-6.966 dBm</td> </tr> </tbody> </table> <p>Freq/Channel</p> <p>Center Freq 13.2650000 GHz</p> <p>Start Freq 30.0000000 MHz</p> <p>Stop Freq 26.5000000 GHz</p> <p>CF Step 2.64700000 GHz Auto Man</p> <p>Freq Offset 0.00000000 Hz</p> <p>Signal Track On Off</p>	#Res	BW	Type	X Axis	Amplitude	1	100 kHz	Freq	2.45 GHz	-6.966 dBm
#Res	BW	Type	X Axis	Amplitude							
1	100 kHz	Freq	2.45 GHz	-6.966 dBm							

Conducted Band Edge

Mode 2: IEEE 802.11b link mode_ANT-1

2412

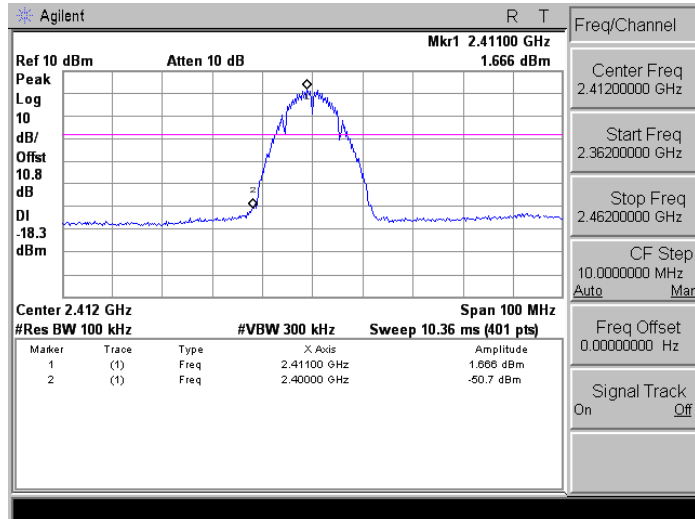

2462

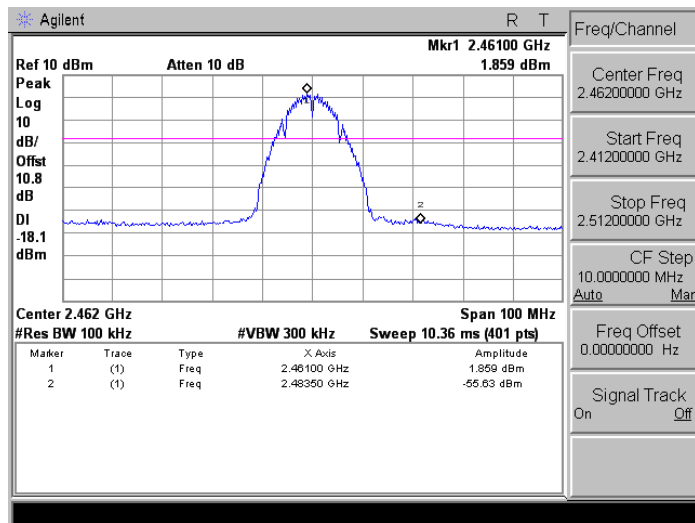

Mode 3: IEEE 802.11g link mode_ANT-1

2412

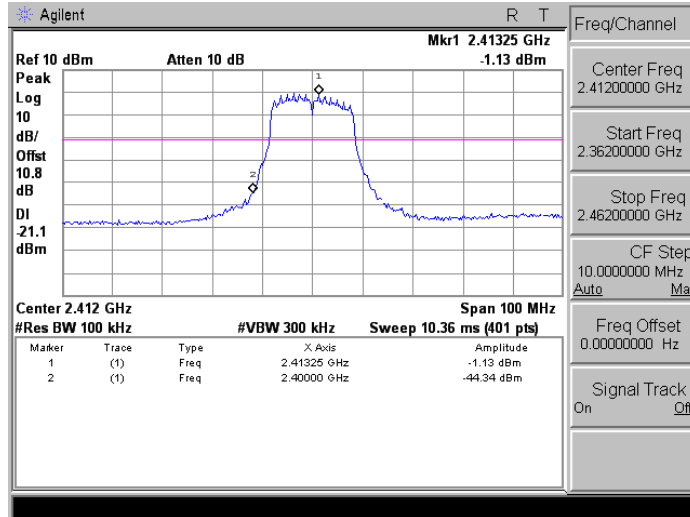

2462

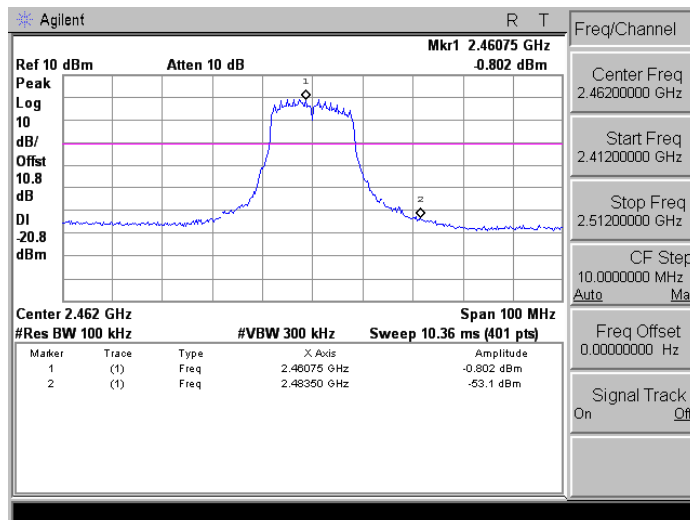

Mode 4: IEEE 802.11n 2.4GHz 20MHz link mode_ANT-1

2412

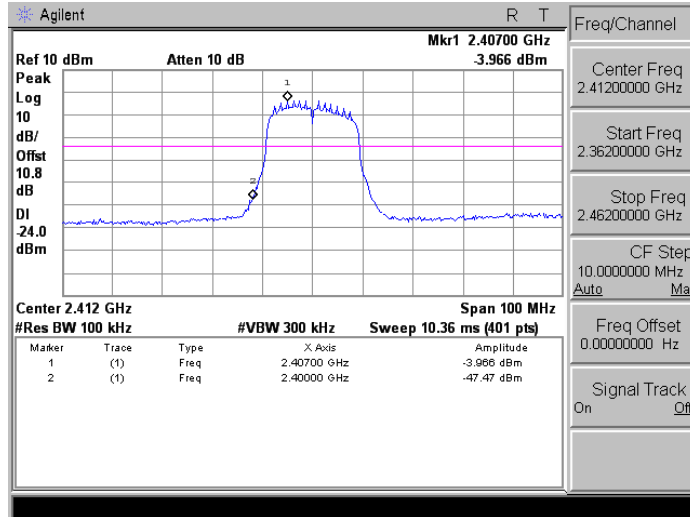

2462

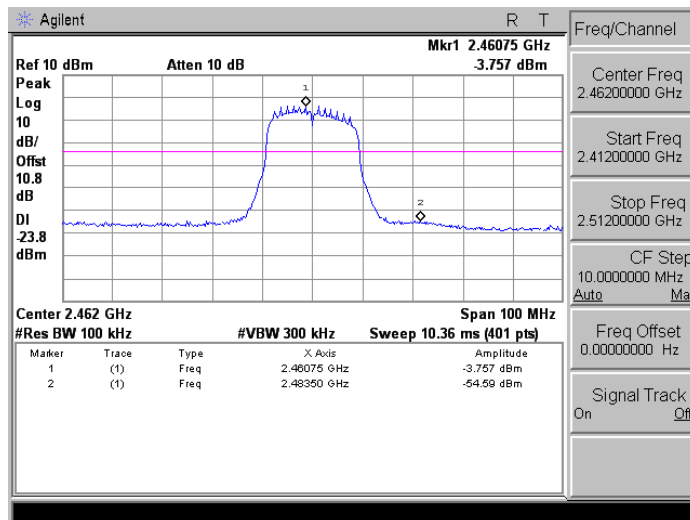

Mode 5: IEEE 802.11n 2.4GHz 40MHz link mode_ANT-1

2422

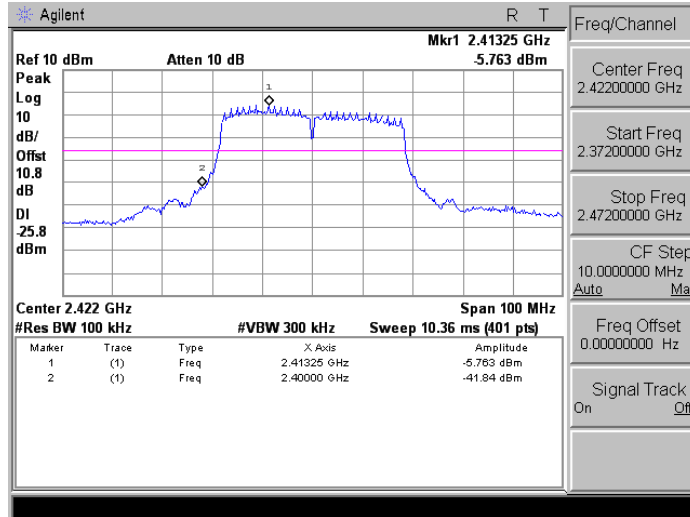

2452

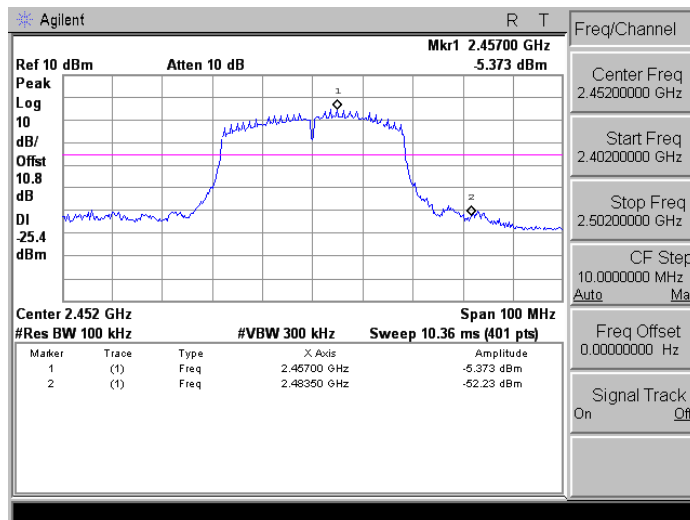

Mode 4: IEEE 802.11n 2.4GHz 20MHz link mode_ANT-2

2412

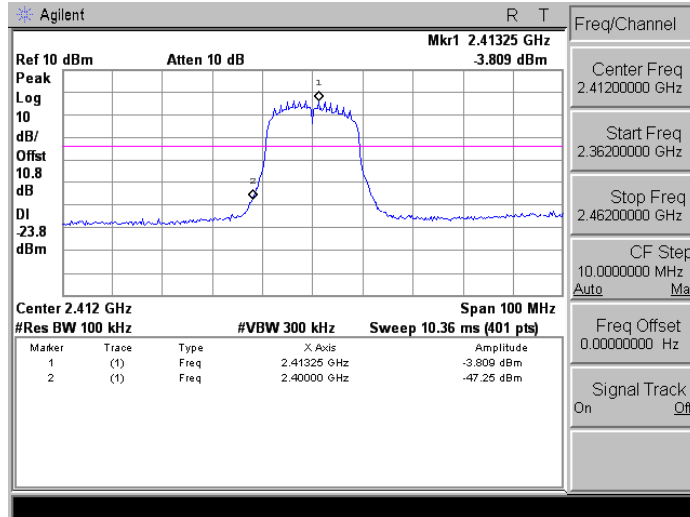

2462

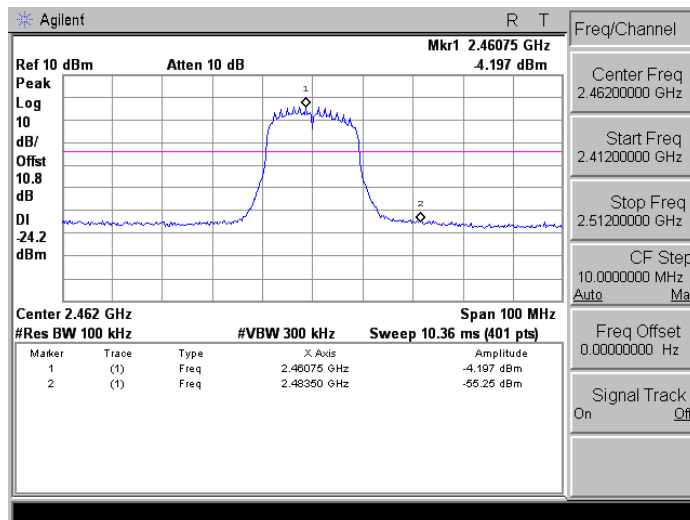

Mode 5: IEEE 802.11n 2.4GHz 40MHz link mode_ANT-2

2422

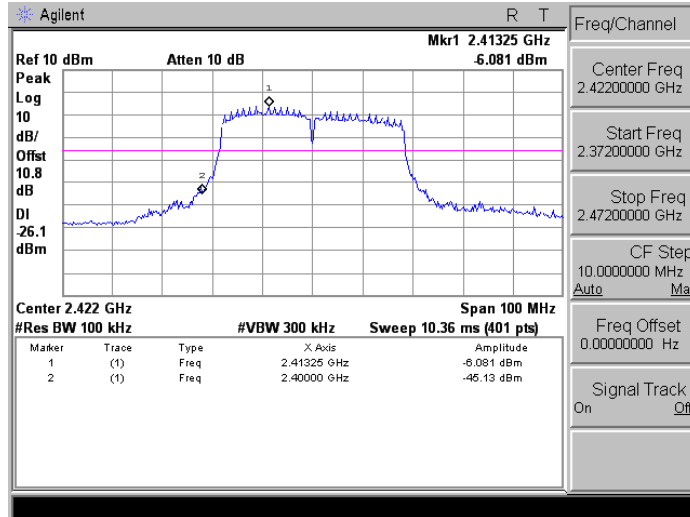

2452

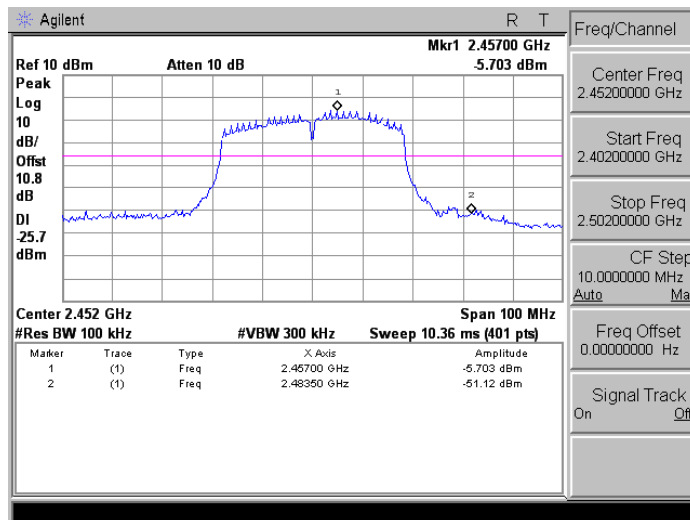

10 Band Edges Measurement

10.1.Limit

In any 100 kHz bandwidth outside the intentional radiation frequency band, the radio frequency power shall be at least 30 dB below the highest level of the radiated power. In addition, radiated emissions which fall in the restricted bands must also comply with the radiated emission limits.

10.2.Test Setup

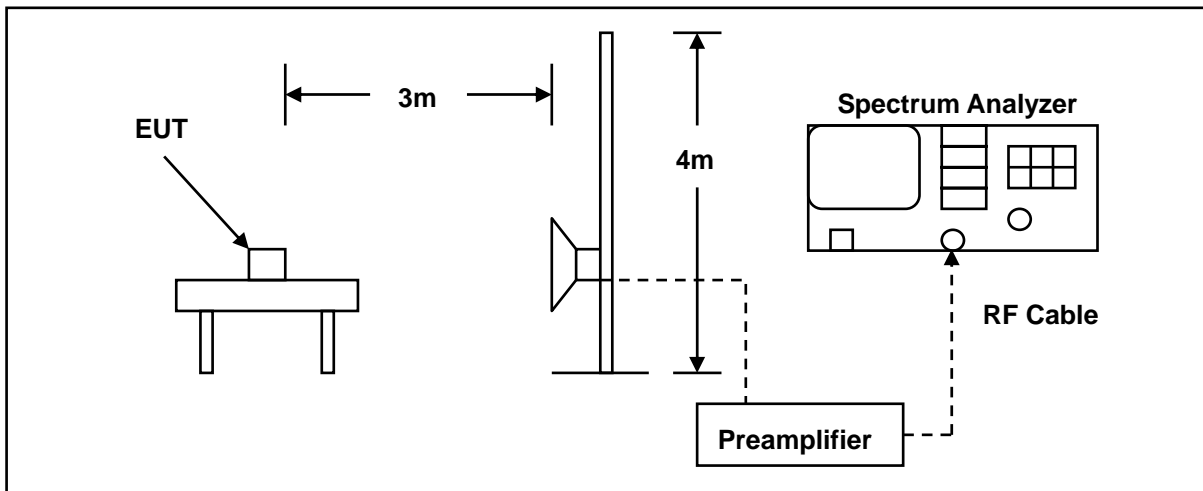

10.3.Test Instruments

3 Meter Chamber					
Equipment	Manufacturer	Model Number	Serial Number	Cal. Date	Remark
RF Pre-selector	Agilent	N9039A	MY46520256	01/06/2015	(1)
Spectrum Analyzer	Agilent	E4446A	MY46180578	01/06/2015	(1)
Pre Amplifier	Agilent	8449B	3008A02237	02/24/2015	(1)
Pre Amplifier	Agilent	8447D	2944A10961	02/24/2015	(1)
Horn Antenna (1~18GHz)	SCHWARZBECK MESS-ELEKTRONIK	BBHA9120D	9120D-550	06/11/2014	(1)
Microwave Cable	EMCI	EMC-104-SM-S M-14000	140202	02/24/2015	(1)
Microwave Cable	EMCI	EMC104-SM-S M-600	140301	02/24/2015	(1)
Test Site	ATL	TE01	888001	08/28/2014	(1)

Remark: (1) Calibration period 1 year. (2) Calibration period 2 years. (3) Calibration period 3 years.

Note: N.C.R. = No Calibration Request.

10.4. Test Procedure

The EUT tested to DTS test procedure of KDB558074D01 for compliance to FCC 47CFR 15.247 requirements.

The emissions on the harmonics frequencies, the limits, and the margin of compliance are presented. These tests were made when the transmitter was in full radiated power. The additional test was performed to show compliance with the requirement at the band-edge frequency 2483.5 MHz and up to 2500 MHz and at 2390.0 MHz.

The transmitter was configured with the worst case antenna and setup to transmit at the highest channel. Then the field strength was measured at 2483.5 MHz.

The transmitter was then configured with the worst case antenna and setup to transmit at the lowest channel. Then the field strength was measured at 2390.0 MHz. These tests were performed at 4 different bit rates.

For measurements the resolution bandwidth is set to 1 MHz, and then the video bandwidth is set to 1 MHz for peak measurements and 1/T for average measurements.

10.5. Test Result

Standard:	FCC Part 15C	Test Distance:	3m				
Test item:	Radiated Emission	Power:	AC 120V/60Hz				
Model Number:	AC791L	Temp.(°C)/Hum.(%RH):	26(°C)/60%RH				
Mode:	Mode 2	Date:	05/08/2015				
Frequency:	2412 MHz	Test By:	Eric Ou Yang				
Frequency (MHz)	Reading (dBuV)	Correct Factor (dB/m)	Result (dBuV/m)	Limit (dBuV/m)	Margin (dB)	Remark	Ant.Polar. H / V
2388.980	50.13	-0.47	49.66	74.00	-24.34	peak	H
2390.000	49.68	-0.46	49.22	74.00	-24.78	peak	H
2337.610	50.30	-0.69	49.61	74.00	-24.39	peak	V
2390.000	47.37	-0.46	46.91	74.00	-27.09	peak	V

Standard:	FCC Part 15C	Test Distance:	3m				
Test item:	Radiated Emission	Power:	AC 120V/60Hz				
Model Number:	AC791L	Temp.(°C)/Hum.(%RH):	26(°C)/60%RH				
Mode:	Mode 2	Date:	05/08/2015				
Frequency:	2462 MHz	Test By:	Eric Ou Yang				
Frequency (MHz)	Reading (dBuV)	Correct Factor (dB/m)	Result (dBuV/m)	Limit (dBuV/m)	Margin (dB)	Remark	Ant.Polar. H / V
2483.500	48.94	-0.06	48.88	74.00	-25.12	peak	H
2485.240	50.25	-0.06	50.19	74.00	-23.81	peak	H
2483.500	47.26	-0.06	47.20	74.00	-26.80	peak	V
2491.240	49.40	-0.03	49.37	74.00	-24.63	peak	V

Standard:	FCC Part 15C			Test Distance:	3m		
Test item:	Radiated Emission			Power:	AC 120V/60Hz		
Model Number:	AC791L			Temp.(°C)/Hum.(%RH):	26(°C)/60%RH		
Mode:	Mode 3			Date:	05/08/2015		
Frequency:	2412 MHz			Test By:	Eric Ou Yang		
Frequency (MHz)	Reading (dBuV)	Correct Factor (dB/m)	Result (dBuV/m)	Limit (dBuV/m)	Margin (dB)	Remark	Ant.Polar. H / V
2387.880	49.75	-0.47	49.28	74.00	-24.72	peak	H
2390.000	49.05	-0.46	48.59	74.00	-25.41	peak	H
2342.230	51.15	-0.67	50.48	74.00	-23.52	peak	V
2390.000	47.52	-0.46	47.06	74.00	-26.94	peak	V

Standard:	FCC Part 15C			Test Distance:	3m		
Test item:	Radiated Emission			Power:	AC 120V/60Hz		
Model Number:	AC791L			Temp.(°C)/Hum.(%RH):	26(°C)/60%RH		
Mode:	Mode 3			Date:	05/08/2015		
Frequency:	2462 MHz			Test By:	Eric Ou Yang		
Frequency (MHz)	Reading (dBuV)	Correct Factor (dB/m)	Result (dBuV/m)	Limit (dBuV/m)	Margin (dB)	Remark	Ant.Polar. H / V
2483.500	50.82	-0.06	50.76	74.00	-23.24	peak	H
2485.320	51.49	-0.06	51.43	74.00	-22.57	peak	H
2483.500	47.94	-0.06	47.88	74.00	-26.12	peak	V
2484.320	50.43	-0.06	50.37	74.00	-23.63	peak	V

Standard:	FCC Part 15C	Test Distance:	3m
Test item:	Radiated Emission	Power:	AC 120V/60Hz
Model Number:	AC791L	Temp.(°C)/Hum.(%RH):	26(°C)/60%RH
Mode:	Mode 4	Date:	05/08/2015
Frequency:	2412 MHz	Test By:	Eric Ou Yang

Frequency (MHz)	Reading (dBuV)	Correct Factor (dB/m)	Result (dBuV/m)	Limit (dBuV/m)	Margin (dB)	Remark	Ant.Polar. H / V
2387.770	50.43	-0.47	49.96	74.00	-24.04	peak	H
2390.000	49.60	-0.46	49.14	74.00	-24.86	peak	H
2387.440	49.35	-0.47	48.88	74.00	-25.12	peak	V
2390.000	46.51	-0.46	46.05	74.00	-27.95	peak	V

Standard:	FCC Part 15C	Test Distance:	3m
Test item:	Radiated Emission	Power:	AC 120V/60Hz
Model Number:	AC791L	Temp.(°C)/Hum.(%RH):	26(°C)/60%RH
Mode:	Mode 4	Date:	05/08/2015
Frequency:	2462 MHz	Test By:	Eric Ou Yang

Frequency (MHz)	Reading (dBuV)	Correct Factor (dB/m)	Result (dBuV/m)	Limit (dBuV/m)	Margin (dB)	Remark	Ant.Polar. H / V
2483.500	51.81	-0.06	51.75	74.00	-22.25	peak	H
2485.520	51.93	-0.05	51.88	74.00	-22.12	peak	H
2483.500	50.07	-0.06	50.01	74.00	-23.99	peak	V
2499.000	50.40	0.01	50.41	74.00	-23.59	peak	V

Standard:	FCC Part 15C			Test Distance:	3m		
Test item:	Radiated Emission			Power:	AC 120V/60Hz		
Model Number:	AC791L			Temp.(°C)/Hum.(%RH):	26(°C)/60%RH		
Mode:	Mode 5			Date:	01/24/2015		
Frequency:	2422 MHz			Test By:	Eric Ou Yang		
Frequency (MHz)	Reading (dBuV)	Correct Factor (dB/m)	Result (dBuV/m)	Limit (dBuV/m)	Margin (dB)	Remark	Ant.Polar. H / V
2388.480	66.07	-0.47	65.60	74.00	-8.40	peak	H
2388.480	42.59	-0.47	42.12	54.00	-11.88	AVG	H
2390.000	53.58	-0.46	53.12	74.00	-20.88	peak	H
2390.000	42.84	-0.46	42.38	54.00	-11.62	AVG	H
2365.200	49.61	-0.57	49.04	74.00	-24.96	peak	V
2390.000	49.03	-0.46	48.57	74.00	-25.43	peak	V

Standard:	FCC Part 15C			Test Distance:	3m		
Test item:	Radiated Emission			Power:	AC 120V/60Hz		
Model Number:	AC791L			Temp.(°C)/Hum.(%RH):	26(°C)/60%RH		
Mode:	Mode 5			Date:	01/24/2015		
Frequency:	2452 MHz			Test By:	Eric Ou Yang		
Frequency (MHz)	Reading (dBuV)	Correct Factor (dB/m)	Result (dBuV/m)	Limit (dBuV/m)	Margin (dB)	Remark	Ant.Polar. H / V
2483.500	52.18	-0.06	52.12	74.00	-21.88	peak	H
2483.500	40.94	-0.06	40.88	54.00	-13.12	AVG	H
2484.700	62.08	-0.06	62.02	74.00	-11.98	peak	H
2484.700	40.30	-0.06	40.24	54.00	-13.76	AVG	H
2483.500	48.28	-0.06	48.22	74.00	-25.78	peak	V
2483.550	58.62	-0.06	58.56	74.00	-15.44	peak	V
2483.550	39.34	-0.06	39.28	54.00	-14.72	AVG	V

11 Antenna Measurement

11.1.Limit

For intentional device, according to 15.203, an intentional radiator shall be designed to ensure that no antenna other than that furnished by the responsible party shall be used with the device.

And According to 15.247 (b), if transmitting antennas of directional gain greater than 6 dBi are used, the power shall be reduced by the amount in dB that the directional gain of the antenna exceeds 6dBi.

11.2.Antenna Connector Construction

The antenna used in this product is Internal IFA type. And the maximum Gain of this antenna is only 1 dBi.