

TAS Validation Report

(Part 2 - Test Under Dynamic Transmission Condition)

Report No. : SFBBQZ-WTW-P24030292-2

Applicant and Manufacturer : NETGEAR, INC.

Address : 350 East Plumeria Drive San Jose CA 95134

Product : Nighthawk 5G Mobile Router

FCC ID : PY324100618

Brand : NETGEAR

Model No. : MR7400

FCC Rule Part : CFR §2.1093

Sample Received Date : Mar. 29, 2024

Date of Testing : Jun. 17, 2024 ~ Jun. 21, 2024

Lab Address : No. 47-2, 14th Ling, Chia Pau Vil., Lin Kou Dist., New Taipei City, Taiwan

Test Location : No. 19, Hwa Ya 2nd Rd., Wen Hwa Vil., Kwei Shan Dist., Taoyuan City, Taiwan

CERTIFICATION: The above equipment have been tested by **Bureau Veritas Consumer Products Services (H.K.) Ltd., Taoyuan Branch-Lin Kou Laboratories**, and found compliance with the requirement of the above standards. The test record, data evaluation & Equipment Under Test (EUT) configurations represented herein are true and accurate accounts of the measurements of the sample's SAR characteristics under the conditions specified in this report. It should not be reproduced except in full, without the written approval of our laboratory. The client should not use it to claim product certification, approval, or endorsement by TAF or any government agencies.

Prepared By :



Vera Huang / Specialist

Approved By :



Gordon Lin / Manager

This report is governed by, and incorporates by reference, the Conditions of Testing as posted at the date of issuance of this report at <http://www.bureauveritas.com/home/about-us/our-business/cps/about-us/terms-conditions/> and is intended for your exclusive use. Any copying or replication of this report to or for any other person or entity, or use of our name or trademark, is permitted only with our prior written permission. This report sets forth our findings solely with respect to the test samples identified herein. The results set forth in this report are not indicative or representative of the quality or characteristics of the lot from which a test sample was taken or any similar or identical product unless specifically and expressly noted. Our report includes all of the tests requested by you and the results thereof based upon the information that you provided to us. Measurement uncertainty is only provided upon request for accredited tests. Statements of conformity are based on simple acceptance criteria without taking measurement uncertainty into account, unless otherwise requested in writing. You have 60 days from date of issuance of this report to notify us of any material error or omission caused by our negligence or if you require measurement uncertainty; provided, however, that such notice shall be in writing and shall specifically address the issue you wish to raise. A failure to raise such issue within the prescribed time shall constitute your unqualified acceptance of the completeness of this report, the tests conducted and the correctness of the report contents.

Table of Contents

Release Control Record	3
1. Introduction.....	4
2. Time Varying Transmission Test Cases	5
3. Sub-6 Validation Test Plan.....	8
3.1 Test Sequence Determination for Validation.....	8
3.2 Test Configuration Selection Criteria for Validating Smart Transmit	11
3.3 Test Procedures for Conducted Power Tests	15
3.4 Test Procedures for Time-Varying SAR Tests.....	22
4. Sub-6 Measurement Test Setup	23
4.1 Conducted Measurement Test Setup	23
4.2 SAR Measurement Test Setup	25
5. Test Configurations.....	26
5.1 WWAN Sub-6 Transmission.....	26
6. Conducted Power Test Results for Sub-6 Smart Transmit Validation	28
6.1 P_{limit} and P_{max} Measurement Results.....	28
6.2 Time-Varying Transmission Power Measurement Results	28
6.3 Call Drop Test Results.....	37
6.4 Change in Time Window Test Results	39
6.5 Switch in SAR Exposure Test Results	41
7. SAR Test Results for Sub-6 Smart Transmit Validation.....	42
7.1 SAR Tissue Verification.....	42
7.2 Test System Verification	43
8. Test Equipment List	44
9. Measurement Uncertainty	45
10. Information of the Testing Laboratories.....	47

Appendix A. Plots of System Verification

Appendix Z. Calibration Certificate for Probe and Dipole

1. Introduction

This device is enabled with Qualcomm Smart Transmit algorithm to control and manage transmitting power in real time and to ensure that the time-averaged RF exposure from LTE/5G NR WWAN is in compliance with FCC requirements. This Part-0 report shows SAR characterization of WWAN radios for LTE/5G NR. The characterization is achieved by determining P_{limit} for LTE/5G NR that corresponds to the exposure design targets after accounting for all device design related uncertainties. The SAR characterization is denoted as SAR Char in this report.

The compliance test under the static transmission scenario and simultaneous transmission analysis are reported in Part-1 report. The validation of the time-averaging algorithm and compliance under the dynamic (time-varying) transmission scenario for WWAN technologies are reported in this Part-2 report.

DUT contains embedded file system (EFS) version 15 configured for the first generation (GEN1). Additionally, this device supports WLAN and Bluetooth technologies but the output power of these modems is not controlled by the Smart Transmit algorithm.

2. Time Varying Transmission Test Cases

To validate the time averaging feature and demonstrate the compliance in Tx varying transmission conditions, the following transmission scenarios are covered in the Part 2 test:

1. During a time-varying Tx power transmission: To prove that the Smart Transmit feature accounts for Tx power variations in time accurately.
2. During a call disconnect and re-establish scenario: To prove that the Smart Transmit feature accounts for history of past Tx power transmissions accurately.
3. During a technology/band handover: To prove that the Smart Transmit feature functions correctly during transitions in technology/band.
4. During a DSI (Device State Index) change: To prove that the Smart Transmit feature functions correctly during transition from one device state (DSI) to another.
5. During an antenna (or beam) switch: To prove that the Smart Transmit feature functions correctly during transitions in antenna (such as AsDiv scenario) or beams (different antenna array configurations) or beams (different antenna array configurations).
6. During time window switch: To prove that the Smart Transmit feature correctly handles the transition from one time window to another specified by FCC, and maintains the normalized time-averaged RF exposure to be less than normalized FCC limit of 1.0 at all times.
7. SAR exposure switching between two active radios (radio1 and radio2): To prove that the Smart Transmit feature functions correctly and ensures total RF exposure compliance when exposure varies among SAR_radio1 only, SAR_radio1 + SAR_radio2, and SAR_radio2 only scenarios.
8. SAR exposure switching between sub6 radios favor modes: To prove that the Smart Transmit feature functions correctly and ensures total RF exposure compliance when exposure varies among sub6 radio1 + sub6 radio2 favor mode.

As described in Part 0 report, the RF exposure is proportional to the Tx power for a SAR- and PD-characterized wireless device. Thus, feature validation in Part 2 can be effectively performed through conducted (for $f < 6\text{GHz}$) and radiated (for $f \geq 6\text{GHz}$) power measurement. Therefore, the compliance demonstration under dynamic transmission conditions and feature validation are done in conducted/radiated power measurement setup for transmission scenario 1 through 9.

To add confidence in the feature validation, the time-averaged SAR and PD measurements are also performed but only performed for transmission scenario 1 to avoid the complexity in SAR and PD measurement (such as, for scenario 3 requiring change in SAR probe calibration file to accommodate different bands and/or tissue simulating liquid).

TAS Validation Report

The strategy for testing in Tx varying transmission condition is outlined as follows:

Conducted Power / Radiated Power Measurement

- Demonstrate the total RF exposure averaged over FCC defined time windows does not exceed FCC's SAR, through time-averaged power measurements
- Measure conducted Tx power (for $f < 6$ GHz) versus time, and radiated Tx power (EIRP for $f > 10$ GHz) versus time.
- Convert it into RF exposure and divide by respective FCC limits to get normalized exposure versus time.
- Perform running time-averaging over FCC defined time windows.
- Demonstrate that the total normalized time-averaged RF exposure is less than 1 for all transmission scenarios (i.e., transmission scenarios 1, 2, 3, 4, 5, 6, 7, and 8) at all times.

Mathematical expression:

➤ For Sub-6 transmission only:

$$1g_or_10gSAR(t) = \frac{conducted_Tx_power(t)}{conducted_Tx_power_P_{limit}} * 1g_or_10gSAR_P_{limit} \quad (3a)$$

$$\frac{1}{T_{SAR}} \int_{t-T_{SAR}}^t 1g_or_10gSAR(t) dt \leq 1 \quad (3b)$$

$FCC\ SAR_{limit}$

where, $conducted_Tx_power(t)$, $conducted_Tx_power_P_{limit}$, and $1g_or_10gSAR_P_{limit}$ correspond to the measured instantaneous conducted Tx power, measured conducted Tx power at P_{limit} , and measured 1gSAR or 10gSAR values at P_{limit} corresponding to sub-6 transmission.

TAS Validation Report

RF Exposure Measurement

- Demonstrate the total RF exposure averaged over FCC defined time windows does not exceed FCC's SAR, through time-averaged SAR measurements. Note as mentioned earlier, this measurement is performed for transmission scenario 1 only.
- For Sub-6 transmission only, measure instantaneous SAR versus time; for LTE + Sub-6 NR transmission, request low power (or all-down bits) on LTE so that measured SAR predominantly corresponds to Sub-6 NR.
- Convert it into RF exposure and divide by respective FCC limits to obtain normalized exposure versus time.
- Perform time averaging over FCC defined time window.
- Demonstrate that the total normalized time-averaged RF exposure is less than 1 for transmission scenario 1 at all times.

Mathematical expression:

➤ For sub-6 transmission only:

$$1g_or_10gSAR(t) = \frac{pointSAR(t)}{pointSAR_{P_{limit}}} * 1g_or_10gSAR_{P_{limit}} \quad (5a)$$

$$\frac{\frac{1}{T_{SAR}} \int_{t-T_{SAR}}^t 1g_or_10gSAR(t) dt}{FCC SAR_{limit}} \leq 1 \quad (5b)$$

where, $pointSAR(t)$, $pointSAR_{P_{limit}}$, and $1g_or_10gSAR_{P_{limit}}$ correspond to the measured instantaneous point SAR, measured point SAR at P_{limit} , and measured 1gSAR or 10gSAR values at P_{limit} corresponding to sub-6 transmission.

Note : SPEAG cDASY6 measurement system measures relative E-field, and provides ratio in dB given by

$$10 * \log_{10} \left\{ \frac{[pointE(t)]^2}{([pointE_{input} \cdot power.limit])^2} \right\} \text{versus time} \quad (11)$$

3. Sub-6 Validation Test Plan

This chapter provides the test plan and test procedure for validating Qualcomm Smart Transmit feature for sub-6 transmission. The 100 seconds time window for operating $f < 3\text{GHz}$ is used as an example to detail the test procedures in this chapter. The same test plan and test procedures described in this chapter apply to 60 seconds time window for operating $f \geq 3\text{GHz}$.

3.1 Test Sequence Determination for Validation

Following the FCC recommendation, two test sequences having time-variation in Tx power are predefined for sub-6 ($f < 6\text{GHz}$) validation:

- Test Sequence 1 : Request DUT to transmit at maximum power, measured P_{max}^{\dagger} , for 80s, then requesting for half of the maximum power, i.e., measured $P_{max}/2$, for the rest of the time.
- Test Sequence 2 : Request DUT to transmit at time-varying Tx power levels. This sequence is generated relative to measured P_{max} , measured P_{limit} and calculated $P_{reserve}$ ($= \text{measured } P_{limit} - \text{Reserve_power_margin}$) of DUT based on measured P_{limit} .

NOTE: For test sequence generation, “measured P_{limit} ” and “measured P_{max} ” are used instead of the “ P_{limit} ” specified in EFS entry and “ P_{max} ” specified for the device, because the Smart Transmit feature operates against the actual power level of the “ P_{limit} ” that was calibrated for the DUT. The “measured P_{limit} ” accurately reflects what the feature is referencing to, therefore, it should be used during feature validation testing. The RF tune up and device-to-device variation are already considered in Part 0 report prior to determining P_{limit} .

TAS Validation Report

1. Test sequence is generated based on below parameters of the DUT:
 - a. Measured maximum power (P_{max})
 - b. Measured Tx_power_at_SAR_design_target (P_{limit})
 - c. Reserve_power_margin ($P_{reserve}$)

$$P_{reserve} \text{ (dBm)} = \text{measured } P_{limit} \text{ (dBm)} - \text{Reserve_power_margin (dB)}$$
 - d. FCC SAR_time_window (100s for $f < 3 \text{ GHz}$, 60s for $3 \text{ GHz} < f \leq 6 \text{ GHz}$, and 30s for $6 \text{ GHz} < f \leq 10 \text{ GHz}$)

2. Test Sequence 1 Waveform:

Based on the parameters above, the Test Sequence 1 is generated with one transition between high and low Tx powers. Here, high power = P_{max} ; low power = $P_{max}/2$, and the transition occurs after 80 seconds at high power P_{max} . As long as the power enforcement is taking into effective during one 100s/60s time window, the validation test with this defined test sequence 1 is valid, otherwise, select other radio configuration (band / DSI within the same technology group) having lower P_{limit} for this test. The Test sequence 1 waveform is shown below:

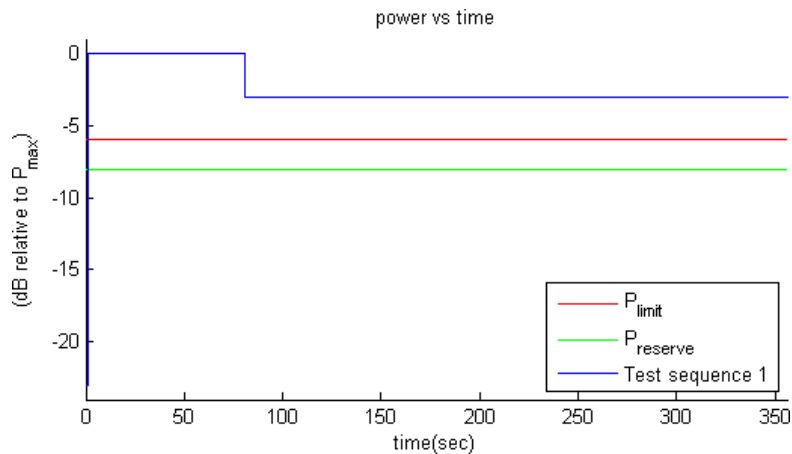

Figure 3-1 Test sequence 1 waveform

TAS Validation Report

3. Test Sequence 2 Waveform:

Based on the parameters above, the Test Sequence 2 is generated as described in below Table, which contains two 170 second-long sequences (yellow and green highlighted rows) that are mirrored around the center row of 20s, resulting in a total duration of 360 seconds:

Time Duration (seconds)	dB relative to P_{limit} or $P_{reserve}$
15	$P_{reserve} - 2$
20	P_{limit}
20	$(P_{limit} + P_{max})/2$ averaged in mW and rounded to nearest 0.1 dB step
10	$P_{reserve} - 6$
20	P_{max}
15	P_{limit}
15	$P_{reserve} - 5$
20	P_{max}
10	$P_{reserve} - 3$
15	P_{limit}
10	$P_{reserve} - 4$
20	$(P_{limit} + P_{max})/2$ averaged in mW and rounded to nearest 0.1 dB step
10	$P_{reserve} - 4$
15	P_{limit}
10	$P_{reserve} - 3$
20	P_{max}
15	$P_{reserve} - 5$
15	P_{limit}
20	P_{max}
10	$P_{reserve} - 6$
20	$(P_{limit} + P_{max})/2$ averaged in mW and rounded to nearest 0.1 dB step
20	P_{limit}
15	$P_{reserve} - 2$

The Test Sequence 2 waveform is shown in Figure A-2.

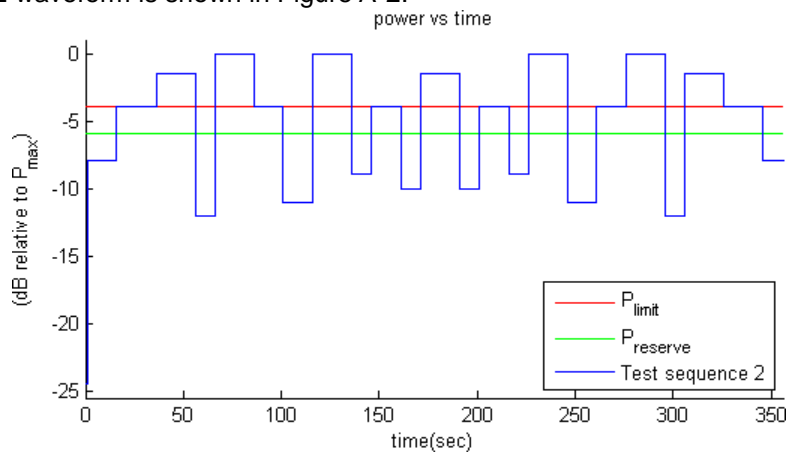

Figure 3-2 Test Sequence 2 waveform

3.2 Test Configuration Selection Criteria for Validating Smart Transmit

For validating the Smart Transmit feature, this section provides the general guidance to select test cases.

3.2.1 Test Configuration Selection for Time-Varying Tx Power Transmission

The Smart Transmit time averaging feature operation is independent of bands, modes, and channels for a given technology. Hence, validation of Smart Transmit in one band/mode/channel per technology is sufficient. Two bands per technology are proposed and selected for this testing to provide high confidence in this validation.

Note this test is designed for single radio transmission scenario. If UE supports sub6 NR in both non-standalone (NSA) and standalone (SA) modes, then validation in time-varying Tx power transmission scenario described in this section needs to be performed in SA mode. Otherwise, it needs to be performed in NSA mode with LTE anchor set to low power. The choice between SA and NSA mode needs to also take into account the selection criteria described below. In general, one mode out of the two modes (NSA or SA) is sufficient for this test.

The criteria for the selection are based on the P_{limit} values determined in Part 0 report. Select two bands* in each supported technology that correspond to least** and highest*** P_{limit} values that are less than P_{max} for validating Smart Transmit. Note:

1. P_{max} refers to maximum Tx power configured for this device in this technology/band (not rated P_{max}). This P_{max} definition applies throughout this Part 2 report.
2. If $P_{limit} > P_{max}$, the validation test with time-varying test sequences is not needed as no power enforcement will be required in this condition.

* If one P_{limit} level applies to all the bands within a technology, then only one band needs to be tested. In this case, within the bands having the same P_{limit} , the radio configuration (e.g., # of RBs, channel#) and device position that correspond to the highest measured 1gSAR at P_{limit} shown in Part 1 report is selected.

** In case of multiple bands having the same least P_{limit} within the technology, then select the band having the highest measured 1gSAR at P_{limit} .

*** The band having a higher P_{limit} needs to be properly selected so that the power limiting enforced by Smart Transmit can be validated using the pre-defined test sequences. If the highest P_{limit} in a technology is too high where the power limiting enforcement is not needed when testing with the pre-defined test sequences, then the next highest level is checked. This process is continued within the technology until the second band for validation testing is determined.

TAS Validation Report

3.2.2 Test Configuration Selection for Change in Call

The criteria to select a test configuration for call-drop measurement is:

- Select technology/band with least P_{limit} among all supported technologies/bands, and select the radio configuration (e.g., # of RBs, channel#) in this technology/band that corresponds to the highest measured 1gSAR at P_{limit} listed in Part 1 report.
- In case of multiple bands having same least P_{limit} , then select the band having the highest measured 1gSAR at P_{limit} in Part 1 report.

This test is performed with the DUT's Tx power requested to be at maximum power, the above band selection will result in Tx power enforcement (i.e., DUT forced to have Tx power at Preserve) for longest duration in one FCC defined time window. The call change (call drop/reestablish) is performed during the Tx power enforcement duration (i.e., during the time when DUT is forced to have Tx power at Preserve). One test is sufficient as the feature operation is independent of technology and band.

3.2.3 Test Configuration Selection for Change in Technology/Band

The selection criteria for this measurement is, for a given antenna, to have DUT switch from a technology/band with lowest P_{limit} within the technology group (in case of multiple bands having the same P_{limit} , then select the band with highest measured 1gSAR at P_{limit}) to a technology/band with highest P_{limit} within the technology group, in case of multiple bands having the same P_{limit} , then select the band with lowest measured 1gSAR at P_{limit} in Part 1 report, or vice versa.

This test is performed with the DUT's Tx power requested to be at maximum power, the technology/band switch is performed during Tx power enforcement duration (i.e., during the time when DUT is forced to have Tx power at Preserve).

TAS Validation Report

3.2.4 Test Configuration Selection for Change in Antenna

The criteria to select a test configuration for antenna switch measurement is:

- Whenever possible and supported by the DUT, first select antenna switch configuration within the same technology/band (i.e., same technology and band combination).
- Then, select any technology/band that supports multiple Tx antennas, and has the highest difference in P_{limit} among all supported antennas.
- In case of multiple bands having same difference in P_{limit} among supported antennas, then select the band having the highest measured 1gSAR at P_{limit} in Part 1 report.

This test is performed with the DUT's Tx power requested to be at maximum power in selected technology/band, and antenna change is conducted during Tx power enforcement duration (i.e., during the time when DUT is forced to have Tx power at $P_{reserve}$).

3.2.5 Test Configuration Selection for Change in DSI

The criteria to select a test configuration for DSI change test is

- Select a technology/band having the $P_{limit} < P_{max}$ within any technology and DSI group, and for the same technology/band having a different P_{limit} in any other DSI group. Note that the selected DSI transition need to be supported by the device.

NOTE: The antennas corresponding to the selected DSIs should be in the same antenna group if EUT is configured with GEN2_SUB6, and selected DSIs should be under the same exposure category (i.e., both selected DSIs are either under head exposure category or under non-head exposure category) if EUT is enabled with Smart Transmit version 18 or higher.

This test is performed with the DUT's Tx power requested to be at maximum power in selected technology/band, and DSI change is conducted during Tx power enforcement duration (i.e., during the time when DUT is forced to have Tx power at $P_{reserve}$).

3.2.6 Test Configuration Selection for Change in Time Window

FCC specifies different time window for time averaging based on operation frequency. The criteria to select a test configuration for validating Smart Transmit feature and demonstrating the compliance during the change in time window is

- Select any technology/band that has operation frequency classified in one time window defined by FCC (such as 100-seconds time window), and its corresponding P_{limit} is less than P_{max} if possible.
- Select the 2nd technology/band that has operation frequency classified in a different time window defined by FCC (such as 60-seconds time window), and its corresponding P_{limit} is less than P_{max} if possible.
- Note it is preferred both P_{limit} values of two selected technology/band less than corresponding P_{max} , but if not possible, at least one of technologies/bands has its P_{limit} less than P_{max} .

This test is performed with the EUT's Tx power requested to be at maximum power in selected technology/band. Test for one pair of time windows selected is sufficient as the feature operation is the same.

TAS Validation Report

3.2.7 Test Configuration Selection for SAR Exposure Switching

If supported, the test configuration for SAR exposure switching should cover

1. SAR exposure switch when two active radios are in the same time window
2. SAR exposure switch when two active radios are in different time windows. One test with two active radios in any two different time windows is sufficient as Smart Transmit operation is the same for RF exposure switch in any combination of two different time windows. For device supporting LTE + Sub6G NR, this test is covered in SAR exposure switch validation.

The Smart Transmit time averaging operation is independent of the source of SAR exposure (for example, LTE vs. Sub6 NR) and ensures total time-averaged RF exposure compliance. Hence, validation of Smart Transmit in any one simultaneous SAR transmission scenario (i.e., one combination for LTE + Sub6 NR transmission) is sufficient, where the SAR exposure varies among SARradio1 only, SARradio1 + SARradio2, and SARradio2 only scenarios.

The criteria to select a test configuration for validating Smart Transmit feature during SAR exposure switching scenarios is

- Select any two < 6GHz technologies/bands that the EUT supports simultaneous transmission (for example, LTE + Sub6 NR).
- Among all supported simultaneous transmission configurations, the selection order is
 1. select one configuration where both P_{limit} of radio1 and radio2 is less than their corresponding P_{max} , preferably, with different P_{limit} . If this configuration is not available, then,
 2. select one configuration that has P_{limit} less than its P_{max} for at least one radio. If this can not be found, then,
 3. select one configuration that has P_{limit} of radio1 and radio2 greater than P_{max} but with least $(P_{limit} - P_{max})$ delta.

Test for one simultaneous transmission scenario is sufficient as the feature operation is the same.

3.3 Test Procedures for Conducted Power Tests

This section provides general conducted power measurement procedures to perform compliance test under dynamic transmission scenarios described in Section 3. In practice, an adjustment can be made in these procedures. The justification/clarification may be provided.

3.3.1 Time-Varying Tx Power Transmission Scenario

This test is performed with the two pre-defined test sequences described in Section 3.1 for all the technologies and bands selected in Section 3.2.1. The purpose of the test is to demonstrate the effectiveness of power limiting enforcement and that the time-averaged SAR (corresponding time-averaged Tx power) does not exceed the FCC limit at all times.

Test Procedure

1. Measure P_{max} , P_{limit} and calculate $P_{reserve}$ (measured P_{limit} - *Reserve_power_margin*) and follow Section 3.1 to generate the test sequences for all the technologies and bands selected in Section 3.2.1. Both test sequence 1 and test sequence 2 are created based on measured P_{max} and measured P_{limit} of the DUT. Test condition to measure P_{max} and P_{limit} is:
 - a. Measure P_{max} with Smart Transmit disabled and callbox set to request maximum power.
 - b. Measure P_{limit} with Smart Transmit enabled and *Reserve_power_margin* set to 0 dB, and callbox set to request maximum power.
2. Set *Reserve_power_margin* to actual (intended) value (3dB for this DUT based on Part-1 report) and reset power on DUT to enable Smart Transmit, establish radio link in desired radio configuration, with callbox requesting the DUT to transmit at pre-defined test sequence 1, measure and record Tx power versus time, and then convert the conducted Tx power into 1gSAR or 10gSAR value using measured P_{limit} from above Step 1. Perform running time average to determine time-averaged power and 1gSAR or 10gSAR versus time as illustrated in Figure 3-1 where using 100 seconds time window as an example.

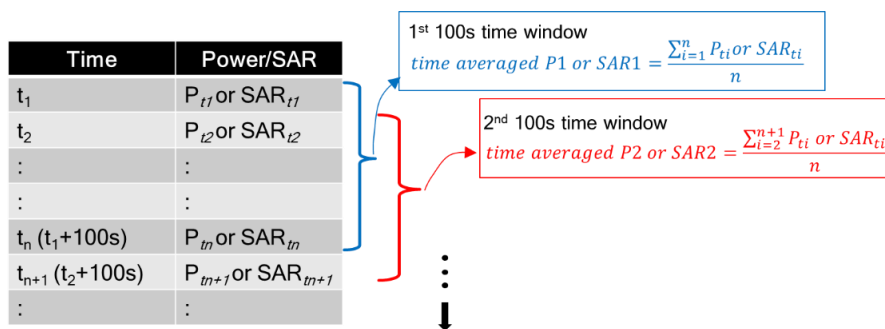

Figure 3-3 Running Average Illustration

Note: The instantaneous Tx power is converted into instantaneous 1gSAR or 10gSAR value by applying the measured worst-case 1gSAR or 10gSAR value at P_{limit} for the corresponding technology/band/antenna/DSI reported in Part-1 report.

Note: For an easier computation of the running time average, 0 dBm can be added at the beginning of the test sequences the length of the responding time window, for example, add 0 dBm for 100 seconds so the running time average can be directly performed starting with the first 100 seconds data using excel spreadsheet. This technique applies to all tests performed in this Part-2 report for easier time-averaged computation using excel spreadsheet.

TAS Validation Report

3. Make one plot containing:
 - a. Instantaneous Tx power versus time measured in Step 2,
 - b. Requested Tx power used in Step 2 (test sequence 1),
 - c. Computed time-averaged power versus time determined in Step 2,
 - d. Time-averaged power limit (corresponding to FCC SAR limit of 1.6 W/kg for 1gSAR or 4.0 W/kg for 10gSAR) given by

$$\text{Time averaged power limit} = \text{meas. } P_{\text{limit}} + 10 \times \log \left(\frac{\text{FCC SAR limit}}{\text{meas. SAR}_{P_{\text{limit}}}} \right) \quad (5a)$$

where $\text{meas. } P_{\text{limit}}$ and $\text{meas. SAR}_{P_{\text{limit}}}$ correspond to measured power at P_{limit} and measured SAR at P_{limit} .

4. Make another plot containing:
 - a. Computed time-averaged 1gSAR or 10gSAR versus time determined in Step 2.
 - b. FCC 1gSAR_{limit} of 1.6 W/kg or FCC 10gSAR_{limit} of 4.0 W/kg.
5. Repeat Steps 2 to 4 for pre-defined test sequence 2 and replace the requested Tx power (test sequence 1) in Step 2 with test sequence 2.
6. Repeat Steps 2 to 5 for all the selected technologies and bands.

The validation criteria are, at all times, the time-averaged power versus time shown in Step 3 plot shall not exceed the time-averaged power limit (defined in Eq. (5a)), in turn, the time-averaged 1gSAR or 10gSAR versus time shown in Step 4 plot shall not exceed the FCC limit of 1.6 W/kg for 1gSAR or 4.0 W/kg for 10gSAR.

3.3.2 Change in Call Scenario

This test is to demonstrate that Smart Transmit feature accurately accounts for the past Tx powers during time-averaging when a new call is established.

The call disconnect and re-establishment needs to be performed during power limit enforcement, i.e., when the DUT's Tx power is at P_{reserve} level, to demonstrate the continuity of RF exposure management and limiting in call change scenario. In other words, the RF exposure averaged over any FCC defined time window (including the time windows containing the call change) doesn't exceed FCC limit of 1.6 W/kg for 1gSAR or 4.0 W/kg for 10gSAR.

Test Procedure

1. Measure P_{limit} for the technology/band selected in Section 3.2.2. Measure P_{limit} with Smart Transmit enabled and *Reserve_power_margin* set to 0 dB, and callbox set to request maximum power.
2. Set *Reserve_power_margin* to actual (intended) value and reset power on DUT to enable Smart Transmit.
3. Establish radio link with callbox in the selected technology/band.
4. Request DUT's Tx power at 0 dBm for at least one time window specified for the selected technology/band, followed by requesting DUT to transmit at maximum Tx power for about ~60 seconds, and then drop the call for ~10 seconds. Afterwards, re-establish another call in the same radio configuration (i.e., same technology/band/channel) and continue callbox requesting DUT to transmit at maximum Tx power for the remaining time of at least another entire duration of the specified time window. Measure and record Tx power versus time.

TAS Validation Report

- Once the measurement is done, extract instantaneous Tx power versus time, and convert the measured conducted Tx power into 1gSAR or 10gSAR value, and then perform the running time average to determine time-averaged 1gSAR or 10gSAR versus time.

Note: The instantaneous Tx power is converted into instantaneous 1gSAR or 10gSAR value by applying the measured worst-case 1gSAR or 10gSAR value at P_{limit} for the corresponding technology/band/antenna/DSI reported in Part-1 report.

- Make one plot containing: (a) instantaneous Tx power versus time, (b) requested power, (c) computed time-averaged power, (d) time-averaged power limit calculated using Eq.(5a).
- Make another plot containing: (a) computed time-averaged 1gSAR or 10gSAR versus time, and (b) FCC limit of 1.6 W/kg for 1gSAR or 4.0 W/kg for 10gSAR.

The validation criteria are, at all times, the time-averaged power versus time shall not exceed the time- averaged power limit (defined in Eq.(5a)), in turn, the time-averaged 1gSAR or 10gSAR versus time shall not exceed the FCC limit of 1.6 W/kg for 1gSAR or 4.0 W/kg for 10gSAR.

3.3.3 Change in Technology and Band

This test is to demonstrate the correct power control by Smart Transmit during technology switches and/or band handovers.

Similar to the change in call test in Section 4.3.2, to validate the continuity of RF exposure limiting during the transition, the technology and band handover needs to be performed when DUT's Tx power is at Preserve level (i.e., during Tx power enforcement) to make sure that the DUT's Tx power from previous $P_{reserve}$ level to the new $P_{reserve}$ level (corresponding to new technology/band). Since the P_{limit} could vary with technology and band, Eq. (1a) can be written as follows to convert the instantaneous Tx power in 1gSAR or 10gSAR exposure for the two given radios, respectively:

$$1g_or_10gSAR_1(t) = \frac{conducted_Tx_power_1(t)}{conducted_Tx_power_P_{limit_1}} \times 1g_or_10gSAR_P_{limit_1} \quad (6a)$$

$$1g_or_10gSAR_2(t) = \frac{conducted_Tx_power_2(t)}{conducted_Tx_power_P_{limit_2}} \times 1g_or_10gSAR_P_{limit_2} \quad (6b)$$

$$\frac{1}{T_{SAR}} \left[\int_{t-T_{SAR}}^{t_1} 1g_or_10gSAR_1(t) dt + \int_{t-T_{SAR}}^t 1g_or_10gSAR_2(t) dt \right] \leq 1g_or_10gSAR_{limit} \quad (6c)$$

where, $conducted_Tx_power_1(t)$, $conducted_Tx_power_P_{limit_1}$, and $1g_or_10gSAR_P_{limit_1}$ correspond to the measured instantaneous conducted Tx power, measured conducted Tx power at P_{limit} , and measured 1gSAR or 10gSAR value at P_{limit} of technology1/band1; $conducted_Tx_power_2(t)$, $conducted_Tx_power_P_{limit_2}$, and $1g_or_10gSAR_P_{limit_2}$ correspond to the measured instantaneous conducted Tx power, measured conducted Tx power at P_{limit} , and measured 1gSAR or 10gSAR value at P_{limit} of technology2/band2. Transition from technology1/band1 to the technology2/band2 happens at time-instant ' t_1 '.

TAS Validation Report

Test Procedure

1. Measure P_{limit} for both the technologies and bands selected in Section 3.2.3. Measure P_{limit} with Smart Transmit peak exposure mode enabled, and callbox set to request maximum power.
2. Set DUT to the intended Smart Transmit exposure mode. Establish radio link with callbox in first technology/band selected. Establish radio link with callbox in first technology/band selected.
3. Request DUT's Tx power at 0 dBm for at least one time window specified for the selected technology/band, followed by requesting DUT's Tx power to be at maximum power for about ~60 seconds, and then switch to second technology/band selected. Continue with callbox requesting DUT's Tx power to be at maximum power for the remaining time of at least another full duration of the specified time window. Measure and record Tx power versus time for the full duration of the test.
4. Once the measurement is done, extract instantaneous Tx power versus time, and convert the conducted Tx power into 1gSAR or 10gSAR value using Eq. (6a) and (6b) and corresponding measured P_{limit} values from Step 1 of this section. Perform the running time average to determine time-averaged power and 1gSAR or 10gSAR versus time.

NOTE: In Eq.(6a) & (6b), instantaneous Tx power is converted into instantaneous 1gSAR or 10gSAR value by applying the measured worst-case 1gSAR or 10gSAR value at P_{limit} for the corresponding technology/band/antenna/DSI reported in Part 1 report.

5. Make one plot containing: (a) instantaneous Tx power versus time, (b) requested power, (c) computed time-averaged power, (d) time-averaged power limit calculated using Eq.(5a).
6. Make another plot containing: (a) computed time-averaged 1gSAR or 10gSAR versus time, and (b) FCC limit of 1.6 W/kg for 1gSAR or 4.0 W/kg for 10gSAR.

The validation criteria are, at all times, the time-averaged 1gSAR or 10gSAR versus time shall not exceed the FCC limit of 1.6 W/kg for 1gSAR or 4.0 W/kg for 10gSAR (i.e., Eq. (6c)).

3.3.4 Change in Antenna

This test is to demonstrate the correct power control by Smart Transmit during antenna switches from one antenna to another. The test procedure is identical to Section 3.3.3, by replacing technology/band switch operation with antenna switch. The validation criteria are, at all times, the time-averaged 1gSAR or 10gSAR versus time shall not exceed FCC limit of 1.6 W/kg for 1gSAR or 4.0 W/kg for 10gSAR.

NOTE: If the DUT does not support antenna switch within the same technology/band, but has multiple antennas to support different frequency bands, then the antenna switch test is included as part of change in technology and band (Section 3.3.3) test.

3.3.5 Change in DSI

This test is to demonstrate the correct power control by Smart Transmit during DSI switches from one DSI to another. The test procedure is identical to Section 3.3.3, by replacing technology/band switch operation with DSI switch. The validation criteria are, at all times, the time-averaged 1gSAR or 10gSAR versus time shall not exceed FCC limit of 1.6 W/kg for 1gSAR or 4.0 W/kg for 10gSAR.

3.3.6 Change in Time Window

This test is to demonstrate the correct power control by Smart Transmit during the change in averaging time window when a specific band handover occurs. FCC specifies time-averaging windows of 100s for Tx frequency < 3GHz, and 60s for Tx frequency between 3GHz and 6GHz.

To validate the continuity of RF exposure limiting during the transition, the band handover test needs to be performed when EUT handovers from operation band less than 3GHz to greater than 3GHz and vice versa. The equations (3a) and (3b) in Section 2 can be written as follows for transmission scenario having change in time window,

$$1g_or_10gSAR_1(t) = \frac{conducted_Tx_power_1(t)}{conducted_Tx_power_P_{limit_1}} \times 1g_or_10gSAR_P_{limit_1} \quad (7a)$$

$$1g_or_10gSAR_2(t) = \frac{conducted_Tx_power_2(t)}{conducted_Tx_power_P_{limit_2}} \times 1g_or_10gSAR_P_{limit_2} \quad (7b)$$

$$\frac{\frac{1}{T1_{SAR}} \left[\int_{t-T1_{SAR}}^{t_1} 1g_or_10gSAR_1(t) dt \right] + \frac{1}{T2_{SAR}} \left[\int_{t-T2_{SAR}}^t 1g_or_10gSAR_2(t) dt \right]}{1g_or_10gSAR_{limit}} \leq 1 \quad (7c)$$

where, $conducted_Tx_power_1(t)$, $conducted_Tx_power_P_{limit_1}(t)$, and $1g_or_10g_SAR_P_{limit_1}$ correspond to the instantaneous Tx power, conducted Tx power at P_{limit} , and compliance $1g_or_10g_SAR$ values at P_{limit_1} of band1 with time-averaging window ' $T1_{SAR}$ '; $conducted_Tx_power_2(t)$, $conducted_Tx_power_P_{limit_2}(t)$, and $1g_or_10g_SAR_P_{limit_2}$ correspond to the instantaneous Tx power, conducted Tx power at P_{limit} , and compliance $1g_or_10g_SAR$ values at P_{limit_2} of band2 with time- averaging window ' $T2_{SAR}$ '. One of the two bands is less than 3 GHz, another is greater than 3 GHz.

Transition from first band with time-averaging window ' $T1_{SAR}$ ' to the second band with time-averaging window ' $T2_{SAR}$ ' happens at time-instant ' t_1 '.

Test Procedure

1. Measure P_{limit} for both the technologies and bands selected in Section 3.2.6. Measure P_{limit} with Smart Transmit peak exposure mode enabled, and callbox set to request maximum power.
2. Set DUT to the intended Smart Transmit exposure mode.

Transition from 100s time window to 60s time window, and vice versa

3. Establish radio link with callbox in the technology/band having 100s time window selected in Section 3.2.6.

TAS Validation Report

4. Request DUT's Tx power to be at 0 dBm for at least 100 seconds, followed by requesting DUT's Tx power to be at maximum power for about ~140 seconds, and then switch to second technology/band (having 60s time window) selected in Section 3.2.6. Continue with callbox requesting DUT's Tx power to be at maximum power for about ~60s in this second technology/band, and then switch back to the first technology/band. Continue with callbox requesting DUT's Tx power to be at maximum power for at least another 100s. Measure and record Tx power versus time for the entire duration of the test.
5. Once the measurement is done, extract instantaneous Tx power versus time, and convert the conducted Tx power into 1gSAR or 10gSAR value (see Eq. (7a) and (7b)) using corresponding technology/band Step 1 result, and then perform 100s running average to determine time-averaged 1gSAR or 10gSAR versus time. Note that in Eq.(7a) & (7b), instantaneous Tx power is converted into instantaneous 1gSAR or 10gSAR value by applying the worst-case 1gSAR or 10gSAR value tested in Part 1 for the selected technologies/bands at P_{limit} .
6. Make one plot containing: (a) instantaneous Tx power versus time measured in Step 4.
7. Make another plot containing: (a) instantaneous 1gSAR versus time determined in Step 5, (b) computed time-averaged 1gSAR versus time determined in Step 5, and (c) corresponding regulatory 1gSARlimit of 1.6W/kg or 10gSARlimit of 4.0W/kg.

Transition from 60s time window to 100s time window, and vice versa

8. Establish radio link with callbox in the technology/band having 60s time window selected in Section 3.2.6.
9. Request DUT's Tx power to be at 0 dBm for at least 60 seconds, followed by requesting DUT's Tx power to be at maximum power for about ~80 seconds, and then switch to second technology/band (having 100s time window) selected in Section 3.2.6. Continue with callbox requesting DUT's Tx power to be at maximum power for about ~100s in this second technology/band, and then switch back to the first technology/band. Continue with callbox requesting DUT's Tx power to be at maximum power for the remaining time for a total test time of 500 seconds. Measure and record Tx power versus time for the entire duration of the test.
- 10.Repeat above Step 5-7 to generate the plots

The validation criteria is, at all times, the time-averaged 1gSAR or 10gSAR versus time shall not exceed the regulatory 1gSARlimit of 1.6W/kg or 10gSARlimit of 4.0W/kg.

TAS Validation Report

3.3.7 SAR Exposure Switching

This test is to demonstrate that Smart Transmit feature is accurately accounts for switching in exposures among SAR from radio1 only, SAR from both radio1 and radio2, and SAR from radio2 only scenarios, and ensures total time-averaged RF exposure complies with the FCC limit. Here, radio1 represents primary radio (for example, LTE anchor in a NR non-standalone mode call) and radio2 represents secondary radio (for example, sub6 NR).

Test Procedure

1. Measure conducted Tx power corresponding to P_{limit} for radio1 and radio2 in selected band. Test condition to measure conducted P_{limit} is:
 - Establish device in call with the callbox for radio1 technology/band. Measure conducted Tx power corresponding to radio1 P_{limit} with Smart Transmit peak exposure mode enabled, and callbox set to request maximum power.
 - Repeat above step to measure conducted Tx power corresponding to radio2 P_{limit} . If radio2 is dependent on radio1 (for example, non-standalone mode of Sub6 NR requiring radio1 LTE as anchor), then establish radio1 + radio2 call with callbox, and request all down bits for radio1 LTE. In this scenario, with callbox requesting maximum power from radio2 Sub6 NR, measured conducted Tx power corresponds to radio2 P_{limit} (as radio1 LTE is at all-down bits)
2. Set DUT to the intended Smart Transmit exposure mode, with EUT setup for radio1 + radio2 call. In this description, it is assumed that radio2 has lower priority than radio1. Establish device in radio1+radio2 call, and request all-down bits or low power on radio1, with callbox requesting EUT's Tx power to be at maximum power in radio2 for at least one time window. After one time window, set callbox to request EUT's Tx power to be at maximum power on radio1, i.e., all-up bits. Continue radio1 + radio2 call with both radios at maximum power for at least one time window, and drop (or request all-down bits on) radio2. Continue radio1 at maximum power for at least one time window. Record the conducted Tx power for both radio1 and radio2 for the entire duration of this test.
3. Once the measurement is done, extract instantaneous Tx power versus time for both radio1 and radio2 links. Convert the conducted Tx power for both these radios into 1gSAR or 10gSAR value (see Eq. (6a) and (6b)) using corresponding technology/band P_{limit} measured in Step 1, and then perform the running time average to determine time-averaged 1gSAR or 10gSAR versus time.
4. Make one plot containing: (a) instantaneous Tx power versus time measured in Step 2.
5. Make another plot containing: (a) instantaneous 1gSAR versus time determined in Step 3, (b) computed time-averaged 1gSAR versus time determined in Step 3, and (c) corresponding regulatory 1gSARlimit of 1.6W/kg or 10gSARlimit of 4.0W/kg.

The validation criteria is, at all times, the time-averaged 1gSAR or 10gSAR versus time shall not exceed the regulatory 1gSARlimit of 1.6W/kg or 10gSARlimit of 4.0W/kg.

3.4 Test Procedures for Time-Varying SAR Tests

This section provides general time-varying SAR measurement procedures to perform compliance test under dynamic transmission scenarios described in Section 2. In practice, an adjustment can be made in these procedures. The justification/clarification may be provided.

To perform the validation through SAR measurement for transmission scenario 1 described in Section 2, the “path loss” between callbox antenna and DUT needs to be calibrated to ensure that the DUT Tx power reacts to the requested power from callbox in a radiated call. It should be noted that when signaling in closed loop mode, protocol-level power control is in play, resulting in DUT not solely following callbox TPC (Tx power control) commands. In other words, DUT response has many dependencies (RSSI, quality of signal, path loss variation, fading, etc.,) other than just TPC commands. These dependencies have less impact in conducted setup (as it is a controlled environment and the path loss can be very well calibrated) but have significant impact on radiated testing in an uncontrolled environment, such as SAR test setup. Therefore, the deviation in DUT Tx power from callbox requested power is expected, however the time-averaged SAR should not exceed FCC SAR requirement at all times as Smart Transmit controls Tx power at DUT. The following steps are for time averaging feature validation through SAR measurement:

1. “Path Loss” calibration: Place the DUT against the phantom in the worst-case position determined based on Section 3.2.1. For each band selected, prior to SAR measurement, perform “path loss” calibration between callbox antenna and DUT. Since the SAR test environment is not controlled and well calibrated for OTA (Over the Air) test, extreme care needs to be taken to avoid the influence from reflections.
2. Time averaging feature validation:
 - i For a given radio configuration (technology/band) selected in Section 3.2.1, enable Smart Transmit peak exposure mode, with callbox to request maximum power, perform area scan, conduct pointSAR measurement at peak location of the area scan. This point SAR value, pointSAR_Plimit, corresponds to point SAR at the measured Plimit (i.e., measured Plimit from the DUT in Step 1 of Section 3.3.1).
 - ii Set DUT to the intended Smart Transmit exposure mode. Note, if Total_min_reserve cannot be set wirelessly, care must be taken to re-position the DUT in the exact same position relative to the SAM phantom as in above Step 2.i. Establish radio link in desired radio configuration, with callbox requesting the DUT’s Tx power at power levels described by test sequence 1 generated in Step 1 of Section 3.3.1, conduct point SAR measurement versus time at peak location of the area scan determined in Step 2.i of this section. Once the measurement is done, extract instantaneous point SAR vs time data, pointSAR(t), and convert it into instantaneous 1gSAR or 10gSAR vs. time using Eq. (3a).
 - iii Perform 100s running average to determine time-averaged 1gSAR or 10gSAR versus time.
 - iv Make one plot containing: (a) time-averaged 1gSAR or 10gSAR versus time determined in Step 2.iii of this section, (b) FCC limit of 1.6 W/kg for 1gSAR or 4.0 W/kg for 10gSAR.
 - v Repeat 2.ii ~ 2.iv for test sequence 2 generated in Step 1 of Section 3.3.1.
 - vi Repeat 2.i ~ 2.v for all the technologies and bands selected in Section 3.2.1.

The time-averaging validation criteria for SAR measurement is that, at all times, the time-averaged 1gSAR or 10gSAR versus time shall not exceed FCC limit of 1.6 W/kg for 1gSAR or 4.0 W/kg for 10gSAR (i.e., Eq. (3b)).

4. Sub-6 Measurement Test Setup

4.1 Conducted Measurement Test Setup

Legacy Test Setup

The Rohde & Schwarz CMW500 callbox was used in this test. The test setup schematic is shown in Figure 4-1 for measurements with a single antenna of DUT, and in Figure 4-2 for measurements involving antenna switch. For single antenna measurement, one port (RF1 COM) of the callbox is connected to the RF port of the DUT using a directional coupler. For technology/band switch measurement, one port (RF1 COM) of the callbox used for signaling two different technologies is connected to a combiner, which is in turn connected to a directional coupler. The other end of the directional coupler is connected to a splitter to connect to two RF ports of the DUT corresponding to the two antennas of interest. In the setups, power meter is used to tap the directional coupler for measuring the conducted output power of the DUT. For all legacy conducted tests, only RF1 COM port of the callbox is used to communicate with the DUT.

All the path losses from RF port of DUT to the callbox RF COM port and to the power meter are calibrated and automatically entered as offsets in the callbox and the power meter via test scripts on the PC used to control callbox and power meter.

Sub6 NR test setup:

The Anritsu MT8000A callbox was used in this test. The test setup schematic is the same as the Legacy Test Setup shown in Figure 4-1. One port of the callbox is connected to the RF port of the DUT using a directional coupler. In the setup, the power meter is used to tap the directional coupler for measuring the conducted output power of the DUT.

All the path losses from RF port of DUT to the callbox RF COM port and to the power meter are calibrated and automatically entered as offsets in the callbox and the power meter via test scripts on the PC used to control callbox and power meter.

LTE+Sub6 NR test setup:

LTE conducted port and Sub6 NR conducted port are the same on this DUT, therefore, the LTE and Sub6 NR signals for power meter measurement are performed on separate paths as shown below in Figure 4-3.

All the path losses from RF port of DUT to the callbox RF COM port and to the power meter are calibrated and automatically entered as offsets in the callbox and the power meter via test scripts on the PC used to control callbox and power meter.

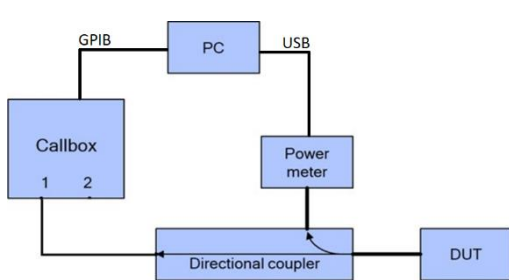

Figure 4-1

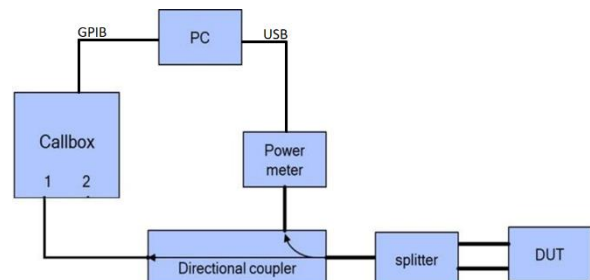

Figure 4-2

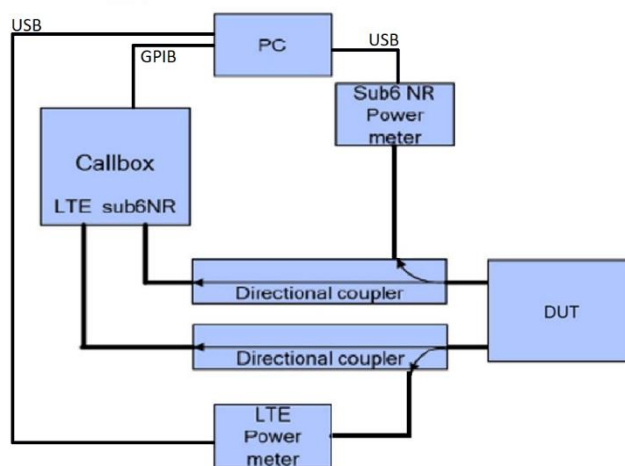

Figure 4-3

Both the callbox and power meter are connected to the PC using GPIB cables. Two test scripts are custom made for automation, and the test duration set in the test scripts is 500 seconds.

For time-varying Tx power measurement, the PC runs the 1st test script to send GPIB commands to control the callbox's requested power versus time, while at the same time to record the conducted power measured at DUT RF port using the power meter. The commands sent to the callbox to request power are:

- 0 dBm for 100 seconds
- test sequence 1 or test sequence 2 (defined in Section 3.1 and generated in Section 3.2.1), for 360 seconds.
- stay at the last power level of test sequence 1 or test sequence 2 for the remaining time.

Power meter readings are periodically recorded every 100 ms. A running average of this measured Tx power over 100 seconds is performed in the post-data processing to determine the 100s-time averaged power.

TAS Validation Report

For call drop, technology/band/antenna switch, and DSI switch tests, after the call is established, the callbox is set to request the DUT's Tx power at 0 dBm for 100 seconds while simultaneously starting the 2nd test script runs at the same time to start recording the Tx power measured at DUT RF port using the power meter. After the initial 100 seconds since starting the Tx power recording, the callbox is set to request maximum power from the DUT for the rest of the test. Note that the call drop/re-establish, or technology/band/antenna switch or DSI switch is manually performed when the Tx power of DUT is at Preserve level. See Section 3.3 for detailed test procedure of call drop test, technology/band/antenna switch test and DSI switch test.

4.2 SAR Measurement Test Setup

The measurement setup is similar to normal SAR measurements as described in the Part 1 Test Report. The difference in SAR measurement setup for time averaging feature validation is that the callbox is signaling in close loop power control mode (instead of requesting maximum power in open loop control mode) and callbox is connected to the PC using GPIB so that the test script executed on PC can send GPIB commands to control the callbox's requested power over time (test sequence). The same test script used in conducted setup for time-varying Tx power measurements is also used in this section for running the test sequences during SAR measurements, and the recorded values from the disconnected power meter by the test script were discarded.

As mentioned in Section 3.4, for DUT to follow TPC command sent from the callbox wirelessly, the "path loss" between callbox antenna and the DUT needs to be very well calibrated. Since the SAR chamber is in uncontrolled environment, precautions must be taken to minimize the environmental influences on "path loss". Similarly, in the case of time-varying SAR measurements in Sub6 NR (with LTE as anchor), "path loss" between callbox antenna and the EUT needs to be carefully calibrated for both LTE link as well as for Sub6 NR link. The DUT is placed in worst-case position accordingly.

5. Test Configurations

5.1 WWAN Sub-6 Transmission

The P_{limit} values, corresponding to 1.0 W/kg (1gSAR) and 2.5 W/kg (10gSAR) of SAR_design_target, for technologies and bands supported by DUT are derived in Part 0 report and summarized in following table. Note all P_{limit} power levels entered in Table 5-1 correspond to average power levels after accounting for duty cycle in the case of TDD modulation schemes.

Exposure Scenario		Body	P_{max}
Averaging Volume		1g	
Test Distance (mm)		10	
WWAN Bands	Antenna	P_{limit}	
LTE B2	1	23.30	23.0
LTE B2	2	21.90	23.0
LTE B4	1	22.40	23.0
LTE B4	2	22.40	23.0
LTE B5	1	25.20	23.0
LTE B5	2	26.50	23.0
LTE B7	2	21.40	23.0
LTE B12	1	23.80	23.0
LTE B14	1	24.70	23.0
LTE B30	1	21.30	23.0
LTE B30	2	21.00	19.50
LTE B40	2	23.00	19.50
LTE B48	1	21.40	23.00
LTE B66	1	22.60	23.00
LTE B66	2	23.90	23.00
5G NR-2	1	23.00	23.00
5G NR-2	2	21.60	23.00
5G NR-5	1	25.50	23.00
5G NR-12	1	24.00	23.00
5G NR-14	1	24.90	23.00
5G NR-30	2	20.30	23.00
5G NR-48	1	19.50	23.00
5G NR-48	2	19.20	23.00
5G NR-66	1	22.90	23.00
5G NR-66	2	24.00	23.00
5G NR-n77/78 for FCC PC2/PC3	1	22.00	26.00/23.00
5G NR-n77/78 for FCC PC2/PC3	2	18.70	26.00/23.00
5G NR-n77/78 for FCC PC2	3	22.00	26.00
5G NR-n77/78 for FCC PC2	4	20.30	26.00

Table 5-1 P_{limit} for supported technologies and bands (P_{limit} in EFS file)

TAS Validation Report

Maximum tune up target power, P_{max} , is configured in NV settings in DUT to limit maximum transmitting power. This power is converted into peak power in NV settings for TDD schemes. The DUT maximum allowed output power is equal to $P_{max} + 1.0$ dB device uncertainty.

Based on selection criteria described in Section 3.2.1, the selected technologies / bands for testing time-varying test sequences are highlighted in yellow in Table 5-1. Per the manufacturer, the reserve_power_margin (dB) is set to 3 dB in EFS and is used in Part 2 test.

The radio configurations used in Part 2 test for selected technologies, bands, DSIs and antennas are listed in Table 5-2. The corresponding worst-case radio configuration SAR values for selected technology / band / DSI are extracted from Part 1 report and are listed in the last column of Table 5-2.

Based on equations (1a), (2a), (3a) and (4a), it is clear that Part 2 testing outcome is normalized quantity, which implies that it can be applied to any radio configuration within a selected technology / band / DSI. Thus, as long as applying the worst-case SAR obtained from the worst radio configuration in Part 1 testing to calculate time-varying SAR exposure in equations (1a), (2a), (3a) and (4a), the accuracy in compliance demonstration remains the same. Therefore, there may be some differences between the radio configuration selected for Part 2 testing and the radio configuration associated with worst-case SAR obtained in the Part 1 evaluation.

Test Case #	Test Scenario	Tech	Band	Antenna	Channel	Frequency (MHz)	Mode	SAR Exposure Scenario	Part 1 Worst Case Measured SAR at Plimit (W/kg)
1	Time-Varying Tx Power (Seq 1 & Seq 2)	LTE	2	2	18700	1860	QPSK, 20M, 1RB, OS0	Right Side, 10 mm	0.874
2		LTE	7	2	21350	2560	QPSK, 20M, 1RB, OS0	Right Side, 10 mm	0.874
3		5G NR SA	n2 / SA (PC3)	2	372000	1860	DFT-S-OFDM, QPSK 20M, 1RB, OS1	Rear Face, 10 mm	0.874
4		5G NR SA	n77 / SA (PC2)	1	633332	3499.98	DFT-S-OFDM, QPSK 100M, 135RB, OS69	Left Side, 10 mm	0.874
5	Call Drop	LTE	7	2	21350	2560	QPSK, 20M, 1RB, OS0	Right Side, 10 mm	0.874
6		5G NR SA	n77 / SA (PC2)	1	633332	3499.98	DFT-S-OFDM, QPSK 100M, 135RB, OS69	Left Side, 10 mm	0.874
7	Change in time Window (100-60-100s)	LTE	2	2	18700	1860	QPSK, 20M, 1RB, OS0	Right Side, 10 mm	0.874
		LTE	7	2	21350	2560	QPSK, 20M, 1RB, OS0	Right Side, 10 mm	0.874
8	Change in time Window (60-100-60s)	LTE	7	2	21350	2560	QPSK, 20M, 1RB, OS0	Right Side, 10 mm	0.874
		LTE	2	2	18700	1860	QPSK, 20M, 1RB, OS0	Right Side, 10 mm	0.874
9	SAR Exposure Switching (EN- DC, same time window)	LTE	2	2	18700	1860	QPSK, 20M, 1RB, OS0	Right Side, 10 mm	0.874
		5G NR SA	n77 / SA (PC2)	1	633332	3499.98	DFT-S-OFDM, QPSK 100M, 135RB, OS69	Left Side, 10 mm	

Table 5-2 Radio Configurations Selected for Part 2 Test

Based on the selection criteria described in Section 3.2, the radio configurations for the Tx varying transmission test cases listed in Section 3 are:

1. Technologies and bands for time-varying Tx power transmission: The test case 1~3 listed in Table 5-2 are selected to test with the test sequences defined in Section 3.1 in both time-varying conducted power measurement and time-varying SAR measurement.
2. Technology and band for change in call test: LTE Band 7, having the lowest Plimit among all technologies and bands (test case 4 in Table 5-2), is selected for performing the call drop test in conducted power setup.
3. Technologies and bands for change in time-window: Based on selection criteria in Section 3.2.6, test case 6 in Table 5-2 is selected for time window switch between 60s window (LTE Band 2 & Band 7, antenna 2) and 100s window (LTE Band 2 & Band 7, antenna 2) in conducted power setup.
4. Technologies and bands for switch in SAR exposure: Based on selection criteria in Section 3.2.7 Scenario 1, test case 7 in Table 5-2 is selected for SAR exposure switching test in one of the supported simultaneous WWAN transmission scenario, i.e., LTE + Sub6 NR active in the same 100s time window, in conducted power setup.

6. Conducted Power Test Results for Sub-6 Smart Transmit Validation

6.1 P_{limit} and P_{max} Measurement Results

The measured P_{limit} for all the selected radio configurations given in Table 5-1 are listed in below Table 6-1. P_{max} was also measured for radio configurations selected for testing time-varying Tx power transmission scenarios in order to generate test sequences following the test procedures in Section 3.1.

Test Case #	Test Scenario	Tech	Band	Antenna	Channel	Frequency (MHz)	Mode	SAR Exposure Scenario	EFS P _{limit} (dBm)	Tune-up P _{max} (dBm)	Measured P _{limit} (dBm)	Measured P _{max} (dBm)
1	Time-Varying Tx Power (Seq 1 & Seq 2)	LTE	2	2	18700	1860	QPSK, 20M, 1RB, OS0	Hotspot	21.9	23	22.408	23.496
2		LTE	7	2	21350	2560	QPSK, 20M, 1RB, OS0	Hotspot	21.4	23	21.837	23.409
3		5G NR SA	n2 / SA (PC3)	2	372000	1860	DFT-S-OFDM, QPSK 20M, 1RB, OS1	Hotspot	21.6	23	21.589	23.023
4		5G NR SA	n77 / SA (PC2)	1	633332	3499.98	DFT-S-OFDM, QPSK 100M, 135RB, OS69	Hotspot	22	26	22.531	24.121
5	Call Drop	LTE	7	2	21350	2560	QPSK, 20M, 1RB, OS0	Hotspot	21.4	23	21.837	23.409
6		5G NR SA	n77 / SA (PC2)	1	633332	3499.98	DFT-S-OFDM, QPSK 100M, 135RB, OS69	Hotspot	22	26	22.531	24.121
7	Change in time Window (100-60-100s)	LTE	2	2	18700	1860	QPSK, 20M, 1RB, OS0	Hotspot	21.9	23	22.408	23.496
		LTE	7	2	21350	2560	QPSK, 20M, 1RB, OS0	Hotspot	21.4	23	21.837	23.409
8	Change in time Window (60-100-60s)	LTE	7	2	21350	2560	QPSK, 20M, 1RB, OS0	Hotspot	21.4	23	21.837	23.409
		LTE	2	2	18700	1860	QPSK, 20M, 1RB, OS0	Hotspot	21.9	23	22.408	23.496
9	SAR Exposure Switching (EN- DC, same time window)	LTE	2	2	18700	1860	QPSK, 20M, 1RB, OS0	Hotspot	21.9	23	22.408	23.496
		5G NR SA	n77 / SA (PC2)	1	633332	3499.98	DFT-S-OFDM, QPSK 100M, 135RB, OS69	Hotspot	22	26	22.531	24.121

Table 6-1 Measured P_{limit} and P_{max} of Selected Radio Configurations

Note: The device uncertainty of P_{max} is +/- 1.0 dB as provided by manufacturer.

6.2 Time-Varying Transmission Power Measurement Results

The measurement setup is shown in Figure 4-1. The purpose of the time-varying Tx power measurement is to demonstrate the effectiveness of power limiting enforcement and that the time-averaged Tx power when represented in time-averaged 1gSAR or 10gSAR values does not exceed FCC limit.

Following the test procedure in Section 3.3, the conducted Tx power measurement for all selected configurations are reported in this section. In all the conducted Tx power plots, the green curve represents time-averaged power and red line represents the conducted power limit that corresponds to FCC limit of 1.6 W/kg for 1gSAR or 4.0 W/kg for 10gSAR.

Similarly, in all the 1g or 10gSAR plots, the green curve represents the 100s/60s-time averaged 1gSAR or 10gSAR value calculated based on instantaneous 1gSAR or 10gSAR; and the red line limit represents the FCC limit of 1.6 W/kg for 1gSAR or 4.0 W/kg for 10gSAR.

TAS Validation Report

6.2.1 LTE Band 2 Antenna 2

Test Result for Test Sequence 1:

Conducted Power

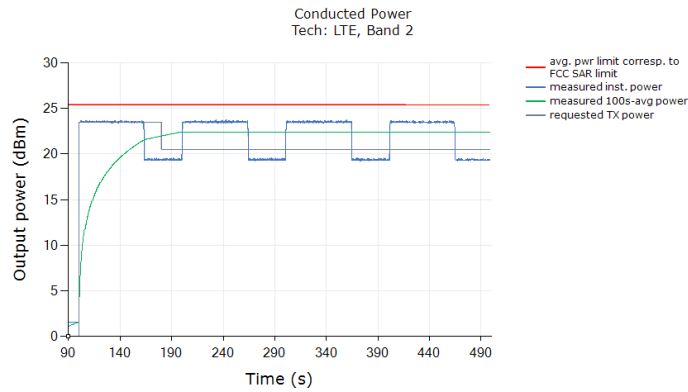

SAR

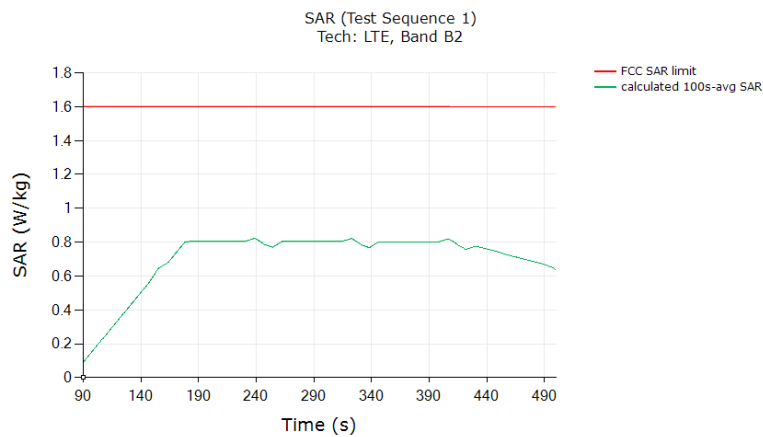

	(W/kg)
FCC 1gSAR limit	1.6
Max 100s-time averaged 1gSAR (green curve)	0.822
Validated: Max time averaged SAR (green curve) is within 1.0 dB device uncertainty of measured SAR at P_{limit} (last column in Table 5-2).	

TAS Validation Report

Test Result for Test Sequence 2: Conducted Power

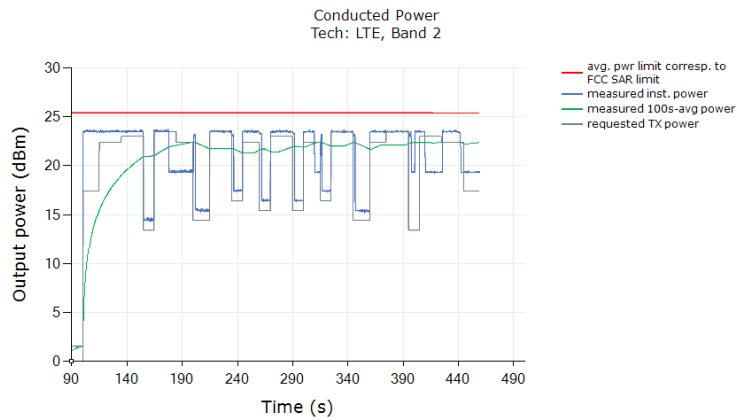

SAR

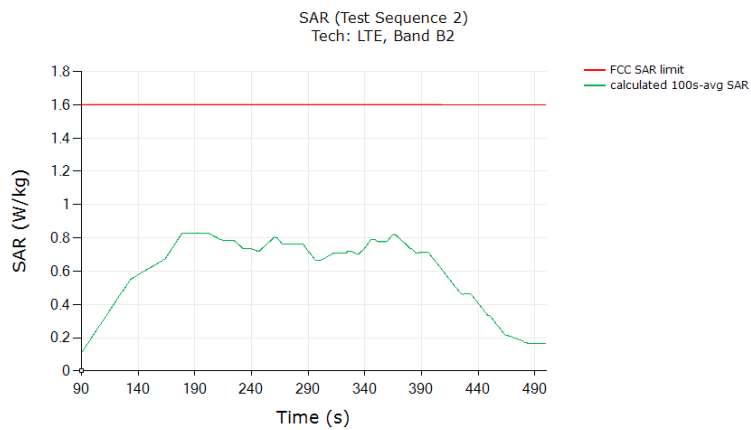

	(W/kg)
FCC 1gSAR limit	1.6
Max 100s-time averaged 1gSAR (green curve)	0.830
Validated: Max time averaged SAR (green curve) is within 1.0 dB device uncertainty of measured SAR at P_{limit} (last column in Table 5-2).	

TAS Validation Report

6.2.2 LTE Band 7 Antenna 2

Test Result for Test Sequence 1:

Conducted Power

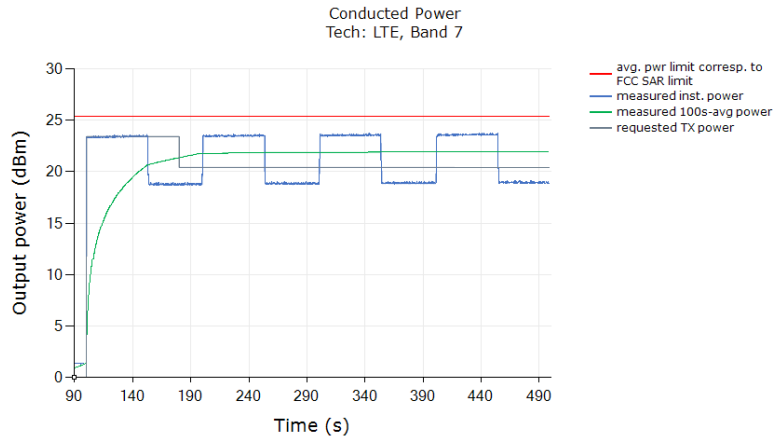

SAR

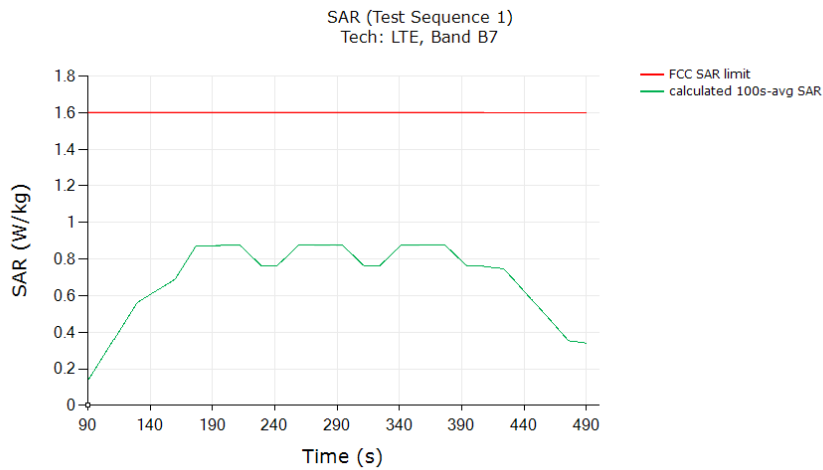

	(W/kg)
FCC 1gSAR limit	1.6
Max 100s-time averaged 1gSAR (green curve)	0.877
Validated: Max time averaged SAR (green curve) is within 1.0 dB device uncertainty of measured SAR at P_{limit} (last column in Table 5-2).	

TAS Validation Report

Test Result for Test Sequence 2: Conducted Power

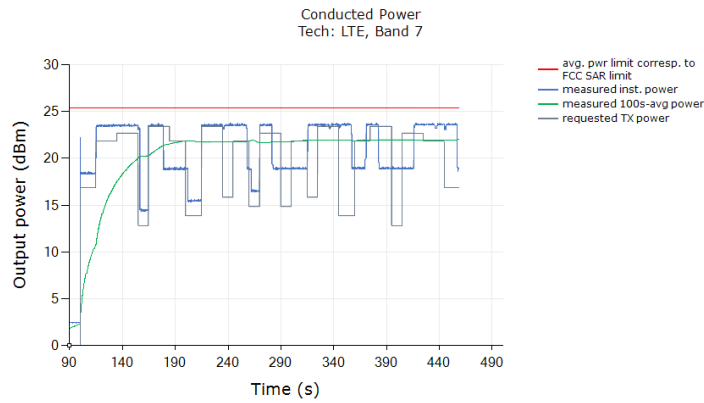

SAR

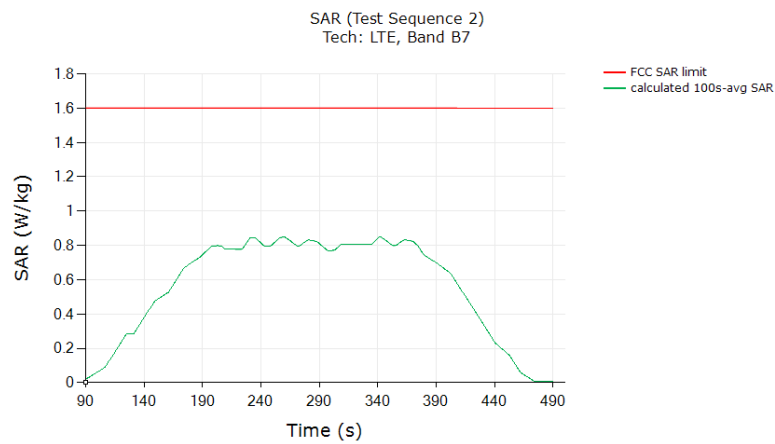

	(W/kg)
FCC 1gSAR limit	1.6
Max 100s-time averaged 1gSAR (green curve)	0.850
Validated: Max time averaged SAR (green curve) is within 1.0 dB device uncertainty of measured SAR at P_{limit} (last column in Table 5-2).	

TAS Validation Report

6.2.3 NR n2 Antenna 2

Test Result for Test Sequence 1:

Conducted Power

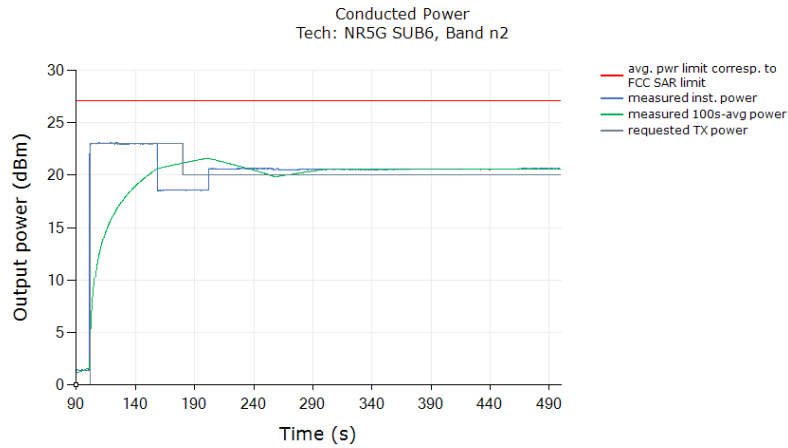

SAR

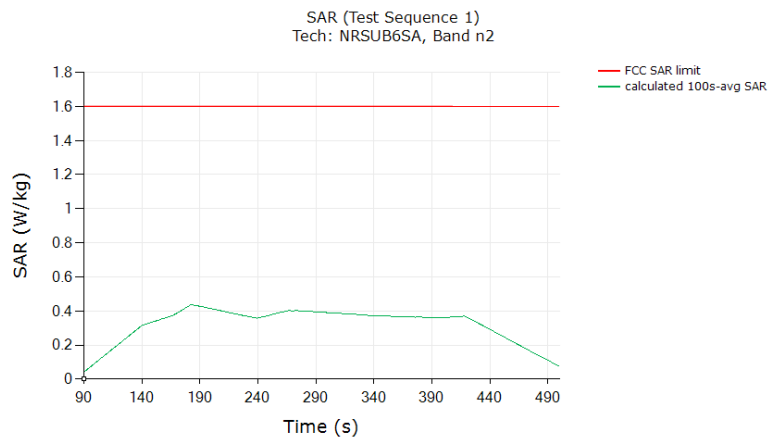

	(W/kg)
FCC 1gSAR limit	1.6
Max 100s-time averaged 1gSAR (green curve)	0.437
Validated: Max time averaged SAR (green curve) is within 1.0 dB device uncertainty of measured SAR at P_{limit} (last column in Table 5-2).	

TAS Validation Report

Test Result for Test Sequence 2: Conducted Power

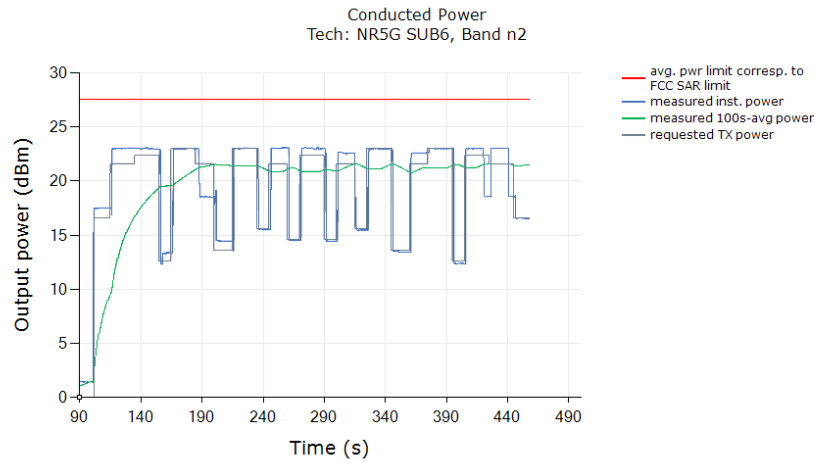

SAR

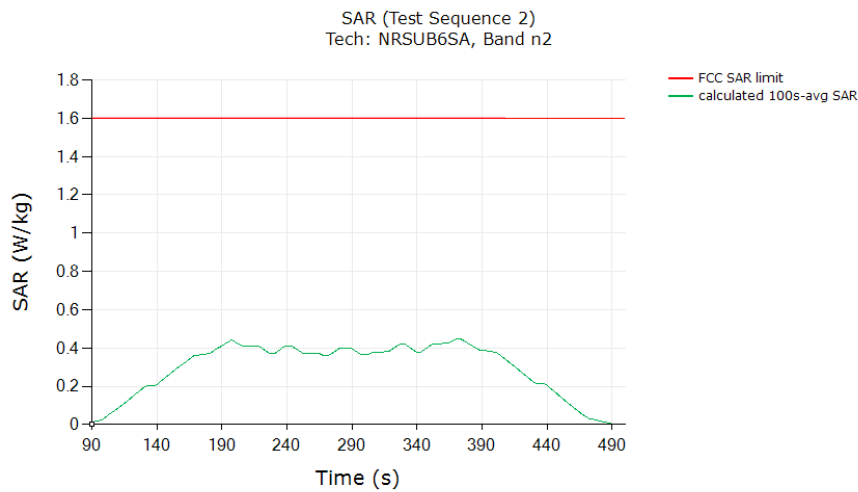

	(W/kg)
FCC 1gSAR limit	1.6
Max 100s-time averaged 1gSAR (green curve)	0.450
Validated: Max time averaged SAR (green curve) is within 1.0 dB device uncertainty of measured SAR at P_{limit} (last column in Table 5-2).	

TAS Validation Report

6.2.4 NR n77 Antenna 1

Test Result for Test Sequence 1:

Conducted Power

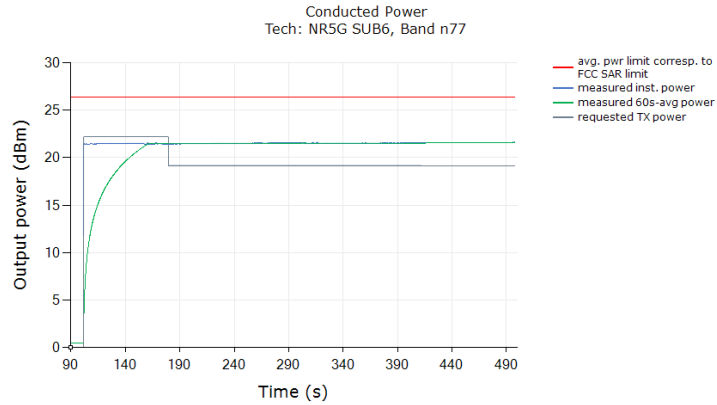

SAR

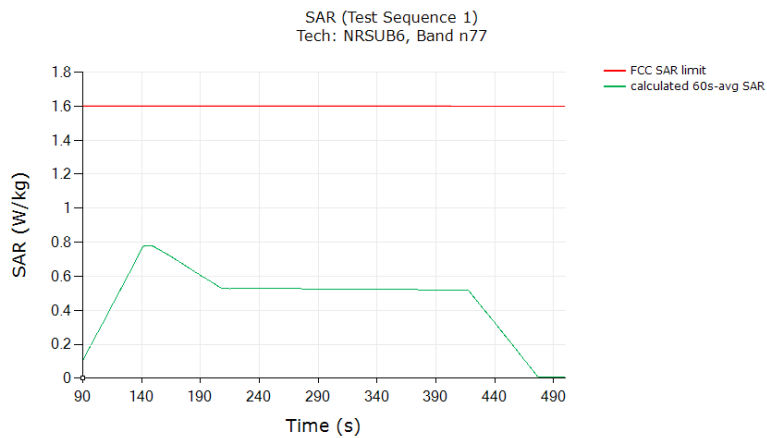

	(W/kg)
FCC 1gSAR limit	1.6
Max 60s-time averaged 1gSAR (green curve)	0.779
Validated: Max time averaged SAR (green curve) is within 1.0 dB device uncertainty of measured SAR at P_{limit} (last column in Table 5-2).	

TAS Validation Report

Test Result for Test Sequence 2: Conducted Power

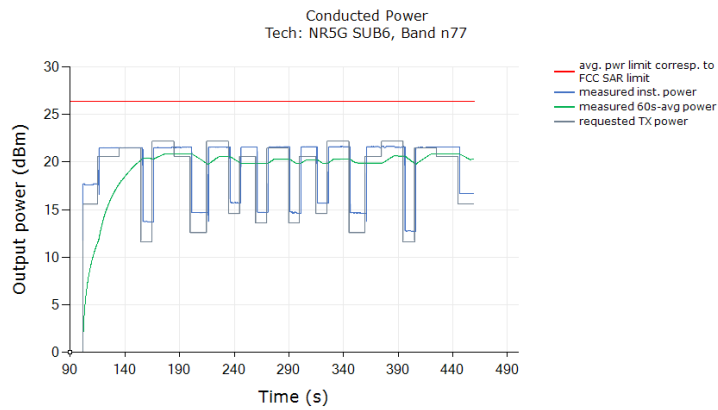

SAR

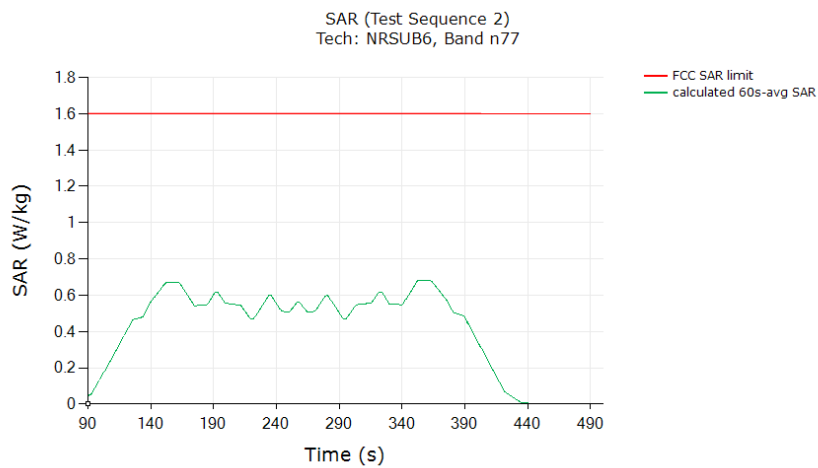

	(W/kg)
FCC 1gSAR limit	1.6
Max 60s-time averaged 1gSAR (green curve)	0.683
Validated: Max time averaged SAR (green curve) is within 1.0 dB device uncertainty of measured SAR at P_{limit} (last column in Table 5-2).	

TAS Validation Report

6.3 Call Drop Test Results

6.3.1 LTE Band 7, Antenna 2 and with callbox requesting maximum power. The call drop was manually performed when the DUT is transmitting at $P_{reserve}$ level as shown in the plot below. The measurement setup is shown in Figure 4-1. The detailed test procedure is described in Section 3.3.2.

Conducted Power

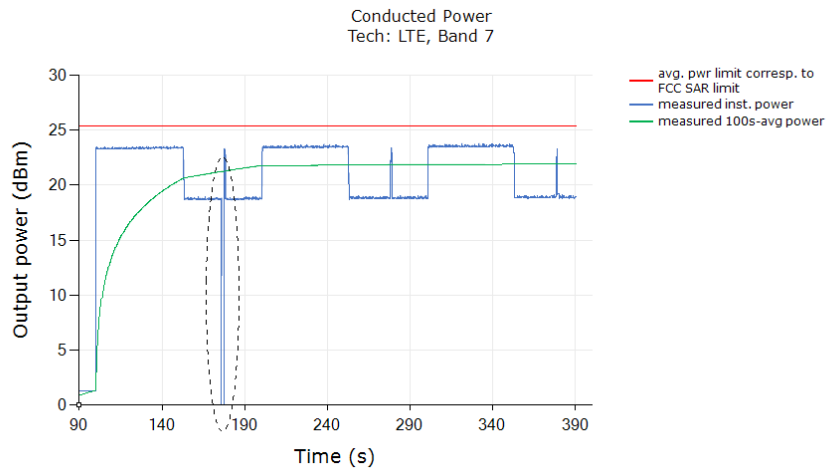

SAR

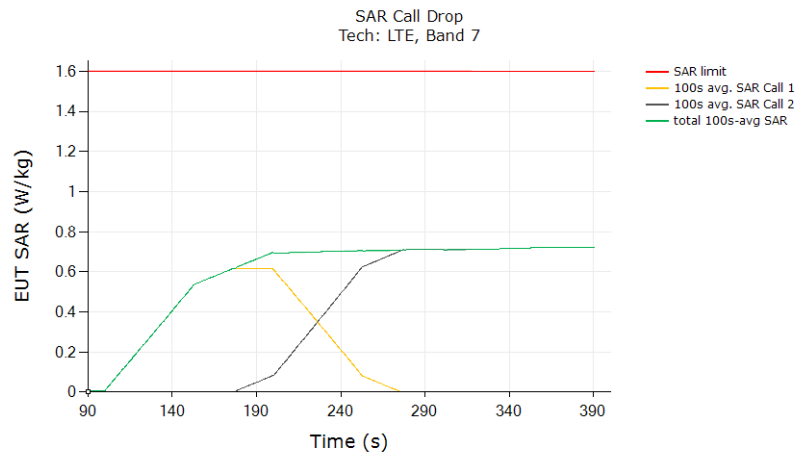

	(W/kg)
FCC 1gSAR limit	1.6
Max 100s-time averaged 1gSAR (green curve)	0.723
Validated	

The test result validated the continuity of power limiting in call change scenario.

TAS Validation Report

6.3.2 5GNR Band 77, Antenna 1 and with callbox requesting maximum power. The call drop was manually performed when the DUT is transmitting at $P_{reserve}$ level as shown in the plot below. The measurement setup is shown in Figure 4-1. The detailed test procedure is described in Section 3.3.2.

Conducted Power

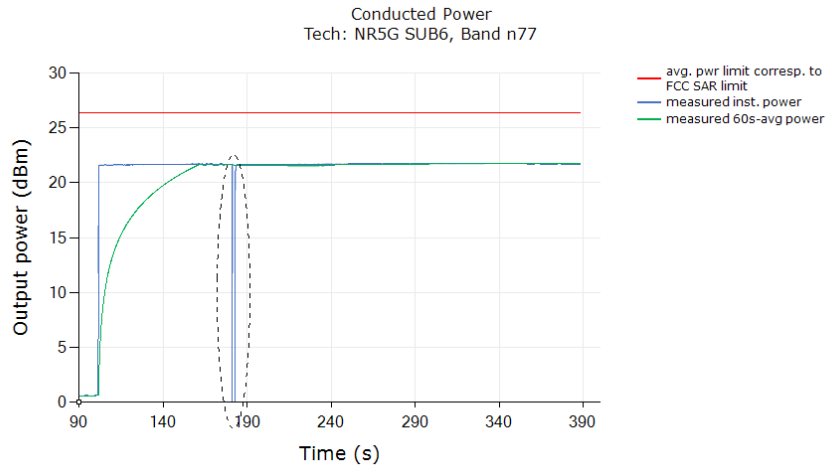

SAR

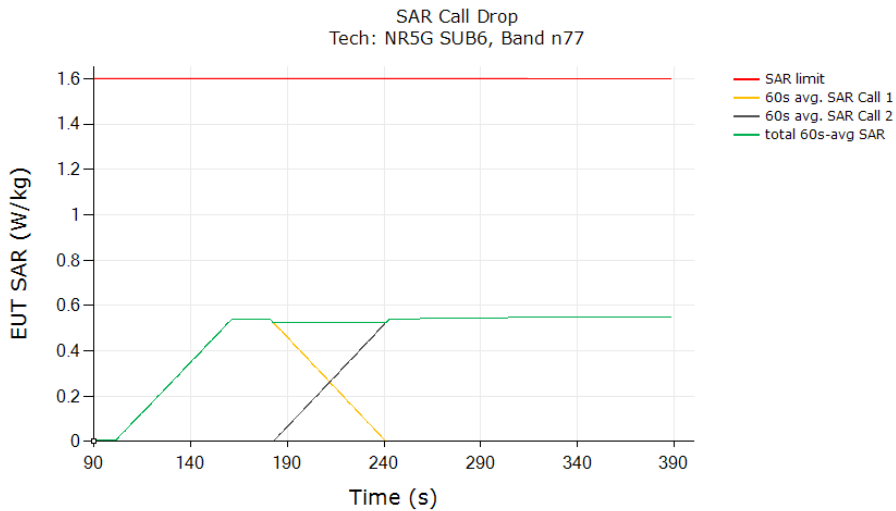

	(W/kg)
FCC 1gSAR limit	1.6
Max 60s-time averaged 1gSAR (green curve)	0.551
Validated	

The test result validated the continuity of power limiting in call change scenario.

TAS Validation Report

6.4 Change in Time Window Test Results

This test was conducted with callbox requesting maximum power, and with time-window/antenna switch between LTE Band 2, Antenna 2 (100s window) and LTE Band 7, Antenna 2 (60s window). Following procedure detailed in Section 3.3.6, and using the measurement setup shown in Figure 4-1, the time-window switch via tech/band/antenna switch was performed when the DUT is transmitting at Preserve level.

6.4.1 Test Case 1: from LTE Band 2 to LTE Band 7, then back to LTE Band 2

Test Result for change in time-window from 100s to 60s to 100s

All the conducted Tx power measurement results were converted into time-averaged normalized SAR values using Equation (7a), (7b) and (7c), and plotted below to demonstrate that the time-averaged normalized SAR versus time does not exceed the FCC limit of 1 unit. Equation (7a) is used to convert the Tx power of device to obtain 100s-averaged normalized SAR in LTE Band 4 as shown in black curve. Similarly, equation (7b) is used to obtain 60s-averaged normalized SAR in LTE Band 48 as shown in orange curve. Equation (7c) is used to obtain total time-averaged normalized SAR as shown in green curve (i.e., sum of black and orange curves).

Conducted Power

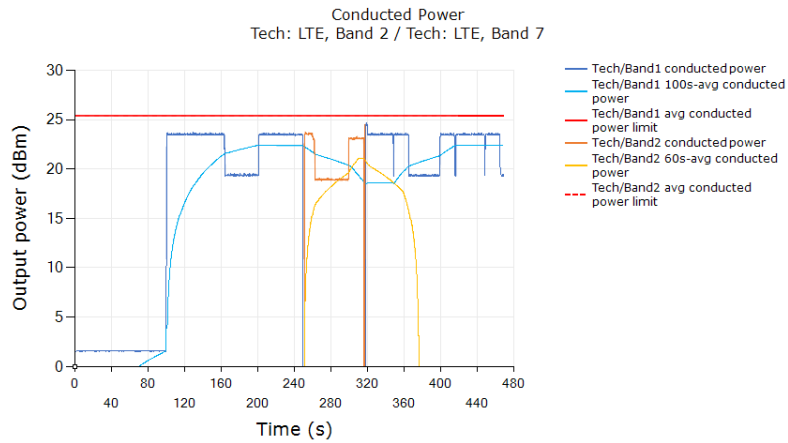

SAR

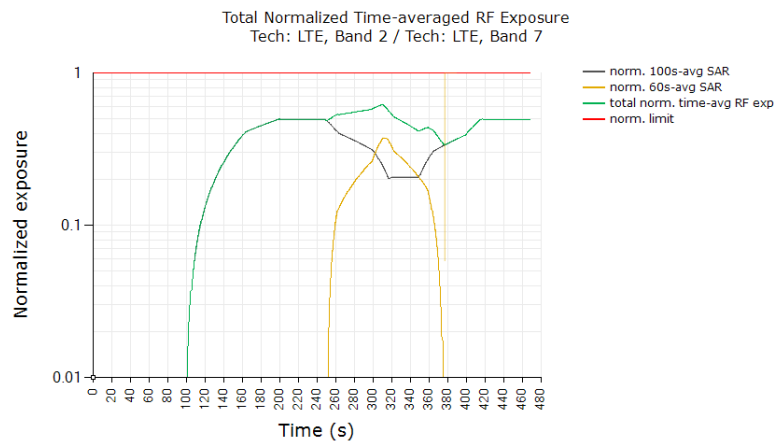

	Exposure Ratio
FCC normalized total exposure limit	1.0
Max time averaged normalized SAR (green curve)	0.619
Validated	

TAS Validation Report

6.5.2 Test Case 2: from LTE Band 7 to LTE Band 2, then back to LTE Band 7

Test Result for change in time-window from 60s to 100s to 60s

All the conducted Tx power measurement results were converted into time-averaged normalized SAR values using Equation (7a), (7b) and (7c), and plotted below to demonstrate that the time-averaged normalized SAR versus time does not exceed the FCC limit of 1 unit. Equation (7a) is used to convert the Tx power of device to obtain 60s-averaged normalized SAR in LTE Band 48 as shown in black curve. Similarly, equation (7b) is used to obtain 100s-averaged normalized SAR in LTE Band 4 as shown in orange curve. Equation (7c) is used to obtain total time-averaged normalized SAR as shown in green curve (i.e., sum of black and orange curves).

Conducted Power

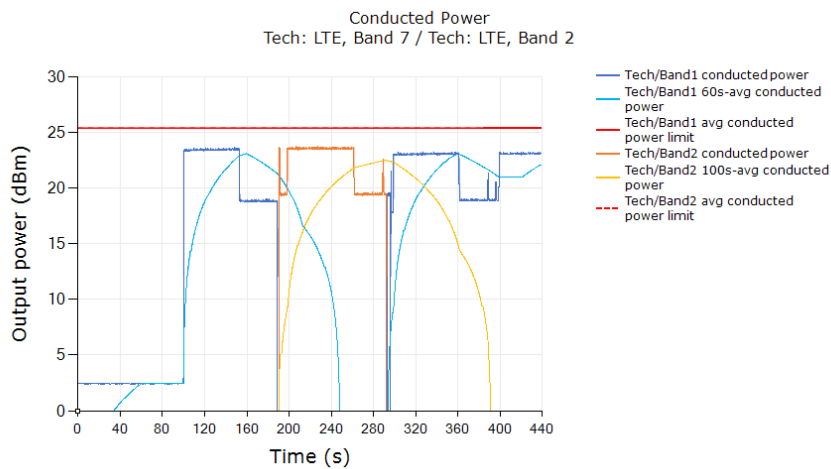

SAR

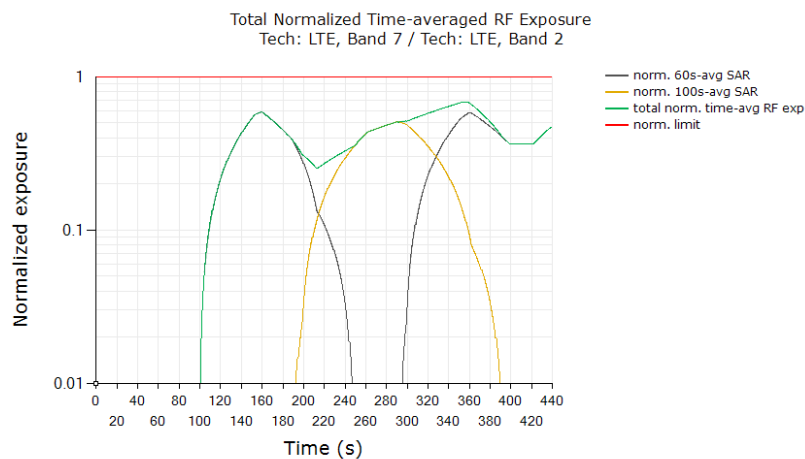

	Exposure Ratio
FCC normalized total exposure limit	1.0
Max time averaged normalized SAR (green curve)	0.683
Validated	

TAS Validation Report

6.5 Switch in SAR Exposure Test Results

This test was conducted with callbox requesting maximum power, and with the DUT in LTE Band 2 + Sub6 NR Band n77 call. Following procedure detailed in Section 3.3.7, and using the measurement setup shown in Figure 4-3 since LTE and Sub6 NR are sharing the same antenna port, the SAR exposure switch measurement is performed with the DUT in various SAR exposure scenarios, i.e., in SAR_{Sub6NR} only scenario (t =0s ~120s), SAR_{Sub6NR} + SAR_{LTE} scenario (t =120s ~ 240s) and SAR_{LTE} only scenario (t > 240s).

All the conducted Tx power measurement results were converted into time-averaged normalized SAR values using Equation (7a), (7b) and (7c), and plotted below to demonstrate that the time-averaged normalized SAR versus time does not exceed the FCC limit of 1 unit. Equation (7a) is used to convert the LTE Tx power of device to obtain 100s-averaged normalized SAR in LTE Band 2 as shown in black curve. Similarly, equation (7b) is used to obtain 100s-averaged normalized SAR in Sub6 NR n77 as shown in orange curve. Equation (7c) is used to obtain total time-averaged normalized SAR as shown in green curve (i.e., sum of black and orange curves).

Conducted Power

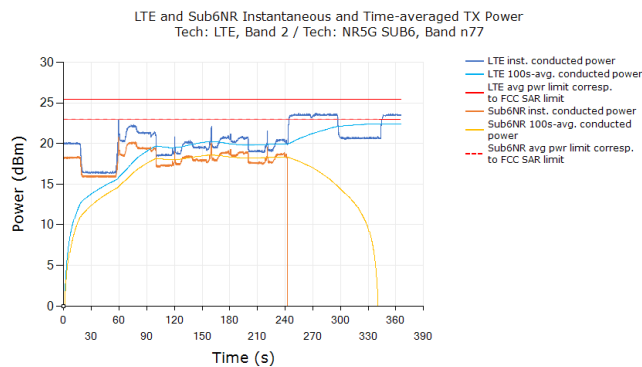

SAR

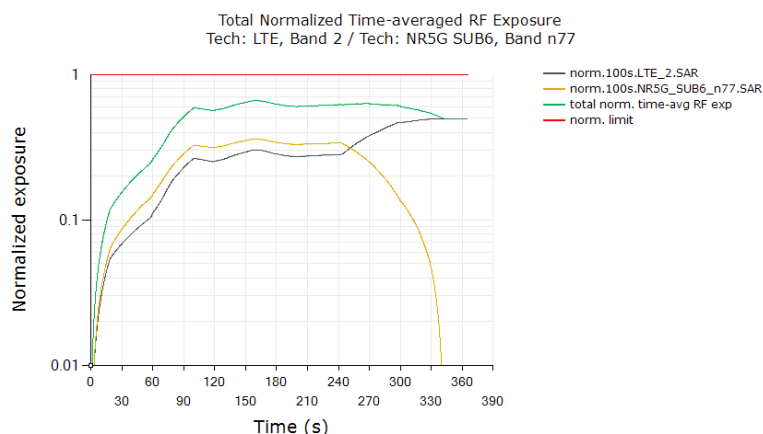

	Exposure Ratio
FCC normalized total exposure limit	1.0
Max time averaged normalized SAR (green curve)	0.664
Validated	

The test result validated the continuity of power limiting in technology/band switch scenario.

7. SAR Test Results for Sub-6 Smart Transmit Validation

7.1 SAR Tissue Verification

The dielectric properties of the tissue simulating liquid have been measured within 24 hours before the SAR testing and within $\pm 10\%$ of the target values. Liquid temperature during the SAR testing has kept within $\pm 2\text{ }^\circ\text{C}$.

Frequency (MHz)	Liquid Temp. ($^\circ\text{C}$)	Conductivity (σ)	Permittivity (ϵ_r)	Conductivity Target (σ)	Permittivity Target (ϵ_r)	σ Delta (%)	ϵ_r Delta (%)	Date
1900	21.6	1.44	41.2	1.4	40	2.86	3.00	Jun. 17, 2024
1900	22	1.48	41.1	1.4	40	5.71	2.75	Jun. 18, 2024
3300	22	2.61	39.7	2.71	38.2	-3.69	3.93	Jun. 21, 2024
3700	22	2.97	39.1	3.12	37.7	-4.81	3.71	Jun. 21, 2024
3900	22	3.17	38.8	3.32	37.5	-4.52	3.47	Jun. 21, 2024
4200	22	3.47	38.3	3.63	37.1	-4.41	3.23	Jun. 21, 2024
3300	21.8	2.61	39.7	2.71	38.2	-3.69	3.93	Jun. 21, 2024
3700	21.8	2.97	39.1	3.12	37.7	-4.81	3.71	Jun. 21, 2024
3900	21.8	3.17	38.8	3.32	37.5	-4.52	3.47	Jun. 21, 2024
4200	21.8	3.47	38.3	3.63	37.1	-4.41	3.23	Jun. 21, 2024

TAS Validation Report

7.2 Test System Verification

Before time-averaged SAR measurements, cDASY6 system has been verified. The result normalized to 1W comparing to the reference SAR value provided by SPEAG in dipole calibration certificate, the deviation of system check results is within its specification of 10 %. The below test results indicate the system check can meet the variation criterion.

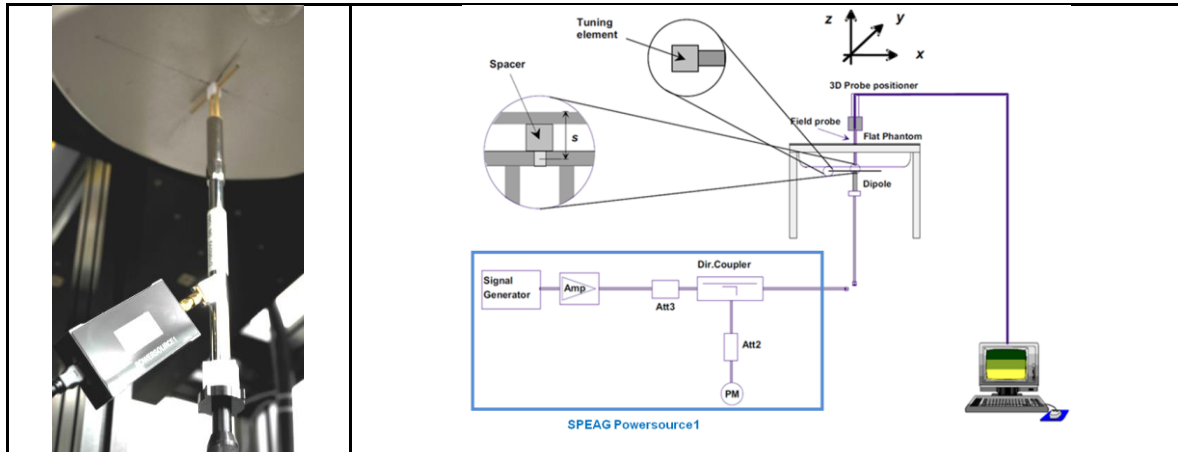

Figure 7-1 System Verification Setup

Date	Frequency (MHz)	Targeted 1g SAR (W/kg)	Measured 1g SAR (W/kg)	Normalized 1g SAR (W/kg)	Deviation (%)	Dipole S/N	Probe S/N	DAE S/N
Jun. 17, 2024	1900	40.30	2.07	41.30	2.49	5d036	7537	1762
Jun. 18, 2024	1900	40.30	2.11	42.10	4.47	5d036	7537	1762
Jun. 21, 2024	3300	65.00	3.37	67.24	3.45	1008	7537	1762
Jun. 21, 2024	3700	65.60	3.37	67.24	2.50	1017	7537	1762
Jun. 21, 2024	3900	69.70	3.27	65.25	-6.39	1020	7537	1762
Jun. 21, 2024	4200	66.30	3.64	72.63	9.54	1006	7537	1762
Jun. 21, 2024	3300	65.00	3.43	68.44	5.29	1008	7537	1762
Jun. 21, 2024	3700	65.60	3.35	66.84	1.89	1017	7537	1762
Jun. 21, 2024	3900	69.70	3.17	63.25	-9.25	1020	7537	1762
Jun. 21, 2024	4200	66.30	3.54	70.63	6.53	1006	7537	1762

8. Test Equipment List

Equipment	Manufacturer	Model	SN	Cal. Date	Cal. Interval
System Validation Dipole	SPEAG	D1900V2	5d036	Feb. 19, 2024	1 Year
System Validation Dipole	SPEAG	D3300V2	1008	Feb. 15, 2024	1 Year
System Validation Dipole	SPEAG	D3700V2	1017	Feb. 15, 2024	1 Year
System Validation Dipole	SPEAG	D3900V2	1020	Feb. 15, 2024	1 Year
System Validation Dipole	SPEAG	D4200V2	1006	Feb. 15, 2024	1 Year
Dosimetric E-Field Probe	SPEAG	EX3DV4	7537	Oct. 23, 2023	1 Year
Data Acquisition Electronics	SPEAG	DAE4	1762	Nov. 17, 2023	1 Year
Universal Radio Communication Tester	Anritsu	MT8821C	6261786083	Aug. 09, 2023	1 Year
Universal Radio Communication Tester	Anritsu	MT8000A	6262012865	Dec. 01, 2023	1 Year
Universal Radio Communication Tester	R&S	CMW500	164864	Jul. 13, 2023	1 Year
3-Path Diode Power Sensor	R&S	NRP8S	111259	Dec. 01, 2023	1 Year
3-Path Diode Power Sensor	R&S	NRP8S	111260	Dec. 01, 2023	1 Year
Vect.Netw.Analyzer 2 Port	R&S	ZNB8	101271	Jan. 09, 2024	1 Year
Dielectric Assessment Kit	SPEAG	DAKS-3.5	1151	Jul. 17, 2023	1 Year
Powersource1	SPEAG	SE_UMS_160 BA	4010	Aug. 15, 2023	1 Year

Notes : CBT (Calibrated Before Testing). Prior to testing, the measurement paths containing a cable, amplifier, attenuator, coupler, or filter were connected to a calibrated source (i.e. a signal generator) to determine the losses of the measurement path. The power meter offset was then adjusted to compensate for the measurement system losses. This level offset is stored within the power meter before measurements are made. This calibration verification procedure applies to the system verification and output power measurements. The calibrated reading is then taken directly from the power meter after compensation of the losses for all final power measurements.

TAS Validation Report

9. Measurement Uncertainty

For SAR Testing:

Source of Uncertainty	Uncertainty (± %)	Probability Distribution	Divisor	Ci (1g)	Ci (10g)	Standard Uncertainty (± %, 1g)	Standard Uncertainty (± %, 10g)	Vi
Measurement System								
Probe Calibration	6.0	Normal	1	1	1	6.0	6.0	∞
Axial Isotropy	4.7	Rectangular	√3	√0.5	√0.5	1.9	1.9	∞
Hemispherical Isotropy	9.6	Rectangular	√3	√0.5	√0.5	3.9	3.9	∞
Boundary Effect	1.0	Rectangular	√3	1	1	0.6	0.6	∞
Linearity	4.7	Rectangular	√3	1	1	2.7	2.7	∞
Detection Limits	0.25	Rectangular	√3	1	1	0.14	0.14	∞
Probe Modulation Response	4.8	Rectangular	√3	1	1	2.8	2.8	∞
Readout Electronics	0.3	Normal	1	1	1	0.3	0.3	∞
Response Time	0.0	Rectangular	√3	1	1	0.0	0.0	∞
Integration Time	1.7	Rectangular	√3	1	1	1.0	1.0	∞
RF Ambient Conditions – Noise	3.0	Rectangular	√3	1	1	1.7	1.7	∞
RF Ambient Conditions – Reflections	3.0	Rectangular	√3	1	1	1.7	1.7	∞
Probe Positioner Mechanical Tolerance	0.02	Rectangular	√3	1	1	0.01	0.01	∞
Probe Positioning with Respect to Phantom	0.4	Rectangular	√3	1	1	0.2	0.2	∞
Post-processing	2.0	Rectangular	√3	1	1	1.2	1.2	∞
Test Sample Related								
Test Sample Positioning	3.68 / 1.73	Normal	1	1	1	3.7	1.7	29
Device Holder Uncertainty	2.55 / 2.76	Normal	1	1	1	2.6	2.8	7
Power Drift of Measurement	5.0	Rectangular	√3	1	1	2.9	2.9	∞
PowerScaling	0.0	Rectangular	√3	1	1	0.0	0.0	∞
Phantom and Setup								
Phantom Uncertainty (Shape and Thickness Tolerances)	7.2	Rectangular	√3	1	1	4.2	4.2	∞
Liquid Conductivity (Temperature Uncertainty)	2.58	Rectangular	√3	0.78	0.71	1.2	1.1	∞
Liquid Conductivity (Measured)	2.95	Normal	1	0.78	0.71	2.3	2.1	61
Liquid Permittivity (Temperature Uncertainty)	1.97	Rectangular	√3	0.23	0.26	0.3	0.3	∞
Liquid Permittivity (Measured)	3.04	Normal	1	0.23	0.26	0.7	0.8	47
Combined Standard Uncertainty						± 11.5 %	± 11.0 %	
Expanded Uncertainty (K=2)						± 23.0 %	± 22.0 %	

SAR Uncertainty Budget for Frequency Range of 300 MHz to 3 GHz

TAS Validation Report

Source of Uncertainty	Uncertainty (± %)	Probability Distribution	Divisor	Ci (1g)	Ci (10g)	Standard Uncertainty (± %, 1g)	Standard Uncertainty (± %, 10g)	Vi
Measurement System								
Probe Calibration	6.55	Normal	1	1	1	6.55	6.55	∞
Axial Isotropy	4.7	Rectangular	√3	0.7	0.7	1.9	1.9	∞
Hemispherical Isotropy	9.6	Rectangular	√3	0.7	0.7	3.9	3.9	∞
Boundary Effect	2.0	Rectangular	√3	1	1	1.2	1.2	∞
Linearity	4.7	Rectangular	√3	1	1	2.7	2.7	∞
Detection Limits	0.25	Rectangular	√3	1	1	0.14	0.14	∞
Probe Modulation Response	4.8	Rectangular	√3	1	1	2.8	2.8	∞
Readout Electronics	0.3	Normal	1	1	1	0.3	0.3	∞
Response Time	0.0	Rectangular	√3	1	1	0.0	0.0	∞
Integration Time	1.7	Rectangular	√3	1	1	1.0	1.0	∞
RF Ambient Conditions – Noise	3.0	Rectangular	√3	1	1	1.7	1.7	∞
RF Ambient Conditions – Reflections	3.0	Rectangular	√3	1	1	1.7	1.7	∞
Probe Positioner Mechanical Tolerance	0.04	Rectangular	√3	1	1	0.02	0.02	∞
Probe Positioning with Respect to Phantom	0.8	Rectangular	√3	1	1	0.5	0.5	∞
Post-processing	4.0	Rectangular	√3	1	1	2.3	2.3	∞
Test Sample Related								
Test Sample Positioning	3.68 / 1.73	Normal	1	1	1	3.7	1.7	29
Device Holder Uncertainty	2.55 / 2.76	Normal	1	1	1	2.6	2.8	7
Power Drift of Measurement	5.0	Rectangular	√3	1	1	2.9	2.9	∞
PowerScaling	0.0	Rectangular	√3	1	1	0.0	0.0	∞
Phantom and Setup								
Phantom Uncertainty (Shape and Thickness Tolerances)	7.6	Rectangular	√3	1	1	4.4	4.4	∞
Liquid Conductivity (Temperature Uncertainty)	2.58	Rectangular	√3	0.78	0.71	1.2	1.1	∞
Liquid Conductivity (Measured)	2.95	Normal	1	0.78	0.71	2.3	2.1	61
Liquid Permittivity (Temperature Uncertainty)	1.97	Rectangular	√3	0.23	0.26	0.3	0.3	∞
Liquid Permittivity (Measured)	3.04	Normal	1	0.23	0.26	0.7	0.8	47
Combined Standard Uncertainty						± 12.1 %	± 11.6 %	
Expanded Uncertainty (K=2)						± 24.2 %	± 23.2 %	

SAR Uncertainty Budget for Frequency Range of 3 GHz to 6 GHz

10. Information of the Testing Laboratories

We, Bureau Veritas Consumer Products Services (H.K.) Ltd., Taoyuan Branch, were founded in 1988 to provide our best service in EMC, Radio, Telecom and Safety consultation. Our laboratories are accredited and approved according to ISO/IEC 17025.

If you have any comments, please feel free to contact us at the following:

Taiwan Huaya Lab:

Add: No. 19, Huaya 2nd Rd., Guishan Dist., Taoyuan City 333, Taiwan

Tel: +886-(0)3-318-3232

Fax: +886-(0)3-211-5834

Taiwan Linkou Lab:

Add: No. 47-2, Baodoucuokeng, Linkou Dist., New Taipei City 244, Taiwan

Tel: +886-(0)2-2605-2180

Fax: +886-(0)2-2605-2943

Taiwan Hsinchu Lab1:

Add: E-2, No. 1, Lixing 1st Rd., East Dist., Hsinchu City 300, Taiwan

Tel: +886-(0)3-666-8565

Fax: +886-(0)3-666-8323

Taiwan Hsinchu Lab2:

Add: No. 49, Ln. 206, Wende Rd., Qionglin Township, Hsinchu County 307, Taiwan

Tel: +886-(0)3-512-0595

Fax: +886-(0)3-512-0568

Taiwan Xindian Lab:

Add: B2F., No. 215, Sec. 3, Beixin Rd., Xindian Dist., New Taipei City 231, Taiwan

Tel: +886-(0)2-8914-5882

Fax: +886-(0)2-8914-5840

Email: service.adt@bureauveritas.com

Web Site: <http://ee.bureauveritas.com.tw>

The road map of all our labs can be found in our web site also.

---END---