

# TEST REPORT

## CERTIFICATE OF CONFORMITY

**Standard:** 47 CFR FCC Part 15, Subpart E (Section 15.407)  
**Report No.:** RFBBQZ-WTW-P23120041-3  
**FCC ID:** PY323300611  
**Product:** NIGHTHAWK BE9300 WiFi 7 Router, NIGHTHAWK BE9200 WiFi 7 Router,  
NIGHTHAWK BE9100 WiFi 7 Router (refer to item 3.1 for more details)  
**Brand:** NETGEAR  
**Model No.:** RS300  
**Series Model:** RS280, RS270 (refer to item 3.1 for more details)  
**Received Date:** 2023/12/4  
**Test Date:** 2024/1/16 ~ 2024/1/27  
**Issued Date:** 2024/2/16

**Applicant and Manufacturer:** NETGEAR, INC.

**Address:** 350 East Plumeria Drive San Jose CA 95134

**Issued By:** Bureau Veritas Consumer Products Services (H.K.) Ltd., Taoyuan Branch  
Lin Kou Laboratories

**Lab Address:** No. 47-2, 14th Ling, Chia Pau Vil., Lin Kou Dist., New Taipei City, Taiwan

**Test Location:** No. 19, Hwa Ya 2nd Rd., Wen Hwa Vil., Kewi Shan Dist., Taoyuan City 33383, Taiwan

### FCC Registration /

**Designation Number:** 788550 / TW0003

**Approved by:** Jeremy Lin, **Date:** 2024/2/16  
Jeremy Lin / Project Engineer

This test report consists of 254 pages in total. It may be duplicated completely for legal use with the approval of the applicant. It should not be reproduced except in full, without the written approval of our laboratory. The test results in the report only apply to the tested sample. The test results in this report are traceable to the national or international standards.



Prepared by : Pettie Chen / Senior Specialist

This report is governed by, and incorporates by reference, the Conditions of Testing as posted at the date of issuance of this report at <http://www.bureauveritas.com/home/about-us/our-business/cps/about-us/terms-conditions/> and is intended for your exclusive use. Any copying or replication of this report to or for any other person or entity, or use of our name or trademark, is permitted only with our prior written permission. This report sets forth our findings solely with respect to the test samples identified herein. The results set forth in this report are not indicative or representative of the quality or characteristics of the lot from which a test sample was taken or any similar or identical product unless specifically and expressly noted. Our report includes all of the tests requested by you and the results thereof based upon the information that you provided to us. Measurement uncertainty is only provided upon request for accredited tests. Statements of conformity are based on simple acceptance criteria without taking measurement uncertainty into account, unless otherwise requested in writing. You have 60 days from date of issuance of this report to notify us of any material error or omission caused by our negligence or if you require measurement uncertainty; provided, however, that such notice shall be in writing and shall specifically address the issue you wish to raise. A failure to raise such issue within the prescribed time shall constitute your unqualified acceptance of the completeness of this report, the tests conducted and the correctness of the report contents.

## Table of Contents

<b>Release Control Record</b> .....	<b>4</b>
<b>1 Certificate</b> .....	<b>5</b>
<b>2 Summary of Test Results</b> .....	<b>6</b>
2.1 Measurement Uncertainty .....	6
2.2 Supplementary Information .....	6
<b>3 General Information</b> .....	<b>7</b>
3.1 General Description of EUT .....	7
3.2 Antenna Description of EUT .....	9
3.3 Channel List .....	10
3.4 Test Mode Applicability and Tested Channel Detail .....	13
3.5 Duty Cycle of Test Signal .....	15
3.6 Test Program Used and Operation Descriptions .....	18
3.7 Connection Diagram of EUT and Peripheral Devices .....	18
3.8 Configuration of Peripheral Devices and Cable Connections .....	18
<b>4 Test Instruments</b> .....	<b>19</b>
4.1 Maximum RF Output Power .....	19
4.2 Maximum Power Spectral Density .....	19
4.3 Emission Bandwidth .....	19
4.4 In-Band Emission Mask .....	20
4.5 Occupied Bandwidth .....	20
4.6 Frequency Stability .....	20
4.7 Contention-based Protocol .....	20
4.8 AC Power Conducted Emissions .....	21
4.9 Unwanted Emissions below 1 GHz .....	22
4.10 Unwanted Emissions above 1 GHz .....	23
<b>5 Limits of Test Items</b> .....	<b>24</b>
5.1 Maximum RF Output Power .....	24
5.2 Maximum Power Spectral Density .....	24
5.3 Emission Bandwidth .....	24
5.4 In-Band Emission Mask .....	24
5.5 Occupied Bandwidth .....	24
5.6 Frequency Stability .....	24
5.7 Contention-based Protocol .....	25
5.8 AC Power Conducted Emissions .....	25
5.9 Unwanted Emissions below 1 GHz .....	25
5.10 Unwanted Emissions above 1 GHz .....	26
<b>6 Test Arrangements</b> .....	<b>27</b>
6.1 Maximum RF Output Power .....	27
6.1.1 Test Setup .....	27
6.1.2 Test Procedure .....	27
6.2 Maximum Power Spectral Density .....	28
6.2.1 Test Setup .....	28
6.2.2 Test Procedure .....	28
6.3 Emission Bandwidth .....	29
6.3.1 Test Setup .....	29
6.3.2 Test Procedure .....	29
6.4 In-Band Emission Mask .....	29
6.4.1 Test Setup .....	29
6.4.2 Test Procedure .....	29
6.5 Occupied Bandwidth .....	30
6.5.1 Test Setup .....	30
6.5.2 Test Procedure .....	30
6.6 Frequency Stability .....	30
6.6.1 Test Setup .....	30



6.6.2	Test Procedure	30
6.7	Contention-based Protocol	31
6.7.1	Test Setup	31
6.7.2	Test Procedure	31
6.8	AC Power Conducted Emissions	32
6.8.1	Test Setup	32
6.8.2	Test Procedure	32
6.9	Unwanted Emissions below 1 GHz	33
6.9.1	Test Setup	33
6.9.2	Test Procedure	34
6.10	Unwanted Emissions above 1 GHz	35
6.10.1	Test Setup	35
6.10.2	Test Procedure	35
<b>7</b>	<b>Test Results of Test Item</b>	<b>36</b>
7.1	Maximum RF Output Power	36
7.2	Maximum Power Spectral Density	43
7.3	Emission Bandwidth	50
7.4	In-Band Emission Mask	57
7.5	Occupied Bandwidth	95
7.6	Frequency Stability	102
7.7	Contention-based Protocol	103
7.8	AC Power Conducted Emissions	112
7.9	Unwanted Emissions below 1 GHz	118
7.10	Unwanted Emissions above 1 GHz	124
<b>8</b>	<b>Pictures of Test Arrangements</b>	<b>253</b>
<b>9</b>	<b>Information of the Testing Laboratories</b>	<b>254</b>



## Release Control Record

Issue No.	Description	Date Issued
RFBBQZ-WTW-P23120041-3	Original release.	2024/2/16

## 1 Certificate

**Product:** NIGHTHAWK BE9300 WiFi 7 Router, NIGHTHAWK BE9200 WiFi 7 Router,  
NIGHTHAWK BE9100 WiFi 7 Router (refer to item 3.1 for more details)

**Brand:** NETGEAR

**Test Model:** RS300

**Series Model:** RS280, RS270 (refer to item 3.1 for more details)

**Sample Status:** Engineering sample

**Applicant:** NETGEAR, INC.

**Test Date:** 2024/1/16 ~ 2024/1/27

**Standard:** 47 CFR FCC Part 15, Subpart E (Section 15.407)

**Measurement** ANSI C63.10-2013

**procedure:**

KDB 987594 D02 U-NII 6 GHz EMC Measurement v02r01

KDB 789033 D02 General UNII Test Procedure New Rules v02r01

KDB 662911 D01 Multiple Transmitter Output v02r01

The above equipment has been tested by **Bureau Veritas Consumer Products Services (H.K.) Ltd., Taoyuan Branch**, and found compliance with the requirement of the above standards. The test record, data evaluation & Equipment Under Test (EUT) configurations represented herein are true and accurate accounts of the measurements of the sample's RF characteristics under the conditions specified in this report.

## 2 Summary of Test Results

47 CFR FCC Part 15, Subpart E (Section 15.407)			
Clause	Test Item	Result	Remark
15.407(a)(5)	Maximum RF Output Power	Pass	Meet the requirement of limit.
15.407(a)(5)	Maximum Power Spectral Density	Pass	Meet the requirement of limit.
15.407(a)(10)	Emission Bandwidth	Pass	Meet the requirement of limit.
15.407(a)(10)	Occupied Bandwidth	Pass	Meet the requirement of limit.
15.407(b)(9)	AC Power Conducted Emissions	Pass	Minimum passing margin is -9.33 dB at 0.42600 MHz
15.407(b)(9)	Unwanted Emissions below 1 GHz	Pass	Minimum passing margin is -3.2 dB at 86.26 MHz
15.407(b)(6) 15.407(b)(10)	Unwanted Emissions above 1 GHz	Pass	Minimum passing margin is -0.1 dB at 7125.00 MHz
15.407(b)(7)	In-Band Emission Mask	Pass	Meet the requirement of limit.
15.407(d)(6)	Contention-based Protocol	Pass	Meet the requirement of limit.
15.407(g)	Frequency Stability	Pass	Meet the requirement of limit.
15.203	Antenna Requirement	Pass	Antenna connector is ipex(MHF) not a standard connector.

### Notes:

- Determining compliance based on the results of the compliance measurement, not taking into account measurement instrumentation uncertainty.
- Per TCBC notice, FCC allows 99% BW measurements for Wi-Fi 320MHz BW mode instead of Emission Bandwidth.

### 2.1 Measurement Uncertainty

Where relevant, the following measurement uncertainty levels have been estimated for tests performed on the EUT as specified in CISPR 16-4-2:

Measurement	Specification	Expanded Uncertainty (k=2) (±)
Maximum RF Output Power	1 GHz ~ 18 GHz	2.29 dB
Maximum Power Spectral Density	1 GHz ~ 18 GHz	2.29 dB
Occupied Bandwidth	-	72 Hz
AC Power Conducted Emissions	9 kHz ~ 30 MHz	2.88 dB
Unwanted Emissions below 1 GHz	9 kHz ~ 30 MHz	3.59 dB
	30 MHz ~ 1 GHz	3.64 dB
Unwanted Emissions above 1 GHz	1 GHz ~ 18 GHz	2.29 dB
	18 GHz ~ 40 GHz	2.29 dB

The other instruments specified are routine verified to remain within the calibrated levels, no measurement uncertainty is required to be calculated.

### 2.2 Supplementary Information

There is not any deviation from the test standards for the test method, and no modifications required for compliance.

### 3 General Information

#### 3.1 General Description of EUT

Product	NIGHTHAWK BE9300 WiFi 7 Router, NIGHTHAWK BE9200 WiFi 7 Router, NIGHTHAWK BE9100 WiFi 7 Router
Brand	NETGEAR
Test Model	RS300
Series Model	RS280, RS270
Model Difference	Refer to note
Status of EUT	Engineering sample
Power Supply Rating	Refer to note
Modulation Type	64QAM, 16QAM, QPSK, BPSK for OFDM 1024QAM for OFDMA in 11ax mode 4096QAM for OFDMA in 11be mode
Modulation Technology	OFDM, OFDMA
Transfer Rate	802.11a: up to 54 Mbps 802.11ax: up to 2401.9 Mbps 802.11be: up to 2882.4 Mbps
Operating Frequency	6.115 GHz ~ 6.415 GHz 6.425 GHz ~ 6.525 GHz 6.535 GHz ~ 6.865 GHz 6.875 GHz ~ 7.115 GHz
Number of Channel	802.11a, 802.11ax (HE20), 802.11be (EHT20): 51 802.11ax (HE40), 802.11be (EHT40): 25 802.11ax (HE80), 802.11be (EHT80): 12 802.11ax (HE160), 802.11be (EHT160): 6 802.11be (EHT320): 5
Output Power	6.115 GHz ~ 6.415 GHz: EIRP: 933.254 mW (29.7 dBm) 6.425 GHz ~ 6.525 GHz: EIRP: 924.698 mW (29.66 dBm) 6.535 GHz ~ 6.865 GHz: EIRP: 916.22 mW (29.62 dBm) 6.875 GHz ~ 7.115 GHz: EIRP: 554.626 mW (27.44 dBm)
Equipment Class	6ID: 15E 6 GHz Low-power indoor access point

Note:

- The following product and models are electrically identical, different model names are for marketing purpose. The model of the RS300 was chosen for final test.

Product	Model	remark
NIGHTHAWK BE9300 WiFi 7 Router	RS300	RS300, RS280 and RS270 are same hardware, just re-model name to sell different channel.
NIGHTHAWK BE9200 WiFi 7 Router	RS280	
NIGHTHAWK BE9100 WiFi 7 Router	RS270	

2. The EUT uses following accessories.

AC Adapter 1			
Brand	Model	Part Number	Specification
NETGEAR	AD2150F10	332-11494-02	AC Input : 100-120V~, 50/60Hz, 1.0A DC Output : 12V, 3.5A DC Output Cable : 1.8m cable without core Plug : US Manufacturer : PI ELECTRONICS (VIETNAM) COMPANY LIMITED
AC Adapter 2			
Brand	Model	Part Number	Specification
NETGEAR	ADS-45FIC-12 12042E	332-11664-02	AC Input : 100-240V~, 50/60Hz, 1.5A DC Output : 12.0V, 3.5A, 42.0W DC Output Cable : 1.8m cable without core Plug : US Manufacturer : VIETNAM HONOR HIGH TECH COMPANY LIMITED
AC Adapter 3			
Brand	Model	Part Number	Specification
NETGEAR	AD2150M20	332-11500-05	AC Input : 100-240V~, 50/60 Hz, 1.0A DC Output : 12V, 3.5A, 42.0W DC Output Cable : 1.8m cable without core Plug : US Manufacturer : PI ELECTRONICS (VIETNAM) COMPANY LIMITED
Ethernet Cable			
Brand		Specification	
NETGEAR		1.96m non-shielded cable without core	

3. The above EUT information is declared by manufacturer and for more detailed features description, please refers to the manufacturer's specifications or user's manual.



### 3.2 Antenna Description of EUT

1. The antenna information is listed as below.

#### Option 1

Antenna No.	Gain (dBi)										Antenna Type	Connector Type
	6000 MHz	6200 MHz	6300 MHz	6500 MHz	6700 MHz	6800 MHz	6900 MHz	7000 MHz	7100 MHz	7125 MHz		
6G 0	3.70	3.75	4.11	4.66	4.93	4.56	4.07	4.13	4.27	4.12	Dipole	ipex(MHF)
6G 1	3.62	3.78	4.25	4.85	4.99	4.85	4.14	4.02	4.07	4.34	Dipole	ipex(MHF)

#### Option 2

Antenna No.	Gain (dBi)										Antenna Type	Connector Type
	6000 MHz	6200 MHz	6300 MHz	6500 MHz	6700 MHz	6800 MHz	6900 MHz	7000 MHz	7100 MHz	7125 MHz		
6G 0	3.59	3.69	4.06	4.54	4.82	4.48	3.92	3.98	4.14	4.05	Dipole	ipex(MHF)
6G 1	3.52	3.72	4.16	4.66	4.96	4.74	4.08	3.93	4.03	4.25	Dipole	ipex(MHF)

\* Detail antenna specification please refer to antenna datasheet and/or antenna measurement report.

2. The EUT incorporates a MIMO function:

6 GHz Band			
Modulation Mode	Beamforming Mode	TX & RX Configuration	
802.11a	Not Support	2TX	2RX
802.11ax (HE20)	Support	2TX	2RX
802.11ax (HE40)	Support	2TX	2RX
802.11ax (HE80)	Support	2TX	2RX
802.11ax (HE160)	Support	2TX	2RX
802.11be (EHT20)	Support	2TX	2RX
802.11be (EHT40)	Support	2TX	2RX
802.11be (EHT80)	Support	2TX	2RX
802.11be (EHT160)	Support	2TX	2RX
802.11be (EHT320)	Support	2TX	2RX

Note:

- All of modulation mode support beamforming function except 802.11a modulation mode.
- The EUT support Beamforming and CDD mode, therefore both mode were investigated and the worst case scenario was identified. The worst case data were presented in test report.
- The modulation and bandwidth are similar for 802.11ax mode for 20 MHz (40 MHz, 80 MHz, 160 MHz) and 802.11be mode for 20 MHz (40 MHz, 80 MHz, 160 MHz) therefore the manufacturer will control the power for 802.11ax mode is same as the 802.11be mode or more lower than it and investigated worst case to representative mode in test report.
- The EUT device modulation technique OFDMA does not support partial RUs (resource units) and channel puncturing/bandwidth reduction mechanisms.

### 3.3 Channel List

#### U-NII-5:

16 channels are provided for 802.11a, 802.11ax (HE20), 802.11be (EHT20):

Channel	Frequency	Channel	Frequency	Channel	Frequency	Channel	Frequency
33	6115 MHz	37	6135 MHz	41	6155 MHz	45	6175 MHz
49	6195 MHz	53	6215 MHz	57	6235 MHz	61	6255 MHz
65	6275 MHz	69	6295 MHz	73	6315 MHz	77	6335 MHz
81	6355 MHz	85	6375 MHz	89	6395 MHz	93	6415 MHz

8 channels are provided for 802.11ax (HE40), 802.11be (EHT40):

Channel	Frequency	Channel	Frequency	Channel	Frequency	Channel	Frequency
35	6125 MHz	43	6165 MHz	51	6205 MHz	59	6245 MHz
67	6285 MHz	75	6325 MHz	83	6365 MHz	91	6405 MHz

4 channels are provided for 802.11ax (HE80), 802.11be (EHT80):

Channel	Frequency	Channel	Frequency	Channel	Frequency	Channel	Frequency
39	6145 MHz	55	6225 MHz	71	6305 MHz	87	6385 MHz

2 channels are provided for 802.11ax (HE160), 802.11be (EHT160):

Channel	Frequency	Channel	Frequency
47	6185 MHz	79	6345 MHz

1 channel is provided for 802.11be (EHT320):

Channel	Frequency
63	6265 MHz

#### U-NII-6:

5 channels are provided for 802.11a, 802.11ax (HE20), 802.11be (EHT20):

Channel	Frequency	Channel	Frequency	Channel	Frequency	Channel	Frequency
97	6435 MHz	101	6455 MHz	105	6475 MHz	109	6495 MHz
113	6515 MHz						

3 channels are provided for 802.11ax (HE40), 802.11be (EHT40):

Channel	Frequency	Channel	Frequency	Channel	Frequency
99	6445 MHz	107	6485 MHz	*115	6525 MHz

1 channel is provided for 802.11ax (HE80), 802.11be (EHT80):

Channel	Frequency
103	6465 MHz

1 channel is provided for 802.11ax (HE160), 802.11be (EHT160):

Channel	Frequency
*111	6505 MHz

1 channel is provided for 802.11be (EHT320):

Channel	Frequency
*95	6425 MHz

**U-NII-7:**

17 channels are provided for 802.11a, 802.11ax (HE20), 802.11be (EHT20):

Channel	Frequency	Channel	Frequency	Channel	Frequency	Channel	Frequency
117	6535 MHz	121	6555 MHz	125	6575 MHz	129	6595 MHz
133	6615 MHz	137	6635 MHz	141	6655 MHz	145	6675 MHz
149	6695 MHz	153	6715 MHz	157	6735 MHz	161	6755 MHz
165	6775 MHz	169	6795 MHz	173	6815 MHz	177	6835 MHz
181	6855 MHz						

8 channels are provided for 802.11ax (HE40), 802.11be (EHT40):

Channel	Frequency	Channel	Frequency	Channel	Frequency	Channel	Frequency
123	6565 MHz	131	6605 MHz	139	6645 MHz	147	6685 MHz
155	6725 MHz	163	6765 MHz	171	6805 MHz	179	6845 MHz

5 channels are provided for 802.11ax (HE80), 802.11be (EHT80):

Channel	Frequency	Channel	Frequency	Channel	Frequency	Channel	Frequency
*119	6545 MHz	135	6625 MHz	151	6705 MHz	167	6785 MHz
*183	6865 MHz						

2 channels are provided for 802.11ax (HE160), 802.11be (EHT160):

Channel	Frequency	Channel	Frequency
143	6665 MHz	*175	6825 MHz

2 channels are provided for 802.11be (EHT320):

Channel	Frequency	Channel	Frequency
*127	6585 MHz	*159	6745 MHz

**U-NII-8:**

13 channels are provided for 802.11a, 802.11ax (HE20), 802.11be (EHT20):

Channel	Frequency	Channel	Frequency	Channel	Frequency	Channel	Frequency
185	6875 MHz	189	6895 MHz	193	6915 MHz	197	6935 MHz
201	6955 MHz	205	6975 MHz	209	6995 MHz	213	7015 MHz
217	7035 MHz	221	7055 MHz	225	7075 MHz	229	7095 MHz
233	7115 MHz						

6 channels are provided for 802.11ax (HE40), 802.11be (EHT40):

Channel	Frequency	Channel	Frequency	Channel	Frequency	Channel	Frequency
187	6885 MHz	195	6925 MHz	203	6965 MHz	211	7005 MHz
219	7045 MHz	227	7085 MHz				

2 channels are provided for 802.11ax (HE80), 802.11be (EHT80):

Channel	Frequency	Channel	Frequency
199	6945 MHz	215	7025 MHz

1 channel is provided for 802.11ax (HE160), 802.11be (EHT160):

Channel	Frequency
207	6985 MHz

1 channel is provided for 802.11be (EHT320):

Channel	Frequency
*191	6905 MHz

Note: \* mean these are straddle channels.

### 3.4 Test Mode Applicability and Tested Channel Detail

Pre-Scan:	The AC Adapter has the following models: AC adapter 1 ~ 3. Pre-scan these models of AC Adapters and find the worst case as a representative test condition.
Worst Case:	1. The worst case: Adapter 1. 2. The EUT is usually used standing that and was therefore chosen for Unwanted Emissions.

Following channel(s) was (were) selected for the final test as listed below:

Test Item	EUT Configure Mode	Mode	Signal Mode	Tested Channel	Modulation	Data Rate Parameter	BF Mode
RF Output Power / Power Spectral Density	A	802.11a	CDD	33, 61, 93, 97, 105, 113, 117, 149, 181, 185, 209, 229, 233	BPSK	6Mb/s	-
		802.11be (EHT20)	Beamforming	33, 61, 93, 97, 105, 113, 117, 149, 181, 185, 209, 229, 233	BPSK	MCS0	Nss1, Nss2
		802.11be (EHT40)	Beamforming	35, 59, 91, 99, 107, 115, 123, 155, 179, 187, 211, 227	BPSK	MCS0	Nss1, Nss2
		802.11be (EHT80)	Beamforming	39, 55, 87, 103, 119, 135, 151, 167, 183, 199, 215	BPSK	MCS0	Nss1, Nss2
		802.11be (EHT160)	Beamforming	47, 79, 111, 143, 175, 207	BPSK	MCS0	Nss1, Nss2
		802.11be (EHT320)	Beamforming	63, 95, 127, 159, 191	BPSK	MCS0	Nss1, Nss2
Emission Bandwidth / In-Band Emission Mask / Occupied Bandwidth	A	802.11a	CDD	33, 61, 93, 97, 105, 113, 117, 149, 181, 185, 209, 229, 233	BPSK	6Mb/s	-
		802.11be (EHT20)	Beamforming	33, 61, 93, 97, 105, 113, 117, 149, 181, 185, 209, 229, 233	BPSK	MCS0	Nss1, Nss2
		802.11be (EHT40)	Beamforming	35, 59, 91, 99, 107, 115, 123, 155, 179, 187, 211, 227	BPSK	MCS0	Nss1, Nss2
		802.11be (EHT80)	Beamforming	39, 55, 87, 103, 119, 135, 151, 167, 183, 199, 215	BPSK	MCS0	Nss1, Nss2
		802.11be (EHT160)	Beamforming	47, 79, 111, 143, 175, 207	BPSK	MCS0	Nss1, Nss2
		802.11be (EHT320)	Beamforming	63, 95, 127, 159, 191	BPSK	MCS0	Nss1, Nss2
Frequency Stability	A	802.11a	CDD	33	un-modulation	-	-
Contention-based Protocol	A	802.11be (EHT20)	Beamforming	45, 105, 149, 209	BPSK	MCS0	Nss1
		802.11be (EHT320)	Beamforming	63, 95, 127, 191	BPSK	MCS0	Nss1



Test Item	EUT Configure Mode	Mode	Signal Mode	Tested Channel	Modulation	Data Rate Parameter	BF Mode
AC Power Conducted Emissions	A, B, C	802.11be (EHT320)	Beamforming	63	BPSK	MCS0	Nss1
Unwanted Emissions below 1 GHz	A, B, C	802.11be (EHT320)	Beamforming	63	BPSK	MCS0	Nss1
Unwanted Emissions above 1 GHz	A	802.11a	CDD	33, 61, 93, 97, 105, 113, 117, 149, 181, 185, 209, 229, 233	BPSK	6Mb/s	-
		802.11be (EHT20)	Beamforming	33, 61, 93, 97, 105, 113, 117, 149, 181, 185, 209, 229, 233	BPSK	MCS0	Nss1, Nss2
		802.11be (EHT40)	Beamforming	35, 59, 91, 99, 107, 115, 123, 155, 179, 187, 211, 227	BPSK	MCS0	Nss1, Nss2
		802.11be (EHT80)	Beamforming	39, 55, 87, 103, 119, 135, 151, 167, 183, 199, 215	BPSK	MCS0	Nss1, Nss2
		802.11be (EHT160)	Beamforming	47, 79, 111, 143, 175, 207	BPSK	MCS0	Nss1, Nss2
		802.11be (EHT320)	Beamforming	63, 95, 127, 159, 191	BPSK	MCS0	Nss1, Nss2
EUT Configure Mode:	A	Power from Adapter 1: AD2150F10					
	B	Power from Adapter 2: ADS-45FIC-12 12042E					
	C	Power from Adapter 3: AD2150M20					

### 3.5 Duty Cycle of Test Signal

**802.11a:** Duty cycle = 3.02 ms / 3.03 ms x 100% = 99.7%

**802.11be (EHT20):** Duty cycle = 2.88 ms / 2.89 ms x 100% = 99.7%

**802.11be (EHT40):** Duty cycle = 2.86 ms / 2.88 ms x 100% = 99.3%

**802.11be (EHT80):** Duty cycle = 2.85 ms / 2.86 ms x 100% = 99.7%

**802.11be (EHT160):** Duty cycle = 2.85 ms / 2.87 ms x 100% = 99.3%

**802.11be (EHT320):** Duty cycle = 2.86 ms / 2.87 ms x 100% = 99.7%

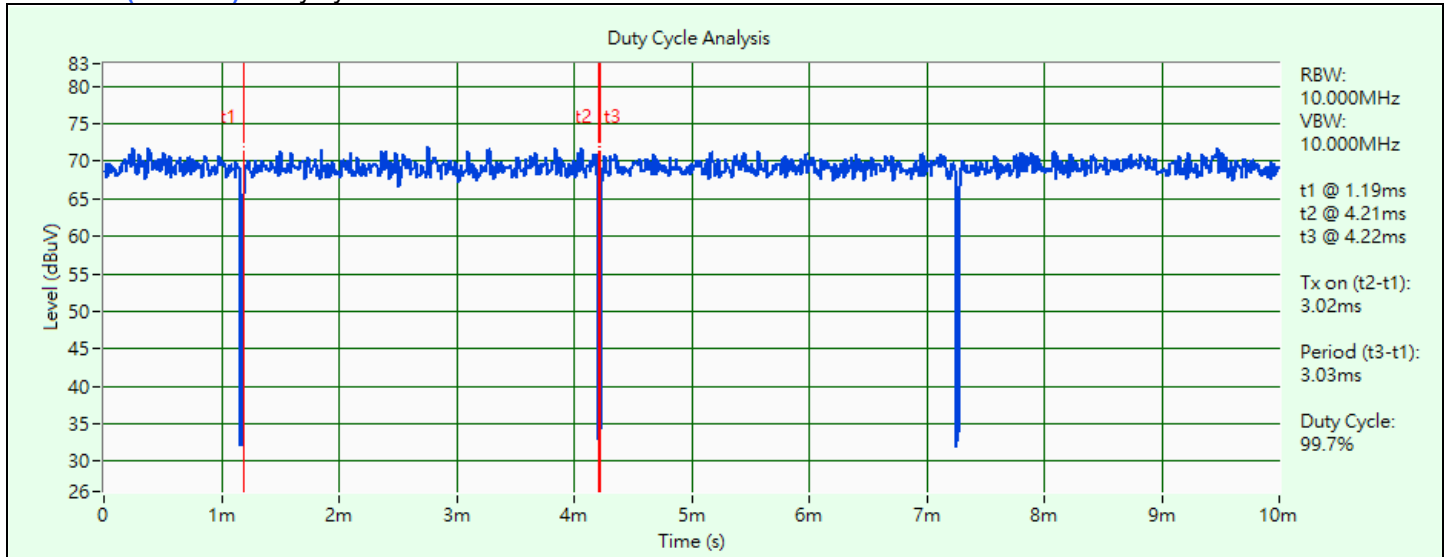

802.11a

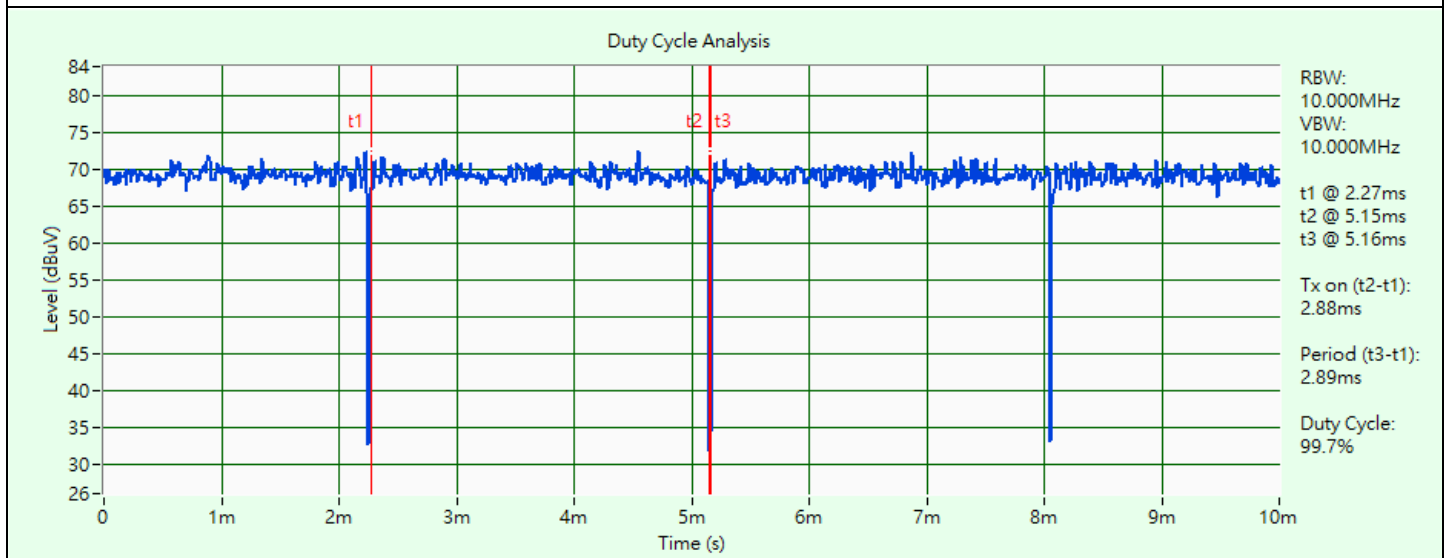

802.11be (EHT20)

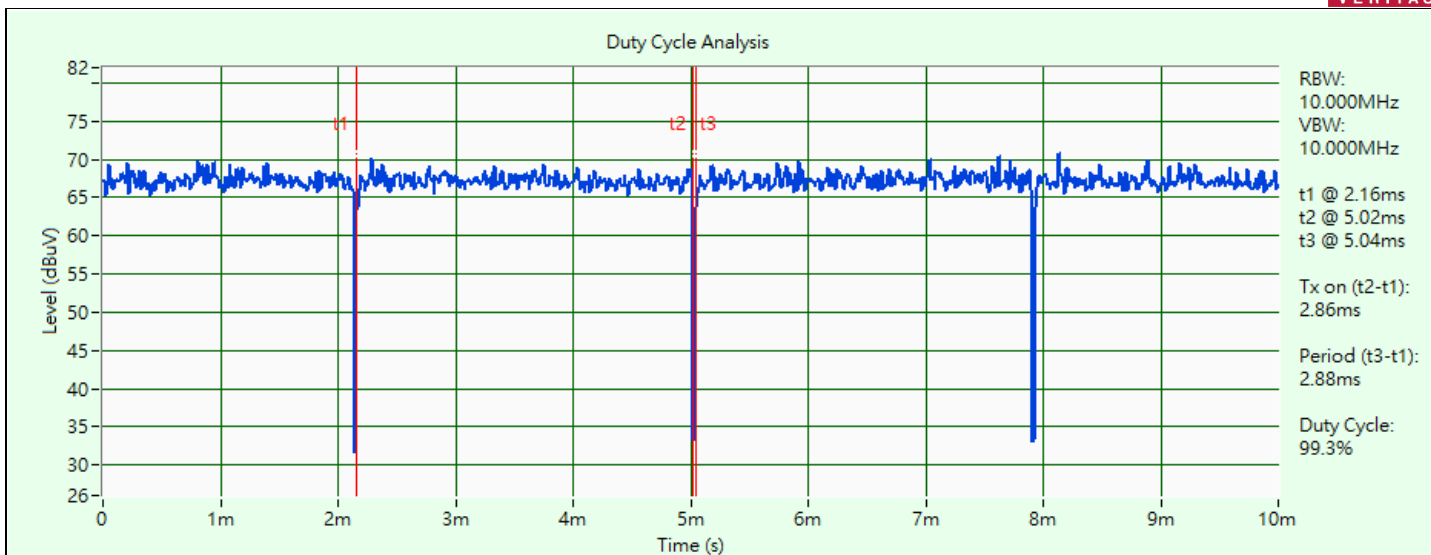

802.11be (EHT40)

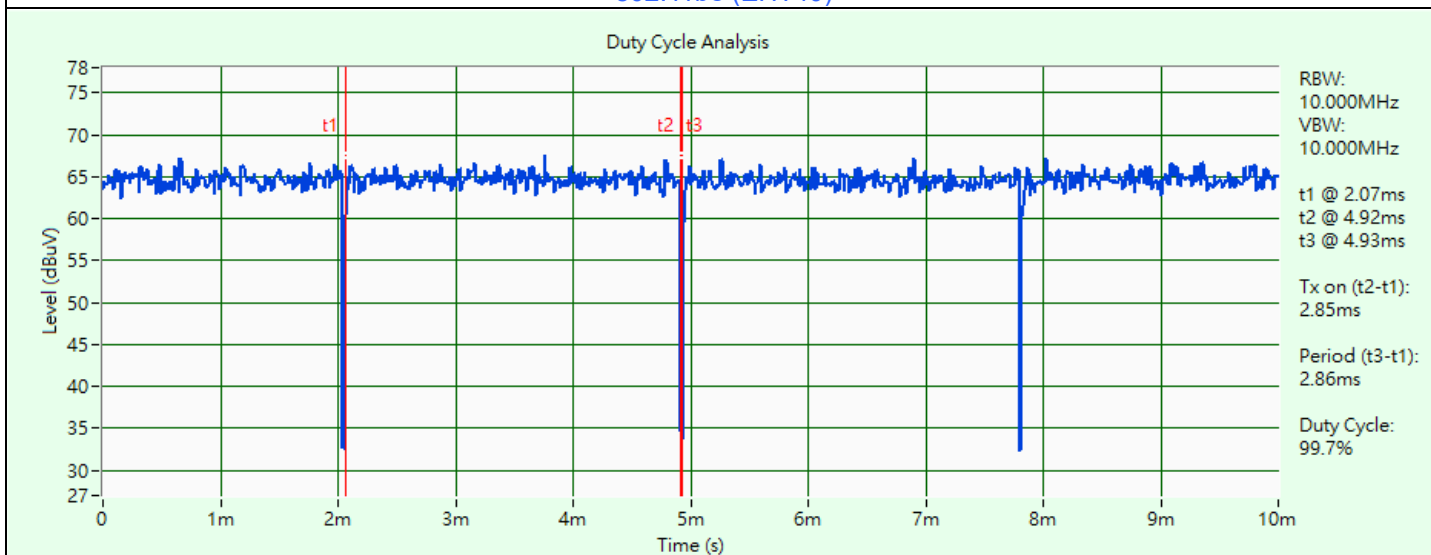

802.11be (EHT80)

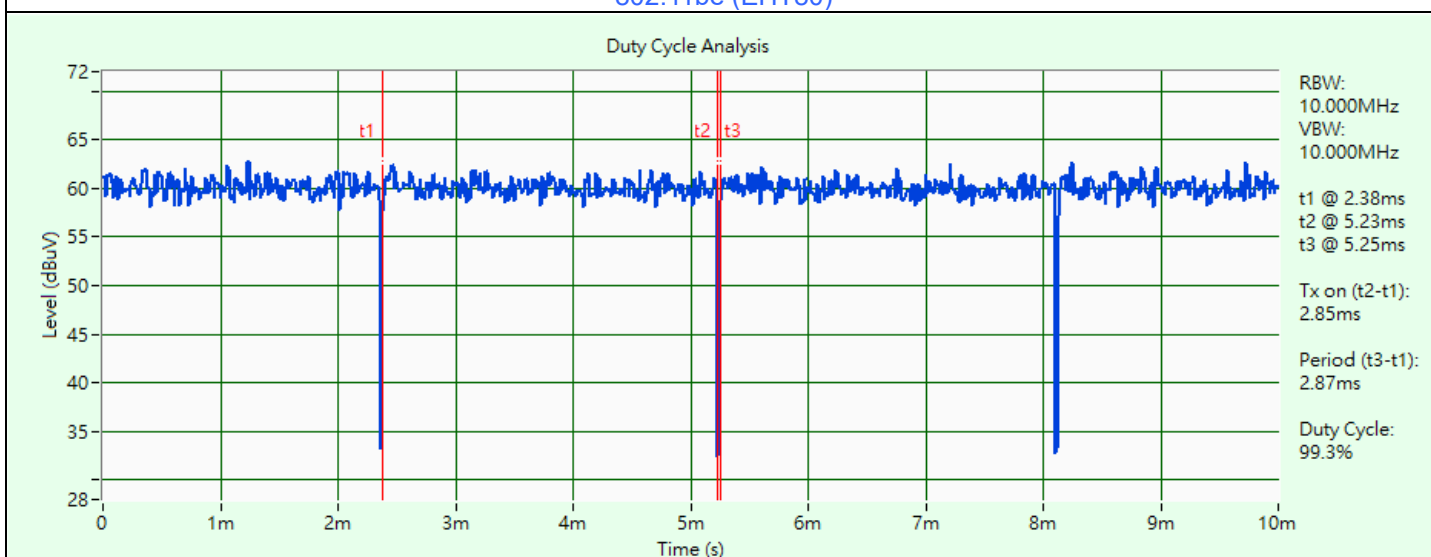

802.11be (EHT160)



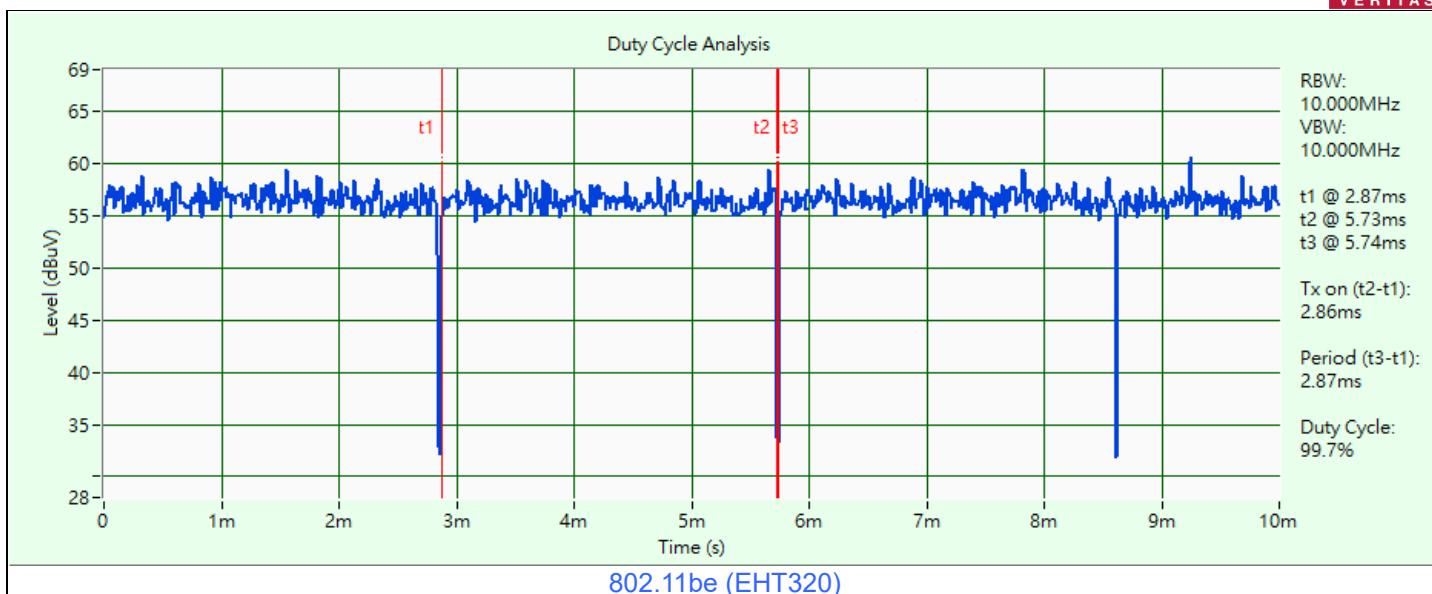

### 3.6 Test Program Used and Operation Descriptions

Controlling software accessMTool\_REL\_3\_3\_0\_6 has been activated to set the EUT under transmission condition continuously at specific channel frequency.

### 3.7 Connection Diagram of EUT and Peripheral Devices

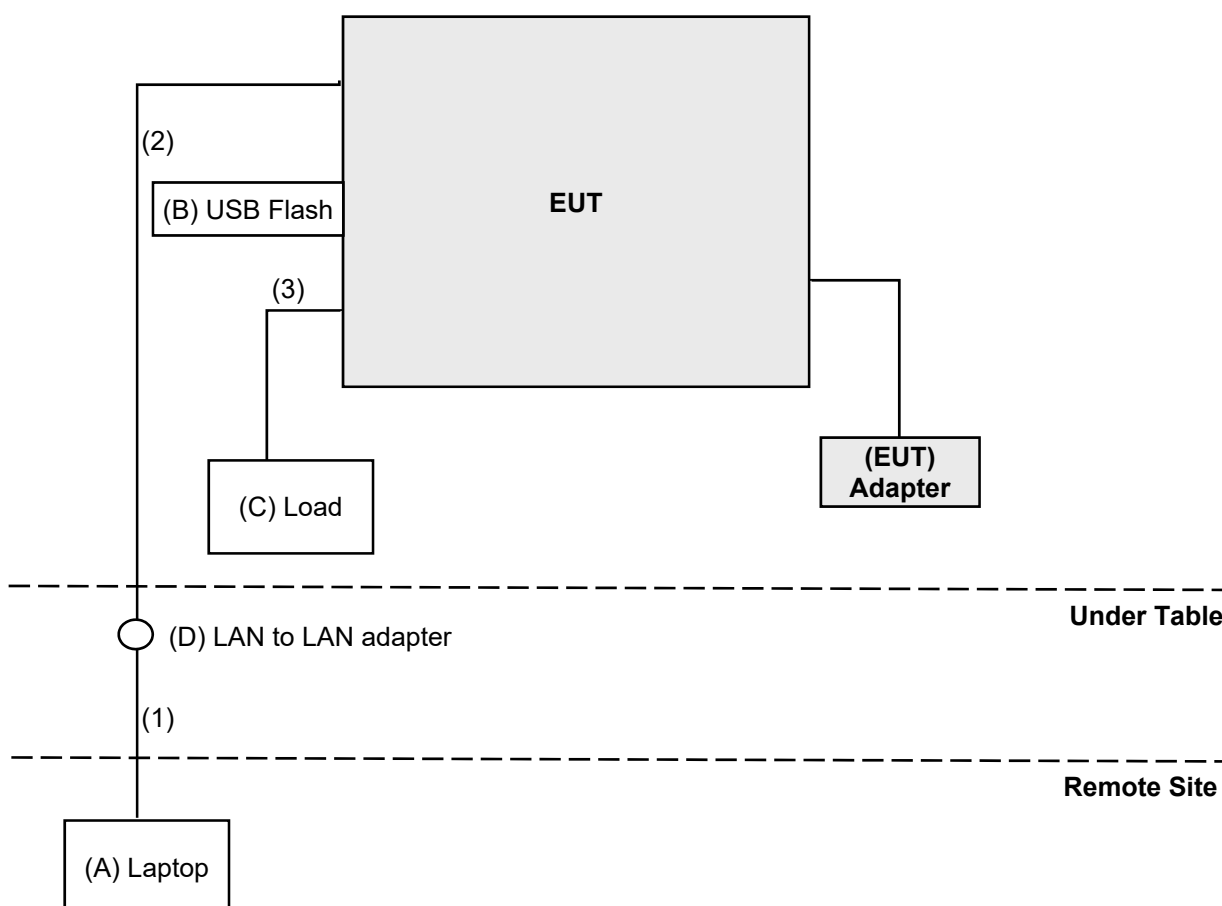

### 3.8 Configuration of Peripheral Devices and Cable Connections

ID	Product	Brand	Model No.	Serial No.	FCC ID	Remarks
A	Laptop	DELL	E5430	2RL3YW1	NA	Provided by Lab
B	USB Flash	SanDisk	NA	NA	NA	Provided by Lab
C	Load	NA	NA	NA	NA	Provided by Lab
D	LAN to LAN adapter	NA	NA	NA	NA	Provided by Lab

ID	Cable Descriptions	Qty.	Length (m)	Shielding (Yes/No)	Cores (Qty.)	Remarks
1	RJ45 Cable	1	10	No	0	Provided by Lab
2	RJ45 Cable	1	1.96	No	0	Accessory of EUT
3	RJ45 Cable	4	1.5	No	0	Provided by Lab

## 4 Test Instruments

The calibration interval of the all test instruments are 12 months and the calibrations are traceable to NML/ROC and NIST/USA.

### 4.1 Maximum RF Output Power

Description Manufacturer	Model No.	Serial No.	Calibrated Date	Calibrated Until
Antenna Tower inn-co GmbH	MA 4000	010303	N/A	N/A
EMI Test Receiver R&S	ESR3	102782	2023/12/7	2024/12/6
Horn Antenna Schwarzbeck	BBHA 9120D	9120D-408	2023/11/12	2024/11/11
Preamplifier Keysight	83017A	MY53270295	2023/5/7	2024/5/6
RF Coaxial Cable HUBER+SUHNER	SUCOFLEX 104	Cable-CH4-03(250724)	2023/5/7	2024/5/6
	Sucoflex 104	MY 13380+295012/04	2023/5/7	2024/5/6
Signal & Spectrum Analyzer R&S	FSW43	101582	2023/4/13	2024/4/12
Software BV ADT	ADT_Radiated_ V7.6.15.9.5	N/A	N/A	N/A
Turn Table BV ADT	TT100	TT93021705	N/A	N/A
Turn Table Controller BV ADT	SC100	SC93021705	N/A	N/A

Notes:

1. The test was performed in HY - 966 chamber 3.
2. Tested Date: 2024/1/27

### 4.2 Maximum Power Spectral Density

Refer to section 4.1 to get information of the instruments.

### 4.3 Emission Bandwidth

Description Manufacturer	Model No.	Serial No.	Calibrated Date	Calibrated Until
Signal & Spectrum Analyzer R&S	FSV3044	101504	2023/6/5	2024/6/4
Software BV	ADT_RF Test Software V7.6.5.4	N/A	N/A	N/A

Notes:

1. The test was performed in Oven room.
2. Tested Date: 2024/1/27

#### 4.4 In-Band Emission Mask

Refer to section 4.3 to get information of the instruments.

#### 4.5 Occupied Bandwidth

Refer to section 4.3 to get information of the instruments.

#### 4.6 Frequency Stability

Description Manufacturer	Model No.	Serial No.	Calibrated Date	Calibrated Until
AC Power Supply JIN YIH Technology	6905S	1720444	N/A	N/A
Digital Multimeter Fluke	87-III	70360742	2023/7/6	2024/7/5
Signal & Spectrum Analyzer R&S	FSV3044	101504	2023/6/5	2024/6/4
Software BV	ADT_RF Test Software V7.6.5.4	N/A	N/A	N/A
Temperature & Humidity Chamber Terchy	HRM-120RF	931022	2023/12/19	2024/12/18

Notes:

1. The test was performed in Oven room.
2. Tested Date: 2024/1/27

#### 4.7 Contention-based Protocol

Description Manufacturer	Model No.	Serial No.	Calibrated Date	Calibrated Until
EXA Signal Analyzer Agilent	N9010A	MY52220207	2023/12/28	2024/12/27
MXG Vector Signal Generator Agilent	N5182B	MY53050430	2023/12/4	2024/12/3
MXG Vector Signal Generator Keysight	N5182BU	MY59360189	2023/12/4	2024/12/3
Power Divider Woken	0120A02058001M	DCMD33WIK3	2023/5/5	2024/5/4
		DCMD33WIK7	2023/5/5	2024/5/4

Notes:

1. The test was performed in Adaptivity room.
2. Tested Date: 2024/1/25

#### 4.8 AC Power Conducted Emissions

Description Manufacturer	Model No.	Serial No.	Calibrated Date	Calibrated Until
50 ohm terminal resistance HUBER+SUHNER	E1-011315	13	2023/11/22	2024/11/21
50 ohm terminal resistance	E1-011279	04	2023/11/22	2024/11/21
	E1-011280	05	2023/11/22	2024/11/21
DC-LISN Schwarzbeck	NNBM 8126G	8126G-069	2023/11/7	2024/11/6
EMI Test Receiver R&S	ESCI	100613	2023/12/4	2024/12/3
Fixed Attenuator Mini-Circuits	HAT-10+	PAD-COND1-01	2024/1/6	2025/1/5
LISN R&S	ENV216	101826	2023/3/23	2024/3/22
	ESH3-Z5	100311	2023/9/6	2024/9/5
RF Coaxial Cable Woken	5D-FB	Cable-cond1-01	2024/1/6	2025/1/5
Software BVADT	BVADT_Cond_ V7.3.7.4	N/A	N/A	N/A
V-LISN Schwarzbeck	NNBL 8226-2	8226-142	2023/8/31	2024/8/30

Notes:

1. The test was performed in HY - Conduction 1.
2. Tested Date: 2024/1/27

#### 4.9 Unwanted Emissions below 1 GHz

Description Manufacturer	Model No.	Serial No.	Calibrated Date	Calibrated Until
Antenna Tower inn-co GmbH	MA 4000	010303	N/A	N/A
Bi_Log Antenna Schwarzbeck	VULB 9168	9168-155	2023/10/13	2024/10/12
EMI Test Receiver R&S	ESR3	102782	2023/12/7	2024/12/6
Loop Antenna Electro-Metrics	EM-6879	269	2023/9/23	2024/9/22
Loop Antenna TESEQ	HLA 6121	45745	2023/8/8	2024/8/7
Preamplifier Agilent	8447D	2944A10631	2023/5/7	2024/5/6
Preamplifier EMCI	EMC001340	980201	2023/9/27	2024/9/26
RF Coaxial Cable Woken	8D-FB	Cable-CH4-01	2023/7/8	2024/7/7
Signal & Spectrum Analyzer R&S	FSW43	101582	2023/4/13	2024/4/12
Software BV ADT	ADT_Radiated_ V7.6.15.9.5	N/A	N/A	N/A
Turn Table BV ADT	TT100	TT93021705	N/A	N/A
Turn Table Controller BV ADT	SC100	SC93021705	N/A	N/A

Notes:

1. The test was performed in HY - 966 chamber 3.
2. Tested Date: 2024/1/26 ~ 2024/1/27

#### 4.10 Unwanted Emissions above 1 GHz

Description Manufacturer	Model No.	Serial No.	Calibrated Date	Calibrated Until
Antenna Tower inn-co GmbH	MA 4000	010303	N/A	N/A
Boresight antenna tower fixture BV	BAF-02	5	N/A	N/A
EMI Test Receiver R&S	ESR3	102782	2023/12/7	2024/12/6
Horn Antenna Schwarzbeck	BBHA 9120D	9120D-408	2023/11/12	2024/11/11
	BBHA 9170	9170-480	2023/11/12	2024/11/11
		BBHA9170241	2023/10/16	2024/10/15
		BBHA9170243	2023/11/12	2024/11/11
Preamplifier EMCI	EMC 184045	980116	2023/9/27	2024/9/26
Preamplifier Keysight	83017A	MY53270295	2023/5/7	2024/5/6
RF Coaxial Cable EMCI	EMC102-KM-KM-600	150928	2023/7/8	2024/7/7
	EMC102-KM-KM-3000	150929	2023/7/8	2024/7/7
RF Coaxial Cable HUBER+SUHNER	SUCOFLEX 104	Cable-CH4-03(250724)	2023/5/7	2024/5/6
	Sucoflex 104	MY 13380+295012/04	2023/5/7	2024/5/6
Signal & Spectrum Analyzer R&S	FSW43	101582	2023/4/13	2024/4/12
Software BV ADT	ADT_Radiated_ V7.6.15.9.5	N/A	N/A	N/A
Turn Table BV ADT	TT100	TT93021705	N/A	N/A
Turn Table Controller BV ADT	SC100	SC93021705	N/A	N/A

Notes:

1. The test was performed in HY - 966 chamber 3.
2. Tested Date: 2024/1/16 ~ 2024/1/25

## 5 Limits of Test Items

### 5.1 Maximum RF Output Power

Operation Band	Equipment Class	Limit
		Maximum Average Power
U-NII-5 U-NII-6 U-NII-7 U-NII-8	6ID: 15E 6 GHz Low-power indoor access point	EIRP 30 dBm

### 5.2 Maximum Power Spectral Density

Operation Band	Equipment Class	Limit
		Maximum Power Density
U-NII-5 U-NII-6 U-NII-7 U-NII-8	6ID: 15E 6 GHz Low-power indoor access point	EIRP 5 dBm/MHz

### 5.3 Emission Bandwidth

The maximum transmitter channel bandwidth for U-NII devices in the 5.925-7.125 GHz band is 320 MHz.

### 5.4 In-Band Emission Mask

Test Item	Frequencies (MHz)	(X) dBc*1
Emission Mask	At 1 MHz outside of channel edge	20
	At one channel bandwidth from the channel center*2	28
	At one- and one-half times the channel bandwidth away from channel center*3	40
	More than one- and one-half times the channel bandwidth	40

\*1 : The power spectral density must be suppressed by "x" dB

\*2 : At frequencies between one megahertz outside an unlicensed device's channel edge and one channel bandwidth from the center of the channel, the limits must be linearly interpolated between 20 dB and 28 dB suppression,

\*3 : At frequencies between one and one- and one-half times an unlicensed device's channel bandwidth, the limits must be linearly interpolated between 28 dB and 40 dB suppression.

### 5.5 Occupied Bandwidth

The maximum transmitter channel bandwidth for U-NII devices in the 5.925-7.125 GHz band is 320 MHz.

### 5.6 Frequency Stability

The frequency of the carrier signal shall be maintained within band of operation.



## 5.7 Contention-based Protocol

Unlicensed indoor low-power devices must detect co-channel radio frequency power that is at least -62 dBm (The threshold is referenced to a 0 dBi antenna gain.) or lower. Additionally, indoor low-power devices must detect co-channel energy with 90% or greater certainty.

## 5.8 AC Power Conducted Emissions

Frequency (MHz)	Conducted Limit (dBuV)	
	Quasi-peak	Average
0.15 - 0.5	66 - 56	56 - 46
0.50 - 5.0	56	46
5.0 - 30.0	60	50

Notes:

1. The lower limit shall apply at the transition frequencies.
2. The limit decreases in line with the logarithm of the frequency in the range of 0.15 to 0.50 MHz.

## 5.9 Unwanted Emissions below 1 GHz

Radiated emissions which fall in the restricted bands must comply with the radiated emission limits specified as below table.

Frequencies (MHz)	Field Strength (microvolts/meter)	Measurement Distance (meters)
0.009 ~ 0.490	2400/F(kHz)	300
0.490 ~ 1.705	24000/F(kHz)	30
1.705 ~ 30.0	30	30
30 ~ 88	100	3
88 ~ 216	150	3
216 ~ 960	200	3
Above 960	500	3

Notes:

1. The lower limit shall apply at the transition frequencies.
2. Emission level (dBuV/m) = 20 log Emission level (uV/m).

## 5.10 Unwanted Emissions above 1 GHz

Radiated emissions which fall in the restricted bands must comply with the radiated emission limits specified as below table.

Frequencies (MHz)	Field Strength (microvolts/meter)	Measurement Distance (meters)
Above 960	500	3

Notes:

1. The lower limit shall apply at the transition frequencies.
2. Emission level (dBuV/m) = 20 log Emission level (uV/m).
3. For frequencies above 1000 MHz, the field strength limits are based on average detector, however, the peak field strength of any emission shall not exceed the maximum permitted average limits, specified above by more than 20 dB under any condition of modulation.

Limits of unwanted emission out of the restricted bands

Frequencies (MHz)	EIRP Limit	Equivalent Field Strength at 3 m
5925 MHz > F > 7125 MHz	Peak: -7 (dBm/MHz)	88.2 (dBuV/m)
	Average: -27 (dBm/MHz)	68.2 (dBuV/m)

Note: The following formula is used to convert the equipment isotropic radiated power (eirp) to field strength:

$$E = \frac{1000000 \sqrt{30P}}{3} \mu\text{V/m, where } P \text{ is the eirp (Watts).}$$

## 6 Test Arrangements

### 6.1 Maximum RF Output Power

#### 6.1.1 Test Setup

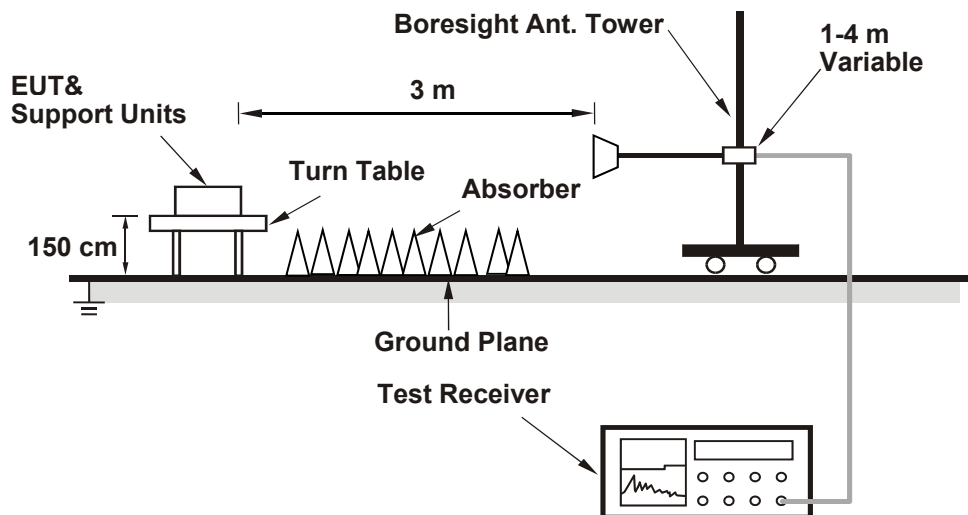

#### 6.1.2 Test Procedure

- The EUT was placed on the top of a rotating table 1.5 meters above the ground at 3 meter chamber room for test. The table was rotated 360 degrees to determine the position of the highest radiation.
- The EUT was set 3 meters away from the interference-receiving antenna, which was mounted on the top of a variable-height antenna tower.
- The height of antenna is varied from one meter to four meters above the ground to determine the maximum value of the field strength. Both horizontal and vertical polarizations of the antenna are set to make the measurement.
- Perform a field strength measurement and record the worse read value, is the field strength value via a spectrum reading obtained corrected for antenna factor, cable loss and pre-amplifier factor and then mathematically convert the measured field strength level to EIRP level.
- Follow ANSI C63.10 section 12.7.3,  $EIRP \text{ Value (dBm)} = \text{Field Strength Value (dBuV / m)} + \text{Correction Factor @ 3 m}$ .
- $\text{Correction Factor (dB) @ 3 m} = 20\log(D) - 104.77 = -95.23 \text{ dB}$ ; where D is the measurement distance @3 m.

Spectrum analyzer setting as below:

Method SA-1

- Set span to encompass the entire emission bandwidth (EBW) of the signal.
- Set RBW = 1 MHz, Set VBW  $\geq$  3 MHz, Detector = RMS
- Sweep points  $\geq [2 \times \text{span} / \text{RBW}]$ . (This gives bin-to-bin spacing  $\leq \text{RBW} / 2$ , so that narrowband signals are not lost between frequency bins.)
- Sweep time = auto, trigger set to "free run".
- Trace average at least 100 traces in power averaging mode.
- Record the max value

Note: When measuring power, use compute power by integrating the spectrum across the 26 dB EBW or 99% OBW of the signal using the instrument's band power measurement function, with band limits set equal to the EBW or OBW band edges. If the instrument does not have a band power function, then sum the spectrum levels (in power units) at 1 MHz intervals extending across the 26 dB EBW or 99% OBW of the spectrum.

## 6.2 Maximum Power Spectral Density

### 6.2.1 Test Setup

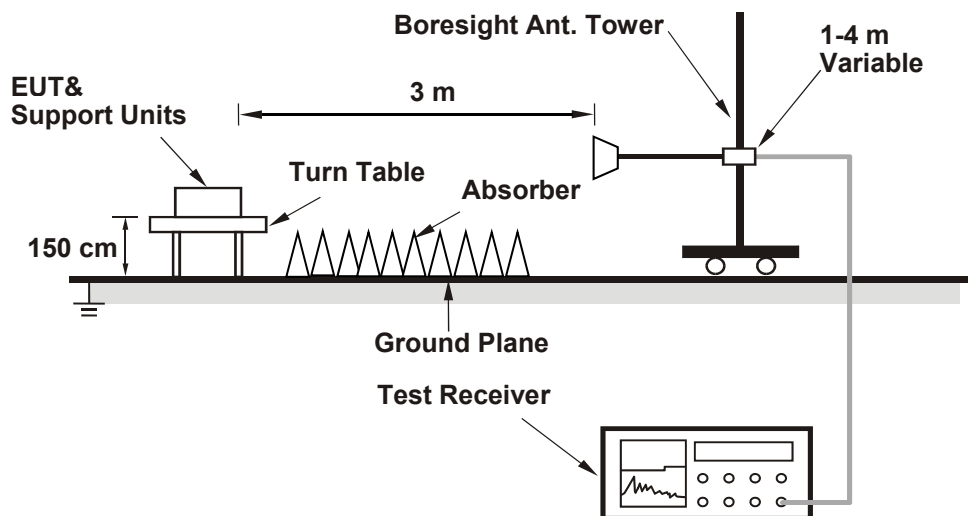

### 6.2.2 Test Procedure

- The EUT was placed on the top of a rotating table 1.5 meters above the ground at 3 meter chamber room for test. The table was rotated 360 degrees to determine the position of the highest radiation.
- The EUT was set 3 meters away from the interference-receiving antenna, which was mounted on the top of a variable-height antenna tower.
- The height of antenna is varied from one meter to four meters above the ground to determine the maximum value of the field strength. Both horizontal and vertical polarizations of the antenna are set to make the measurement.
- Perform a field strength measurement and record the worse read value, is the field strength value via a spectrum reading obtained corrected for antenna factor, cable loss and pre-amplifier factor and then mathematically convert the measured field strength level to EIRP level.
- Follow ANSI C63.10 section 12.7.3,  $EIRP \text{ Value (dBm)} = \text{Field Strength Value (dBuV/m)} + \text{Correction Factor @ 3 m}$ .
- $\text{Correction Factor (dB) @ 3 m} = 20\log(D) - 104.77$ ; where D is the measurement distance @3 m = -95.23 dB

Spectrum analyzer setting as below:

#### Method SA-1

- Set span to encompass the entire emission bandwidth (EBW) of the signal.
- Set RBW = 1 MHz, Set VBW  $\geq$  3 MHz, Detector = RMS
- Sweep points  $\geq [2 \times \text{span} / \text{RBW}]$ . (This gives bin-to-bin spacing  $\leq \text{RBW} / 2$ , so that narrowband signals are not lost between frequency bins.)
- Sweep time = auto, trigger set to "free run".
- Trace average at least 100 traces in power averaging mode.
- Record the max value

## 6.3 Emission Bandwidth

### 6.3.1 Test Setup

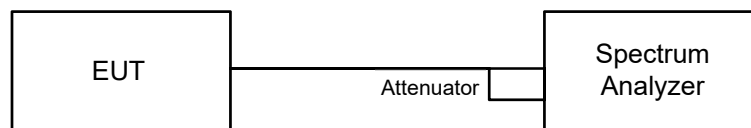

### 6.3.2 Test Procedure

- Set RBW = approximately 1% of the emission bandwidth.
- Set the VBW > RBW.
- Detector = Peak.
- Trace mode = max hold.
- Measure the maximum width of the emission that is 26 dB down from the peak of the emission. Compare this with the RBW setting of the analyzer. Readjust RBW and repeat measurement as needed until the RBW/EBW ratio is approximately 1%.

## 6.4 In-Band Emission Mask

### 6.4.1 Test Setup

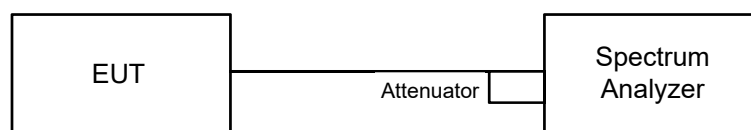

### 6.4.2 Test Procedure

- Connect output of the antenna port to a spectrum analyzer and adjust appropriate attenuation.
- Measure the 26 dB EBW using the test procedure 12.4.1 of ANSI C63.10-2013. (Determine the channel edge.)
- Measure the power spectral density (for emissions mask reference) using the following procedure:
  - Set the span to encompass the entire 26 dB EBW of the signal.
  - Set RBW = same RBW used for 26 dB EBW measurement.
  - Set VBW  $\geq$  [3 X RBW].
  - Number of points in sweep  $\geq$  [2 X span / RBW].
  - Sweep time = auto.
  - Detector = RMS (i.e., power averaging).
  - Trace average at least 100 traces in power averaging (rms) mode.
  - Use the peak search function on the instrument to find the peak of the spectrum.
- Using the measuring equipment limit line function, develop the emissions mask based on the following requirements. The emissions power spectral density must be reduced below the peak power spectral density (in dB) as follows:
  - Suppressed by 20 dB at 1 MHz outside of the channel edge. (The channel edge is defined as the 26-dB point on either side of the carrier center frequency.)
  - Suppressed by 28 dB at one channel bandwidth from the channel center.
  - Suppressed by 40 dB at one- and one-half times the channel bandwidth from the channel center.
- Adjust the span to encompass the entire mask as necessary and clear trace.
- Trace average at least 100 traces in power averaging (rms) mode.
- Adjust the reference level as necessary so that the crest of the channel touches the top of the emission mask

## 6.5 Occupied Bandwidth

### 6.5.1 Test Setup

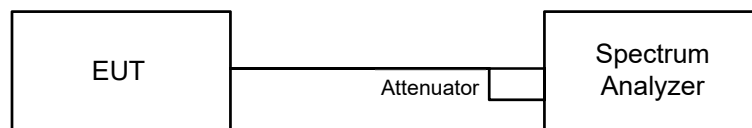

### 6.5.2 Test Procedure

The transmitter output was connected to the spectrum analyzer through an attenuator. The bandwidth of the fundamental frequency was measured by spectrum analyzer with resolution bandwidth in the range of 1% to 5% of the anticipated emission bandwidth, and a video bandwidth at least 3x the resolution bandwidth and set the detector to Sampling. The width of a frequency band such that, below the lower and above the upper frequency limits, the mean powers emitted are each equal to a specified percentage 0.5% of the total mean power of a given emission.

## 6.6 Frequency Stability

### 6.6.1 Test Setup

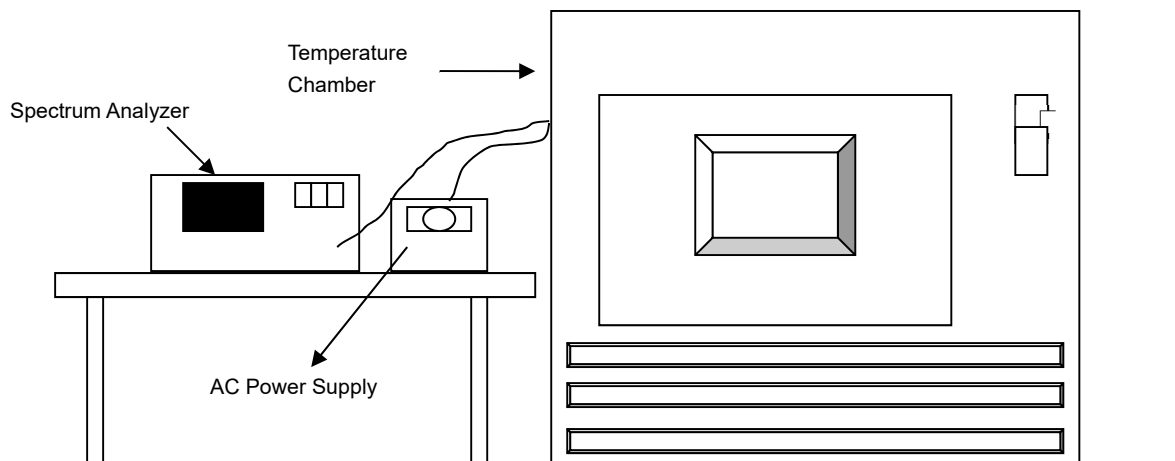

### 6.6.2 Test Procedure

- The EUT was placed inside the environmental test chamber and powered by nominal AC voltage.
- Turn the EUT on and couple its output to a spectrum analyzer.
- Turn the EUT off and set the chamber to the highest temperature specified.
- Allow sufficient time (approximately 30 min) for the temperature of the chamber to stabilize, turn the EUT on and measure the operating frequency after 2, 5, and 10 Minutes.
- Repeat step (d) with the temperature chamber set to the next desired temperature until measurements down to the lowest specified temperature have been completed.
- The test chamber was allowed to stabilize at +20 degree C for a minimum of 30 Minutes. The supply voltage was then adjusted on the EUT from 85% to 115% and the frequency record.

## 6.7 Contention-based Protocol

### 6.7.1 Test Setup

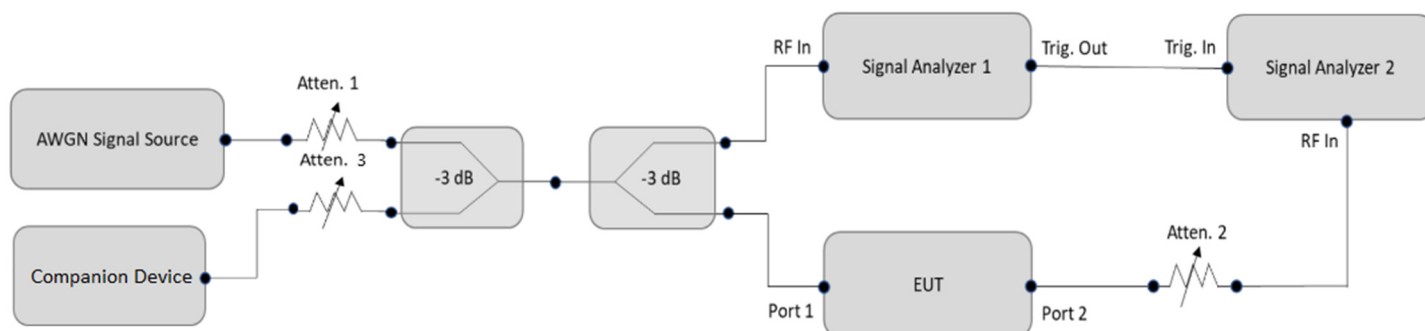

### 6.7.2 Test Procedure

- Set the signal analyzer center frequency to the nominal EUT channel center frequency. The span range of the signal analyzer shall be between two times and five times the OBW of the EUT. Connect the output port of the EUT to the signal analyzer 2. Ensure that the attenuator 2 provides enough attenuation to not overload the signal analyzer 2 receiver.
- Monitoring the signal analyzer 2, verify the EUT is operating and transmitting with the parameters (set as following section 4.7.5 EUT operating condition).
- Determine number of times detection threshold test as following table,

If	Number of Tests	Placement of Incumbent Transmission
$BW_{EUT} \leq BW_{Inc}$	Once	Same as EUT transmission
$BW_{Inc} < BW_{EUT} \leq 2x BW_{Inc}$	Once	Contained within $BW_{EUT}$
$2x BW_{Inc} < BW_{EUT} \leq 4x BW_{Inc}$	Twice. (Incumbent transmission is contained within $BW_{EUT}$ )	Closely to the lower edge and upper edge of the EUT Channel
$BW_{EUT} > 4x BW_{Inc}$	Three times	Closely to the lower edge, in the middle and upper edge of the EUT Channel

- Using an AWGN signal source, generate (but do not transmit, i.e., RF OFF) a 10 MHz-wide AWGN signal. Use step c table to determine the center frequency of the 10 MHz AWGN signal relative to the EUT's channel bandwidth and center frequency.
- Set the AWGN signal power to an extremely low level (more than 20 dB below the -62 dBm threshold). Connect the AWGN signal source, via a 3-dB splitter, to the signal analyzer 1 and the EUT.
- Transmit the AWGN signal (RF ON) and verify its characteristics on the signal analyzer 1.
- Monitor the signal analyzer 2 to verify if the AWGN signal has been detected and the EUT has ceased transmission. If the EUT continues to transmit, then incrementally increase the AWGN signal power level until the EUT stops transmitting.
- (Including all losses in the RF paths) Determine and record the AWGN signal power level (at the EUT's antenna port) at which the EUT ceased transmission. Repeat the procedure at least 10 times to verify the EUT can detect an AWGN signal with 90% (or better) level of certainty.
- Refer to step c table to determine number of times the detection threshold testing needs to be repeated. If testing is required more than once, then go back to step d, choose a different center frequency for the AWGN signal and repeat the process.

## 6.8 AC Power Conducted Emissions

### 6.8.1 Test Setup

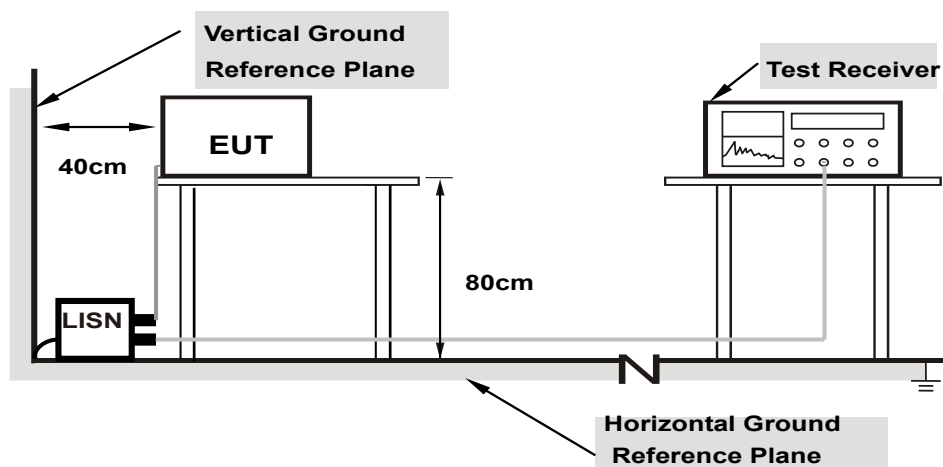

**Note: 1.Support units were connected to second LISN.**

For the actual test configuration, please refer to the attached file (Test Setup Photo).

### 6.8.2 Test Procedure

- The EUT was placed on a 0.8 meter to the top of table and placed 0.4 meters from the conducting wall of the shielded room with EUT being connected to the power mains through a line impedance stabilization network (LISN). Other support units were connected to the power mains through another LISN. The two LISNs provide 50 ohm/ 50 uH of coupling impedance for the measuring instrument.
- Both lines of the power mains connected to the EUT were checked for maximum conducted interference.
- The frequency range from 150 kHz to 30 MHz was searched. Emission levels under (Limit – 20 dB) was not recorded.

Note: The resolution bandwidth and video bandwidth of test receiver is 9 kHz for quasi-peak detection (QP) and average detection (AV) at frequency 0.15 MHz-30 MHz.



## 6.9 Unwanted Emissions below 1 GHz

### 6.9.1 Test Setup

#### For Radiated emission below 30 MHz

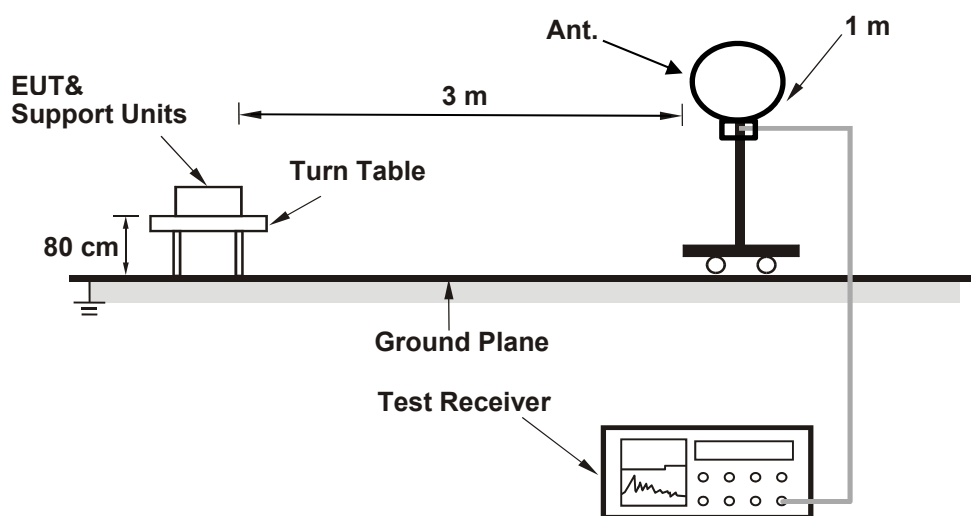

#### For Radiated emission above 30 MHz

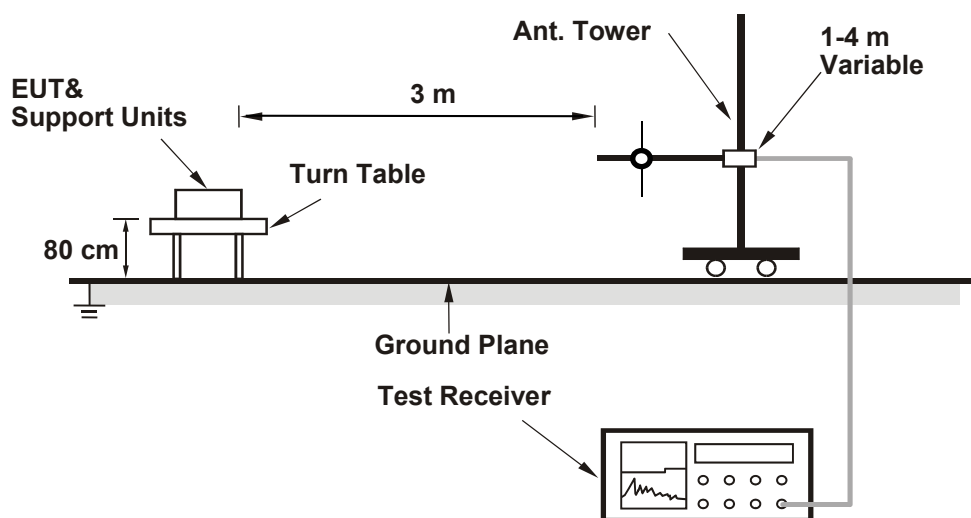

For the actual test configuration, please refer to the attached file (Test Setup Photo).

## 6.9.2 Test Procedure

### For Radiated emission below 30 MHz

- a. The EUT was placed on the top of a rotating table 0.8 meters above the ground at 3 meter chamber room for test. The table was rotated 360 degrees to determine the position of the highest radiation.
- b. The EUT was set 3 meters away from the interference-receiving antenna, which was mounted on the top of a variable-height antenna tower.
- c. Parallel, perpendicular, and ground-parallel orientations of the antenna are set to make the measurement.
- d. For each suspected emission, the EUT was arranged to its worst case and the rotatable table was turned from 0 degrees to 360 degrees to find the maximum reading.
- e. The test-receiver system was set to Quasi-Peak Detect Function and Specified Bandwidth with Maximum Hold Mode, except for the frequency band (9 kHz to 90 kHz and 110 kHz to 490 kHz) set to average detect function and peak detect function.

#### Notes:

1. The resolution bandwidth and video bandwidth of test receiver/spectrum analyzer is 200 Hz at frequency below 150 kHz.
2. The resolution bandwidth and video bandwidth of test receiver/spectrum analyzer is 9 kHz or 10 kHz at frequency (150 kHz to 30 MHz).
3. All modes of operation were investigated and the worst-case emissions are reported.

### For Radiated emission above 30 MHz

- a. The EUT was placed on the top of a rotating table 0.8 meters above the ground at 3 meter chamber room for test. The table was rotated 360 degrees to determine the position of the highest radiation.
- b. The EUT was set 3 meters away from the interference-receiving antenna, which was mounted on the top of a variable-height antenna tower.
- c. The height of antenna is varied from one meter to four meters above the ground to determine the maximum value of the field strength. Both horizontal and vertical polarizations of the antenna are set to make the measurement.
- d. For each suspected emission, the EUT was arranged to its worst case and then the antenna was tuned to heights from 1 meter to 4 meters and the rotatable table was turned from 0 degrees to 360 degrees to find the maximum reading.
- e. The test-receiver system was set to quasi-peak detect function and specified bandwidth with maximum hold mode when the test frequency is below 1 GHz.

#### Notes:

1. The resolution bandwidth and video bandwidth of test receiver/spectrum analyzer is 120 kHz for Quasi-peak detection (QP) at frequency below 1 GHz.
2. All modes of operation were investigated and the worst-case emissions are reported.

## 6.10 Unwanted Emissions above 1 GHz

### 6.10.1 Test Setup

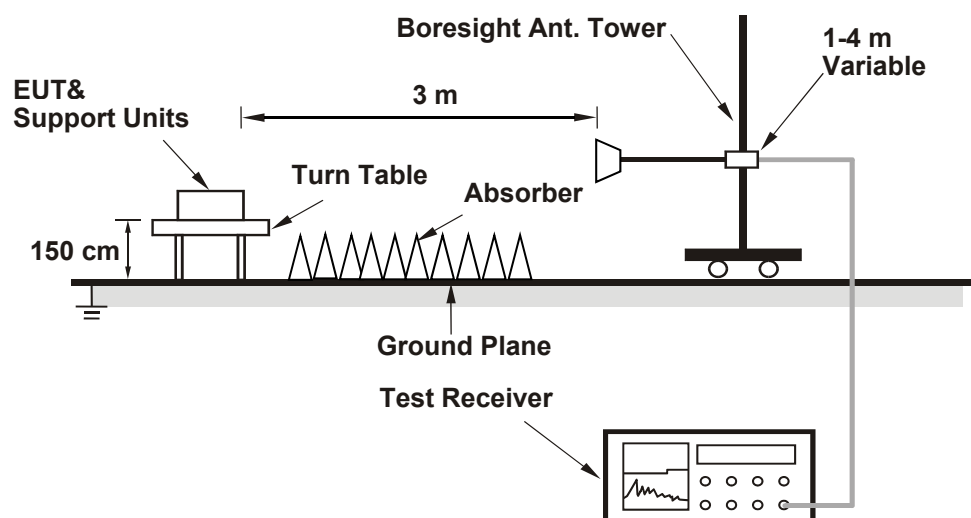

For the actual test configuration, please refer to the attached file (Test Setup Photo).

### 6.10.2 Test Procedure

- The EUT was placed on the top of a rotating table 1.5 meters above the ground at 3 meter chamber room for test. The table was rotated 360 degrees to determine the position of the highest radiation.
- The EUT was set 3 meters away from the interference-receiving antenna, which was mounted on the top of a variable-height antenna tower.
- The height of antenna is varied from one meter to four meters above the ground to determine the maximum value of the field strength. Both horizontal and vertical polarizations of the antenna are set to make the measurement.
- For each suspected emission, the EUT was arranged to its worst case and then the antenna was tuned to heights from 1 meter to 4 meters and the rotatable table was turned from 0 degrees to 360 degrees to find the maximum reading.
- The test-receiver system was set to peak and average detects function and specified bandwidth with maximum hold mode when the test frequency is above 1 GHz. If the peak reading value also meets average limit, measurement with the average detector is unnecessary.

#### Notes:

- The resolution bandwidth of test receiver/spectrum analyzer is 1 MHz and the video bandwidth is 3 MHz for Peak detection (PK) and Average detection (AV) at frequency above 1 GHz.
- For fundamental and harmonic signal measurement, the resolution bandwidth of test receiver/spectrum analyzer is 1 MHz and the video bandwidth is  $\geq 1/T$  (Duty cycle  $< 98\%$ ) or 10 Hz (Duty cycle  $\geq 98\%$ ) for Average detection (AV) at frequency above 1 GHz.
- All modes of operation were investigated and the worst-case emissions are reported.

## 7 Test Results of Test Item

### 7.1 Maximum RF Output Power

Input Power:	120 Vac, 60 Hz	Environmental Conditions:	25°C, 60% RH	Tested By:	Jisyoung Wang
--------------	----------------	---------------------------	--------------	------------	---------------

#### NSS1

#### 802.11a CDD

Chan.	Chan. Freq. (MHz)	Field Strength (dBuV/m)	Correction Factor (dB)	EIRP (mW)	EIRP (dBm)	EIRP Limit (dBm)	Test Result
33	6115	111.49	-95.23	42.267	16.26	30	Pass
61	6255	111.46	-95.23	41.976	16.23	30	Pass
93	6415	111.50	-95.23	42.364	16.27	30	Pass
97	6435	111.45	-95.23	41.879	16.22	30	Pass
105	6475	111.48	-95.23	42.17	16.25	30	Pass
113	6515	111.61	-95.23	43.451	16.38	30	Pass
117	6535	111.51	-95.23	42.462	16.28	30	Pass
149	6695	111.52	-95.23	42.56	16.29	30	Pass
181	6855	111.59	-95.23	43.251	16.36	30	Pass
185	6875	111.46	-95.23	41.976	16.23	30	Pass
209	6995	111.48	-95.23	42.17	16.25	30	Pass
229	7095	111.49	-95.23	42.267	16.26	30	Pass
233	7115	111.60	-95.23	43.351	16.37	30	Pass

#### 802.11be (EHT20) Beamforming

Chan.	Chan. Freq. (MHz)	Field Strength (dBuV/m)	Correction Factor (dB)	EIRP (mW)	EIRP (dBm)	EIRP Limit (dBm)	Test Result
33	6115	113.61	-95.23	68.865	18.38	30	Pass
61	6255	113.40	-95.23	65.615	18.17	30	Pass
93	6415	113.66	-95.23	69.663	18.43	30	Pass
97	6435	113.74	-95.23	70.958	18.51	30	Pass
105	6475	113.53	-95.23	67.608	18.30	30	Pass
113	6515	113.52	-95.23	67.453	18.29	30	Pass
117	6535	113.52	-95.23	67.453	18.29	30	Pass
149	6695	113.57	-95.23	68.234	18.34	30	Pass
181	6855	113.54	-95.23	67.764	18.31	30	Pass
185	6875	113.60	-95.23	68.707	18.37	30	Pass
209	6995	113.46	-95.23	66.527	18.23	30	Pass
229	7095	113.47	-95.23	66.681	18.24	30	Pass
233	7115	93.38	-95.23	0.6531	-1.85	30	Pass

### 802.11be (EHT40) Beamforming

Chan.	Chan. Freq. (MHz)	Field Strength (dBuV/m)	Correction Factor (dB)	EIRP (mW)	EIRP (dBm)	EIRP Limit (dBm)	Test Result
35	6125	115.78	-95.23	113.501	20.55	30	Pass
59	6245	115.94	-95.23	117.761	20.71	30	Pass
91	6405	115.68	-95.23	110.917	20.45	30	Pass
99	6445	115.76	-95.23	112.98	20.53	30	Pass
107	6485	115.78	-95.23	113.501	20.55	30	Pass
115	6525	115.80	-95.23	114.025	20.57	30	Pass
123	6565	115.69	-95.23	111.173	20.46	30	Pass
155	6725	115.77	-95.23	113.24	20.54	30	Pass
179	6845	115.83	-95.23	114.815	20.60	30	Pass
187	6885	115.81	-95.23	114.288	20.58	30	Pass
211	7005	115.76	-95.23	112.98	20.53	30	Pass
227	7085	115.92	-95.23	117.22	20.69	30	Pass

### 802.11be (EHT80) Beamforming

Chan.	Chan. Freq. (MHz)	Field Strength (dBuV/m)	Correction Factor (dB)	EIRP (mW)	EIRP (dBm)	EIRP Limit (dBm)	Test Result
39	6145	118.80	-95.23	227.51	23.57	30	Pass
55	6225	118.97	-95.23	236.592	23.74	30	Pass
87	6385	119.02	-95.23	239.332	23.79	30	Pass
103	6465	119.06	-95.23	241.546	23.83	30	Pass
119	6545	118.98	-95.23	237.137	23.75	30	Pass
135	6625	119.09	-95.23	243.22	23.86	30	Pass
151	6705	118.80	-95.23	227.51	23.57	30	Pass
167	6785	119.11	-95.23	244.343	23.88	30	Pass
183	6865	118.91	-95.23	233.346	23.68	30	Pass
199	6945	118.97	-95.23	236.592	23.74	30	Pass
215	7025	119.05	-95.23	240.991	23.82	30	Pass

### 802.11be (EHT160) Beamforming

Chan.	Chan. Freq. (MHz)	Field Strength (dBuV/m)	Correction Factor (dB)	EIRP (mW)	EIRP (dBm)	EIRP Limit (dBm)	Test Result
47	6185	121.99	-95.23	474.242	26.76	30	Pass
79	6345	121.97	-95.23	472.063	26.74	30	Pass
111	6505	122.00	-95.23	475.335	26.77	30	Pass
143	6665	121.97	-95.23	472.063	26.74	30	Pass
175	6825	121.98	-95.23	473.151	26.75	30	Pass
207	6985	121.93	-95.23	467.735	26.70	30	Pass

### 802.11be (EHT320) Beamforming

Chan.	Chan. Freq. (MHz)	Field Strength (dBuV/m)	Correction Factor (dB)	EIRP (mW)	EIRP (dBm)	EIRP Limit (dBm)	Test Result
63	6265	124.92	-95.23	931.108	29.69	30	Pass
95	6425	124.81	-95.23	907.821	29.58	30	Pass
127	6585	124.78	-95.23	901.571	29.55	30	Pass
159	6745	124.77	-95.23	899.498	29.54	30	Pass
191	6905	122.66	-95.23	553.35	27.43	30	Pass



### Spectrum Plot of Worst Value

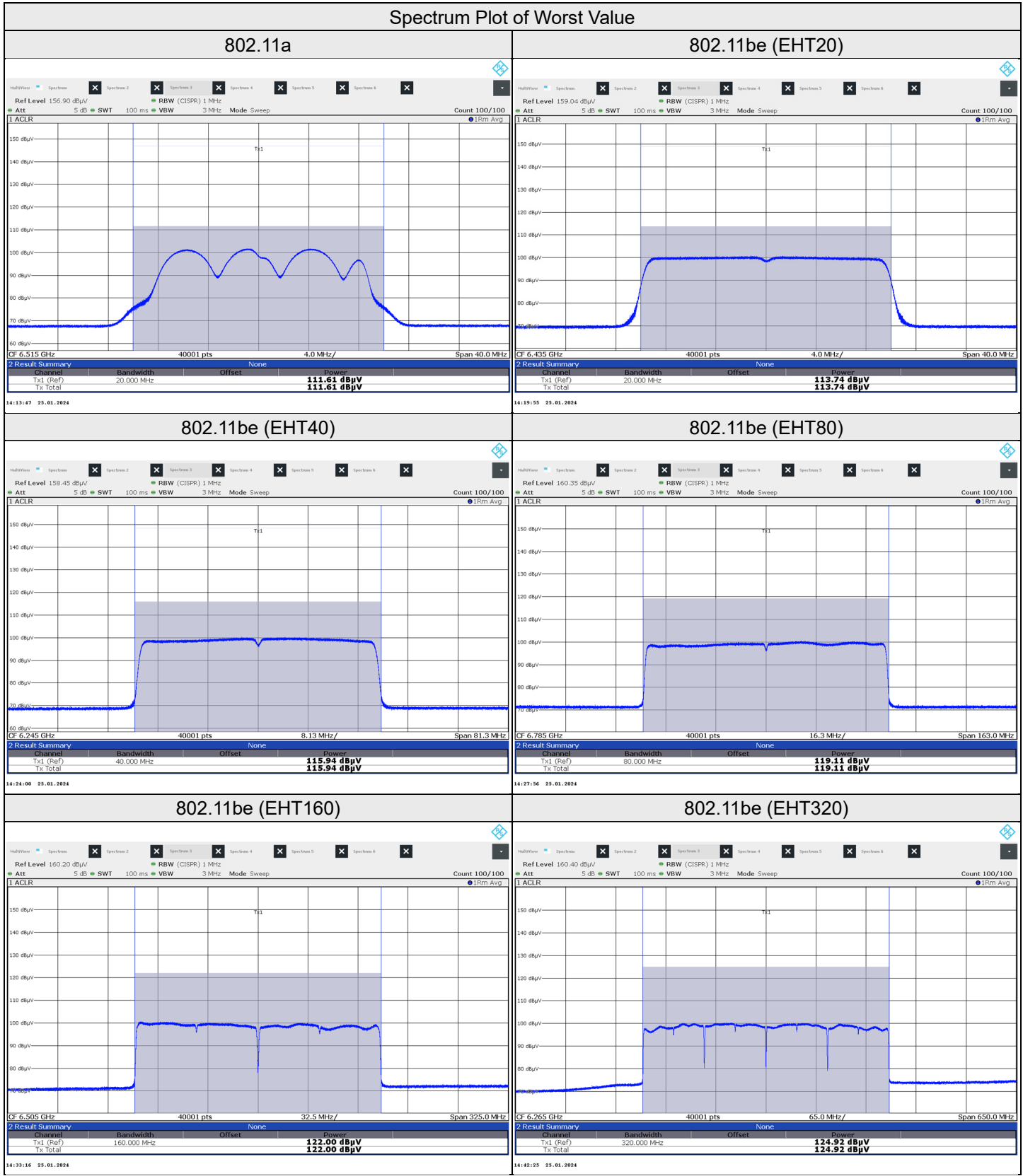

Input Power:	120 Vac, 60 Hz	Environmental Conditions:	25°C, 60% RH	Tested By:	Jisyong Wang
--------------	----------------	---------------------------	--------------	------------	--------------

## NSS2

### 802.11be (EHT20) Beamforming

Chan.	Chan. Freq. (MHz)	Field Strength (dBuV/m)	Correction Factor (dB)	EIRP (mW)	EIRP (dBm)	EIRP Limit (dBm)	Test Result
33	6115	113.62	-95.23	69.024	18.39	30	Pass
61	6255	113.42	-95.23	65.917	18.19	30	Pass
93	6415	113.70	-95.23	70.307	18.47	30	Pass
97	6435	113.74	-95.23	70.958	18.51	30	Pass
105	6475	113.60	-95.23	68.707	18.37	30	Pass
113	6515	113.56	-95.23	68.077	18.33	30	Pass
117	6535	113.56	-95.23	68.077	18.33	30	Pass
149	6695	113.65	-95.23	69.502	18.42	30	Pass
181	6855	113.63	-95.23	69.183	18.40	30	Pass
185	6875	113.66	-95.23	69.663	18.43	30	Pass
209	6995	113.52	-95.23	67.453	18.29	30	Pass
229	7095	113.51	-95.23	67.298	18.28	30	Pass
233	7115	95.25	-95.23	1.005	0.02	30	Pass

### 802.11be (EHT40) Beamforming

Chan.	Chan. Freq. (MHz)	Field Strength (dBuV/m)	Correction Factor (dB)	EIRP (mW)	EIRP (dBm)	EIRP Limit (dBm)	Test Result
35	6125	115.81	-95.23	114.288	20.58	30	Pass
59	6245	115.98	-95.23	118.85	20.75	30	Pass
91	6405	115.75	-95.23	112.72	20.52	30	Pass
99	6445	115.78	-95.23	113.501	20.55	30	Pass
107	6485	115.83	-95.23	114.815	20.60	30	Pass
115	6525	115.82	-95.23	114.551	20.59	30	Pass
123	6565	115.71	-95.23	111.686	20.48	30	Pass
155	6725	115.80	-95.23	114.025	20.57	30	Pass
179	6845	115.85	-95.23	115.345	20.62	30	Pass
187	6885	115.82	-95.23	114.551	20.59	30	Pass
211	7005	115.80	-95.23	114.025	20.57	30	Pass
227	7085	115.98	-95.23	118.85	20.75	30	Pass



### 802.11be (EHT80) Beamforming

Chan.	Chan. Freq. (MHz)	Field Strength (dBuV/m)	Correction Factor (dB)	EIRP (mW)	EIRP (dBm)	EIRP Limit (dBm)	Test Result
39	6145	118.87	-95.23	231.206	23.64	30	Pass
55	6225	119.01	-95.23	238.781	23.78	30	Pass
87	6385	119.08	-95.23	242.661	23.85	30	Pass
103	6465	119.10	-95.23	243.781	23.87	30	Pass
119	6545	119.00	-95.23	238.232	23.77	30	Pass
135	6625	119.14	-95.23	246.037	23.91	30	Pass
151	6705	118.87	-95.23	231.206	23.64	30	Pass
167	6785	119.12	-95.23	244.906	23.89	30	Pass
183	6865	118.98	-95.23	237.137	23.75	30	Pass
199	6945	119.06	-95.23	241.546	23.83	30	Pass
215	7025	119.08	-95.23	242.661	23.85	30	Pass

### 802.11be (EHT160) Beamforming

Chan.	Chan. Freq. (MHz)	Field Strength (dBuV/m)	Correction Factor (dB)	EIRP (mW)	EIRP (dBm)	EIRP Limit (dBm)	Test Result
47	6185	122.09	-95.23	485.289	26.86	30	Pass
79	6345	121.99	-95.23	474.242	26.76	30	Pass
111	6505	122.08	-95.23	484.172	26.85	30	Pass
143	6665	122.03	-95.23	478.63	26.80	30	Pass
175	6825	122.00	-95.23	475.335	26.77	30	Pass
207	6985	121.97	-95.23	472.063	26.74	30	Pass

### 802.11be (EHT320) Beamforming

Chan.	Chan. Freq. (MHz)	Field Strength (dBuV/m)	Correction Factor (dB)	EIRP (mW)	EIRP (dBm)	EIRP Limit (dBm)	Test Result
63	6265	124.93	-95.23	933.254	29.70	30	Pass
95	6425	124.89	-95.23	924.698	29.66	30	Pass
127	6585	124.83	-95.23	912.011	29.60	30	Pass
159	6745	124.85	-95.23	916.22	29.62	30	Pass
191	6905	122.67	-95.23	554.626	27.44	30	Pass



### Spectrum Plot of Worst Value

#### 802.11be (EHT20)

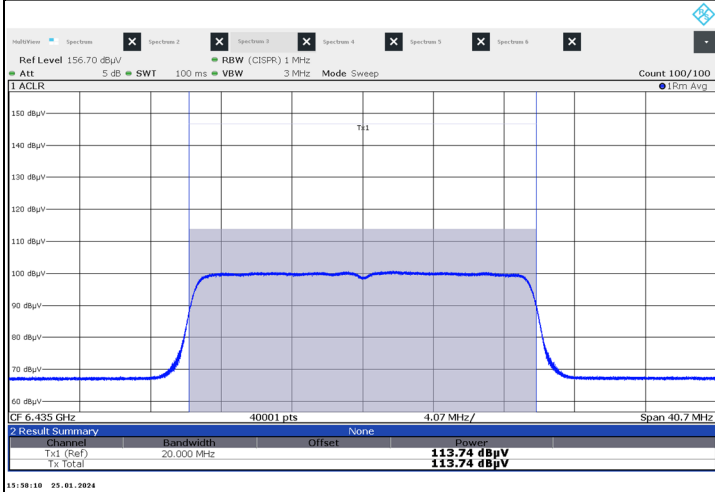

#### 802.11be (EHT40)

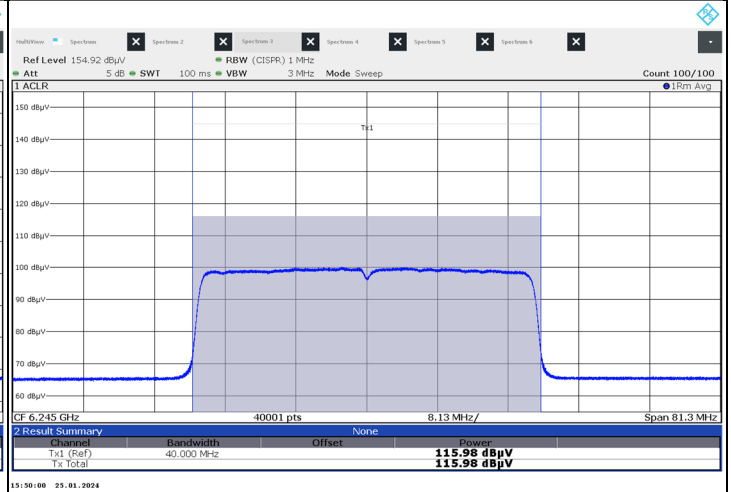

#### 802.11be (EHT80)

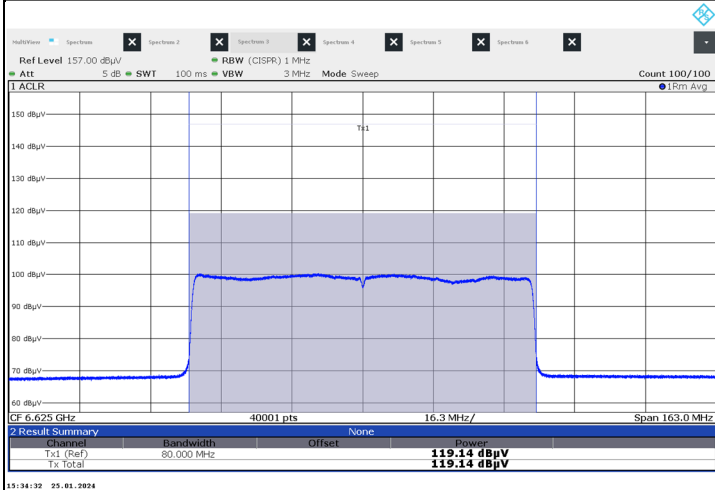

#### 802.11be (EHT160)

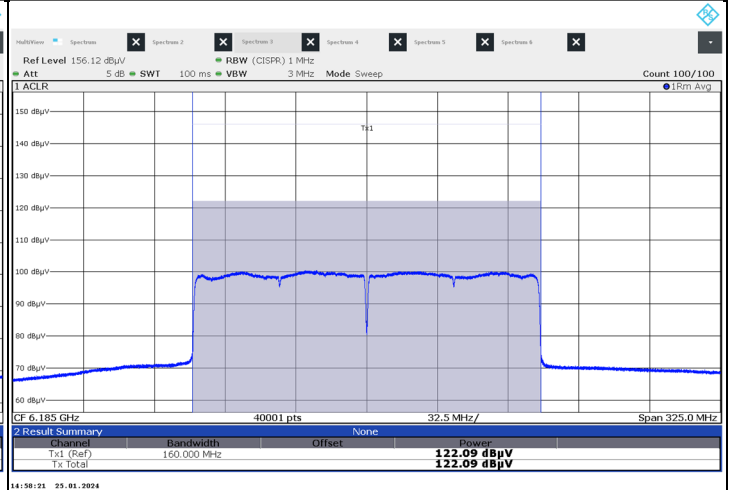

#### 802.11be (EHT320)

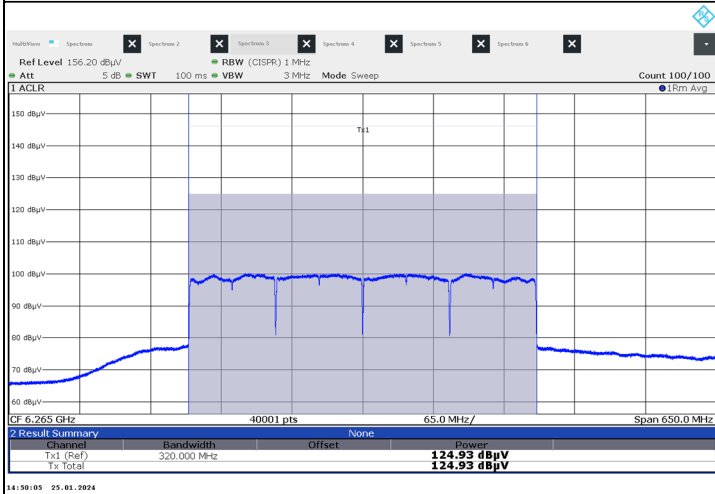

## 7.2 Maximum Power Spectral Density

Input Power:	120 Vac, 60 Hz	Environmental Conditions:	25°C, 60% RH	Tested By:	Jisyong Wang
--------------	----------------	---------------------------	--------------	------------	--------------

### NSS1

#### 802.11a CDD

Chan.	Chan. Freq. (MHz)	Field Strength (dBuV/m)	Correction Factor (dB)	EIRP PSD (dBm/MHz)	EIRP PSD Limit (dBm/MHz)	Test Result
33	6115	100.12	-95.23	4.89	5	Pass
61	6255	100.11	-95.23	4.88	5	Pass
93	6415	100.10	-95.23	4.87	5	Pass
97	6435	100.09	-95.23	4.86	5	Pass
105	6475	100.10	-95.23	4.87	5	Pass
113	6515	100.18	-95.23	4.95	5	Pass
117	6535	100.10	-95.23	4.87	5	Pass
149	6695	100.11	-95.23	4.88	5	Pass
181	6855	100.11	-95.23	4.88	5	Pass
185	6875	100.08	-95.23	4.85	5	Pass
209	6995	100.11	-95.23	4.88	5	Pass
229	7095	100.13	-95.23	4.90	5	Pass
233	7115	100.06	-95.23	4.83	5	Pass

#### 802.11be (EHT20) Beamforming

Chan.	Chan. Freq. (MHz)	Field Strength (dBuV/m)	Correction Factor (dB)	EIRP PSD (dBm/MHz)	EIRP PSD Limit (dBm/MHz)	Test Result
33	6115	100.02	-95.23	4.79	5	Pass
61	6255	100.11	-95.23	4.88	5	Pass
93	6415	100.15	-95.23	4.92	5	Pass
97	6435	100.19	-95.23	4.96	5	Pass
105	6475	100.18	-95.23	4.95	5	Pass
113	6515	100.09	-95.23	4.86	5	Pass
117	6535	100.12	-95.23	4.89	5	Pass
149	6695	100.18	-95.23	4.95	5	Pass
181	6855	100.14	-95.23	4.91	5	Pass
185	6875	100.16	-95.23	4.93	5	Pass
209	6995	100.18	-95.23	4.95	5	Pass
229	7095	100.06	-95.23	4.83	5	Pass
233	7115	84.27	-95.23	-10.96	5	Pass

### 802.11be (EHT40) Beamforming

Chan.	Chan. Freq. (MHz)	Field Strength (dBuV/m)	Correction Factor (dB)	EIRP PSD (dBm/MHz)	EIRP PSD Limit (dBm/MHz)	Test Result
35	6125	100.09	-95.23	4.86	5	Pass
59	6245	100.21	-95.23	4.98	5	Pass
91	6405	100.13	-95.23	4.90	5	Pass
99	6445	100.15	-95.23	4.92	5	Pass
107	6485	100.13	-95.23	4.90	5	Pass
115	6525	100.16	-95.23	4.93	5	Pass
123	6565	100.18	-95.23	4.95	5	Pass
155	6725	100.11	-95.23	4.88	5	Pass
179	6845	100.09	-95.23	4.86	5	Pass
187	6885	100.08	-95.23	4.85	5	Pass
211	7005	100.15	-95.23	4.92	5	Pass
227	7085	100.20	-95.23	4.97	5	Pass

### 802.11be (EHT80) Beamforming

Chan.	Chan. Freq. (MHz)	Field Strength (dBuV/m)	Correction Factor (dB)	EIRP PSD (dBm/MHz)	EIRP PSD Limit (dBm/MHz)	Test Result
39	6145	100.18	-95.23	4.95	5	Pass
55	6225	100.11	-95.23	4.88	5	Pass
87	6385	100.12	-95.23	4.89	5	Pass
103	6465	100.13	-95.23	4.90	5	Pass
119	6545	100.15	-95.23	4.92	5	Pass
135	6625	100.17	-95.23	4.94	5	Pass
151	6705	100.16	-95.23	4.93	5	Pass
167	6785	100.19	-95.23	4.96	5	Pass
183	6865	100.17	-95.23	4.94	5	Pass
199	6945	100.12	-95.23	4.89	5	Pass
215	7025	100.16	-95.23	4.93	5	Pass

### 802.11be (EHT160) Beamforming

Chan.	Chan. Freq. (MHz)	Field Strength (dBuV/m)	Correction Factor (dB)	EIRP PSD (dBm/MHz)	EIRP PSD Limit (dBm/MHz)	Test Result
47	6185	100.17	-95.23	4.94	5	Pass
79	6345	100.10	-95.23	4.87	5	Pass
111	6505	100.18	-95.23	4.95	5	Pass
143	6665	100.15	-95.23	4.92	5	Pass
175	6825	100.16	-95.23	4.93	5	Pass
207	6985	100.08	-95.23	4.85	5	Pass

### 802.11be (EHT320) Beamforming

Chan.	Chan. Freq. (MHz)	Field Strength (dBuV/m)	Correction Factor (dB)	EIRP PSD (dBm/MHz)	EIRP PSD Limit (dBm/MHz)	Test Result
63	6265	100.18	-95.23	4.95	5	Pass
95	6425	100.17	-95.23	4.94	5	Pass
127	6585	100.14	-95.23	4.91	5	Pass
159	6745	100.18	-95.23	4.95	5	Pass
191	6905	100.10	-95.23	4.87	5	Pass



### Spectrum Plot of Worst Value

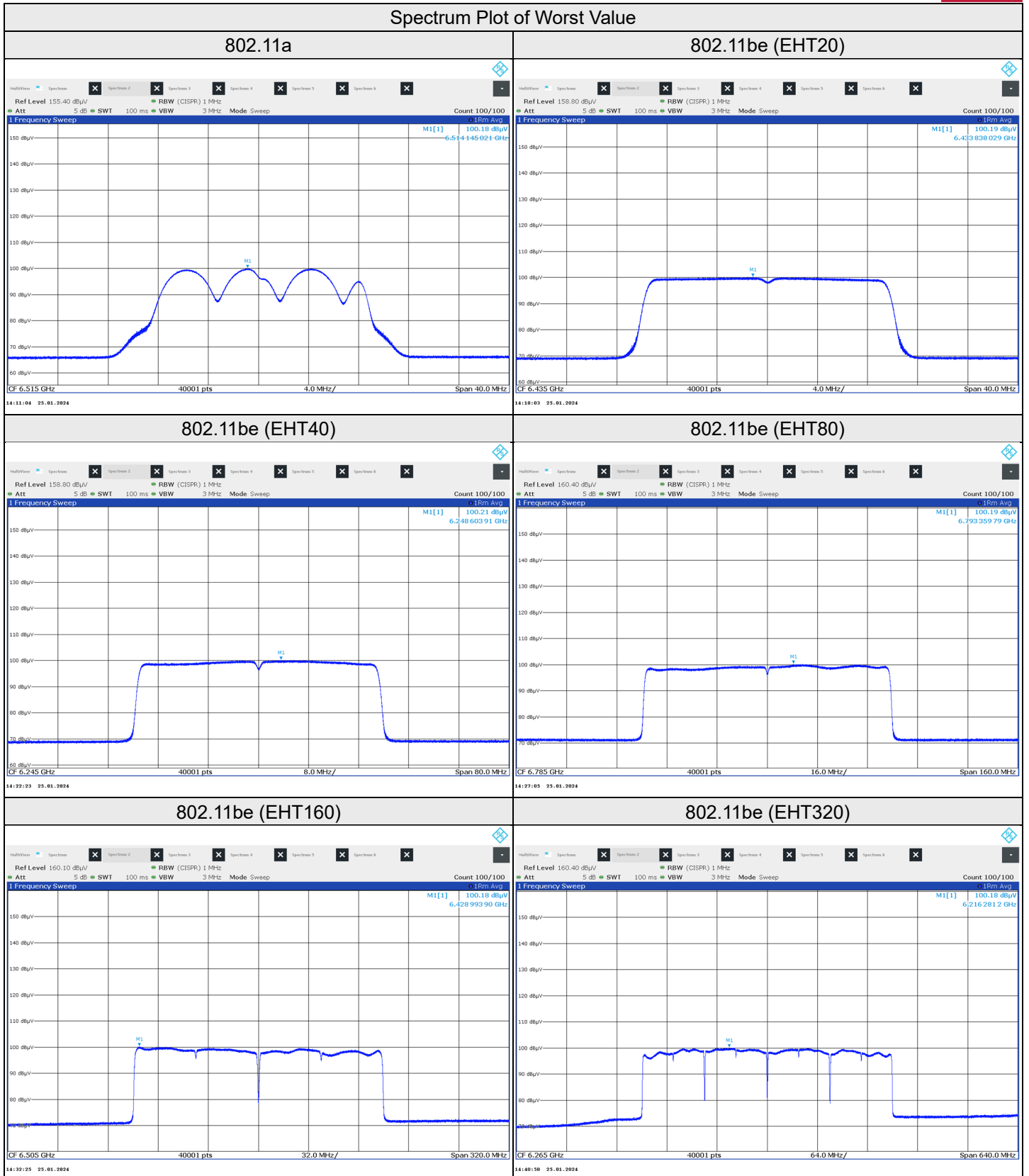



Input Power:	120 Vac, 60 Hz	Environmental Conditions:	25°C, 60% RH	Tested By:	Jisyong Wang
--------------	----------------	---------------------------	--------------	------------	--------------

**NSS2**

**802.11be (EHT20) Beamforming**

Chan.	Chan. Freq. (MHz)	Field Strength (dBuV/m)	Correction Factor (dB)	EIRP PSD (dBm/MHz)	EIRP PSD Limit (dBm/MHz)	Test Result
33	6115	100.01	-95.23	4.78	5	Pass
61	6255	100.18	-95.23	4.95	5	Pass
93	6415	100.13	-95.23	4.90	5	Pass
97	6435	100.20	-95.23	4.97	5	Pass
105	6475	100.19	-95.23	4.96	5	Pass
113	6515	100.13	-95.23	4.90	5	Pass
117	6535	100.18	-95.23	4.95	5	Pass
149	6695	100.15	-95.23	4.92	5	Pass
181	6855	100.12	-95.23	4.89	5	Pass
185	6875	100.17	-95.23	4.94	5	Pass
209	6995	100.19	-95.23	4.96	5	Pass
229	7095	100.11	-95.23	4.88	5	Pass
233	7115	86.00	-95.23	-9.23	5	Pass

**802.11be (EHT40) Beamforming**

Chan.	Chan. Freq. (MHz)	Field Strength (dBuV/m)	Correction Factor (dB)	EIRP PSD (dBm/MHz)	EIRP PSD Limit (dBm/MHz)	Test Result
35	6125	100.05	-95.23	4.82	5	Pass
59	6245	100.21	-95.23	4.98	5	Pass
91	6405	100.16	-95.23	4.93	5	Pass
99	6445	100.18	-95.23	4.95	5	Pass
107	6485	100.20	-95.23	4.97	5	Pass
115	6525	100.20	-95.23	4.97	5	Pass
123	6565	100.18	-95.23	4.95	5	Pass
155	6725	100.13	-95.23	4.90	5	Pass
179	6845	100.12	-95.23	4.89	5	Pass
187	6885	100.11	-95.23	4.88	5	Pass
211	7005	100.17	-95.23	4.94	5	Pass
227	7085	100.20	-95.23	4.97	5	Pass

### 802.11be (EHT80) Beamforming

Chan.	Chan. Freq. (MHz)	Field Strength (dBuV/m)	Correction Factor (dB)	EIRP PSD (dBm/MHz)	EIRP PSD Limit (dBm/MHz)	Test Result
39	6145	100.19	-95.23	4.96	5	Pass
55	6225	100.13	-95.23	4.90	5	Pass
87	6385	100.19	-95.23	4.96	5	Pass
103	6465	100.16	-95.23	4.93	5	Pass
119	6545	100.16	-95.23	4.93	5	Pass
135	6625	100.21	-95.23	4.98	5	Pass
151	6705	100.19	-95.23	4.96	5	Pass
167	6785	100.15	-95.23	4.92	5	Pass
183	6865	100.19	-95.23	4.96	5	Pass
199	6945	100.14	-95.23	4.91	5	Pass
215	7025	100.20	-95.23	4.97	5	Pass

### 802.11be (EHT160) Beamforming

Chan.	Chan. Freq. (MHz)	Field Strength (dBuV/m)	Correction Factor (dB)	EIRP PSD (dBm/MHz)	EIRP PSD Limit (dBm/MHz)	Test Result
47	6185	100.20	-95.23	4.97	5	Pass
79	6345	100.14	-95.23	4.91	5	Pass
111	6505	100.15	-95.23	4.92	5	Pass
143	6665	100.17	-95.23	4.94	5	Pass
175	6825	100.17	-95.23	4.94	5	Pass
207	6985	100.07	-95.23	4.84	5	Pass

### 802.11be (EHT320) Beamforming

Chan.	Chan. Freq. (MHz)	Field Strength (dBuV/m)	Correction Factor (dB)	EIRP PSD (dBm/MHz)	EIRP PSD Limit (dBm/MHz)	Test Result
63	6265	100.20	-95.23	4.97	5	Pass
95	6425	100.18	-95.23	4.95	5	Pass
127	6585	100.17	-95.23	4.94	5	Pass
159	6745	100.17	-95.23	4.94	5	Pass
191	6905	100.13	-95.23	4.90	5	Pass





### Spectrum Plot of Worst Value

#### 802.11be (EHT20)

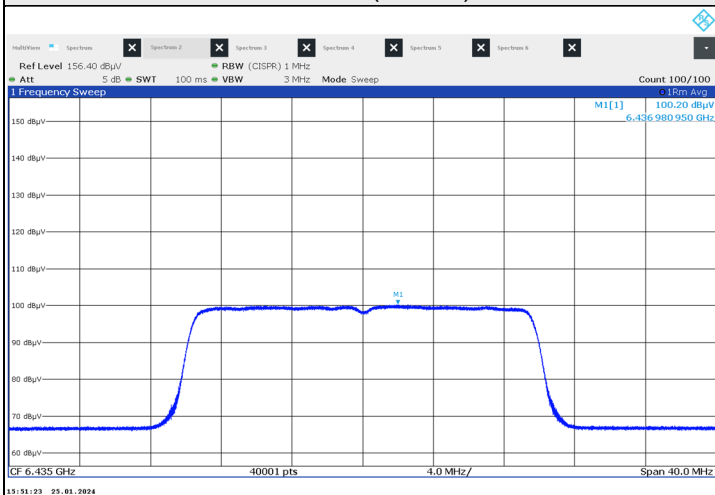

#### 802.11be (EHT40)

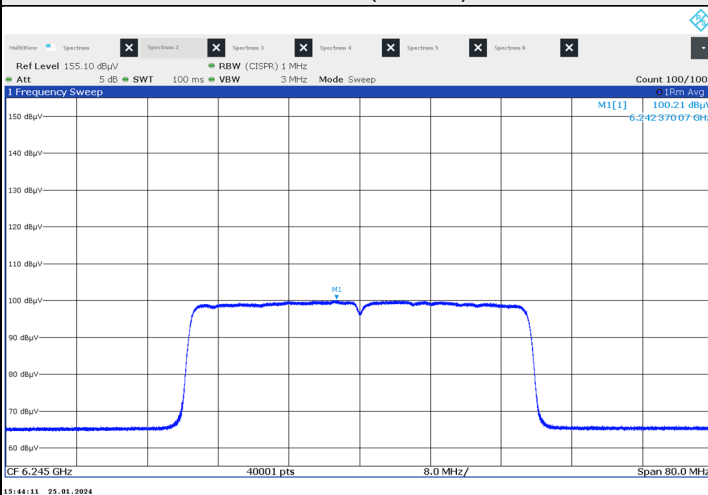

#### 802.11be (EHT80)

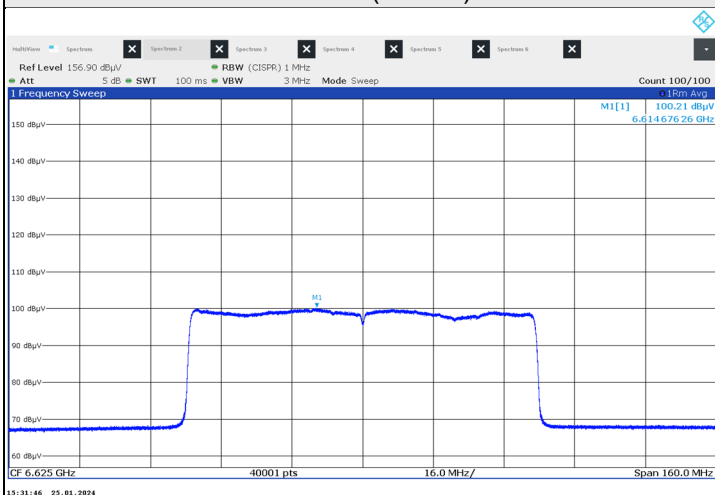

#### 802.11be (EHT160)

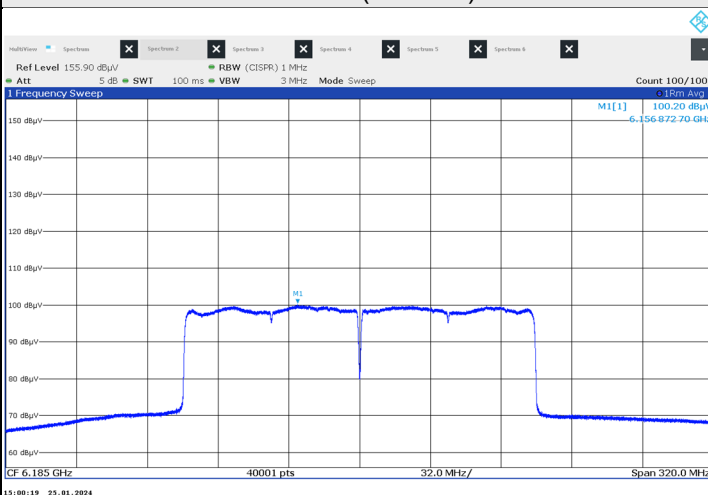

#### 802.11be (EHT320)

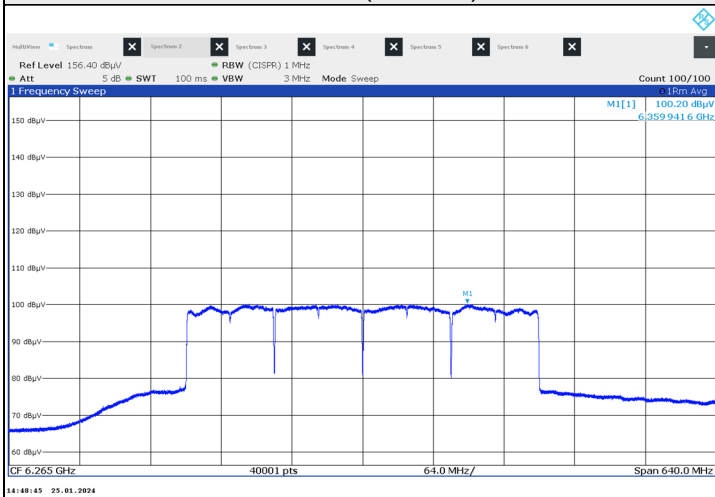

### 7.3 Emission Bandwidth

Input Power:	120 Vac, 60 Hz	Environmental Conditions:	25°C, 60% RH	Tested By:	Jisyong Wang
--------------	----------------	---------------------------	--------------	------------	--------------

#### NSS1

##### 802.11a

Channel	Frequency (MHz)	26dB Bandwidth (MHz)		Maximum Limit (MHz)	Test Result
		Chain 0	Chain 1		
33	6115	21.58	21.64	320	Pass
61	6255	21.38	21.51	320	Pass
93	6415	21.72	21.66	320	Pass
97	6435	21.59	21.68	320	Pass
105	6475	21.76	21.52	320	Pass
113	6515	21.69	21.49	320	Pass
117	6535	21.62	21.59	320	Pass
149	6695	21.54	21.63	320	Pass
181	6855	21.54	21.63	320	Pass
185	6875	21.67	21.71	320	Pass
209	6995	21.86	21.52	320	Pass
229	7095	21.58	21.62	320	Pass
233	7115	21.61	21.67	320	Pass

##### 802.11be (EHT20)

Channel	Frequency (MHz)	26dB Bandwidth (MHz)		Maximum Limit (MHz)	Test Result
		Chain 0	Chain 1		
33	6115	21.74	21.62	320	Pass
61	6255	21.76	21.75	320	Pass
93	6415	21.79	21.82	320	Pass
97	6435	21.68	21.67	320	Pass
105	6475	21.90	21.80	320	Pass
113	6515	21.81	21.78	320	Pass
117	6535	21.81	21.80	320	Pass
149	6695	21.79	21.80	320	Pass
181	6855	22.00	21.81	320	Pass
185	6875	21.84	21.83	320	Pass
209	6995	21.76	21.82	320	Pass
229	7095	21.73	21.78	320	Pass
233	7115	21.87	21.69	320	Pass

**802.11be (EHT40)**

Channel	Frequency (MHz)	26dB Bandwidth (MHz)		Maximum Limit (MHz)	Test Result
		Chain 0	Chain 1		
35	6125	41.24	41.25	320	Pass
59	6245	41.43	41.24	320	Pass
91	6405	41.26	41.30	320	Pass
99	6445	41.34	41.18	320	Pass
107	6485	41.34	41.16	320	Pass
115	6525	41.20	41.27	320	Pass
123	6565	41.49	41.48	320	Pass
155	6725	41.51	41.31	320	Pass
179	6845	40.97	41.22	320	Pass
187	6885	41.49	41.51	320	Pass
211	7005	41.47	41.31	320	Pass
227	7085	41.29	41.25	320	Pass

**802.11be (EHT80)**

Channel	Frequency (MHz)	26dB Bandwidth (MHz)		Maximum Limit (MHz)	Test Result
		Chain 0	Chain 1		
39	6145	82.20	82.09	320	Pass
55	6225	82.29	82.52	320	Pass
87	6385	82.87	82.71	320	Pass
103	6465	82.54	82.59	320	Pass
119	6545	82.34	82.73	320	Pass
135	6625	82.67	82.50	320	Pass
151	6705	82.68	82.68	320	Pass
167	6785	82.36	82.78	320	Pass
183	6865	82.63	82.73	320	Pass
199	6945	82.66	82.51	320	Pass
215	7025	82.42	82.56	320	Pass

**802.11be (EHT160)**

Channel	Frequency (MHz)	26dB Bandwidth (MHz)		Maximum Limit (MHz)	Test Result
		Chain 0	Chain 1		
47	6185	165.71	165.25	320	Pass
79	6345	165.78	165.92	320	Pass
111	6505	165.32	165.42	320	Pass
143	6665	166.02	165.49	320	Pass
175	6825	165.38	166.35	320	Pass
207	6985	165.20	164.70	320	Pass

**802.11be (EHT320)**

Channel	Frequency (MHz)	26dB Bandwidth (MHz)		Maximum Limit (MHz)	Test Result
		Chain 0	Chain 1		
63	6265	438.11	394.63	320	Note
95	6425	368.84	359.85	320	Note
127	6585	347.44	344.10	320	Note
159	6745	530.58	530.58	320	Note
191	6905	328.82	328.52	320	Note

Note: Please refer to 99% OBW measurement test results for Wi-Fi 320 MHz BW mode.

### Spectrum Plot of Maximum Value

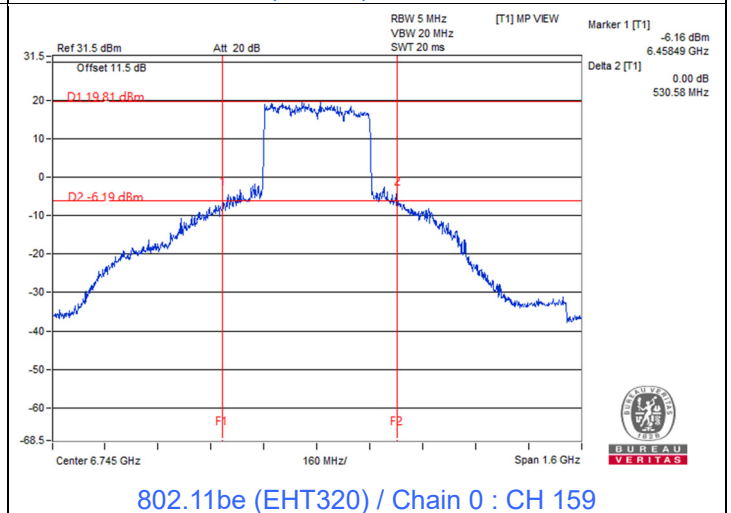
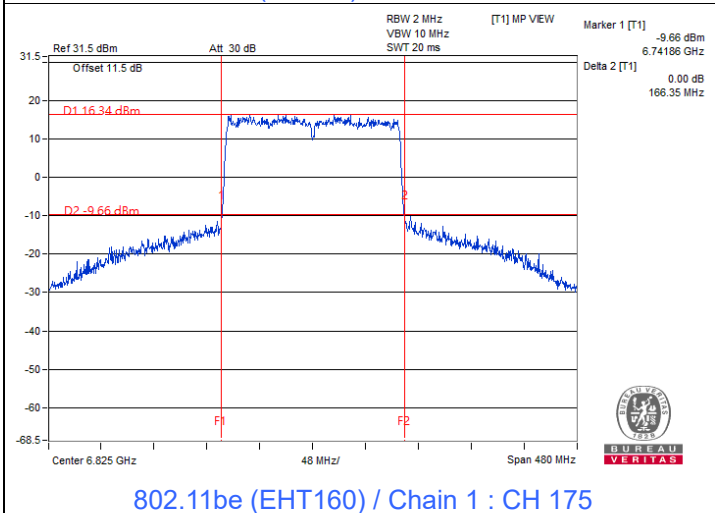
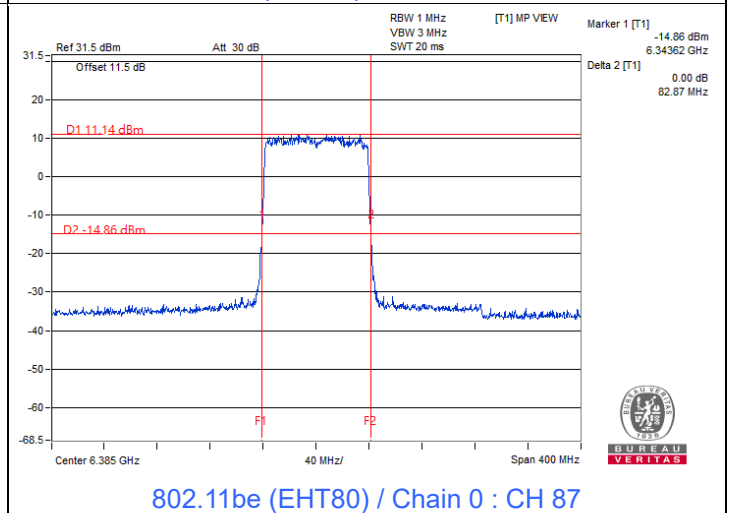
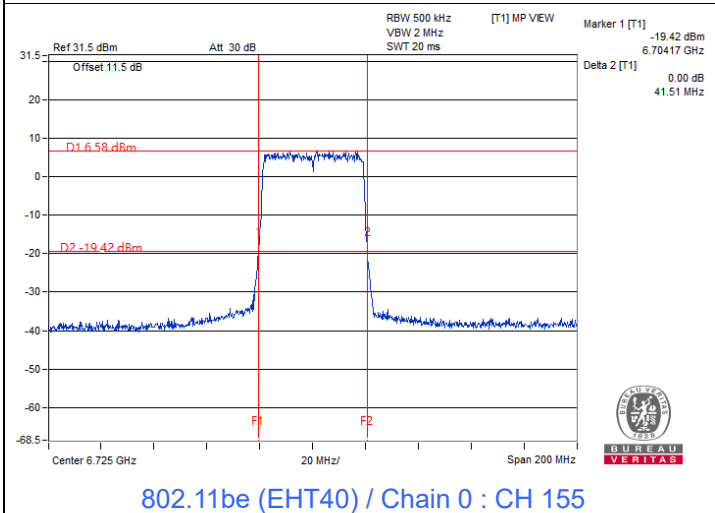
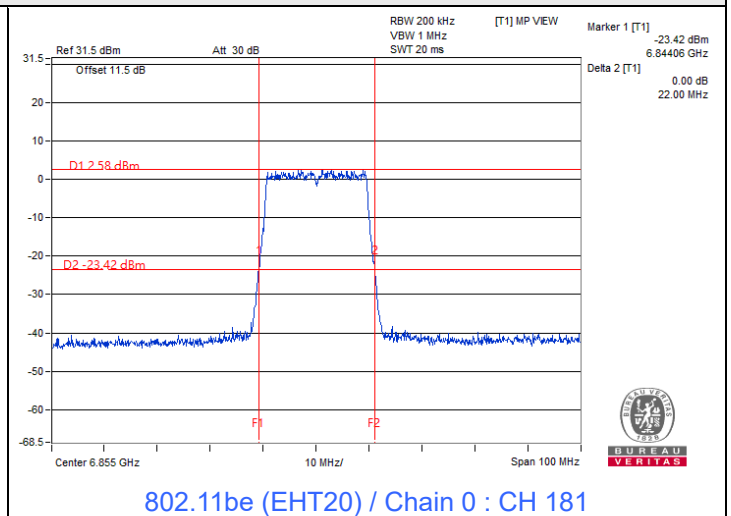
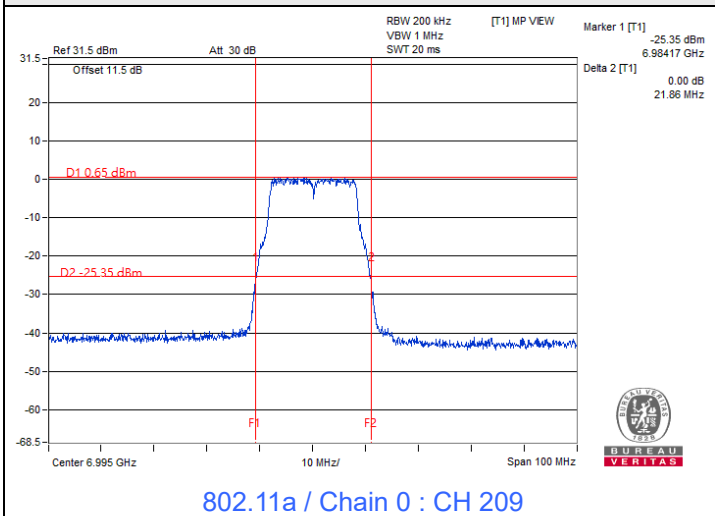



Input Power:	120 Vac, 60 Hz	Environmental Conditions:	25°C, 60% RH	Tested By:	Jisyong Wang
--------------	----------------	---------------------------	--------------	------------	--------------

**NSS2**

**802.11be (EHT20)**

Channel	Frequency (MHz)	26dB Bandwidth (MHz)		Maximum Limit (MHz)	Test Result
		Chain 0	Chain 1		
33	6115	21.67	21.75	320	Pass
61	6255	21.85	21.64	320	Pass
93	6415	21.77	21.74	320	Pass
97	6435	21.71	21.91	320	Pass
105	6475	21.71	21.76	320	Pass
113	6515	21.71	21.75	320	Pass
117	6535	21.75	21.65	320	Pass
149	6695	21.75	21.77	320	Pass
181	6855	21.88	21.83	320	Pass
185	6875	21.86	21.53	320	Pass
209	6995	21.86	21.75	320	Pass
229	7095	21.60	21.67	320	Pass
233	7115	21.84	21.76	320	Pass

**802.11be (EHT40)**

Channel	Frequency (MHz)	26dB Bandwidth (MHz)		Maximum Limit (MHz)	Test Result
		Chain 0	Chain 1		
35	6125	40.82	41.05	320	Pass
59	6245	41.13	40.84	320	Pass
91	6405	40.88	41.03	320	Pass
99	6445	40.92	40.99	320	Pass
107	6485	40.81	41.12	320	Pass
115	6525	41.00	41.04	320	Pass
123	6565	40.83	40.88	320	Pass
155	6725	40.93	41.09	320	Pass
179	6845	41.30	40.94	320	Pass
187	6885	40.85	41.00	320	Pass
211	7005	40.93	40.93	320	Pass
227	7085	41.24	40.82	320	Pass

**802.11be (EHT80)**

Channel	Frequency (MHz)	26dB Bandwidth (MHz)		Maximum Limit (MHz)	Test Result
		Chain 0	Chain 1		
39	6145	82.57	82.50	320	Pass
55	6225	82.40	82.21	320	Pass
87	6385	82.68	82.66	320	Pass
103	6465	83.16	82.57	320	Pass
119	6545	82.61	82.44	320	Pass
135	6625	82.61	82.57	320	Pass
151	6705	82.60	82.59	320	Pass
167	6785	82.19	82.21	320	Pass
183	6865	82.89	82.41	320	Pass
199	6945	82.74	82.42	320	Pass
215	7025	82.85	82.31	320	Pass

**802.11be (EHT160)**

Channel	Frequency (MHz)	26dB Bandwidth (MHz)		Maximum Limit (MHz)	Test Result
		Chain 0	Chain 1		
47	6185	167.27	179.06	320	Pass
79	6345	165.62	166.04	320	Pass
111	6505	165.81	164.82	320	Pass
143	6665	165.40	166.24	320	Pass
175	6825	172.54	165.75	320	Pass
207	6985	220.53	232.62	320	Pass

**802.11be (EHT320)**

Channel	Frequency (MHz)	26dB Bandwidth (MHz)		Maximum Limit (MHz)	Test Result
		Chain 0	Chain 1		
63	6265	522.24	536.63	320	Note
95	6425	543.90	569.97	320	Note
127	6585	655.08	625.71	320	Note
159	6745	663.02	644.78	320	Note
191	6905	410.30	408.58	320	Note

Note: Please refer to 99% OBW measurement test results for Wi-Fi 320 MHz BW mode.

### Spectrum Plot of Maximum Value

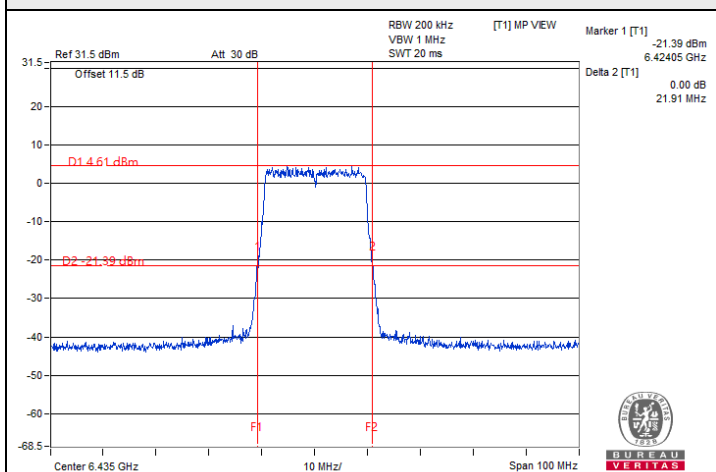

802.11be (EHT20) / Chain 1 : CH 97

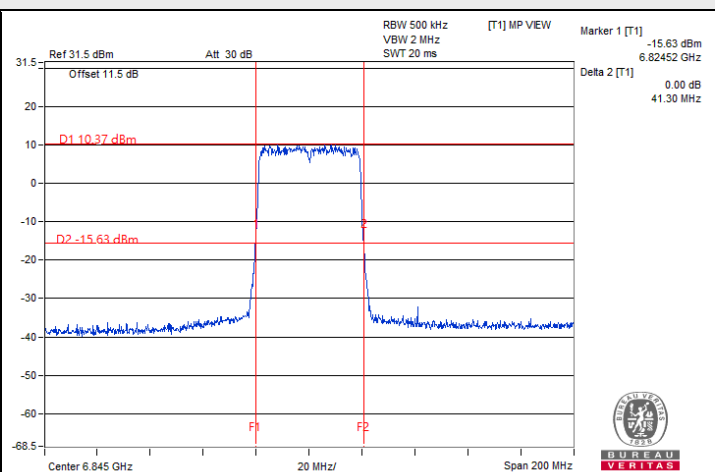

802.11be (EHT40) / Chain 0 : CH 179

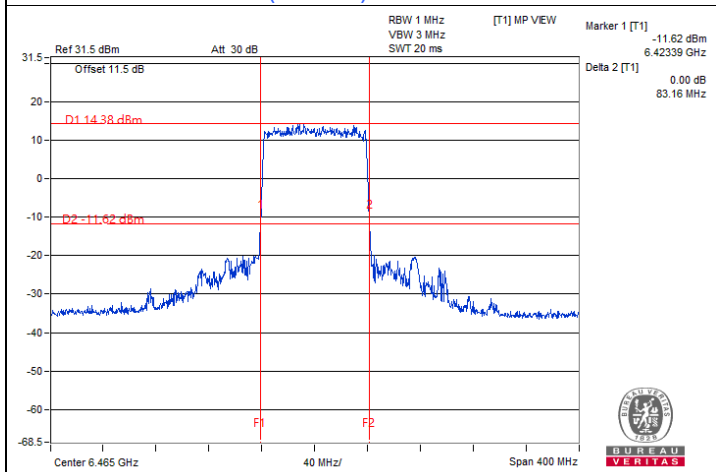

802.11be (EHT80) / Chain 0 : CH 103

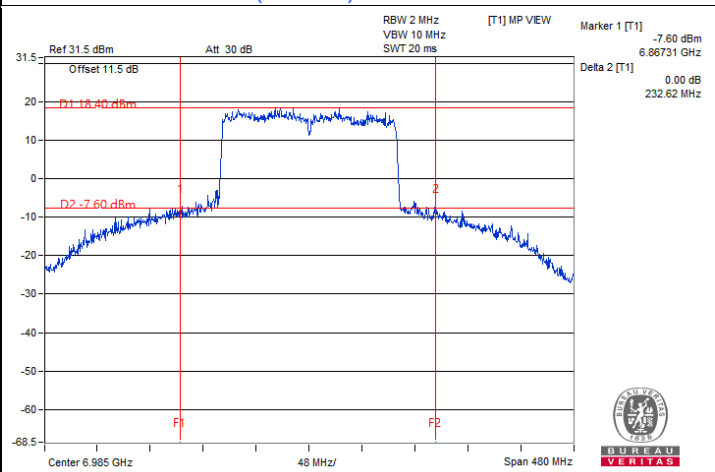

802.11be (EHT160) / Chain 1 : CH 207

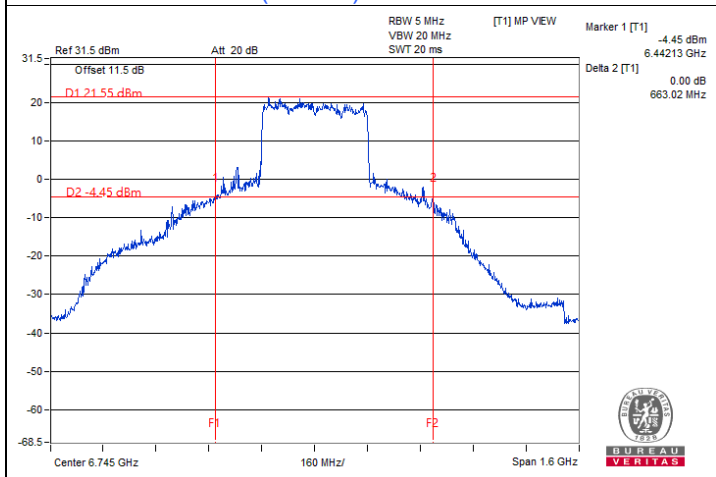

802.11be (EHT320) / Chain 0 : CH 159



### 7.4 In-Band Emission Mask

Input Power:	120 Vac, 60 Hz	Environmental Conditions:	25°C, 60% RH	Tested By:	Jisyong Wang
--------------	----------------	---------------------------	--------------	------------	--------------

NSS1

802.11a

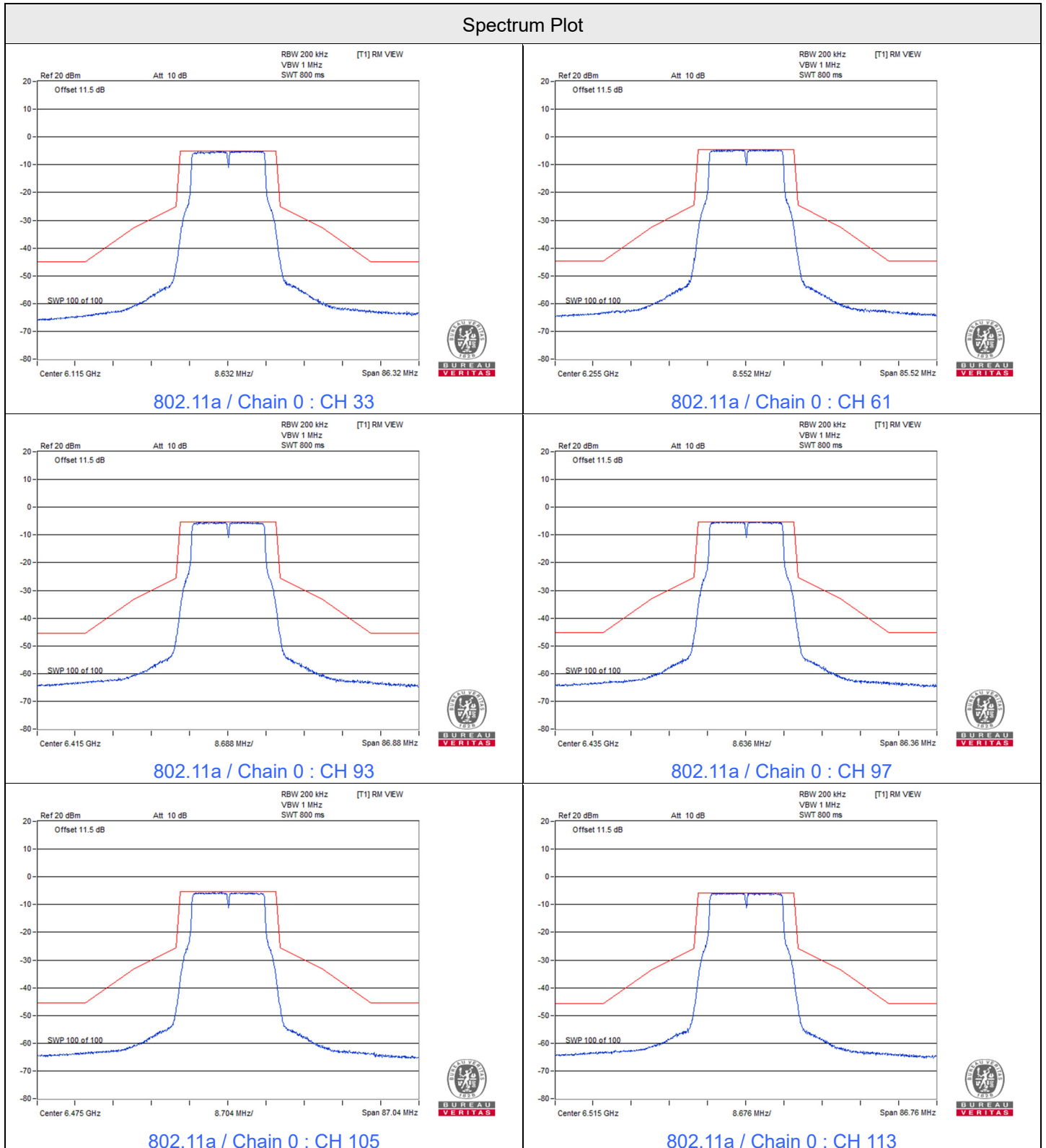

### Spectrum Plot

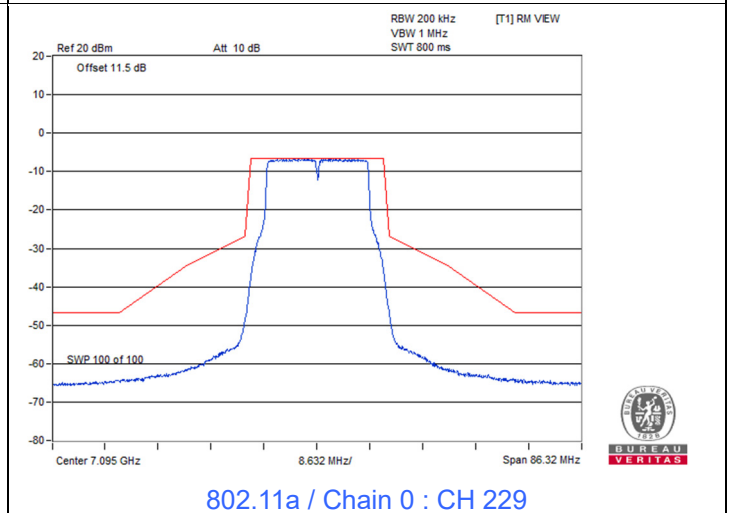
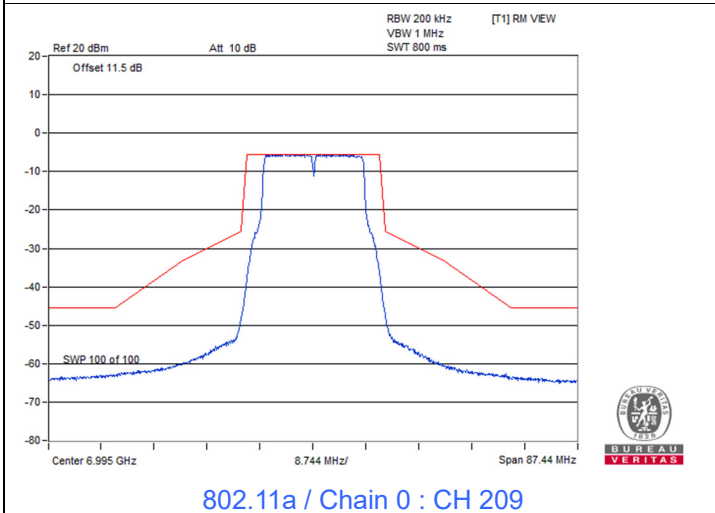
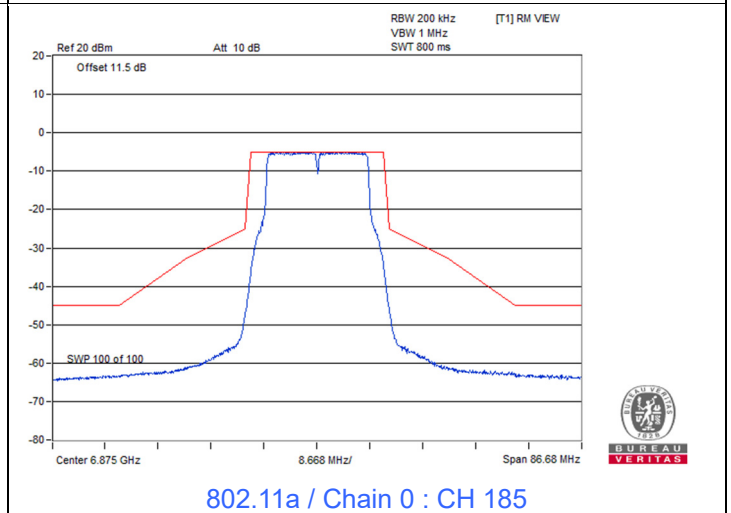
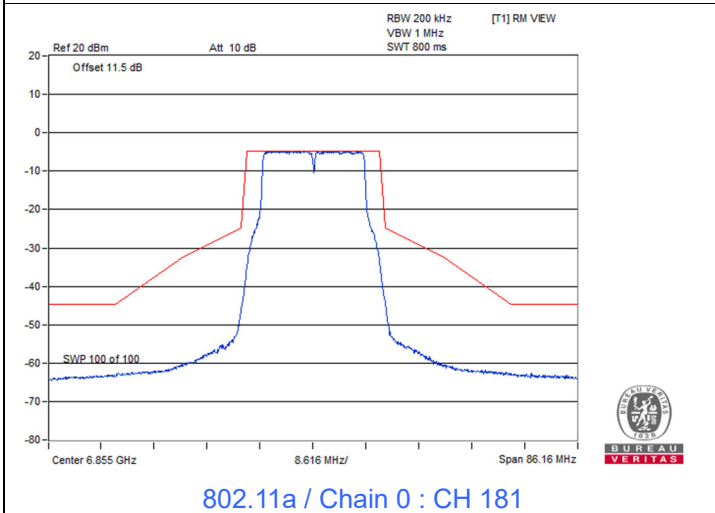
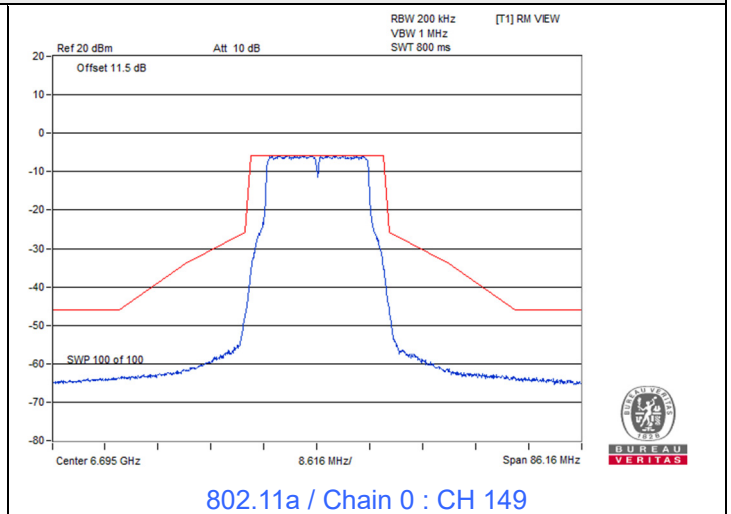
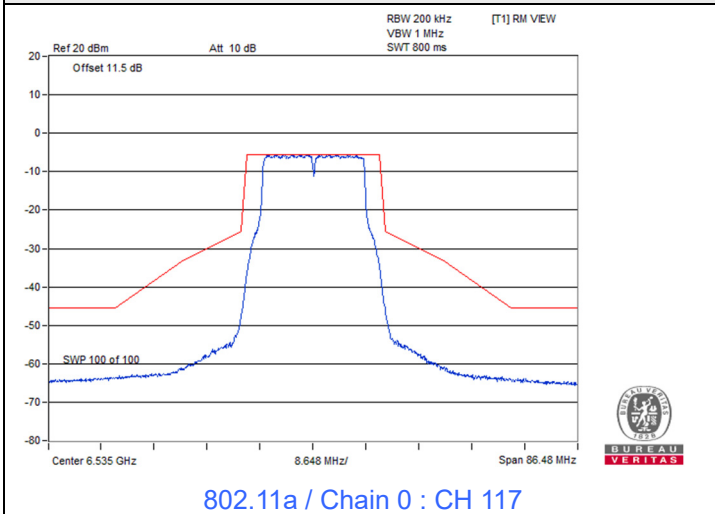

### Spectrum Plot

