

Antenna Data sheet

Date: 2024.01.30

Address: 20 Park Avenue II (or Yuanchiu 2nd Rd.), Hsinchu Science Park, Hsinchu 300, Taiwan

Contents

- Chamber Info.
- Name and address of the antenna manufacture
- Peak Gain
- Radiation Pattern

Chamber Info.

➤ Measurement setup info. & test method:

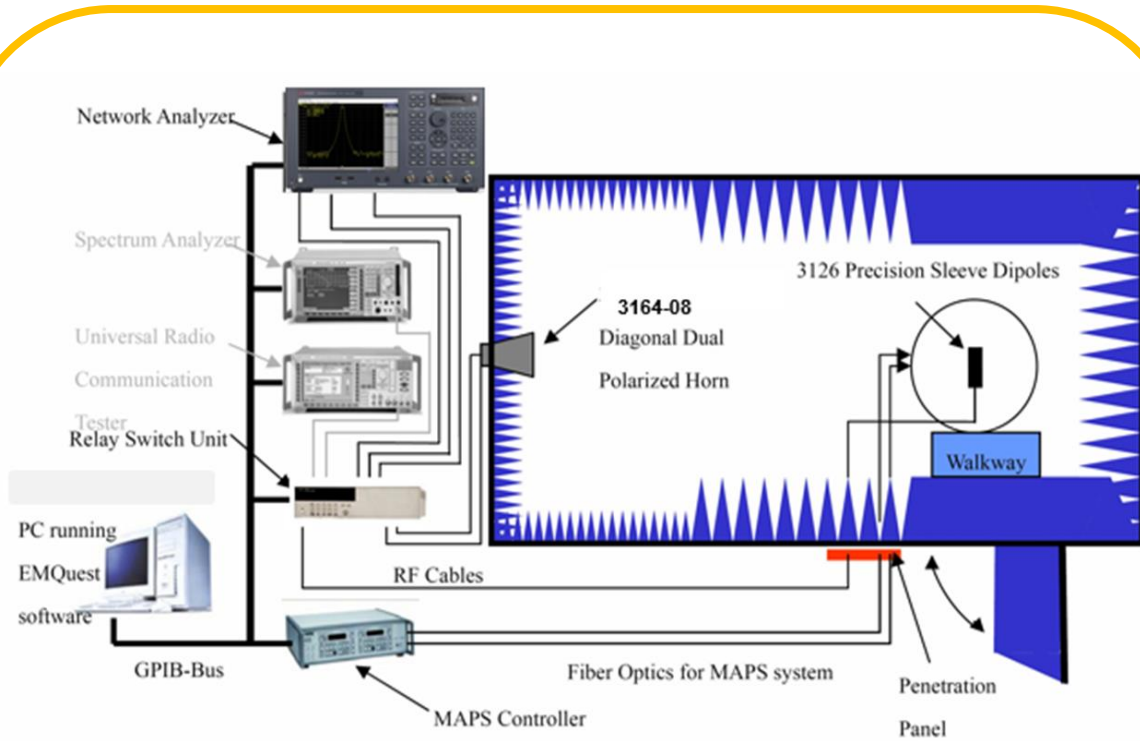

Test Method

The “great circle” cut method, whereby the Measurement Antenna remains fixed and the EUT is rotated about two axes in sequential order. The radiated RF performance of the Equipment Under Test (EUT) is measured by sampling the radiated transmit power of the mobile at various locations surrounding the device. A three-dimensional characterization of the 'transmit' performance of the EUT is pieced together by analyzing the data from the spatially distributed measurements.

Data points taken every 15 degrees in the theta and in the phi axes are deemed sufficient to fully characterize the EUT's Far-Field radiation pattern and total radiated power. All of the measured power values will be integrated.

Chamber Info.

➤ *Calibrated and measurement equipment table list:*

Describe	Manufacturer	Model Number	Serial Number	Cal. Date	Cal. Due Date
Full Anechoic Wireless Test chamber	ETS-Lindgren	AMS-8500	N/A	N.C.R	-----
Test Software	EMQuest™	N/A	N/A	N.C.R	-----
Multi-Axis Positioning System (MAPS)	EMCO	2090	N/A	N.C.R	-----
Turn Table	EMCO	2015	N/A	N.C.R	-----
Dual Polarization Horn	ETS-Lindgren	3164-08	00140264	N.C.R	-----
ENA Series Network Analyzer	Keysight	E5071C	MY467330006	May. 31, 2022	May. 31, 2023

Note:

1. N.C.R. = No Calibration Request.
2. This ant. test chamber is located in WNC which address is :
Add: 20 Park Avenue II (or Yuanchiu 2nd Rd.), Hsinchu Science Park, Hsinchu 300, Taiwan
Tel: +886-3-666-7799

Chamber Info.

➤ Test Procedure & SW :

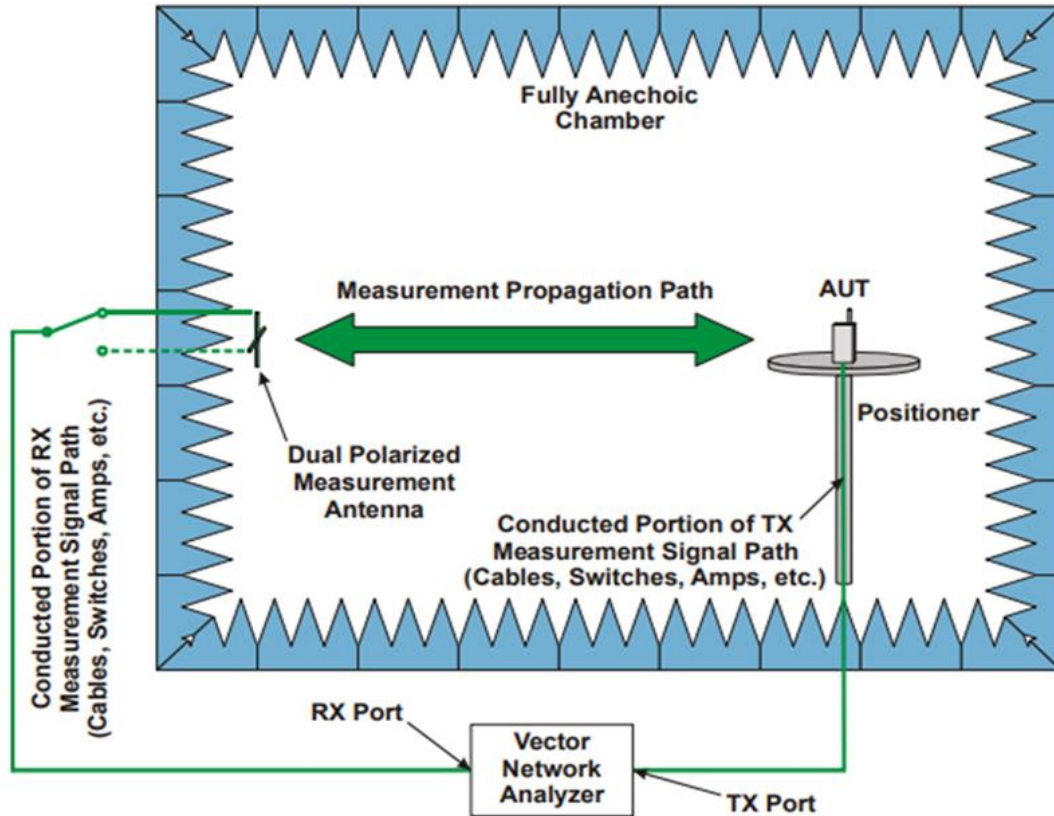

- Place the device at the center of the chamber.
- Connect the antenna cable to RF cable of the chamber.
- Run the test SW (EMQuest™).
- Get 3D data in 15 degree step from phi 0° ~ 360° and theta -90° ~ $+90^{\circ}$, including efficiency, peak gain, 2D & 3D radiation pattern.
- This is far field test for antenna verification.
- This is passive measurement, which means the device is off and not in any operating mode.

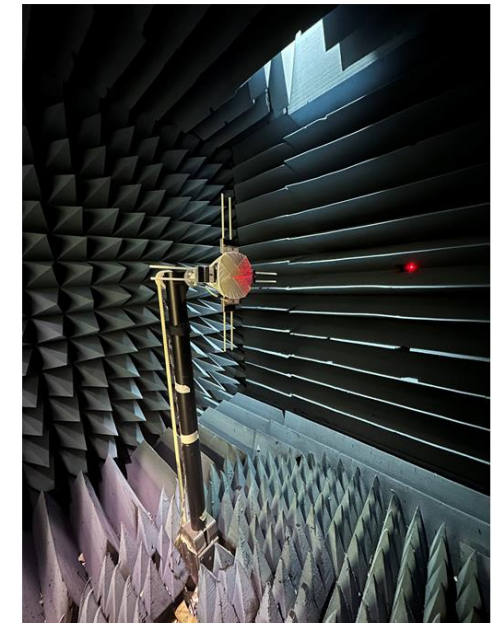

Note : Top cover toward +Z direction

Name and address of the antenna manufacture



NEWEB VIETNAM CO., LTD.

- *Land Lot CN01, Dong Van III Industrial Zone, Dong Van Ward, Duy Tien Town, Ha Nam Province, Vietnam*
- [+84-226-358-8899](tel:+84-226-358-8899)
- [+84-226-358-7799](tel:+84-226-358-7799)

Peak Gain

Dual Band	Freq. (MHz)	2400	2450	2500	5150	5350	5550	5750	5850
90XYBH15.GAD	Peak Gain (dBi)	1.32	1.35	1.04	1.98	2.97	2.95	2.56	2.73
90XYBH15.GAE	Peak Gain (dBi)	1.73	1.98	1.85	1.83	2.75	2.98	2.85	2.93

6G	Freq. (MHz)	6000	6200	6300	6500	6700	6800	6900	7000	7100	7125
90XYBH15.GAB_0	Peak Gain (dBi)	3.70	3.75	4.11	4.66	4.93	4.56	4.07	4.13	4.27	4.12
90XYBH15.GAC_0	Peak Gain (dBi)	3.62	3.78	4.25	4.85	4.99	4.85	4.14	4.02	4.07	4.34

Radiation Pattern for 6G

90XYBH15.GAB_0

6G Radiation Pattern

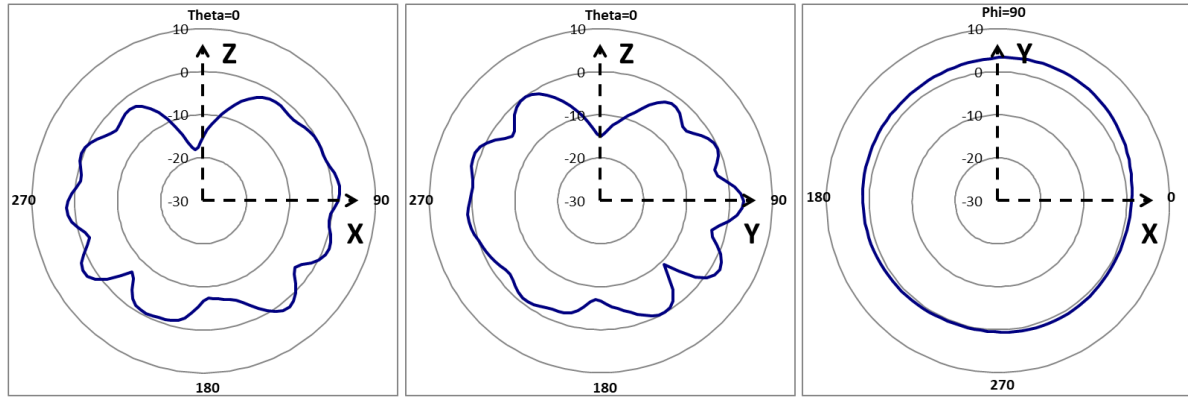

90XYBH15.GAC_0

6G Radiation Pattern

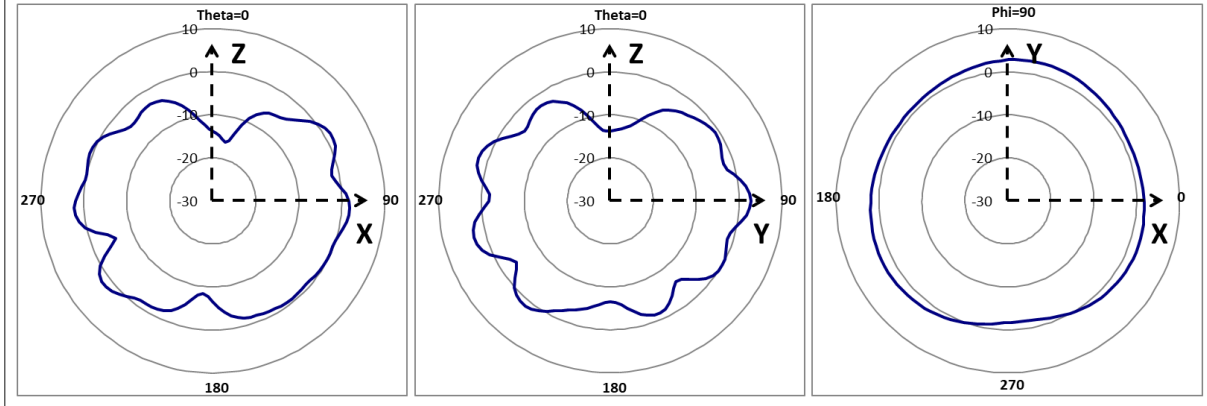

Radiation Pattern for Dual Band

90XYBH15.GAD

2G
Radiation Pattern

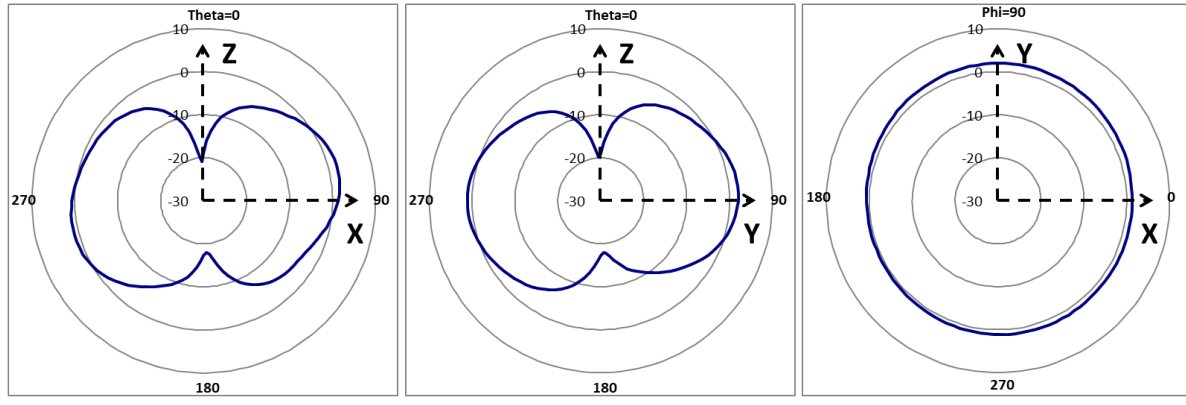

90XYBH15.GAE

2G
Radiation Pattern

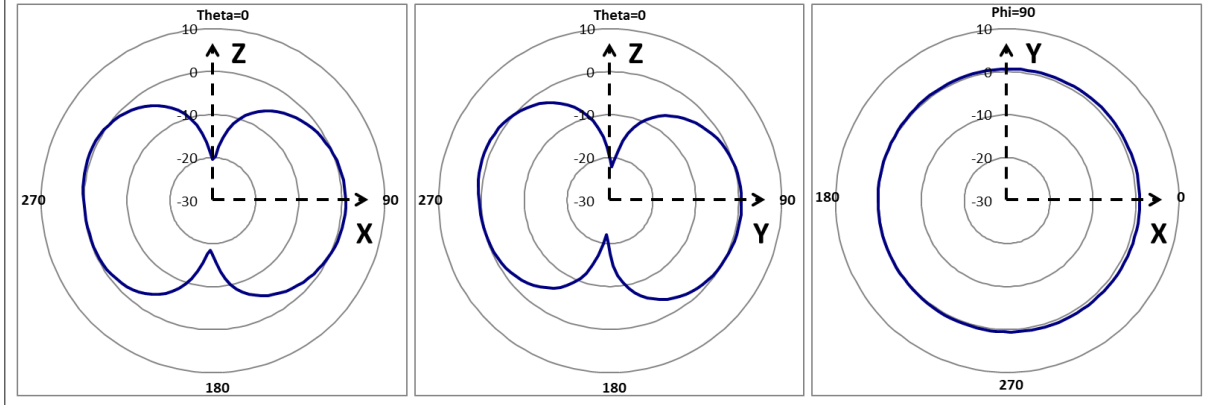

90XYBH15.GAD

5G
Radiation Pattern

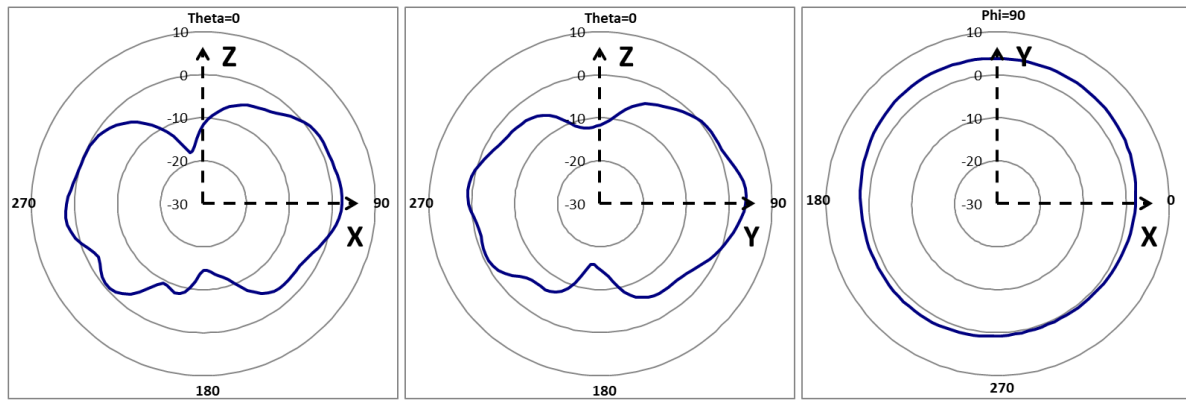

90XYBH15.GAE

5G
Radiation Pattern

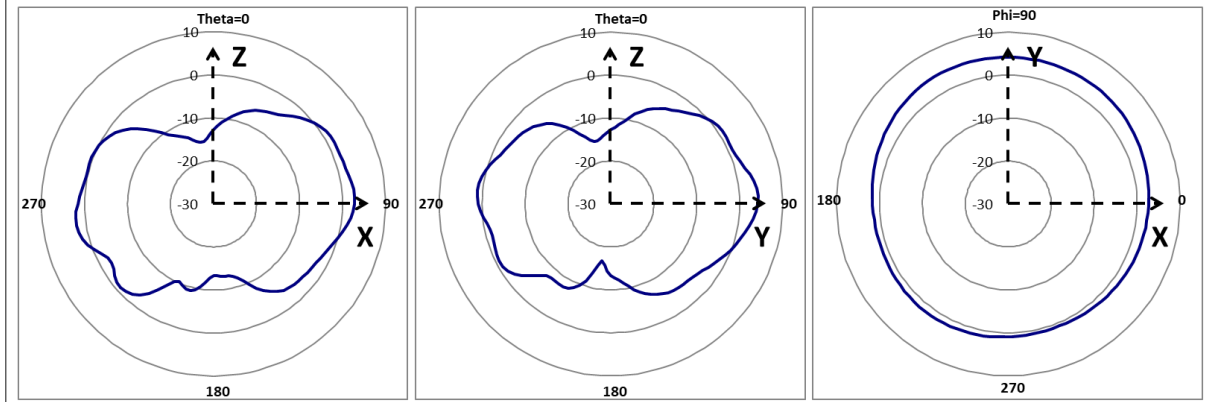

WNC

Wistron NeWeb Corp.

