

ACA-5036-A2-CC-S Specification

1. APPLICATION:

WLAN, 802.11b/g, Bluetooth, etc...

2. Explanation of part number :

$\frac{AC}{(1)}$ $\frac{A}{(2)}$ - $\frac{5036}{(3)}$ - $\frac{A2}{(4)}$ - $\frac{CC}{(5)}$ - $\frac{S}{(6)}$ $\bar{(7)}$

- (1) Product Type : Chip Antenna
- (2) Center Frequency/Band Code : A--2.45GHz group
- (3) Size Code: 5.0mm(Length) x 3.6mm(Width)
- (4) Design Revision Code: Rev.2
- (5) CC= Coupling Ceramics Type
- (6) Special Code: S=RoHS Compliant
- (7) Suffix For Special Requirements

3. Electrical Specification :

ITEM		SPECIFICATION
Frequency Band		2.40GHz~2.50GHz
VSWR		Less than 2.5
Polarization		Linear
*Peak Gain	Layout A	3 dBi Typ.
	Layout B	2.1 dBi Typ.
*Peak Efficiency	Layout A	80% Typ.
	Layout B	74% Typ
Impedance		50Ω Typ.

* Test condition: Test board size 80*40 mm

Matching circuit: Pi matching circuit will be required

4. Physical Dimension : (Unit:mm)

TOP view

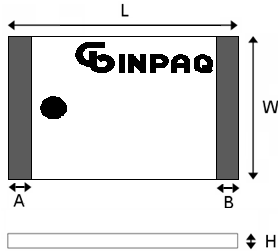

Bottom view



Chip Antenna	L	W	A	B	L1	W1	H
ACA5036	5.2±0.3	3.7±0.3	0.45±0.25	0.45±0.25	1.1±0.20	0.55±0.20	0.70±0.15

UNLESS OTHER SPECIFIED TOLERANCES ON :

X=± X.X=± X.XX=

ANGLES=± HOLEDIA=±

SCALE : -----

UNIT : mm

DRAWN BY : 黃琬珮

CHECKED BY : 楊奇峰

DESIGNED BY : 謝立庭

APPROVED BY : 蔡岳霖

TITLE : ACA-5036-A2-CC-S Specification



INPAQ TECHNOLOGY CO., LTD.

THIS DRAWINGS AND SPECIFICATIONS ARE THE PROPERTY OF INPAQ TECHNOLOGY CO.,LTD.AND SHALL NOT BE REPRODUCED OR USED AS THE BASIS FOR THE MANUFACTURE OR SALE OF APPARATUS OR DEVICES WITHOUT PERMISSION

DOCUMENT NO.

ENS000023010

SPEC REV.

A0

5. Recommend PCB Layout : (Unit:mm)

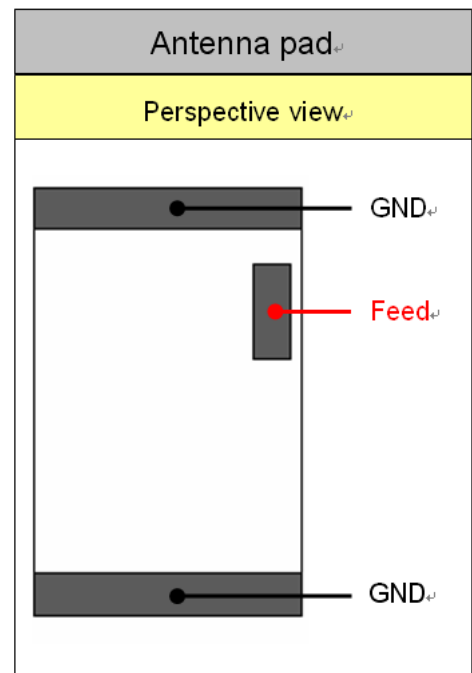
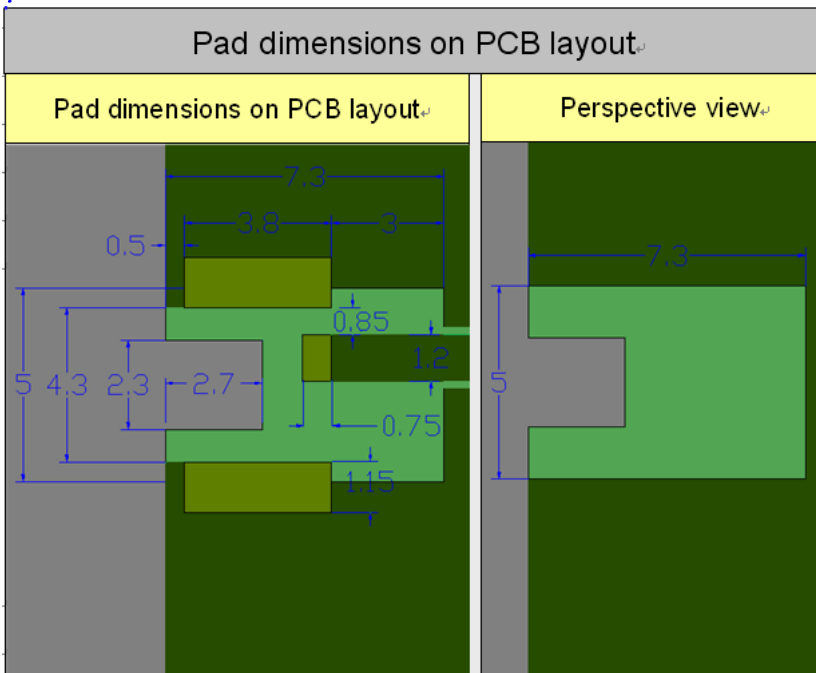
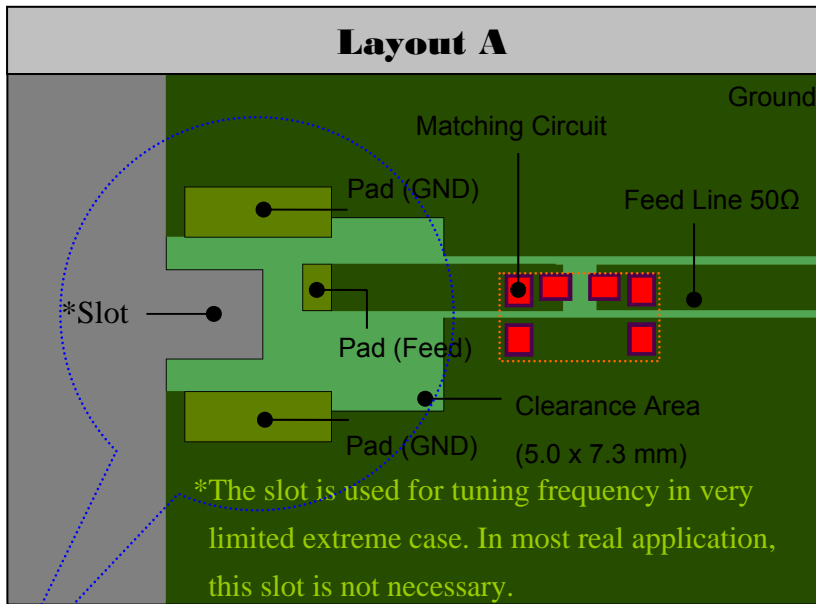

PCB pad dimensions

Terminal name	Terminal Dimensions
Pad (Feed)	1.2 X 0.75
Pad (GND)	3.8 X 1.15
Pad (GND)	3.8 X 1.15

Antenna pad dimensions

Terminal name	Terminal Dimensions
Feed	1.1 X 0.55
GND	3.7 X 0.45
GND	3.7 X 0.45

UNLESS OTHER SPECIFIED TOLERANCES ON :

X=± X.X=± X.XX=±
 ANGLES=± HOLEDIA=±



INPAQ TECHNOLOGY CO., LTD.

SCALE : -----

UNIT : mm

DRAWN BY : 黃琬珮

CHECKED BY : 楊奇峰

DESIGNED BY : 謝立庭

APPROVED BY : 蔡岳霖

THIS DRAWINGS AND SPECIFICATIONS ARE THE PROPERTY OF INPAQ TECHNOLOGY CO.,LTD.AND SHALL NOT BE REPRODUCED OR USED AS THE BASIS FOR THE MANUFACTURE OR SALE OF APPARATUS OR DEVICES WITHOUT PERMISSION

TITLE : ACA-5036-A2-CC-S Specification

DOCUMENT NO.

ENS000023010

SPEC REV.

A0

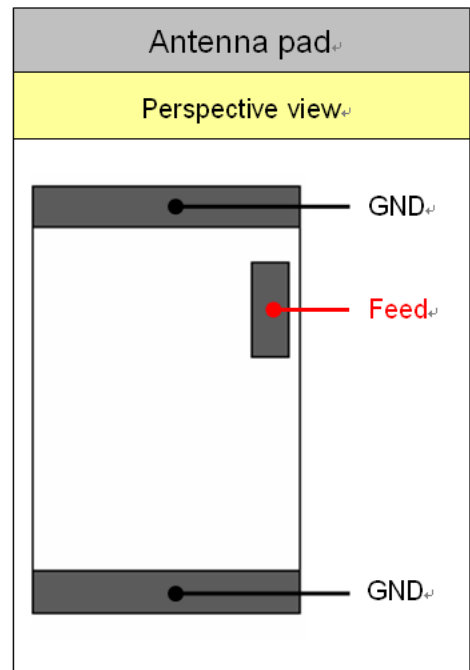
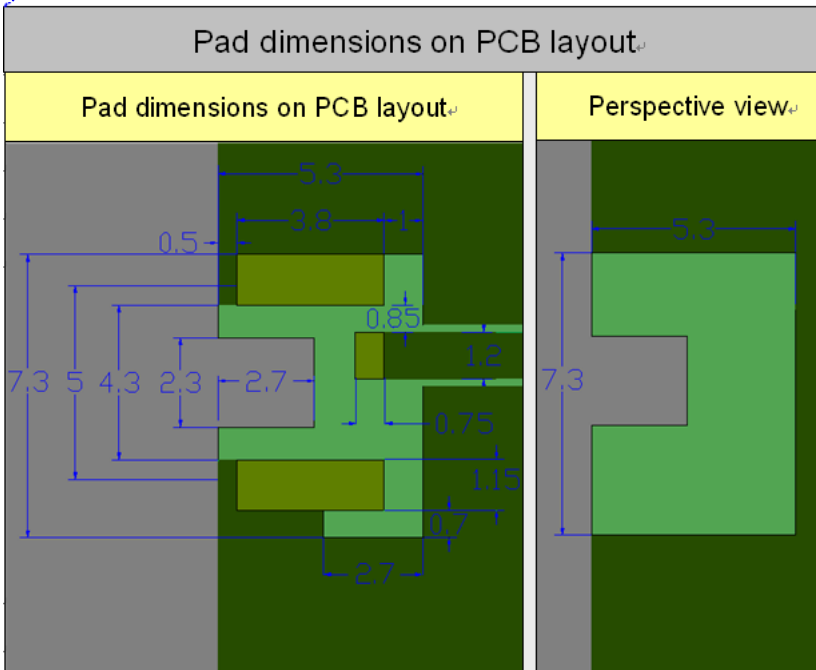
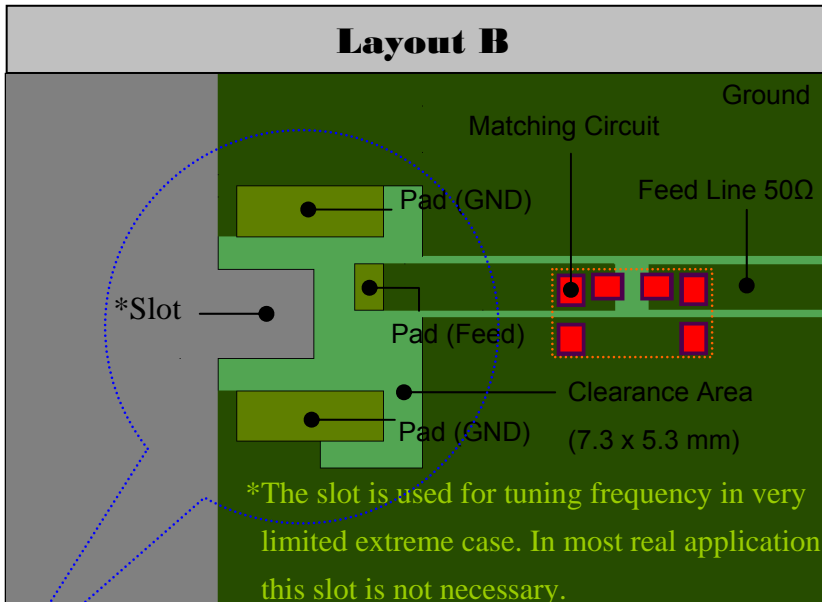

PCB pad dimensions

Terminal name	Terminal Dimensions
Pad (Feed)	1.2 X 0.75
Pad (GND)	3.8 X 1.15
Pad (GND)	3.8 X 1.15

Antenna pad dimensions

Terminal name	Terminal Dimensions
Feed	1.1 X 0.55
GND	3.7 X 0.45
GND	3.7 X 0.45

UNLESS OTHER SPECIFIED TOLERANCES ON :

X=± X.X=± X.XX=±
 ANGLES=± HOLEDIA=±



INPAQ TECHNOLOGY CO., LTD.

SCALE : -----

UNIT : mm

DRAWN BY : 黃琬珮

CHECKED BY : 楊奇峰

DESIGNED BY : 謝立庭

APPROVED BY : 蔡岳霖

THIS DRAWINGS AND SPECIFICATIONS ARE THE PROPERTY OF INPAQ TECHNOLOGY CO.,LTD.AND SHALL NOT BE REPRODUCED OR USED AS THE BASIS FOR THE MANUFACTURE OR SALE OF APPARATUS OR DEVICES WITHOUT PERMISSION





TITLE : ACA-5036-A2-CC-S Specification

DOCUMENT NO.

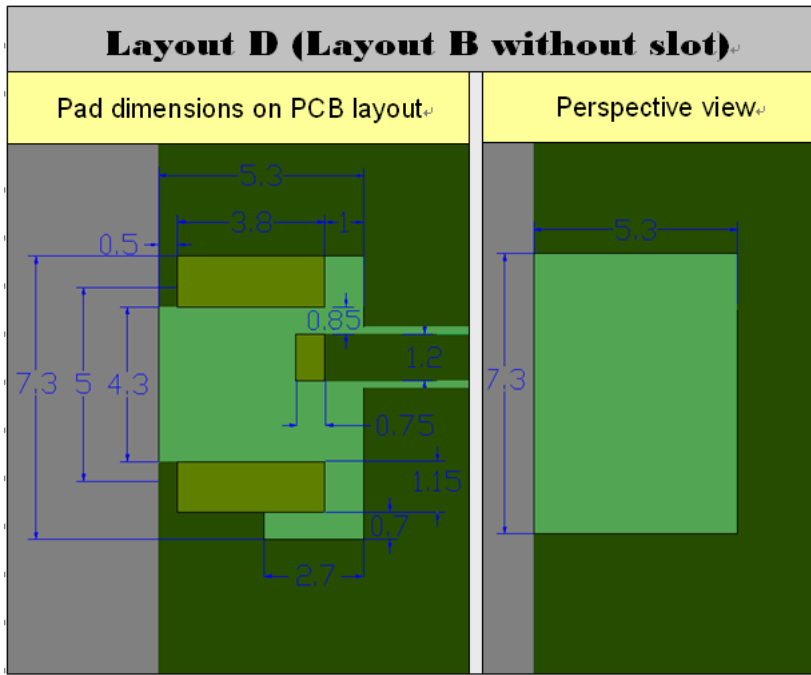
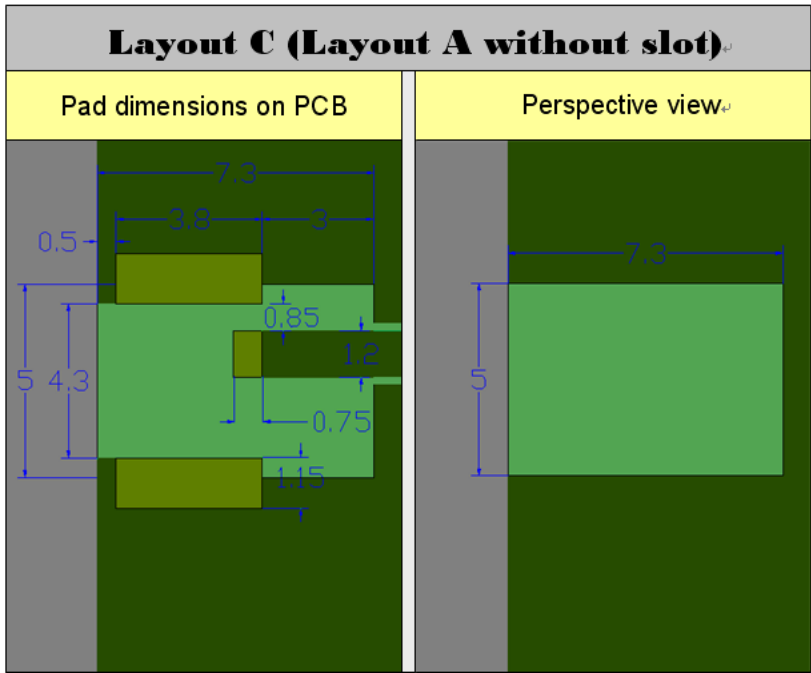
ENS000023010

SPEC REV.
A0



UNLESS OTHER SPECIFIED TOLERANCES ON : $X = \pm$ $X.X = \pm$ $X.XX =$ ANGLES = \pm HOLEDIA = \pm			INPAQ TECHNOLOGY CO., LTD.
SCALE : -----	UNIT : mm	THIS DRAWINGS AND SPECIFICATIONS ARE THE PROPERTY OF INPAQ TECHNOLOGY CO.,LTD.AND SHALL NOT BE REPRODUCED OR USED AS THE BASIS FOR THE MANUFACTURE OR SALE OF APPARATUS OR DEVICES WITHOUT PERMISSION	
DRAWN BY : 黃琬珮 	CHECKED BY : 楊奇峰 	DESIGNED BY : 謝立庭 	
TITLE : ACA-5036-A2-CC-S Specification		DOCUMENT NO.	ENS000023010
		SPEC REV.	A0

6. Electrical Characteristics :

Layout A : VSWR

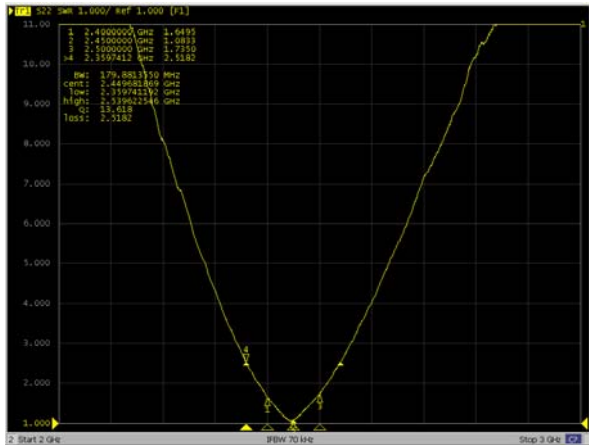

Mark	Frequency	VSWR
1	2400 MHz	1.65
2	2450 MHz	1.08
3	2500 MHz	1.73

Layout B : VSWR

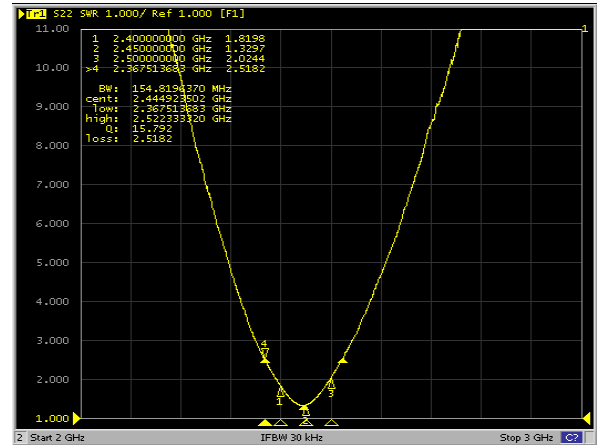

Mark	Frequency	VSWR
1	2400 MHz	1.82
2	2450 MHz	1.33
3	2500 MHz	2.02

Radiation Pattern

The Gain pattern is measured in INPAQ's FAR-field chamber. DUT is placed on the table of rotator, a standard horn antenna and Vector Network Analyzer is used to collect data.

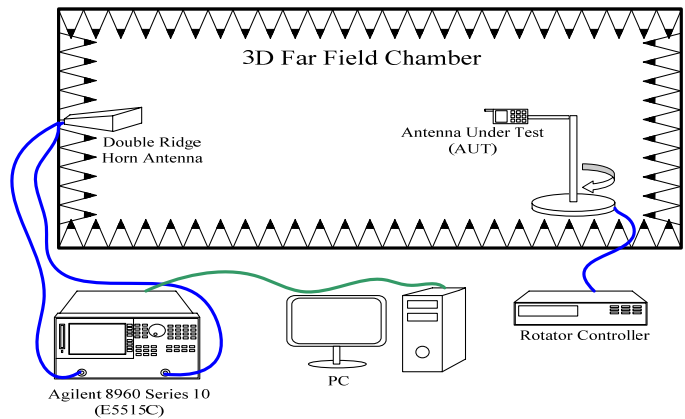
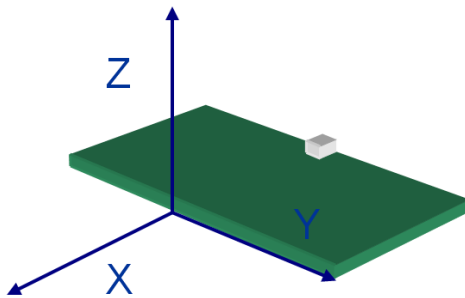

3D Chamber Definition

© 3D Gain Pattern (2450 MHz)

Layout A :

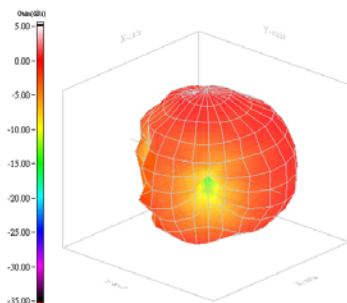

Layout B :

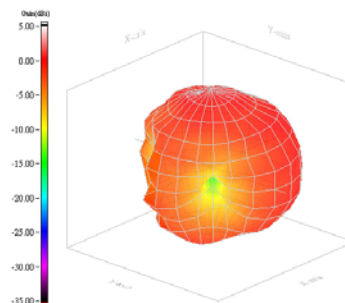

UNLESS OTHER SPECIFIED TOLERANCES ON :

X=± X.X=± X.XX=±

ANGLES=± HOLEDIA=±

SCALE : -----

UNIT : mm

DRAWN BY : 黃琬珮

CHECKED BY : 楊奇峰

DESIGNED BY : 謝立庭

APPROVED BY : 蔡岳霖

TITLE : ACA-5036-A2-CC-S Specification



INPAQ TECHNOLOGY CO., LTD.

THIS DRAWINGS AND SPECIFICATIONS ARE THE PROPERTY OF INPAQ TECHNOLOGY CO.,LTD.AND SHALL NOT BE REPRODUCED OR USED AS THE BASIS FOR THE MANUFACTURE OR SALE OF APPARATUS OR DEVICES WITHOUT PERMISSION

DOCUMENT NO.

ENS000023010

SPEC REV.

A0

© 2D Gain Pattern (2450 MHz)

X-Y Plane

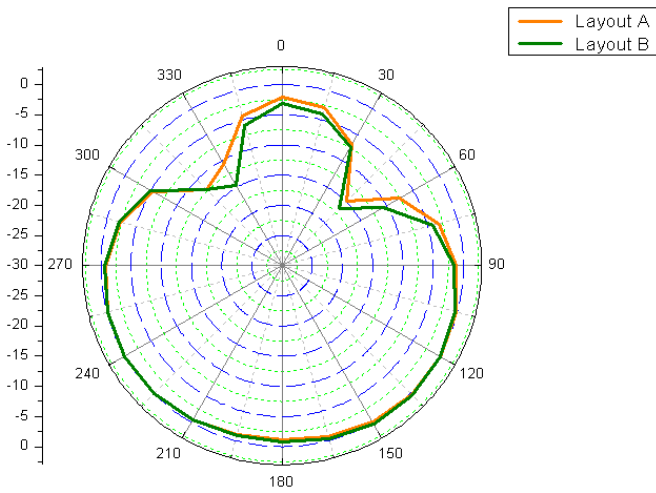

X-Z Plane

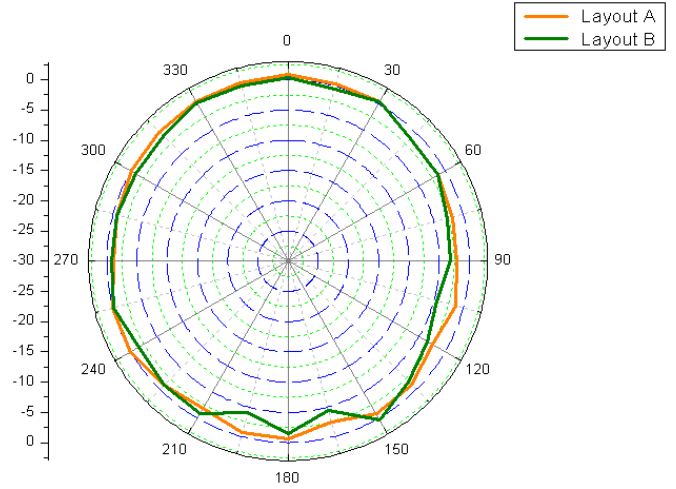

Y-Z Plane

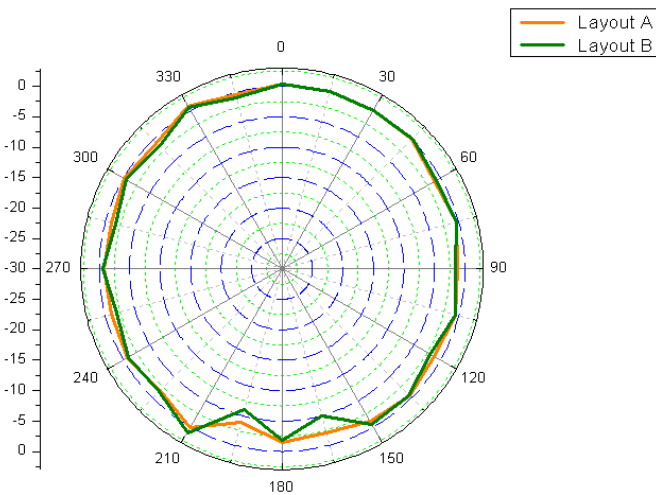

UNLESS OTHER SPECIFIED TOLERANCES ON :

X=± X.X=± X.XX=

ANGLES=± HOLEDIA=±

SCALE : -----

UNIT : mm

DRAWN BY : 黃琬珮

CHECKED BY : 楊奇峰

DESIGNED BY : 謝立庭

APPROVED BY : 蔡岳霖

TITLE : ACA-5036-A2-CC-S Specification



INPAQ TECHNOLOGY CO., LTD.

THIS DRAWINGS AND SPECIFICATIONS ARE THE PROPERTY OF INPAQ TECHNOLOGY CO.,LTD.AND SHALL NOT BE REPRODUCED OR USED AS THE BASIS FOR THE MANUFACTURE OR SALE OF APPARATUS OR DEVICES WITHOUT PERMISSION

DOCUMENT NO.

ENS000023010

SPEC REV.

A0

7. Taping Package and Label Marking: (unit: mm)

- (1) Quantity/Reel: 2000pcs/Reel
- (2) Carrier tape dimensions

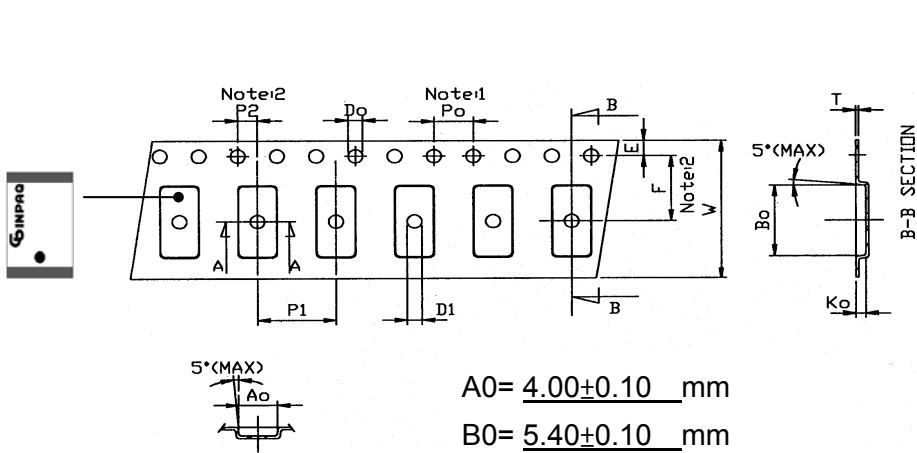

A-A SECTION

Unit: mm

Symbol	Spec.
K1	-
Po	4.0±0.10
P1	8.0±0.10
P2	2.0±0.10
Do	1.50 ^{+0.1} _{+0.}
D1	1.50(MIN)
E	1.75±0.10
F	7.50±0.10
10Po	40.0±0.10
W	16.0±0.20
T	0.30±0.10

$A0 = 4.00 \pm 0.10$ mm
 $B0 = 5.40 \pm 0.10$ mm
 $K0 = 1.02 \pm 0.10$ mm

Notice:

1. 10 Sprocket hole pitch cumulative tolerance is ±0.1mm
2. Pocket position relative to sprocket hole measured as true position of pocket not pocket hole.
3. A0 & B0 measured on a plane 0.3mm above the bottom of the pocket to top surface of the carrier.
4. K0 measured from a plane on the inside bottom of the pocket to the top surface of the carrier.
5. Carrier camber shall be not than 1mm per 100mm through a length of 250mm.

(3) Taping reel dimensions

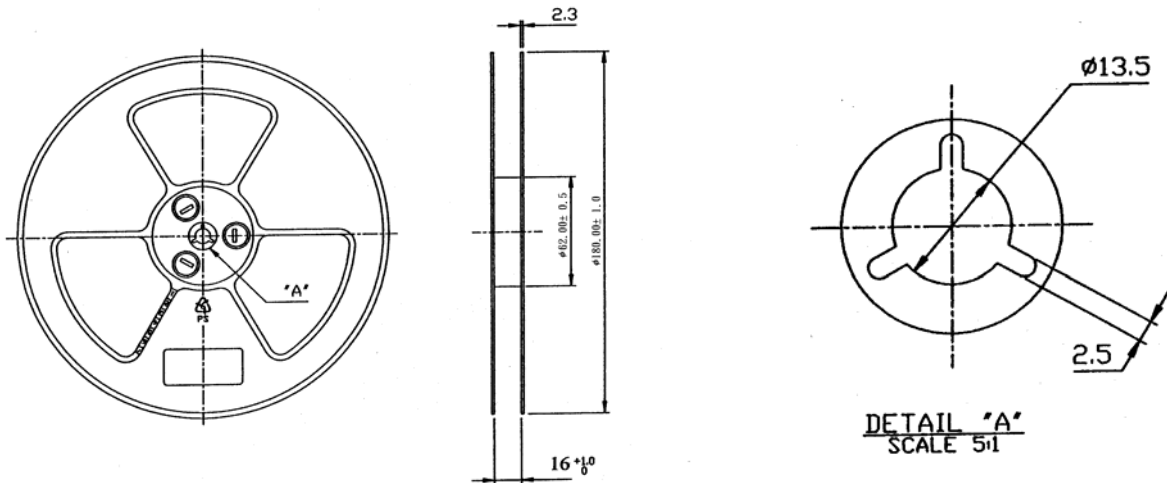

UNLESS OTHER SPECIFIED TOLERANCES ON :

$X = \pm$ $X.X = \pm$ $X.XX =$
 ANGLES = ± HOLEDIA = ±

SCALE : ----- UNIT : mm

DRAWN BY : 黃琬珮 CHECKED BY : 楊奇峰

DESIGNED BY : 謝立庭 APPROVED BY : 蔡岳霖

TITLE : ACA-5036-A2-CC-S Specification



INPAQ TECHNOLOGY CO., LTD.

THIS DRAWINGS AND SPECIFICATIONS ARE THE PROPERTY OF INPAQ TECHNOLOGY CO.,LTD.AND SHALL NOT BE REPRODUCED OR USED AS THE BASIS FOR THE MANUFACTURE OR SALE OF APPARATUS OR DEVICES WITHOUT PERMISSION

DOCUMENT NO.

ENS000023010

SPEC REV.

A0

8. Environmental Characteristics

(1) Reliability Test

Item	Condition	Specification
Thermal shock	1. 30±3 minutes at -40°C±5°C, 2. Convert to +105°C (5 minutes) 3. 30±3 minutes at +105°C±5°C, 4. Convert to -40°C (5 minutes) 5. Total 100 continuous cycles	No apparent damage Fulfill the electrical spec. after test.
Humidity resistance	1. Humidity: 85% R.H. 2. Temperature: 85±5°C 3. Time: 1000 hours.	No apparent damage Fulfill the electrical spec. after test.
High temperature resistance	1. Temperature: 150°C±5°C 2. Time: 1000 hours.	No apparent damage Fulfill the electrical spec. after test.
Low temperature resistance	1. Temperature: -40°C±5°C 2. Time: 1000 hours.	No apparent damage Fulfill the electrical spec. after test.
Soldering heat resistance	1. Solder bath temperature : 260±5°C 2. Bathing time: 10±1 seconds	No apparent damage
Solderability	The dipped surface of the terminal shall be at least 95% covered with solder after dipped in solder bath of 245±5°C for 3±1 seconds.	No apparent damage

(2) Storage condition

(a) At warehouse:

The temperature should be within 0 ~ 30°C and humidity should be less than 60% RH.

The product should be used within 1 year from the time of delivery.

(b) On board:

The temperature should be within -40~85°C and humidity should be less than 85% RH.

(3) Operating temperature range

Operating temperature range : -40°C to +105°C.

UNLESS OTHER SPECIFIED TOLERANCES ON :

X=± X.X=± X.XX=

ANGLES=± HOLEDIA=±

SCALE : -----

UNIT : mm

DRAWN BY : 黃琬珮 

CHECKED BY : 楊奇峰 

DESIGNED BY : 謝立庭 

APPROVED BY : 蔡岳霖 

TITLE : ACA-5036-A2-CC-S Specification



INPAQ TECHNOLOGY CO., LTD.

THIS DRAWINGS AND SPECIFICATIONS ARE THE PROPERTY OF INPAQ TECHNOLOGY CO.,LTD.AND SHALL NOT BE REPRODUCED OR USED AS THE BASIS FOR THE MANUFACTURE OR SALE OF APPARATUS OR DEVICES WITHOUT PERMISSION

DOCUMENT NO.

ENS000023010

SPEC REV.

A0

9. Recommended reflow soldering

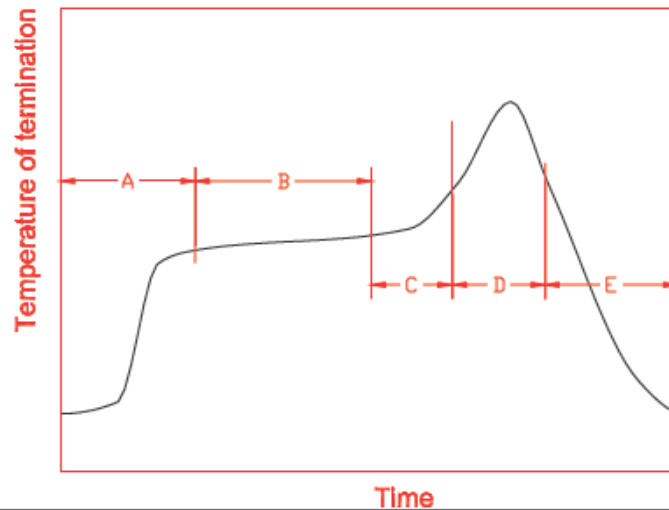

A	1 st rising temperature	The normal to Preheating temperature	30s to 60s
B	Preheating	140°C to 160°C	60s to 120s
C	2 nd rising temperature	Preheating to 200°C	20s to 40s
D	Main heating	if 220°C	50s~60s
		if 230°C	40s~50s
		if 240°C	30s~40s
		if 250°C	20s~40s
E	Regular cooling	200°C to 100°C	1°C/s ~ 4°C/s

*reference: J-STD-020C

(1) Soldering gun procedure

Note the follows, in case of using solder gun for replacement.

- The tip temperature must be less than 350°C for the period within 3 seconds by using soldering gun under 30 W.
- The soldering gun tip shall not touch this product directly.

(2) Soldering volume

Note that excess of soldering volume will easily get crack the body of this product.

UNLESS OTHER SPECIFIED TOLERANCES ON : X=± X.X=± X.XX=± ANGLES=± HOLEDIA=±			INPAQ TECHNOLOGY CO., LTD.	
SCALE : -----	UNIT : mm			
DRAWN BY : 黃琬珮 	CHECKED BY : 楊奇峰 	THIS DRAWINGS AND SPECIFICATIONS ARE THE PROPERTY OF INPAQ TECHNOLOGY CO.,LTD.AND SHALL NOT BE REPRODUCED OR USED AS THE BASIS FOR THE MANUFACTURE OR SALE OF APPARATUS OR DEVICES WITHOUT PERMISSION		
DESIGNED BY : 謝立庭 	APPROVED BY : 蔡岳霖 			
TITLE : ACA-5036-A2-CC-S Specification		DOCUMENT NO.	ENS000023010	SPEC REV. A0