

DFS Test Report

Report No.: RFBBQZ-WTW-P22110099-2

FCC ID: PY323100586

Model No.: RS700

Received Date: 2023/2/14

Test Date: 2023/4/12 ~ 2023/4/19

Issued Date: 2023/5/24

**Applicant and
Manufacturer:** NETGEAR, INC.

Address: 350 East Plumeria Drive San Jose, CA 95134

Issued By: Bureau Veritas Consumer Products Services (H.K.) Ltd., Taoyuan Branch
Lin Kou Laboratories

Lab Address: No. 47-2, 14th Ling, Chia Pau Vil., Lin Kou Dist., New Taipei City, Taiwan

Test Location: No. 19, Hwa Ya 2nd Rd., Wen Hwa Vil., Kwei Shan Dist., Taoyuan City
33383, TAIWAN

**FCC Registration /
Designation Number:** 788550 / TW0003



This report is governed by, and incorporates by reference, the Conditions of Testing as posted at the date of issuance of this report at <http://www.bureauveritas.com/home/about-us/our-business/cps/about-us/terms-conditions/> and is intended for your exclusive use. Any copying or replication of this report to or for any other person or entity, or use of our name or trademark, is permitted only with our prior written permission. This report sets forth our findings solely with respect to the test samples identified herein. The results set forth in this report are not indicative or representative of the quality or characteristics of the lot from which a test sample was taken or any similar or identical product unless specifically and expressly noted. Our report includes all of the tests requested by you and the results thereof based upon the information that you provided to us. Measurement uncertainty is only provided upon request for accredited tests. Statements of conformity are based on simple acceptance criteria without taking measurement uncertainty into account, unless otherwise requested in writing. You have 60 days from date of issuance of this report to notify us of any material error or omission caused by our negligence or if you require measurement uncertainty; provided, however, that such notice shall be in writing and shall specifically address the issue you wish to raise. A failure to raise such issue within the prescribed time shall constitute your unqualified acceptance of the completeness of this report, the tests conducted and the correctness of the report contents.

Table of Contents

Release Control Record	3
1 Certificate of Conformity	4
2 EUT Information	5
2.1 Operating Frequency Bands and Mode of EUT.....	5
2.2 EUT Software and Firmware Version.....	5
2.3 Description of Available Antennas to the EUT.....	5
2.4 EUT Maximum Conducted Power.....	6
2.5 EUT Maximum E.I.R.P. Power.....	8
2.6 Transmit Power Control (TPC).....	9
2.7 Statement of Manufacturer.....	9
3 U-NII DFS Rule Requirements	10
3.1 Working Modes and Required Test Items.....	10
3.2 Test Limits and Radar Signal Parameters.....	11
4 Test & Support Equipment List	14
4.1 Test Instruments.....	14
4.2 Description of Support Units.....	14
5 Test Procedure	15
5.1 DFS Measurement System.....	15
5.2 Calibration of DFS Detection Threshold Level.....	16
5.3 Deviation from Test Standard.....	16
5.4 Conducted Test Setup Configuration.....	17
5.4.1 Master Mode.....	17
6 Test Results	18
6.1 Summary of Test Results.....	18
6.1.1 Master mode.....	18
6.2 Test Results.....	19
6.2.1 Test Mode: Device Operating In Master Mode.....	19
6.2.2 Detection Bandwidth.....	24
6.2.3 Channel Availability Check Time.....	39
6.2.4 Channel Closing Transmission and Channel Move Time.....	41
6.2.5 Non-Occupancy Period.....	88
6.2.9 Non- Co-Channel Test.....	91
6.2.10 Uniform Spreading.....	91
7 Information of the Testing Laboratories	92
Appendix-A	93

Release Control Record

Issue No.	Description	Date Issued
RFBBQZ-WTW-P22110099-2	Original release.	2023/5/24

1 Certificate of Conformity

Product: Tri-band WiFi 7 11be WiFi Router

Brand: NETGEAR

Test Model: RS700

Sample Status: Engineering sample

Applicant: NETGEAR, Inc.

Test Date: 2023/4/12 ~ 2023/4/19

Standards: FCC Part 15, Subpart E (Section 15.407)

References Test Guidance: KDB 905462 D02 UNII DFS Compliance Procedures New Rules v02

The above equipment has been tested by **Bureau Veritas Consumer Products Services (H.K.) Ltd., Taoyuan Branch**, and found compliance with the requirement of the above standards. The test record, data evaluation & Equipment Under Test (EUT) configurations represented herein are true and accurate accounts of the measurements of the sample's RF characteristics under the conditions specified in this report.

Prepared by : Celine Chou , **Date:** 2023/5/24
Celine Chou / Senior Specialist

Approved by : Jeremy Lin , **Date:** 2023/5/24
Jeremy Lin / Project Engineer

2 EUT Information

2.1 Operating Frequency Bands and Mode of EUT

Table 1: Operating Frequency Bands and Mode of EUT

Operational Mode	Operating Frequency Range	
	5250~5350MHz	5470~5725MHz
Master	✓	✓

2.2 EUT Software and Firmware Version

Table 2: The EUT Software/Firmware Version

No.	Product	Test Model No.	Software/Firmware Version
1	Tri-band WiFi 7 11be WiFi Router	RS700	V1.0.2.26_2.0.53

2.3 Description of Available Antennas to the EUT

Table 3: Antenna Gain

Antenna Type	Dipole
Connector Type	ipex(MHF)
Antenna Gain	Directional Gain (dBi)
5250~5350 MHz	6.05
5470~5725 MHz	6.03

* The detailed antenna information, please refer to the BV CPS report no.: RFBBQZ-WTW-P22110099-6.

2.4 EUT Maximum Conducted Power

Table 4: The Measured Conducted Output Power

CDD Mode

802.11a

Frequency Band (MHz)	Max. Power	
	Output Power (dBm)	Output Power (mW)
5250~5350	23.31	214.374
5470~5725	23.38	217.921

802.11be (EHT20)

Frequency Band (MHz)	Max. Power	
	Output Power (dBm)	Output Power (mW)
5250~5350	23.32	214.549
5470~5725	23.36	216.556

802.11be (EHT40)

Frequency Band (MHz)	Max. Power	
	Output Power (dBm)	Output Power (mW)
5250~5350	23.28	212.704
5470~5725	23.29	213.193

802.11be (EHT80)

Frequency Band (MHz)	Max. Power	
	Output Power (dBm)	Output Power (mW)
5250~5350	23.33	215.267
5470~5725	23.36	217.008

802.11be (EHT160)

Frequency Band (MHz)	Max. Power	
	Output Power (dBm)	Output Power (mW)
5250~5350	19.71	93.511
5470~5725	23.25	211.527

Beamforming Mode

802.11be (EHT20)

Frequency Band (MHz)	Max. Power	
	Output Power (dBm)	Output Power (mW)
5250~5350	23.32	214.549
5470~5725	23.36	216.556

802.11be (EHT40)

Frequency Band (MHz)	Max. Power	
	Output Power (dBm)	Output Power (mW)
5250~5350	23.28	212.704
5470~5725	23.29	213.193

802.11be (EHT80)

Frequency Band (MHz)	Max. Power	
	Output Power (dBm)	Output Power (mW)
5250~5350	23.33	215.267
5470~5725	23.36	217.008

802.11be (EHT160)

Frequency Band (MHz)	Max. Power	
	Output Power (dBm)	Output Power (mW)
5250~5350	19.71	93.511
5470~5725	23.25	211.527

2.5 EUT Maximum E.I.R.P. Power

Table 5: The EIRP Output Power List

CDD Mode

802.11a

Frequency Band (MHz)	Max. EIRP Power	
	Output Power (dBm)	Output Power (mW)
5250~5350	26.11	408.319
5470~5725	26.28	424.620

802.11be (EHT20)

Frequency Band (MHz)	Max. EIRP Power	
	Output Power (dBm)	Output Power (mW)
5250~5350	26.12	409.261
5470~5725	26.26	422.669

802.11be (EHT40)

Frequency Band (MHz)	Max. EIRP Power	
	Output Power (dBm)	Output Power (mW)
5250~5350	26.08	405.509
5470~5725	26.19	415.911

802.11be (EHT80)

Frequency Band (MHz)	Max. EIRP Power	
	Output Power (dBm)	Output Power (mW)
5250~5350	26.13	410.204
5470~5725	26.26	422.669

802.11be (EHT160)

Frequency Band (MHz)	Max. EIRP Power	
	Output Power (dBm)	Output Power (mW)
5250~5350	22.51	178.238
5470~5725	26.15	412.098

Beamforming Mode

802.11be (EHT20)

Frequency Band (MHz)	Max. EIRP Power	
	Output Power (dBm)	Output Power (mW)
5250~5350	29.37	864.968
5470~5725	29.39	868.960

802.11be (EHT40)

Frequency Band (MHz)	Max. EIRP Power	
	Output Power (dBm)	Output Power (mW)
5250~5350	29.33	857.038
5470~5725	29.32	855.067

802.11be (EHT80)

Frequency Band (MHz)	Max. EIRP Power	
	Output Power (dBm)	Output Power (mW)
5250~5350	29.38	866.962
5470~5725	29.39	868.960

802.11be (EHT160)

Frequency Band (MHz)	Max. EIRP Power	
	Output Power (dBm)	Output Power (mW)
5250~5350	25.76	376.704
5470~5725	29.28	847.227

2.6 Transmit Power Control (TPC)

U-NII devices operating in the 5.25-5.35 GHz band and the 5.47-5.725 GHz band shall employ a TPC mechanism. The U-NII device is required to have the capability to operate at least 6 dB below the mean EIRP value of 30 dBm. A TPC mechanism is not required for systems with an e.i.r.p. of less than 500 mW.

Maximum EIRP of this device is **868.960mW** which greater than 500mW, therefore it's require TPC function.

The UUT can adjust a transmitter's output power based on the signal level present at the receiver. TPC is auto controlled by software

Applicable	E.I.R.P	FCC 15.407 (h)(1)
√	>500mW	The TPC mechanism is required for system with an E.I.R.P of above 500mW
	<500mW	The TPC mechanism is not required for system with an E.I.R.P of less 500mW

2.7 Statement of Manufacturer

Manufacturer statement confirming that information regarding the parameters of the detected Radar Waveforms is not available to the end user.

3 U-NII DFS Rule Requirements

3.1 Working Modes and Required Test Items

The manufacturer shall state whether the UUT is capable of operating as a Master and/or a Client. If the UUT is capable of operating in more than one operating mode then each operating mode shall be tested separately. See tables 6 and 7 for the applicability of DFS requirements for each of the operational modes.

Table 6: Applicability of DFS Requirements Prior To Use a Channel

Requirement	Operational Mode		
	Master	Client without radar detection	Client with radar detection
Non-Occupancy Period	✓	✓ note	✓
DFS Detection Threshold	✓	Not required	✓
Channel Availability Check Time	✓	Not required	Not required
U-NII Detection Bandwidth	✓	Not required	✓

Note: Per KDB 905462 D03 UNII Clients Without Radar Detection New Rules v01r02 section (b)(5/6), If the client moves with the master, the device is considered compliant if nothing appears in the client non-occupancy period test. For devices that shut down (rather than moving channels), no beacons should appear. An analyzer plot that contains a single 30-minute sweep on the original channel.

Table 7: Applicability of DFS Requirements during Normal Operation.

Requirement	Operational Mode	
	Master or Client with radar detection	Client without radar detection
DFS Detection Threshold	✓	Not required
Channel Closing Transmission Time	✓	✓
Channel Move Time	✓	✓
U-NII Detection Bandwidth	✓	Not required

Additional requirements for devices with multiple bandwidth modes	Master or Client with radar detection	Client without radar detection
U-NII Detection Bandwidth and Statistical Performance Check	All BW modes must be tested	Not required
Channel Move Time and Channel Closing Transmission Time	Test using widest BW mode available	Test using the widest BW mode available for the link
All other tests	Any single BW mode	Not required

Note: Frequencies selected for statistical performance check (Section 7.8.4) should include several frequencies within the radar detection bandwidth and frequencies near the edge of the radar detection bandwidth. For 802.11 devices it is suggested to select frequencies in each of the bonded 20 MHz channels and the channel center frequency.

3.2 Test Limits and Radar Signal Parameters

Detection Threshold Values

Table 8: DFS Detection Thresholds for Master Devices And Client Devices With Radar Detection

Maximum Transmit Power	Value (See Notes 1, 2, and 3)
EIRP \geq 200 milliwatt	-64 dBm
EIRP < 200 milliwatt and power spectral density < 10 dBm/MHz	-62 dBm
EIRP < 200 milliwatt that do not meet the power spectral density requirement	-64 dBm

Note 1: This is the level at the input of the receiver assuming a 0 dBi receive antenna.

Note 2: Throughout these test procedures an additional 1 dB has been added to the amplitude of the test transmission waveforms to account for variations in measurement equipment. This will ensure that the test signal is at or above the detection threshold level to trigger a DFS response.

Note3: EIRP is based on the highest antenna gain. For MIMO devices refer to KDB Publication 662911 D01.

Table 9: DFS Response Requirement Values

Parameter	Value
Non-occupancy period	Minimum 30 minutes
Channel Availability Check Time	60 seconds
Channel Move Time	10 seconds See Note 1.
Channel Closing Transmission Time	200 milliseconds + an aggregate of 60 milliseconds over remaining 10 second period. See Notes 1 and 2.
U-NII Detection Bandwidth	Minimum 100% of the U-NII 99% transmission power bandwidth. See Note 3

Note 1: Channel Move Time and the Channel Closing Transmission Time should be performed with Radar Type 0. The measurement timing begins at the end of the Radar Type 0 burst.

Note 2: The Channel Closing Transmission Time is comprised of 200 milliseconds starting at the beginning of the Channel Move Time plus any additional intermittent control signals required to facilitate a Channel move (an aggregate of 60 milliseconds) during the remainder of the 10 second period. The aggregate duration of control signals will not count quiet periods in between transmissions.

Note 3: During the U-NII Detection Bandwidth detection test, radar type 0 should be used. For each frequency step the minimum percentage of detection is 90 percent. Measurements are performed with no data traffic.

Parameters of DFS Test Signals

Step intervals of 0.1 microsecond for Pulse Width, 1 microsecond for PRI, 1 MHz for chirp width and 1 for the number of pulses will be utilized for the random determination of specific test waveforms.

Table 10: Short Pulse Radar Test Waveforms

Radar Type	Pulse Width (μsec)	PRI (μsec)	Number of Pulses	Minimum Percentage of Successful Detection	Minimum Number of Trials
0	1	1428	18	See Note 1	See Note 1
1	1	Test A: 15 unique PRI values randomly selected from the list of 23 PRI values in Table 5a ----- Test B: 15 unique PRI values randomly selected within the range of 518-3066 μ sec, with a minimum increment of 1 μ sec, excluding PRI values selected in Test A	$\text{Roundup} \left\{ \begin{array}{l} \left(\frac{1}{360} \right) \\ \left(\frac{19 \cdot 10^6}{\text{PRI}_{\mu\text{sec}}} \right) \end{array} \right\}$	60%	30
2	1-5	150-230	23-29	60%	30
3	6-10	200-500	16-18	60%	30
4	11-20	200-500	12-16	60%	30
Aggregate (Radar Types 1-4)				80%	120
Note 1: Short Pulse Radar Type 0 should be used for the detection bandwidth test, channel move time, and channel closing time tests.					

Table 11: Long Pulse Radar Test Waveform

Radar Type	Pulse Width (μsec)	Chirp Width (MHz)	PRI (μsec)	Number Of Pulses Per Burst	Number Of Bursts	Minimum Percentage Of Successful Detection	Minimum Number Of Trials
5	50-100	5-20	1000-2000	1-3	8-20	80%	30

Three subsets of trials will be performed with a minimum of ten trials per subset. The subset of trials differ in where the Long Pulse Type 5 Signal is tuned in frequency.

- a) the Channel center frequency
- b) tuned frequencies such that 90% of the Long Pulse Type 5 frequency modulation is within the low edge of the UUT Occupied Bandwidth
- c) tuned frequencies such that 90% of the Long Pulse Type 5 frequency modulation is within the high edge of the UUT Occupied Bandwidth

It include 10 trails for every subset, the formula as below,

For subset case 1: the center frequency of the signal generator will remain fixed at the center of the UUT Channel.

For subset case 2: to retain 90% frequency overlap between the radar signal and the UUT Occupied Bandwidth, the center frequency of the signal generator will vary for each of the ten trials in subset case 2. The center frequency of the signal generator for each trial is calculated by:

$$FL+(0.4*Chirp\ Width\ [in\ MHz])$$

For subset case 3: to retain 90% frequency overlap between the radar signal and the UUT Occupied Bandwidth, the center frequency of the signal generator will vary for each of the ten trials in subset case 3. The center frequency of the signal generator for each trial is calculated by:

$$FH-(0.4*Chirp\ Width\ [in\ MHz])$$

Table 12: Frequency Hopping Radar Test Waveform

Radar Type	Pulse Width (μsec)	PRI (μsec)	Pulses per Hop	Hopping Rate (kHz)	Hopping Sequence Length (msec)	Minimum Percentage Of Successful Detection	Minimum Number Of Trials
6	1	333	9	0.333	300	70%	30

4 Test & Support Equipment List

4.1 Test Instruments

Table 13: Test Instruments List

Description	Brand	Model No.	Serial No.	Cal. Date	Cal. Due
Spectrum analyzer	R&S	ESR	101451	Mar. 27, 2023	Mar. 26, 2024
Signal generator	KEYSIGHT	MXG	MY53052282	Jan. 06, 2023	Jan. 05, 2024
Horn antenna	Schwarzbeck	BBHA 9120 D	9120D-563	Nov. 13, 2022	Nov. 12, 2023
RF coaxial cable	HUBER SUHNER	SUCOFLEX 104	CABLE-DFS-01-254644	NA	NA

Note: Calibrate the RF coaxial cable before each test and use the radiation or conducted method to calibrate the reference FCC KDB 412172 standard.

4.2 Description of Support Units

Table 14: Support Unit Information.

No.	Product	Brand	Model No.	FCC ID	Spec.
1	Tri-band WiFi 7 11be WiFi Router	NETGEAR	RS700	PY323100586	5G Ant gain : 2.9dBi Maximum EIRP : 26.28dBm

Note: This device No.1 was functioned as a Master Slave device during the DFS Master test.

Table 15: Software/Firmware Information.

No.	Product	Model No.	Software/Firmware Version
1	Tri-band WiFi 7 11be WiFi Router	NETGEAR	V1.0.0.22_2.0.49

Note: This device No.1 was functioned as a Master Slave device during the DFS Master test.

5 Test Procedure

5.1 DFS Measurement System

A complete DFS Measurement System consists of two subsystems: (1) the Radar Signal Generating system and (2) the Traffic Monitoring system. The control PC is necessary for generating the Radar waveforms in Table 10, 11 and 12. The traffic monitoring subsystem is specified to the type of unit under test (UUT).

Conducted Setup Configuration of DFS Measurement System

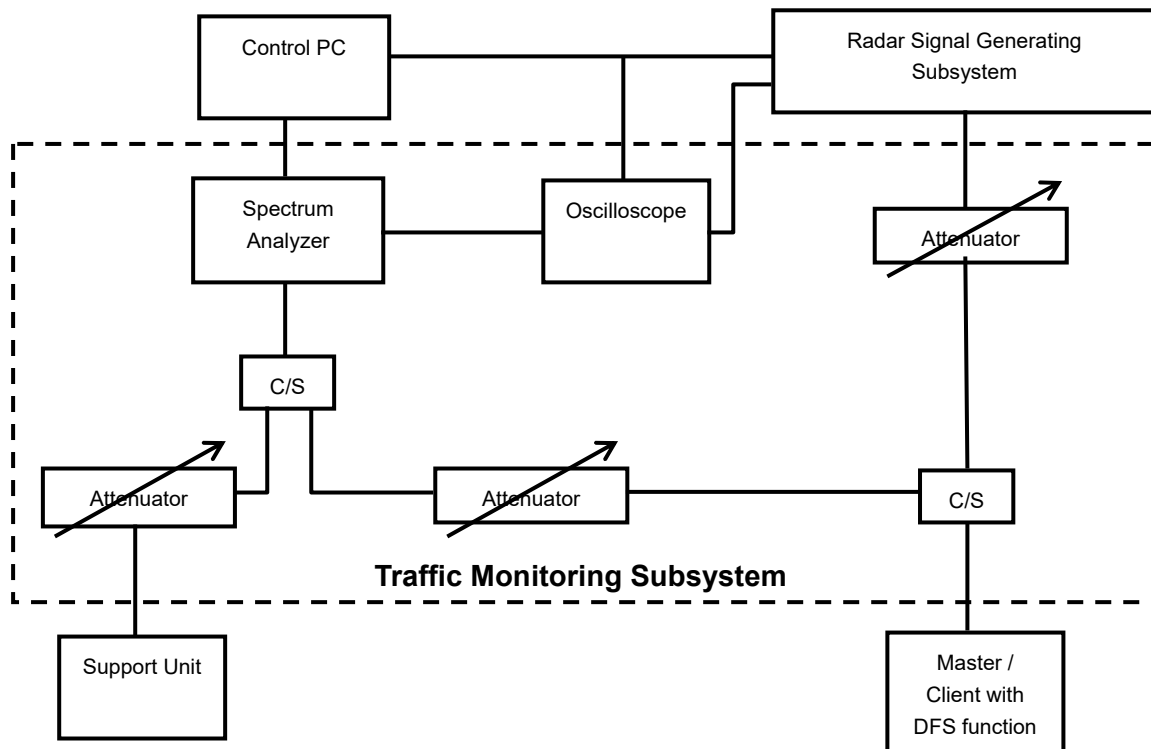

Channel Loading

System testing will be performed with channel-loading using means appropriate to the data types that are used by the unlicensed device. The following requirements apply:

	a) The data file must be of a type that is typical for the device (i.e., MPEG-2, MPEG-4, WAV, MP3, MP4, AVI, etc.) and must generally be transmitting in a streaming mode.
	b) Software to ping the client is permitted to simulate data transfer but must have random ping intervals.
V	c) Timing plots are required with calculations demonstrating a minimum channel loading of approximately 17% or greater.
	d) Unicast or Multicast protocols are preferable but other protocols may be used. The appropriate protocol used must be described in the test procedures.

5.2 Calibration of DFS Detection Threshold Level

The measured channel is 5500MHz and 5510MHz and 5530MHz and 5250MHz and 5570MHz. The radar signal was the same as transmitted channels, and injected into the antenna of AP (master) or Client Device with Radar Detection, measured the channel closing transmission time and channel move time.

Conducted setup configuration of Calibration of DFS Detection Threshold Level

The radar signal generate system is generating waveform pattern of radar types. The amplitude of the radar signal generator system is adjusted to yield a level of -64 dBm as measured on the spectrum analyzer. The interference detection threshold level is lower than -64dBm hence it provides margin to the limit.

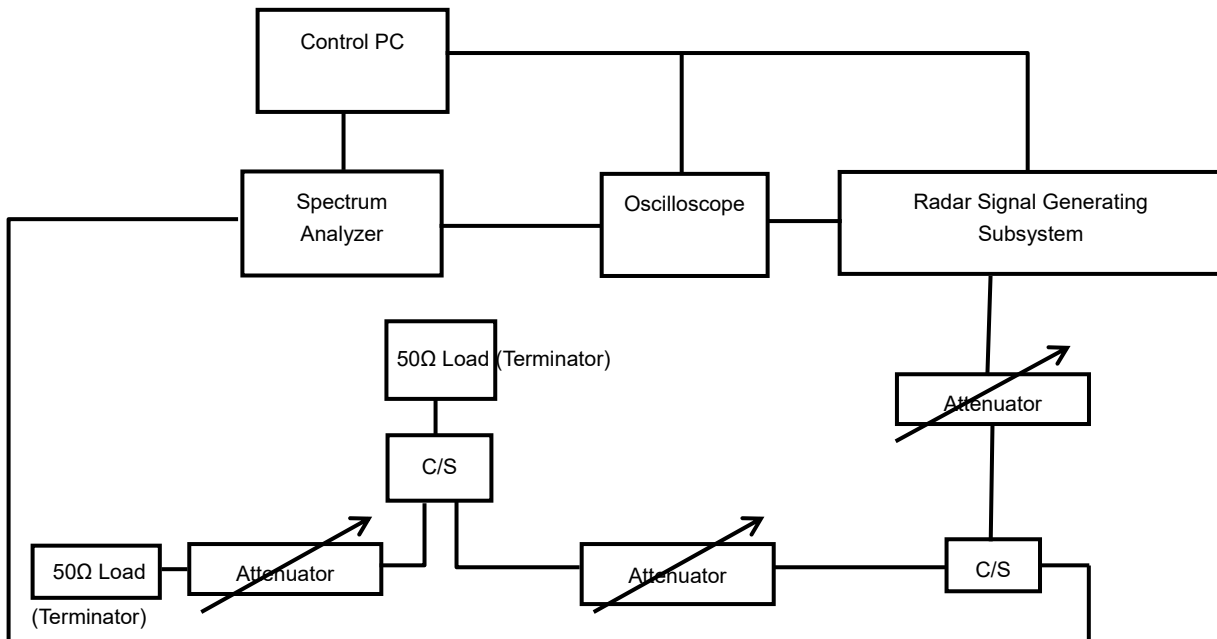

5.3 Deviation from Test Standard

No deviation.

5.4 Conducted Test Setup Configuration

5.4.1 Master Mode

The EUT is a U-NII Device operating in Master mode. The radar test signals are injected into the Master Device.

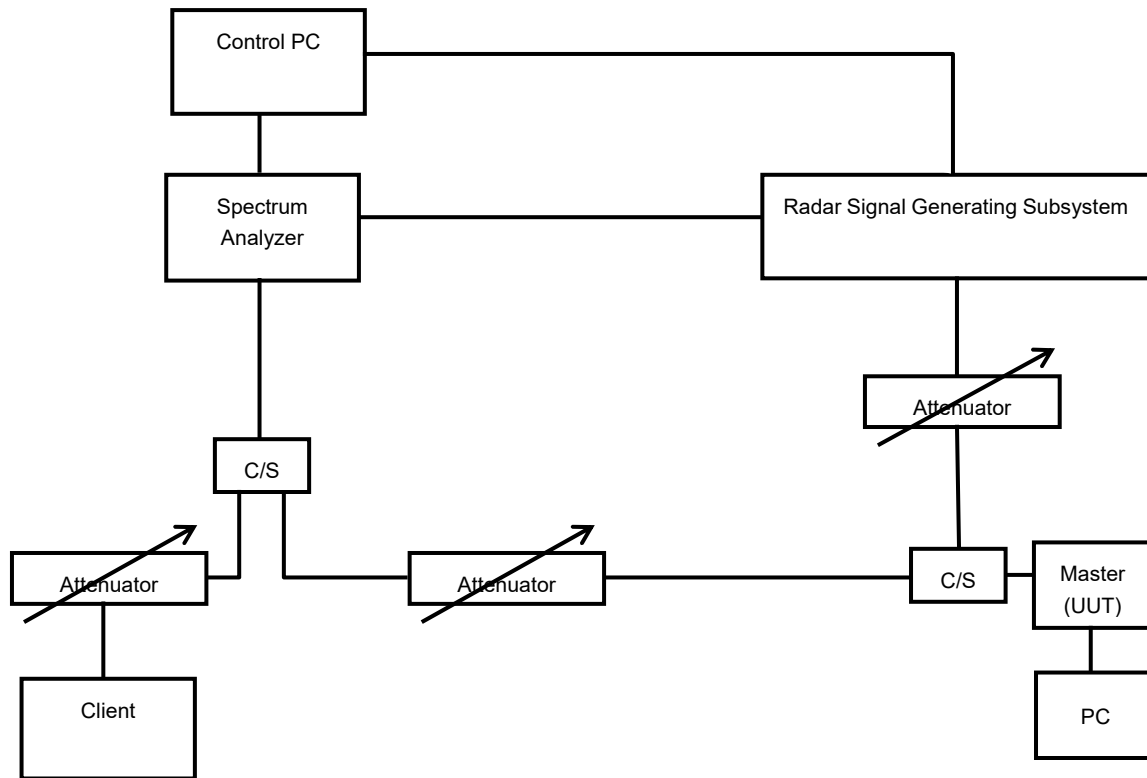

6 Test Results

6.1 Summary of Test Results

6.1.1 Master mode

Clause	Test Parameter	Remarks	Pass/Fail
15.407	DFS Detection Threshold	Applicable	Pass
15.407	U-NII Detection Bandwidth	Applicable	Pass
15.407	Channel Availability Check Time	Applicable	Pass
15.407	Channel Move Time	Applicable	Pass
15.407	Channel Closing Transmission Time	Applicable	Pass
15.407	Non- Occupancy Period	Applicable	Pass
15.407	Uniform Spreading	Applicable	Pass

Note: Determining compliance based on the results of the compliance measurement, not taking into account measurement instrumentation uncertainty.

6.2 Test Results

6.2.1 Test Mode: Device Operating In Master Mode

The radar test waveforms are injected into the Master.

DFS Detection Threshold

For detection threshold level of -64dBm, the tested level is lower than required level for 1dB, hence it provides margin to the limit. For detection threshold level of -64dBm, the required signal strength at AP antenna location is -64 dBm. The tested level is lower than required level for 1dB, hence it provides margin to the limit.

For radar burst signal level at the UUT antenna connector is $-64 + 2.5 = -61.5$ dBm

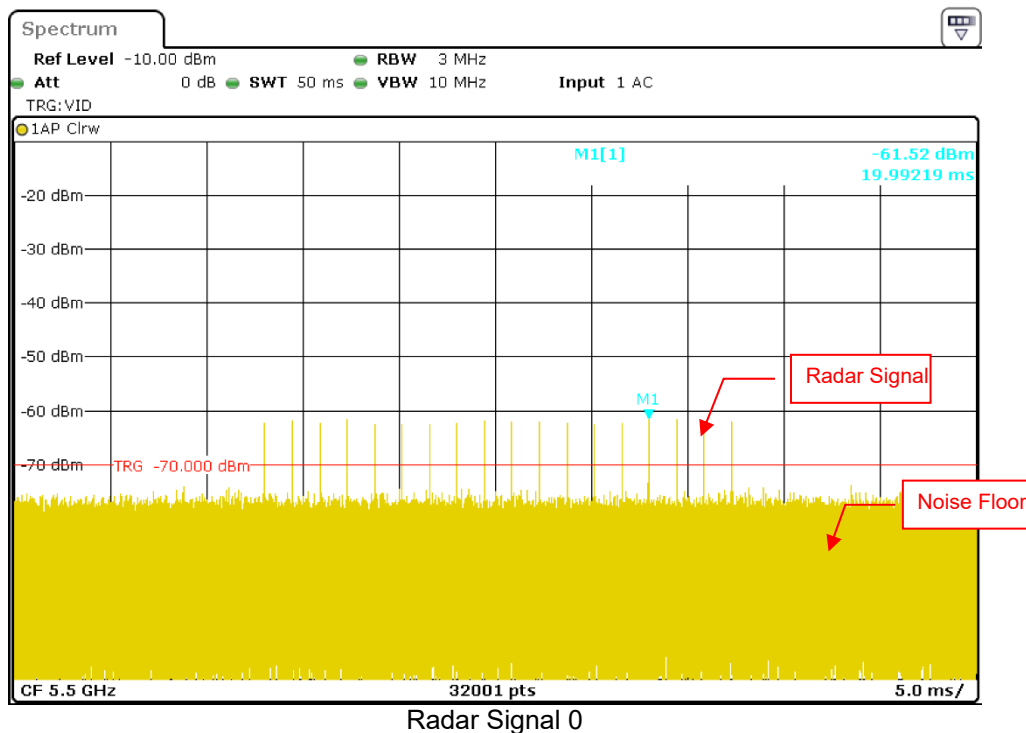

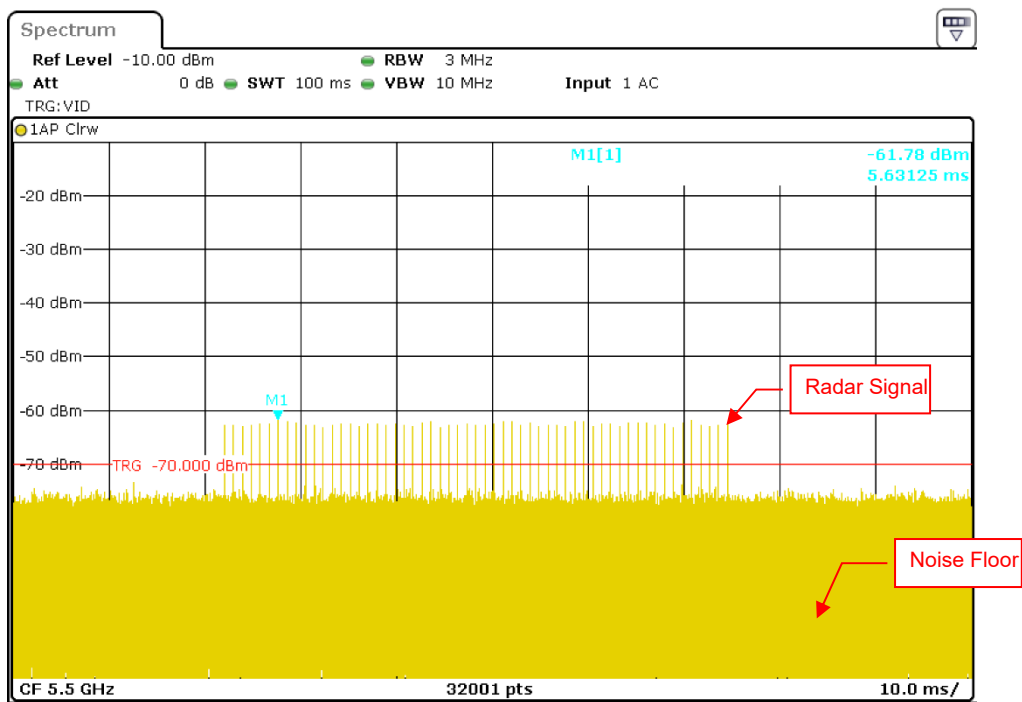

Radar Signal 1 (Test A)

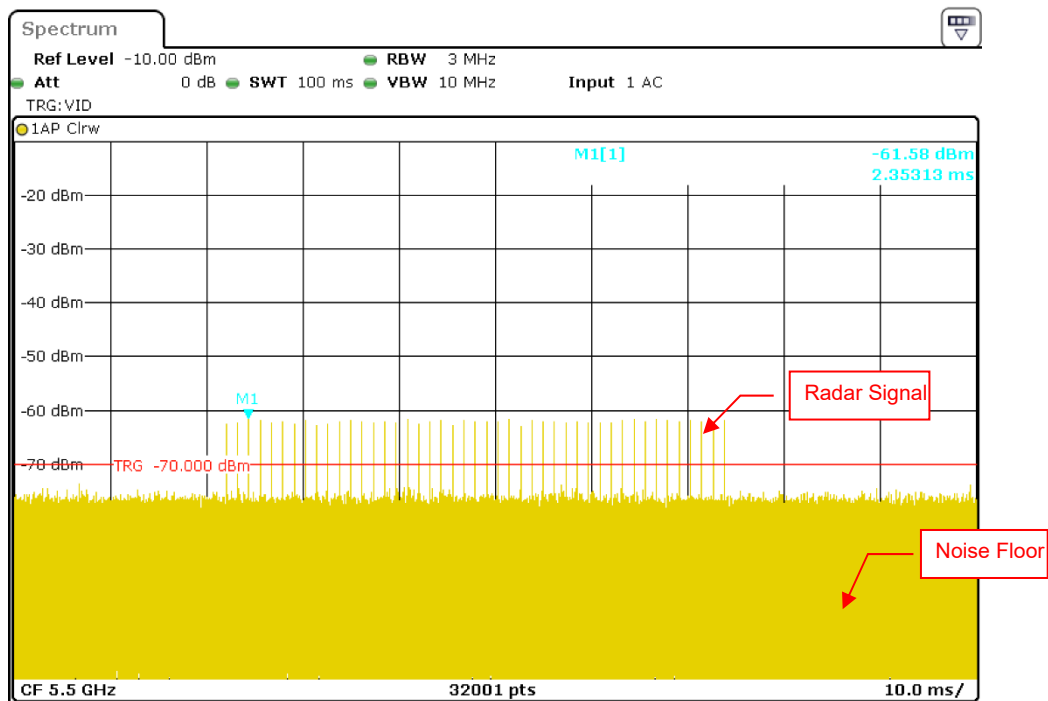

Radar Signal 1 (Test B)

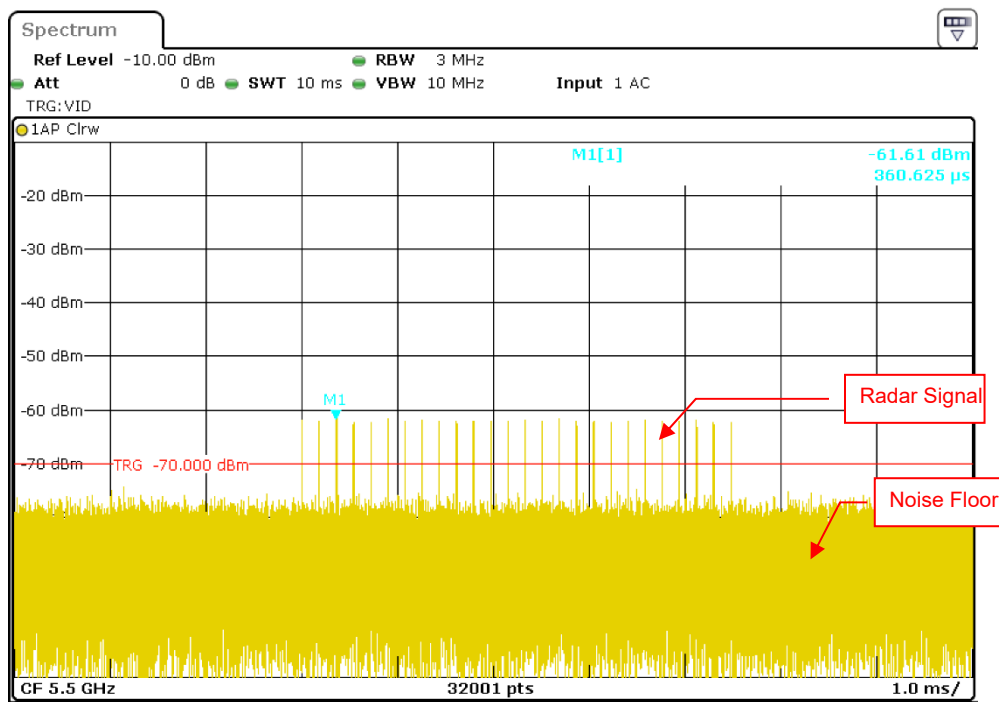

Radar Signal 2

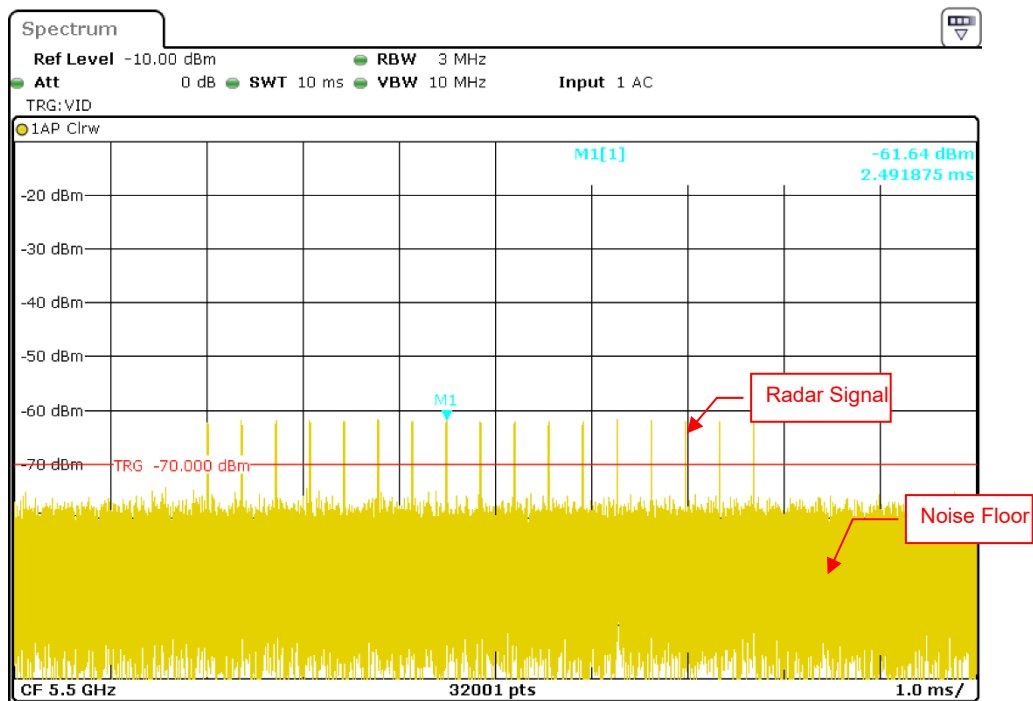

Radar Signal 3

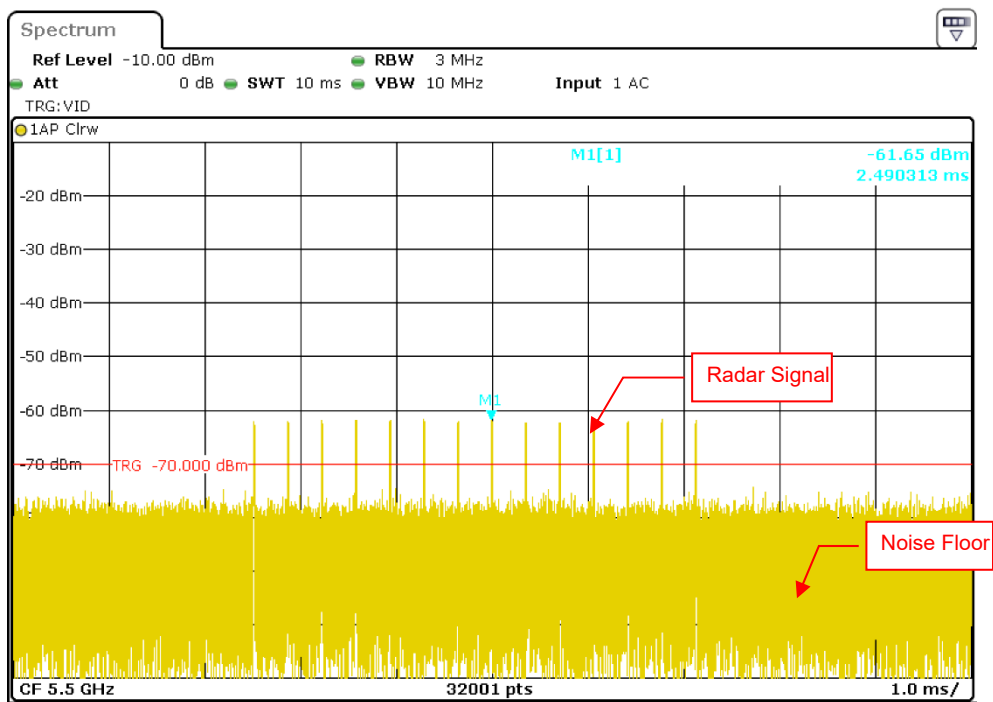

Radar Signal 4

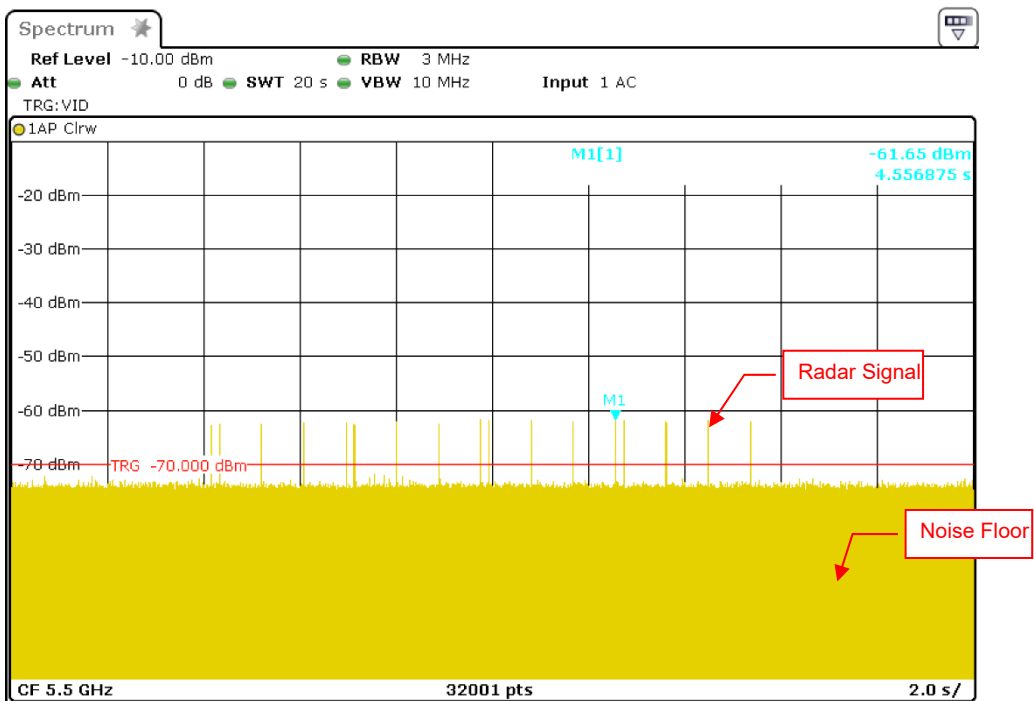

Radar Signal 5

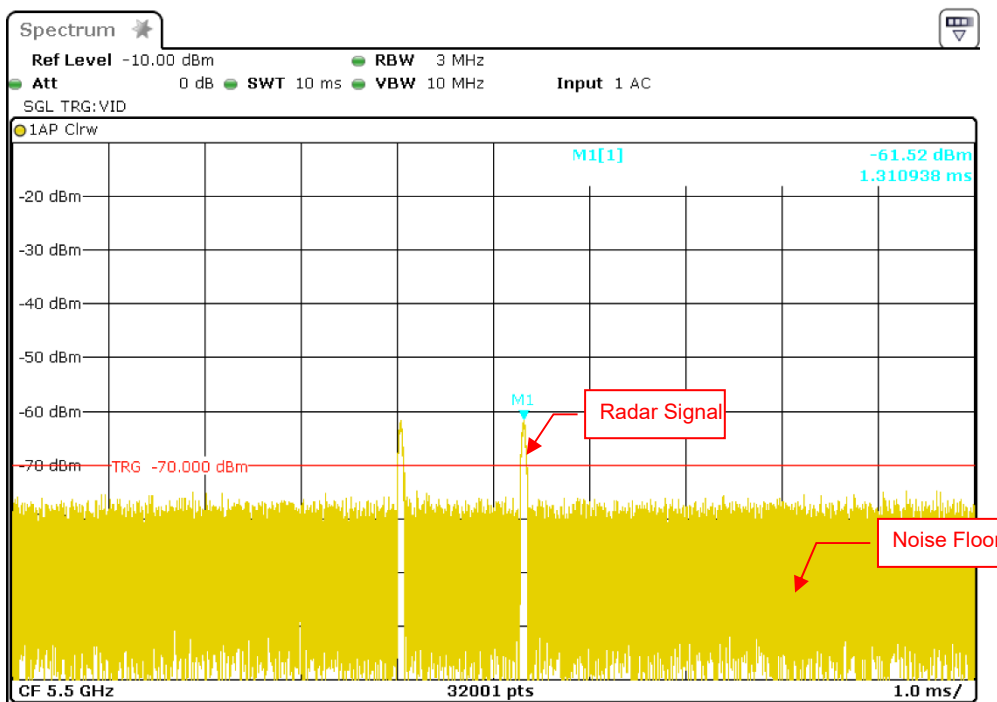

Single Burst of Radar Signal 5

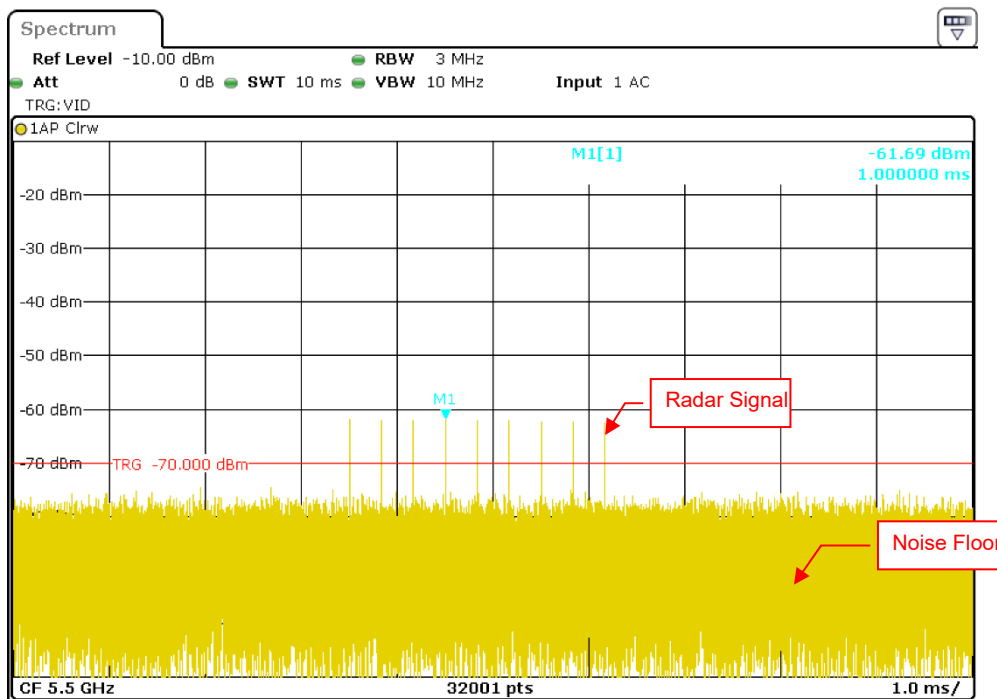

Radar Signal 6

6.2.2 Detection Bandwidth

802.11be (EHT20)

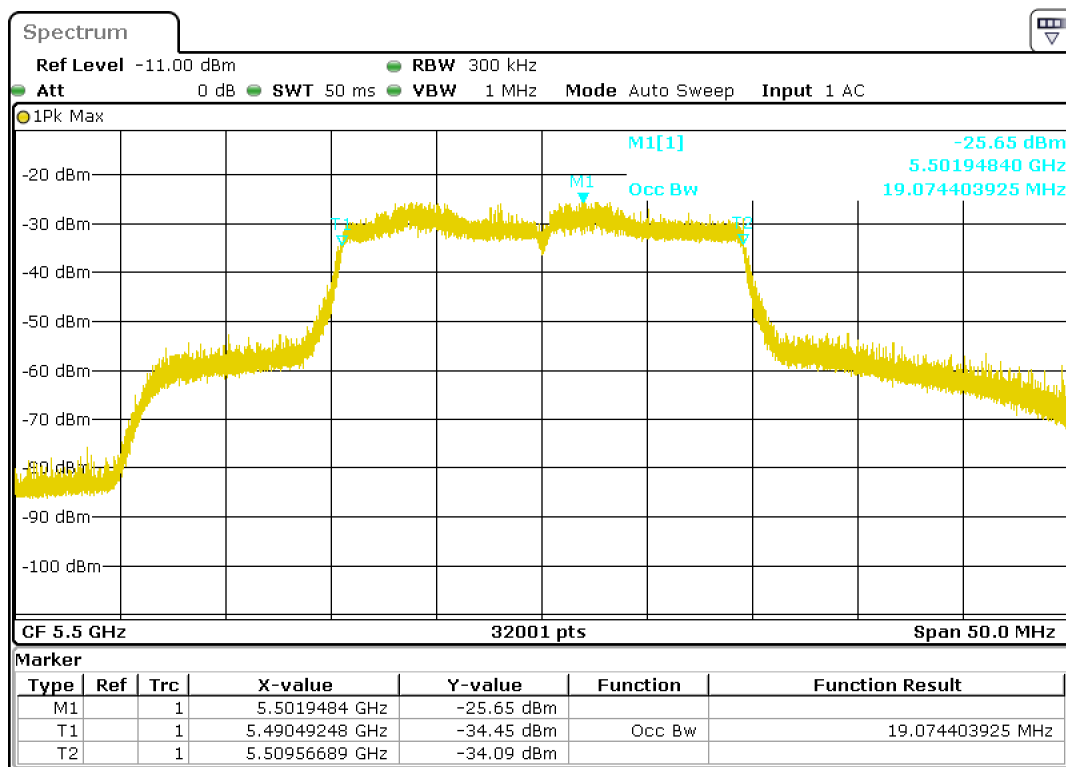

U-NII 99% Channel bandwidth

Notes:

UUT Occupied Bandwidth : 19.07 MHz

UUT Occupied Bandwidth low edge (FL) : 5490.50 MHz

UUT Occupied Bandwidth high edge (FH) : 5509.57 MHz

802.11be (EHT40)

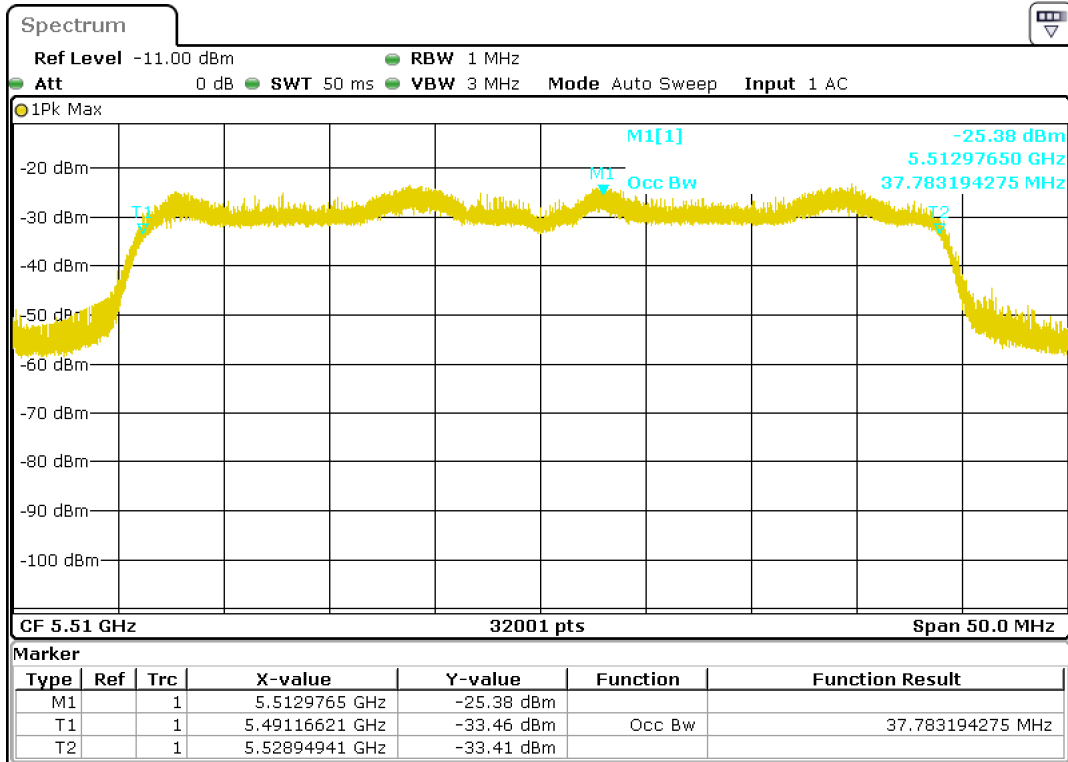

U-NII 99% Channel bandwidth

Notes:

- UUT Occupied Bandwidth : 37.78 MHz
- UUT Occupied Bandwidth low edge (FL) : 5491.17MHz
- UUT Occupied Bandwidth high edge (FH) : 5528.95 MHz

802.11be (EHT80)

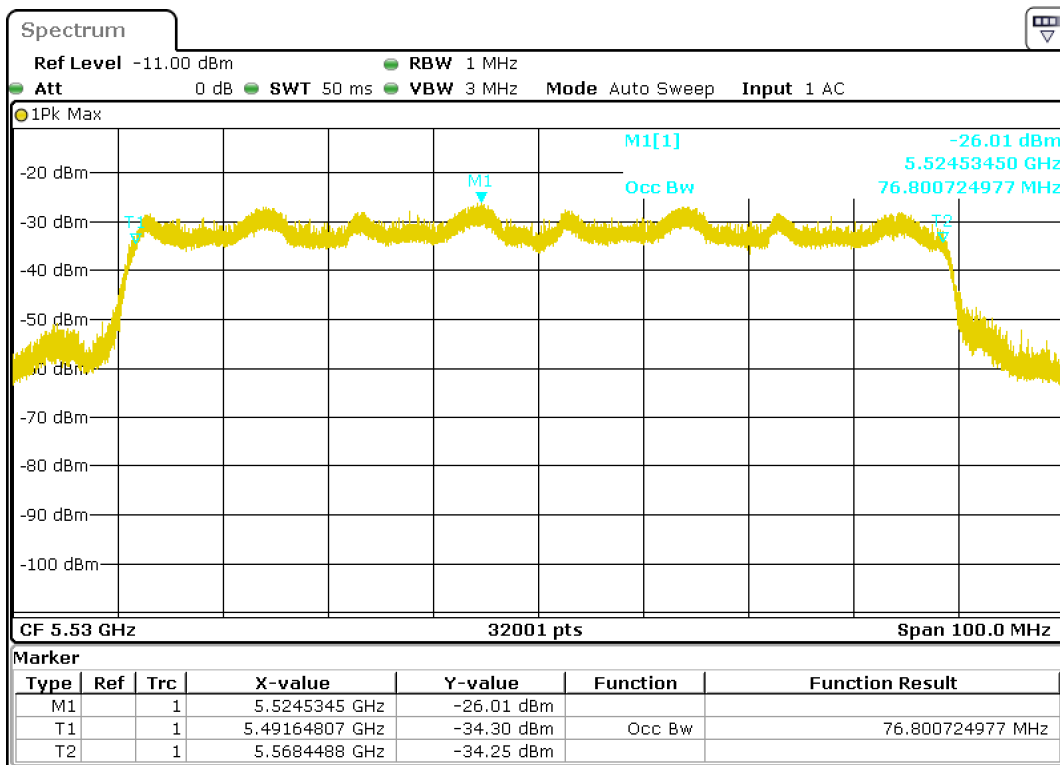

U-NII 99% Channel bandwidth

Notes:

- UUT Occupied Bandwidth : 76.80 MHz
- UUT Occupied Bandwidth low edge (FL) : 5491.65MHz
- UUT Occupied Bandwidth high edge (FH) : 5568.45 MHz

802.11be (EHT160)_5250MHz

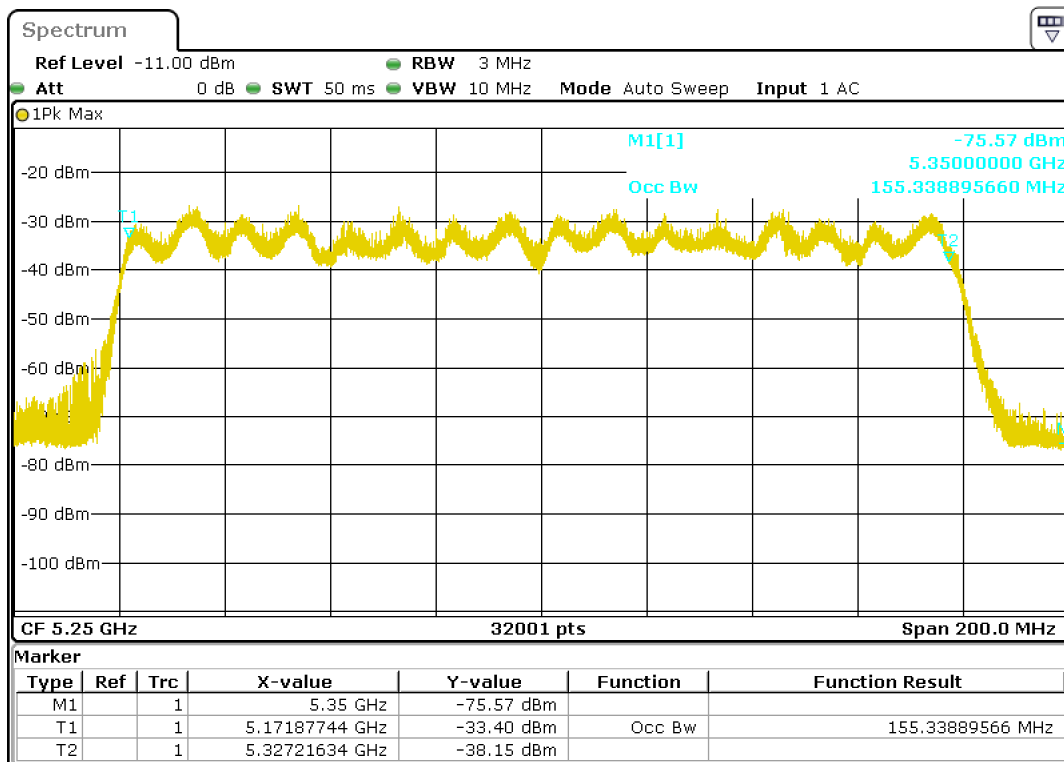

U-NII 99% Channel bandwidth

Notes:

- UUT Occupied Bandwidth : 155.34 MHz
- DFS band range:5250~5330MHz
- UUT Occupied Bandwidth low edge (FL) : 5250 MHz
- UUT Occupied Bandwidth high edge (FH) : 5327.22 MHz

802.11be (EHT160)_5570MHz

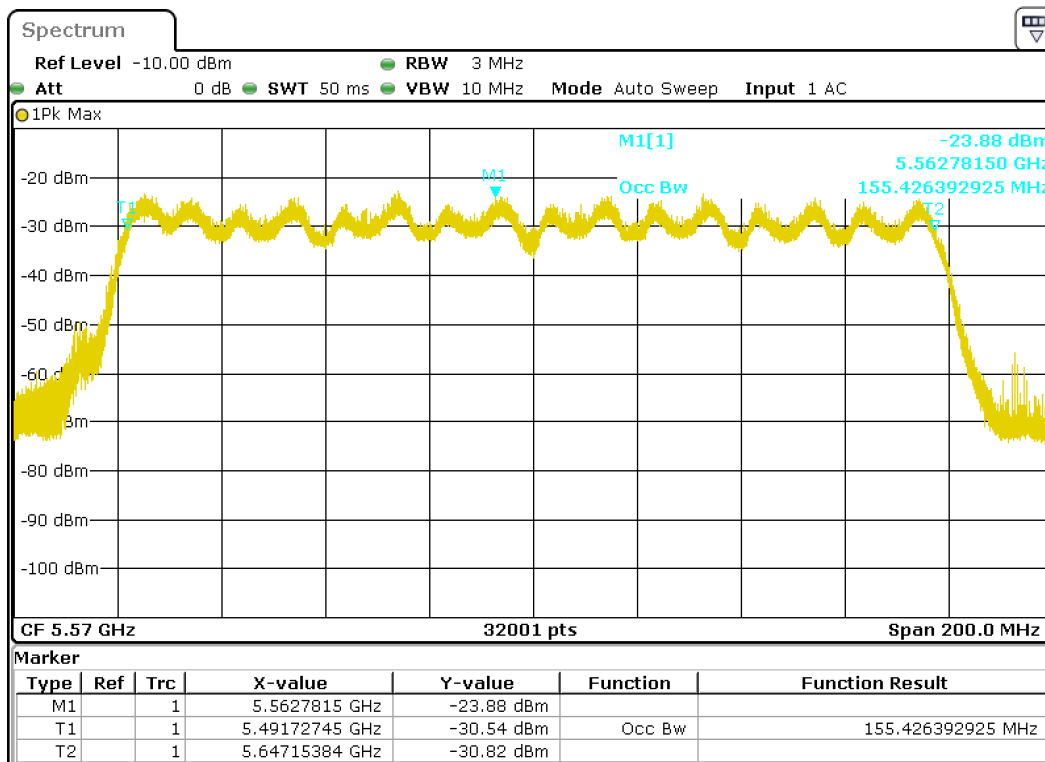

U-NII 99% Channel bandwidth

Notes:

- UUT Occupied Bandwidth : 155.43 MHz
- UUT Occupied Bandwidth low edge (FL) : 5491.72 MHz
- UUT Occupied Bandwidth high edge (FH) : 5647.15 MHz

Detection Bandwidth Test - 802.11be (EHT20)

Radar Type 0

EUT Frequency: 5500MHz

EUT 99% Power bandwidth: 19.07MHz

Detection bandwidth limit (100% of EUT 99% Power bandwidth): 19.07MHz

Detection bandwidth (5510(FH) – 5490(FL)) : 20MHz

Test Result : Pass

Radar Frequency (MHz)	Trial Number / Detection										Detection Rate (%)
	1	2	3	4	5	6	7	8	9	10	
5489	No	No	No	No	No	No	No	No	No	No	0.0
5490 (FL)	Yes	Yes	Yes	Yes	Yes	Yes	Yes	Yes	Yes	Yes	100.0
5491	Yes	Yes	Yes	Yes	Yes	Yes	Yes	Yes	Yes	Yes	100.0
5492	Yes	Yes	Yes	Yes	Yes	Yes	Yes	Yes	Yes	Yes	100.0
5493	Yes	Yes	Yes	Yes	Yes	Yes	Yes	Yes	Yes	Yes	100.0
5494	Yes	Yes	Yes	Yes	Yes	Yes	Yes	Yes	Yes	Yes	100.0
5495	Yes	Yes	Yes	Yes	Yes	Yes	Yes	Yes	Yes	Yes	100.0
5496	Yes	Yes	Yes	Yes	Yes	Yes	Yes	Yes	Yes	Yes	100.0
5497	Yes	Yes	Yes	Yes	Yes	Yes	Yes	Yes	Yes	Yes	100.0
5498	Yes	Yes	Yes	Yes	Yes	Yes	Yes	Yes	Yes	Yes	100.0
5499	Yes	Yes	Yes	Yes	Yes	Yes	Yes	Yes	Yes	Yes	100.0
5500	Yes	Yes	Yes	Yes	Yes	Yes	Yes	Yes	Yes	Yes	100.0
5501	Yes	Yes	Yes	Yes	Yes	Yes	Yes	Yes	Yes	Yes	100.0
5502	Yes	Yes	Yes	Yes	Yes	Yes	Yes	Yes	Yes	Yes	100.0
5503	Yes	Yes	Yes	Yes	Yes	Yes	Yes	Yes	Yes	Yes	100.0
5504	Yes	Yes	Yes	Yes	Yes	Yes	Yes	Yes	Yes	Yes	100.0
5505	Yes	Yes	Yes	Yes	Yes	Yes	Yes	Yes	Yes	Yes	100.0
5506	Yes	Yes	Yes	Yes	Yes	Yes	Yes	Yes	Yes	Yes	100.0
5507	Yes	Yes	Yes	Yes	Yes	Yes	Yes	Yes	Yes	Yes	100.0
5508	Yes	Yes	Yes	Yes	Yes	Yes	Yes	Yes	Yes	Yes	100.0
5509	Yes	Yes	Yes	Yes	Yes	Yes	Yes	Yes	Yes	Yes	100.0
5510 (FH)	Yes	Yes	Yes	Yes	Yes	Yes	Yes	Yes	Yes	Yes	100.0
5511	No	No	No	No	No	No	No	No	No	No	0.0

Detection Bandwidth Test - 802.11be (EHT40)

Radar Type 0

EUT Frequency: 5510MHz

EUT 99% Power bandwidth: 37.78MHz

Detection bandwidth limit (100% of EUT 99% Power bandwidth): 37.78MHz

Detection bandwidth (5530(FH) – 5490(FL)) : 40MHz

Test Result : Pass

Radar Frequency (MHz)	Trial Number / Detection										Detection Rate (%)
	1	2	3	4	5	6	7	8	9	10	
5489	No	No	No	No	No	No	No	No	No	No	0.0
5490 (FL)	Yes	Yes	Yes	Yes	Yes	Yes	Yes	Yes	Yes	Yes	100.0
5491	Yes	Yes	Yes	Yes	Yes	Yes	Yes	Yes	Yes	Yes	100.0
5492	Yes	Yes	Yes	Yes	Yes	Yes	Yes	Yes	Yes	Yes	100.0
5493	Yes	Yes	Yes	Yes	Yes	Yes	Yes	Yes	Yes	Yes	100.0
5494	Yes	Yes	Yes	Yes	Yes	Yes	Yes	Yes	Yes	Yes	100.0
5495	Yes	Yes	Yes	Yes	Yes	Yes	Yes	Yes	Yes	Yes	100.0
5496	Yes	Yes	Yes	Yes	Yes	Yes	Yes	Yes	Yes	Yes	100.0
5497	Yes	Yes	Yes	Yes	Yes	Yes	Yes	Yes	Yes	Yes	100.0
5498	Yes	Yes	Yes	Yes	Yes	Yes	Yes	Yes	Yes	Yes	100.0
5499	Yes	Yes	Yes	Yes	Yes	Yes	Yes	Yes	Yes	Yes	100.0
5500	Yes	Yes	Yes	Yes	Yes	Yes	Yes	Yes	Yes	Yes	100.0
5501	Yes	Yes	Yes	Yes	Yes	Yes	Yes	Yes	Yes	Yes	100.0
5502	Yes	Yes	Yes	Yes	Yes	Yes	Yes	Yes	Yes	Yes	100.0
5503	Yes	Yes	Yes	Yes	Yes	Yes	Yes	Yes	Yes	Yes	100.0
5504	Yes	Yes	Yes	Yes	Yes	Yes	Yes	Yes	Yes	Yes	100.0
5505	Yes	Yes	Yes	Yes	Yes	Yes	Yes	Yes	Yes	Yes	100.0
5506	Yes	Yes	Yes	Yes	Yes	Yes	Yes	Yes	Yes	Yes	100.0
5507	Yes	Yes	Yes	Yes	Yes	Yes	Yes	Yes	Yes	Yes	100.0
5508	Yes	Yes	Yes	Yes	Yes	Yes	Yes	Yes	Yes	Yes	100.0
5509	Yes	Yes	Yes	Yes	Yes	Yes	Yes	Yes	Yes	Yes	100.0
5510	Yes	Yes	Yes	Yes	Yes	Yes	Yes	Yes	Yes	Yes	100.0
5511	Yes	Yes	Yes	Yes	Yes	Yes	Yes	Yes	Yes	Yes	100.0
5512	Yes	Yes	Yes	Yes	Yes	Yes	Yes	Yes	Yes	Yes	100.0
5513	Yes	Yes	Yes	Yes	Yes	Yes	Yes	Yes	Yes	Yes	100.0
5514	Yes	Yes	Yes	Yes	Yes	Yes	Yes	Yes	Yes	Yes	100.0
5515	Yes	Yes	Yes	Yes	Yes	Yes	Yes	Yes	Yes	Yes	100.0
5516	Yes	Yes	Yes	Yes	Yes	Yes	Yes	Yes	Yes	Yes	100.0
5517	Yes	Yes	Yes	Yes	Yes	Yes	Yes	Yes	Yes	Yes	100.0
5518	Yes	Yes	Yes	Yes	Yes	Yes	Yes	Yes	Yes	Yes	100.0
5519	Yes	Yes	Yes	Yes	Yes	Yes	Yes	Yes	Yes	Yes	100.0
5520	Yes	Yes	Yes	Yes	Yes	Yes	Yes	Yes	Yes	Yes	100.0
5521	Yes	Yes	Yes	Yes	Yes	Yes	Yes	Yes	Yes	Yes	100.0
5522	Yes	Yes	Yes	Yes	Yes	Yes	Yes	Yes	Yes	Yes	100.0
5523	Yes	Yes	Yes	Yes	Yes	Yes	Yes	Yes	Yes	Yes	100.0
5524	Yes	Yes	Yes	Yes	Yes	Yes	Yes	Yes	Yes	Yes	100.0
5525	Yes	Yes	Yes	Yes	Yes	Yes	Yes	Yes	Yes	Yes	100.0
5526	Yes	Yes	Yes	Yes	Yes	Yes	Yes	Yes	Yes	Yes	100.0
5527	Yes	Yes	Yes	Yes	Yes	Yes	Yes	Yes	Yes	Yes	100.0
5528	Yes	Yes	Yes	Yes	Yes	Yes	Yes	Yes	Yes	Yes	100.0
5529	Yes	Yes	Yes	Yes	Yes	Yes	Yes	Yes	Yes	Yes	100.0
5530 (FH)	Yes	Yes	Yes	Yes	Yes	Yes	Yes	Yes	Yes	Yes	100.0
5531	No	No	No	No	No	No	No	No	No	No	0.0

Detection Bandwidth Test - 802.11be (EHT80)

Radar Type 0

EUT Frequency: 5530MHz

EUT 99% Power bandwidth: 76.80 MHz

Detection bandwidth limit (100% of EUT 99% Power bandwidth): 76.80MHz

Detection bandwidth (5570(FH) – 5490(FL)) : 80MHz

Test Result : Pass

Radar Frequency (MHz)	Trial Number / Detection										Detection Rate (%)
	1	2	3	4	5	6	7	8	9	10	
5489	No	No	No	No	No	No	No	No	No	No	0.0
5490 (FL)	Yes	Yes	Yes	Yes	Yes	Yes	Yes	Yes	Yes	Yes	100.0
5491	Yes	Yes	Yes	Yes	Yes	Yes	Yes	Yes	Yes	Yes	100.0
5492	Yes	Yes	Yes	Yes	Yes	Yes	Yes	Yes	Yes	Yes	100.0
5493	Yes	Yes	Yes	Yes	Yes	Yes	Yes	Yes	Yes	Yes	100.0
5494	Yes	Yes	Yes	Yes	Yes	Yes	Yes	Yes	Yes	Yes	100.0
5495	Yes	Yes	Yes	Yes	Yes	Yes	Yes	Yes	Yes	Yes	100.0
5496	Yes	Yes	Yes	Yes	Yes	Yes	Yes	Yes	Yes	Yes	100.0
5497	Yes	Yes	Yes	Yes	Yes	Yes	Yes	Yes	Yes	Yes	100.0
5498	Yes	Yes	Yes	Yes	Yes	Yes	Yes	Yes	Yes	Yes	100.0
5499	Yes	Yes	Yes	Yes	Yes	Yes	Yes	Yes	Yes	Yes	100.0
5500	Yes	Yes	Yes	Yes	Yes	Yes	Yes	Yes	Yes	Yes	100.0
5501	Yes	Yes	Yes	Yes	Yes	Yes	Yes	Yes	Yes	Yes	100.0
5502	Yes	Yes	Yes	Yes	Yes	Yes	Yes	Yes	Yes	Yes	100.0
5503	Yes	Yes	Yes	Yes	Yes	Yes	Yes	Yes	Yes	Yes	100.0
5504	Yes	Yes	Yes	Yes	Yes	Yes	Yes	Yes	Yes	Yes	100.0
5505	Yes	Yes	Yes	Yes	Yes	Yes	Yes	Yes	Yes	Yes	100.0
5506	Yes	Yes	Yes	Yes	Yes	Yes	Yes	Yes	Yes	Yes	100.0
5507	Yes	Yes	Yes	Yes	Yes	Yes	Yes	Yes	Yes	Yes	100.0
5508	Yes	Yes	Yes	Yes	Yes	Yes	Yes	Yes	Yes	Yes	100.0
5509	Yes	Yes	Yes	Yes	Yes	Yes	Yes	Yes	Yes	Yes	100.0
5510	Yes	Yes	Yes	Yes	Yes	Yes	Yes	Yes	Yes	Yes	100.0
5511	Yes	Yes	Yes	Yes	Yes	Yes	Yes	Yes	Yes	Yes	100.0
5512	Yes	Yes	Yes	Yes	Yes	Yes	Yes	Yes	Yes	Yes	100.0
5513	Yes	Yes	Yes	Yes	Yes	Yes	Yes	Yes	Yes	Yes	100.0
5514	Yes	Yes	Yes	Yes	Yes	Yes	Yes	Yes	Yes	Yes	100.0
5515	Yes	Yes	Yes	Yes	Yes	Yes	Yes	Yes	Yes	Yes	100.0
5516	Yes	Yes	Yes	Yes	Yes	Yes	Yes	Yes	Yes	Yes	100.0
5517	Yes	Yes	Yes	Yes	Yes	Yes	Yes	Yes	Yes	Yes	100.0
5518	Yes	Yes	Yes	Yes	Yes	Yes	Yes	Yes	Yes	Yes	100.0
5519	Yes	Yes	Yes	Yes	Yes	Yes	Yes	Yes	Yes	Yes	100.0
5520	Yes	Yes	Yes	Yes	Yes	Yes	Yes	Yes	Yes	Yes	100.0
5521	Yes	Yes	Yes	Yes	Yes	Yes	Yes	Yes	Yes	Yes	100.0
5522	Yes	Yes	Yes	Yes	Yes	Yes	Yes	Yes	Yes	Yes	100.0
5523	Yes	Yes	Yes	Yes	Yes	Yes	Yes	Yes	Yes	Yes	100.0
5524	Yes	Yes	Yes	Yes	Yes	Yes	Yes	Yes	Yes	Yes	100.0
5525	Yes	Yes	Yes	Yes	Yes	Yes	Yes	Yes	Yes	Yes	100.0
5526	Yes	Yes	Yes	Yes	Yes	Yes	Yes	Yes	Yes	Yes	100.0
5527	Yes	Yes	Yes	Yes	Yes	Yes	Yes	Yes	Yes	Yes	100.0
5528	Yes	Yes	Yes	Yes	Yes	Yes	Yes	Yes	Yes	Yes	100.0
5529	Yes	Yes	Yes	Yes	Yes	Yes	Yes	Yes	Yes	Yes	100.0
5530	Yes	Yes	Yes	Yes	Yes	Yes	Yes	Yes	Yes	Yes	100.0
5531	Yes	Yes	Yes	Yes	Yes	Yes	Yes	Yes	Yes	Yes	100.0
5532	Yes	Yes	Yes	Yes	Yes	Yes	Yes	Yes	Yes	Yes	100.0
5533	Yes	Yes	Yes	Yes	Yes	Yes	Yes	Yes	Yes	Yes	100.0

5534	Yes	Yes	Yes	Yes	Yes	Yes	Yes	Yes	Yes	Yes	100.0
5535	Yes	Yes	Yes	Yes	Yes	Yes	Yes	Yes	Yes	Yes	100.0
5536	Yes	Yes	Yes	Yes	Yes	Yes	Yes	Yes	Yes	Yes	100.0
5537	Yes	Yes	Yes	Yes	Yes	Yes	Yes	Yes	Yes	Yes	100.0
5538	Yes	Yes	Yes	Yes	Yes	Yes	Yes	Yes	Yes	Yes	100.0
5539	Yes	Yes	Yes	Yes	Yes	Yes	Yes	Yes	Yes	Yes	100.0
5540	Yes	Yes	Yes	Yes	Yes	Yes	Yes	Yes	Yes	Yes	100.0
5541	Yes	Yes	Yes	Yes	Yes	Yes	Yes	Yes	Yes	Yes	100.0
5542	Yes	Yes	Yes	Yes	Yes	Yes	Yes	Yes	Yes	Yes	100.0
5543	Yes	Yes	Yes	Yes	Yes	Yes	Yes	Yes	Yes	Yes	100.0
5544	Yes	Yes	Yes	Yes	Yes	Yes	Yes	Yes	Yes	Yes	100.0
5545	Yes	Yes	Yes	Yes	Yes	Yes	Yes	Yes	Yes	Yes	100.0
5546	Yes	Yes	Yes	Yes	Yes	Yes	Yes	Yes	Yes	Yes	100.0
5547	Yes	Yes	Yes	Yes	Yes	Yes	Yes	Yes	Yes	Yes	100.0
5548	Yes	Yes	Yes	Yes	Yes	Yes	Yes	Yes	Yes	Yes	100.0
5549	Yes	Yes	Yes	Yes	Yes	Yes	Yes	Yes	Yes	Yes	100.0
5550	Yes	Yes	Yes	Yes	Yes	Yes	Yes	Yes	Yes	Yes	100.0
5551	Yes	Yes	Yes	Yes	Yes	Yes	Yes	Yes	Yes	Yes	100.0
5552	Yes	Yes	Yes	Yes	Yes	Yes	Yes	Yes	Yes	Yes	100.0
5553	Yes	Yes	Yes	Yes	Yes	Yes	Yes	Yes	Yes	Yes	100.0
5554	Yes	Yes	Yes	Yes	Yes	Yes	Yes	Yes	Yes	Yes	100.0
5555	Yes	Yes	Yes	Yes	Yes	Yes	Yes	Yes	Yes	Yes	100.0
5556	Yes	Yes	Yes	Yes	Yes	Yes	Yes	Yes	Yes	Yes	100.0
5557	Yes	Yes	Yes	Yes	Yes	Yes	Yes	Yes	Yes	Yes	100.0
5558	Yes	Yes	Yes	Yes	Yes	Yes	Yes	Yes	Yes	Yes	100.0
5559	Yes	Yes	Yes	Yes	Yes	Yes	Yes	Yes	Yes	Yes	100.0
5560	Yes	Yes	Yes	Yes	Yes	Yes	Yes	Yes	Yes	Yes	100.0
5561	Yes	Yes	Yes	Yes	Yes	Yes	Yes	Yes	Yes	Yes	100.0
5562	Yes	Yes	Yes	Yes	Yes	Yes	Yes	Yes	Yes	Yes	100.0
5563	Yes	Yes	Yes	Yes	Yes	Yes	Yes	Yes	Yes	Yes	100.0
5564	Yes	Yes	Yes	Yes	Yes	Yes	Yes	Yes	Yes	Yes	100.0
5565	Yes	Yes	Yes	Yes	Yes	Yes	Yes	Yes	Yes	Yes	100.0
5566	Yes	Yes	Yes	Yes	Yes	Yes	Yes	Yes	Yes	Yes	100.0
5567	Yes	Yes	Yes	Yes	Yes	Yes	Yes	Yes	Yes	Yes	100.0
5568	Yes	Yes	Yes	Yes	Yes	Yes	Yes	Yes	Yes	Yes	100.0
5569	Yes	Yes	Yes	Yes	Yes	Yes	Yes	Yes	Yes	Yes	100.0
5570 (FH)	Yes	Yes	Yes	Yes	Yes	Yes	Yes	Yes	Yes	Yes	100.0
5571	No	No	No	No	No	No	No	No	No	No	0.0

Detection Bandwidth Test - 802.11be (EHT160)

Radar Type 0

EUT Frequency: 5250MHz

EUT 99% Power bandwidth: 155.34MHz

Detection bandwidth limit (100% of EUT 99% Power bandwidth): 155.34MHz

Detection bandwidth (5330(FH) – 5250(FL)) : 80MHz

(160MHz channel (5250MHz) straddle between 5150~5250 and 5250~5350MHz, the DFS ability is necessary in 5250~5350MHz, therefore DFS detection bandwidth start from 5250MHz for 11ax HE160 mode.)

Test Result : Pass

Radar Frequency (MHz)	Trial Number / Detection										Detection Rate (%)
	1	2	3	4	5	6	7	8	9	10	
5250 (FL)	Yes	Yes	Yes	Yes	Yes	Yes	Yes	Yes	Yes	Yes	100.0
5251	Yes	Yes	Yes	Yes	Yes	Yes	Yes	Yes	Yes	Yes	100.0
5252	Yes	Yes	Yes	Yes	Yes	Yes	Yes	Yes	Yes	Yes	100.0
5253	Yes	Yes	Yes	Yes	Yes	Yes	Yes	Yes	Yes	Yes	100.0
5254	Yes	Yes	Yes	Yes	Yes	Yes	Yes	Yes	Yes	Yes	100.0
5255	Yes	Yes	Yes	Yes	Yes	Yes	Yes	Yes	Yes	Yes	100.0
5256	Yes	Yes	Yes	Yes	Yes	Yes	Yes	Yes	Yes	Yes	100.0
5257	Yes	Yes	Yes	Yes	Yes	Yes	Yes	Yes	Yes	Yes	100.0
5258	Yes	Yes	Yes	Yes	Yes	Yes	Yes	Yes	Yes	Yes	100.0
5259	Yes	Yes	Yes	Yes	Yes	Yes	Yes	Yes	Yes	Yes	100.0
5260	Yes	Yes	Yes	Yes	Yes	Yes	Yes	Yes	Yes	Yes	100.0
5261	Yes	Yes	Yes	Yes	Yes	Yes	Yes	Yes	Yes	Yes	100.0
5262	Yes	Yes	Yes	Yes	Yes	Yes	Yes	Yes	Yes	Yes	100.0
5263	Yes	Yes	Yes	Yes	Yes	Yes	Yes	Yes	Yes	Yes	100.0
5264	Yes	Yes	Yes	Yes	Yes	Yes	Yes	Yes	Yes	Yes	100.0
5265	Yes	Yes	Yes	Yes	Yes	Yes	Yes	Yes	Yes	Yes	100.0
5266	Yes	Yes	Yes	Yes	Yes	Yes	Yes	Yes	Yes	Yes	100.0
5267	Yes	Yes	Yes	Yes	Yes	Yes	Yes	Yes	Yes	Yes	100.0
5268	Yes	Yes	Yes	Yes	Yes	Yes	Yes	Yes	Yes	Yes	100.0
5269	Yes	Yes	Yes	Yes	Yes	Yes	Yes	Yes	Yes	Yes	100.0
5270	Yes	Yes	Yes	Yes	Yes	Yes	Yes	Yes	Yes	Yes	100.0
5271	Yes	Yes	Yes	Yes	Yes	Yes	Yes	Yes	Yes	Yes	100.0
5272	Yes	Yes	Yes	Yes	Yes	Yes	Yes	Yes	Yes	Yes	100.0
5273	Yes	Yes	Yes	Yes	Yes	Yes	Yes	Yes	Yes	Yes	100.0
5274	Yes	Yes	Yes	Yes	Yes	Yes	Yes	Yes	Yes	Yes	100.0
5275	Yes	Yes	Yes	Yes	Yes	Yes	Yes	Yes	Yes	Yes	100.0
5276	Yes	Yes	Yes	Yes	Yes	Yes	Yes	Yes	Yes	Yes	100.0
5277	Yes	Yes	Yes	Yes	Yes	Yes	Yes	Yes	Yes	Yes	100.0
5278	Yes	Yes	Yes	Yes	Yes	Yes	Yes	Yes	Yes	Yes	100.0
5279	Yes	Yes	Yes	Yes	Yes	Yes	Yes	Yes	Yes	Yes	100.0
5280	Yes	Yes	Yes	Yes	Yes	Yes	Yes	Yes	Yes	Yes	100.0
5281	Yes	Yes	Yes	Yes	Yes	Yes	Yes	Yes	Yes	Yes	100.0
5282	Yes	Yes	Yes	Yes	Yes	Yes	Yes	Yes	Yes	Yes	100.0
5283	Yes	Yes	Yes	Yes	Yes	Yes	Yes	Yes	Yes	Yes	100.0
5284	Yes	Yes	Yes	Yes	Yes	Yes	Yes	Yes	Yes	Yes	100.0
5285	Yes	Yes	Yes	Yes	Yes	Yes	Yes	Yes	Yes	Yes	100.0
5286	Yes	Yes	Yes	Yes	Yes	Yes	Yes	Yes	Yes	Yes	100.0
5287	Yes	Yes	Yes	Yes	Yes	Yes	Yes	Yes	Yes	Yes	100.0
5288	Yes	Yes	Yes	Yes	Yes	Yes	Yes	Yes	Yes	Yes	100.0
5289	Yes	Yes	Yes	Yes	Yes	Yes	Yes	Yes	Yes	Yes	100.0
5290	Yes	Yes	Yes	Yes	Yes	Yes	Yes	Yes	Yes	Yes	100.0
5291	Yes	Yes	Yes	Yes	Yes	Yes	Yes	Yes	Yes	Yes	100.0

5292	Yes	Yes	Yes	Yes	Yes	Yes	Yes	Yes	Yes	Yes	100.0
5293	Yes	Yes	Yes	Yes	Yes	Yes	Yes	Yes	Yes	Yes	100.0
5294	Yes	Yes	Yes	Yes	Yes	Yes	Yes	Yes	Yes	Yes	100.0
5295	Yes	Yes	Yes	Yes	Yes	Yes	Yes	Yes	Yes	Yes	100.0
5296	Yes	Yes	Yes	Yes	Yes	Yes	Yes	Yes	Yes	Yes	100.0
5297	Yes	Yes	Yes	Yes	Yes	Yes	Yes	Yes	Yes	Yes	100.0
5298	Yes	Yes	Yes	Yes	Yes	Yes	Yes	Yes	Yes	Yes	100.0
5299	Yes	Yes	Yes	Yes	Yes	Yes	Yes	Yes	Yes	Yes	100.0
5300	Yes	Yes	Yes	Yes	Yes	Yes	Yes	Yes	Yes	Yes	100.0
5301	Yes	Yes	Yes	Yes	Yes	Yes	Yes	Yes	Yes	Yes	100.0
5302	Yes	Yes	Yes	Yes	Yes	Yes	Yes	Yes	Yes	Yes	100.0
5303	Yes	Yes	Yes	Yes	Yes	Yes	Yes	Yes	Yes	Yes	100.0
5304	Yes	Yes	Yes	Yes	Yes	Yes	Yes	Yes	Yes	Yes	100.0
5305	Yes	Yes	Yes	Yes	Yes	Yes	Yes	Yes	Yes	Yes	100.0
5306	Yes	Yes	Yes	Yes	Yes	Yes	Yes	Yes	Yes	Yes	100.0
5307	Yes	Yes	Yes	Yes	Yes	Yes	Yes	Yes	Yes	Yes	100.0
5308	Yes	Yes	Yes	Yes	Yes	Yes	Yes	Yes	Yes	Yes	100.0
5309	Yes	Yes	Yes	Yes	Yes	Yes	Yes	Yes	Yes	Yes	100.0
5310	Yes	Yes	Yes	Yes	Yes	Yes	Yes	Yes	Yes	Yes	100.0
5311	Yes	Yes	Yes	Yes	Yes	Yes	Yes	Yes	Yes	Yes	100.0
5312	Yes	Yes	Yes	Yes	Yes	Yes	Yes	Yes	Yes	Yes	100.0
5313	Yes	Yes	Yes	Yes	Yes	Yes	Yes	Yes	Yes	Yes	100.0
5314	Yes	Yes	Yes	Yes	Yes	Yes	Yes	Yes	Yes	Yes	100.0
5315	Yes	Yes	Yes	Yes	Yes	Yes	Yes	Yes	Yes	Yes	100.0
5316	Yes	Yes	Yes	Yes	Yes	Yes	Yes	Yes	Yes	Yes	100.0
5317	Yes	Yes	Yes	Yes	Yes	Yes	Yes	Yes	Yes	Yes	100.0
5318	Yes	Yes	Yes	Yes	Yes	Yes	Yes	Yes	Yes	Yes	100.0
5319	Yes	Yes	Yes	Yes	Yes	Yes	Yes	Yes	Yes	Yes	100.0
5320	Yes	Yes	Yes	Yes	Yes	Yes	Yes	Yes	Yes	Yes	100.0
5321	Yes	Yes	Yes	Yes	Yes	Yes	Yes	Yes	Yes	Yes	100.0
5322	Yes	Yes	Yes	Yes	Yes	Yes	Yes	Yes	Yes	Yes	100.0
5323	Yes	Yes	Yes	Yes	Yes	Yes	Yes	Yes	Yes	Yes	100.0
5324	Yes	Yes	Yes	Yes	Yes	Yes	Yes	Yes	Yes	Yes	100.0
5325	Yes	Yes	Yes	Yes	Yes	Yes	Yes	Yes	Yes	Yes	100.0
5326	Yes	Yes	Yes	Yes	Yes	Yes	Yes	Yes	Yes	Yes	100.0
5327	Yes	Yes	Yes	Yes	Yes	Yes	Yes	Yes	Yes	Yes	100.0
5328	Yes	Yes	Yes	Yes	Yes	Yes	Yes	Yes	Yes	Yes	100.0
5329	Yes	Yes	Yes	Yes	Yes	Yes	Yes	Yes	Yes	Yes	100.0
5330 (FH)	Yes	Yes	Yes	Yes	Yes	Yes	Yes	Yes	Yes	Yes	100.0
5331	No	No	No	No	No	No	No	No	No	No	0.0

Detection Bandwidth Test - 802.11be (EHT160)

Radar Type 0

EUT Frequency: 5570MHz

EUT 99% Power bandwidth: 155.43 MHz

Detection bandwidth limit (100% of EUT 99% Power bandwidth): 155.43MHz

Detection bandwidth (5649(FH) – 5491(FL)) : 158MHz

Test Result : Pass

Radar Frequency (MHz)	Trial Number / Detection										Detection Rate (%)
	1	2	3	4	5	6	7	8	9	10	
5490	No	No	No	No	No	No	No	No	No	No	0.0
5491(FL)	Yes	Yes	Yes	Yes	Yes	Yes	Yes	Yes	Yes	Yes	100.0
5492	Yes	Yes	Yes	Yes	Yes	Yes	Yes	Yes	Yes	Yes	100.0
5493	Yes	Yes	Yes	Yes	Yes	Yes	Yes	Yes	Yes	Yes	100.0
5494	Yes	Yes	Yes	Yes	Yes	Yes	Yes	Yes	Yes	Yes	100.0
5495	Yes	Yes	Yes	Yes	Yes	Yes	Yes	Yes	Yes	Yes	100.0
5496	Yes	Yes	Yes	Yes	Yes	Yes	Yes	Yes	Yes	Yes	100.0
5497	Yes	Yes	No	Yes	Yes	Yes	Yes	Yes	Yes	Yes	90.0
5498	Yes	Yes	Yes	Yes	Yes	Yes	Yes	Yes	Yes	Yes	100.0
5499	Yes	Yes	Yes	Yes	Yes	Yes	Yes	Yes	Yes	Yes	100.0
5500	Yes	Yes	Yes	Yes	Yes	Yes	Yes	Yes	Yes	Yes	100.0
5501	Yes	Yes	Yes	Yes	Yes	Yes	Yes	Yes	Yes	Yes	100.0
5502	Yes	Yes	Yes	Yes	Yes	Yes	Yes	Yes	Yes	Yes	100.0
5503	Yes	Yes	Yes	Yes	Yes	Yes	Yes	Yes	Yes	Yes	100.0
5504	Yes	Yes	Yes	Yes	Yes	Yes	Yes	Yes	Yes	Yes	100.0
5505	Yes	Yes	Yes	Yes	Yes	Yes	Yes	Yes	Yes	Yes	100.0
5506	Yes	Yes	Yes	Yes	Yes	Yes	Yes	Yes	Yes	Yes	100.0
5507	Yes	Yes	Yes	Yes	Yes	Yes	Yes	Yes	Yes	Yes	100.0
5508	Yes	Yes	Yes	Yes	Yes	Yes	Yes	Yes	Yes	Yes	100.0
5509	Yes	Yes	Yes	Yes	Yes	Yes	Yes	Yes	Yes	Yes	100.0
5510	Yes	Yes	Yes	Yes	Yes	Yes	Yes	Yes	Yes	Yes	100.0
5511	Yes	Yes	Yes	Yes	Yes	Yes	Yes	Yes	Yes	Yes	100.0
5512	Yes	Yes	Yes	Yes	Yes	Yes	Yes	Yes	Yes	Yes	100.0
5513	Yes	Yes	Yes	Yes	Yes	Yes	Yes	Yes	Yes	Yes	100.0
5514	Yes	Yes	Yes	Yes	Yes	Yes	Yes	Yes	Yes	Yes	100.0
5515	Yes	Yes	Yes	Yes	Yes	Yes	Yes	Yes	Yes	Yes	100.0
5516	Yes	Yes	Yes	Yes	Yes	Yes	Yes	Yes	Yes	Yes	100.0
5517	Yes	Yes	Yes	Yes	Yes	Yes	Yes	Yes	Yes	Yes	100.0
5518	Yes	Yes	Yes	Yes	Yes	Yes	Yes	Yes	Yes	Yes	100.0
5519	Yes	Yes	Yes	Yes	Yes	Yes	Yes	Yes	Yes	Yes	100.0
5520	Yes	Yes	Yes	Yes	Yes	Yes	Yes	Yes	Yes	Yes	100.0
5521	Yes	Yes	Yes	Yes	Yes	Yes	Yes	Yes	Yes	Yes	100.0
5522	Yes	Yes	Yes	Yes	Yes	Yes	Yes	Yes	Yes	Yes	100.0
5523	Yes	Yes	Yes	Yes	Yes	Yes	Yes	Yes	Yes	Yes	100.0
5524	Yes	Yes	Yes	Yes	Yes	Yes	Yes	Yes	Yes	Yes	100.0
5525	Yes	Yes	Yes	Yes	Yes	Yes	Yes	Yes	Yes	Yes	100.0
5526	Yes	Yes	Yes	Yes	Yes	Yes	Yes	Yes	Yes	Yes	100.0
5527	Yes	Yes	Yes	Yes	Yes	No	Yes	Yes	Yes	Yes	90.0
5528	Yes	Yes	Yes	Yes	Yes	Yes	Yes	Yes	Yes	Yes	100.0
5529	Yes	Yes	Yes	Yes	Yes	Yes	Yes	Yes	Yes	Yes	100.0
5530	Yes	Yes	Yes	Yes	Yes	Yes	Yes	Yes	Yes	Yes	100.0
5531	Yes	Yes	Yes	Yes	Yes	Yes	Yes	Yes	Yes	Yes	100.0
5532	Yes	Yes	Yes	Yes	Yes	Yes	Yes	Yes	Yes	Yes	100.0
5533	Yes	Yes	Yes	Yes	Yes	Yes	Yes	Yes	Yes	Yes	100.0
5534	Yes	Yes	Yes	Yes	Yes	Yes	Yes	Yes	Yes	Yes	100.0

5645	Yes	Yes	Yes	Yes	Yes	Yes	Yes	Yes	Yes	Yes	100.0
5646	Yes	Yes	Yes	Yes	Yes	Yes	Yes	Yes	Yes	Yes	100.0
5647	Yes	Yes	Yes	Yes	Yes	Yes	Yes	Yes	Yes	Yes	100.0
5648	Yes	Yes	Yes	Yes	Yes	Yes	Yes	Yes	Yes	Yes	100.0
5649 (FH)	Yes	Yes	Yes	Yes	Yes	Yes	Yes	Yes	Yes	Yes	100.0
5650	No	No	No	No	No	No	No	No	No	No	0.0

6.2.3 Channel Availability Check Time

If the EUT successfully detected the radar burst, it should be observed as the EUT has no transmissions occurred until the EUT starts transmitting on another channel.

Timing of Radar Signal	Observation	
	EUT	Spectrum Analyzer
Within 1 to 6 second	Detected	No transmissions
Within 54 to 60 second	Detected	No transmissions

Note: Worst case channel for final "Channel Availability Check" test.

Initial Channel Availability Check Time Channel Availability Check

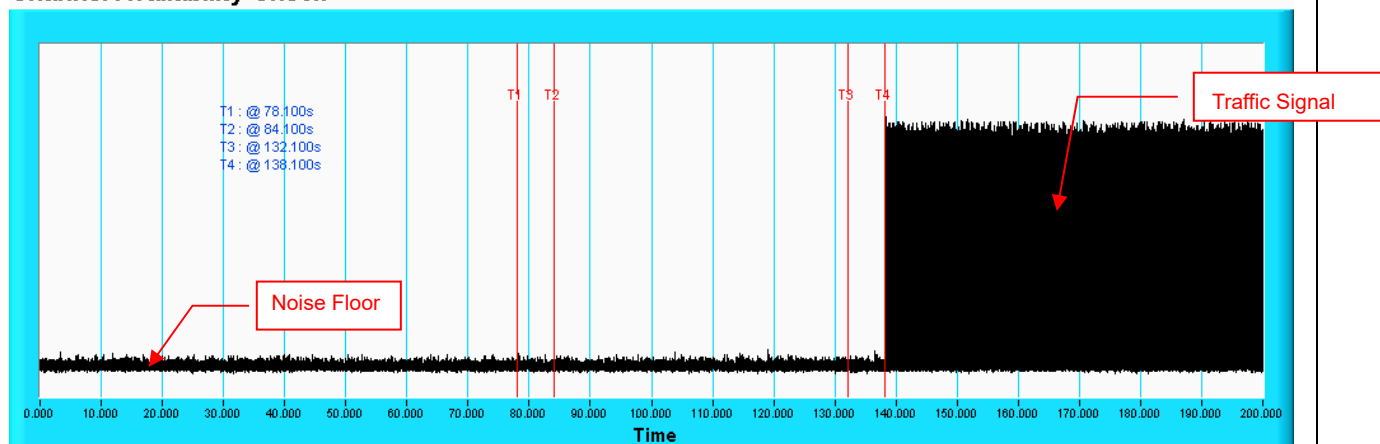

Note: T1 denotes the end of power-up time period is 78.1th second. T4 denotes the end of Channel Availability Check time is 138.1th second. Channel Availability Check time is equal to (T4 – T1) 60 seconds.

Radar Burst at the Beginning of the Channel Availability Check Time Channel Availability Check

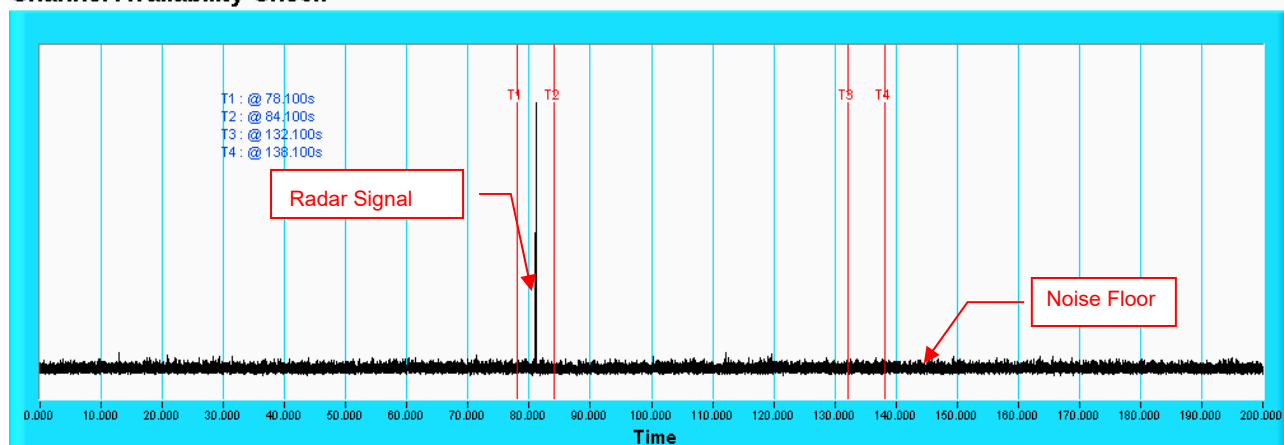

Note: T1 denotes the end of power up time period is 78.1th second. T2 denotes 84.1th second and the radar burst was commenced within a 6 second window starting from the end of power-up sequence. T4 denotes the 138.1th second.

Radar Burst at the End of the Channel Availability Check Time Channel Availability Check

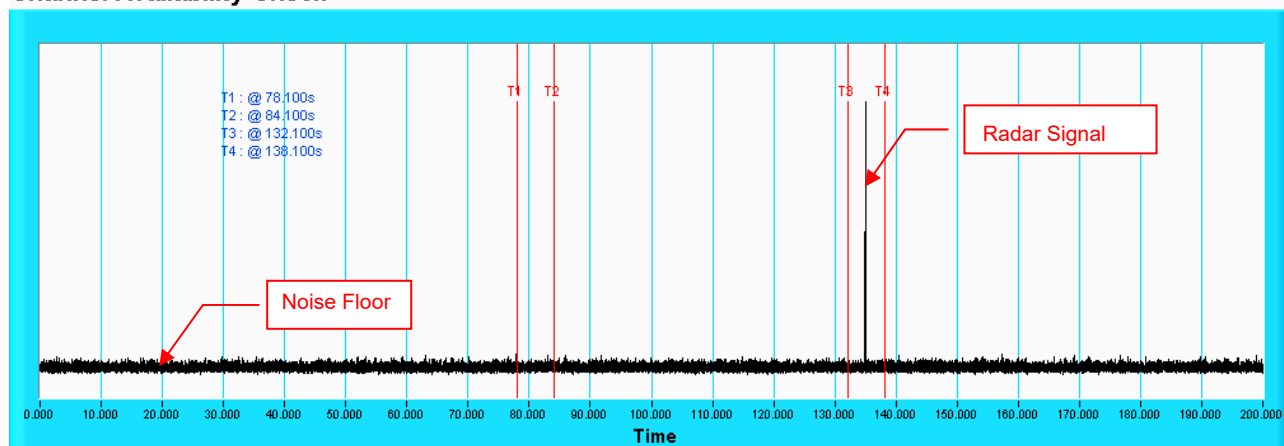

Note: T1 denotes the end of power up time period is 78.1th second. T3 denotes 84.1th second and the radar burst was commenced within 54th second to 60th second window starting from the end of power-up sequence. T4 denotes the 138.1th second.

6.2.4 Channel Closing Transmission and Channel Move Time

Wireless Traffic Loading 802.11be (EHT20) Duty Cycle

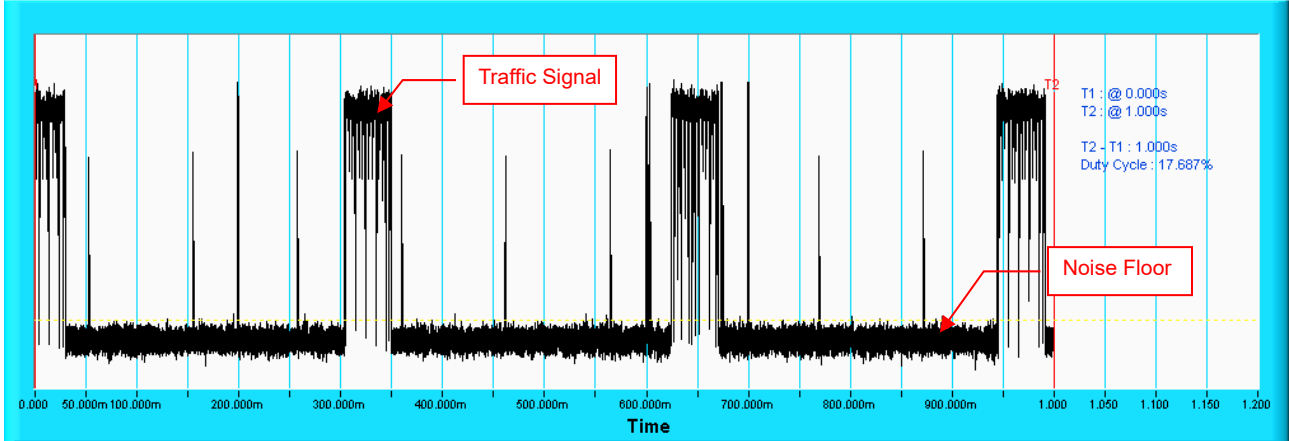

802.11be (EHT40) Duty Cycle

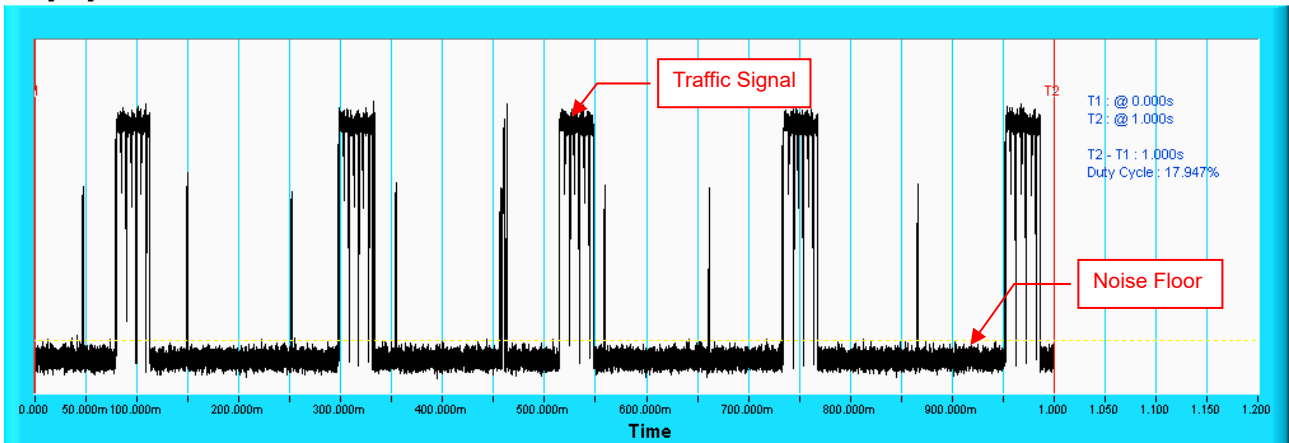

802.11be (EHT80) Duty Cycle

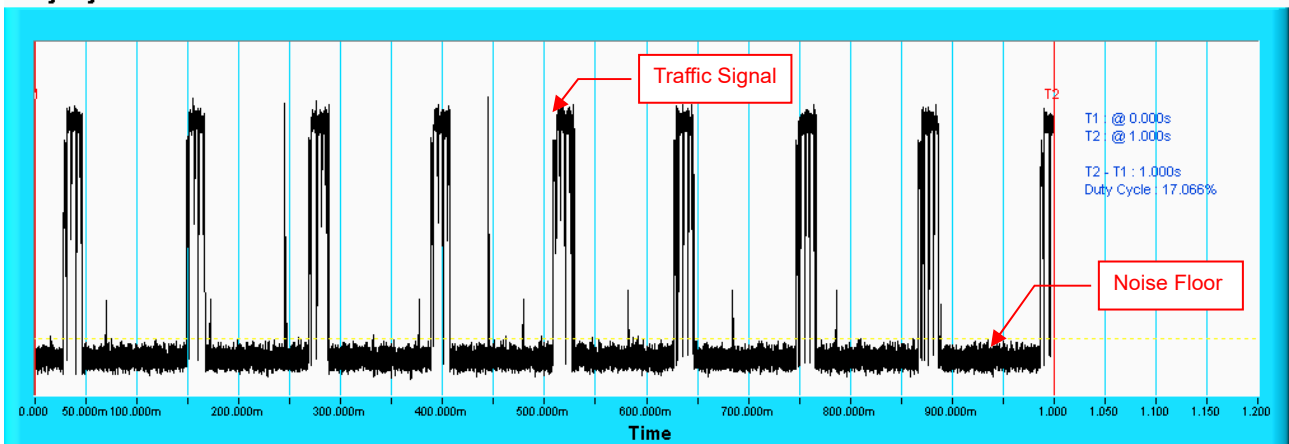

802.11be (EHT160) Duty Cycle

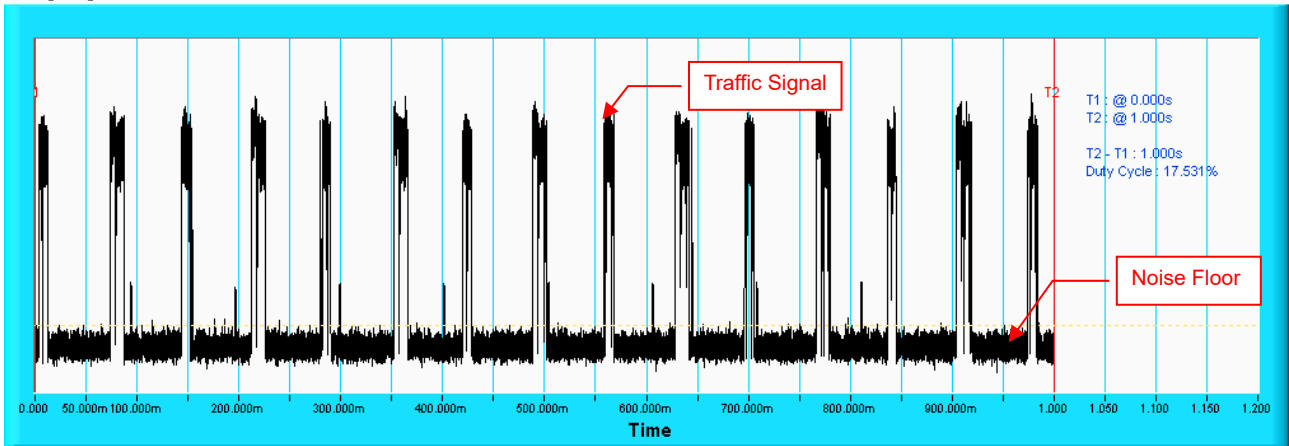

Note: Traffic signal: from master transmit to slave.

IEEE 802.11be (EHT20)

Table 1: Short Pulse Radar Test Waveforms.

Radar Type	Pulse Width (μsec)	PRI (μsec)	Number of Pulses	Number of Trials (Times)	Percentage of Successful Detection (%)
1	1	Test A: 15 unique PRI values randomly selected from the list of 23 PRI values in Table 5a	Roundup $\left\{ \begin{array}{l} \frac{1}{360} \cdot \\ \frac{19 \cdot 10^6}{\text{PRI}_{\mu\text{sec}}} \end{array} \right\}$	30	93.33
		Test B: 15 unique PRI values randomly selected within the range of 518-3066 μ sec, with a minimum increment of 1 μ sec, excluding PRI values selected in Test A			
2	1-5	150-230	23-29	30	70
3	6-10	200-500	16-18	30	83.33
4	11-20	200-500	12-16	30	76.67
Aggregate (Radar Types 1-4)				120	80.83

Table 2: Long Pulse Radar Test Waveform

Radar Type	Pulse Width (μsec)	Chirp Width (MHz)	PRI (μsec)	Number of Pulses per Burst	Number of Bursts	Number of Trials(Times)	Percentage of Successful Detection (%)
5	50-100	5-20	1000-2000	1-3	8-20	30	96.67

Table 3: Frequency Hopping Radar Test Waveform

Radar Type	Pulse Width (μsec)	PRI (μsec)	Pulses per Hop	Hopping Rate (kHz)	Hopping Sequence Length (msec)	Number of Trials(Times)	Percentage of Successful Detection (%)
6	1	333	9	0.333	300	30	100

The Detailed Radar pattern and Statistical Performance showed in Annex A.

IEEE 802.11be (EHT40)

Table 1: Short Pulse Radar Test Waveforms.

Radar Type	Pulse Width (μsec)	PRI (μsec)	Number of Pulses	Number of Trials (Times)	Percentage of Successful Detection (%)
1	1	Test A: 15 unique PRI values randomly selected from the list of 23 PRI values in Table 5a	Roundup $\left\{ \begin{array}{l} \left(\frac{1}{360} \right) \cdot \\ \left(\frac{19 \cdot 10^6}{\text{PRI}_{\mu\text{sec}}} \right) \end{array} \right\}$	30	100
		Test B: 15 unique PRI values randomly selected within the range of 518-3066 μ sec, with a minimum increment of 1 μ sec, excluding PRI values selected in Test A			
2	1-5	150-230	23-29	30	80
3	6-10	200-500	16-18	30	83.33
4	11-20	200-500	12-16	30	76.67
Aggregate (Radar Types 1-4)				120	85

Table 2: Long Pulse Radar Test Waveform

Radar Type	Pulse Width (μsec)	Chirp Width (MHz)	PRI (μsec)	Number of Pulses per Burst	Number of Bursts	Number of Trials(Times)	Percentage of Successful Detection (%)
5	50-100	5-20	1000-2000	1-3	8-20	30	100

Table 3: Frequency Hopping Radar Test Waveform

Radar Type	Pulse Width (μsec)	PRI (μsec)	Pulses per Hop	Hopping Rate (kHz)	Hopping Sequence Length (msec)	Number of Trials(Times)	Percentage of Successful Detection (%)
6	1	333	9	0.333	300	30	100

The Detailed Radar pattern and Statistical Performance showed in Annex A.

IEEE 802.11be (EHT80)

Table 1: Short Pulse Radar Test Waveforms.

Radar Type	Pulse Width (μsec)	PRI (μsec)	Number of Pulses	Number of Trials (Times)	Percentage of Successful Detection (%)
1	1	Test A: 15 unique PRI values randomly selected from the list of 23 PRI values in Table 5a	Roundup $\left\{ \left(\frac{1}{360} \right) \cdot \left(\frac{19 \cdot 10^6}{\text{PRI}_{\mu\text{sec}}} \right) \right\}$	30	93.33
		Test B: 15 unique PRI values randomly selected within the range of 518-3066 μ sec, with a minimum increment of 1 μ sec, excluding PRI values selected in Test A			
2	1-5	150-230	23-29	30	83.33
3	6-10	200-500	16-18	30	70
4	11-20	200-500	12-16	30	80
Aggregate (Radar Types 1-4)				120	81.67

Table 2: Long Pulse Radar Test Waveform

Radar Type	Pulse Width (μsec)	Chirp Width (MHz)	PRI (μsec)	Number of Pulses per Burst	Number of Bursts	Number of Trials(Times)	Percentage of Successful Detection (%)
5	50-100	5-20	1000-2000	1-3	8-20	30	93.33

Table 3: Frequency Hopping Radar Test Waveform

Radar Type	Pulse Width (μsec)	PRI (μsec)	Pulses per Hop	Hopping Rate (kHz)	Hopping Sequence Length (msec)	Number of Trials(Times)	Percentage of Successful Detection (%)
6	1	333	9	0.333	300	30	100

The Detailed Radar pattern and Statistical Performance showed in Annex A.

IEEE 802.11be (EHT160)_5250MHz

Table 1: Short Pulse Radar Test Waveforms.

Radar Type	Pulse Width (μsec)	PRI (μsec)	Number of Pulses	Number of Trials (Times)	Percentage of Successful Detection (%)
1	1	Test A: 15 unique PRI values randomly selected from the list of 23 PRI values in Table 5a	Roundup $\left\{ \left(\frac{1}{360} \right) \cdot \left(\frac{19 \cdot 10^6}{\text{PRI}_{\mu\text{sec}}} \right) \right\}$	30	96.67
		Test B: 15 unique PRI values randomly selected within the range of 518-3066 μ sec, with a minimum increment of 1 μ sec, excluding PRI values selected in Test A			
2	1-5	150-230	23-29	30	83.33
3	6-10	200-500	16-18	30	86.67
4	11-20	200-500	12-16	30	76.67
Aggregate (Radar Types 1-4)				120	85.83

Table 2: Long Pulse Radar Test Waveform

Radar Type	Pulse Width (μsec)	Chirp Width (MHz)	PRI (μsec)	Number of Pulses per Burst	Number of Bursts	Number of Trials(Times)	Percentage of Successful Detection (%)
5	50-100	5-20	1000-2000	1-3	8-20	30	96.67

Table 3: Frequency Hopping Radar Test Waveform

Radar Type	Pulse Width (μsec)	PRI (μsec)	Pulses per Hop	Hopping Rate (kHz)	Hopping Sequence Length (msec)	Number of Trials(Times)	Percentage of Successful Detection (%)
6	1	333	9	0.333	300	30	100

The Detailed Radar pattern and Statistical Performance showed in Annex A.

IEEE 802.11be (EHT160)_5570MHz

Table 1: Short Pulse Radar Test Waveforms.

Radar Type	Pulse Width (μsec)	PRI (μsec)	Number of Pulses	Number of Trials (Times)	Percentage of Successful Detection (%)
1	1	Test A: 15 unique PRI values randomly selected from the list of 23 PRI values in Table 5a	Roundup $\left\{ \left(\frac{1}{360} \right) \cdot \left(\frac{19 \cdot 10^6}{\text{PRI}_{\mu\text{sec}}} \right) \right\}$	30	100
		Test B: 15 unique PRI values randomly selected within the range of 518-3066 μ sec, with a minimum increment of 1 μ sec, excluding PRI values selected in Test A			
2	1-5	150-230	23-29	30	80
3	6-10	200-500	16-18	30	80
4	11-20	200-500	12-16	30	70
Aggregate (Radar Types 1-4)				120	82.5

Table 2: Long Pulse Radar Test Waveform

Radar Type	Pulse Width (μsec)	Chirp Width (MHz)	PRI (μsec)	Number of Pulses per Burst	Number of Bursts	Number of Trials(Times)	Percentage of Successful Detection (%)
5	50-100	5-20	1000-2000	1-3	8-20	30	96.67

Table 3: Frequency Hopping Radar Test Waveform

Radar Type	Pulse Width (μsec)	PRI (μsec)	Pulses per Hop	Hopping Rate (kHz)	Hopping Sequence Length (msec)	Number of Trials(Times)	Percentage of Successful Detection (%)
6	1	333	9	0.333	300	30	100

The Detailed Radar pattern and Statistical Performance showed in Annex A.

Radar signal 0
802.11be (EHT160)
Channel Closing Transmission Time & Channel Move Time

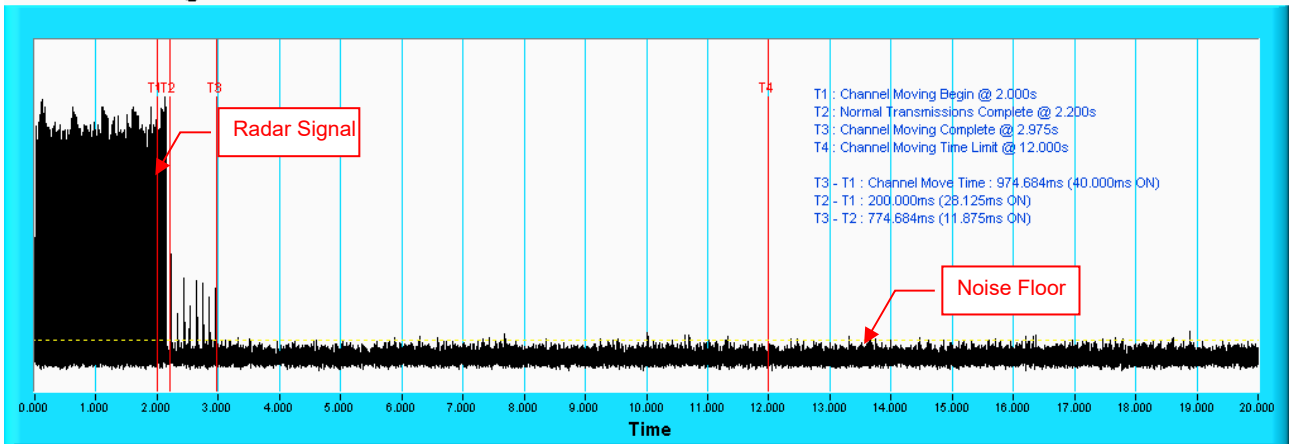

Note: T1 denotes the start of Channel Move Time upon the end of the last Radar burst. T2 denotes the data transmission time of 200ms from T1. T3 denotes the end of Channel Move Time. T4 denotes the 10 second from T1 to observe the aggregate duration of transmissions.

Channel Closing Transmission Time & Channel Move Time

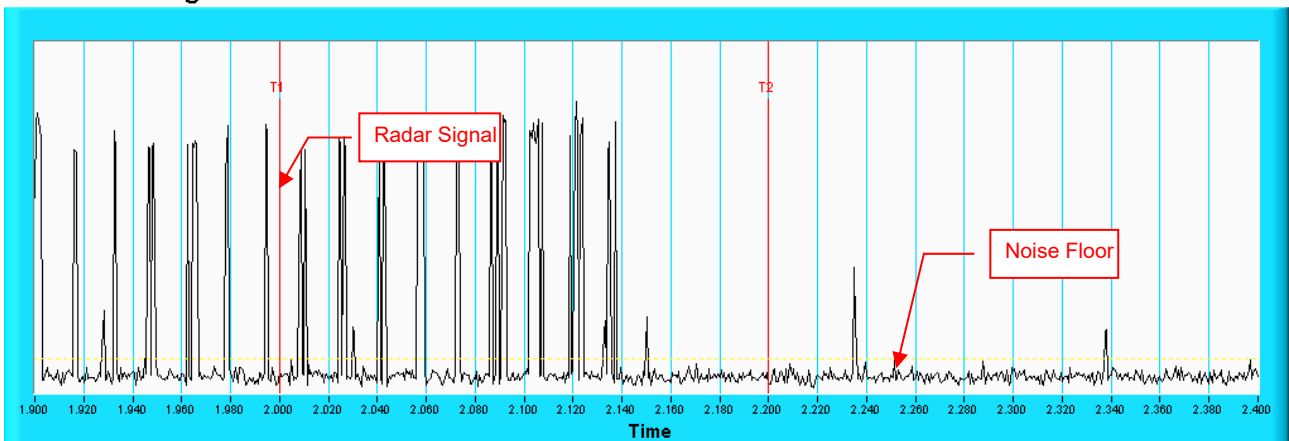

Note: Room-in of the first 500ms after radar signal applied.

Radar signal 1
802.11be (EHT160)
Channel Closing Transmission Time & Channel Move Time

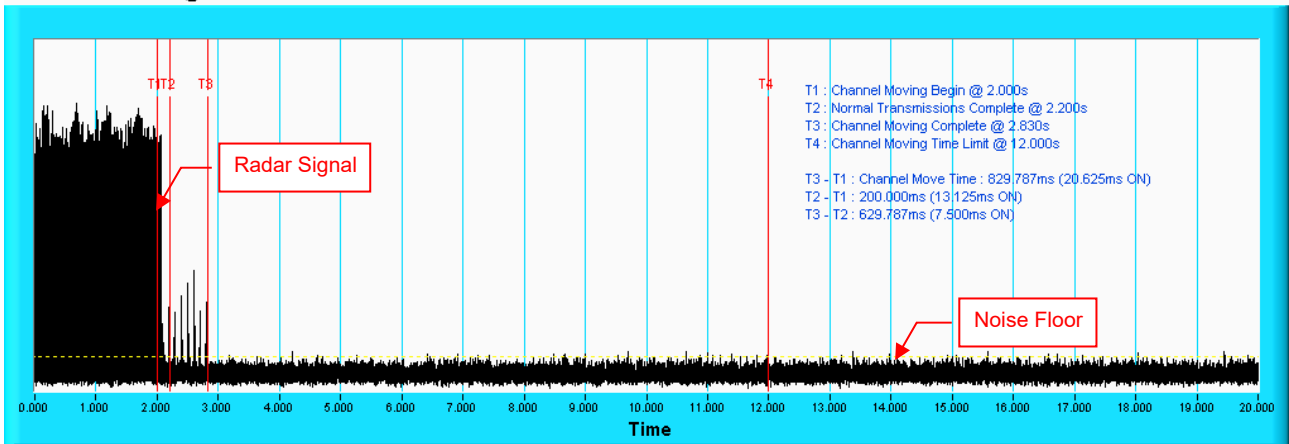

Note: T1 denotes the start of Channel Move Time upon the end of the last Radar burst. T2 denotes the data transmission time of 200ms from T1. T3 denotes the end of Channel Move Time. T4 denotes the 10 second from T1 to observe the aggregate duration of transmissions.

Channel Closing Transmission Time & Channel Move Time

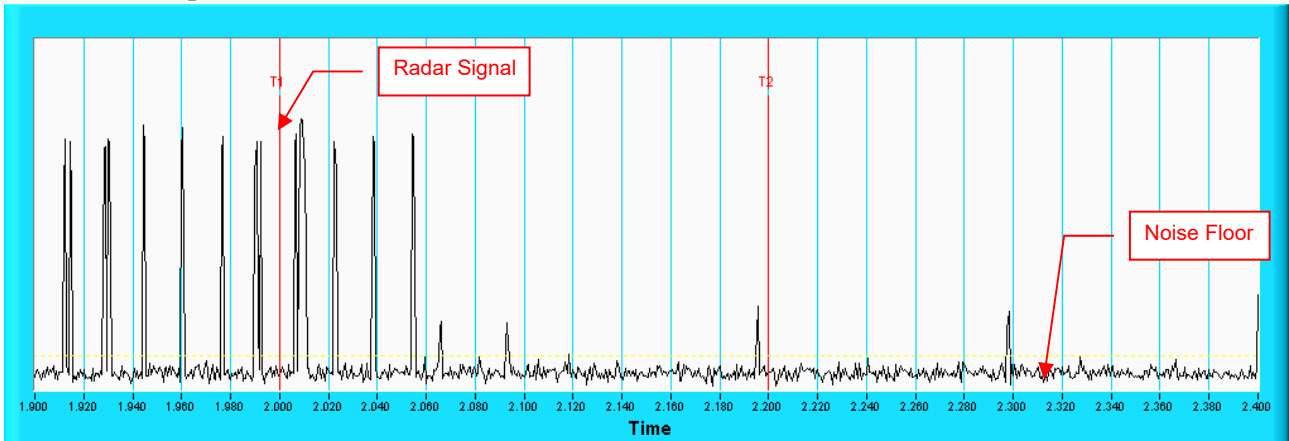

Note: Room-in of the first 500ms after radar signal applied.

Radar signal 2
802.11be (EHT160)
Channel Closing Transmission Time & Channel Move Time

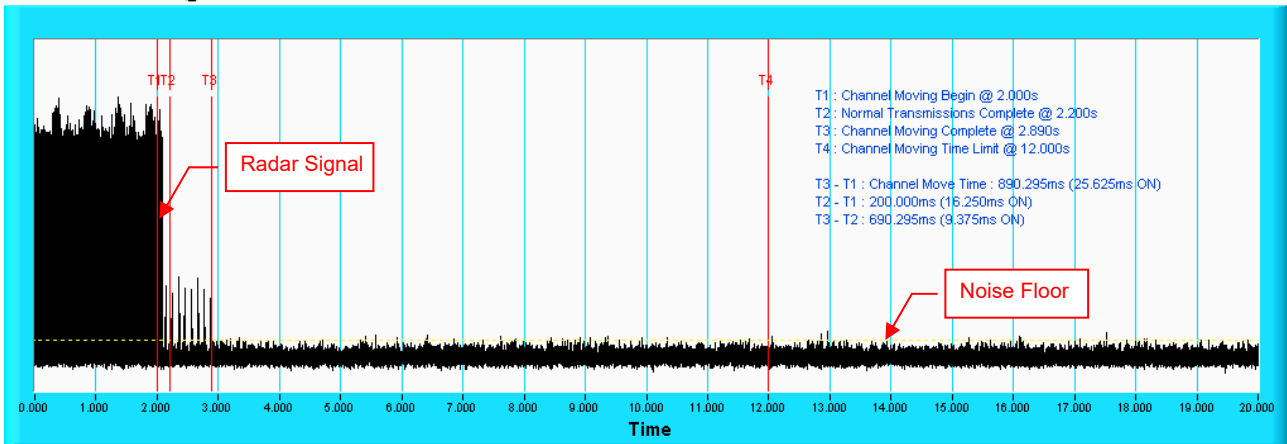

Note: T1 denotes the start of Channel Move Time upon the end of the last Radar burst. T2 denotes the data transmission time of 200ms from T1. T3 denotes the end of Channel Move Time. T4 denotes the 10 second from T1 to observe the aggregate duration of transmissions.

Channel Closing Transmission Time & Channel Move Time

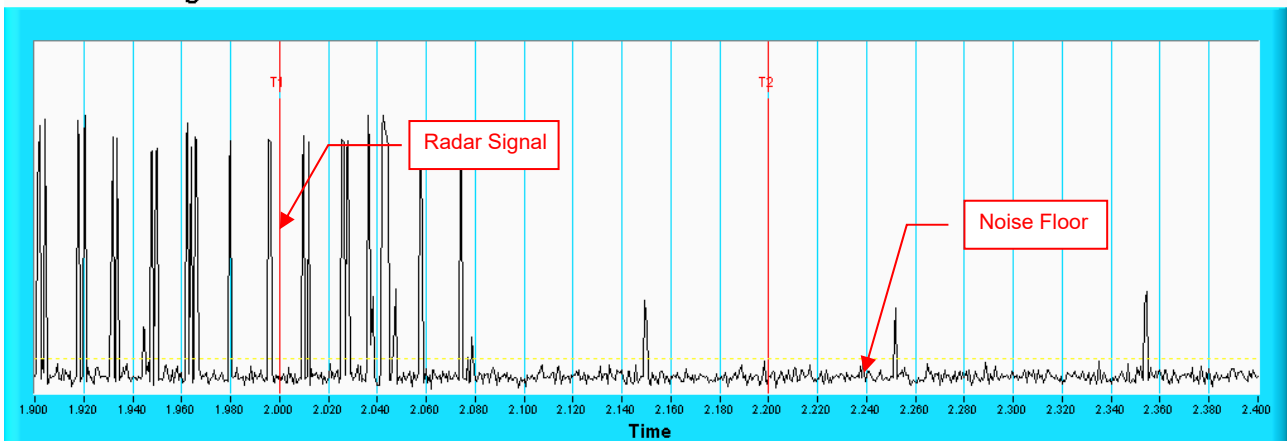

Note: Room-in of the first 500ms after radar signal applied.

Radar signal 3
802.11be (EHT160)
Channel Closing Transmission Time & Channel Move Time

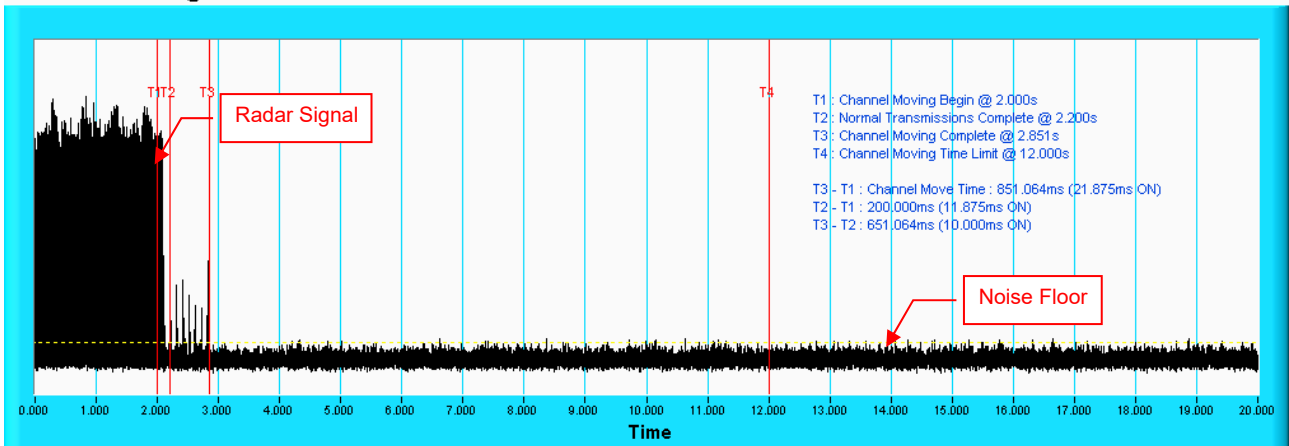

Note: T1 denotes the start of Channel Move Time upon the end of the last Radar burst. T2 denotes the data transmission time of 200ms from T1. T3 denotes the end of Channel Move Time. T4 denotes the 10 second from T1 to observe the aggregate duration of transmissions.

Channel Closing Transmission Time & Channel Move Time

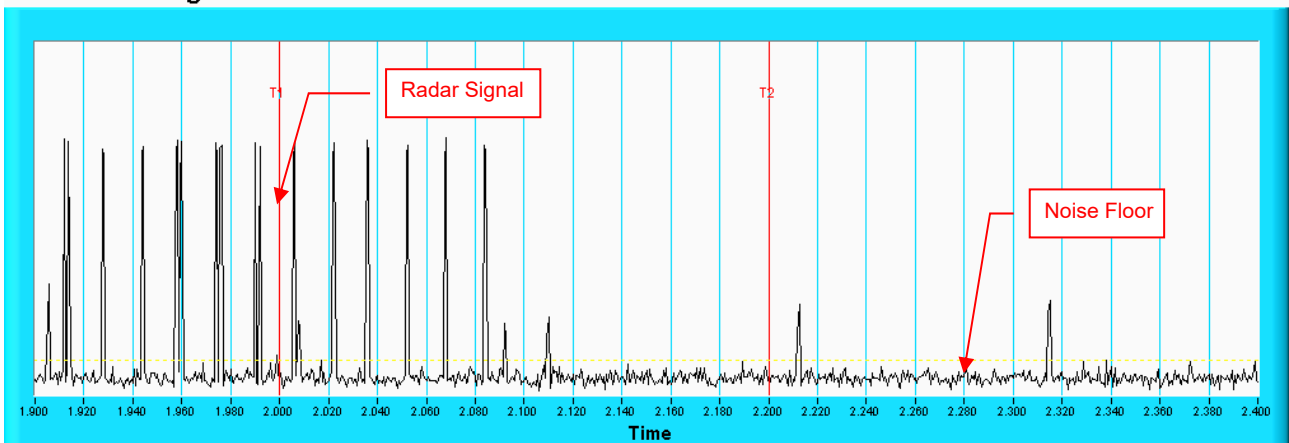

Note: Room-in of the first 500ms after radar signal applied.

Radar signal 4
802.11be (EHT160)
Channel Closing Transmission Time & Channel Move Time

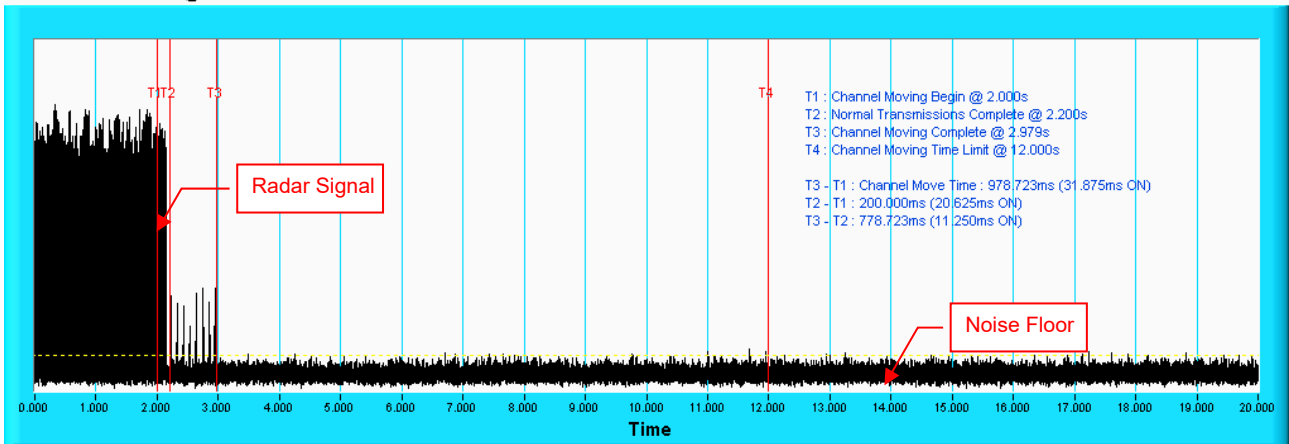

Note: T1 denotes the start of Channel Move Time upon the end of the last Radar burst. T2 denotes the data transmission time of 200ms from T1. T3 denotes the end of Channel Move Time. T4 denotes the 10 second from T1 to observe the aggregate duration of transmissions.

Channel Closing Transmission Time & Channel Move Time

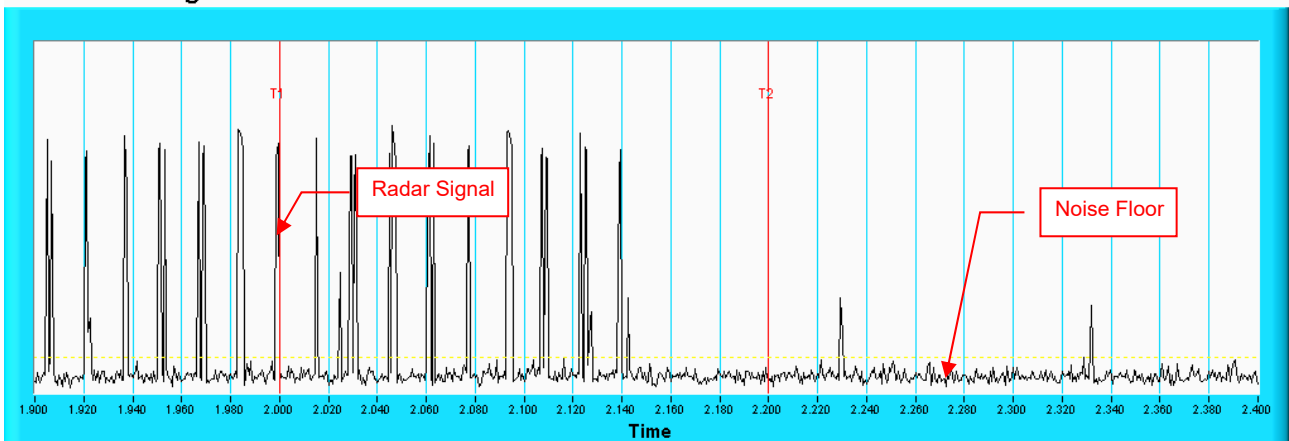

Note: Room-in of the first 500ms after radar signal applied.

802.11be (EHT20)

Type 1 Radar Statistical Performances

Trial #	Test Frequency (MHz)	Pulse Repetition Frequency Number (1 to 23)	Pulse Repetition Frequency (Pulse per seconds)	Pulses per Burst	Pulse Repetition Interval (microseconds)	Detection
1	5506	15	1253	67	798	No
2	5492	16	1223	65	818	Yes
3	5494	4	1730	92	578	Yes
4	5499	11	1393	74	718	Yes
5	5495	22	1066	57	938	Yes
6	5509	7	1567	83	638	Yes
7	5502	2	1859	99	538	Yes
8	5508	8	1520	81	658	Yes
9	5493	1	1931	102	518	Yes
10	5497	19	1139	61	878	Yes
11	5496	21	1089	58	918	Yes
12	5498	23	326.2	18	3066	Yes
13	5491	9	1475	78	678	Yes
14	5507	5	1672	89	598	Yes
15	5503	6	1618	86	618	Yes
16	5505		1111	59	900	Yes
17	5500		1024	55	977	Yes
18	5504		625.8	34	1598	Yes
19	5501		730.5	39	1369	Yes
20	5494		1181	63	847	Yes
21	5506		400.6	22	2496	Yes
22	5495		529.4	28	1889	Yes
23	5501		347.6	19	2877	Yes
24	5502		641.4	34	1559	Yes
25	5496		508.9	27	1965	Yes
26	5491		345.4	19	2895	Yes
27	5493		580.7	31	1722	No
28	5497		786.8	42	1271	Yes
29	5500		808.4	43	1237	Yes
30	5498		517.1	28	1934	Yes
Detection Rate: 93.33%						

Type 2 Radar Statistical Performances

Trial #	Test Frequency (MHz)	Pulses per Burst	Pulse Width(us)	PRI(us)	Detection
1	5496	24	1.7	174	Yes
2	5508	27	3.8	176	No
3	5493	28	4	161	No
4	5503	28	4.3	226	Yes
5	5498	24	1.9	193	No
6	5500	23	1.1	230	Yes
7	5507	29	4.5	198	Yes
8	5495	26	2.9	227	Yes
9	5504	26	2.8	171	Yes
10	5506	27	3.6	221	Yes
11	5499	23	1.1	180	No
12	5492	23	1.3	189	Yes
13	5502	25	2.5	204	Yes
14	5505	29	4.5	203	Yes
15	5501	29	5	170	Yes
16	5491	26	3.1	201	No
17	5497	24	2.1	218	Yes
18	5494	25	2.6	208	Yes
19	5509	24	1.8	223	No
20	5501	23	1.2	220	Yes
21	5508	26	2.9	224	Yes
22	5493	28	4	160	Yes
23	5491	25	2.5	209	No
24	5492	23	1	205	No
25	5496	27	3.7	151	Yes
26	5505	25	2.5	186	Yes
27	5500	23	1.5	190	Yes
28	5498	23	1.3	185	Yes
29	5495	23	1.2	175	No
30	5507	24	1.7	216	Yes
Detection Rate: 70 %					

Type 3 Radar Statistical Performances

Trial #	Test Frequency (MHz)	Pulses per Burst	Pulse Width(us)	PRI(us)	Detection
1	5508	16	6.7	467	Yes
2	5494	18	8.8	304	Yes
3	5492	18	9	316	Yes
4	5491	18	9.3	439	Yes
5	5503	16	6.9	420	Yes
6	5496	16	6.1	249	Yes
7	5497	18	9.5	463	Yes
8	5501	17	7.9	258	Yes
9	5495	17	7.8	212	Yes
10	5509	17	8.6	236	No
11	5504	16	6.1	474	No
12	5499	16	6.3	461	Yes
13	5505	17	7.5	437	Yes
14	5493	18	9.5	287	Yes
15	5502	18	10	395	Yes
16	5506	17	8.1	322	Yes
17	5507	16	7.1	468	No
18	5500	17	7.6	255	Yes
19	5498	16	6.8	423	Yes
20	5495	16	6.2	456	Yes
21	5499	17	7.9	351	No
22	5491	18	9	411	Yes
23	5496	17	7.5	279	Yes
24	5498	16	6	431	Yes
25	5506	17	8.7	324	No
26	5494	17	7.5	419	Yes
27	5493	16	6.5	447	Yes
28	5492	16	6.3	481	Yes
29	5500	16	6.2	438	Yes
30	5501	16	6.7	270	Yes
Detection Rate: 83.33%					

Type 4 Radar Statistical Performances

Trial #	Test Frequency (MHz)	Pulses per Burst	Pulse Width(us)	PRI(us)	Detection
1	5505	12	12.5	467	Yes
2	5503	15	17.2	304	Yes
3	5493	15	17.8	316	Yes
4	5491	16	18.5	439	No
5	5496	13	13.1	420	Yes
6	5495	12	11.3	249	Yes
7	5504	16	18.8	463	Yes
8	5501	14	15.3	258	Yes
9	5492	14	15.1	212	Yes
10	5506	15	16.9	236	No
11	5509	12	11.2	474	Yes
12	5494	12	11.7	461	Yes
13	5500	13	14.4	437	Yes
14	5499	16	18.9	287	No
15	5497	16	19.9	395	No
16	5502	14	15.7	322	Yes
17	5508	13	13.4	468	Yes
18	5507	13	14.5	255	No
19	5498	13	12.9	423	Yes
20	5500	12	11.5	456	Yes
21	5502	14	15.3	351	Yes
22	5498	15	17.8	411	Yes
23	5503	13	14.3	279	Yes
24	5508	12	11.1	431	Yes
25	5496	15	17	324	No
26	5506	13	14.5	419	No
27	5494	12	12.1	447	Yes
28	5501	12	11.7	481	Yes
29	5497	12	11.6	438	Yes
30	5504	12	12.7	270	Yes
Detection Rate: 76.67 %					

Type 5 Radar Statistical Performances

Trial #	Minimum Chirp Width(MHz)	Chirp Center Frequency(MHz)	Test Signal Name	Detection
1	16	5500.0	LP_Signal_01	Yes
2	15	5500.0	LP_Signal_02	Yes
3	12	5500.0	LP_Signal_03	Yes
4	13	5500.0	LP_Signal_04	Yes
5	15	5500.0	LP_Signal_05	Yes
6	18	5500.0	LP_Signal_06	Yes
7	10	5500.0	LP_Signal_07	Yes
8	13	5500.0	LP_Signal_08	Yes
9	7	5500.0	LP_Signal_09	Yes
10	6	5500.0	LP_Signal_10	Yes
11	15	5496.5	LP_Signal_11	Yes
12	18	5497.7	LP_Signal_12	Yes
13	12	5495.3	LP_Signal_13	Yes
14	9	5494.1	LP_Signal_14	Yes
15	17	5497.3	LP_Signal_15	Yes
16	11	5494.9	LP_Signal_16	Yes
17	19	5498.1	LP_Signal_17	Yes
18	9	5494.1	LP_Signal_18	Yes
19	11	5494.9	LP_Signal_19	Yes
20	9	5494.1	LP_Signal_20	Yes
21	14	5503.97	LP_Signal_21	Yes
22	8	5506.37	LP_Signal_22	Yes
23	19	5501.97	LP_Signal_23	Yes
24	11	5505.17	LP_Signal_24	Yes
25	10	5505.57	LP_Signal_25	Yes
26	5	5507.57	LP_Signal_26	Yes
27	15	5503.57	LP_Signal_27	Yes
28	18	5502.37	LP_Signal_28	Yes
29	9	5505.97	LP_Signal_29	Yes
30	16	5503.17	LP_Signal_30	No
Detection Rate: 96.67 %				

The Long Pulse Radar pattern shown in Appendix A.1

Type 6 Radar Statistical Performances

Trial #	Pulses per Burst	Pulse Width(us)	PRI(us)	Detection
1	9	1	333.3	Yes
2	9	1	333.3	Yes
3	9	1	333.3	Yes
4	9	1	333.3	Yes
5	9	1	333.3	Yes
6	9	1	333.3	Yes
7	9	1	333.3	Yes
8	9	1	333.3	Yes
9	9	1	333.3	Yes
10	9	1	333.3	Yes
11	9	1	333.3	Yes
12	9	1	333.3	Yes
13	9	1	333.3	Yes
14	9	1	333.3	Yes
15	9	1	333.3	Yes
16	9	1	333.3	Yes
17	9	1	333.3	Yes
18	9	1	333.3	Yes
19	9	1	333.3	Yes
20	9	1	333.3	Yes
21	9	1	333.3	Yes
22	9	1	333.3	Yes
23	9	1	333.3	Yes
24	9	1	333.3	Yes
25	9	1	333.3	Yes
26	9	1	333.3	Yes
27	9	1	333.3	Yes
28	9	1	333.3	Yes
29	9	1	333.3	Yes
30	9	1	333.3	Yes
Detection Rate: 100 %				

Type 6 Radar Statistical Performances

Trial #	Hopping Frequency Sequence Name	Detection
1	HOP_FREQ_SEQ_01	Yes
2	HOP_FREQ_SEQ_02	Yes
3	HOP_FREQ_SEQ_03	Yes
4	HOP_FREQ_SEQ_04	Yes
5	HOP_FREQ_SEQ_05	Yes
6	HOP_FREQ_SEQ_06	Yes
7	HOP_FREQ_SEQ_07	Yes
8	HOP_FREQ_SEQ_08	Yes
9	HOP_FREQ_SEQ_09	Yes
10	HOP_FREQ_SEQ_10	Yes
11	HOP_FREQ_SEQ_11	Yes
12	HOP_FREQ_SEQ_12	Yes
13	HOP_FREQ_SEQ_13	Yes
14	HOP_FREQ_SEQ_14	Yes
15	HOP_FREQ_SEQ_15	Yes
16	HOP_FREQ_SEQ_16	Yes
17	HOP_FREQ_SEQ_17	Yes
18	HOP_FREQ_SEQ_18	Yes
19	HOP_FREQ_SEQ_19	Yes
20	HOP_FREQ_SEQ_20	Yes
21	HOP_FREQ_SEQ_21	Yes
22	HOP_FREQ_SEQ_22	Yes
23	HOP_FREQ_SEQ_23	Yes
24	HOP_FREQ_SEQ_24	Yes
25	HOP_FREQ_SEQ_25	Yes
26	HOP_FREQ_SEQ_26	Yes
27	HOP_FREQ_SEQ_27	Yes
28	HOP_FREQ_SEQ_28	Yes
29	HOP_FREQ_SEQ_29	Yes
30	HOP_FREQ_SEQ_30	Yes
Detection Rate: 100 %		

The Frequency Hopping Radar pattern shown in Appendix A.2

802.11be (EHT40)

Type 1 Radar Statistical Performances

Trial #	Test Frequency (MHz)	Pulse Repetition Frequency Number (1 to 23)	Pulse Repetition Frequency (Pulse per seconds)	Pulses per Burst	Pulse Repetition Interval (microseconds)	Detection
1	5501	15	1253	67	798	Yes
2	5494	16	1223	65	818	Yes
3	5524	4	1730	92	578	Yes
4	5510	11	1393	74	718	Yes
5	5504	22	1066	57	938	Yes
6	5492	7	1567	83	638	Yes
7	5514	2	1859	99	538	Yes
8	5495	8	1520	81	658	Yes
9	5497	1	1931	102	518	Yes
10	5521	19	1139	61	878	Yes
11	5500	21	1089	58	918	Yes
12	5525	23	326.2	18	3066	Yes
13	5498	9	1475	78	678	Yes
14	5520	5	1672	89	598	Yes
15	5506	6	1618	86	618	Yes
16	5518		1111	59	900	Yes
17	5515		1024	55	977	Yes
18	5516		625.8	34	1598	Yes
19	5503		730.5	39	1369	Yes
20	5493		1181	63	847	Yes
21	5512		400.6	22	2496	Yes
22	5507		529.4	28	1889	Yes
23	5513		347.6	19	2877	Yes
24	5508		641.4	34	1559	Yes
25	5522		508.9	27	1965	Yes
26	5496		345.4	19	2895	Yes
27	5511		580.7	31	1722	Yes
28	5519		786.8	42	1271	Yes
29	5517		808.4	43	1237	Yes
30	5502		517.1	28	1934	Yes
Detection Rate: 100 %						

Type 2 Radar Statistical Performances

Trial #	Test Frequency (MHz)	Pulses per Burst	Pulse Width(us)	PRI(us)	Detection
1	5518	24	1.7	174	Yes
2	5510	27	3.8	176	Yes
3	5524	28	4	161	Yes
4	5495	28	4.3	226	Yes
5	5496	24	1.9	193	No
6	5512	23	1.1	230	Yes
7	5499	29	4.5	198	Yes
8	5525	26	2.9	227	Yes
9	5527	26	2.8	171	Yes
10	5506	27	3.6	221	Yes
11	5498	23	1.1	180	Yes
12	5497	23	1.3	189	No
13	5492	25	2.5	204	Yes
14	5513	29	4.5	203	Yes
15	5516	29	5	170	Yes
16	5504	26	3.1	201	No
17	5493	24	2.1	218	Yes
18	5509	25	2.6	208	Yes
19	5501	24	1.8	223	No
20	5514	23	1.2	220	Yes
21	5494	26	2.9	224	Yes
22	5517	28	4	160	Yes
23	5520	25	2.5	209	Yes
24	5515	23	1	205	No
25	5522	27	3.7	151	Yes
26	5521	25	2.5	186	Yes
27	5528	23	1.5	190	No
28	5500	23	1.3	185	Yes
29	5503	23	1.2	175	Yes
30	5507	24	1.7	216	Yes
Detection Rate: 80 %					

Type 3 Radar Statistical Performances

Trial #	Test Frequency (MHz)	Pulses per Burst	Pulse Width(us)	PRI(us)	Detection
1	5526	16	6.7	467	Yes
2	5511	18	8.8	304	Yes
3	5504	18	9	316	No
4	5507	18	9.3	439	Yes
5	5528	16	6.9	420	Yes
6	5501	16	6.1	249	Yes
7	5514	18	9.5	463	Yes
8	5493	17	7.9	258	Yes
9	5492	17	7.8	212	Yes
10	5510	17	8.6	236	Yes
11	5518	16	6.1	474	Yes
12	5499	16	6.3	461	Yes
13	5497	17	7.5	437	Yes
14	5505	18	9.5	287	No
15	5506	18	10	395	No
16	5519	17	8.1	322	Yes
17	5524	16	7.1	468	Yes
18	5495	17	7.6	255	Yes
19	5498	16	6.8	423	Yes
20	5523	16	6.2	456	Yes
21	5509	17	7.9	351	No
22	5502	18	9	411	Yes
23	5494	17	7.5	279	Yes
24	5522	16	6	431	Yes
25	5500	17	8.7	324	Yes
26	5513	17	7.5	419	Yes
27	5508	16	6.5	447	Yes
28	5517	16	6.3	481	No
29	5520	16	6.2	438	Yes
30	5521	16	6.7	270	Yes
Detection Rate: 83.33%					

Type 4 Radar Statistical Performances

Trial #	Test Frequency (MHz)	Pulses per Burst	Pulse Width(us)	PRI(us)	Detection
1	5515	12	12.5	467	Yes
2	5493	15	17.2	304	Yes
3	5520	15	17.8	316	Yes
4	5502	16	18.5	439	No
5	5496	13	13.1	420	Yes
6	5510	12	11.3	249	Yes
7	5498	16	18.8	463	Yes
8	5521	14	15.3	258	Yes
9	5508	14	15.1	212	Yes
10	5513	15	16.9	236	Yes
11	5499	12	11.2	474	Yes
12	5512	12	11.7	461	No
13	5494	13	14.4	437	Yes
14	5505	16	18.9	287	No
15	5506	16	19.9	395	Yes
16	5507	14	15.7	322	Yes
17	5517	13	13.4	468	Yes
18	5504	13	14.5	255	Yes
19	5528	13	12.9	423	Yes
20	5495	12	11.5	456	Yes
21	5526	14	15.3	351	No
22	5522	15	17.8	411	No
23	5514	13	14.3	279	Yes
24	5527	12	11.1	431	Yes
25	5500	15	17	324	Yes
26	5492	13	14.5	419	Yes
27	5509	12	12.1	447	Yes
28	5519	12	11.7	481	No
29	5497	12	11.6	438	Yes
30	5501	12	12.7	270	No
Detection Rate: 76.67 %					

Type 5 Radar Statistical Performances

Trial #	Minimum Chirp Width(MHz)	Chirp Center Frequency(MHz)	Test Signal Name	Detection
1	7	5510.00	LP_Signal_01	Yes
2	16	5510.00	LP_Signal_02	Yes
3	6	5510.00	LP_Signal_03	Yes
4	19	5510.00	LP_Signal_04	Yes
5	8	5510.00	LP_Signal_05	Yes
6	5	5510.00	LP_Signal_06	Yes
7	11	5510.00	LP_Signal_07	Yes
8	20	5510.00	LP_Signal_08	Yes
9	12	5510.00	LP_Signal_09	Yes
10	16	5510.00	LP_Signal_10	Yes
11	16	5497.57	LP_Signal_11	Yes
12	19	5498.77	LP_Signal_12	Yes
13	13	5496.37	LP_Signal_13	Yes
14	10	5495.17	LP_Signal_14	Yes
15	18	5498.37	LP_Signal_15	Yes
16	12	5495.97	LP_Signal_16	Yes
17	20	5499.17	LP_Signal_17	Yes
18	10	5495.17	LP_Signal_18	Yes
19	12	5495.97	LP_Signal_19	Yes
20	10	5495.17	LP_Signal_20	Yes
21	15	5522.95	LP_Signal_21	Yes
22	9	5525.35	LP_Signal_22	Yes
23	20	5520.95	LP_Signal_23	Yes
24	12	5524.15	LP_Signal_24	Yes
25	11	5524.55	LP_Signal_25	Yes
26	5	5526.95	LP_Signal_26	Yes
27	16	5522.55	LP_Signal_27	Yes
28	19	5521.35	LP_Signal_28	Yes
29	10	5524.95	LP_Signal_29	Yes
30	17	5522.15	LP_Signal_30	Yes
Detection Rate: 100 %				

The Long Pulse Radar pattern shown in Appendix A.1

Type 6 Radar Statistical Performances

Trial #	Pulses per Burst	Pulse Width(us)	PRI(us)	Detection
1	9	1	333.3	Yes
2	9	1	333.3	Yes
3	9	1	333.3	Yes
4	9	1	333.3	Yes
5	9	1	333.3	Yes
6	9	1	333.3	Yes
7	9	1	333.3	Yes
8	9	1	333.3	Yes
9	9	1	333.3	Yes
10	9	1	333.3	Yes
11	9	1	333.3	Yes
12	9	1	333.3	Yes
13	9	1	333.3	Yes
14	9	1	333.3	Yes
15	9	1	333.3	Yes
16	9	1	333.3	Yes
17	9	1	333.3	Yes
18	9	1	333.3	Yes
19	9	1	333.3	Yes
20	9	1	333.3	Yes
21	9	1	333.3	Yes
22	9	1	333.3	Yes
23	9	1	333.3	Yes
24	9	1	333.3	Yes
25	9	1	333.3	Yes
26	9	1	333.3	Yes
27	9	1	333.3	Yes
28	9	1	333.3	Yes
29	9	1	333.3	Yes
30	9	1	333.3	Yes
Detection Rate: 100 %				

Type 6 Radar Statistical Performances

Trial #	Hopping Frequency Sequence Name	Detection
1	HOP_FREQ_SEQ_01	Yes
2	HOP_FREQ_SEQ_02	Yes
3	HOP_FREQ_SEQ_03	Yes
4	HOP_FREQ_SEQ_04	Yes
5	HOP_FREQ_SEQ_05	Yes
6	HOP_FREQ_SEQ_06	Yes
7	HOP_FREQ_SEQ_07	Yes
8	HOP_FREQ_SEQ_08	Yes
9	HOP_FREQ_SEQ_09	Yes
10	HOP_FREQ_SEQ_10	Yes
11	HOP_FREQ_SEQ_11	Yes
12	HOP_FREQ_SEQ_12	Yes
13	HOP_FREQ_SEQ_13	Yes
14	HOP_FREQ_SEQ_14	Yes
15	HOP_FREQ_SEQ_15	Yes
16	HOP_FREQ_SEQ_16	Yes
17	HOP_FREQ_SEQ_17	Yes
18	HOP_FREQ_SEQ_18	Yes
19	HOP_FREQ_SEQ_19	Yes
20	HOP_FREQ_SEQ_20	Yes
21	HOP_FREQ_SEQ_21	Yes
22	HOP_FREQ_SEQ_22	Yes
23	HOP_FREQ_SEQ_23	Yes
24	HOP_FREQ_SEQ_24	Yes
25	HOP_FREQ_SEQ_25	Yes
26	HOP_FREQ_SEQ_26	Yes
27	HOP_FREQ_SEQ_27	Yes
28	HOP_FREQ_SEQ_28	Yes
29	HOP_FREQ_SEQ_29	Yes
30	HOP_FREQ_SEQ_30	Yes
Detection Rate: 100 %		

The Frequency Hopping Radar pattern shown in Appendix A.2

802.11be (EHT80)

Type 1 Radar Statistical Performances

Trial #	Test Frequency (MHz)	Pulse Repetition Frequency Number (1 to 23)	Pulse Repetition Frequency (Pulse per seconds)	Pulses per Burst	Pulse Repetition Interval (microseconds)	Detection
1	5566	15	1253	67	798	Yes
2	5500	16	1223	65	818	Yes
3	5494	4	1730	92	578	Yes
4	5534	11	1393	74	718	Yes
5	5496	22	1066	57	938	Yes
6	5524	7	1567	83	638	Yes
7	5498	2	1859	99	538	Yes
8	5499	8	1520	81	658	Yes
9	5544	1	1931	102	518	Yes
10	5501	19	1139	61	878	No
11	5540	21	1089	58	918	Yes
12	5512	23	326.2	18	3066	Yes
13	5538	9	1475	78	678	Yes
14	5505	5	1672	89	598	Yes
15	5533	6	1618	86	618	Yes
16	5514		1111	59	900	Yes
17	5531		1024	55	977	No
18	5529		625.8	34	1598	Yes
19	5555		730.5	39	1369	Yes
20	5526		1181	63	847	Yes
21	5507		400.6	22	2496	Yes
22	5523		529.4	28	1889	Yes
23	5503		347.6	19	2877	Yes
24	5493		641.4	34	1559	Yes
25	5508		508.9	27	1965	Yes
26	5520		345.4	19	2895	Yes
27	5564		580.7	31	1722	Yes
28	5535		786.8	42	1271	Yes
29	5557		808.4	43	1237	Yes
30	5504		517.1	28	1934	Yes
Detection Rate: 93.33 %						

Type 2 Radar Statistical Performances

Trial #	Test Frequency (MHz)	Pulses per Burst	Pulse Width(us)	PRI(us)	Detection
1	5547	24	1.7	174	Yes
2	5539	27	3.8	176	Yes
3	5565	28	4	161	Yes
4	5564	28	4.3	226	No
5	5550	24	1.9	193	Yes
6	5553	23	1.1	230	Yes
7	5498	29	4.5	198	Yes
8	5563	26	2.9	227	Yes
9	5499	26	2.8	171	No
10	5543	27	3.6	221	Yes
11	5533	23	1.1	180	Yes
12	5561	23	1.3	189	No
13	5557	25	2.5	204	Yes
14	5559	29	4.5	203	Yes
15	5556	29	5	170	Yes
16	5507	26	3.1	201	Yes
17	5545	24	2.1	218	Yes
18	5519	25	2.6	208	Yes
19	5546	24	1.8	223	Yes
20	5520	23	1.2	220	Yes
21	5512	26	2.9	224	No
22	5528	28	4	160	Yes
23	5551	25	2.5	209	Yes
24	5524	23	1	205	Yes
25	5516	27	3.7	151	No
26	5505	25	2.5	186	Yes
27	5518	23	1.5	190	Yes
28	5509	23	1.3	185	Yes
29	5554	23	1.2	175	Yes
30	5562	24	1.7	216	Yes
Detection Rate: 83.33 %					

Type 3 Radar Statistical Performances

Trial #	Test Frequency (MHz)	Pulses per Burst	Pulse Width(us)	PRI(us)	Detection
1	5492	16	6.7	467	Yes
2	5493	18	8.8	304	No
3	5544	18	9	316	Yes
4	5494	18	9.3	439	Yes
5	5536	16	6.9	420	No
6	5522	16	6.1	249	No
7	5550	18	9.5	463	Yes
8	5555	17	7.9	258	No
9	5505	17	7.8	212	Yes
10	5568	17	8.6	236	Yes
11	5548	16	6.1	474	Yes
12	5519	16	6.3	461	Yes
13	5495	17	7.5	437	Yes
14	5499	18	9.5	287	Yes
15	5504	18	10	395	Yes
16	5507	17	8.1	322	No
17	5534	16	7.1	468	Yes
18	5498	17	7.6	255	Yes
19	5525	16	6.8	423	Yes
20	5516	16	6.2	456	Yes
21	5497	17	7.9	351	No
22	5565	18	9	411	Yes
23	5557	17	7.5	279	Yes
24	5501	16	6	431	Yes
25	5531	17	8.7	324	Yes
26	5553	17	7.5	419	No
27	5523	16	6.5	447	No
28	5512	16	6.3	481	No
29	5502	16	6.2	438	Yes
30	5521	16	6.7	270	Yes
Detection Rate: 70 %					

Type 4 Radar Statistical Performances

Trial #	Test Frequency (MHz)	Pulses per Burst	Pulse Width(us)	PRI(us)	Detection
1	5510	12	12.5	467	Yes
2	5532	15	17.2	304	Yes
3	5549	15	17.8	316	Yes
4	5507	16	18.5	439	Yes
5	5496	13	13.1	420	No
6	5531	12	11.3	249	Yes
7	5492	16	18.8	463	Yes
8	5527	14	15.3	258	Yes
9	5568	14	15.1	212	No
10	5501	15	16.9	236	Yes
11	5505	12	11.2	474	Yes
12	5517	12	11.7	461	No
13	5550	13	14.4	437	Yes
14	5536	16	18.9	287	Yes
15	5562	16	19.9	395	No
16	5566	14	15.7	322	No
17	5519	13	13.4	468	Yes
18	5539	13	14.5	255	Yes
19	5502	13	12.9	423	Yes
20	5521	12	11.5	456	Yes
21	5523	14	15.3	351	Yes
22	5558	15	17.8	411	Yes
23	5514	13	14.3	279	Yes
24	5512	12	11.1	431	Yes
25	5555	15	17	324	Yes
26	5533	13	14.5	419	Yes
27	5559	12	12.1	447	Yes
28	5565	12	11.7	481	Yes
29	5535	12	11.6	438	No
30	5511	12	12.7	270	Yes
Detection Rate: 80 %					

Type 5 Radar Statistical Performances

Trial #	Minimum Chirp Width(MHz)	Chirp Center Frequency(MHz)	Test Signal Name	Detection
1	13	5530.00	LP_Signal_01	Yes
2	10	5530.00	LP_Signal_02	No
3	16	5530.00	LP_Signal_03	Yes
4	13	5530.00	LP_Signal_04	Yes
5	10	5530.00	LP_Signal_05	Yes
6	6	5530.00	LP_Signal_06	Yes
7	19	5530.00	LP_Signal_07	Yes
8	16	5530.00	LP_Signal_08	Yes
9	13	5530.00	LP_Signal_09	Yes
10	19	5530.00	LP_Signal_10	Yes
11	19	5499.25	LP_Signal_11	Yes
12	12	5496.45	LP_Signal_12	Yes
13	18	5498.85	LP_Signal_13	Yes
14	7	5494.45	LP_Signal_14	Yes
15	9	5495.25	LP_Signal_15	Yes
16	15	5497.65	LP_Signal_16	Yes
17	15	5497.65	LP_Signal_17	Yes
18	14	5497.25	LP_Signal_18	Yes
19	19	5499.25	LP_Signal_19	Yes
20	17	5498.45	LP_Signal_20	Yes
21	5	5566.45	LP_Signal_21	No
22	5	5566.45	LP_Signal_22	Yes
23	13	5563.25	LP_Signal_23	Yes
24	7	5565.65	LP_Signal_24	Yes
25	14	5562.85	LP_Signal_25	Yes
26	10	5564.45	LP_Signal_26	Yes
27	15	5562.45	LP_Signal_27	Yes
28	9	5564.85	LP_Signal_28	Yes
29	5	5566.45	LP_Signal_29	Yes
30	10	5564.45	LP_Signal_30	Yes
Detection Rate: 93.33%				

The Long Pulse Radar pattern shown in Appendix A.1

Type 6 Radar Statistical Performances

Trial #	Pulses per Burst	Pulse Width(us)	PRI(us)	Detection
1	9	1	333.3	Yes
2	9	1	333.3	Yes
3	9	1	333.3	Yes
4	9	1	333.3	Yes
5	9	1	333.3	Yes
6	9	1	333.3	Yes
7	9	1	333.3	Yes
8	9	1	333.3	Yes
9	9	1	333.3	Yes
10	9	1	333.3	Yes
11	9	1	333.3	Yes
12	9	1	333.3	Yes
13	9	1	333.3	Yes
14	9	1	333.3	Yes
15	9	1	333.3	Yes
16	9	1	333.3	Yes
17	9	1	333.3	Yes
18	9	1	333.3	Yes
19	9	1	333.3	Yes
20	9	1	333.3	Yes
21	9	1	333.3	Yes
22	9	1	333.3	Yes
23	9	1	333.3	Yes
24	9	1	333.3	Yes
25	9	1	333.3	Yes
26	9	1	333.3	Yes
27	9	1	333.3	Yes
28	9	1	333.3	Yes
29	9	1	333.3	Yes
30	9	1	333.3	Yes
Detection Rate: 100 %				

Type 6 Radar Statistical Performances

Trial #	Hopping Frequency Sequence Name	Detection
1	HOP_FREQ_SEQ_01	Yes
2	HOP_FREQ_SEQ_02	Yes
3	HOP_FREQ_SEQ_03	Yes
4	HOP_FREQ_SEQ_04	Yes
5	HOP_FREQ_SEQ_05	Yes
6	HOP_FREQ_SEQ_06	Yes
7	HOP_FREQ_SEQ_07	Yes
8	HOP_FREQ_SEQ_08	Yes
9	HOP_FREQ_SEQ_09	Yes
10	HOP_FREQ_SEQ_10	Yes
11	HOP_FREQ_SEQ_11	Yes
12	HOP_FREQ_SEQ_12	Yes
13	HOP_FREQ_SEQ_13	Yes
14	HOP_FREQ_SEQ_14	Yes
15	HOP_FREQ_SEQ_15	Yes
16	HOP_FREQ_SEQ_16	Yes
17	HOP_FREQ_SEQ_17	Yes
18	HOP_FREQ_SEQ_18	Yes
19	HOP_FREQ_SEQ_19	Yes
20	HOP_FREQ_SEQ_20	Yes
21	HOP_FREQ_SEQ_21	Yes
22	HOP_FREQ_SEQ_22	Yes
23	HOP_FREQ_SEQ_23	Yes
24	HOP_FREQ_SEQ_24	Yes
25	HOP_FREQ_SEQ_25	Yes
26	HOP_FREQ_SEQ_26	Yes
27	HOP_FREQ_SEQ_27	Yes
28	HOP_FREQ_SEQ_28	Yes
29	HOP_FREQ_SEQ_29	Yes
30	HOP_FREQ_SEQ_30	Yes
Detection Rate: 100 %		

The Frequency Hopping Radar pattern shown in Appendix A.2

802.11be (EHT160) 5250MHz

Type 1 Radar Statistical Performances

Trial #	Test Frequency (MHz)	Pulse Repetition Frequency Number (1 to 23)	Pulse Repetition Frequency (Pulse per seconds)	Pulses per Burst	Pulse Repetition Interval (microseconds)	Detection
1	5318	15	1253	67	798	Yes
2	5251	16	1223	65	818	Yes
3	5255	4	1730	92	578	Yes
4	5250	11	1393	74	718	Yes
5	5310	22	1066	57	938	Yes
6	5253	7	1567	83	638	Yes
7	5256	2	1859	99	538	Yes
8	5259	8	1520	81	658	Yes
9	5287	1	1931	102	518	Yes
10	5315	19	1139	61	878	Yes
11	5285	21	1089	58	918	Yes
12	5261	23	326.2	18	3066	Yes
13	5267	9	1475	78	678	No
14	5306	5	1672	89	598	Yes
15	5275	6	1618	86	618	Yes
16	5326		1111	59	900	Yes
17	5266		1024	55	977	Yes
18	5262		625.8	34	1598	Yes
19	5312		730.5	39	1369	Yes
20	5264		1181	63	847	Yes
21	5323		400.6	22	2496	Yes
22	5265		529.4	28	1889	Yes
23	5292		347.6	19	2877	Yes
24	5329		641.4	34	1559	Yes
25	5274		508.9	27	1965	Yes
26	5303		345.4	19	2895	Yes
27	5316		580.7	31	1722	Yes
28	5304		786.8	42	1271	Yes
29	5294		808.4	43	1237	Yes
30	5279		517.1	28	1934	Yes
Detection Rate: 96.67 %						

Type 2 Radar Statistical Performances

Trial #	Test Frequency (MHz)	Pulses per Burst	Pulse Width(us)	PRI(us)	Detection
1	5251	24	1.7	174	Yes
2	5280	27	3.8	176	Yes
3	5324	28	4	161	No
4	5271	28	4.3	226	Yes
5	5254	24	1.9	193	Yes
6	5278	23	1.1	230	Yes
7	5277	29	4.5	198	No
8	5316	26	2.9	227	No
9	5262	26	2.8	171	Yes
10	5290	27	3.6	221	Yes
11	5298	23	1.1	180	Yes
12	5268	23	1.3	189	Yes
13	5264	25	2.5	204	Yes
14	5272	29	4.5	203	No
15	5300	29	5	170	Yes
16	5326	26	3.1	201	Yes
17	5304	24	2.1	218	Yes
18	5266	25	2.6	208	Yes
19	5311	24	1.8	223	Yes
20	5317	23	1.2	220	Yes
21	5309	26	2.9	224	Yes
22	5294	28	4	160	Yes
23	5274	25	2.5	209	No
24	5310	23	1	205	Yes
25	5265	27	3.7	151	Yes
26	5275	25	2.5	186	Yes
27	5252	23	1.5	190	Yes
28	5328	23	1.3	185	Yes
29	5288	23	1.2	175	Yes
30	5250	24	1.7	216	Yes
Detection Rate: 83.33 %					

Type 3 Radar Statistical Performances

Trial #	Test Frequency (MHz)	Pulses per Burst	Pulse Width(us)	PRI(us)	Detection
1	5272	16	6.7	467	Yes
2	5296	18	8.8	304	Yes
3	5297	18	9	316	Yes
4	5299	18	9.3	439	Yes
5	5327	16	6.9	420	Yes
6	5269	16	6.1	249	Yes
7	5276	18	9.5	463	Yes
8	5268	17	7.9	258	Yes
9	5283	17	7.8	212	Yes
10	5291	17	8.6	236	Yes
11	5260	16	6.1	474	No
12	5311	16	6.3	461	Yes
13	5309	17	7.5	437	Yes
14	5277	18	9.5	287	Yes
15	5305	18	10	395	Yes
16	5263	17	8.1	322	Yes
17	5266	16	7.1	468	No
18	5282	17	7.6	255	Yes
19	5271	16	6.8	423	No
20	5256	16	6.2	456	Yes
21	5328	17	7.9	351	Yes
22	5301	18	9	411	Yes
23	5306	17	7.5	279	Yes
24	5257	16	6	431	Yes
25	5312	17	8.7	324	Yes
26	5275	17	7.5	419	Yes
27	5254	16	6.5	447	Yes
28	5265	16	6.3	481	No
29	5298	16	6.2	438	Yes
30	5259	16	6.7	270	Yes
Detection Rate: 86.67 %					

Type 4 Radar Statistical Performances

Trial #	Test Frequency (MHz)	Pulses per Burst	Pulse Width(us)	PRI(us)	Detection
1	5250	12	12.5	467	Yes
2	5305	15	17.2	304	Yes
3	5298	15	17.8	316	Yes
4	5253	16	18.5	439	No
5	5323	13	13.1	420	Yes
6	5282	12	11.3	249	Yes
7	5310	16	18.8	463	Yes
8	5289	14	15.3	258	No
9	5260	14	15.1	212	Yes
10	5259	15	16.9	236	Yes
11	5319	12	11.2	474	Yes
12	5283	12	11.7	461	Yes
13	5262	13	14.4	437	Yes
14	5327	16	18.9	287	Yes
15	5264	16	19.9	395	Yes
16	5294	14	15.7	322	Yes
17	5315	13	13.4	468	No
18	5309	13	14.5	255	Yes
19	5299	13	12.9	423	Yes
20	5269	12	11.5	456	Yes
21	5270	14	15.3	351	No
22	5266	15	17.8	411	Yes
23	5307	13	14.3	279	No
24	5330	12	11.1	431	Yes
25	5274	15	17	324	Yes
26	5308	13	14.5	419	Yes
27	5252	12	12.1	447	No
28	5324	12	11.7	481	Yes
29	5267	12	11.6	438	Yes
30	5251	12	12.7	270	No
Detection Rate: 76.67 %					

Type 5 Radar Statistical Performances

Trial #	Minimum Chirp Width(MHz)	Chirp Center Frequency(MHz)	Test Signal Name	Detection
1	16	5290.00	LP_Signal_01	No
2	9	5290.00	LP_Signal_02	Yes
3	16	5290.00	LP_Signal_03	Yes
4	13	5290.00	LP_Signal_04	Yes
5	13	5290.00	LP_Signal_05	Yes
6	12	5290.00	LP_Signal_06	Yes
7	14	5290.00	LP_Signal_07	Yes
8	15	5290.00	LP_Signal_08	Yes
9	12	5290.00	LP_Signal_09	Yes
10	13	5290.00	LP_Signal_10	Yes
11	20	5258	LP_Signal_11	Yes
12	6	5252.4	LP_Signal_12	Yes
13	18	5257.2	LP_Signal_13	Yes
14	17	5256.8	LP_Signal_14	Yes
15	7	5252.8	LP_Signal_15	Yes
16	18	5257.2	LP_Signal_16	Yes
17	14	5255.6	LP_Signal_17	Yes
18	16	5256.4	LP_Signal_18	Yes
19	12	5254.8	LP_Signal_19	Yes
20	19	5257.6	LP_Signal_20	Yes
21	13	5322.02	LP_Signal_21	Yes
22	6	5324.82	LP_Signal_22	Yes
23	17	5320.42	LP_Signal_23	Yes
24	7	5324.42	LP_Signal_24	Yes
25	9	5323.62	LP_Signal_25	Yes
26	11	5322.82	LP_Signal_26	Yes
27	18	5320.02	LP_Signal_27	Yes
28	9	5323.62	LP_Signal_28	Yes
29	6	5324.82	LP_Signal_29	Yes
30	20	5319.22	LP_Signal_30	Yes
Detection Rate: 96.67 %				

The Long Pulse Radar pattern shown in Appendix A.1

Type 6 Radar Statistical Performances

Trial #	Pulses per Burst	Pulse Width(us)	PRI(us)	Detection
1	9	1	333.3	Yes
2	9	1	333.3	Yes
3	9	1	333.3	Yes
4	9	1	333.3	Yes
5	9	1	333.3	Yes
6	9	1	333.3	Yes
7	9	1	333.3	Yes
8	9	1	333.3	Yes
9	9	1	333.3	Yes
10	9	1	333.3	Yes
11	9	1	333.3	Yes
12	9	1	333.3	Yes
13	9	1	333.3	Yes
14	9	1	333.3	Yes
15	9	1	333.3	Yes
16	9	1	333.3	Yes
17	9	1	333.3	Yes
18	9	1	333.3	Yes
19	9	1	333.3	Yes
20	9	1	333.3	Yes
21	9	1	333.3	Yes
22	9	1	333.3	Yes
23	9	1	333.3	Yes
24	9	1	333.3	Yes
25	9	1	333.3	Yes
26	9	1	333.3	Yes
27	9	1	333.3	Yes
28	9	1	333.3	Yes
29	9	1	333.3	Yes
30	9	1	333.3	Yes
Detection Rate: 100 %				

Type 6 Radar Statistical Performances

Trial #	Hopping Frequency Sequence Name	Detection
1	HOP_FREQ_SEQ_01	Yes
2	HOP_FREQ_SEQ_02	Yes
3	HOP_FREQ_SEQ_03	Yes
4	HOP_FREQ_SEQ_04	Yes
5	HOP_FREQ_SEQ_05	Yes
6	HOP_FREQ_SEQ_06	Yes
7	HOP_FREQ_SEQ_07	Yes
8	HOP_FREQ_SEQ_08	Yes
9	HOP_FREQ_SEQ_09	Yes
10	HOP_FREQ_SEQ_10	Yes
11	HOP_FREQ_SEQ_11	Yes
12	HOP_FREQ_SEQ_12	Yes
13	HOP_FREQ_SEQ_13	Yes
14	HOP_FREQ_SEQ_14	Yes
15	HOP_FREQ_SEQ_15	Yes
16	HOP_FREQ_SEQ_16	Yes
17	HOP_FREQ_SEQ_17	Yes
18	HOP_FREQ_SEQ_18	Yes
19	HOP_FREQ_SEQ_19	Yes
20	HOP_FREQ_SEQ_20	Yes
21	HOP_FREQ_SEQ_21	Yes
22	HOP_FREQ_SEQ_22	Yes
23	HOP_FREQ_SEQ_23	Yes
24	HOP_FREQ_SEQ_24	Yes
25	HOP_FREQ_SEQ_25	Yes
26	HOP_FREQ_SEQ_26	Yes
27	HOP_FREQ_SEQ_27	Yes
28	HOP_FREQ_SEQ_28	Yes
29	HOP_FREQ_SEQ_29	Yes
30	HOP_FREQ_SEQ_30	Yes
Detection Rate: 100 %		

The Frequency Hopping Radar pattern shown in Appendix A.2

802.11be (EHT160) 5570MHz

Type 1 Radar Statistical Performances

Trial #	Test Frequency (MHz)	Pulse Repetition Frequency Number (1 to 23)	Pulse Repetition Frequency (Pulse per seconds)	Pulses per Burst	Pulse Repetition Interval (microseconds)	Detection
1	5525	15	1253	67	798	Yes
2	5517	16	1223	65	818	Yes
3	5636	4	1730	92	578	Yes
4	5571	11	1393	74	718	Yes
5	5494	22	1066	57	938	Yes
6	5630	7	1567	83	638	Yes
7	5629	2	1859	99	538	Yes
8	5580	8	1520	81	658	Yes
9	5552	1	1931	102	518	Yes
10	5532	19	1139	61	878	Yes
11	5500	21	1089	58	918	Yes
12	5643	23	326.2	18	3066	Yes
13	5540	9	1475	78	678	Yes
14	5555	5	1672	89	598	Yes
15	5504	6	1618	86	618	Yes
16	5546		1111	59	900	Yes
17	5506		1024	55	977	Yes
18	5615		625.8	34	1598	Yes
19	5557		730.5	39	1369	Yes
20	5593		1181	63	847	Yes
21	5650		400.6	22	2496	Yes
22	5644		529.4	28	1889	Yes
23	5573		347.6	19	2877	Yes
24	5649		641.4	34	1559	Yes
25	5632		508.9	27	1965	Yes
26	5537		345.4	19	2895	Yes
27	5527		580.7	31	1722	Yes
28	5611		786.8	42	1271	Yes
29	5594		808.4	43	1237	Yes
30	5515		517.1	28	1934	Yes
Detection Rate: 100 %						

Type 2 Radar Statistical Performances

Trial #	Test Frequency (MHz)	Pulses per Burst	Pulse Width(us)	PRI(us)	Detection
1	5528	24	1.7	174	Yes
2	5504	27	3.8	176	Yes
3	5629	28	4	161	Yes
4	5493	28	4.3	226	Yes
5	5570	24	1.9	193	Yes
6	5555	23	1.1	230	Yes
7	5559	29	4.5	198	No
8	5575	26	2.9	227	Yes
9	5512	26	2.8	171	No
10	5648	27	3.6	221	No
11	5500	23	1.1	180	Yes
12	5590	23	1.3	189	Yes
13	5502	25	2.5	204	Yes
14	5546	29	4.5	203	Yes
15	5554	29	5	170	Yes
16	5492	26	3.1	201	Yes
17	5506	24	2.1	218	Yes
18	5618	25	2.6	208	Yes
19	5535	24	1.8	223	Yes
20	5598	23	1.2	220	No
21	5517	26	2.9	224	No
22	5601	28	4	160	Yes
23	5599	25	2.5	209	Yes
24	5513	23	1	205	No
25	5514	27	3.7	151	Yes
26	5490	25	2.5	186	Yes
27	5576	23	1.5	190	Yes
28	5636	23	1.3	185	Yes
29	5561	23	1.2	175	Yes
30	5519	24	1.7	216	Yes
Detection Rate: 80 %					

Type 3 Radar Statistical Performances

Trial #	Test Frequency (MHz)	Pulses per Burst	Pulse Width(us)	PRI(us)	Detection
1	5587	16	6.7	467	No
2	5616	18	8.8	304	Yes
3	5573	18	9	316	Yes
4	5621	18	9.3	439	Yes
5	5643	16	6.9	420	Yes
6	5558	16	6.1	249	Yes
7	5627	18	9.5	463	No
8	5622	17	7.9	258	Yes
9	5537	17	7.8	212	Yes
10	5518	17	8.6	236	No
11	5624	16	6.1	474	No
12	5497	16	6.3	461	Yes
13	5498	17	7.5	437	Yes
14	5514	18	9.5	287	Yes
15	5493	18	10	395	Yes
16	5505	17	8.1	322	Yes
17	5552	16	7.1	468	Yes
18	5598	17	7.6	255	Yes
19	5492	16	6.8	423	No
20	5604	16	6.2	456	Yes
21	5510	17	7.9	351	Yes
22	5526	18	9	411	Yes
23	5512	17	7.5	279	Yes
24	5543	16	6	431	Yes
25	5527	17	8.7	324	Yes
26	5634	17	7.5	419	Yes
27	5597	16	6.5	447	Yes
28	5639	16	6.3	481	No
29	5528	16	6.2	438	Yes
30	5519	16	6.7	270	Yes
Detection Rate: 80 %					

Type 4 Radar Statistical Performances

Trial #	Test Frequency (MHz)	Pulses per Burst	Pulse Width(us)	PRI(us)	Detection
1	5628	12	12.5	467	Yes
2	5503	15	17.2	304	No
3	5616	15	17.8	316	Yes
4	5522	16	18.5	439	Yes
5	5512	13	13.1	420	Yes
6	5599	12	11.3	249	Yes
7	5496	16	18.8	463	Yes
8	5493	14	15.3	258	Yes
9	5537	14	15.1	212	Yes
10	5602	15	16.9	236	Yes
11	5500	12	11.2	474	No
12	5632	12	11.7	461	No
13	5502	13	14.4	437	No
14	5531	16	18.9	287	Yes
15	5504	16	19.9	395	Yes
16	5596	14	15.7	322	Yes
17	5597	13	13.4	468	Yes
18	5501	13	14.5	255	Yes
19	5560	13	12.9	423	Yes
20	5629	12	11.5	456	No
21	5646	14	15.3	351	No
22	5633	15	17.8	411	No
23	5544	13	14.3	279	Yes
24	5590	12	11.1	431	Yes
25	5514	15	17	324	Yes
26	5551	13	14.5	419	Yes
27	5589	12	12.1	447	No
28	5556	12	11.7	481	No
29	5598	12	11.6	438	Yes
30	5530	12	12.7	270	Yes
Detection Rate: 70%					

Type 5 Radar Statistical Performances

Trial #	Minimum Chirp Width(MHz)	Chirp Center Frequency(MHz)	Test Signal Name	Detection
1	19	5530.00	LP_Signal_01	Yes
2	17	5530.00	LP_Signal_02	Yes
3	12	5530.00	LP_Signal_03	Yes
4	19	5530.00	LP_Signal_04	Yes
5	8	5530.00	LP_Signal_05	Yes
6	20	5530.00	LP_Signal_06	Yes
7	9	5530.00	LP_Signal_07	Yes
8	19	5530.00	LP_Signal_08	Yes
9	14	5530.00	LP_Signal_09	Yes
10	13	5530.00	LP_Signal_10	Yes
11	17	5498.52	LP_Signal_11	Yes
12	20	5499.72	LP_Signal_12	Yes
13	14	5497.32	LP_Signal_13	Yes
14	11	5496.12	LP_Signal_14	Yes
15	19	5499.32	LP_Signal_15	Yes
16	13	5496.92	LP_Signal_16	Yes
17	20	5499.72	LP_Signal_17	Yes
18	11	5496.12	LP_Signal_18	Yes
19	13	5496.92	LP_Signal_19	Yes
20	11	5496.12	LP_Signal_20	Yes
21	16	5640.75	LP_Signal_21	Yes
22	10	5643.15	LP_Signal_22	Yes
23	20	5639.15	LP_Signal_23	Yes
24	13	5641.95	LP_Signal_24	Yes
25	12	5642.35	LP_Signal_25	Yes
26	6	5644.75	LP_Signal_26	No
27	17	5640.35	LP_Signal_27	Yes
28	20	5639.15	LP_Signal_28	Yes
29	11	5642.75	LP_Signal_29	Yes
30	18	5639.95	LP_Signal_30	Yes
Detection Rate: 96.67 %				

The Long Pulse Radar pattern shown in Appendix A.1

Type 6 Radar Statistical Performances

Trial #	Pulses per Burst	Pulse Width(us)	PRI(us)	Detection
1	9	1	333.3	Yes
2	9	1	333.3	Yes
3	9	1	333.3	Yes
4	9	1	333.3	Yes
5	9	1	333.3	Yes
6	9	1	333.3	Yes
7	9	1	333.3	Yes
8	9	1	333.3	Yes
9	9	1	333.3	Yes
10	9	1	333.3	Yes
11	9	1	333.3	Yes
12	9	1	333.3	Yes
13	9	1	333.3	Yes
14	9	1	333.3	Yes
15	9	1	333.3	Yes
16	9	1	333.3	Yes
17	9	1	333.3	Yes
18	9	1	333.3	Yes
19	9	1	333.3	Yes
20	9	1	333.3	Yes
21	9	1	333.3	Yes
22	9	1	333.3	Yes
23	9	1	333.3	Yes
24	9	1	333.3	Yes
25	9	1	333.3	Yes
26	9	1	333.3	Yes
27	9	1	333.3	Yes
28	9	1	333.3	Yes
29	9	1	333.3	Yes
30	9	1	333.3	Yes
Detection Rate: 100 %				

Type 6 Radar Statistical Performances

Trial #	Hopping Frequency Sequence Name	Detection
1	HOP_FREQ_SEQ_01	Yes
2	HOP_FREQ_SEQ_02	Yes
3	HOP_FREQ_SEQ_03	Yes
4	HOP_FREQ_SEQ_04	Yes
5	HOP_FREQ_SEQ_05	Yes
6	HOP_FREQ_SEQ_06	Yes
7	HOP_FREQ_SEQ_07	Yes
8	HOP_FREQ_SEQ_08	Yes
9	HOP_FREQ_SEQ_09	Yes
10	HOP_FREQ_SEQ_10	Yes
11	HOP_FREQ_SEQ_11	Yes
12	HOP_FREQ_SEQ_12	Yes
13	HOP_FREQ_SEQ_13	Yes
14	HOP_FREQ_SEQ_14	Yes
15	HOP_FREQ_SEQ_15	Yes
16	HOP_FREQ_SEQ_16	Yes
17	HOP_FREQ_SEQ_17	Yes
18	HOP_FREQ_SEQ_18	Yes
19	HOP_FREQ_SEQ_19	Yes
20	HOP_FREQ_SEQ_20	Yes
21	HOP_FREQ_SEQ_21	Yes
22	HOP_FREQ_SEQ_22	Yes
23	HOP_FREQ_SEQ_23	Yes
24	HOP_FREQ_SEQ_24	Yes
25	HOP_FREQ_SEQ_25	Yes
26	HOP_FREQ_SEQ_26	Yes
27	HOP_FREQ_SEQ_27	Yes
28	HOP_FREQ_SEQ_28	Yes
29	HOP_FREQ_SEQ_29	Yes
30	HOP_FREQ_SEQ_30	Yes
Detection Rate: 100 %		

The Frequency Hopping Radar pattern shown in Appendix A.2

6.2.5 Non-Occupancy Period

During the 30 minutes observation time, UUT did not make any transmissions on a channel after a radar signal was detected on that channel by either the Channel Availability Check or the In-Service Monitoring.

- 1) EUT (Master) links with Client on 5500MHz.

Waveform of EUT links up with Client

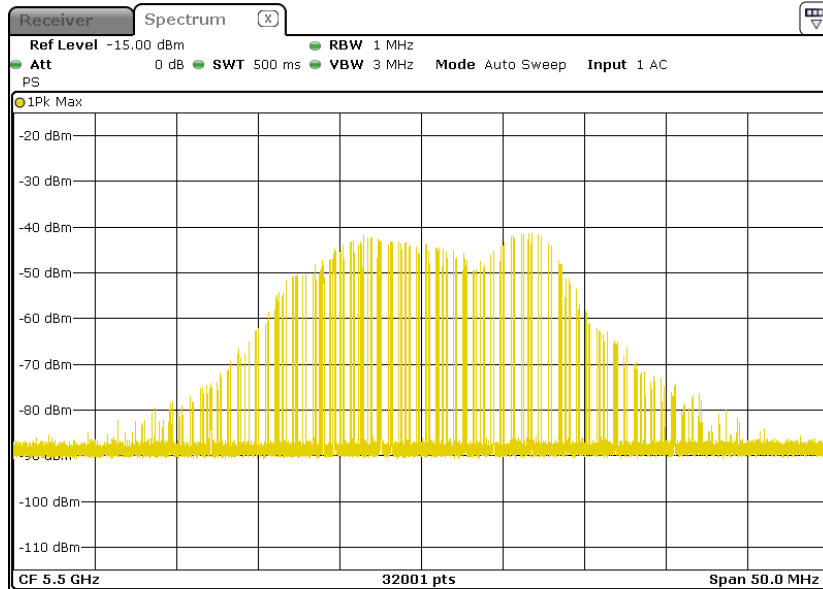

- 2) Client plays specified files via master.

Waveform of transmission

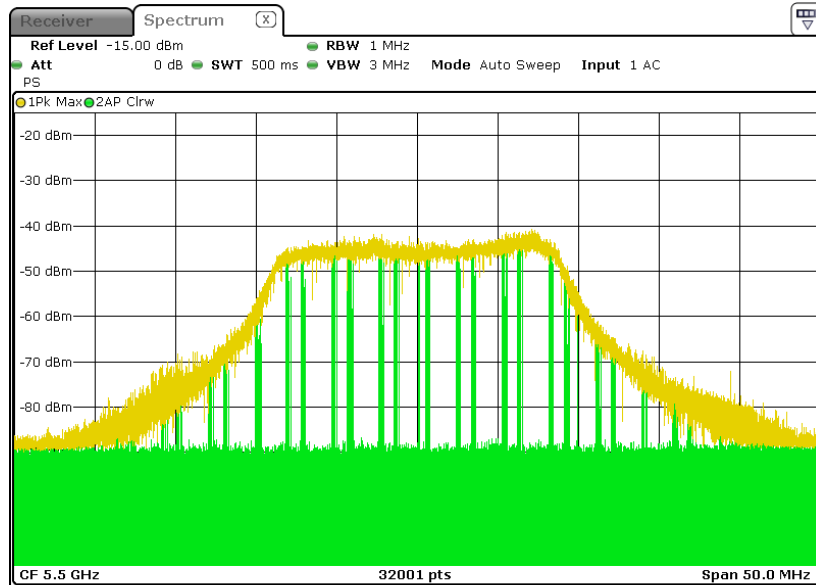

3) Radar signal is applied to the Master device and WiFi traffic signal stop immediately.

Radar 0

Trial Id	Radar Type	Pulse Width (ns)	PRI (ns)	Number of Pulses	Waveform Length (ns)
Download 0	Type 0	1.0	1428.0	18	25704.0
Download 1	Type 0	1.0	1428.0	18	25704.0
Download 2	Type 0	1.0	1428.0	18	25704.0
Download 3	Type 0	1.0	1428.0	18	25704.0
Download 4	Type 0	1.0	1428.0	18	25704.0
Download 5	Type 0	1.0	1428.0	18	25704.0
Download 6	Type 0	1.0	1428.0	18	25704.0
Download 7	Type 0	1.0	1428.0	18	25704.0
Download 8	Type 0	1.0	1428.0	18	25704.0
Download 9	Type 0	1.0	1428.0	18	25704.0
Download 10	Type 0	1.0	1428.0	18	25704.0
Download 11	Type 0	1.0	1428.0	18	25704.0
Download 12	Type 0	1.0	1428.0	18	25704.0
Download 13	Type 0	1.0	1428.0	18	25704.0
Download 14	Type 0	1.0	1428.0	18	25704.0
Download 15	Type 0	1.0	1428.0	18	25704.0
Download 16	Type 0	1.0	1428.0	18	25704.0

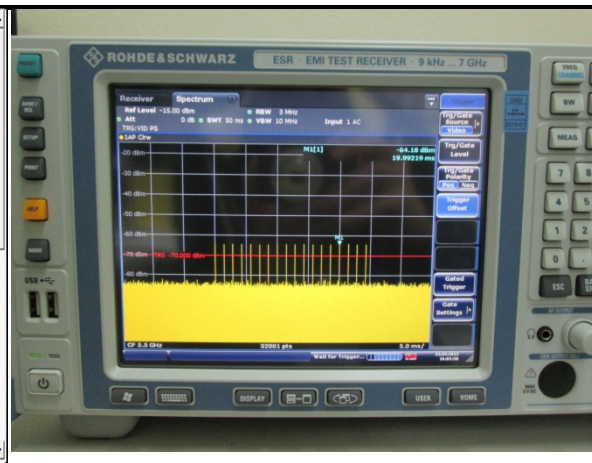

Radar 1

Trial Id	Radar Type	Pulse Width (ns)	PRI (ns)	Number of Pulses	Waveform Length (ns)
Download 0	Type 1	1.0	678.0	78	52884.0
Download 1	Type 1	1.0	658.0	62	53196.0
Download 2	Type 1	1.0	738.0	72	53136.0
Download 3	Type 1	1.0	878.0	61	53558.0
Download 4	Type 1	1.0	938.0	57	53466.0
Download 5	Type 1	1.0	918.0	58	53244.0
Download 6	Type 1	1.0	538.0	99	53282.0
Download 7	Type 1	1.0	618.0	86	53148.0
Download 8	Type 1	1.0	798.0	67	53466.0
Download 9	Type 1	1.0	888.0	59	53282.0
Download 10	Type 1	1.0	518.0	102	53286.0
Download 11	Type 1	1.0	718.0	74	53132.0
Download 12	Type 1	1.0	3066.0	18	55188.0
Download 13	Type 1	1.0	598.0	89	53222.0
Download 14	Type 1	1.0	838.0	63	52794.0
Download 15	Type 1	1.0	2846.0	19	54074.0
Download 16	Type 1	1.0	692.0	84	69204.0

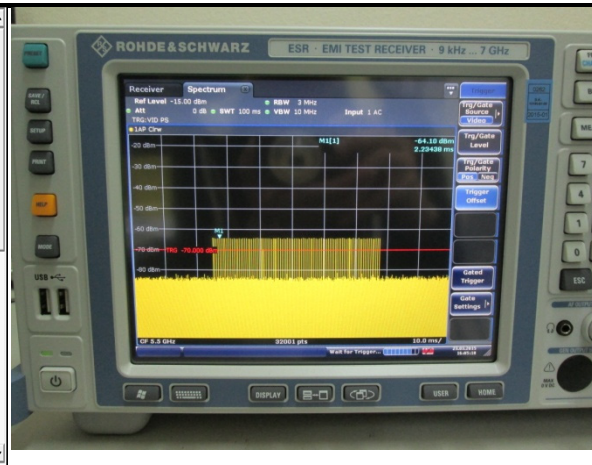

Radar 2

Trial Id	Radar Type	Pulse Width (ns)	PRI (ns)	Number of Pulses	Waveform Length (ns)
Download 0	Type 2	1.3	2000.0	23	4600.0
Download 1	Type 2	2.3	1730.0	25	4325.0
Download 2	Type 2	4.9	1580.0	29	4582.0
Download 3	Type 2	1.5	1900.0	24	4560.0
Download 4	Type 2	1.6	2190.0	24	5256.0
Download 5	Type 2	2.4	1830.0	25	4575.0
Download 6	Type 2	5.0	171.0	29	4959.0
Download 7	Type 2	4.5	1940.0	29	5626.0
Download 8	Type 2	3.6	1600.0	27	4320.0
Download 9	Type 2	2.7	1660.0	26	4316.0
Download 10	Type 2	2.8	2020.0	26	5252.0
Download 11	Type 2	3.7	1880.0	27	5076.0
Download 12	Type 2	1.9	1840.0	24	4416.0
Download 13	Type 2	4.4	2030.0	28	5684.0
Download 14	Type 2	3.3	2050.0	26	5330.0
Download 15	Type 2	1.5	1890.0	23	4347.0
Download 16	Type 2	17.6	2220.0	25	3900.0

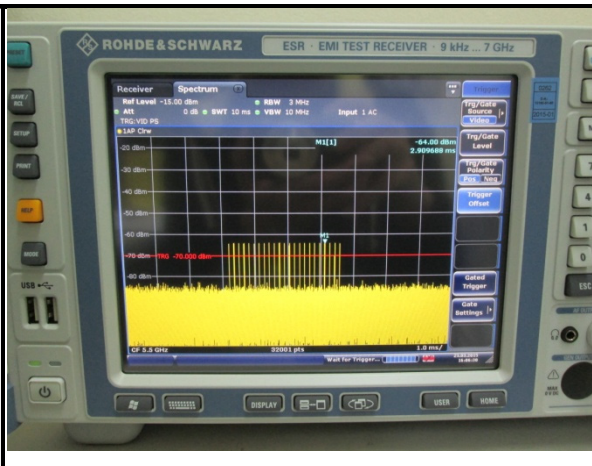

Radar 3

Trial Id	Radar Type	Pulse Width (ns)	PRI (ns)	Number of Pulses	Waveform Length (ns)
Download 0	Type 3	8.2	355.0	17	6035.0
Download 1	Type 3	6.1	487.0	16	7792.0
Download 2	Type 3	7.1	344.0	16	5504.0
Download 3	Type 3	9.8	288.0	18	5194.0
Download 4	Type 3	8.9	230.0	18	4140.0
Download 5	Type 3	7.9	432.0	17	7344.0
Download 6	Type 3	8.2	207.0	17	3519.0
Download 7	Type 3	7.5	443.0	17	7531.0
Download 8	Type 3	8.1	438.0	17	7463.0
Download 9	Type 3	6.2	223.0	16	3568.0
Download 10	Type 3	8.9	208.0	18	3744.0
Download 11	Type 3	9.6	463.0	18	8334.0
Download 12	Type 3	8.2	441.0	17	7497.0
Download 13	Type 3	7.2	323.0	16	5168.0
Download 14	Type 3	9.5	297.0	18	5346.0
Download 15	Type 3	8.0	412.0	17	7004.0
Download 16	Type 3	10.0	338.0	18	5872.0

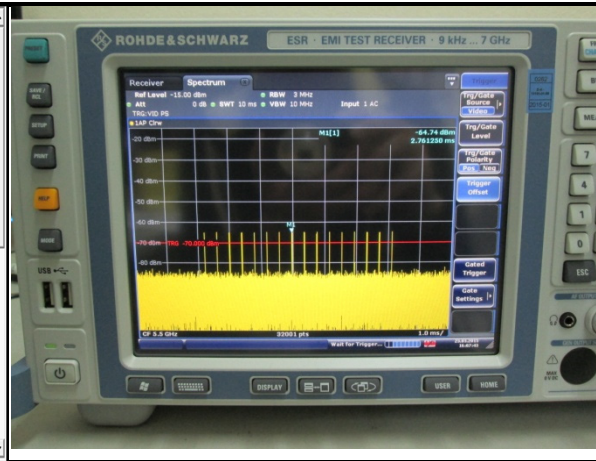

Radar 4

Trial Id	Radar Type	Pulse Width (ns)	PRI (ns)	Number of Pulses	Waveform Length (ns)
Download 0	Type 4	16.0	355.0	14	4970.0
Download 1	Type 4	11.3	407.0	12	5844.0
Download 2	Type 4	13.5	344.0	13	4472.0
Download 3	Type 4	19.4	288.0	16	4608.0
Download 4	Type 4	17.5	230.0	15	3450.0
Download 5	Type 4	15.3	432.0	14	6048.0
Download 6	Type 4	15.9	207.0	14	2698.0
Download 7	Type 4	14.3	443.0	13	5759.0
Download 8	Type 4	15.8	438.0	14	6146.0
Download 9	Type 4	11.5	223.0	12	2676.0
Download 10	Type 4	17.4	208.0	15	3120.0
Download 11	Type 4	19.0	463.0	16	7408.0
Download 12	Type 4	16.0	441.0	14	6174.0
Download 13	Type 4	13.8	323.0	13	4199.0
Download 14	Type 4	18.9	297.0	16	4752.0
Download 15	Type 4	15.5	412.0	14	5768.0
Download 16	Type 4	10.0	338.0	14	5184.0

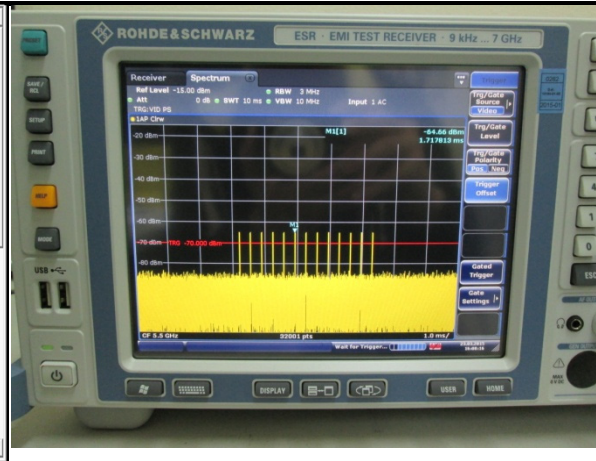

Radar 5

Trial Id	Radar Type	Number of Bursts	Burst Period (s)	Waveform Length (s)	Center Frequency (GHz)	Number of Pulses per Burst	PRI-1 (ns)	PRI-2 (ns)	PRI-3 (ns)
Download 0	Type 5	18	0.6666667	12.0000000	5.900000000	-	-	-	-
0									
1									
2									
3									
4									
5									
6									
7									
8									
9									
10									
11									
12									
13									
14									
15									
16									
17									
Download 9	Type 5	18	0.6666667	12.0000000	5.900000000	-	-	-	-
Download 10	Type 5	10	1.0000000	12.0000000	5.494200000	-	-	-	-
Download 11	Type 5	11	11.0718782	17.0000000	1.450000000	-	-	-	-

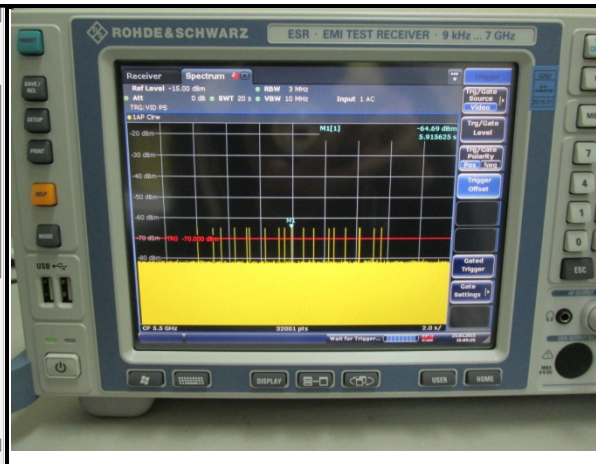

Radar 6

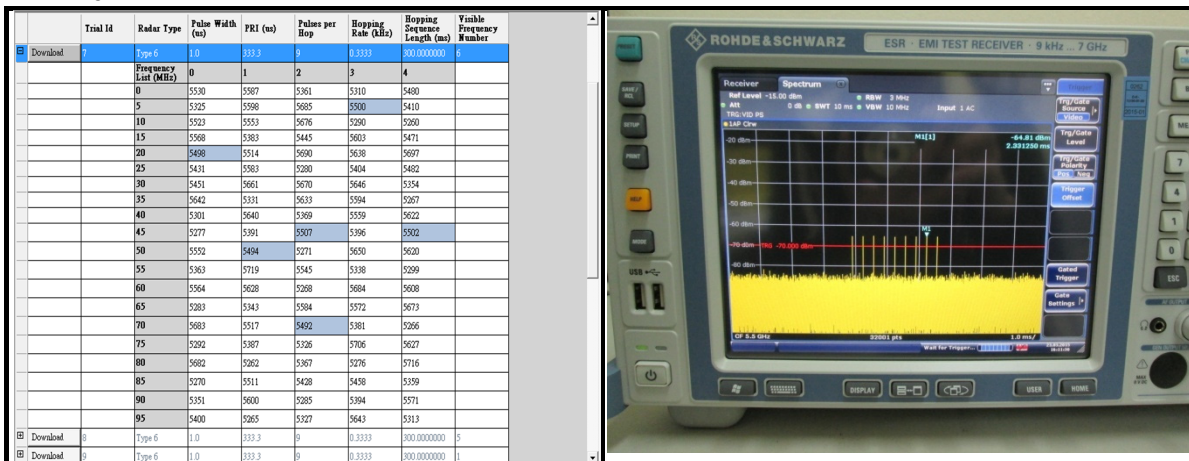

4) 5500MHz has been monitored in 30 minutes period. In this period, no any transmission occurs.

Plot of 30minutes period

802.11be (EHT20) Non - Occupancy Period

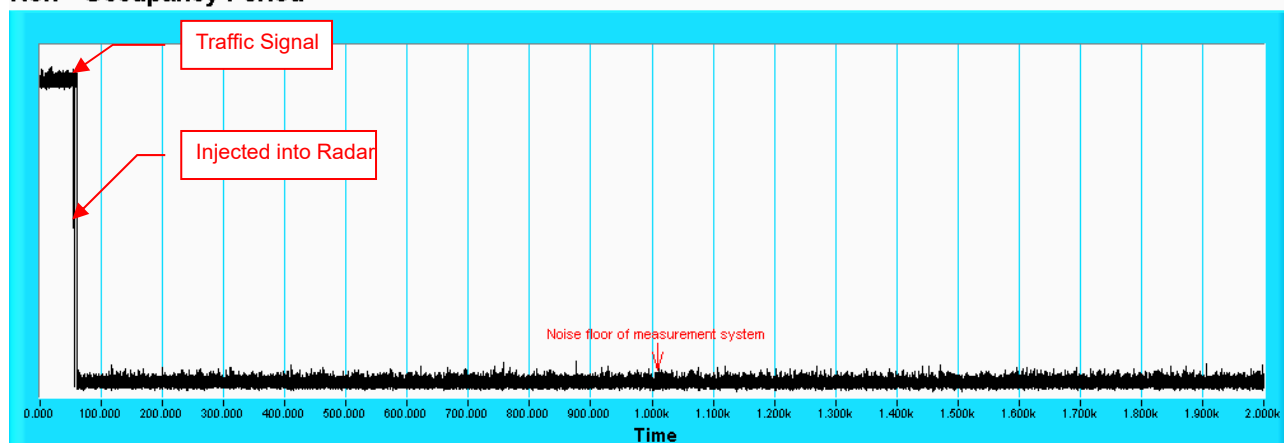

Note: Test setup are shown on Test setup photo.pdf

6.2.9 Non- Co-Channel Test

The UUT was investigated after radar was detected and confirmed that no co-channel operation with radars.

6.2.10 Uniform Spreading

The intention of the uniform spreading is to provide, on aggregate, a uniform loading of the spectrum. The EUT randomly select next output channel without any bias or fixed pattern, so that all channels in DFS bands (5250 to 5350MHz and 5470 to 5725 MHz) will be used equally.

7 Information of the Testing Laboratories

We, Bureau Veritas Consumer Products Services (H.K.) Ltd., Taoyuan Branch, were founded in 1988 to provide our best service in EMC, Radio, Telecom and Safety consultation. Our laboratories are FCC recognized accredited test firms and accredited and approved according to ISO/IEC 17025.

If you have any comments, please feel free to contact us at the following:

Lin Kou EMC/RF Lab

Tel: 886-2-26052180

Fax: 886-2-26051924

Hsin Chu EMC/RF/Telecom Lab

Tel: 886-3-6668565

Fax: 886-3-6668323

Hwa Ya EMC/RF/Safety Lab

Tel: 886-3-3183232

Fax: 886-3-3270892

Email: service.adt@bureauveritas.com

Web Site: <http://ee.bureauveritas.com.tw>

The address and road map of all our labs can be found in our web site also.

Appendix-A

Radar Test Signal

A.1 The Long Pulse Radar Pattern

802.11be (EHT20)

Long Pulse Radar Test Signal						
Test Signal Name: LP_Signal_01						
Number of Bursts in Trial: 15						
Chrip Center Frequency 5500.0MHz						
Burst	Pulses per Burst	Chirp (MHz)	Pulse Width(us)	PRI-1 (us)	PRI-2 (us)	PRI-3 (us)
1	2	16	77.8	1665.0	1477.0	-
2	1	16	51.9	1074.0	-	-
3	1	16	63.8	1584.0	-	-
4	3	16	96.6	1682.0	1786.0	1843.0
5	3	16	85.9	1795.0	1215.0	1729.0
6	2	16	73.7	1198.0	1549.0	-
7	2	16	77.2	1837.0	1819.0	-
8	2	16	68.4	1587.0	1114.0	-
9	2	16	76.7	2000.0	1155.0	-
10	1	16	53.2	1147.0	-	-
11	3	16	85.7	1433.0	1695.0	1394.0
12	3	16	94.3	1670.0	1426.0	1935.0
13	2	16	77.6	1294.0	1671.0	-
14	1	16	65.7	1512.0	-	-
15	3	16	93.5	1444.0	1130.0	1468.0
16						
17						
18						
19						
20						

Long Pulse Radar Test Signal

Test Signal Name: LP_Signal_02

Number of Bursts in Trial: 8

Chrip Center Frequency: 5500.0MHz

Burst	Pulses per Burst	Chirp (MHz)	Pulse Width(us)	PRI-1 (us)	PRI-2 (us)	PRI-3 (us)
1	2	15	75.0	1880.0	1527.0	-
2	3	15	99.4	1401.0	1262.0	1257.0
3	2	15	67.4	1531.0	1403.0	-
4	2	15	73.6	1449.0	1041.0	-
5	1	15	65.9	1432.0	-	-
6	3	15	83.8	1356.0	1292.0	1419.0
7	1	15	65.5	1543.0	-	-
8	3	15	98.6	1548.0	1796.0	1728.0
9						
10						
11						
12						
13						
14						
15						
16						
17						
18						
19						
20						

Long Pulse Radar Test Signal

Test Signal Name: LP_Signal_03

Number of Bursts in Trial: 11

Chrip Center Frequency: 5500.0MHz

Burst	Pulses per Burst	Chrip (MHz)	Pulse Width(us)	PRI-1 (us)	PRI-2 (us)	PRI-3 (us)
1	2	12	73.8	1806.0	1538.0	-
2	2	12	69.5	1117.0	1649.0	-
3	1	12	51.9	1651.0	-	-
4	3	12	84.6	1976.0	1032.0	1271.0
5	3	12	95.4	1060.0	1903.0	1388.0
6	2	12	68.0	1368.0	1351.0	-
7	3	12	89.6	1338.0	1514.0	1573.0
8	2	12	81.9	1022.0	1689.0	-
9	3	12	88.3	1810.0	1330.0	1838.0
10	1	12	53.7	1597.0	-	-
11	3	12	91.3	1961.0	1106.0	1001.0
12						
13						
14						
15						
16						
17						
18						
19						
20						

Long Pulse Radar Test Signal

Test Signal Name: LP_Signal_04

Number of Bursts in Trial: 20

Chrip Center Frequency: 5500.0MHz

Burst	Pulses per Burst	Chrip (MHz)	Pulse Width(us)	PRI-1 (us)	PRI-2 (us)	PRI-3 (us)
1	2	13	68.1	1339.0	1355.0	-
2	1	13	58.7	1251.0	-	-
3	2	13	75.3	1136.0	1640.0	-
4	1	13	56.4	1753.0	-	-
5	3	13	99.7	1196.0	1708.0	1159.0
6	1	13	57.7	1013.0	-	-
7	1	13	59.5	1072.0	-	-
8	2	13	80.0	1482.0	1369.0	-
9	2	13	82.0	1993.0	1197.0	-
10	2	13	82.8	1883.0	1005.0	-
11	3	13	88.0	1061.0	1928.0	1101.0
12	3	13	93.2	1207.0	1907.0	1223.0
13	2	13	70.4	1526.0	1360.0	-
14	3	13	95.3	1171.0	1955.0	1775.0
15	2	13	81.9	1690.0	1545.0	-
16	3	13	98.5	1975.0	1169.0	1062.0
17	1	13	65.0	1767.0	-	-
18	3	13	85.4	1011.0	1637.0	1425.0
19	3	13	91.6	1878.0	1445.0	1325.0
20	2	13	67.3	1091.0	1218.0	-

Long Pulse Radar Test Signal

Test Signal Name: LP_Signal_05

Number of Bursts in Trial: 17

Chrip Center Frequency: 5500.0MHz

Burst	Pulses per Burst	Chrip (MHz)	Pulse Width(us)	PRI-1 (us)	PRI-2 (us)	PRI-3 (us)
1	2	15	67.9	1320.0	1133.0	-
2	1	15	62.3	1957.0	-	-
3	1	15	53.3	1592.0	-	-
4	3	15	90.0	1900.0	1153.0	1346.0
5	2	15	77.1	1166.0	1646.0	-
6	3	15	83.9	1278.0	1232.0	1459.0
7	3	15	89.1	1240.0	1384.0	1939.0
8	2	15	81.8	1833.0	1676.0	-
9	1	15	50.3	1075.0	-	-
10	3	15	87.1	1116.0	1996.0	1756.0
11	2	15	71.3	1225.0	1815.0	-
12	3	15	97.5	1884.0	1465.0	1132.0
13	3	15	90.6	1561.0	1040.0	1354.0
14	3	15	86.3	1596.0	1183.0	1792.0
15	3	15	97.6	1365.0	1073.0	1361.0
16	3	15	84.7	1021.0	1718.0	1854.0
17	3	15	99.7	1150.0	1244.0	1988.0
18						
19						
20						

Long Pulse Radar Test Signal

Test Signal Name: LP_Signal_06

Number of Bursts in Trial: 14

Chrip Center Frequency: 5500.0MHz

Burst	Pulses per Burst	Chrip (MHz)	Pulse Width(us)	PRI-1 (us)	PRI-2 (us)	PRI-3 (us)
1	3	18	92.9	1085.0	1564.0	1407.0
2	2	18	67.7	1744.0	1747.0	-
3	1	18	65.8	1092.0	-	-
4	1	18	56.3	1851.0	-	-
5	1	18	53.7	1727.0	-	-
6	3	18	83.5	1679.0	1930.0	1025.0
7	1	18	65.8	1519.0	-	-
8	3	18	85.9	1134.0	1034.0	1808.0
9	2	18	76.3	1606.0	1926.0	-
10	2	18	81.5	1891.0	1714.0	-
11	3	18	89.4	1310.0	1594.0	1827.0
12	1	18	63.4	1568.0	-	-
13	2	18	69.6	1307.0	1925.0	-
14	2	18	74.5	1264.0	1846.0	-
15						
16						
17						
18						
19						
20						

Long Pulse Radar Test Signal

Test Signal Name: LP_Signal_07

Number of Bursts in Trial: 15

Chrip Center Frequency: 5500.0MHz

Burst	Pulses per Burst	Chrip (MHz)	Pulse Width(us)	PRI-1 (us)	PRI-2 (us)	PRI-3 (us)
1	3	10	96.6	1182.0	1609.0	1581.0
2	3	10	96.7	1829.0	1799.0	1154.0
3	3	10	86.5	1923.0	1396.0	1865.0
4	2	10	73.3	1908.0	1318.0	-
5	1	10	55.8	1688.0	-	-
6	1	10	55.4	1145.0	-	-
7	3	10	85.3	1336.0	1504.0	1820.0
8	2	10	79.4	1344.0	1893.0	-
9	1	10	65.7	1476.0	-	-
10	2	10	68.6	1008.0	1028.0	-
11	2	10	77.7	1972.0	1835.0	-
12	2	10	79.6	1882.0	1331.0	-
13	3	10	94.9	1830.0	1070.0	1349.0
14	1	10	61.4	1451.0	-	-
15	3	10	90.6	1233.0	1562.0	1887.0
16						
17						
18						
19						
20						

Long Pulse Radar Test Signal

Test Signal Name: LP_Signal_08

Number of Bursts in Trial: 12

Chrip Center Frequency: 5500.0MHz

Burst	Pulses per Burst	Chrip (MHz)	Pulse Width(us)	PRI-1 (us)	PRI-2 (us)	PRI-3 (us)
1	1	13	52.6	1210.0	-	-
2	3	13	84.1	1314.0	1725.0	1529.0
3	3	13	97.7	1139.0	1868.0	1805.0
4	3	13	97.3	1341.0	1446.0	1755.0
5	3	13	98.8	1544.0	1386.0	1302.0
6	2	13	72.2	1771.0	1184.0	-
7	2	13	67.6	1175.0	1027.0	-
8	2	13	75.7	1026.0	1871.0	-
9	1	13	60.9	1798.0	-	-
10	1	13	64.2	1138.0	-	-
11	2	13	78.8	1784.0	1604.0	-
12	3	13	87.5	1511.0	1712.0	1683.0
13						
14						
15						
16						
17						
18						
19						
20						

Long Pulse Radar Test Signal

Test Signal Name: LP_Signal_09

Number of Bursts in Trial: 14

Chirp Center Frequency: 5500.0MHz

Burst	Pulses per Burst	Chirp (MHz)	Pulse Width(us)	PRI-1 (us)	PRI-2 (us)	PRI-3 (us)
1	1	7	54.1	1415.0	-	-
2	1	7	50.7	1221.0	-	-
3	1	7	52.3	1974.0	-	-
4	3	7	99.8	1558.0	1696.0	1949.0
5	2	7	68.4	1014.0	1099.0	-
6	2	7	80.8	1736.0	1505.0	-
7	1	7	62.5	1778.0	-	-
8	2	7	74.8	1149.0	1204.0	-
9	1	7	50.8	1049.0	-	-
10	1	7	54.0	1417.0	-	-
11	1	7	63.0	1730.0	-	-
12	3	7	91.8	1143.0	1270.0	1347.0
13	2	7	79.3	1274.0	1992.0	-
14	1	7	64.3	1937.0	-	-
15						
16						
17						
18						
19						
20						

Long Pulse Radar Test Signal

Test Signal Name: LP_Signal_10

Number of Bursts in Trial: 8

Chrip Center Frequency: 5500.0MHz

Burst	Pulses per Burst	Chrip (MHz)	Pulse Width(us)	PRI-1 (us)	PRI-2 (us)	PRI-3 (us)
1	1	6	63.4	1043.0	-	-
2	1	6	52.0	1863.0	-	-
3	3	6	97.2	1973.0	1605.0	1583.0
4	2	6	78.7	1466.0	1743.0	-
5	2	6	74.2	1280.0	1219.0	-
6	3	6	88.7	1293.0	1934.0	1273.0
7	1	6	54.3	1991.0	-	-
8	3	6	95.4	1580.0	1555.0	1791.0
9						
10						
11						
12						
13						
14						
15						
16						
17						
18						
19						
20						

Long Pulse Radar Test Signal

Test Signal Name: LP_Signal_11

Number of Bursts in Trial: 17

Chirp Center Frequency: 5496.5 MHz

Burst	Pulses per Burst	Chirp (MHz)	Pulse Width(us)	PRI-1 (us)	PRI-2 (us)	PRI-3 (us)
1	2	15	73.7	1208.0	1497.0	-
2	3	15	97.4	1942.0	1754.0	1613.0
3	3	15	91.7	1999.0	1702.0	1462.0
4	1	15	66.2	1393.0	-	-
5	2	15	70.8	1968.0	1821.0	-
6	1	15	52.3	1740.0	-	-
7	2	15	78.9	1308.0	1984.0	-
8	2	15	70.9	1050.0	1358.0	-
9	2	15	75.6	1437.0	1430.0	-
10	1	15	59.1	1697.0	-	-
11	2	15	77.0	1397.0	1304.0	-
12	2	15	67.9	1803.0	1083.0	-
13	2	15	81.2	1720.0	1932.0	-
14	2	15	78.7	1247.0	1121.0	-
15	1	15	63.3	1634.0	-	-
16	2	15	68.9	1849.0	1423.0	-
17	1	15	59.3	1093.0	-	-
18						
19						
20						

Long Pulse Radar Test Signal

Test Signal Name: LP_Signal_12

Number of Bursts in Trial: 19

Chrip Center Frequency: 5497.7 MHz

Burst	Pulses per Burst	Chrip (MHz)	Pulse Width(us)	PRI-1 (us)	PRI-2 (us)	PRI-3 (us)
1	3	18	98.9	1381.0	1680.0	1488.0
2	2	18	82.3	1716.0	1855.0	-
3	3	18	86.7	1211.0	1400.0	1919.0
4	3	18	89.7	1861.0	1068.0	1282.0
5	3	18	98.6	1507.0	1194.0	1461.0
6	2	18	71.1	1921.0	1789.0	-
7	1	18	55.9	1947.0	-	-
8	2	18	67.9	1350.0	1372.0	-
9	3	18	84.4	1203.0	1107.0	1443.0
10	1	18	58.8	1715.0	-	-
11	1	18	65.6	1017.0	-	-
12	2	18	78.5	1911.0	1704.0	-
13	2	18	82.3	1845.0	1686.0	-
14	3	18	90.1	1938.0	1071.0	1266.0
15	3	18	90.2	1989.0	1089.0	1950.0
16	2	18	83.1	1943.0	1406.0	-
17	1	18	58.8	1742.0	-	-
18	2	18	77.0	1187.0	1657.0	-
19	1	18	55.0	1012.0	-	-
20						

Long Pulse Radar Test Signal

Test Signal Name: LP_Signal_13

Number of Bursts in Trial: 15

Chirp Center Frequency: 5495.3MHz

Burst	Pulses per Burst	Chirp (MHz)	Pulse Width(us)	PRI-1 (us)	PRI-2 (us)	PRI-3 (us)
1	1	12	58.1	1929.0	-	-
2	1	12	52.1	1910.0	-	-
3	1	12	59.9	1971.0	-	-
4	1	12	60.2	1812.0	-	-
5	3	12	95.9	1399.0	1906.0	1608.0
6	2	12	79.9	1626.0	1859.0	-
7	2	12	78.5	1238.0	1917.0	-
8	1	12	53.8	1763.0	-	-
9	1	12	64.7	1800.0	-	-
10	1	12	61.4	1390.0	-	-
11	2	12	83.2	1692.0	1858.0	-
12	3	12	84.7	1533.0	1677.0	1638.0
13	3	12	88.7	1703.0	1528.0	1058.0
14	2	12	78.3	1258.0	1951.0	-
15	2	12	69.3	1731.0	1717.0	-
16						
17						
18						
19						
20						

Long Pulse Radar Test Signal

Test Signal Name: LP_Signal_14

Number of Bursts in Trial: 12

Chrip Center Frequency: 5494.1MHz

Burst	Pulses per Burst	Chrip (MHz)	Pulse Width(us)	PRI-1 (us)	PRI-2 (us)	PRI-3 (us)
1	2	9	75.3	1994.0	1612.0	-
2	1	9	56.3	1456.0	-	-
3	2	9	67.7	1617.0	1185.0	-
4	1	9	55.6	1337.0	-	-
5	2	9	75.2	1421.0	1267.0	-
6	2	9	76.3	1359.0	1305.0	-
7	3	9	85.7	1547.0	1362.0	1924.0
8	3	9	98.4	1873.0	1550.0	1249.0
9	3	9	86.4	1779.0	1439.0	1046.0
10	3	9	93.6	1059.0	1031.0	1452.0
11	1	9	63.3	1328.0	-	-
12	3	9	92.4	1412.0	1673.0	1322.0
13						
14						
15						
16						
17						
18						
19						
20						

Long Pulse Radar Test Signal

Test Signal Name: LP_Signal_15

Number of Bursts in Trial: 19

Chrip Center Frequency: 5497.3MHz

Burst	Pulses per Burst	Chrip (MHz)	Pulse Width(us)	PRI-1 (us)	PRI-2 (us)	PRI-3 (us)
1	3	17	93.3	1983.0	1912.0	1535.0
2	2	17	69.1	1102.0	1794.0	-
3	3	17	86.9	1044.0	1152.0	1148.0
4	3	17	84.9	1894.0	1948.0	1118.0
5	2	17	72.3	1094.0	1916.0	-
6	1	17	51.7	1447.0	-	-
7	1	17	58.3	1429.0	-	-
8	1	17	60.8	1979.0	-	-
9	1	17	57.1	1641.0	-	-
10	3	17	88.9	1886.0	1964.0	1489.0
11	2	17	72.0	1909.0	1297.0	-
12	3	17	90.9	1261.0	1566.0	1370.0
13	1	17	59.8	1552.0	-	-
14	2	17	70.0	1759.0	1291.0	-
15	2	17	67.2	1625.0	1881.0	-
16	3	17	91.2	1382.0	1832.0	1661.0
17	1	17	56.5	1483.0	-	-
18	1	17	51.2	1237.0	-	-
19	2	17	74.1	1471.0	1245.0	-
20						

Long Pulse Radar Test Signal

Test Signal Name: LP_Signal_16

Number of Bursts in Trial: 14

Chrip Center Frequency: 5494.9MHz

Burst	Pulses per Burst	Chrip (MHz)	Pulse Width(us)	PRI-1 (us)	PRI-2 (us)	PRI-3 (us)
1	2	11	76.9	1110.0	1140.0	-
2	1	11	50.2	1316.0	-	-
3	1	11	62.9	1520.0	-	-
4	1	11	64.7	1902.0	-	-
5	3	11	83.8	1410.0	1097.0	1621.0
6	1	11	65.4	1944.0	-	-
7	1	11	53.2	1024.0	-	-
8	1	11	51.7	1603.0	-	-
9	2	11	78.7	1804.0	1168.0	-
10	2	11	72.4	1030.0	1343.0	-
11	1	11	53.8	1327.0	-	-
12	2	11	73.6	1524.0	1553.0	-
13	2	11	66.7	1722.0	1122.0	-
14	2	11	82.5	1404.0	1019.0	-
15						
16						
17						
18						
19						
20						

Long Pulse Radar Test Signal

Test Signal Name: LP_Signal_17

Number of Bursts in Trial: 20

Chrip Center Frequency: 5498.1MHz

Burst	Pulses per Burst	Chirp (MHz)	Pulse Width(us)	PRI-1 (us)	PRI-2 (us)	PRI-3 (us)
1	3	19	87.6	1565.0	1055.0	1840.0
2	3	19	85.2	1735.0	1541.0	1408.0
3	3	19	84.8	1534.0	1889.0	1463.0
4	2	19	77.9	1749.0	1460.0	-
5	2	19	76.5	1518.0	1485.0	-
6	1	19	60.9	1540.0	-	-
7	2	19	83.0	1080.0	1010.0	-
8	2	19	80.4	1824.0	1752.0	-
9	2	19	67.5	1764.0	1181.0	-
10	1	19	62.1	1495.0	-	-
11	3	19	86.4	1773.0	1966.0	1263.0
12	3	19	84.3	1593.0	1188.0	1788.0
13	2	19	76.9	1226.0	1537.0	-
14	3	19	95.8	1192.0	1298.0	1844.0
15	1	19	55.2	1644.0	-	-
16	1	19	59.0	1402.0	-	-
17	3	19	94.5	1296.0	1700.0	1283.0
18	3	19	91.9	1970.0	1978.0	1165.0
19	3	19	85.2	1732.0	1551.0	1189.0
20	2	19	69.5	1038.0	1224.0	-

Long Pulse Radar Test Signal

Test Signal Name: LP_Signal_18

Number of Bursts in Trial: 12

Chrip Center Frequency: 5494.1MHz

Burst	Pulses per Burst	Chrip (MHz)	Pulse Width(us)	PRI-1 (us)	PRI-2 (us)	PRI-3 (us)
1	3	9	86.4	1259.0	1918.0	1455.0
2	3	9	92.2	1598.0	1719.0	1895.0
3	2	9	80.4	1816.0	1899.0	-
4	1	9	54.3	1335.0	-	-
5	1	9	53.1	1303.0	-	-
6	2	9	69.4	1503.0	1546.0	-
7	2	9	69.1	1279.0	1639.0	-
8	3	9	100.0	1375.0	1438.0	1595.0
9	2	9	79.6	1239.0	1705.0	-
10	3	9	88.4	1374.0	1579.0	1623.0
11	1	9	53.3	1016.0	-	-
12	1	9	65.3	1709.0	-	-
13						
14						
15						
16						
17						
18						
19						
20						

Long Pulse Radar Test Signal

Test Signal Name: LP_Signal_19

Number of Bursts in Trial: 14

Chrip Center Frequency: 5494.9MHz

Burst	Pulses per Burst	Chrip (MHz)	Pulse Width(us)	PRI-1 (us)	PRI-2 (us)	PRI-3 (us)
1	1	11	55.3	1920.0	-	-
2	1	11	58.3	1797.0	-	-
3	2	11	72.3	1610.0	1039.0	-
4	3	11	84.8	1131.0	1761.0	1721.0
5	2	11	82.5	1875.0	1431.0	-
6	1	11	63.3	1095.0	-	-
7	2	11	80.0	1119.0	1913.0	-
8	3	11	90.3	1660.0	1853.0	1123.0
9	3	11	91.1	1539.0	1783.0	1172.0
10	3	11	96.6	1525.0	1036.0	1385.0
11	2	11	82.7	1710.0	1990.0	-
12	1	11	50.7	1234.0	-	-
13	2	11	78.4	1047.0	1109.0	-
14	3	11	99.5	1299.0	1965.0	1869.0
15						
16						
17						
18						
19						
20						

Long Pulse Radar Test Signal
 Test Signal Name: LP_Signal_20
 Number of Bursts in Trial: 12
 Chrip Center Frequency: 5494.1MHz

Burst	Pulses per Burst	Chrip (MHz)	Pulse Width(us)	PRI-1 (us)	PRI-2 (us)	PRI-3 (us)
1	3	9	88.6	1501.0	1067.0	1927.0
2	1	9	57.4	1723.0	-	-
3	3	9	96.6	1086.0	1658.0	1324.0
4	2	9	69.7	1751.0	1945.0	-
5	2	9	77.9	1642.0	1317.0	-
6	1	9	62.0	1866.0	-	-
7	3	9	88.4	1997.0	1077.0	1366.0
8	3	9	97.3	1790.0	1896.0	1367.0
9	3	9	96.2	1391.0	1787.0	1672.0
10	3	9	95.4	1020.0	1892.0	1414.0
11	1	9	54.8	1084.0	-	-
12	2	9	80.4	1850.0	1436.0	-
13						
14						
15						
16						
17						
18						
19						
20						

Long Pulse Radar Test Signal

Test Signal Name: LP_Signal_21

Number of Bursts in Trial: 16

Chrip Center Frequency: 5503.97MHz

Burst	Pulses per Burst	Chrip (MHz)	Pulse Width(us)	PRI-1 (us)	PRI-2 (us)	PRI-3 (us)
1	2	14	74.7	1619.0	1611.0	-
2	1	14	57.1	1560.0	-	-
3	3	14	91.9	1392.0	1475.0	1276.0
4	2	14	83.1	1809.0	1772.0	-
5	1	14	50.7	1003.0	-	-
6	2	14	79.2	1574.0	1600.0	-
7	1	14	58.7	1186.0	-	-
8	2	14	71.0	1521.0	1567.0	-
9	2	14	79.0	1777.0	1960.0	-
10	2	14	68.5	1284.0	1428.0	-
11	2	14	73.5	1904.0	1352.0	-
12	2	14	70.5	1864.0	1115.0	-
13	2	14	76.6	1045.0	1300.0	-
14	2	14	81.2	1160.0	1675.0	-
15	1	14	61.8	1277.0	-	-
16	3	14	94.9	1450.0	1206.0	1860.0
17						
18						
19						
20						

Long Pulse Radar Test Signal

Test Signal Name: LP_Signal_22

Number of Bursts in Trial: 12

Chrip Center Frequency: 5506.37MHz

Burst	Pulses per Burst	Chrip (MHz)	Pulse Width(us)	PRI-1 (us)	PRI-2 (us)	PRI-3 (us)
1	2	8	78.5	1653.0	1698.0	-
2	3	8	89.8	1174.0	1962.0	1167.0
3	1	8	59.4	1982.0	-	-
4	2	8	79.6	1633.0	1890.0	-
5	2	8	76.0	1112.0	1811.0	-
6	1	8	53.6	1144.0	-	-
7	2	8	80.9	1220.0	1053.0	-
8	1	8	61.6	1724.0	-	-
9	1	8	53.4	1901.0	-	-
10	1	8	59.9	1379.0	-	-
11	1	8	60.4	1453.0	-	-
12	3	8	91.4	1768.0	1726.0	1227.0
13						
14						
15						
16						
17						
18						
19						
20						

Long Pulse Radar Test Signal

Test Signal Name: LP_Signal_23

Number of Bursts in Trial: 20

Chrip Center Frequency: 5501.97MHz

Burst	Pulses per Burst	Chrip (MHz)	Pulse Width(us)	PRI-1 (us)	PRI-2 (us)	PRI-3 (us)
1	2	19	77.0	1191.0	1363.0	-
2	1	19	58.1	1248.0	-	-
3	1	19	62.1	1836.0	-	-
4	2	19	76.9	1334.0	1236.0	-
5	2	19	80.0	1914.0	1852.0	-
6	1	19	52.0	1701.0	-	-
7	3	19	88.6	1693.0	1995.0	1905.0
8	2	19	72.9	1922.0	1387.0	-
9	3	19	98.5	1839.0	1746.0	1389.0
10	1	19	57.9	1193.0	-	-
11	3	19	95.9	1659.0	1870.0	1066.0
12	1	19	53.5	1162.0	-	-
13	3	19	92.0	1745.0	1654.0	1458.0
14	1	19	57.3	1834.0	-	-
15	2	19	70.5	1684.0	1586.0	-
16	2	19	70.0	1042.0	1664.0	-
17	3	19	84.0	1765.0	1630.0	1176.0
18	2	19	76.1	1557.0	1057.0	-
19	3	19	93.2	1985.0	1018.0	1340.0
20	3	19	96.8	1760.0	1614.0	1817.0

Long Pulse Radar Test Signal

Test Signal Name: LP_Signal_24

Number of Bursts in Trial: 14

Chrip Center Frequency: 5505.17MHz

Burst	Pulses per Burst	Chrip (MHz)	Pulse Width(us)	PRI-1 (us)	PRI-2 (us)	PRI-3 (us)
1	1	11	50.1	1841.0	-	-
2	3	11	93.5	1590.0	1081.0	1413.0
3	2	11	68.8	1707.0	1577.0	-
4	1	11	56.3	1056.0	-	-
5	3	11	86.0	1953.0	1108.0	1987.0
6	2	11	75.2	1572.0	1536.0	-
7	1	11	54.4	1517.0	-	-
8	2	11	71.1	1329.0	1243.0	-
9	2	11	76.2	1940.0	1770.0	-
10	2	11	80.2	1098.0	1209.0	-
11	2	11	79.7	1588.0	1214.0	-
12	3	11	90.9	1615.0	1862.0	1601.0
13	2	11	68.7	1377.0	1441.0	-
14	2	11	67.4	1872.0	1313.0	-
15						
16						
17						
18						
19						
20						

Long Pulse Radar Test Signal

Test Signal Name: LP_Signal_25

Number of Bursts in Trial: 13

Chrip Center Frequency: 5505.57MHz

Burst	Pulses per Burst	Chrip (MHz)	Pulse Width(us)	PRI-1 (us)	PRI-2 (us)	PRI-3 (us)
1	3	10	94.0	1643.0	1748.0	1941.0
2	2	10	70.8	1177.0	1201.0	-
3	1	10	56.3	1006.0	-	-
4	3	10	96.7	1230.0	1163.0	1332.0
5	3	10	90.6	1217.0	1582.0	1498.0
6	2	10	74.5	1569.0	1281.0	-
7	3	10	92.6	1065.0	1669.0	1222.0
8	3	10	89.0	1493.0	1135.0	1380.0
9	3	10	96.5	1607.0	1822.0	1602.0
10	2	10	70.5	1141.0	1178.0	-
11	3	10	94.0	1009.0	1629.0	1956.0
12	1	10	55.8	1290.0	-	-
13	3	10	87.7	1435.0	1963.0	1164.0
14						
15						
16						
17						
18						
19						
20						

Long Pulse Radar Test Signal

Test Signal Name: LP_Signal_26

Number of Bursts in Trial: 8

Chrip Center Frequency: 5507.57MHz

Burst	Pulses per Burst	Chrip (MHz)	Pulse Width(us)	PRI-1 (us)	PRI-2 (us)	PRI-3 (us)
1	2	5	68.6	1306.0	1161.0	-
2	2	5	83.1	1420.0	1315.0	-
3	1	5	60.9	1687.0	-	-
4	2	5	77.7	1776.0	1158.0	-
5	2	5	77.4	1793.0	1510.0	-
6	2	5	66.8	1576.0	1323.0	-
7	1	5	63.7	1333.0	-	-
8	3	5	91.2	1409.0	1681.0	1275.0
9						
10						
11						
12						
13						
14						

Long Pulse Radar Test Signal

Test Signal Name: LP_Signal_27

Number of Bursts in Trial: 17

Chrip Center Frequency: 5503.57MHz

Burst	Pulses per Burst	Chrip (MHz)	Pulse Width(us)	PRI-1 (us)	PRI-2 (us)	PRI-3 (us)
1	3	15	83.6	1632.0	1195.0	1000.0
2	3	15	89.4	1173.0	1627.0	1656.0
3	1	15	55.8	1532.0	-	-
4	3	15	90.9	1981.0	1554.0	1998.0
5	1	15	54.7	1825.0	-	-
6	3	15	97.7	1734.0	1202.0	1250.0
7	2	15	67.5	1571.0	1434.0	-
8	3	15	96.7	1589.0	1469.0	1268.0
9	2	15	68.3	1750.0	1954.0	-
10	2	15	78.3	1591.0	1082.0	-
11	1	15	55.0	1427.0	-	-
12	3	15	84.9	1129.0	1936.0	1199.0
13	2	15	74.6	1959.0	1856.0	-
14	1	15	63.3	1885.0	-	-
15	3	15	99.8	1035.0	1515.0	1120.0
16	1	15	63.6	1647.0	-	-
17	3	15	87.3	1931.0	1051.0	1831.0
18						

Long Pulse Radar Test Signal

Test Signal Name: LP_Signal_28

Number of Bursts in Trial: 19

Chrip Center Frequency: 5502.37MHz

Burst	Pulses per Burst	Chrip (MHz)	Pulse Width(us)	PRI-1 (us)	PRI-2 (us)	PRI-3 (us)
1	3	18	85.6	1946.0	1078.0	1015.0
2	2	18	68.6	1029.0	1780.0	-
3	1	18	54.2	1111.0	-	-
4	1	18	61.2	1104.0	-	-
5	3	18	97.1	1157.0	1969.0	1100.0
6	3	18	98.3	1142.0	1699.0	1622.0
7	1	18	62.4	1655.0	-	-
8	2	18	80.2	1126.0	1769.0	-
9	3	18	87.5	1216.0	1448.0	1179.0
10	3	18	85.8	1847.0	1348.0	1472.0
11	3	18	88.1	1023.0	1124.0	1631.0
12	1	18	65.3	1848.0	-	-
13	1	18	52.5	1470.0	-	-
14	1	18	52.3	1312.0	-	-
15	2	18	74.1	1915.0	1200.0	-
16	1	18	54.9	1479.0	-	-
17	2	18	76.2	1376.0	1502.0	-
18	1	18	60.4	1758.0	-	-
19	2	18	81.5	1491.0	1103.0	-
20						

Long Pulse Radar Test Signal

Test Signal Name: LP_Signal_29

Number of Bursts in Trial: 12

Chirp Center Frequency: 5505.97MHz

Burst	Pulses per Burst	Chirp (MHz)	Pulse Width(us)	PRI-1 (us)	PRI-2 (us)	PRI-3 (us)
1	1	9	50.5	1857.0	-	-
2	1	9	55.7	1246.0	-	-
3	3	9	85.8	1774.0	1002.0	1967.0
4	2	9	76.9	1125.0	1474.0	-
5	2	9	75.1	1254.0	1052.0	-
6	3	9	92.3	1180.0	1486.0	1492.0
7	2	9	78.1	1301.0	1757.0	-
8	3	9	92.2	1898.0	1252.0	1713.0
9	3	9	89.0	1260.0	1706.0	1411.0
10	2	9	70.9	1578.0	1620.0	-
11	1	9	63.1	1782.0	-	-
12	1	9	55.3	1522.0	-	-
13						

Long Pulse Radar Test Signal

Test Signal Name: LP_Signal_30

Number of Bursts in Trial: 18

Chrip Center Frequency: 5503.17MHz

Burst	Pulses per Burst	Chrip (MHz)	Pulse Width(us)	PRI-1 (us)	PRI-2 (us)	PRI-3 (us)
1	3	16	83.4	1454.0	1205.0	1801.0
2	3	16	97.3	1319.0	1826.0	1635.0
3	3	16	90.4	1079.0	1986.0	1674.0
4	3	16	91.8	1563.0	1151.0	1802.0
5	3	16	98.2	1876.0	1977.0	1766.0
6	1	16	59.5	1952.0	-	-
7	2	16	80.0	1253.0	1137.0	-
8	3	16	86.5	1054.0	1128.0	1828.0
9	3	16	91.1	1105.0	1599.0	1442.0
10	3	16	93.5	1867.0	1373.0	1087.0
11	1	16	60.7	1033.0	-	-
12	2	16	67.2	1288.0	1405.0	-
13	1	16	61.8	1585.0	-	-
14	2	16	79.4	1933.0	1667.0	-
15	2	16	81.4	1096.0	1464.0	-
16	1	16	65.7	1496.0	-	-
17	2	16	76.0	1733.0	1255.0	-
18	2	16	81.0	1326.0	1668.0	-

802.11be (EHT40)

Long Pulse Radar Test Signal

Test Signal Name: LP_Signal_01

Number of Bursts in Trial: 15

Chrip Center Frequency 5510.0MHz

Burst	Pulses per Burst	Chirp (MHz)	Pulse Width(us)	PRI-1 (us)	PRI-2 (us)	PRI-3 (us)
1	2	7	77.8	1665.0	1477.0	-
2	1	7	51.9	1074.0	-	-
3	1	7	63.8	1584.0	-	-
4	3	7	96.6	1682.0	1786.0	1843.0
5	3	7	85.9	1795.0	1215.0	1729.0
6	2	7	73.7	1198.0	1549.0	-
7	2	7	77.2	1837.0	1819.0	-
8	2	7	68.4	1587.0	1114.0	-
9	2	7	76.7	2000.0	1155.0	-
10	1	7	53.2	1147.0	-	-
11	3	7	85.7	1433.0	1695.0	1394.0
12	3	7	94.3	1670.0	1426.0	1935.0
13	2	7	77.6	1294.0	1671.0	-
14	1	7	65.7	1512.0	-	-
15	3	7	93.5	1444.0	1130.0	1468.0
16						
17						
18						
19						
20						

Long Pulse Radar Test Signal

Test Signal Name: LP_Signal_02

Number of Bursts in Trial: 8

Chrip Center Frequency: 5510.0MHz

Burst	Pulses per Burst	Chirp (MHz)	Pulse Width(us)	PRI-1 (us)	PRI-2 (us)	PRI-3 (us)
1	2	16	75.0	1880.0	1527.0	-
2	3	16	99.4	1401.0	1262.0	1257.0
3	2	16	67.4	1531.0	1403.0	-
4	2	16	73.6	1449.0	1041.0	-
5	1	16	65.9	1432.0	-	-
6	3	16	83.8	1356.0	1292.0	1419.0
7	1	16	65.5	1543.0	-	-
8	3	16	98.6	1548.0	1796.0	1728.0
9						
10						
11						
12						
13						
14						
15						
16						
17						
18						
19						
20						

Long Pulse Radar Test Signal

Test Signal Name: LP_Signal_03

Number of Bursts in Trial: 11

Chrip Center Frequency: 5510.0MHz

Burst	Pulses per Burst	Chrip (MHz)	Pulse Width(us)	PRI-1 (us)	PRI-2 (us)	PRI-3 (us)
1	2	6	73.8	1806.0	1538.0	-
2	2	6	69.5	1117.0	1649.0	-
3	1	6	51.9	1651.0	-	-
4	3	6	84.6	1976.0	1032.0	1271.0
5	3	6	95.4	1060.0	1903.0	1388.0
6	2	6	68.0	1368.0	1351.0	-
7	3	6	89.6	1338.0	1514.0	1573.0
8	2	6	81.9	1022.0	1689.0	-
9	3	6	88.3	1810.0	1330.0	1838.0
10	1	6	53.7	1597.0	-	-
11	3	6	91.3	1961.0	1106.0	1001.0
12						
13						
14						
15						
16						
17						
18						
19						
20						

Long Pulse Radar Test Signal

Test Signal Name: LP_Signal_04

Number of Bursts in Trial: 20

Chrip Center Frequency: 5510.0MHz

Burst	Pulses per Burst	Chrip (MHz)	Pulse Width(us)	PRI-1 (us)	PRI-2 (us)	PRI-3 (us)
1	2	19	68.1	1339.0	1355.0	-
2	1	19	58.7	1251.0	-	-
3	2	19	75.3	1136.0	1640.0	-
4	1	19	56.4	1753.0	-	-
5	3	19	99.7	1196.0	1708.0	1159.0
6	1	19	57.7	1013.0	-	-
7	1	19	59.5	1072.0	-	-
8	2	19	80.0	1482.0	1369.0	-
9	2	19	82.0	1993.0	1197.0	-
10	2	19	82.8	1883.0	1005.0	-
11	3	19	88.0	1061.0	1928.0	1101.0
12	3	19	93.2	1207.0	1907.0	1223.0
13	2	19	70.4	1526.0	1360.0	-
14	3	19	95.3	1171.0	1955.0	1775.0
15	2	19	81.9	1690.0	1545.0	-
16	3	19	98.5	1975.0	1169.0	1062.0
17	1	19	65.0	1767.0	-	-
18	3	19	85.4	1011.0	1637.0	1425.0
19	3	19	91.6	1878.0	1445.0	1325.0
20	2	19	67.3	1091.0	1218.0	-

Long Pulse Radar Test Signal

Test Signal Name: LP_Signal_05

Number of Bursts in Trial: 17

Chrip Center Frequency: 5510.0MHz

Burst	Pulses per Burst	Chrip (MHz)	Pulse Width(us)	PRI-1 (us)	PRI-2 (us)	PRI-3 (us)
1	2	8	67.9	1320.0	1133.0	-
2	1	8	62.3	1957.0	-	-
3	1	8	53.3	1592.0	-	-
4	3	8	90.0	1900.0	1153.0	1346.0
5	2	8	77.1	1166.0	1646.0	-
6	3	8	83.9	1278.0	1232.0	1459.0
7	3	8	89.1	1240.0	1384.0	1939.0
8	2	8	81.8	1833.0	1676.0	-
9	1	8	50.3	1075.0	-	-
10	3	8	87.1	1116.0	1996.0	1756.0
11	2	8	71.3	1225.0	1815.0	-
12	3	8	97.5	1884.0	1465.0	1132.0
13	3	8	90.6	1561.0	1040.0	1354.0
14	3	8	86.3	1596.0	1183.0	1792.0
15	3	8	97.6	1365.0	1073.0	1361.0
16	3	8	84.7	1021.0	1718.0	1854.0
17	3	8	99.7	1150.0	1244.0	1988.0
18						
19						
20						

Long Pulse Radar Test Signal

Test Signal Name: LP_Signal_06

Number of Bursts in Trial: 14

Chrip Center Frequency: 5510.0MHz

Burst	Pulses per Burst	Chrip (MHz)	Pulse Width(us)	PRI-1 (us)	PRI-2 (us)	PRI-3 (us)
1	3	5	92.9	1085.0	1564.0	1407.0
2	2	5	67.7	1744.0	1747.0	-
3	1	5	65.8	1092.0	-	-
4	1	5	56.3	1851.0	-	-
5	1	5	53.7	1727.0	-	-
6	3	5	83.5	1679.0	1930.0	1025.0
7	1	5	65.8	1519.0	-	-
8	3	5	85.9	1134.0	1034.0	1808.0
9	2	5	76.3	1606.0	1926.0	-
10	2	5	81.5	1891.0	1714.0	-
11	3	5	89.4	1310.0	1594.0	1827.0
12	1	5	63.4	1568.0	-	-
13	2	5	69.6	1307.0	1925.0	-
14	2	5	74.5	1264.0	1846.0	-
15						
16						
17						
18						
19						
20						

Long Pulse Radar Test Signal

Test Signal Name: LP_Signal_07

Number of Bursts in Trial: 15

Chrip Center Frequency: 5510.0MHz

Burst	Pulses per Burst	Chrip (MHz)	Pulse Width(us)	PRI-1 (us)	PRI-2 (us)	PRI-3 (us)
1	3	11	96.6	1182.0	1609.0	1581.0
2	3	11	96.7	1829.0	1799.0	1154.0
3	3	11	86.5	1923.0	1396.0	1865.0
4	2	11	73.3	1908.0	1318.0	-
5	1	11	55.8	1688.0	-	-
6	1	11	55.4	1145.0	-	-
7	3	11	85.3	1336.0	1504.0	1820.0
8	2	11	79.4	1344.0	1893.0	-
9	1	11	65.7	1476.0	-	-
10	2	11	68.6	1008.0	1028.0	-
11	2	11	77.7	1972.0	1835.0	-
12	2	11	79.6	1882.0	1331.0	-
13	3	11	94.9	1830.0	1070.0	1349.0
14	1	11	61.4	1451.0	-	-
15	3	11	90.6	1233.0	1562.0	1887.0
16						
17						
18						
19						
20						

Long Pulse Radar Test Signal

Test Signal Name: LP_Signal_08

Number of Bursts in Trial: 12

Chrip Center Frequency: 5510.0MHz

Burst	Pulses per Burst	Chrip (MHz)	Pulse Width(us)	PRI-1 (us)	PRI-2 (us)	PRI-3 (us)
1	1	20	52.6	1210.0	-	-
2	3	20	84.1	1314.0	1725.0	1529.0
3	3	20	97.7	1139.0	1868.0	1805.0
4	3	20	97.3	1341.0	1446.0	1755.0
5	3	20	98.8	1544.0	1386.0	1302.0
6	2	20	72.2	1771.0	1184.0	-
7	2	20	67.6	1175.0	1027.0	-
8	2	20	75.7	1026.0	1871.0	-
9	1	20	60.9	1798.0	-	-
10	1	20	64.2	1138.0	-	-
11	2	20	78.8	1784.0	1604.0	-
12	3	20	87.5	1511.0	1712.0	1683.0
13						
14						
15						
16						
17						
18						
19						
20						

Long Pulse Radar Test Signal

Test Signal Name: LP_Signal_09

Number of Bursts in Trial: 14

Chrip Center Frequency: 5510.0MHz

Burst	Pulses per Burst	Chrip (MHz)	Pulse Width(us)	PRI-1 (us)	PRI-2 (us)	PRI-3 (us)
1	1	12	54.1	1415.0	-	-
2	1	12	50.7	1221.0	-	-
3	1	12	52.3	1974.0	-	-
4	3	12	99.8	1558.0	1696.0	1949.0
5	2	12	68.4	1014.0	1099.0	-
6	2	12	80.8	1736.0	1505.0	-
7	1	12	62.5	1778.0	-	-
8	2	12	74.8	1149.0	1204.0	-
9	1	12	50.8	1049.0	-	-
10	1	12	54.0	1417.0	-	-
11	1	12	63.0	1730.0	-	-
12	3	12	91.8	1143.0	1270.0	1347.0
13	2	12	79.3	1274.0	1992.0	-
14	1	12	64.3	1937.0	-	-
15						
16						
17						
18						
19						

Long Pulse Radar Test Signal

Test Signal Name: LP_Signal_10

Number of Bursts in Trial: 8

Chrip Center Frequency: 5510.0MHz

Burst	Pulses per Burst	Chrip (MHz)	Pulse Width(us)	PRI-1 (us)	PRI-2 (us)	PRI-3 (us)
1	1	16	63.4	1043.0	-	-
2	1	16	52.0	1863.0	-	-
3	3	16	97.2	1973.0	1605.0	1583.0
4	2	16	78.7	1466.0	1743.0	-
5	2	16	74.2	1280.0	1219.0	-
6	3	16	88.7	1293.0	1934.0	1273.0
7	1	16	54.3	1991.0	-	-
8	3	16	95.4	1580.0	1555.0	1791.0
9						
10						
11						
12						
13						
14						
15						
16						
17						
18						
19						
20						

Long Pulse Radar Test Signal

Test Signal Name: LP_Signal_11

Number of Bursts in Trial: 17

Chrip Center Frequency: 5497.57MHz

Burst	Pulses per Burst	Chrip (MHz)	Pulse Width(us)	PRI-1 (us)	PRI-2 (us)	PRI-3 (us)
1	2	16	73.7	1208.0	1497.0	-
2	3	16	97.4	1942.0	1754.0	1613.0
3	3	16	91.7	1999.0	1702.0	1462.0
4	1	16	66.2	1393.0	-	-
5	2	16	70.8	1968.0	1821.0	-
6	1	16	52.3	1740.0	-	-
7	2	16	78.9	1308.0	1984.0	-
8	2	16	70.9	1050.0	1358.0	-
9	2	16	75.6	1437.0	1430.0	-
10	1	16	59.1	1697.0	-	-
11	2	16	77.0	1397.0	1304.0	-
12	2	16	67.9	1803.0	1083.0	-
13	2	16	81.2	1720.0	1932.0	-
14	2	16	78.7	1247.0	1121.0	-
15	1	16	63.3	1634.0	-	-
16	2	16	68.9	1849.0	1423.0	-
17	1	16	59.3	1093.0	-	-
18						
19						
20						

Long Pulse Radar Test Signal

Test Signal Name: LP_Signal_12

Number of Bursts in Trial: 19

Chrip Center Frequency: 5498.77MHz

Burst	Pulses per Burst	Chrip (MHz)	Pulse Width(us)	PRI-1 (us)	PRI-2 (us)	PRI-3 (us)
1	3	19	98.9	1381.0	1680.0	1488.0
2	2	19	82.3	1716.0	1855.0	-
3	3	19	86.7	1211.0	1400.0	1919.0
4	3	19	89.7	1861.0	1068.0	1282.0
5	3	19	98.6	1507.0	1194.0	1461.0
6	2	19	71.1	1921.0	1789.0	-
7	1	19	55.9	1947.0	-	-
8	2	19	67.9	1350.0	1372.0	-
9	3	19	84.4	1203.0	1107.0	1443.0
10	1	19	58.8	1715.0	-	-
11	1	19	65.6	1017.0	-	-
12	2	19	78.5	1911.0	1704.0	-
13	2	19	82.3	1845.0	1686.0	-
14	3	19	90.1	1938.0	1071.0	1266.0
15	3	19	90.2	1989.0	1089.0	1950.0
16	2	19	83.1	1943.0	1406.0	-
17	1	19	58.8	1742.0	-	-
18	2	19	77.0	1187.0	1657.0	-
19	1	19	55.0	1012.0	-	-
20						

Long Pulse Radar Test Signal

Test Signal Name: LP_Signal_13

Number of Bursts in Trial: 15

Chrip Center Frequency: 5496.37MHz

Burst	Pulses per Burst	Chrip (MHz)	Pulse Width(us)	PRI-1 (us)	PRI-2 (us)	PRI-3 (us)
1	1	13	58.1	1929.0	-	-
2	1	13	52.1	1910.0	-	-
3	1	13	59.9	1971.0	-	-
4	1	13	60.2	1812.0	-	-
5	3	13	95.9	1399.0	1906.0	1608.0
6	2	13	79.9	1626.0	1859.0	-
7	2	13	78.5	1238.0	1917.0	-
8	1	13	53.8	1763.0	-	-
9	1	13	64.7	1800.0	-	-
10	1	13	61.4	1390.0	-	-
11	2	13	83.2	1692.0	1858.0	-
12	3	13	84.7	1533.0	1677.0	1638.0
13	3	13	88.7	1703.0	1528.0	1058.0
14	2	13	78.3	1258.0	1951.0	-
15	2	13	69.3	1731.0	1717.0	-
16						
17						
18						
19						
20						

Long Pulse Radar Test Signal

Test Signal Name: LP_Signal_14

Number of Bursts in Trial: 12

Chrip Center Frequency: 5495.17MHz

Burst	Pulses per Burst	Chrip (MHz)	Pulse Width(us)	PRI-1 (us)	PRI-2 (us)	PRI-3 (us)
1	2	10	75.3	1994.0	1612.0	-
2	1	10	56.3	1456.0	-	-
3	2	10	67.7	1617.0	1185.0	-
4	1	10	55.6	1337.0	-	-
5	2	10	75.2	1421.0	1267.0	-
6	2	10	76.3	1359.0	1305.0	-
7	3	10	85.7	1547.0	1362.0	1924.0
8	3	10	98.4	1873.0	1550.0	1249.0
9	3	10	86.4	1779.0	1439.0	1046.0
10	3	10	93.6	1059.0	1031.0	1452.0
11	1	10	63.3	1328.0	-	-
12	3	10	92.4	1412.0	1673.0	1322.0
13						
14						
15						
16						
17						
18						
19						
20						

Long Pulse Radar Test Signal

Test Signal Name: LP_Signal_15

Number of Bursts in Trial: 19

Chrip Center Frequency: 5498.37MHz

Burst	Pulses per Burst	Chrip (MHz)	Pulse Width(us)	PRI-1 (us)	PRI-2 (us)	PRI-3 (us)
1	3	18	93.3	1983.0	1912.0	1535.0
2	2	18	69.1	1102.0	1794.0	-
3	3	18	86.9	1044.0	1152.0	1148.0
4	3	18	84.9	1894.0	1948.0	1118.0
5	2	18	72.3	1094.0	1916.0	-
6	1	18	51.7	1447.0	-	-
7	1	18	58.3	1429.0	-	-
8	1	18	60.8	1979.0	-	-
9	1	18	57.1	1641.0	-	-
10	3	18	88.9	1886.0	1964.0	1489.0
11	2	18	72.0	1909.0	1297.0	-
12	3	18	90.9	1261.0	1566.0	1370.0
13	1	18	59.8	1552.0	-	-
14	2	18	70.0	1759.0	1291.0	-
15	2	18	67.2	1625.0	1881.0	-
16	3	18	91.2	1382.0	1832.0	1661.0
17	1	18	56.5	1483.0	-	-
18	1	18	51.2	1237.0	-	-
19	2	18	74.1	1471.0	1245.0	-
20						

Long Pulse Radar Test Signal

Test Signal Name: LP_Signal_16

Number of Bursts in Trial: 14

Chrip Center Frequency: 5495.97MHz

Burst	Pulses per Burst	Chrip (MHz)	Pulse Width(us)	PRI-1 (us)	PRI-2 (us)	PRI-3 (us)
1	2	12	76.9	1110.0	1140.0	-
2	1	12	50.2	1316.0	-	-
3	1	12	62.9	1520.0	-	-
4	1	12	64.7	1902.0	-	-
5	3	12	83.8	1410.0	1097.0	1621.0
6	1	12	65.4	1944.0	-	-
7	1	12	53.2	1024.0	-	-
8	1	12	51.7	1603.0	-	-
9	2	12	78.7	1804.0	1168.0	-
10	2	12	72.4	1030.0	1343.0	-
11	1	12	53.8	1327.0	-	-
12	2	12	73.6	1524.0	1553.0	-
13	2	12	66.7	1722.0	1122.0	-
14	2	12	82.5	1404.0	1019.0	-
15						
16						
17						
18						
19						
20						

Long Pulse Radar Test Signal

Test Signal Name: LP_Signal_17

Number of Bursts in Trial: 20

Chrip Center Frequency: 5499.17MHz

Burst	Pulses per Burst	Chrip (MHz)	Pulse Width(us)	PRI-1 (us)	PRI-2 (us)	PRI-3 (us)
1	3	20	87.6	1565.0	1055.0	1840.0
2	3	20	85.2	1735.0	1541.0	1408.0
3	3	20	84.8	1534.0	1889.0	1463.0
4	2	20	77.9	1749.0	1460.0	-
5	2	20	76.5	1518.0	1485.0	-
6	1	20	60.9	1540.0	-	-
7	2	20	83.0	1080.0	1010.0	-
8	2	20	80.4	1824.0	1752.0	-
9	2	20	67.5	1764.0	1181.0	-
10	1	20	62.1	1495.0	-	-
11	3	20	86.4	1773.0	1966.0	1263.0
12	3	20	84.3	1593.0	1188.0	1788.0
13	2	20	76.9	1226.0	1537.0	-
14	3	20	95.8	1192.0	1298.0	1844.0
15	1	20	55.2	1644.0	-	-
16	1	20	59.0	1402.0	-	-
17	3	20	94.5	1296.0	1700.0	1283.0
18	3	20	91.9	1970.0	1978.0	1165.0
19	3	20	85.2	1732.0	1551.0	1189.0
20	2	20	69.5	1038.0	1224.0	-

Long Pulse Radar Test Signal

Test Signal Name: LP_Signal_18

Number of Bursts in Trial: 12

Chrip Center Frequency: 5495.17MHz

Burst	Pulses per Burst	Chrip (MHz)	Pulse Width(us)	PRI-1 (us)	PRI-2 (us)	PRI-3 (us)
1	3	10	86.4	1259.0	1918.0	1455.0
2	3	10	92.2	1598.0	1719.0	1895.0
3	2	10	80.4	1816.0	1899.0	-
4	1	10	54.3	1335.0	-	-
5	1	10	53.1	1303.0	-	-
6	2	10	69.4	1503.0	1546.0	-
7	2	10	69.1	1279.0	1639.0	-
8	3	10	100.0	1375.0	1438.0	1595.0
9	2	10	79.6	1239.0	1705.0	-
10	3	10	88.4	1374.0	1579.0	1623.0
11	1	10	53.3	1016.0	-	-
12	1	10	65.3	1709.0	-	-
13						
14						
15						
16						
17						
18						
19						
20						

Long Pulse Radar Test Signal

Test Signal Name: LP_Signal_19

Number of Bursts in Trial: 14

Chrip Center Frequency: 5495.97MHz

Burst	Pulses per Burst	Chrip (MHz)	Pulse Width(us)	PRI-1 (us)	PRI-2 (us)	PRI-3 (us)
1	1	12	55.3	1920.0	-	-
2	1	12	58.3	1797.0	-	-
3	2	12	72.3	1610.0	1039.0	-
4	3	12	84.8	1131.0	1761.0	1721.0
5	2	12	82.5	1875.0	1431.0	-
6	1	12	63.3	1095.0	-	-
7	2	12	80.0	1119.0	1913.0	-
8	3	12	90.3	1660.0	1853.0	1123.0
9	3	12	91.1	1539.0	1783.0	1172.0
10	3	12	96.6	1525.0	1036.0	1385.0
11	2	12	82.7	1710.0	1990.0	-
12	1	12	50.7	1234.0	-	-
13	2	12	78.4	1047.0	1109.0	-
14	3	12	99.5	1299.0	1965.0	1869.0
15						
16						
17						
18						
19						
20						

Long Pulse Radar Test Signal
 Test Signal Name: LP_Signal_20
 Number of Bursts in Trial: 12
 Chrip Center Frequency: 5495.17MHz

Burst	Pulses per Burst	Chrip (MHz)	Pulse Width(us)	PRI-1 (us)	PRI-2 (us)	PRI-3 (us)
1	3	10	88.6	1501.0	1067.0	1927.0
2	1	10	57.4	1723.0	-	-
3	3	10	96.6	1086.0	1658.0	1324.0
4	2	10	69.7	1751.0	1945.0	-
5	2	10	77.9	1642.0	1317.0	-
6	1	10	62.0	1866.0	-	-
7	3	10	88.4	1997.0	1077.0	1366.0
8	3	10	97.3	1790.0	1896.0	1367.0
9	3	10	96.2	1391.0	1787.0	1672.0
10	3	10	95.4	1020.0	1892.0	1414.0
11	1	10	54.8	1084.0	-	-
12	2	10	80.4	1850.0	1436.0	-
13						
14						
15						
16						
17						
18						
19						
20						

Long Pulse Radar Test Signal

Test Signal Name: LP_Signal_21

Number of Bursts in Trial: 16

Chrip Center Frequency: 5522.95MHz

Burst	Pulses per Burst	Chrip (MHz)	Pulse Width(us)	PRI-1 (us)	PRI-2 (us)	PRI-3 (us)
1	2	15	74.7	1619.0	1611.0	-
2	1	15	57.1	1560.0	-	-
3	3	15	91.9	1392.0	1475.0	1276.0
4	2	15	83.1	1809.0	1772.0	-
5	1	15	50.7	1003.0	-	-
6	2	15	79.2	1574.0	1600.0	-
7	1	15	58.7	1186.0	-	-
8	2	15	71.0	1521.0	1567.0	-
9	2	15	79.0	1777.0	1960.0	-
10	2	15	68.5	1284.0	1428.0	-
11	2	15	73.5	1904.0	1352.0	-
12	2	15	70.5	1864.0	1115.0	-
13	2	15	76.6	1045.0	1300.0	-
14	2	15	81.2	1160.0	1675.0	-
15	1	15	61.8	1277.0	-	-
16	3	15	94.9	1450.0	1206.0	1860.0
17						
18						
19						
20						

Long Pulse Radar Test Signal

Test Signal Name: LP_Signal_22

Number of Bursts in Trial: 12

Chrip Center Frequency: 5525.35MHz

Burst	Pulses per Burst	Chrip (MHz)	Pulse Width(us)	PRI-1 (us)	PRI-2 (us)	PRI-3 (us)
1	2	9	78.5	1653.0	1698.0	-
2	3	9	89.8	1174.0	1962.0	1167.0
3	1	9	59.4	1982.0	-	-
4	2	9	79.6	1633.0	1890.0	-
5	2	9	76.0	1112.0	1811.0	-
6	1	9	53.6	1144.0	-	-
7	2	9	80.9	1220.0	1053.0	-
8	1	9	61.6	1724.0	-	-
9	1	9	53.4	1901.0	-	-
10	1	9	59.9	1379.0	-	-
11	1	9	60.4	1453.0	-	-
12	3	9	91.4	1768.0	1726.0	1227.0
13						
14						
15						
16						
17						
18						
19						
20						

Long Pulse Radar Test Signal

Test Signal Name: LP_Signal_23

Number of Bursts in Trial: 20

Chrip Center Frequency: 5520.95MHz

Burst	Pulses per Burst	Chrip (MHz)	Pulse Width(us)	PRI-1 (us)	PRI-2 (us)	PRI-3 (us)
1	2	20	77.0	1191.0	1363.0	-
2	1	20	58.1	1248.0	-	-
3	1	20	62.1	1836.0	-	-
4	2	20	76.9	1334.0	1236.0	-
5	2	20	80.0	1914.0	1852.0	-
6	1	20	52.0	1701.0	-	-
7	3	20	88.6	1693.0	1995.0	1905.0
8	2	20	72.9	1922.0	1387.0	-
9	3	20	98.5	1839.0	1746.0	1389.0
10	1	20	57.9	1193.0	-	-
11	3	20	95.9	1659.0	1870.0	1066.0
12	1	20	53.5	1162.0	-	-
13	3	20	92.0	1745.0	1654.0	1458.0
14	1	20	57.3	1834.0	-	-
15	2	20	70.5	1684.0	1586.0	-
16	2	20	70.0	1042.0	1664.0	-
17	3	20	84.0	1765.0	1630.0	1176.0
18	2	20	76.1	1557.0	1057.0	-
19	3	20	93.2	1985.0	1018.0	1340.0
20	3	20	96.8	1760.0	1614.0	1817.0

Long Pulse Radar Test Signal

Test Signal Name: LP_Signal_24

Number of Bursts in Trial: 14

Chrip Center Frequency: 5524.15MHz

Burst	Pulses per Burst	Chrip (MHz)	Pulse Width(us)	PRI-1 (us)	PRI-2 (us)	PRI-3 (us)
1	1	12	50.1	1841.0	-	-
2	3	12	93.5	1590.0	1081.0	1413.0
3	2	12	68.8	1707.0	1577.0	-
4	1	12	56.3	1056.0	-	-
5	3	12	86.0	1953.0	1108.0	1987.0
6	2	12	75.2	1572.0	1536.0	-
7	1	12	54.4	1517.0	-	-
8	2	12	71.1	1329.0	1243.0	-
9	2	12	76.2	1940.0	1770.0	-
10	2	12	80.2	1098.0	1209.0	-
11	2	12	79.7	1588.0	1214.0	-
12	3	12	90.9	1615.0	1862.0	1601.0
13	2	12	68.7	1377.0	1441.0	-
14	2	12	67.4	1872.0	1313.0	-
15						
16						
17						
18						
19						
20						

Long Pulse Radar Test Signal

Test Signal Name: LP_Signal_25

Number of Bursts in Trial: 13

Chrip Center Frequency: 5524.55MHz

Burst	Pulses per Burst	Chrip (MHz)	Pulse Width(us)	PRI-1 (us)	PRI-2 (us)	PRI-3 (us)
1	3	11	94.0	1643.0	1748.0	1941.0
2	2	11	70.8	1177.0	1201.0	-
3	1	11	56.3	1006.0	-	-
4	3	11	96.7	1230.0	1163.0	1332.0
5	3	11	90.6	1217.0	1582.0	1498.0
6	2	11	74.5	1569.0	1281.0	-
7	3	11	92.6	1065.0	1669.0	1222.0
8	3	11	89.0	1493.0	1135.0	1380.0
9	3	11	96.5	1607.0	1822.0	1602.0
10	2	11	70.5	1141.0	1178.0	-
11	3	11	94.0	1009.0	1629.0	1956.0
12	1	11	55.8	1290.0	-	-
13	3	11	87.7	1435.0	1963.0	1164.0
14						
15						
16						
17						
18						
19						
20						

Long Pulse Radar Test Signal

Test Signal Name: LP_Signal_26

Number of Bursts in Trial: 8

Chrip Center Frequency: 5526.95MHz

Burst	Pulses per Burst	Chrip (MHz)	Pulse Width(us)	PRI-1 (us)	PRI-2 (us)	PRI-3 (us)
1	2	5	68.6	1306.0	1161.0	-
2	2	5	83.1	1420.0	1315.0	-
3	1	5	60.9	1687.0	-	-
4	2	5	77.7	1776.0	1158.0	-
5	2	5	77.4	1793.0	1510.0	-
6	2	5	66.8	1576.0	1323.0	-
7	1	5	63.7	1333.0	-	-
8	3	5	91.2	1409.0	1681.0	1275.0
9						
10						
11						
12						

Long Pulse Radar Test Signal

Test Signal Name: LP_Signal_27

Number of Bursts in Trial: 17

Chrip Center Frequency: 5522.55MHz

Burst	Pulses per Burst	Chrip (MHz)	Pulse Width(us)	PRI-1 (us)	PRI-2 (us)	PRI-3 (us)
1	3	16	83.6	1632.0	1195.0	1000.0
2	3	16	89.4	1173.0	1627.0	1656.0
3	1	16	55.8	1532.0	-	-
4	3	16	90.9	1981.0	1554.0	1998.0
5	1	16	54.7	1825.0	-	-
6	3	16	97.7	1734.0	1202.0	1250.0
7	2	16	67.5	1571.0	1434.0	-
8	3	16	96.7	1589.0	1469.0	1268.0
9	2	16	68.3	1750.0	1954.0	-
10	2	16	78.3	1591.0	1082.0	-
11	1	16	55.0	1427.0	-	-
12	3	16	84.9	1129.0	1936.0	1199.0
13	2	16	74.6	1959.0	1856.0	-
14	1	16	63.3	1885.0	-	-
15	3	16	99.8	1035.0	1515.0	1120.0
16	1	16	63.6	1647.0	-	-
17	3	16	87.3	1931.0	1051.0	1831.0
18						
19						
20						

Long Pulse Radar Test Signal

Test Signal Name: LP_Signal_28

Number of Bursts in Trial: 19

Chrip Center Frequency: 5521.35MHz

Burst	Pulses per Burst	Chrip (MHz)	Pulse Width(us)	PRI-1 (us)	PRI-2 (us)	PRI-3 (us)
1	3	19	85.6	1946.0	1078.0	1015.0
2	2	19	68.6	1029.0	1780.0	-
3	1	19	54.2	1111.0	-	-
4	1	19	61.2	1104.0	-	-
5	3	19	97.1	1157.0	1969.0	1100.0
6	3	19	98.3	1142.0	1699.0	1622.0
7	1	19	62.4	1655.0	-	-
8	2	19	80.2	1126.0	1769.0	-
9	3	19	87.5	1216.0	1448.0	1179.0
10	3	19	85.8	1847.0	1348.0	1472.0
11	3	19	88.1	1023.0	1124.0	1631.0
12	1	19	65.3	1848.0	-	-
13	1	19	52.5	1470.0	-	-
14	1	19	52.3	1312.0	-	-
15	2	19	74.1	1915.0	1200.0	-
16	1	19	54.9	1479.0	-	-
17	2	19	76.2	1376.0	1502.0	-
18	1	19	60.4	1758.0	-	-
19	2	19	81.5	1491.0	1103.0	-
20						

Long Pulse Radar Test Signal

Test Signal Name: LP_Signal_29

Number of Bursts in Trial: 12

Chrip Center Frequency: 5524.95MHz

Burst	Pulses per Burst	Chrip (MHz)	Pulse Width(us)	PRI-1 (us)	PRI-2 (us)	PRI-3 (us)
1	1	10	50.5	1857.0	-	-
2	1	10	55.7	1246.0	-	-
3	3	10	85.8	1774.0	1002.0	1967.0
4	2	10	76.9	1125.0	1474.0	-
5	2	10	75.1	1254.0	1052.0	-
6	3	10	92.3	1180.0	1486.0	1492.0
7	2	10	78.1	1301.0	1757.0	-
8	3	10	92.2	1898.0	1252.0	1713.0
9	3	10	89.0	1260.0	1706.0	1411.0
10	2	10	70.9	1578.0	1620.0	-
11	1	10	63.1	1782.0	-	-
12	1	10	55.3	1522.0	-	-
13						

Long Pulse Radar Test Signal

Test Signal Name: LP_Signal_30

Number of Bursts in Trial: 18

Chrip Center Frequency: 5522.15MHz

Burst	Pulses per Burst	Chrip (MHz)	Pulse Width(us)	PRI-1 (us)	PRI-2 (us)	PRI-3 (us)
1	3	17	83.4	1454.0	1205.0	1801.0
2	3	17	97.3	1319.0	1826.0	1635.0
3	3	17	90.4	1079.0	1986.0	1674.0
4	3	17	91.8	1563.0	1151.0	1802.0
5	3	17	98.2	1876.0	1977.0	1766.0
6	1	17	59.5	1952.0	-	-
7	2	17	80.0	1253.0	1137.0	-
8	3	17	86.5	1054.0	1128.0	1828.0
9	3	17	91.1	1105.0	1599.0	1442.0
10	3	17	93.5	1867.0	1373.0	1087.0
11	1	17	60.7	1033.0	-	-
12	2	17	67.2	1288.0	1405.0	-
13	1	17	61.8	1585.0	-	-
14	2	17	79.4	1933.0	1667.0	-
15	2	17	81.4	1096.0	1464.0	-
16	1	17	65.7	1496.0	-	-
17	2	17	76.0	1733.0	1255.0	-
18	2	17	81.0	1326.0	1668.0	-
19						

802.11be (EHT80)

Long Pulse Radar Test Signal

Test Signal Name: LP_Signal_01

Number of Bursts in Trial: 15

Chrip Center Frequency 5530.0MHz

Burst	Pulses per Burst	Chirp (MHz)	Pulse Width(us)	PRI-1 (us)	PRI-2 (us)	PRI-3 (us)
1	2	13	77.8	1665.0	1477.0	-
2	1	13	51.9	1074.0	-	-
3	1	13	63.8	1584.0	-	-
4	3	13	96.6	1682.0	1786.0	1843.0
5	3	13	85.9	1795.0	1215.0	1729.0
6	2	13	73.7	1198.0	1549.0	-
7	2	13	77.2	1837.0	1819.0	-
8	2	13	68.4	1587.0	1114.0	-
9	2	13	76.7	2000.0	1155.0	-
10	1	13	53.2	1147.0	-	-
11	3	13	85.7	1433.0	1695.0	1394.0
12	3	13	94.3	1670.0	1426.0	1935.0
13	2	13	77.6	1294.0	1671.0	-
14	1	13	65.7	1512.0	-	-
15	3	13	93.5	1444.0	1130.0	1468.0
16						
17						
18						
19						
20						

Long Pulse Radar Test Signal

Test Signal Name: LP_Signal_02

Number of Bursts in Trial: 8

Chrip Center Frequency: 5530.0MHz

Burst	Pulses per Burst	Chirp (MHz)	Pulse Width(us)	PRI-1 (us)	PRI-2 (us)	PRI-3 (us)
1	2	10	75.0	1880.0	1527.0	-
2	3	10	99.4	1401.0	1262.0	1257.0
3	2	10	67.4	1531.0	1403.0	-
4	2	10	73.6	1449.0	1041.0	-
5	1	10	65.9	1432.0	-	-
6	3	10	83.8	1356.0	1292.0	1419.0
7	1	10	65.5	1543.0	-	-
8	3	10	98.6	1548.0	1796.0	1728.0
9						
10						
11						
12						
13						
14						
15						
16						
17						
18						
19						
20						

Long Pulse Radar Test Signal

Test Signal Name: LP_Signal_03

Number of Bursts in Trial: 11

Chrip Center Frequency: 5530.0MHz

Burst	Pulses per Burst	Chrip (MHz)	Pulse Width(us)	PRI-1 (us)	PRI-2 (us)	PRI-3 (us)
1	2	16	73.8	1806.0	1538.0	-
2	2	16	69.5	1117.0	1649.0	-
3	1	16	51.9	1651.0	-	-
4	3	16	84.6	1976.0	1032.0	1271.0
5	3	16	95.4	1060.0	1903.0	1388.0
6	2	16	68.0	1368.0	1351.0	-
7	3	16	89.6	1338.0	1514.0	1573.0
8	2	16	81.9	1022.0	1689.0	-
9	3	16	88.3	1810.0	1330.0	1838.0
10	1	16	53.7	1597.0	-	-
11	3	16	91.3	1961.0	1106.0	1001.0
12						
13						
14						
15						
16						
17						
18						
19						
20						

Long Pulse Radar Test Signal

Test Signal Name: LP_Signal_04

Number of Bursts in Trial: 20

Chrip Center Frequency: 5530.0MHz

Burst	Pulses per Burst	Chrip (MHz)	Pulse Width(us)	PRI-1 (us)	PRI-2 (us)	PRI-3 (us)
1	2	13	68.1	1339.0	1355.0	-
2	1	13	58.7	1251.0	-	-
3	2	13	75.3	1136.0	1640.0	-
4	1	13	56.4	1753.0	-	-
5	3	13	99.7	1196.0	1708.0	1159.0
6	1	13	57.7	1013.0	-	-
7	1	13	59.5	1072.0	-	-
8	2	13	80.0	1482.0	1369.0	-
9	2	13	82.0	1993.0	1197.0	-
10	2	13	82.8	1883.0	1005.0	-
11	3	13	88.0	1061.0	1928.0	1101.0
12	3	13	93.2	1207.0	1907.0	1223.0
13	2	13	70.4	1526.0	1360.0	-
14	3	13	95.3	1171.0	1955.0	1775.0
15	2	13	81.9	1690.0	1545.0	-
16	3	13	98.5	1975.0	1169.0	1062.0
17	1	13	65.0	1767.0	-	-
18	3	13	85.4	1011.0	1637.0	1425.0
19	3	13	91.6	1878.0	1445.0	1325.0
20	2	13	67.3	1091.0	1218.0	-

Long Pulse Radar Test Signal

Test Signal Name: LP_Signal_05

Number of Bursts in Trial: 17

Chrip Center Frequency: 5530.0MHz

Burst	Pulses per Burst	Chrip (MHz)	Pulse Width(us)	PRI-1 (us)	PRI-2 (us)	PRI-3 (us)
1	2	10	67.9	1320.0	1133.0	-
2	1	10	62.3	1957.0	-	-
3	1	10	53.3	1592.0	-	-
4	3	10	90.0	1900.0	1153.0	1346.0
5	2	10	77.1	1166.0	1646.0	-
6	3	10	83.9	1278.0	1232.0	1459.0
7	3	10	89.1	1240.0	1384.0	1939.0
8	2	10	81.8	1833.0	1676.0	-
9	1	10	50.3	1075.0	-	-
10	3	10	87.1	1116.0	1996.0	1756.0
11	2	10	71.3	1225.0	1815.0	-
12	3	10	97.5	1884.0	1465.0	1132.0
13	3	10	90.6	1561.0	1040.0	1354.0
14	3	10	86.3	1596.0	1183.0	1792.0
15	3	10	97.6	1365.0	1073.0	1361.0
16	3	10	84.7	1021.0	1718.0	1854.0
17	3	10	99.7	1150.0	1244.0	1988.0
18						
19						
20						

Long Pulse Radar Test Signal

Test Signal Name: LP_Signal_06

Number of Bursts in Trial: 14

Chrip Center Frequency: 5530.0MHz

Burst	Pulses per Burst	Chrip (MHz)	Pulse Width(us)	PRI-1 (us)	PRI-2 (us)	PRI-3 (us)
1	3	6	92.9	1085.0	1564.0	1407.0
2	2	6	67.7	1744.0	1747.0	-
3	1	6	65.8	1092.0	-	-
4	1	6	56.3	1851.0	-	-
5	1	6	53.7	1727.0	-	-
6	3	6	83.5	1679.0	1930.0	1025.0
7	1	6	65.8	1519.0	-	-
8	3	6	85.9	1134.0	1034.0	1808.0
9	2	6	76.3	1606.0	1926.0	-
10	2	6	81.5	1891.0	1714.0	-
11	3	6	89.4	1310.0	1594.0	1827.0
12	1	6	63.4	1568.0	-	-
13	2	6	69.6	1307.0	1925.0	-
14	2	6	74.5	1264.0	1846.0	-
15						
16						
17						
18						
19						
20						

Long Pulse Radar Test Signal

Test Signal Name: LP_Signal_07

Number of Bursts in Trial: 15

Chrip Center Frequency: 5530.0MHz

Burst	Pulses per Burst	Chrip (MHz)	Pulse Width(us)	PRI-1 (us)	PRI-2 (us)	PRI-3 (us)
1	3	19	96.6	1182.0	1609.0	1581.0
2	3	19	96.7	1829.0	1799.0	1154.0
3	3	19	86.5	1923.0	1396.0	1865.0
4	2	19	73.3	1908.0	1318.0	-
5	1	19	55.8	1688.0	-	-
6	1	19	55.4	1145.0	-	-
7	3	19	85.3	1336.0	1504.0	1820.0
8	2	19	79.4	1344.0	1893.0	-
9	1	19	65.7	1476.0	-	-
10	2	19	68.6	1008.0	1028.0	-
11	2	19	77.7	1972.0	1835.0	-
12	2	19	79.6	1882.0	1331.0	-
13	3	19	94.9	1830.0	1070.0	1349.0
14	1	19	61.4	1451.0	-	-
15	3	19	90.6	1233.0	1562.0	1887.0
16						
17						
18						
19						
20						

Long Pulse Radar Test Signal
 Test Signal Name: LP_Signal_08
 Number of Bursts in Trial: 12
 Chrip Center Frequency: 5530.0MHz

Burst	Pulses per Burst	Chrip (MHz)	Pulse Width(us)	PRI-1 (us)	PRI-2 (us)	PRI-3 (us)
1	1	16	52.6	1210.0	-	-
2	3	16	84.1	1314.0	1725.0	1529.0
3	3	16	97.7	1139.0	1868.0	1805.0
4	3	16	97.3	1341.0	1446.0	1755.0
5	3	16	98.8	1544.0	1386.0	1302.0
6	2	16	72.2	1771.0	1184.0	-
7	2	16	67.6	1175.0	1027.0	-
8	2	16	75.7	1026.0	1871.0	-
9	1	16	60.9	1798.0	-	-
10	1	16	64.2	1138.0	-	-
11	2	16	78.8	1784.0	1604.0	-
12	3	16	87.5	1511.0	1712.0	1683.0
13						
14						
15						
16						
17						
18						
19						
20						

Long Pulse Radar Test Signal

Test Signal Name: LP_Signal_09

Number of Bursts in Trial: 14

Chrip Center Frequency: 5530.0MHz

Burst	Pulses per Burst	Chrip (MHz)	Pulse Width(us)	PRI-1 (us)	PRI-2 (us)	PRI-3 (us)
1	1	13	54.1	1415.0	-	-
2	1	13	50.7	1221.0	-	-
3	1	13	52.3	1974.0	-	-
4	3	13	99.8	1558.0	1696.0	1949.0
5	2	13	68.4	1014.0	1099.0	-
6	2	13	80.8	1736.0	1505.0	-
7	1	13	62.5	1778.0	-	-
8	2	13	74.8	1149.0	1204.0	-
9	1	13	50.8	1049.0	-	-
10	1	13	54.0	1417.0	-	-
11	1	13	63.0	1730.0	-	-
12	3	13	91.8	1143.0	1270.0	1347.0
13	2	13	79.3	1274.0	1992.0	-
14	1	13	64.3	1937.0	-	-
15						
16						
17						
18						
19						
20						

Long Pulse Radar Test Signal

Test Signal Name: LP_Signal_10

Number of Bursts in Trial: 8

Chirp Center Frequency: 5530.0MHz

Burst	Pulses per Burst	Chirp (MHz)	Pulse Width(us)	PRI-1 (us)	PRI-2 (us)	PRI-3 (us)
1	1	19	63.4	1043.0	-	-
2	1	19	52.0	1863.0	-	-
3	3	19	97.2	1973.0	1605.0	1583.0
4	2	19	78.7	1466.0	1743.0	-
5	2	19	74.2	1280.0	1219.0	-
6	3	19	88.7	1293.0	1934.0	1273.0
7	1	19	54.3	1991.0	-	-
8	3	19	95.4	1580.0	1555.0	1791.0
9						
10						
11						
12						
13						
14						
15						
16						
17						
18						
19						
20						

Long Pulse Radar Test Signal

Test Signal Name: LP_Signal_11

Number of Bursts in Trial: 17

Chrip Center Frequency: 5499.25MHz

Burst	Pulses per Burst	Chrip (MHz)	Pulse Width(us)	PRI-1 (us)	PRI-2 (us)	PRI-3 (us)
1	2	19	73.7	1208.0	1497.0	-
2	3	19	97.4	1942.0	1754.0	1613.0
3	3	19	91.7	1999.0	1702.0	1462.0
4	1	19	66.2	1393.0	-	-
5	2	19	70.8	1968.0	1821.0	-
6	1	19	52.3	1740.0	-	-
7	2	19	78.9	1308.0	1984.0	-
8	2	19	70.9	1050.0	1358.0	-
9	2	19	75.6	1437.0	1430.0	-
10	1	19	59.1	1697.0	-	-
11	2	19	77.0	1397.0	1304.0	-
12	2	19	67.9	1803.0	1083.0	-
13	2	19	81.2	1720.0	1932.0	-
14	2	19	78.7	1247.0	1121.0	-
15	1	19	63.3	1634.0	-	-
16	2	19	68.9	1849.0	1423.0	-
17	1	19	59.3	1093.0	-	-
18						
19						
20						

Long Pulse Radar Test Signal

Test Signal Name: LP_Signal_12

Number of Bursts in Trial: 19

Chrip Center Frequency: 5496.45MHz

Burst	Pulses per Burst	Chrip (MHz)	Pulse Width(us)	PRI-1 (us)	PRI-2 (us)	PRI-3 (us)
1	3	12	98.9	1381.0	1680.0	1488.0
2	2	12	82.3	1716.0	1855.0	-
3	3	12	86.7	1211.0	1400.0	1919.0
4	3	12	89.7	1861.0	1068.0	1282.0
5	3	12	98.6	1507.0	1194.0	1461.0
6	2	12	71.1	1921.0	1789.0	-
7	1	12	55.9	1947.0	-	-
8	2	12	67.9	1350.0	1372.0	-
9	3	12	84.4	1203.0	1107.0	1443.0
10	1	12	58.8	1715.0	-	-
11	1	12	65.6	1017.0	-	-
12	2	12	78.5	1911.0	1704.0	-
13	2	12	82.3	1845.0	1686.0	-
14	3	12	90.1	1938.0	1071.0	1266.0
15	3	12	90.2	1989.0	1089.0	1950.0
16	2	12	83.1	1943.0	1406.0	-
17	1	12	58.8	1742.0	-	-
18	2	12	77.0	1187.0	1657.0	-
19	1	12	55.0	1012.0	-	-
20						

Long Pulse Radar Test Signal

Test Signal Name: LP_Signal_13

Number of Bursts in Trial: 15

Chrip Center Frequency: 5498.85MHz

Burst	Pulses per Burst	Chrip (MHz)	Pulse Width(us)	PRI-1 (us)	PRI-2 (us)	PRI-3 (us)
1	1	18	58.1	1929.0	-	-
2	1	18	52.1	1910.0	-	-
3	1	18	59.9	1971.0	-	-
4	1	18	60.2	1812.0	-	-
5	3	18	95.9	1399.0	1906.0	1608.0
6	2	18	79.9	1626.0	1859.0	-
7	2	18	78.5	1238.0	1917.0	-
8	1	18	53.8	1763.0	-	-
9	1	18	64.7	1800.0	-	-
10	1	18	61.4	1390.0	-	-
11	2	18	83.2	1692.0	1858.0	-
12	3	18	84.7	1533.0	1677.0	1638.0
13	3	18	88.7	1703.0	1528.0	1058.0
14	2	18	78.3	1258.0	1951.0	-
15	2	18	69.3	1731.0	1717.0	-
16						
17						
18						
19						
20						

Long Pulse Radar Test Signal

Test Signal Name: LP_Signal_14

Number of Bursts in Trial: 12

Chrip Center Frequency: 5494.45MHz

Burst	Pulses per Burst	Chrip (MHz)	Pulse Width(us)	PRI-1 (us)	PRI-2 (us)	PRI-3 (us)
1	2	7	75.3	1994.0	1612.0	-
2	1	7	56.3	1456.0	-	-
3	2	7	67.7	1617.0	1185.0	-
4	1	7	55.6	1337.0	-	-
5	2	7	75.2	1421.0	1267.0	-
6	2	7	76.3	1359.0	1305.0	-
7	3	7	85.7	1547.0	1362.0	1924.0
8	3	7	98.4	1873.0	1550.0	1249.0
9	3	7	86.4	1779.0	1439.0	1046.0
10	3	7	93.6	1059.0	1031.0	1452.0
11	1	7	63.3	1328.0	-	-
12	3	7	92.4	1412.0	1673.0	1322.0
13						
14						
15						
16						
17						
18						
19						
20						

Long Pulse Radar Test Signal

Test Signal Name: LP_Signal_15

Number of Bursts in Trial: 19

Chrip Center Frequency: 5495.25MHz

Burst	Pulses per Burst	Chrip (MHz)	Pulse Width(us)	PRI-1 (us)	PRI-2 (us)	PRI-3 (us)
1	3	9	93.3	1983.0	1912.0	1535.0
2	2	9	69.1	1102.0	1794.0	-
3	3	9	86.9	1044.0	1152.0	1148.0
4	3	9	84.9	1894.0	1948.0	1118.0
5	2	9	72.3	1094.0	1916.0	-
6	1	9	51.7	1447.0	-	-
7	1	9	58.3	1429.0	-	-
8	1	9	60.8	1979.0	-	-
9	1	9	57.1	1641.0	-	-
10	3	9	88.9	1886.0	1964.0	1489.0
11	2	9	72.0	1909.0	1297.0	-
12	3	9	90.9	1261.0	1566.0	1370.0
13	1	9	59.8	1552.0	-	-
14	2	9	70.0	1759.0	1291.0	-
15	2	9	67.2	1625.0	1881.0	-
16	3	9	91.2	1382.0	1832.0	1661.0
17	1	9	56.5	1483.0	-	-
18	1	9	51.2	1237.0	-	-
19	2	9	74.1	1471.0	1245.0	-
20						

Long Pulse Radar Test Signal

Test Signal Name: LP_Signal_16

Number of Bursts in Trial: 14

Chrip Center Frequency: 5497.65MHz

Burst	Pulses per Burst	Chrip (MHz)	Pulse Width(us)	PRI-1 (us)	PRI-2 (us)	PRI-3 (us)
1	2	15	76.9	1110.0	1140.0	-
2	1	15	50.2	1316.0	-	-
3	1	15	62.9	1520.0	-	-
4	1	15	64.7	1902.0	-	-
5	3	15	83.8	1410.0	1097.0	1621.0
6	1	15	65.4	1944.0	-	-
7	1	15	53.2	1024.0	-	-
8	1	15	51.7	1603.0	-	-
9	2	15	78.7	1804.0	1168.0	-
10	2	15	72.4	1030.0	1343.0	-
11	1	15	53.8	1327.0	-	-
12	2	15	73.6	1524.0	1553.0	-
13	2	15	66.7	1722.0	1122.0	-
14	2	15	82.5	1404.0	1019.0	-
15						
16						
17						
18						
19						
20						

Long Pulse Radar Test Signal

Test Signal Name: LP_Signal_17

Number of Bursts in Trial: 20

Chrip Center Frequency: 5497.65MHz

Burst	Pulses per Burst	Chrip (MHz)	Pulse Width(us)	PRI-1 (us)	PRI-2 (us)	PRI-3 (us)
1	3	15	87.6	1565.0	1055.0	1840.0
2	3	15	85.2	1735.0	1541.0	1408.0
3	3	15	84.8	1534.0	1889.0	1463.0
4	2	15	77.9	1749.0	1460.0	-
5	2	15	76.5	1518.0	1485.0	-
6	1	15	60.9	1540.0	-	-
7	2	15	83.0	1080.0	1010.0	-
8	2	15	80.4	1824.0	1752.0	-
9	2	15	67.5	1764.0	1181.0	-
10	1	15	62.1	1495.0	-	-
11	3	15	86.4	1773.0	1966.0	1263.0
12	3	15	84.3	1593.0	1188.0	1788.0
13	2	15	76.9	1226.0	1537.0	-
14	3	15	95.8	1192.0	1298.0	1844.0
15	1	15	55.2	1644.0	-	-
16	1	15	59.0	1402.0	-	-
17	3	15	94.5	1296.0	1700.0	1283.0
18	3	15	91.9	1970.0	1978.0	1165.0
19	3	15	85.2	1732.0	1551.0	1189.0
20	2	15	69.5	1038.0	1224.0	-

Long Pulse Radar Test Signal

Test Signal Name: LP_Signal_18

Number of Bursts in Trial: 12

Chrip Center Frequency: 5497.25MHz

Burst	Pulses per Burst	Chrip (MHz)	Pulse Width(us)	PRI-1 (us)	PRI-2 (us)	PRI-3 (us)
1	3	14	86.4	1259.0	1918.0	1455.0
2	3	14	92.2	1598.0	1719.0	1895.0
3	2	14	80.4	1816.0	1899.0	-
4	1	14	54.3	1335.0	-	-
5	1	14	53.1	1303.0	-	-
6	2	14	69.4	1503.0	1546.0	-
7	2	14	69.1	1279.0	1639.0	-
8	3	14	100.0	1375.0	1438.0	1595.0
9	2	14	79.6	1239.0	1705.0	-
10	3	14	88.4	1374.0	1579.0	1623.0
11	1	14	53.3	1016.0	-	-
12	1	14	65.3	1709.0	-	-
13						
14						
15						
16						
17						
18						
19						
20						

Long Pulse Radar Test Signal

Test Signal Name: LP_Signal_19

Number of Bursts in Trial: 14

Chrip Center Frequency: 5499.25MHz

Burst	Pulses per Burst	Chrip (MHz)	Pulse Width(us)	PRI-1 (us)	PRI-2 (us)	PRI-3 (us)
1	1	19	55.3	1920.0	-	-
2	1	19	58.3	1797.0	-	-
3	2	19	72.3	1610.0	1039.0	-
4	3	19	84.8	1131.0	1761.0	1721.0
5	2	19	82.5	1875.0	1431.0	-
6	1	19	63.3	1095.0	-	-
7	2	19	80.0	1119.0	1913.0	-
8	3	19	90.3	1660.0	1853.0	1123.0
9	3	19	91.1	1539.0	1783.0	1172.0
10	3	19	96.6	1525.0	1036.0	1385.0
11	2	19	82.7	1710.0	1990.0	-
12	1	19	50.7	1234.0	-	-
13	2	19	78.4	1047.0	1109.0	-
14	3	19	99.5	1299.0	1965.0	1869.0
15						
16						
17						
18						
19						
20						

Long Pulse Radar Test Signal
 Test Signal Name: LP_Signal_20
 Number of Bursts in Trial: 12
 Chrip Center Frequency: 5498.45MHz

Burst	Pulses per Burst	Chrip (MHz)	Pulse Width(us)	PRI-1 (us)	PRI-2 (us)	PRI-3 (us)
1	3	17	88.6	1501.0	1067.0	1927.0
2	1	17	57.4	1723.0	-	-
3	3	17	96.6	1086.0	1658.0	1324.0
4	2	17	69.7	1751.0	1945.0	-
5	2	17	77.9	1642.0	1317.0	-
6	1	17	62.0	1866.0	-	-
7	3	17	88.4	1997.0	1077.0	1366.0
8	3	17	97.3	1790.0	1896.0	1367.0
9	3	17	96.2	1391.0	1787.0	1672.0
10	3	17	95.4	1020.0	1892.0	1414.0
11	1	17	54.8	1084.0	-	-
12	2	17	80.4	1850.0	1436.0	-
13						
14						
15						
16						
17						
18						
19						
20						

Long Pulse Radar Test Signal

Test Signal Name: LP_Signal_21

Number of Bursts in Trial: 16

Chrip Center Frequency: 5566.45MHz

Burst	Pulses per Burst	Chrip (MHz)	Pulse Width(us)	PRI-1 (us)	PRI-2 (us)	PRI-3 (us)
1	2	17	74.7	1619.0	1611.0	-
2	1	5	57.1	1560.0	-	-
3	3	5	91.9	1392.0	1475.0	1276.0
4	2	5	83.1	1809.0	1772.0	-
5	1	5	50.7	1003.0	-	-
6	2	5	79.2	1574.0	1600.0	-
7	1	5	58.7	1186.0	-	-
8	2	5	71.0	1521.0	1567.0	-
9	2	5	79.0	1777.0	1960.0	-
10	2	5	68.5	1284.0	1428.0	-
11	2	5	73.5	1904.0	1352.0	-
12	2	5	70.5	1864.0	1115.0	-
13	2	5	76.6	1045.0	1300.0	-
14	2	5	81.2	1160.0	1675.0	-
15	1	5	61.8	1277.0	-	-
16	3	5	94.9	1450.0	1206.0	1860.0
17						
18						
19						
20						

Long Pulse Radar Test Signal

Test Signal Name: LP_Signal_22

Number of Bursts in Trial: 12

Chrip Center Frequency: 5566.45MHz

Burst	Pulses per Burst	Chrip (MHz)	Pulse Width(us)	PRI-1 (us)	PRI-2 (us)	PRI-3 (us)
1	2	5	78.5	1653.0	1698.0	-
2	3	5	89.8	1174.0	1962.0	1167.0
3	1	5	59.4	1982.0	-	-
4	2	5	79.6	1633.0	1890.0	-
5	2	5	76.0	1112.0	1811.0	-
6	1	5	53.6	1144.0	-	-
7	2	5	80.9	1220.0	1053.0	-
8	1	5	61.6	1724.0	-	-
9	1	5	53.4	1901.0	-	-
10	1	5	59.9	1379.0	-	-
11	1	5	60.4	1453.0	-	-
12	3	5	91.4	1768.0	1726.0	1227.0
13						
14						
15						
16						
17						
18						
19						
20						

Long Pulse Radar Test Signal

Test Signal Name: LP_Signal_23

Number of Bursts in Trial: 20

Chrip Center Frequency: 5563.25MHz

Burst	Pulses per Burst	Chrip (MHz)	Pulse Width(us)	PRI-1 (us)	PRI-2 (us)	PRI-3 (us)
1	2	13	77.0	1191.0	1363.0	-
2	1	13	58.1	1248.0	-	-
3	1	13	62.1	1836.0	-	-
4	2	13	76.9	1334.0	1236.0	-
5	2	13	80.0	1914.0	1852.0	-
6	1	13	52.0	1701.0	-	-
7	3	13	88.6	1693.0	1995.0	1905.0
8	2	13	72.9	1922.0	1387.0	-
9	3	13	98.5	1839.0	1746.0	1389.0
10	1	13	57.9	1193.0	-	-
11	3	13	95.9	1659.0	1870.0	1066.0
12	1	13	53.5	1162.0	-	-
13	3	13	92.0	1745.0	1654.0	1458.0
14	1	13	57.3	1834.0	-	-
15	2	13	70.5	1684.0	1586.0	-
16	2	13	70.0	1042.0	1664.0	-
17	3	13	84.0	1765.0	1630.0	1176.0
18	2	13	76.1	1557.0	1057.0	-
19	3	13	93.2	1985.0	1018.0	1340.0
20	3	13	96.8	1760.0	1614.0	1817.0

Long Pulse Radar Test Signal

Test Signal Name: LP_Signal_24

Number of Bursts in Trial: 14

Chrip Center Frequency: 5565.65MHz

Burst	Pulses per Burst	Chrip (MHz)	Pulse Width(us)	PRI-1 (us)	PRI-2 (us)	PRI-3 (us)
1	1	7	50.1	1841.0	-	-
2	3	7	93.5	1590.0	1081.0	1413.0
3	2	7	68.8	1707.0	1577.0	-
4	1	7	56.3	1056.0	-	-
5	3	7	86.0	1953.0	1108.0	1987.0
6	2	7	75.2	1572.0	1536.0	-
7	1	7	54.4	1517.0	-	-
8	2	7	71.1	1329.0	1243.0	-
9	2	7	76.2	1940.0	1770.0	-
10	2	7	80.2	1098.0	1209.0	-
11	2	7	79.7	1588.0	1214.0	-
12	3	7	90.9	1615.0	1862.0	1601.0
13	2	7	68.7	1377.0	1441.0	-
14	2	7	67.4	1872.0	1313.0	-
15						
16						
17						
18						
19						
20						

Long Pulse Radar Test Signal

Test Signal Name: LP_Signal_25

Number of Bursts in Trial: 13

Chrip Center Frequency: 5562.85MHz

Burst	Pulses per Burst	Chrip (MHz)	Pulse Width(us)	PRI-1 (us)	PRI-2 (us)	PRI-3 (us)
1	3	14	94.0	1643.0	1748.0	1941.0
2	2	14	70.8	1177.0	1201.0	-
3	1	14	56.3	1006.0	-	-
4	3	14	96.7	1230.0	1163.0	1332.0
5	3	14	90.6	1217.0	1582.0	1498.0
6	2	14	74.5	1569.0	1281.0	-
7	3	14	92.6	1065.0	1669.0	1222.0
8	3	14	89.0	1493.0	1135.0	1380.0
9	3	14	96.5	1607.0	1822.0	1602.0
10	2	14	70.5	1141.0	1178.0	-
11	3	14	94.0	1009.0	1629.0	1956.0
12	1	14	55.8	1290.0	-	-
13	3	14	87.7	1435.0	1963.0	1164.0
14						
15						
16						
17						
18						
19						
20						

Long Pulse Radar Test Signal

Test Signal Name: LP_Signal_26

Number of Bursts in Trial: 8

Chrip Center Frequency: 5564.45MHz

Burst	Pulses per Burst	Chrip (MHz)	Pulse Width(us)	PRI-1 (us)	PRI-2 (us)	PRI-3 (us)
1	2	10	68.6	1306.0	1161.0	-
2	2	10	83.1	1420.0	1315.0	-
3	1	10	60.9	1687.0	-	-
4	2	10	77.7	1776.0	1158.0	-
5	2	10	77.4	1793.0	1510.0	-
6	2	10	66.8	1576.0	1323.0	-
7	1	10	63.7	1333.0	-	-
8	3	10	91.2	1409.0	1681.0	1275.0
9						
10						
11						
12						
13						
14						
15						
16						
17						
18						
19						
20						

Long Pulse Radar Test Signal

Test Signal Name: LP_Signal_27

Number of Bursts in Trial: 17

Chrip Center Frequency: 5562.45MHz

Burst	Pulses per Burst	Chrip (MHz)	Pulse Width(us)	PRI-1 (us)	PRI-2 (us)	PRI-3 (us)
1	3	15	83.6	1632.0	1195.0	1000.0
2	3	15	89.4	1173.0	1627.0	1656.0
3	1	15	55.8	1532.0	-	-
4	3	15	90.9	1981.0	1554.0	1998.0
5	1	15	54.7	1825.0	-	-
6	3	15	97.7	1734.0	1202.0	1250.0
7	2	15	67.5	1571.0	1434.0	-
8	3	15	96.7	1589.0	1469.0	1268.0
9	2	15	68.3	1750.0	1954.0	-
10	2	15	78.3	1591.0	1082.0	-
11	1	15	55.0	1427.0	-	-
12	3	15	84.9	1129.0	1936.0	1199.0
13	2	15	74.6	1959.0	1856.0	-
14	1	15	63.3	1885.0	-	-
15	3	15	99.8	1035.0	1515.0	1120.0
16	1	15	63.6	1647.0	-	-
17	3	15	87.3	1931.0	1051.0	1831.0
18						
19						
20						

Long Pulse Radar Test Signal

Test Signal Name: LP_Signal_28

Number of Bursts in Trial: 19

Chrip Center Frequency: 5564.85MHz

Burst	Pulses per Burst	Chrip (MHz)	Pulse Width(us)	PRI-1 (us)	PRI-2 (us)	PRI-3 (us)
1	3	9	85.6	1946.0	1078.0	1015.0
2	2	9	68.6	1029.0	1780.0	-
3	1	9	54.2	1111.0	-	-
4	1	9	61.2	1104.0	-	-
5	3	9	97.1	1157.0	1969.0	1100.0
6	3	9	98.3	1142.0	1699.0	1622.0
7	1	9	62.4	1655.0	-	-
8	2	9	80.2	1126.0	1769.0	-
9	3	9	87.5	1216.0	1448.0	1179.0
10	3	9	85.8	1847.0	1348.0	1472.0
11	3	9	88.1	1023.0	1124.0	1631.0
12	1	9	65.3	1848.0	-	-
13	1	9	52.5	1470.0	-	-
14	1	9	52.3	1312.0	-	-
15	2	9	74.1	1915.0	1200.0	-
16	1	9	54.9	1479.0	-	-
17	2	9	76.2	1376.0	1502.0	-
18	1	9	60.4	1758.0	-	-
19	2	9	81.5	1491.0	1103.0	-
20						

Long Pulse Radar Test Signal

Test Signal Name: LP_Signal_29

Number of Bursts in Trial: 12

Chrip Center Frequency: 5566.45MHz

Burst	Pulses per Burst	Chrip (MHz)	Pulse Width(us)	PRI-1 (us)	PRI-2 (us)	PRI-3 (us)
1	1	5	50.5	1857.0	-	-
2	1	5	55.7	1246.0	-	-
3	3	5	85.8	1774.0	1002.0	1967.0
4	2	5	76.9	1125.0	1474.0	-
5	2	5	75.1	1254.0	1052.0	-
6	3	5	92.3	1180.0	1486.0	1492.0
7	2	5	78.1	1301.0	1757.0	-
8	3	5	92.2	1898.0	1252.0	1713.0
9	3	5	89.0	1260.0	1706.0	1411.0
10	2	5	70.9	1578.0	1620.0	-
11	1	5	63.1	1782.0	-	-
12	1	5	55.3	1522.0	-	-
13						
14						
15						
16						
17						
18						
19						

Long Pulse Radar Test Signal

Test Signal Name: LP_Signal_30

Number of Bursts in Trial: 18

Chrip Center Frequency: 5564.45MHz

Burst	Pulses per Burst	Chrip (MHz)	Pulse Width(us)	PRI-1 (us)	PRI-2 (us)	PRI-3 (us)
1	3	10	83.4	1454.0	1205.0	1801.0
2	3	10	97.3	1319.0	1826.0	1635.0
3	3	10	90.4	1079.0	1986.0	1674.0
4	3	10	91.8	1563.0	1151.0	1802.0
5	3	10	98.2	1876.0	1977.0	1766.0
6	1	10	59.5	1952.0	-	-
7	2	10	80.0	1253.0	1137.0	-
8	3	10	86.5	1054.0	1128.0	1828.0
9	3	10	91.1	1105.0	1599.0	1442.0
10	3	10	93.5	1867.0	1373.0	1087.0
11	1	10	60.7	1033.0	-	-
12	2	10	67.2	1288.0	1405.0	-
13	1	10	61.8	1585.0	-	-
14	2	10	79.4	1933.0	1667.0	-
15	2	10	81.4	1096.0	1464.0	-
16	1	10	65.7	1496.0	-	-
17	2	10	76.0	1733.0	1255.0	-
18	2	10	81.0	1326.0	1668.0	-

802.11be (EHT160)_5250MHz

Long Pulse Radar Test Signal

Test Signal Name: LP_Signal_01

Number of Bursts in Trial: 15

Chrip Center Frequency 5290.0MHz

Burst	Pulses per Burst	Chirp (MHz)	Pulse Width(us)	PRI-1 (us)	PRI-2 (us)	PRI-3 (us)
1	2	16	77.8	1665.0	1477.0	-
2	1	16	51.9	1074.0	-	-
3	1	16	63.8	1584.0	-	-
4	3	16	96.6	1682.0	1786.0	1843.0
5	3	16	85.9	1795.0	1215.0	1729.0
6	2	16	73.7	1198.0	1549.0	-
7	2	16	77.2	1837.0	1819.0	-
8	2	16	68.4	1587.0	1114.0	-
9	2	16	76.7	2000.0	1155.0	-
10	1	16	53.2	1147.0	-	-
11	3	16	85.7	1433.0	1695.0	1394.0
12	3	16	94.3	1670.0	1426.0	1935.0
13	2	16	77.6	1294.0	1671.0	-
14	1	16	65.7	1512.0	-	-
15	3	16	93.5	1444.0	1130.0	1468.0
16						
17						
18						
19						
20						

Long Pulse Radar Test Signal

Test Signal Name: LP_Signal_02

Number of Bursts in Trial: 8

Chrip Center Frequency: 5290.0MHz

Burst	Pulses per Burst	Chirp (MHz)	Pulse Width(us)	PRI-1 (us)	PRI-2 (us)	PRI-3 (us)
1	2	9	75.0	1880.0	1527.0	-
2	3	9	99.4	1401.0	1262.0	1257.0
3	2	9	67.4	1531.0	1403.0	-
4	2	9	73.6	1449.0	1041.0	-
5	1	9	65.9	1432.0	-	-
6	3	9	83.8	1356.0	1292.0	1419.0
7	1	9	65.5	1543.0	-	-
8	3	9	98.6	1548.0	1796.0	1728.0
9						
10						
11						
12						
13						
14						
15						
16						
17						
18						
19						
20						

Long Pulse Radar Test Signal

Test Signal Name: LP_Signal_03

Number of Bursts in Trial: 11

Chrip Center Frequency: 5290.0MHz

Burst	Pulses per Burst	Chrip (MHz)	Pulse Width(us)	PRI-1 (us)	PRI-2 (us)	PRI-3 (us)
1	2	16	73.8	1806.0	1538.0	-
2	2	16	69.5	1117.0	1649.0	-
3	1	16	51.9	1651.0	-	-
4	3	16	84.6	1976.0	1032.0	1271.0
5	3	16	95.4	1060.0	1903.0	1388.0
6	2	16	68.0	1368.0	1351.0	-
7	3	16	89.6	1338.0	1514.0	1573.0
8	2	16	81.9	1022.0	1689.0	-
9	3	16	88.3	1810.0	1330.0	1838.0
10	1	16	53.7	1597.0	-	-
11	3	16	91.3	1961.0	1106.0	1001.0
12						
13						
14						
15						
16						
17						
18						
19						
20						

Long Pulse Radar Test Signal

Test Signal Name: LP_Signal_04

Number of Bursts in Trial: 20

Chrip Center Frequency: 5290.0MHz

Burst	Pulses per Burst	Chrip (MHz)	Pulse Width(us)	PRI-1 (us)	PRI-2 (us)	PRI-3 (us)
1	2	13	68.1	1339.0	1355.0	-
2	1	13	58.7	1251.0	-	-
3	2	13	75.3	1136.0	1640.0	-
4	1	13	56.4	1753.0	-	-
5	3	13	99.7	1196.0	1708.0	1159.0
6	1	13	57.7	1013.0	-	-
7	1	13	59.5	1072.0	-	-
8	2	13	80.0	1482.0	1369.0	-
9	2	13	82.0	1993.0	1197.0	-
10	2	13	82.8	1883.0	1005.0	-
11	3	13	88.0	1061.0	1928.0	1101.0
12	3	13	93.2	1207.0	1907.0	1223.0
13	2	13	70.4	1526.0	1360.0	-
14	3	13	95.3	1171.0	1955.0	1775.0
15	2	13	81.9	1690.0	1545.0	-
16	3	13	98.5	1975.0	1169.0	1062.0
17	1	13	65.0	1767.0	-	-
18	3	13	85.4	1011.0	1637.0	1425.0
19	3	13	91.6	1878.0	1445.0	1325.0
20	2	13	67.3	1091.0	1218.0	-

Long Pulse Radar Test Signal

Test Signal Name: LP_Signal_05

Number of Bursts in Trial: 17

Chrip Center Frequency: 5290.0MHz

Burst	Pulses per Burst	Chrip (MHz)	Pulse Width(us)	PRI-1 (us)	PRI-2 (us)	PRI-3 (us)
1	2	13	67.9	1320.0	1133.0	-
2	1	13	62.3	1957.0	-	-
3	1	13	53.3	1592.0	-	-
4	3	13	90.0	1900.0	1153.0	1346.0
5	2	13	77.1	1166.0	1646.0	-
6	3	13	83.9	1278.0	1232.0	1459.0
7	3	13	89.1	1240.0	1384.0	1939.0
8	2	13	81.8	1833.0	1676.0	-
9	1	13	50.3	1075.0	-	-
10	3	13	87.1	1116.0	1996.0	1756.0
11	2	13	71.3	1225.0	1815.0	-
12	3	13	97.5	1884.0	1465.0	1132.0
13	3	13	90.6	1561.0	1040.0	1354.0
14	3	13	86.3	1596.0	1183.0	1792.0
15	3	13	97.6	1365.0	1073.0	1361.0
16	3	13	84.7	1021.0	1718.0	1854.0
17	3	13	99.7	1150.0	1244.0	1988.0
18						
19						
20						

Long Pulse Radar Test Signal

Test Signal Name: LP_Signal_06

Number of Bursts in Trial: 14

Chrip Center Frequency: 5290.0MHz

Burst	Pulses per Burst	Chrip (MHz)	Pulse Width(us)	PRI-1 (us)	PRI-2 (us)	PRI-3 (us)
1	3	12	92.9	1085.0	1564.0	1407.0
2	2	12	67.7	1744.0	1747.0	-
3	1	12	65.8	1092.0	-	-
4	1	12	56.3	1851.0	-	-
5	1	12	53.7	1727.0	-	-
6	3	12	83.5	1679.0	1930.0	1025.0
7	1	12	65.8	1519.0	-	-
8	3	12	85.9	1134.0	1034.0	1808.0
9	2	12	76.3	1606.0	1926.0	-
10	2	12	81.5	1891.0	1714.0	-
11	3	12	89.4	1310.0	1594.0	1827.0
12	1	12	63.4	1568.0	-	-
13	2	12	69.6	1307.0	1925.0	-
14	2	12	74.5	1264.0	1846.0	-
15						
16						
17						
18						
19						
20						

Long Pulse Radar Test Signal

Test Signal Name: LP_Signal_07

Number of Bursts in Trial: 15

Chrip Center Frequency: 5290.0MHz

Burst	Pulses per Burst	Chrip (MHz)	Pulse Width(us)	PRI-1 (us)	PRI-2 (us)	PRI-3 (us)
1	3	14	96.6	1182.0	1609.0	1581.0
2	3	14	96.7	1829.0	1799.0	1154.0
3	3	14	86.5	1923.0	1396.0	1865.0
4	2	14	73.3	1908.0	1318.0	-
5	1	14	55.8	1688.0	-	-
6	1	14	55.4	1145.0	-	-
7	3	14	85.3	1336.0	1504.0	1820.0
8	2	14	79.4	1344.0	1893.0	-
9	1	14	65.7	1476.0	-	-
10	2	14	68.6	1008.0	1028.0	-
11	2	14	77.7	1972.0	1835.0	-
12	2	14	79.6	1882.0	1331.0	-
13	3	14	94.9	1830.0	1070.0	1349.0
14	1	14	61.4	1451.0	-	-
15	3	14	90.6	1233.0	1562.0	1887.0
16						
17						
18						
19						
20						

Long Pulse Radar Test Signal

Test Signal Name: LP_Signal_08

Number of Bursts in Trial: 12

Chrip Center Frequency: 5290.0MHz

Burst	Pulses per Burst	Chrip (MHz)	Pulse Width(us)	PRI-1 (us)	PRI-2 (us)	PRI-3 (us)
1	1	15	52.6	1210.0	-	-
2	3	15	84.1	1314.0	1725.0	1529.0
3	3	15	97.7	1139.0	1868.0	1805.0
4	3	15	97.3	1341.0	1446.0	1755.0
5	3	15	98.8	1544.0	1386.0	1302.0
6	2	15	72.2	1771.0	1184.0	-
7	2	15	67.6	1175.0	1027.0	-
8	2	15	75.7	1026.0	1871.0	-
9	1	15	60.9	1798.0	-	-
10	1	15	64.2	1138.0	-	-
11	2	15	78.8	1784.0	1604.0	-
12	3	15	87.5	1511.0	1712.0	1683.0
13						
14						
15						
16						
17						
18						
19						
20						

Long Pulse Radar Test Signal

Test Signal Name: LP_Signal_09

Number of Bursts in Trial: 14

Chrip Center Frequency: 5290.0MHz

Burst	Pulses per Burst	Chrip (MHz)	Pulse Width(us)	PRI-1 (us)	PRI-2 (us)	PRI-3 (us)
1	1	12	54.1	1415.0	-	-
2	1	12	50.7	1221.0	-	-
3	1	12	52.3	1974.0	-	-
4	3	12	99.8	1558.0	1696.0	1949.0
5	2	12	68.4	1014.0	1099.0	-
6	2	12	80.8	1736.0	1505.0	-
7	1	12	62.5	1778.0	-	-
8	2	12	74.8	1149.0	1204.0	-
9	1	12	50.8	1049.0	-	-
10	1	12	54.0	1417.0	-	-
11	1	12	63.0	1730.0	-	-
12	3	12	91.8	1143.0	1270.0	1347.0
13	2	12	79.3	1274.0	1992.0	-
14	1	12	64.3	1937.0	-	-
15						
16						
17						
18						
19						
20						

Long Pulse Radar Test Signal

Test Signal Name: LP_Signal_10

Number of Bursts in Trial: 8

Chirp Center Frequency: 5290.0MHz

Burst	Pulses per Burst	Chirp (MHz)	Pulse Width(us)	PRI-1 (us)	PRI-2 (us)	PRI-3 (us)
1	1	13	63.4	1043.0	-	-
2	1	13	52.0	1863.0	-	-
3	3	13	97.2	1973.0	1605.0	1583.0
4	2	13	78.7	1466.0	1743.0	-
5	2	13	74.2	1280.0	1219.0	-
6	3	13	88.7	1293.0	1934.0	1273.0
7	1	13	54.3	1991.0	-	-
8	3	13	95.4	1580.0	1555.0	1791.0
9						
10						
11						
12						
13						
14						
15						
16						
17						
18						
19						
20						

Long Pulse Radar Test Signal

Test Signal Name: LP_Signal_11

Number of Bursts in Trial: 17

Chirp Center Frequency: 5258MHz

Burst	Pulses per Burst	Chirp (MHz)	Pulse Width(us)	PRI-1 (us)	PRI-2 (us)	PRI-3 (us)
1	2	20	73.7	1208.0	1497.0	-
2	3	20	97.4	1942.0	1754.0	1613.0
3	3	20	91.7	1999.0	1702.0	1462.0
4	1	20	66.2	1393.0	-	-
5	2	20	70.8	1968.0	1821.0	-
6	1	20	52.3	1740.0	-	-
7	2	20	78.9	1308.0	1984.0	-
8	2	20	70.9	1050.0	1358.0	-
9	2	20	75.6	1437.0	1430.0	-
10	1	20	59.1	1697.0	-	-
11	2	20	77.0	1397.0	1304.0	-
12	2	20	67.9	1803.0	1083.0	-
13	2	20	81.2	1720.0	1932.0	-
14	2	20	78.7	1247.0	1121.0	-
15	1	20	63.3	1634.0	-	-
16	2	20	68.9	1849.0	1423.0	-
17	1	20	59.3	1093.0	-	-
18						
19						
20						

Long Pulse Radar Test Signal

Test Signal Name: LP_Signal_12

Number of Bursts in Trial: 19

Chrip Center Frequency: 5252.4MHz

Burst	Pulses per Burst	Chrip (MHz)	Pulse Width(us)	PRI-1 (us)	PRI-2 (us)	PRI-3 (us)
1	3	6	98.9	1381.0	1680.0	1488.0
2	2	6	82.3	1716.0	1855.0	-
3	3	6	86.7	1211.0	1400.0	1919.0
4	3	6	89.7	1861.0	1068.0	1282.0
5	3	6	98.6	1507.0	1194.0	1461.0
6	2	6	71.1	1921.0	1789.0	-
7	1	6	55.9	1947.0	-	-
8	2	6	67.9	1350.0	1372.0	-
9	3	6	84.4	1203.0	1107.0	1443.0
10	1	6	58.8	1715.0	-	-
11	1	6	65.6	1017.0	-	-
12	2	6	78.5	1911.0	1704.0	-
13	2	6	82.3	1845.0	1686.0	-
14	3	6	90.1	1938.0	1071.0	1266.0
15	3	6	90.2	1989.0	1089.0	1950.0
16	2	6	83.1	1943.0	1406.0	-
17	1	6	58.8	1742.0	-	-
18	2	6	77.0	1187.0	1657.0	-
19	1	6	55.0	1012.0	-	-
20						

Long Pulse Radar Test Signal

Test Signal Name: LP_Signal_13

Number of Bursts in Trial: 15

Chirp Center Frequency: 5257.2MHz

Burst	Pulses per Burst	Chirp (MHz)	Pulse Width(us)	PRI-1 (us)	PRI-2 (us)	PRI-3 (us)
1	1	18	58.1	1929.0	-	-
2	1	18	52.1	1910.0	-	-
3	1	18	59.9	1971.0	-	-
4	1	18	60.2	1812.0	-	-
5	3	18	95.9	1399.0	1906.0	1608.0
6	2	18	79.9	1626.0	1859.0	-
7	2	18	78.5	1238.0	1917.0	-
8	1	18	53.8	1763.0	-	-
9	1	18	64.7	1800.0	-	-
10	1	18	61.4	1390.0	-	-
11	2	18	83.2	1692.0	1858.0	-
12	3	18	84.7	1533.0	1677.0	1638.0
13	3	18	88.7	1703.0	1528.0	1058.0
14	2	18	78.3	1258.0	1951.0	-
15	2	18	69.3	1731.0	1717.0	-
16						
17						
18						
19						
20						

Long Pulse Radar Test Signal

Test Signal Name: LP_Signal_14

Number of Bursts in Trial: 12

Chrip Center Frequency: 5256.8MHz

Burst	Pulses per Burst	Chrip (MHz)	Pulse Width(us)	PRI-1 (us)	PRI-2 (us)	PRI-3 (us)
1	2	17	75.3	1994.0	1612.0	-
2	1	17	56.3	1456.0	-	-
3	2	17	67.7	1617.0	1185.0	-
4	1	17	55.6	1337.0	-	-
5	2	17	75.2	1421.0	1267.0	-
6	2	17	76.3	1359.0	1305.0	-
7	3	17	85.7	1547.0	1362.0	1924.0
8	3	17	98.4	1873.0	1550.0	1249.0
9	3	17	86.4	1779.0	1439.0	1046.0
10	3	17	93.6	1059.0	1031.0	1452.0
11	1	17	63.3	1328.0	-	-
12	3	17	92.4	1412.0	1673.0	1322.0
13						
14						
15						
16						
17						
18						
19						
20						

Long Pulse Radar Test Signal

Test Signal Name: LP_Signal_15

Number of Bursts in Trial: 19

Chrip Center Frequency: 5252.8MHz

Burst	Pulses per Burst	Chrip (MHz)	Pulse Width(us)	PRI-1 (us)	PRI-2 (us)	PRI-3 (us)
1	3	7	93.3	1983.0	1912.0	1535.0
2	2	7	69.1	1102.0	1794.0	-
3	3	7	86.9	1044.0	1152.0	1148.0
4	3	7	84.9	1894.0	1948.0	1118.0
5	2	7	72.3	1094.0	1916.0	-
6	1	7	51.7	1447.0	-	-
7	1	7	58.3	1429.0	-	-
8	1	7	60.8	1979.0	-	-
9	1	7	57.1	1641.0	-	-
10	3	7	88.9	1886.0	1964.0	1489.0
11	2	7	72.0	1909.0	1297.0	-
12	3	7	90.9	1261.0	1566.0	1370.0
13	1	7	59.8	1552.0	-	-
14	2	7	70.0	1759.0	1291.0	-
15	2	7	67.2	1625.0	1881.0	-
16	3	7	91.2	1382.0	1832.0	1661.0
17	1	7	56.5	1483.0	-	-
18	1	7	51.2	1237.0	-	-
19	2	7	74.1	1471.0	1245.0	-
20						

Long Pulse Radar Test Signal

Test Signal Name: LP_Signal_16

Number of Bursts in Trial: 14

Chrip Center Frequency: 5257.2MHz

Burst	Pulses per Burst	Chrip (MHz)	Pulse Width(us)	PRI-1 (us)	PRI-2 (us)	PRI-3 (us)
1	2	18	76.9	1110.0	1140.0	-
2	1	18	50.2	1316.0	-	-
3	1	18	62.9	1520.0	-	-
4	1	18	64.7	1902.0	-	-
5	3	18	83.8	1410.0	1097.0	1621.0
6	1	18	65.4	1944.0	-	-
7	1	18	53.2	1024.0	-	-
8	1	18	51.7	1603.0	-	-
9	2	18	78.7	1804.0	1168.0	-
10	2	18	72.4	1030.0	1343.0	-
11	1	18	53.8	1327.0	-	-
12	2	18	73.6	1524.0	1553.0	-
13	2	18	66.7	1722.0	1122.0	-
14	2	18	82.5	1404.0	1019.0	-
15						
16						
17						
18						
19						
20						

Long Pulse Radar Test Signal

Test Signal Name: LP_Signal_17

Number of Bursts in Trial: 20

Chrip Center Frequency: 5255.6MHz

Burst	Pulses per Burst	Chrip (MHz)	Pulse Width(us)	PRI-1 (us)	PRI-2 (us)	PRI-3 (us)
1	3	14	87.6	1565.0	1055.0	1840.0
2	3	14	85.2	1735.0	1541.0	1408.0
3	3	14	84.8	1534.0	1889.0	1463.0
4	2	14	77.9	1749.0	1460.0	-
5	2	14	76.5	1518.0	1485.0	-
6	1	14	60.9	1540.0	-	-
7	2	14	83.0	1080.0	1010.0	-
8	2	14	80.4	1824.0	1752.0	-
9	2	14	67.5	1764.0	1181.0	-
10	1	14	62.1	1495.0	-	-
11	3	14	86.4	1773.0	1966.0	1263.0
12	3	14	84.3	1593.0	1188.0	1788.0
13	2	14	76.9	1226.0	1537.0	-
14	3	14	95.8	1192.0	1298.0	1844.0
15	1	14	55.2	1644.0	-	-
16	1	14	59.0	1402.0	-	-
17	3	14	94.5	1296.0	1700.0	1283.0
18	3	14	91.9	1970.0	1978.0	1165.0
19	3	14	85.2	1732.0	1551.0	1189.0
20	2	14	69.5	1038.0	1224.0	-

Long Pulse Radar Test Signal

Test Signal Name: LP_Signal_18

Number of Bursts in Trial: 12

Chrip Center Frequency: 5256.4MHz

Burst	Pulses per Burst	Chrip (MHz)	Pulse Width(us)	PRI-1 (us)	PRI-2 (us)	PRI-3 (us)
1	3	16	86.4	1259.0	1918.0	1455.0
2	3	16	92.2	1598.0	1719.0	1895.0
3	2	16	80.4	1816.0	1899.0	-
4	1	16	54.3	1335.0	-	-
5	1	16	53.1	1303.0	-	-
6	2	16	69.4	1503.0	1546.0	-
7	2	16	69.1	1279.0	1639.0	-
8	3	16	100.0	1375.0	1438.0	1595.0
9	2	16	79.6	1239.0	1705.0	-
10	3	16	88.4	1374.0	1579.0	1623.0
11	1	16	53.3	1016.0	-	-
12	1	16	65.3	1709.0	-	-
13						
14						
15						
16						
17						
18						
19						
20						

Long Pulse Radar Test Signal

Test Signal Name: LP_Signal_19

Number of Bursts in Trial: 14

Chrip Center Frequency: 5254.8MHz

Burst	Pulses per Burst	Chrip (MHz)	Pulse Width(us)	PRI-1 (us)	PRI-2 (us)	PRI-3 (us)
1	1	12	55.3	1920.0	-	-
2	1	12	58.3	1797.0	-	-
3	2	12	72.3	1610.0	1039.0	-
4	3	12	84.8	1131.0	1761.0	1721.0
5	2	12	82.5	1875.0	1431.0	-
6	1	12	63.3	1095.0	-	-
7	2	12	80.0	1119.0	1913.0	-
8	3	12	90.3	1660.0	1853.0	1123.0
9	3	12	91.1	1539.0	1783.0	1172.0
10	3	12	96.6	1525.0	1036.0	1385.0
11	2	12	82.7	1710.0	1990.0	-
12	1	12	50.7	1234.0	-	-
13	2	12	78.4	1047.0	1109.0	-
14	3	12	99.5	1299.0	1965.0	1869.0
15						
16						
17						
18						
19						
20						

Long Pulse Radar Test Signal
 Test Signal Name: LP_Signal_20
 Number of Bursts in Trial: 12
 Chrip Center Frequency: 5257.6MHz

Burst	Pulses per Burst	Chrip (MHz)	Pulse Width(us)	PRI-1 (us)	PRI-2 (us)	PRI-3 (us)
1	3	19	88.6	1501.0	1067.0	1927.0
2	1	19	57.4	1723.0	-	-
3	3	19	96.6	1086.0	1658.0	1324.0
4	2	19	69.7	1751.0	1945.0	-
5	2	19	77.9	1642.0	1317.0	-
6	1	19	62.0	1866.0	-	-
7	3	19	88.4	1997.0	1077.0	1366.0
8	3	19	97.3	1790.0	1896.0	1367.0
9	3	19	96.2	1391.0	1787.0	1672.0
10	3	19	95.4	1020.0	1892.0	1414.0
11	1	19	54.8	1084.0	-	-
12	2	19	80.4	1850.0	1436.0	-
13						
14						
15						
16						
17						
18						
19						
20						

Long Pulse Radar Test Signal

Test Signal Name: LP_Signal_21

Number of Bursts in Trial: 16

Chrip Center Frequency: 5322.02MHz

Burst	Pulses per Burst	Chrip (MHz)	Pulse Width(us)	PRI-1 (us)	PRI-2 (us)	PRI-3 (us)
1	2	13	74.7	1619.0	1611.0	-
2	1	13	57.1	1560.0	-	-
3	3	13	91.9	1392.0	1475.0	1276.0
4	2	13	83.1	1809.0	1772.0	-
5	1	13	50.7	1003.0	-	-
6	2	13	79.2	1574.0	1600.0	-
7	1	13	58.7	1186.0	-	-
8	2	13	71.0	1521.0	1567.0	-
9	2	13	79.0	1777.0	1960.0	-
10	2	13	68.5	1284.0	1428.0	-
11	2	13	73.5	1904.0	1352.0	-
12	2	13	70.5	1864.0	1115.0	-
13	2	13	76.6	1045.0	1300.0	-
14	2	13	81.2	1160.0	1675.0	-
15	1	13	61.8	1277.0	-	-
16	3	13	94.9	1450.0	1206.0	1860.0
17						
18						
19						
20						

Long Pulse Radar Test Signal

Test Signal Name: LP_Signal_22

Number of Bursts in Trial: 12

Chrip Center Frequency: 5324.82MHz

Burst	Pulses per Burst	Chrip (MHz)	Pulse Width(us)	PRI-1 (us)	PRI-2 (us)	PRI-3 (us)
1	2	6	78.5	1653.0	1698.0	-
2	3	6	89.8	1174.0	1962.0	1167.0
3	1	6	59.4	1982.0	-	-
4	2	6	79.6	1633.0	1890.0	-
5	2	6	76.0	1112.0	1811.0	-
6	1	6	53.6	1144.0	-	-
7	2	6	80.9	1220.0	1053.0	-
8	1	6	61.6	1724.0	-	-
9	1	6	53.4	1901.0	-	-
10	1	6	59.9	1379.0	-	-
11	1	6	60.4	1453.0	-	-
12	3	6	91.4	1768.0	1726.0	1227.0
13						
14						
15						
16						
17						
18						
19						
20						

Long Pulse Radar Test Signal

Test Signal Name: LP_Signal_23

Number of Bursts in Trial: 20

Chrip Center Frequency: 5320.42MHz

Burst	Pulses per Burst	Chrip (MHz)	Pulse Width(us)	PRI-1 (us)	PRI-2 (us)	PRI-3 (us)
1	2	17	77.0	1191.0	1363.0	-
2	1	17	58.1	1248.0	-	-
3	1	17	62.1	1836.0	-	-
4	2	17	76.9	1334.0	1236.0	-
5	2	17	80.0	1914.0	1852.0	-
6	1	17	52.0	1701.0	-	-
7	3	17	88.6	1693.0	1995.0	1905.0
8	2	17	72.9	1922.0	1387.0	-
9	3	17	98.5	1839.0	1746.0	1389.0
10	1	17	57.9	1193.0	-	-
11	3	17	95.9	1659.0	1870.0	1066.0
12	1	17	53.5	1162.0	-	-
13	3	17	92.0	1745.0	1654.0	1458.0
14	1	17	57.3	1834.0	-	-
15	2	17	70.5	1684.0	1586.0	-
16	2	17	70.0	1042.0	1664.0	-
17	3	17	84.0	1765.0	1630.0	1176.0
18	2	17	76.1	1557.0	1057.0	-
19	3	17	93.2	1985.0	1018.0	1340.0
20	3	17	96.8	1760.0	1614.0	1817.0

Long Pulse Radar Test Signal

Test Signal Name: LP_Signal_24

Number of Bursts in Trial: 14

Chrip Center Frequency: 5324.42MHz

Burst	Pulses per Burst	Chrip (MHz)	Pulse Width(us)	PRI-1 (us)	PRI-2 (us)	PRI-3 (us)
1	1	7	50.1	1841.0	-	-
2	3	7	93.5	1590.0	1081.0	1413.0
3	2	7	68.8	1707.0	1577.0	-
4	1	7	56.3	1056.0	-	-
5	3	7	86.0	1953.0	1108.0	1987.0
6	2	7	75.2	1572.0	1536.0	-
7	1	7	54.4	1517.0	-	-
8	2	7	71.1	1329.0	1243.0	-
9	2	7	76.2	1940.0	1770.0	-
10	2	7	80.2	1098.0	1209.0	-
11	2	7	79.7	1588.0	1214.0	-
12	3	7	90.9	1615.0	1862.0	1601.0
13	2	7	68.7	1377.0	1441.0	-
14	2	7	67.4	1872.0	1313.0	-
15						
16						
17						
18						
19						
20						

Long Pulse Radar Test Signal

Test Signal Name: LP_Signal_25

Number of Bursts in Trial: 13

Chrip Center Frequency: 5323.62MHz

Burst	Pulses per Burst	Chrip (MHz)	Pulse Width(us)	PRI-1 (us)	PRI-2 (us)	PRI-3 (us)
1	3	9	94.0	1643.0	1748.0	1941.0
2	2	9	70.8	1177.0	1201.0	-
3	1	9	56.3	1006.0	-	-
4	3	9	96.7	1230.0	1163.0	1332.0
5	3	9	90.6	1217.0	1582.0	1498.0
6	2	9	74.5	1569.0	1281.0	-
7	3	9	92.6	1065.0	1669.0	1222.0
8	3	9	89.0	1493.0	1135.0	1380.0
9	3	9	96.5	1607.0	1822.0	1602.0
10	2	9	70.5	1141.0	1178.0	-
11	3	9	94.0	1009.0	1629.0	1956.0
12	1	9	55.8	1290.0	-	-
13	3	9	87.7	1435.0	1963.0	1164.0
14						
15						
16						
17						
18						
19						
20						

Long Pulse Radar Test Signal

Test Signal Name: LP_Signal_26

Number of Bursts in Trial: 8

Chrip Center Frequency: 5322.82MHz

Burst	Pulses per Burst	Chrip (MHz)	Pulse Width(us)	PRI-1 (us)	PRI-2 (us)	PRI-3 (us)
1	2	11	68.6	1306.0	1161.0	-
2	2	11	83.1	1420.0	1315.0	-
3	1	11	60.9	1687.0	-	-
4	2	11	77.7	1776.0	1158.0	-
5	2	11	77.4	1793.0	1510.0	-
6	2	11	66.8	1576.0	1323.0	-
7	1	11	63.7	1333.0	-	-
8	3	11	91.2	1409.0	1681.0	1275.0
9						
10						
11						
12						
13						
14						
15						
16						
17						
18						
19						
20						

Long Pulse Radar Test Signal

Test Signal Name: LP_Signal_27

Number of Bursts in Trial: 17

Chrip Center Frequency: 5320.02MHz

Burst	Pulses per Burst	Chrip (MHz)	Pulse Width(us)	PRI-1 (us)	PRI-2 (us)	PRI-3 (us)
1	3	18	83.6	1632.0	1195.0	1000.0
2	3	18	89.4	1173.0	1627.0	1656.0
3	1	18	55.8	1532.0	-	-
4	3	18	90.9	1981.0	1554.0	1998.0
5	1	18	54.7	1825.0	-	-
6	3	18	97.7	1734.0	1202.0	1250.0
7	2	18	67.5	1571.0	1434.0	-
8	3	18	96.7	1589.0	1469.0	1268.0
9	2	18	68.3	1750.0	1954.0	-
10	2	18	78.3	1591.0	1082.0	-
11	1	18	55.0	1427.0	-	-
12	3	18	84.9	1129.0	1936.0	1199.0
13	2	18	74.6	1959.0	1856.0	-
14	1	18	63.3	1885.0	-	-
15	3	18	99.8	1035.0	1515.0	1120.0
16	1	18	63.6	1647.0	-	-
17	3	18	87.3	1931.0	1051.0	1831.0
18						
19						
20						

Long Pulse Radar Test Signal

Test Signal Name: LP_Signal_28

Number of Bursts in Trial: 19

Chrip Center Frequency: 5323.62MHz

Burst	Pulses per Burst	Chrip (MHz)	Pulse Width(us)	PRI-1 (us)	PRI-2 (us)	PRI-3 (us)
1	3	9	85.6	1946.0	1078.0	1015.0
2	2	9	68.6	1029.0	1780.0	-
3	1	9	54.2	1111.0	-	-
4	1	9	61.2	1104.0	-	-
5	3	9	97.1	1157.0	1969.0	1100.0
6	3	9	98.3	1142.0	1699.0	1622.0
7	1	9	62.4	1655.0	-	-
8	2	9	80.2	1126.0	1769.0	-
9	3	9	87.5	1216.0	1448.0	1179.0
10	3	9	85.8	1847.0	1348.0	1472.0
11	3	9	88.1	1023.0	1124.0	1631.0
12	1	9	65.3	1848.0	-	-
13	1	9	52.5	1470.0	-	-
14	1	9	52.3	1312.0	-	-
15	2	9	74.1	1915.0	1200.0	-
16	1	9	54.9	1479.0	-	-
17	2	9	76.2	1376.0	1502.0	-
18	1	9	60.4	1758.0	-	-
19	2	9	81.5	1491.0	1103.0	-
20						

Long Pulse Radar Test Signal

Test Signal Name: LP_Signal_29

Number of Bursts in Trial: 12

Chrip Center Frequency: 5324.82MHz

Burst	Pulses per Burst	Chrip (MHz)	Pulse Width(us)	PRI-1 (us)	PRI-2 (us)	PRI-3 (us)
1	1	6	50.5	1857.0	-	-
2	1	6	55.7	1246.0	-	-
3	3	6	85.8	1774.0	1002.0	1967.0
4	2	6	76.9	1125.0	1474.0	-
5	2	6	75.1	1254.0	1052.0	-
6	3	6	92.3	1180.0	1486.0	1492.0
7	2	6	78.1	1301.0	1757.0	-
8	3	6	92.2	1898.0	1252.0	1713.0
9	3	6	89.0	1260.0	1706.0	1411.0
10	2	6	70.9	1578.0	1620.0	-
11	1	6	63.1	1782.0	-	-
12	1	6	55.3	1522.0	-	-
13						
14						
15						
16						
17						
18						
19						

Long Pulse Radar Test Signal

Test Signal Name: LP_Signal_30

Number of Bursts in Trial: 18

Chrip Center Frequency: 5319.22MHz

Burst	Pulses per Burst	Chrip (MHz)	Pulse Width(us)	PRI-1 (us)	PRI-2 (us)	PRI-3 (us)
1	3	20	83.4	1454.0	1205.0	1801.0
2	3	20	97.3	1319.0	1826.0	1635.0
3	3	20	90.4	1079.0	1986.0	1674.0
4	3	20	91.8	1563.0	1151.0	1802.0
5	3	20	98.2	1876.0	1977.0	1766.0
6	1	20	59.5	1952.0	-	-
7	2	20	80.0	1253.0	1137.0	-
8	3	20	86.5	1054.0	1128.0	1828.0
9	3	20	91.1	1105.0	1599.0	1442.0
10	3	20	93.5	1867.0	1373.0	1087.0
11	1	20	60.7	1033.0	-	-
12	2	20	67.2	1288.0	1405.0	-
13	1	20	61.8	1585.0	-	-
14	2	20	79.4	1933.0	1667.0	-
15	2	20	81.4	1096.0	1464.0	-
16	1	20	65.7	1496.0	-	-
17	2	20	76.0	1733.0	1255.0	-
18	2	20	81.0	1326.0	1668.0	-

802.11be (EHT160)_5570MHz

Long Pulse Radar Test Signal

Test Signal Name: LP_Signal_01

Number of Bursts in Trial: 15

Chrip Center Frequency 5530.0MHz

Burst	Pulses per Burst	Chirp (MHz)	Pulse Width(us)	PRI-1 (us)	PRI-2 (us)	PRI-3 (us)
1	2	19	77.8	1665.0	1477.0	-
2	1	19	51.9	1074.0	-	-
3	1	19	63.8	1584.0	-	-
4	3	19	96.6	1682.0	1786.0	1843.0
5	3	19	85.9	1795.0	1215.0	1729.0
6	2	19	73.7	1198.0	1549.0	-
7	2	19	77.2	1837.0	1819.0	-
8	2	19	68.4	1587.0	1114.0	-
9	2	19	76.7	2000.0	1155.0	-
10	1	19	53.2	1147.0	-	-
11	3	19	85.7	1433.0	1695.0	1394.0
12	3	19	94.3	1670.0	1426.0	1935.0
13	2	19	77.6	1294.0	1671.0	-
14	1	19	65.7	1512.0	-	-
15	3	19	93.5	1444.0	1130.0	1468.0
16						
17						
18						
19						
20						

Long Pulse Radar Test Signal

Test Signal Name: LP_Signal_02

Number of Bursts in Trial: 8

Chrip Center Frequency: 5530.0MHz

Burst	Pulses per Burst	Chirp (MHz)	Pulse Width(us)	PRI-1 (us)	PRI-2 (us)	PRI-3 (us)
1	2	17	75.0	1880.0	1527.0	-
2	3	17	99.4	1401.0	1262.0	1257.0
3	2	17	67.4	1531.0	1403.0	-
4	2	17	73.6	1449.0	1041.0	-
5	1	17	65.9	1432.0	-	-
6	3	17	83.8	1356.0	1292.0	1419.0
7	1	17	65.5	1543.0	-	-
8	3	17	98.6	1548.0	1796.0	1728.0
9						
10						
11						
12						
13						
14						
15						
16						
17						
18						
19						
20						

Long Pulse Radar Test Signal

Test Signal Name: LP_Signal_03

Number of Bursts in Trial: 11

Chrip Center Frequency: 5530.0MHz

Burst	Pulses per Burst	Chrip (MHz)	Pulse Width(us)	PRI-1 (us)	PRI-2 (us)	PRI-3 (us)
1	2	12	73.8	1806.0	1538.0	-
2	2	12	69.5	1117.0	1649.0	-
3	1	12	51.9	1651.0	-	-
4	3	12	84.6	1976.0	1032.0	1271.0
5	3	12	95.4	1060.0	1903.0	1388.0
6	2	12	68.0	1368.0	1351.0	-
7	3	12	89.6	1338.0	1514.0	1573.0
8	2	12	81.9	1022.0	1689.0	-
9	3	12	88.3	1810.0	1330.0	1838.0
10	1	12	53.7	1597.0	-	-
11	3	12	91.3	1961.0	1106.0	1001.0
12						
13						
14						
15						
16						
17						
18						
19						
20						

Long Pulse Radar Test Signal

Test Signal Name: LP_Signal_04

Number of Bursts in Trial: 20

Chrip Center Frequency: 5530.0MHz

Burst	Pulses per Burst	Chrip (MHz)	Pulse Width(us)	PRI-1 (us)	PRI-2 (us)	PRI-3 (us)
1	2	19	68.1	1339.0	1355.0	-
2	1	19	58.7	1251.0	-	-
3	2	19	75.3	1136.0	1640.0	-
4	1	19	56.4	1753.0	-	-
5	3	19	99.7	1196.0	1708.0	1159.0
6	1	19	57.7	1013.0	-	-
7	1	19	59.5	1072.0	-	-
8	2	19	80.0	1482.0	1369.0	-
9	2	19	82.0	1993.0	1197.0	-
10	2	19	82.8	1883.0	1005.0	-
11	3	19	88.0	1061.0	1928.0	1101.0
12	3	19	93.2	1207.0	1907.0	1223.0
13	2	19	70.4	1526.0	1360.0	-
14	3	19	95.3	1171.0	1955.0	1775.0
15	2	19	81.9	1690.0	1545.0	-
16	3	19	98.5	1975.0	1169.0	1062.0
17	1	19	65.0	1767.0	-	-
18	3	19	85.4	1011.0	1637.0	1425.0
19	3	19	91.6	1878.0	1445.0	1325.0
20	2	19	67.3	1091.0	1218.0	-

Long Pulse Radar Test Signal

Test Signal Name: LP_Signal_05

Number of Bursts in Trial: 17

Chrip Center Frequency: 5530.0MHz

Burst	Pulses per Burst	Chrip (MHz)	Pulse Width(us)	PRI-1 (us)	PRI-2 (us)	PRI-3 (us)
1	2	8	67.9	1320.0	1133.0	-
2	1	8	62.3	1957.0	-	-
3	1	8	53.3	1592.0	-	-
4	3	8	90.0	1900.0	1153.0	1346.0
5	2	8	77.1	1166.0	1646.0	-
6	3	8	83.9	1278.0	1232.0	1459.0
7	3	8	89.1	1240.0	1384.0	1939.0
8	2	8	81.8	1833.0	1676.0	-
9	1	8	50.3	1075.0	-	-
10	3	8	87.1	1116.0	1996.0	1756.0
11	2	8	71.3	1225.0	1815.0	-
12	3	8	97.5	1884.0	1465.0	1132.0
13	3	8	90.6	1561.0	1040.0	1354.0
14	3	8	86.3	1596.0	1183.0	1792.0
15	3	8	97.6	1365.0	1073.0	1361.0
16	3	8	84.7	1021.0	1718.0	1854.0
17	3	8	99.7	1150.0	1244.0	1988.0
18						
19						
20						

Long Pulse Radar Test Signal

Test Signal Name: LP_Signal_06

Number of Bursts in Trial: 14

Chrip Center Frequency: 5530.0MHz

Burst	Pulses per Burst	Chrip (MHz)	Pulse Width(us)	PRI-1 (us)	PRI-2 (us)	PRI-3 (us)
1	3	20	92.9	1085.0	1564.0	1407.0
2	2	20	67.7	1744.0	1747.0	-
3	1	20	65.8	1092.0	-	-
4	1	20	56.3	1851.0	-	-
5	1	20	53.7	1727.0	-	-
6	3	20	83.5	1679.0	1930.0	1025.0
7	1	20	65.8	1519.0	-	-
8	3	20	85.9	1134.0	1034.0	1808.0
9	2	20	76.3	1606.0	1926.0	-
10	2	20	81.5	1891.0	1714.0	-
11	3	20	89.4	1310.0	1594.0	1827.0
12	1	20	63.4	1568.0	-	-
13	2	20	69.6	1307.0	1925.0	-
14	2	20	74.5	1264.0	1846.0	-
15						
16						
17						
18						
19						
20						

Long Pulse Radar Test Signal

Test Signal Name: LP_Signal_07

Number of Bursts in Trial: 15

Chrip Center Frequency: 5530.0MHz

Burst	Pulses per Burst	Chrip (MHz)	Pulse Width(us)	PRI-1 (us)	PRI-2 (us)	PRI-3 (us)
1	3	9	96.6	1182.0	1609.0	1581.0
2	3	9	96.7	1829.0	1799.0	1154.0
3	3	9	86.5	1923.0	1396.0	1865.0
4	2	9	73.3	1908.0	1318.0	-
5	1	9	55.8	1688.0	-	-
6	1	9	55.4	1145.0	-	-
7	3	9	85.3	1336.0	1504.0	1820.0
8	2	9	79.4	1344.0	1893.0	-
9	1	9	65.7	1476.0	-	-
10	2	9	68.6	1008.0	1028.0	-
11	2	9	77.7	1972.0	1835.0	-
12	2	9	79.6	1882.0	1331.0	-
13	3	9	94.9	1830.0	1070.0	1349.0
14	1	9	61.4	1451.0	-	-
15	3	9	90.6	1233.0	1562.0	1887.0
16						
17						
18						
19						
20						

Long Pulse Radar Test Signal

Test Signal Name: LP_Signal_08

Number of Bursts in Trial: 12

Chrip Center Frequency: 5530.0MHz

Burst	Pulses per Burst	Chrip (MHz)	Pulse Width(us)	PRI-1 (us)	PRI-2 (us)	PRI-3 (us)
1	1	19	52.6	1210.0	-	-
2	3	19	84.1	1314.0	1725.0	1529.0
3	3	19	97.7	1139.0	1868.0	1805.0
4	3	19	97.3	1341.0	1446.0	1755.0
5	3	19	98.8	1544.0	1386.0	1302.0
6	2	19	72.2	1771.0	1184.0	-
7	2	19	67.6	1175.0	1027.0	-
8	2	19	75.7	1026.0	1871.0	-
9	1	19	60.9	1798.0	-	-
10	1	19	64.2	1138.0	-	-
11	2	19	78.8	1784.0	1604.0	-
12	3	19	87.5	1511.0	1712.0	1683.0
13						
14						
15						
16						
17						
18						
19						
20						

Long Pulse Radar Test Signal

Test Signal Name: LP_Signal_09

Number of Bursts in Trial: 14

Chirp Center Frequency: 5530.0MHz

Burst	Pulses per Burst	Chirp (MHz)	Pulse Width(us)	PRI-1 (us)	PRI-2 (us)	PRI-3 (us)
1	1	14	54.1	1415.0	-	-
2	1	14	50.7	1221.0	-	-
3	1	14	52.3	1974.0	-	-
4	3	14	99.8	1558.0	1696.0	1949.0
5	2	14	68.4	1014.0	1099.0	-
6	2	14	80.8	1736.0	1505.0	-
7	1	14	62.5	1778.0	-	-
8	2	14	74.8	1149.0	1204.0	-
9	1	14	50.8	1049.0	-	-
10	1	14	54.0	1417.0	-	-
11	1	14	63.0	1730.0	-	-
12	3	14	91.8	1143.0	1270.0	1347.0
13	2	14	79.3	1274.0	1992.0	-
14	1	14	64.3	1937.0	-	-
15						
16						
17						
18						
19						
20						

Long Pulse Radar Test Signal

Test Signal Name: LP_Signal_10

Number of Bursts in Trial: 8

Chirp Center Frequency: 5530.0MHz

Burst	Pulses per Burst	Chirp (MHz)	Pulse Width(us)	PRI-1 (us)	PRI-2 (us)	PRI-3 (us)
1	1	13	63.4	1043.0	-	-
2	1	13	52.0	1863.0	-	-
3	3	13	97.2	1973.0	1605.0	1583.0
4	2	13	78.7	1466.0	1743.0	-
5	2	13	74.2	1280.0	1219.0	-
6	3	13	88.7	1293.0	1934.0	1273.0
7	1	13	54.3	1991.0	-	-
8	3	13	95.4	1580.0	1555.0	1791.0
9						
10						
11						
12						
13						
14						
15						
16						
17						
18						
19						
20						

Long Pulse Radar Test Signal

Test Signal Name: LP_Signal_11

Number of Bursts in Trial: 17

Chrip Center Frequency: 5498.52MHz

Burst	Pulses per Burst	Chrip (MHz)	Pulse Width(us)	PRI-1 (us)	PRI-2 (us)	PRI-3 (us)
1	2	17	73.7	1208.0	1497.0	-
2	3	17	97.4	1942.0	1754.0	1613.0
3	3	17	91.7	1999.0	1702.0	1462.0
4	1	17	66.2	1393.0	-	-
5	2	17	70.8	1968.0	1821.0	-
6	1	17	52.3	1740.0	-	-
7	2	17	78.9	1308.0	1984.0	-
8	2	17	70.9	1050.0	1358.0	-
9	2	17	75.6	1437.0	1430.0	-
10	1	17	59.1	1697.0	-	-
11	2	17	77.0	1397.0	1304.0	-
12	2	17	67.9	1803.0	1083.0	-
13	2	17	81.2	1720.0	1932.0	-
14	2	17	78.7	1247.0	1121.0	-
15	1	17	63.3	1634.0	-	-
16	2	17	68.9	1849.0	1423.0	-
17	1	17	59.3	1093.0	-	-
18						
19						
20						

Long Pulse Radar Test Signal

Test Signal Name: LP_Signal_12

Number of Bursts in Trial: 19

Chrip Center Frequency: 5499.72MHz

Burst	Pulses per Burst	Chrip (MHz)	Pulse Width(us)	PRI-1 (us)	PRI-2 (us)	PRI-3 (us)
1	3	20	98.9	1381.0	1680.0	1488.0
2	2	20	82.3	1716.0	1855.0	-
3	3	20	86.7	1211.0	1400.0	1919.0
4	3	20	89.7	1861.0	1068.0	1282.0
5	3	20	98.6	1507.0	1194.0	1461.0
6	2	20	71.1	1921.0	1789.0	-
7	1	20	55.9	1947.0	-	-
8	2	20	67.9	1350.0	1372.0	-
9	3	20	84.4	1203.0	1107.0	1443.0
10	1	20	58.8	1715.0	-	-
11	1	20	65.6	1017.0	-	-
12	2	20	78.5	1911.0	1704.0	-
13	2	20	82.3	1845.0	1686.0	-
14	3	20	90.1	1938.0	1071.0	1266.0
15	3	20	90.2	1989.0	1089.0	1950.0
16	2	20	83.1	1943.0	1406.0	-
17	1	20	58.8	1742.0	-	-
18	2	20	77.0	1187.0	1657.0	-
19	1	20	55.0	1012.0	-	-
20						

Long Pulse Radar Test Signal

Test Signal Name: LP_Signal_13

Number of Bursts in Trial: 15

Chrip Center Frequency: 5497.32MHz

Burst	Pulses per Burst	Chrip (MHz)	Pulse Width(us)	PRI-1 (us)	PRI-2 (us)	PRI-3 (us)
1	1	14	58.1	1929.0	-	-
2	1	14	52.1	1910.0	-	-
3	1	14	59.9	1971.0	-	-
4	1	14	60.2	1812.0	-	-
5	3	14	95.9	1399.0	1906.0	1608.0
6	2	14	79.9	1626.0	1859.0	-
7	2	14	78.5	1238.0	1917.0	-
8	1	14	53.8	1763.0	-	-
9	1	14	64.7	1800.0	-	-
10	1	14	61.4	1390.0	-	-
11	2	14	83.2	1692.0	1858.0	-
12	3	14	84.7	1533.0	1677.0	1638.0
13	3	14	88.7	1703.0	1528.0	1058.0
14	2	14	78.3	1258.0	1951.0	-
15	2	14	69.3	1731.0	1717.0	-
16						
17						
18						
19						
20						

Long Pulse Radar Test Signal

Test Signal Name: LP_Signal_14

Number of Bursts in Trial: 12

Chrip Center Frequency: 5496.12MHz

Burst	Pulses per Burst	Chrip (MHz)	Pulse Width(us)	PRI-1 (us)	PRI-2 (us)	PRI-3 (us)
1	2	11	75.3	1994.0	1612.0	-
2	1	11	56.3	1456.0	-	-
3	2	11	67.7	1617.0	1185.0	-
4	1	11	55.6	1337.0	-	-
5	2	11	75.2	1421.0	1267.0	-
6	2	11	76.3	1359.0	1305.0	-
7	3	11	85.7	1547.0	1362.0	1924.0
8	3	11	98.4	1873.0	1550.0	1249.0
9	3	11	86.4	1779.0	1439.0	1046.0
10	3	11	93.6	1059.0	1031.0	1452.0
11	1	11	63.3	1328.0	-	-
12	3	11	92.4	1412.0	1673.0	1322.0
13						
14						
15						
16						
17						
18						
19						
20						

Long Pulse Radar Test Signal

Test Signal Name: LP_Signal_15

Number of Bursts in Trial: 19

Chrip Center Frequency: 5499.32MHz

Burst	Pulses per Burst	Chrip (MHz)	Pulse Width(us)	PRI-1 (us)	PRI-2 (us)	PRI-3 (us)
1	3	19	93.3	1983.0	1912.0	1535.0
2	2	19	69.1	1102.0	1794.0	-
3	3	19	86.9	1044.0	1152.0	1148.0
4	3	19	84.9	1894.0	1948.0	1118.0
5	2	19	72.3	1094.0	1916.0	-
6	1	19	51.7	1447.0	-	-
7	1	19	58.3	1429.0	-	-
8	1	19	60.8	1979.0	-	-
9	1	19	57.1	1641.0	-	-
10	3	19	88.9	1886.0	1964.0	1489.0
11	2	19	72.0	1909.0	1297.0	-
12	3	19	90.9	1261.0	1566.0	1370.0
13	1	19	59.8	1552.0	-	-
14	2	19	70.0	1759.0	1291.0	-
15	2	19	67.2	1625.0	1881.0	-
16	3	19	91.2	1382.0	1832.0	1661.0
17	1	19	56.5	1483.0	-	-
18	1	19	51.2	1237.0	-	-
19	2	19	74.1	1471.0	1245.0	-
20						

Long Pulse Radar Test Signal

Test Signal Name: LP_Signal_16

Number of Bursts in Trial: 14

Chrip Center Frequency: 5496.92MHz

Burst	Pulses per Burst	Chrip (MHz)	Pulse Width(us)	PRI-1 (us)	PRI-2 (us)	PRI-3 (us)
1	2	13	76.9	1110.0	1140.0	-
2	1	13	50.2	1316.0	-	-
3	1	13	62.9	1520.0	-	-
4	1	13	64.7	1902.0	-	-
5	3	13	83.8	1410.0	1097.0	1621.0
6	1	13	65.4	1944.0	-	-
7	1	13	53.2	1024.0	-	-
8	1	13	51.7	1603.0	-	-
9	2	13	78.7	1804.0	1168.0	-
10	2	13	72.4	1030.0	1343.0	-
11	1	13	53.8	1327.0	-	-
12	2	13	73.6	1524.0	1553.0	-
13	2	13	66.7	1722.0	1122.0	-
14	2	13	82.5	1404.0	1019.0	-
15						
16						
17						
18						
19						
20						

Long Pulse Radar Test Signal

Test Signal Name: LP_Signal_17

Number of Bursts in Trial: 20

Chrip Center Frequency: 5499.72MHz

Burst	Pulses per Burst	Chrip (MHz)	Pulse Width(us)	PRI-1 (us)	PRI-2 (us)	PRI-3 (us)
1	3	20	87.6	1565.0	1055.0	1840.0
2	3	20	85.2	1735.0	1541.0	1408.0
3	3	20	84.8	1534.0	1889.0	1463.0
4	2	20	77.9	1749.0	1460.0	-
5	2	20	76.5	1518.0	1485.0	-
6	1	20	60.9	1540.0	-	-
7	2	20	83.0	1080.0	1010.0	-
8	2	20	80.4	1824.0	1752.0	-
9	2	20	67.5	1764.0	1181.0	-
10	1	20	62.1	1495.0	-	-
11	3	20	86.4	1773.0	1966.0	1263.0
12	3	20	84.3	1593.0	1188.0	1788.0
13	2	20	76.9	1226.0	1537.0	-
14	3	20	95.8	1192.0	1298.0	1844.0
15	1	20	55.2	1644.0	-	-
16	1	20	59.0	1402.0	-	-
17	3	20	94.5	1296.0	1700.0	1283.0
18	3	20	91.9	1970.0	1978.0	1165.0
19	3	20	85.2	1732.0	1551.0	1189.0
20	2	20	69.5	1038.0	1224.0	-

Long Pulse Radar Test Signal

Test Signal Name: LP_Signal_18

Number of Bursts in Trial: 12

Chrip Center Frequency: 5496.12MHz

Burst	Pulses per Burst	Chrip (MHz)	Pulse Width(us)	PRI-1 (us)	PRI-2 (us)	PRI-3 (us)
1	3	11	86.4	1259.0	1918.0	1455.0
2	3	11	92.2	1598.0	1719.0	1895.0
3	2	11	80.4	1816.0	1899.0	-
4	1	11	54.3	1335.0	-	-
5	1	11	53.1	1303.0	-	-
6	2	11	69.4	1503.0	1546.0	-
7	2	11	69.1	1279.0	1639.0	-
8	3	11	100.0	1375.0	1438.0	1595.0
9	2	11	79.6	1239.0	1705.0	-
10	3	11	88.4	1374.0	1579.0	1623.0
11	1	11	53.3	1016.0	-	-
12	1	11	65.3	1709.0	-	-
13						
14						
15						
16						
17						
18						
19						
20						

Long Pulse Radar Test Signal

Test Signal Name: LP_Signal_19

Number of Bursts in Trial: 14

Chrip Center Frequency: 5496.92MHz

Burst	Pulses per Burst	Chrip (MHz)	Pulse Width(us)	PRI-1 (us)	PRI-2 (us)	PRI-3 (us)
1	1	13	55.3	1920.0	-	-
2	1	13	58.3	1797.0	-	-
3	2	13	72.3	1610.0	1039.0	-
4	3	13	84.8	1131.0	1761.0	1721.0
5	2	13	82.5	1875.0	1431.0	-
6	1	13	63.3	1095.0	-	-
7	2	13	80.0	1119.0	1913.0	-
8	3	13	90.3	1660.0	1853.0	1123.0
9	3	13	91.1	1539.0	1783.0	1172.0
10	3	13	96.6	1525.0	1036.0	1385.0
11	2	13	82.7	1710.0	1990.0	-
12	1	13	50.7	1234.0	-	-
13	2	13	78.4	1047.0	1109.0	-
14	3	13	99.5	1299.0	1965.0	1869.0
15						
16						
17						
18						
19						
20						

Long Pulse Radar Test Signal
 Test Signal Name: LP_Signal_20
 Number of Bursts in Trial: 12
 Chrip Center Frequency: 5496.12MHz

Burst	Pulses per Burst	Chrip (MHz)	Pulse Width(us)	PRI-1 (us)	PRI-2 (us)	PRI-3 (us)
1	3	11	88.6	1501.0	1067.0	1927.0
2	1	11	57.4	1723.0	-	-
3	3	11	96.6	1086.0	1658.0	1324.0
4	2	11	69.7	1751.0	1945.0	-
5	2	11	77.9	1642.0	1317.0	-
6	1	11	62.0	1866.0	-	-
7	3	11	88.4	1997.0	1077.0	1366.0
8	3	11	97.3	1790.0	1896.0	1367.0
9	3	11	96.2	1391.0	1787.0	1672.0
10	3	11	95.4	1020.0	1892.0	1414.0
11	1	11	54.8	1084.0	-	-
12	2	11	80.4	1850.0	1436.0	-
13						
14						
15						
16						
17						
18						
19						
20						

Long Pulse Radar Test Signal

Test Signal Name: LP_Signal_21

Number of Bursts in Trial: 16

Chrip Center Frequency: 5640.75MHz

Burst	Pulses per Burst	Chrip (MHz)	Pulse Width(us)	PRI-1 (us)	PRI-2 (us)	PRI-3 (us)
1	2	16	74.7	1619.0	1611.0	-
2	1	16	57.1	1560.0	-	-
3	3	16	91.9	1392.0	1475.0	1276.0
4	2	16	83.1	1809.0	1772.0	-
5	1	16	50.7	1003.0	-	-
6	2	16	79.2	1574.0	1600.0	-
7	1	16	58.7	1186.0	-	-
8	2	16	71.0	1521.0	1567.0	-
9	2	16	79.0	1777.0	1960.0	-
10	2	16	68.5	1284.0	1428.0	-
11	2	16	73.5	1904.0	1352.0	-
12	2	16	70.5	1864.0	1115.0	-
13	2	16	76.6	1045.0	1300.0	-
14	2	16	81.2	1160.0	1675.0	-
15	1	16	61.8	1277.0	-	-
16	3	16	94.9	1450.0	1206.0	1860.0
17						
18						
19						
20						

Long Pulse Radar Test Signal

Test Signal Name: LP_Signal_22

Number of Bursts in Trial: 12

Chrip Center Frequency: 5643.15MHz

Burst	Pulses per Burst	Chrip (MHz)	Pulse Width(us)	PRI-1 (us)	PRI-2 (us)	PRI-3 (us)
1	2	10	78.5	1653.0	1698.0	-
2	3	10	89.8	1174.0	1962.0	1167.0
3	1	10	59.4	1982.0	-	-
4	2	10	79.6	1633.0	1890.0	-
5	2	10	76.0	1112.0	1811.0	-
6	1	10	53.6	1144.0	-	-
7	2	10	80.9	1220.0	1053.0	-
8	1	10	61.6	1724.0	-	-
9	1	10	53.4	1901.0	-	-
10	1	10	59.9	1379.0	-	-
11	1	10	60.4	1453.0	-	-
12	3	10	91.4	1768.0	1726.0	1227.0
13						
14						
15						
16						
17						
18						
19						
20						

Long Pulse Radar Test Signal

Test Signal Name: LP_Signal_23

Number of Bursts in Trial: 20

Chrip Center Frequency: 5639.15MHz

Burst	Pulses per Burst	Chrip (MHz)	Pulse Width(us)	PRI-1 (us)	PRI-2 (us)	PRI-3 (us)
1	2	20	77.0	1191.0	1363.0	-
2	1	20	58.1	1248.0	-	-
3	1	20	62.1	1836.0	-	-
4	2	20	76.9	1334.0	1236.0	-
5	2	20	80.0	1914.0	1852.0	-
6	1	20	52.0	1701.0	-	-
7	3	20	88.6	1693.0	1995.0	1905.0
8	2	20	72.9	1922.0	1387.0	-
9	3	20	98.5	1839.0	1746.0	1389.0
10	1	20	57.9	1193.0	-	-
11	3	20	95.9	1659.0	1870.0	1066.0
12	1	20	53.5	1162.0	-	-
13	3	20	92.0	1745.0	1654.0	1458.0
14	1	20	57.3	1834.0	-	-
15	2	20	70.5	1684.0	1586.0	-
16	2	20	70.0	1042.0	1664.0	-
17	3	20	84.0	1765.0	1630.0	1176.0
18	2	20	76.1	1557.0	1057.0	-
19	3	20	93.2	1985.0	1018.0	1340.0
20	3	20	96.8	1760.0	1614.0	1817.0

Long Pulse Radar Test Signal

Test Signal Name: LP_Signal_24

Number of Bursts in Trial: 14

Chrip Center Frequency: 5541.95MHz

Burst	Pulses per Burst	Chrip (MHz)	Pulse Width(us)	PRI-1 (us)	PRI-2 (us)	PRI-3 (us)
1	1	13	50.1	1841.0	-	-
2	3	13	93.5	1590.0	1081.0	1413.0
3	2	13	68.8	1707.0	1577.0	-
4	1	13	56.3	1056.0	-	-
5	3	13	86.0	1953.0	1108.0	1987.0
6	2	13	75.2	1572.0	1536.0	-
7	1	13	54.4	1517.0	-	-
8	2	13	71.1	1329.0	1243.0	-
9	2	13	76.2	1940.0	1770.0	-
10	2	13	80.2	1098.0	1209.0	-
11	2	13	79.7	1588.0	1214.0	-
12	3	13	90.9	1615.0	1862.0	1601.0
13	2	13	68.7	1377.0	1441.0	-
14	2	13	67.4	1872.0	1313.0	-
15						
16						
17						
18						
19						
20						

Long Pulse Radar Test Signal

Test Signal Name: LP_Signal_25

Number of Bursts in Trial: 13

Chrip Center Frequency: 5642.35MHz

Burst	Pulses per Burst	Chrip (MHz)	Pulse Width(us)	PRI-1 (us)	PRI-2 (us)	PRI-3 (us)
1	3	12	94.0	1643.0	1748.0	1941.0
2	2	12	70.8	1177.0	1201.0	-
3	1	12	56.3	1006.0	-	-
4	3	12	96.7	1230.0	1163.0	1332.0
5	3	12	90.6	1217.0	1582.0	1498.0
6	2	12	74.5	1569.0	1281.0	-
7	3	12	92.6	1065.0	1669.0	1222.0
8	3	12	89.0	1493.0	1135.0	1380.0
9	3	12	96.5	1607.0	1822.0	1602.0
10	2	12	70.5	1141.0	1178.0	-
11	3	12	94.0	1009.0	1629.0	1956.0
12	1	12	55.8	1290.0	-	-
13	3	12	87.7	1435.0	1963.0	1164.0
14						
15						
16						
17						
18						
19						
20						

Long Pulse Radar Test Signal

Test Signal Name: LP_Signal_26

Number of Bursts in Trial: 8

Chrip Center Frequency: 5644.75MHz

Burst	Pulses per Burst	Chrip (MHz)	Pulse Width(us)	PRI-1 (us)	PRI-2 (us)	PRI-3 (us)
1	2	6	68.6	1306.0	1161.0	-
2	2	6	83.1	1420.0	1315.0	-
3	1	6	60.9	1687.0	-	-
4	2	6	77.7	1776.0	1158.0	-
5	2	6	77.4	1793.0	1510.0	-
6	2	6	66.8	1576.0	1323.0	-
7	1	6	63.7	1333.0	-	-
8	3	6	91.2	1409.0	1681.0	1275.0
9						
10						
11						
12						
13						
14						
15						
16						
17						
18						
19						
20						

Long Pulse Radar Test Signal

Test Signal Name: LP_Signal_27

Number of Bursts in Trial: 17

Chrip Center Frequency: 5640.35MHz

Burst	Pulses per Burst	Chrip (MHz)	Pulse Width(us)	PRI-1 (us)	PRI-2 (us)	PRI-3 (us)
1	3	17	83.6	1632.0	1195.0	1000.0
2	3	17	89.4	1173.0	1627.0	1656.0
3	1	17	55.8	1532.0	-	-
4	3	17	90.9	1981.0	1554.0	1998.0
5	1	17	54.7	1825.0	-	-
6	3	17	97.7	1734.0	1202.0	1250.0
7	2	17	67.5	1571.0	1434.0	-
8	3	17	96.7	1589.0	1469.0	1268.0
9	2	17	68.3	1750.0	1954.0	-
10	2	17	78.3	1591.0	1082.0	-
11	1	17	55.0	1427.0	-	-
12	3	17	84.9	1129.0	1936.0	1199.0
13	2	17	74.6	1959.0	1856.0	-
14	1	17	63.3	1885.0	-	-
15	3	17	99.8	1035.0	1515.0	1120.0
16	1	17	63.6	1647.0	-	-
17	3	17	87.3	1931.0	1051.0	1831.0
18						
19						
20						

Long Pulse Radar Test Signal

Test Signal Name: LP_Signal_28

Number of Bursts in Trial: 19

Chrip Center Frequency: 5639.15MHz

Burst	Pulses per Burst	Chrip (MHz)	Pulse Width(us)	PRI-1 (us)	PRI-2 (us)	PRI-3 (us)
1	3	20	85.6	1946.0	1078.0	1015.0
2	2	20	68.6	1029.0	1780.0	-
3	1	20	54.2	1111.0	-	-
4	1	20	61.2	1104.0	-	-
5	3	20	97.1	1157.0	1969.0	1100.0
6	3	20	98.3	1142.0	1699.0	1622.0
7	1	20	62.4	1655.0	-	-
8	2	20	80.2	1126.0	1769.0	-
9	3	20	87.5	1216.0	1448.0	1179.0
10	3	20	85.8	1847.0	1348.0	1472.0
11	3	20	88.1	1023.0	1124.0	1631.0
12	1	20	65.3	1848.0	-	-
13	1	20	52.5	1470.0	-	-
14	1	20	52.3	1312.0	-	-
15	2	20	74.1	1915.0	1200.0	-
16	1	20	54.9	1479.0	-	-
17	2	20	76.2	1376.0	1502.0	-
18	1	20	60.4	1758.0	-	-
19	2	20	81.5	1491.0	1103.0	-
20						

Long Pulse Radar Test Signal

Test Signal Name: LP_Signal_29

Number of Bursts in Trial: 12

Chrip Center Frequency: 5642.75Hz

Burst	Pulses per Burst	Chrip (MHz)	Pulse Width(us)	PRI-1 (us)	PRI-2 (us)	PRI-3 (us)
1	1	11	50.5	1857.0	-	-
2	1	11	55.7	1246.0	-	-
3	3	11	85.8	1774.0	1002.0	1967.0
4	2	11	76.9	1125.0	1474.0	-
5	2	11	75.1	1254.0	1052.0	-
6	3	11	92.3	1180.0	1486.0	1492.0
7	2	11	78.1	1301.0	1757.0	-
8	3	11	92.2	1898.0	1252.0	1713.0
9	3	11	89.0	1260.0	1706.0	1411.0
10	2	11	70.9	1578.0	1620.0	-
11	1	11	63.1	1782.0	-	-
12	1	11	55.3	1522.0	-	-
13						
14						
15						
16						
17						
18						
19						

Long Pulse Radar Test Signal

Test Signal Name: LP_Signal_30

Number of Bursts in Trial: 18

Chrip Center Frequency: 5639.95Hz

Burst	Pulses per Burst	Chrip (MHz)	Pulse Width(us)	PRI-1 (us)	PRI-2 (us)	PRI-3 (us)
1	3	18	83.4	1454.0	1205.0	1801.0
2	3	18	97.3	1319.0	1826.0	1635.0
3	3	18	90.4	1079.0	1986.0	1674.0
4	3	18	91.8	1563.0	1151.0	1802.0
5	3	18	98.2	1876.0	1977.0	1766.0
6	1	18	59.5	1952.0	-	-
7	2	18	80.0	1253.0	1137.0	-
8	3	18	86.5	1054.0	1128.0	1828.0
9	3	18	91.1	1105.0	1599.0	1442.0
10	3	18	93.5	1867.0	1373.0	1087.0
11	1	18	60.7	1033.0	-	-
12	2	18	67.2	1288.0	1405.0	-
13	1	18	61.8	1585.0	-	-
14	2	18	79.4	1933.0	1667.0	-
15	2	18	81.4	1096.0	1464.0	-
16	1	18	65.7	1496.0	-	-
17	2	18	76.0	1733.0	1255.0	-
18	2	18	81.0	1326.0	1668.0	-

A.2 The Frequency Hopping Radar pattern

802.11be (EHT20)

Hopping Frequency Sequence Name: HOP_FREQ_SEQ_01							
SEQ#	Frequency (GHz)	SEQ#	Frequency (GHz)	SEQ#	Frequency (GHz)	SEQ#	Frequency (GHz)
1	5.505	2	5.674	3	5.257	4	5.690
5	5.520	6	5.262	7	5.356	8	5.439
9	5.685	10	5.332	11	5.720	12	5.579
13	5.313	14	5.383	15	5.697	16	5.318
17	5.695	18	5.461	19	5.719	20	5.606
21	5.533	22	5.287	23	5.675	24	5.540
25	5.604	26	5.591	27	5.564	28	5.612
29	5.399	30	5.593	31	5.600	32	5.478
33	5.667	34	5.434	35	5.299	36	5.387
37	5.319	38	5.376	39	5.710	40	5.581
41	5.624	42	5.302	43	5.406	44	5.272
45	5.531	46	5.298	47	5.303	48	5.265
49	5.688	50	5.372	51	5.699	52	5.550
53	5.336	54	5.308	55	5.565	56	5.269
57	5.635	58	5.650	59	5.357	60	5.462
61	5.389	62	5.626	63	5.411	64	5.386
65	5.665	66	5.481	67	5.354	68	5.267
69	5.279	70	5.558	71	5.578	72	5.647
73	5.717	74	5.382	75	5.297	76	5.601
77	5.630	78	5.603	79	5.676	80	5.657
81	5.608	82	5.329	83	5.388	84	5.602
85	5.549	86	5.451	87	5.709	88	5.716
89	5.643	90	5.285	91	5.377	92	5.443
93	5.535	94	5.584	95	5.506	96	5.723
97	5.507	98	5.712	99	5.680	100	5.724

Hopping Frequency Sequence Name: HOP_FREQ_SEQ_02

SEQ#	Frequency (GHz)	SEQ#	Frequency (GHz)	SEQ#	Frequency (GHz)	SEQ#	Frequency (GHz)
1	5.350	2	5.673	3	5.251	4	5.286
5	5.699	6	5.714	7	5.500	8	5.265
9	5.299	10	5.455	11	5.359	12	5.611
13	5.487	14	5.448	15	5.663	16	5.373
17	5.269	18	5.614	19	5.439	20	5.385
21	5.680	22	5.603	23	5.363	24	5.341
25	5.303	26	5.504	27	5.576	28	5.584
29	5.632	30	5.535	31	5.402	32	5.597
33	5.308	34	5.566	35	5.689	36	5.301
37	5.494	38	5.400	39	5.513	40	5.691
41	5.553	42	5.343	43	5.532	44	5.520
45	5.664	46	5.718	47	5.612	48	5.444
49	5.452	50	5.588	51	5.307	52	5.422
53	5.662	54	5.275	55	5.583	56	5.578
57	5.595	58	5.479	59	5.410	60	5.693
61	5.465	62	5.312	63	5.268	64	5.629
65	5.671	66	5.284	67	5.406	68	5.624
69	5.300	70	5.568	71	5.318	72	5.711
73	5.330	74	5.399	75	5.694	76	5.631
77	5.416	78	5.723	79	5.637	80	5.339
81	5.252	82	5.703	83	5.654	84	5.538
85	5.478	86	5.482	87	5.474	88	5.407
89	5.279	90	5.316	91	5.592	92	5.627
93	5.594	94	5.633	95	5.380	96	5.598
97	5.533	98	5.446	99	5.526	100	5.555

Hopping Frequency Sequence Name: HOP_FREQ_SEQ_03

SEQ#	Frequency (GHz)	SEQ#	Frequency (GHz)	SEQ#	Frequency (GHz)	SEQ#	Frequency (GHz)
1	5.501	2	5.592	3	5.263	4	5.484
5	5.549	6	5.346	7	5.361	8	5.576
9	5.264	10	5.700	11	5.623	12	5.324
13	5.640	14	5.669	15	5.344	16	5.579
17	5.703	18	5.585	19	5.382	20	5.601
21	5.364	22	5.296	23	5.524	24	5.532
25	5.546	26	5.555	27	5.710	28	5.644
29	5.465	30	5.456	31	5.526	32	5.627
33	5.621	34	5.717	35	5.667	36	5.652
37	5.659	38	5.498	39	5.478	40	5.386
41	5.654	42	5.508	43	5.716	44	5.599
45	5.408	46	5.427	47	5.306	48	5.402
49	5.337	50	5.464	51	5.712	52	5.358
53	5.278	54	5.680	55	5.365	56	5.442
57	5.432	58	5.538	59	5.315	60	5.587
61	5.342	62	5.615	63	5.674	64	5.563
65	5.668	66	5.460	67	5.590	68	5.542
69	5.685	70	5.469	71	5.453	72	5.429
73	5.504	74	5.660	75	5.353	76	5.616
77	5.417	78	5.672	79	5.331	80	5.393
81	5.449	82	5.347	83	5.610	84	5.706
85	5.314	86	5.321	87	5.415	88	5.724
89	5.392	90	5.437	91	5.691	92	5.407
93	5.625	94	5.463	95	5.582	96	5.646
97	5.622	98	5.688	99	5.266	100	5.428

Hopping Frequency Sequence Name: HOP_FREQ_SEQ_04

SEQ#	Frequency (GHz)	SEQ#	Frequency (GHz)	SEQ#	Frequency (GHz)	SEQ#	Frequency (GHz)
1	5.487	2	5.498	3	5.707	4	5.277
5	5.312	6	5.447	7	5.259	8	5.548
9	5.492	10	5.699	11	5.308	12	5.677
13	5.328	14	5.520	15	5.318	16	5.433
17	5.440	18	5.294	19	5.486	20	5.258
21	5.370	22	5.405	23	5.266	24	5.380
25	5.292	26	5.590	27	5.459	28	5.495
29	5.541	30	5.564	31	5.472	32	5.680
33	5.558	34	5.319	35	5.645	36	5.475
37	5.591	38	5.375	39	5.678	40	5.649
41	5.437	42	5.674	43	5.706	44	5.460
45	5.316	46	5.636	47	5.301	48	5.660
49	5.416	50	5.284	51	5.321	52	5.545
53	5.260	54	5.353	55	5.489	56	5.334
57	5.256	58	5.600	59	5.307	60	5.683
61	5.288	62	5.637	63	5.631	64	5.253
65	5.604	66	5.709	67	5.568	68	5.697
69	5.404	70	5.508	71	5.681	72	5.345
73	5.300	74	5.497	75	5.633	76	5.655
77	5.415	78	5.333	79	5.251	80	5.374
81	5.451	82	5.443	83	5.625	84	5.473
85	5.584	86	5.338	87	5.647	88	5.304
89	5.525	90	5.542	91	5.361	92	5.650
93	5.482	94	5.666	95	5.608	96	5.589
97	5.427	98	5.384	99	5.457	100	5.355

Hopping Frequency Sequence Name: HOP_FREQ_SEQ_05

SEQ#	Frequency (GHz)	SEQ#	Frequency (GHz)	SEQ#	Frequency (GHz)	SEQ#	Frequency (GHz)
1	5.583	2	5.381	3	5.662	4	5.649
5	5.275	6	5.678	7	5.287	8	5.452
9	5.461	10	5.670	11	5.279	12	5.702
13	5.399	14	5.420	15	5.479	16	5.278
17	5.487	18	5.484	19	5.320	20	5.433
21	5.550	22	5.333	23	5.573	24	5.456
25	5.299	26	5.261	27	5.263	28	5.614
29	5.321	30	5.300	31	5.391	32	5.551
33	5.600	34	5.509	35	5.718	36	5.522
37	5.396	38	5.713	39	5.457	40	5.717
41	5.659	42	5.607	43	5.536	44	5.370
45	5.329	46	5.708	47	5.534	48	5.429
49	5.492	50	5.379	51	5.653	52	5.545
53	5.620	54	5.681	55	5.546	56	5.715
57	5.616	58	5.591	59	5.508	60	5.375
61	5.271	62	5.596	63	5.500	64	5.455
65	5.318	66	5.585	67	5.336	68	5.657
69	5.598	70	5.251	71	5.512	72	5.668
73	5.665	74	5.667	75	5.682	76	5.407
77	5.489	78	5.309	79	5.490	80	5.418
81	5.257	82	5.697	83	5.719	84	5.341
85	5.689	86	5.647	87	5.568	88	5.699
89	5.674	90	5.572	91	5.619	92	5.408
93	5.664	94	5.706	95	5.360	96	5.439
97	5.284	98	5.312	99	5.367	100	5.478

Hopping Frequency Sequence Name: HOP_FREQ_SEQ_06

SEQ#	Frequency (GHz)	SEQ#	Frequency (GHz)	SEQ#	Frequency (GHz)	SEQ#	Frequency (GHz)
1	5.493	2	5.665	3	5.291	4	5.553
5	5.367	6	5.518	7	5.444	8	5.350
9	5.338	10	5.467	11	5.262	12	5.629
13	5.439	14	5.406	15	5.267	16	5.293
17	5.384	18	5.447	19	5.647	20	5.716
21	5.583	22	5.697	23	5.260	24	5.609
25	5.465	26	5.632	27	5.268	28	5.593
29	5.611	30	5.546	31	5.466	32	5.478
33	5.653	34	5.660	35	5.357	36	5.454
37	5.605	38	5.502	39	5.604	40	5.703
41	5.637	42	5.519	43	5.258	44	5.601
45	5.516	46	5.346	47	5.645	48	5.638
49	5.418	50	5.354	51	5.644	52	5.456
53	5.682	54	5.702	55	5.607	56	5.503
57	5.396	58	5.441	59	5.273	60	5.548
61	5.314	62	5.371	63	5.306	64	5.360
65	5.691	66	5.413	67	5.551	68	5.485
69	5.495	70	5.419	71	5.531	72	5.492
73	5.499	74	5.392	75	5.347	76	5.497
77	5.692	78	5.342	79	5.723	80	5.356
81	5.484	82	5.491	83	5.705	84	5.563
85	5.394	86	5.397	87	5.534	88	5.269
89	5.471	90	5.514	91	5.339	92	5.640
93	5.332	94	5.680	95	5.482	96	5.488
97	5.429	98	5.430	99	5.464	100	5.295

Hopping Frequency Sequence Name: HOP_FREQ_SEQ_07

SEQ#	Frequency (GHz)	SEQ#	Frequency (GHz)	SEQ#	Frequency (GHz)	SEQ#	Frequency (GHz)
1	5.320	2	5.390	3	5.286	4	5.418
5	5.603	6	5.488	7	5.457	8	5.410
9	5.299	10	5.545	11	5.358	12	5.355
13	5.454	14	5.277	15	5.687	16	5.582
17	5.434	18	5.475	19	5.619	20	5.627
21	5.307	22	5.317	23	5.319	24	5.421
25	5.556	26	5.541	27	5.623	28	5.546
29	5.336	30	5.578	31	5.304	32	5.325
33	5.574	34	5.382	35	5.570	36	5.544
37	5.700	38	5.571	39	5.491	40	5.465
41	5.272	42	5.536	43	5.279	44	5.402
45	5.628	46	5.595	47	5.479	48	5.401
49	5.451	50	5.356	51	5.309	52	5.561
53	5.539	54	5.685	55	5.648	56	5.693
57	5.414	58	5.679	59	5.362	60	5.695
61	5.256	62	5.283	63	5.376	64	5.706
65	5.504	66	5.441	67	5.284	68	5.449
69	5.476	70	5.462	71	5.381	72	5.343
73	5.638	74	5.689	75	5.357	76	5.389
77	5.255	78	5.303	79	5.592	80	5.675
81	5.450	82	5.611	83	5.566	84	5.265
85	5.510	86	5.724	87	5.680	88	5.392
89	5.296	90	5.605	91	5.490	92	5.631
93	5.560	94	5.612	95	5.555	96	5.487
97	5.530	98	5.327	99	5.573	100	5.704

Hopping Frequency Sequence Name: HOP_FREQ_SEQ_08

SEQ#	Frequency (GHz)	SEQ#	Frequency (GHz)	SEQ#	Frequency (GHz)	SEQ#	Frequency (GHz)
1	5.537	2	5.669	3	5.683	4	5.517
5	5.583	6	5.304	7	5.607	8	5.656
9	5.424	10	5.441	11	5.256	12	5.552
13	5.599	14	5.277	15	5.349	16	5.707
17	5.521	18	5.478	19	5.612	20	5.302
21	5.677	22	5.581	23	5.300	24	5.412
25	5.381	26	5.259	27	5.637	28	5.251
29	5.296	30	5.565	31	5.306	32	5.285
33	5.648	34	5.563	35	5.452	36	5.555
37	5.650	38	5.495	39	5.503	40	5.594
41	5.469	42	5.582	43	5.307	44	5.255
45	5.253	46	5.323	47	5.676	48	5.709
49	5.720	50	5.712	51	5.679	52	5.482
53	5.438	54	5.415	55	5.268	56	5.636
57	5.593	58	5.427	59	5.383	60	5.661
61	5.560	62	5.697	63	5.675	64	5.468
65	5.649	66	5.298	67	5.651	68	5.400
69	5.647	70	5.467	71	5.329	72	5.652
73	5.589	74	5.347	75	5.628	76	5.500
77	5.689	78	5.368	79	5.611	80	5.387
81	5.608	82	5.473	83	5.575	84	5.278
85	5.704	86	5.662	87	5.342	88	5.592
89	5.686	90	5.702	91	5.624	92	5.434
93	5.416	94	5.553	95	5.576	96	5.477
97	5.464	98	5.396	99	5.386	100	5.432

Hopping Frequency Sequence Name: HOP_FREQ_SEQ_09

SEQ#	Frequency (GHz)	SEQ#	Frequency (GHz)	SEQ#	Frequency (GHz)	SEQ#	Frequency (GHz)
1	5.349	2	5.590	3	5.466	4	5.546
5	5.530	6	5.355	7	5.575	8	5.709
9	5.350	10	5.724	11	5.456	12	5.682
13	5.625	14	5.554	15	5.713	16	5.477
17	5.432	18	5.412	19	5.454	20	5.402
21	5.357	22	5.389	23	5.626	24	5.717
25	5.282	26	5.524	27	5.697	28	5.264
29	5.467	30	5.720	31	5.459	32	5.313
33	5.640	34	5.329	35	5.605	36	5.427
37	5.295	38	5.567	39	5.302	40	5.635
41	5.278	42	5.578	43	5.461	44	5.700
45	5.455	46	5.327	47	5.592	48	5.275
49	5.632	50	5.453	51	5.422	52	5.300
53	5.721	54	5.650	55	5.704	56	5.380
57	5.403	58	5.373	59	5.367	60	5.372
61	5.492	62	5.690	63	5.618	64	5.540
65	5.508	66	5.485	67	5.496	68	5.548
69	5.512	70	5.687	71	5.296	72	5.676
73	5.499	74	5.440	75	5.579	76	5.604
77	5.608	78	5.723	79	5.576	80	5.703
81	5.433	82	5.612	83	5.482	84	5.583
85	5.633	86	5.582	87	5.437	88	5.521
89	5.601	90	5.391	91	5.647	92	5.393
93	5.419	94	5.598	95	5.434	96	5.597
97	5.446	98	5.478	99	5.551	100	5.621

Hopping Frequency Sequence Name: HOP_FREQ_SEQ_10

SEQ#	Frequency (GHz)	SEQ#	Frequency (GHz)	SEQ#	Frequency (GHz)	SEQ#	Frequency (GHz)
1	5.550	2	5.265	3	5.435	4	5.470
5	5.657	6	5.490	7	5.566	8	5.303
9	5.400	10	5.263	11	5.271	12	5.372
13	5.448	14	5.659	15	5.549	16	5.571
17	5.381	18	5.398	19	5.278	20	5.511
21	5.583	22	5.333	23	5.482	24	5.494
25	5.353	26	5.668	27	5.460	28	5.563
29	5.706	30	5.421	31	5.283	32	5.703
33	5.554	34	5.503	35	5.513	36	5.461
37	5.355	38	5.341	39	5.532	40	5.528
41	5.380	42	5.698	43	5.392	44	5.582
45	5.285	46	5.425	47	5.454	48	5.617
49	5.323	50	5.281	51	5.544	52	5.466
53	5.447	54	5.420	55	5.600	56	5.676
57	5.422	58	5.638	59	5.324	60	5.295
61	5.359	62	5.483	63	5.628	64	5.350
65	5.690	66	5.389	67	5.495	68	5.252
69	5.603	70	5.688	71	5.266	72	5.696
73	5.713	74	5.649	75	5.465	76	5.413
77	5.551	78	5.615	79	5.620	80	5.358
81	5.567	82	5.442	83	5.524	84	5.506
85	5.296	86	5.597	87	5.360	88	5.484
89	5.430	90	5.407	91	5.612	92	5.619
93	5.488	94	5.631	95	5.375	96	5.432
97	5.641	98	5.342	99	5.443	100	5.590

Hopping Frequency Sequence Name: HOP_FREQ_SEQ_11

SEQ#	Frequency (GHz)	SEQ#	Frequency (GHz)	SEQ#	Frequency (GHz)	SEQ#	Frequency (GHz)
1	5.408	2	5.306	3	5.263	4	5.393
5	5.321	6	5.559	7	5.525	8	5.427
9	5.723	10	5.451	11	5.696	12	5.626
13	5.709	14	5.553	15	5.257	16	5.474
17	5.261	18	5.669	19	5.462	20	5.348
21	5.487	22	5.589	23	5.625	24	5.294
25	5.262	26	5.711	27	5.362	28	5.623
29	5.568	30	5.564	31	5.666	32	5.413
33	5.538	34	5.484	35	5.641	36	5.520
37	5.721	38	5.483	39	5.659	40	5.339
41	5.300	42	5.478	43	5.563	44	5.269
45	5.684	46	5.663	47	5.252	48	5.254
49	5.480	50	5.655	51	5.521	52	5.377
53	5.603	54	5.627	55	5.314	56	5.364
57	5.629	58	5.365	59	5.351	60	5.528
61	5.657	62	5.447	63	5.270	64	5.477
65	5.515	66	5.295	67	5.268	68	5.383
69	5.251	70	5.458	71	5.320	72	5.374
73	5.492	74	5.358	75	5.357	76	5.410
77	5.676	78	5.588	79	5.414	80	5.399
81	5.498	82	5.491	83	5.604	84	5.658
85	5.330	86	5.613	87	5.317	88	5.539
89	5.652	90	5.403	91	5.675	92	5.642
93	5.551	94	5.343	95	5.460	96	5.543
97	5.369	98	5.276	99	5.532	100	5.708

Hopping Frequency Sequence Name: HOP_FREQ_SEQ_12

SEQ#	Frequency (GHz)	SEQ#	Frequency (GHz)	SEQ#	Frequency (GHz)	SEQ#	Frequency (GHz)
1	5.603	2	5.666	3	5.522	4	5.502
5	5.678	6	5.480	7	5.479	8	5.281
9	5.364	10	5.297	11	5.713	12	5.316
13	5.476	14	5.662	15	5.437	16	5.710
17	5.561	18	5.306	19	5.416	20	5.463
21	5.268	22	5.498	23	5.674	24	5.313
25	5.549	26	5.294	27	5.558	28	5.637
29	5.583	30	5.462	31	5.291	32	5.492
33	5.452	34	5.260	35	5.497	36	5.535
37	5.586	38	5.577	39	5.658	40	5.470
41	5.424	42	5.264	43	5.680	44	5.347
45	5.619	46	5.500	47	5.266	48	5.411
49	5.272	50	5.353	51	5.661	52	5.317
53	5.696	54	5.576	55	5.391	56	5.376
57	5.442	58	5.432	59	5.305	60	5.461
61	5.398	62	5.394	63	5.368	64	5.283
65	5.624	66	5.414	67	5.483	68	5.458
69	5.329	70	5.634	71	5.578	72	5.718
73	5.387	74	5.596	75	5.650	76	5.517
77	5.690	78	5.453	79	5.613	80	5.653
81	5.628	82	5.451	83	5.478	84	5.356
85	5.441	86	5.381	87	5.552	88	5.395
89	5.341	90	5.496	91	5.455	92	5.469
93	5.573	94	5.365	95	5.642	96	5.505
97	5.309	98	5.397	99	5.568	100	5.639

Hopping Frequency Sequence Name: HOP_FREQ_SEQ_13

SEQ#	Frequency (GHz)	SEQ#	Frequency (GHz)	SEQ#	Frequency (GHz)	SEQ#	Frequency (GHz)
1	5.375	2	5.264	3	5.273	4	5.293
5	5.612	6	5.436	7	5.695	8	5.549
9	5.422	10	5.631	11	5.262	12	5.490
13	5.589	14	5.506	15	5.326	16	5.282
17	5.657	18	5.497	19	5.509	20	5.660
21	5.474	22	5.629	23	5.272	24	5.314
25	5.433	26	5.560	27	5.399	28	5.357
29	5.668	30	5.484	31	5.408	32	5.325
33	5.434	34	5.356	35	5.563	36	5.285
37	5.401	38	5.426	39	5.393	40	5.621
41	5.277	42	5.567	43	5.593	44	5.559
45	5.496	46	5.675	47	5.419	48	5.319
49	5.690	50	5.694	51	5.373	52	5.661
53	5.367	54	5.522	55	5.674	56	5.265
57	5.300	58	5.468	59	5.596	60	5.324
61	5.528	62	5.526	63	5.537	64	5.669
65	5.599	66	5.358	67	5.303	68	5.648
69	5.378	70	5.478	71	5.469	72	5.407
73	5.513	74	5.263	75	5.586	76	5.360
77	5.571	78	5.604	79	5.446	80	5.479
81	5.482	82	5.366	83	5.394	84	5.693
85	5.288	86	5.512	87	5.551	88	5.585
89	5.723	90	5.705	91	5.412	92	5.711
93	5.345	94	5.486	95	5.678	96	5.361
97	5.390	98	5.352	99	5.649	100	5.647

Hopping Frequency Sequence Name: HOP_FREQ_SEQ_14

SEQ#	Frequency (GHz)	SEQ#	Frequency (GHz)	SEQ#	Frequency (GHz)	SEQ#	Frequency (GHz)
1	5.507	2	5.709	3	5.352	4	5.516
5	5.503	6	5.594	7	5.415	8	5.255
9	5.475	10	5.275	11	5.657	12	5.344
13	5.534	14	5.406	15	5.612	16	5.671
17	5.389	18	5.314	19	5.323	20	5.544
21	5.277	22	5.302	23	5.545	24	5.577
25	5.388	26	5.258	27	5.386	28	5.434
29	5.312	30	5.595	31	5.689	32	5.420
33	5.287	34	5.408	35	5.464	36	5.511
37	5.443	38	5.427	39	5.416	40	5.365
41	5.500	42	5.587	43	5.457	44	5.395
45	5.621	46	5.588	47	5.442	48	5.411
49	5.390	50	5.539	51	5.425	52	5.521
53	5.722	54	5.696	55	5.413	56	5.529
57	5.355	58	5.656	59	5.704	60	5.316
61	5.480	62	5.581	63	5.632	64	5.676
65	5.482	66	5.432	67	5.259	68	5.438
69	5.694	70	5.580	71	5.536	72	5.663
73	5.495	74	5.674	75	5.347	76	5.400
77	5.465	78	5.330	79	5.589	80	5.519
81	5.699	82	5.645	83	5.380	84	5.672
85	5.635	86	5.548	87	5.563	88	5.710
89	5.348	90	5.629	91	5.641	92	5.509
93	5.317	94	5.384	95	5.562	96	5.666
97	5.332	98	5.456	99	5.262	100	5.701

Hopping Frequency Sequence Name: HOP_FREQ_SEQ_15

SEQ#	Frequency (GHz)	SEQ#	Frequency (GHz)	SEQ#	Frequency (GHz)	SEQ#	Frequency (GHz)
1	5.332	2	5.253	3	5.256	4	5.368
5	5.366	6	5.427	7	5.495	8	5.322
9	5.496	10	5.474	11	5.448	12	5.678
13	5.410	14	5.687	15	5.686	16	5.533
17	5.269	18	5.385	19	5.429	20	5.261
21	5.585	22	5.509	23	5.255	24	5.478
25	5.360	26	5.339	27	5.335	28	5.512
29	5.604	30	5.462	31	5.479	32	5.562
33	5.693	34	5.337	35	5.671	36	5.260
37	5.382	38	5.556	39	5.523	40	5.292
41	5.273	42	5.313	43	5.586	44	5.668
45	5.317	46	5.324	47	5.505	48	5.486
49	5.358	50	5.493	51	5.456	52	5.610
53	5.528	54	5.590	55	5.506	56	5.517
57	5.530	58	5.640	59	5.318	60	5.274
61	5.381	62	5.579	63	5.667	64	5.661
65	5.415	66	5.442	67	5.621	68	5.552
69	5.455	70	5.300	71	5.441	72	5.491
73	5.722	74	5.305	75	5.331	76	5.365
77	5.390	78	5.637	79	5.266	80	5.591
81	5.563	82	5.607	83	5.461	84	5.262
85	5.605	86	5.617	87	5.403	88	5.600
89	5.492	90	5.294	91	5.706	92	5.507
93	5.284	94	5.298	95	5.564	96	5.650
97	5.537	98	5.611	99	5.645	100	5.413

Hopping Frequency Sequence Name: HOP_FREQ_SEQ_16

SEQ#	Frequency (GHz)	SEQ#	Frequency (GHz)	SEQ#	Frequency (GHz)	SEQ#	Frequency (GHz)
1	5.469	2	5.426	3	5.347	4	5.449
5	5.330	6	5.537	7	5.391	8	5.687
9	5.666	10	5.332	11	5.651	12	5.341
13	5.352	14	5.457	15	5.686	16	5.531
17	5.693	18	5.631	19	5.269	20	5.525
21	5.702	22	5.403	23	5.536	24	5.363
25	5.516	26	5.538	27	5.490	28	5.511
29	5.724	30	5.704	31	5.442	32	5.441
33	5.411	34	5.717	35	5.571	36	5.647
37	5.649	38	5.606	39	5.319	40	5.448
41	5.504	42	5.472	43	5.609	44	5.438
45	5.545	46	5.480	47	5.256	48	5.679
49	5.382	50	5.284	51	5.543	52	5.424
53	5.317	54	5.520	55	5.604	56	5.397
57	5.505	58	5.463	59	5.685	60	5.602
61	5.270	62	5.618	63	5.662	64	5.273
65	5.707	66	5.664	67	5.552	68	5.294
69	5.320	70	5.464	71	5.641	72	5.476
73	5.661	74	5.566	75	5.299	76	5.584
77	5.619	78	5.420	79	5.488	80	5.593
81	5.654	82	5.714	83	5.287	84	5.657
85	5.337	86	5.644	87	5.648	88	5.659
89	5.251	90	5.265	91	5.279	92	5.359
93	5.460	94	5.413	95	5.308	96	5.544
97	5.640	98	5.394	99	5.348	100	5.613

Hopping Frequency Sequence Name: HOP_FREQ_SEQ_17

SEQ#	Frequency (GHz)	SEQ#	Frequency (GHz)	SEQ#	Frequency (GHz)	SEQ#	Frequency (GHz)
1	5.421	2	5.498	3	5.713	4	5.660
5	5.583	6	5.662	7	5.657	8	5.641
9	5.268	10	5.654	11	5.517	12	5.259
13	5.485	14	5.419	15	5.276	16	5.649
17	5.467	18	5.646	19	5.359	20	5.642
21	5.659	22	5.620	23	5.345	24	5.257
25	5.288	26	5.478	27	5.637	28	5.252
29	5.489	30	5.274	31	5.703	32	5.534
33	5.376	34	5.719	35	5.682	36	5.413
37	5.614	38	5.448	39	5.256	40	5.365
41	5.587	42	5.350	43	5.605	44	5.447
45	5.328	46	5.710	47	5.330	48	5.679
49	5.557	50	5.674	51	5.437	52	5.668
53	5.714	54	5.353	55	5.488	56	5.427
57	5.577	58	5.482	59	5.700	60	5.626
61	5.307	62	5.464	63	5.423	64	5.336
65	5.617	66	5.608	67	5.562	68	5.443
69	5.446	70	5.561	71	5.493	72	5.560
73	5.304	74	5.354	75	5.495	76	5.680
77	5.397	78	5.344	79	5.426	80	5.425
81	5.599	82	5.567	83	5.510	84	5.555
85	5.625	86	5.324	87	5.707	88	5.262
89	5.501	90	5.651	91	5.292	92	5.424
93	5.573	94	5.411	95	5.597	96	5.691
97	5.435	98	5.459	99	5.282	100	5.600

Hopping Frequency Sequence Name: HOP_FREQ_SEQ_18

SEQ#	Frequency (GHz)	SEQ#	Frequency (GHz)	SEQ#	Frequency (GHz)	SEQ#	Frequency (GHz)
1	5.471	2	5.678	3	5.410	4	5.537
5	5.446	6	5.666	7	5.563	8	5.355
9	5.484	10	5.489	11	5.556	12	5.596
13	5.454	14	5.682	15	5.554	16	5.595
17	5.270	18	5.610	19	5.586	20	5.549
21	5.264	22	5.415	23	5.266	24	5.339
25	5.662	26	5.697	27	5.379	28	5.392
29	5.301	30	5.334	31	5.573	32	5.643
33	5.253	34	5.439	35	5.300	36	5.519
37	5.267	38	5.689	39	5.539	40	5.455
41	5.468	42	5.613	43	5.496	44	5.665
45	5.381	46	5.250	47	5.298	48	5.272
49	5.592	50	5.360	51	5.532	52	5.324
53	5.710	54	5.409	55	5.517	56	5.467
57	5.647	58	5.668	59	5.309	60	5.548
61	5.317	62	5.428	63	5.597	64	5.314
65	5.481	66	5.308	67	5.584	68	5.622
69	5.358	70	5.466	71	5.616	72	5.295
73	5.364	74	5.261	75	5.655	76	5.660
77	5.457	78	5.672	79	5.565	80	5.652
81	5.260	82	5.683	83	5.343	84	5.401
85	5.325	86	5.686	87	5.353	88	5.315
89	5.373	90	5.402	91	5.352	92	5.599
93	5.626	94	5.702	95	5.258	96	5.460
97	5.724	98	5.670	99	5.444	100	5.388

Hopping Frequency Sequence Name: HOP_FREQ_SEQ_19

SEQ#	Frequency (GHz)	SEQ#	Frequency (GHz)	SEQ#	Frequency (GHz)	SEQ#	Frequency (GHz)
1	5.550	2	5.672	3	5.305	4	5.508
5	5.713	6	5.500	7	5.312	8	5.704
9	5.291	10	5.288	11	5.664	12	5.468
13	5.405	14	5.558	15	5.313	16	5.308
17	5.390	18	5.685	19	5.526	20	5.394
21	5.616	22	5.333	23	5.419	24	5.461
25	5.417	26	5.393	27	5.427	28	5.650
29	5.376	30	5.351	31	5.656	32	5.494
33	5.700	34	5.365	35	5.624	36	5.551
37	5.259	38	5.657	39	5.470	40	5.666
41	5.250	42	5.501	43	5.681	44	5.496
45	5.370	46	5.689	47	5.535	48	5.271
49	5.444	50	5.696	51	5.337	52	5.621
53	5.265	54	5.399	55	5.609	56	5.722
57	5.401	58	5.667	59	5.473	60	5.511
61	5.350	62	5.614	63	5.516	64	5.409
65	5.260	66	5.709	67	5.677	68	5.590
69	5.671	70	5.418	71	5.297	72	5.623
73	5.539	74	5.371	75	5.280	76	5.422
77	5.607	78	5.407	79	5.533	80	5.316
81	5.301	82	5.640	83	5.610	84	5.454
85	5.413	86	5.512	87	5.577	88	5.557
89	5.471	90	5.622	91	5.439	92	5.361
93	5.582	94	5.360	95	5.440	96	5.537
97	5.406	98	5.585	99	5.342	100	5.462

Hopping Frequency Sequence Name: HOP_FREQ_SEQ_20

SEQ#	Frequency (GHz)	SEQ#	Frequency (GHz)	SEQ#	Frequency (GHz)	SEQ#	Frequency (GHz)
1	5.664	2	5.377	3	5.595	4	5.701
5	5.596	6	5.490	7	5.573	8	5.706
9	5.594	10	5.393	11	5.581	12	5.592
13	5.403	14	5.547	15	5.428	16	5.314
17	5.643	18	5.585	19	5.444	20	5.405
21	5.279	22	5.294	23	5.477	24	5.277
25	5.543	26	5.338	27	5.720	28	5.613
29	5.323	30	5.541	31	5.496	32	5.270
33	5.499	34	5.410	35	5.530	36	5.339
37	5.452	38	5.287	39	5.423	40	5.375
41	5.328	42	5.644	43	5.620	44	5.333
45	5.635	46	5.566	47	5.645	48	5.497
49	5.325	50	5.417	51	5.523	52	5.562
53	5.605	54	5.495	55	5.271	56	5.693
57	5.442	58	5.524	59	5.637	60	5.407
61	5.421	62	5.342	63	5.435	64	5.590
65	5.636	66	5.711	67	5.468	68	5.288
69	5.488	70	5.719	71	5.699	72	5.400
73	5.343	74	5.589	75	5.379	76	5.408
77	5.406	78	5.712	79	5.370	80	5.268
81	5.299	82	5.576	83	5.619	84	5.332
85	5.361	86	5.465	87	5.517	88	5.485
89	5.724	90	5.557	91	5.297	92	5.586
93	5.321	94	5.368	95	5.683	96	5.526
97	5.649	98	5.587	99	5.582	100	5.681

Hopping Frequency Sequence Name: HOP_FREQ_SEQ_21

SEQ#	Frequency (GHz)	SEQ#	Frequency (GHz)	SEQ#	Frequency (GHz)	SEQ#	Frequency (GHz)
1	5.265	2	5.645	3	5.335	4	5.680
5	5.551	6	5.661	7	5.669	8	5.387
9	5.352	10	5.635	11	5.451	12	5.534
13	5.511	14	5.708	15	5.721	16	5.644
17	5.524	18	5.634	19	5.453	20	5.698
21	5.631	22	5.445	23	5.279	24	5.582
25	5.488	26	5.687	27	5.292	28	5.673
29	5.361	30	5.256	31	5.471	32	5.523
33	5.464	34	5.330	35	5.555	36	5.499
37	5.700	38	5.613	39	5.695	40	5.672
41	5.591	42	5.399	43	5.432	44	5.664
45	5.578	46	5.571	47	5.478	48	5.463
49	5.431	50	5.516	51	5.371	52	5.652
53	5.709	54	5.692	55	5.421	56	5.480
57	5.425	58	5.293	59	5.285	60	5.693
61	5.666	62	5.609	63	5.377	64	5.338
65	5.597	66	5.430	67	5.568	68	5.489
69	5.495	70	5.479	71	5.304	72	5.527
73	5.473	74	5.397	75	5.643	76	5.626
77	5.411	78	5.702	79	5.409	80	5.512
81	5.599	82	5.497	83	5.393	84	5.351
85	5.706	86	5.327	87	5.660	88	5.437
89	5.322	90	5.566	91	5.553	92	5.501
93	5.315	94	5.590	95	5.385	96	5.650
97	5.614	98	5.705	99	5.276	100	5.469

Hopping Frequency Sequence Name: HOP_FREQ_SEQ_22

SEQ#	Frequency (GHz)	SEQ#	Frequency (GHz)	SEQ#	Frequency (GHz)	SEQ#	Frequency (GHz)
1	5.609	2	5.255	3	5.447	4	5.276
5	5.345	6	5.385	7	5.526	8	5.623
9	5.601	10	5.535	11	5.657	12	5.300
13	5.306	14	5.708	15	5.495	16	5.422
17	5.658	18	5.379	19	5.692	20	5.502
21	5.253	22	5.498	23	5.380	24	5.670
25	5.460	26	5.514	27	5.545	28	5.319
29	5.252	30	5.457	31	5.478	32	5.707
33	5.722	34	5.681	35	5.329	36	5.390
37	5.367	38	5.622	39	5.286	40	5.472
41	5.435	42	5.427	43	5.458	44	5.715
45	5.537	46	5.312	47	5.671	48	5.521
49	5.322	50	5.655	51	5.308	52	5.484
53	5.361	54	5.304	55	5.259	56	5.418
57	5.360	58	5.724	59	5.594	60	5.420
61	5.549	62	5.454	63	5.314	64	5.569
65	5.467	66	5.450	67	5.519	68	5.444
69	5.268	70	5.663	71	5.709	72	5.610
73	5.621	74	5.647	75	5.648	76	5.557
77	5.529	78	5.483	79	5.589	80	5.377
81	5.338	82	5.698	83	5.433	84	5.446
85	5.618	86	5.597	87	5.393	88	5.554
89	5.477	90	5.403	91	5.280	92	5.719
93	5.263	94	5.465	95	5.305	96	5.646
97	5.550	98	5.396	99	5.637	100	5.716

Hopping Frequency Sequence Name: HOP_FREQ_SEQ_23

SEQ#	Frequency (GHz)	SEQ#	Frequency (GHz)	SEQ#	Frequency (GHz)	SEQ#	Frequency (GHz)
1	5.401	2	5.459	3	5.412	4	5.639
5	5.383	6	5.630	7	5.689	8	5.673
9	5.441	10	5.384	11	5.432	12	5.451
13	5.608	14	5.440	15	5.593	16	5.398
17	5.590	18	5.280	19	5.339	20	5.257
21	5.702	22	5.422	23	5.648	24	5.683
25	5.642	26	5.479	27	5.354	28	5.718
29	5.633	30	5.620	31	5.562	32	5.334
33	5.515	34	5.546	35	5.585	36	5.486
37	5.366	38	5.409	39	5.375	40	5.392
41	5.482	42	5.313	43	5.660	44	5.279
45	5.563	46	5.617	47	5.694	48	5.307
49	5.314	50	5.376	51	5.447	52	5.697
53	5.393	54	5.698	55	5.335	56	5.358
57	5.503	58	5.605	59	5.712	60	5.413
61	5.285	62	5.662	63	5.576	64	5.429
65	5.365	66	5.653	67	5.284	68	5.687
69	5.415	70	5.315	71	5.347	72	5.722
73	5.613	74	5.372	75	5.425	76	5.504
77	5.723	78	5.330	79	5.672	80	5.473
81	5.423	82	5.618	83	5.526	84	5.452
85	5.301	86	5.460	87	5.652	88	5.592
89	5.547	90	5.286	91	5.614	92	5.603
93	5.696	94	5.484	95	5.721	96	5.343
97	5.519	98	5.667	99	5.407	100	5.489

Hopping Frequency Sequence Name: HOP_FREQ_SEQ_24

SEQ#	Frequency (GHz)	SEQ#	Frequency (GHz)	SEQ#	Frequency (GHz)	SEQ#	Frequency (GHz)
1	5.338	2	5.690	3	5.513	4	5.614
5	5.452	6	5.451	7	5.357	8	5.646
9	5.375	10	5.403	11	5.400	12	5.341
13	5.469	14	5.723	15	5.707	16	5.314
17	5.708	18	5.474	19	5.336	20	5.416
21	5.427	22	5.521	23	5.593	24	5.611
25	5.598	26	5.558	27	5.652	28	5.581
29	5.383	30	5.642	31	5.313	32	5.649
33	5.722	34	5.664	35	5.561	36	5.594
37	5.266	38	5.334	39	5.685	40	5.701
41	5.437	42	5.544	43	5.332	44	5.603
45	5.465	46	5.379	47	5.579	48	5.262
49	5.250	50	5.724	51	5.283	52	5.291
53	5.587	54	5.391	55	5.329	56	5.382
57	5.372	58	5.645	59	5.455	60	5.596
61	5.422	62	5.251	63	5.609	64	5.559
65	5.497	66	5.253	67	5.545	68	5.438
69	5.488	70	5.697	71	5.503	72	5.348
73	5.583	74	5.390	75	5.647	76	5.377
77	5.535	78	5.298	79	5.556	80	5.571
81	5.644	82	5.625	83	5.490	84	5.610
85	5.592	86	5.426	87	5.280	88	5.591
89	5.305	90	5.564	91	5.721	92	5.285
93	5.526	94	5.315	95	5.698	96	5.624
97	5.258	98	5.505	99	5.606	100	5.516

Hopping Frequency Sequence Name: HOP_FREQ_SEQ_25

SEQ#	Frequency (GHz)	SEQ#	Frequency (GHz)	SEQ#	Frequency (GHz)	SEQ#	Frequency (GHz)
1	5.337	2	5.639	3	5.406	4	5.583
5	5.403	6	5.551	7	5.705	8	5.571
9	5.488	10	5.253	11	5.519	12	5.369
13	5.575	14	5.445	15	5.511	16	5.419
17	5.619	18	5.261	19	5.473	20	5.710
21	5.580	22	5.657	23	5.446	24	5.508
25	5.355	26	5.634	27	5.334	28	5.460
29	5.648	30	5.546	31	5.608	32	5.674
33	5.534	34	5.723	35	5.256	36	5.629
37	5.459	38	5.352	39	5.293	40	5.517
41	5.322	42	5.467	43	5.557	44	5.672
45	5.703	46	5.415	47	5.296	48	5.547
49	5.435	50	5.465	51	5.260	52	5.282
53	5.374	54	5.430	55	5.494	56	5.640
57	5.268	58	5.432	59	5.392	60	5.307
61	5.393	62	5.344	63	5.416	64	5.285
65	5.638	66	5.597	67	5.516	68	5.690
69	5.449	70	5.504	71	5.572	72	5.669
73	5.594	74	5.532	75	5.628	76	5.673
77	5.448	78	5.537	79	5.326	80	5.266
81	5.697	82	5.522	83	5.678	84	5.655
85	5.422	86	5.317	87	5.602	88	5.264
89	5.589	90	5.627	91	5.491	92	5.701
93	5.436	94	5.680	95	5.478	96	5.558
97	5.320	98	5.662	99	5.525	100	5.434

Hopping Frequency Sequence Name: HOP_FREQ_SEQ_26

SEQ#	Frequency (GHz)	SEQ#	Frequency (GHz)	SEQ#	Frequency (GHz)	SEQ#	Frequency (GHz)
1	5.518	2	5.489	3	5.280	4	5.598
5	5.417	6	5.447	7	5.418	8	5.400
9	5.674	10	5.631	11	5.668	12	5.577
13	5.654	14	5.251	15	5.570	16	5.649
17	5.318	18	5.373	19	5.558	20	5.544
21	5.331	22	5.695	23	5.395	24	5.628
25	5.551	26	5.338	27	5.678	28	5.375
29	5.448	30	5.254	31	5.693	32	5.273
33	5.501	34	5.596	35	5.406	36	5.295
37	5.253	38	5.430	39	5.315	40	5.650
41	5.565	42	5.504	43	5.533	44	5.664
45	5.547	46	5.307	47	5.385	48	5.561
49	5.521	50	5.303	51	5.383	52	5.525
53	5.300	54	5.641	55	5.613	56	5.291
57	5.614	58	5.588	59	5.365	60	5.294
61	5.600	62	5.445	63	5.387	64	5.468
65	5.405	66	5.429	67	5.450	68	5.288
69	5.462	70	5.464	71	5.443	72	5.659
73	5.344	74	5.636	75	5.611	76	5.432
77	5.341	78	5.532	79	5.420	80	5.449
81	5.284	82	5.414	83	5.724	84	5.440
85	5.556	86	5.455	87	5.499	88	5.474
89	5.481	90	5.363	91	5.478	92	5.456
93	5.264	94	5.633	95	5.589	96	5.686
97	5.538	98	5.569	99	5.524	100	5.578

Hopping Frequency Sequence Name: HOP_FREQ_SEQ_27

SEQ#	Frequency (GHz)	SEQ#	Frequency (GHz)	SEQ#	Frequency (GHz)	SEQ#	Frequency (GHz)
1	5.368	2	5.583	3	5.564	4	5.520
5	5.428	6	5.366	7	5.611	8	5.390
9	5.616	10	5.556	11	5.539	12	5.485
13	5.360	14	5.302	15	5.581	16	5.614
17	5.353	18	5.358	19	5.582	20	5.325
21	5.348	22	5.292	23	5.287	24	5.567
25	5.615	26	5.346	27	5.531	28	5.263
29	5.272	30	5.282	31	5.657	32	5.554
33	5.618	34	5.580	35	5.525	36	5.291
37	5.715	38	5.343	39	5.534	40	5.312
41	5.275	42	5.270	43	5.718	44	5.696
45	5.671	46	5.307	47	5.332	48	5.721
49	5.462	50	5.714	51	5.451	52	5.679
53	5.422	54	5.317	55	5.640	56	5.695
57	5.722	58	5.598	59	5.607	60	5.648
61	5.547	62	5.396	63	5.523	64	5.659
65	5.624	66	5.584	67	5.660	68	5.452
69	5.550	70	5.440	71	5.683	72	5.382
73	5.562	74	5.578	75	5.513	76	5.393
77	5.379	78	5.409	79	5.362	80	5.297
81	5.597	82	5.337	83	5.711	84	5.460
85	5.576	86	5.605	87	5.645	88	5.591
89	5.667	90	5.398	91	5.456	92	5.380
93	5.710	94	5.636	95	5.315	96	5.277
97	5.441	98	5.676	99	5.593	100	5.394

Hopping Frequency Sequence Name: HOP_FREQ_SEQ_28

SEQ#	Frequency (GHz)	SEQ#	Frequency (GHz)	SEQ#	Frequency (GHz)	SEQ#	Frequency (GHz)
1	5.336	2	5.506	3	5.514	4	5.286
5	5.715	6	5.452	7	5.408	8	5.722
9	5.332	10	5.606	11	5.608	12	5.630
13	5.676	14	5.547	15	5.568	16	5.436
17	5.503	18	5.344	19	5.723	20	5.331
21	5.637	22	5.454	23	5.589	24	5.517
25	5.586	26	5.474	27	5.267	28	5.686
29	5.333	30	5.540	31	5.585	32	5.678
33	5.482	34	5.549	35	5.473	36	5.695
37	5.412	38	5.600	39	5.620	40	5.272
41	5.499	42	5.424	43	5.366	44	5.594
45	5.526	46	5.625	47	5.632	48	5.572
49	5.260	50	5.463	51	5.679	52	5.444
53	5.716	54	5.388	55	5.587	56	5.592
57	5.399	58	5.327	59	5.607	60	5.529
61	5.455	62	5.554	63	5.688	64	5.534
65	5.250	66	5.295	67	5.541	68	5.402
69	5.551	70	5.595	71	5.459	72	5.516
73	5.467	74	5.544	75	5.358	76	5.393
77	5.490	78	5.656	79	5.493	80	5.639
81	5.410	82	5.494	83	5.346	84	5.304
85	5.357	86	5.616	87	5.339	88	5.316
89	5.318	90	5.510	91	5.405	92	5.697
93	5.483	94	5.535	95	5.672	96	5.645
97	5.558	98	5.284	99	5.460	100	5.519

Hopping Frequency Sequence Name: HOP_FREQ_SEQ_29

SEQ#	Frequency (GHz)	SEQ#	Frequency (GHz)	SEQ#	Frequency (GHz)	SEQ#	Frequency (GHz)
1	5.666	2	5.685	3	5.395	4	5.370
5	5.611	6	5.291	7	5.687	8	5.327
9	5.307	10	5.486	11	5.389	12	5.604
13	5.319	14	5.463	15	5.445	16	5.357
17	5.415	18	5.721	19	5.587	20	5.585
21	5.558	22	5.574	23	5.675	24	5.566
25	5.679	26	5.570	27	5.488	28	5.640
29	5.406	30	5.617	31	5.386	32	5.592
33	5.382	34	5.448	35	5.479	36	5.461
37	5.273	38	5.671	39	5.458	40	5.432
41	5.544	42	5.271	43	5.628	44	5.343
45	5.689	46	5.709	47	5.691	48	5.529
49	5.540	50	5.633	51	5.623	52	5.667
53	5.536	54	5.277	55	5.577	56	5.625
57	5.454	58	5.595	59	5.660	60	5.564
61	5.673	62	5.362	63	5.692	64	5.252
65	5.680	66	5.304	67	5.459	68	5.436
69	5.314	70	5.723	71	5.423	72	5.651
73	5.435	74	5.553	75	5.562	76	5.602
77	5.368	78	5.646	79	5.441	80	5.412
81	5.718	82	5.552	83	5.430	84	5.607
85	5.404	86	5.393	87	5.420	88	5.672
89	5.669	90	5.596	91	5.384	92	5.428
93	5.495	94	5.268	95	5.606	96	5.551
97	5.377	98	5.588	99	5.352	100	5.477

Hopping Frequency Sequence Name: HOP_FREQ_SEQ_30

SEQ#	Frequency (GHz)	SEQ#	Frequency (GHz)	SEQ#	Frequency (GHz)	SEQ#	Frequency (GHz)
1	5.458	2	5.613	3	5.717	4	5.475
5	5.607	6	5.589	7	5.417	8	5.406
9	5.298	10	5.318	11	5.710	12	5.667
13	5.351	14	5.347	15	5.300	16	5.619
17	5.309	18	5.502	19	5.578	20	5.639
21	5.573	22	5.448	23	5.462	24	5.721
25	5.389	26	5.509	27	5.414	28	5.443
29	5.262	30	5.571	31	5.558	32	5.285
33	5.529	34	5.606	35	5.419	36	5.352
37	5.566	38	5.459	39	5.304	40	5.398
41	5.339	42	5.408	43	5.281	44	5.663
45	5.690	46	5.405	47	5.335	48	5.577
49	5.491	50	5.424	51	5.411	52	5.581
53	5.715	54	5.686	55	5.267	56	5.594
57	5.277	58	5.596	59	5.457	60	5.554
61	5.388	62	5.669	63	5.474	64	5.720
65	5.453	66	5.658	67	5.500	68	5.677
69	5.358	70	5.287	71	5.338	72	5.394
73	5.609	74	5.676	75	5.353	76	5.379
77	5.616	78	5.625	79	5.257	80	5.595
81	5.588	82	5.426	83	5.556	84	5.680
85	5.373	86	5.674	87	5.350	88	5.628
89	5.423	90	5.418	91	5.260	92	5.590
93	5.392	94	5.532	95	5.478	96	5.582
97	5.562	98	5.326	99	5.548	100	5.286

802.11be (EHT40)

Hopping Frequency Sequence Name: HOP_FREQ_SEQ_01

SEQ#	Frequency (GHz)	SEQ#	Frequency (GHz)	SEQ#	Frequency (GHz)	SEQ#	Frequency (GHz)
1	5.603	2	5.405	3	5.498	4	5.670
5	5.630	6	5.712	7	5.653	8	5.285
9	5.399	10	5.541	11	5.704	12	5.323
13	5.532	14	5.366	15	5.410	16	5.581
17	5.612	18	5.467	19	5.312	20	5.554
21	5.520	22	5.551	23	5.575	24	5.448
25	5.414	26	5.598	27	5.354	28	5.708
29	5.332	30	5.288	31	5.310	32	5.456
33	5.397	34	5.361	35	5.390	36	5.380
37	5.620	38	5.652	39	5.666	40	5.457
41	5.296	42	5.631	43	5.411	44	5.470
45	5.526	46	5.472	47	5.628	48	5.375
49	5.649	50	5.656	51	5.408	52	5.393
53	5.514	54	5.348	55	5.523	56	5.709
57	5.311	58	5.284	59	5.552	60	5.427
61	5.255	62	5.395	63	5.536	64	5.626
65	5.389	66	5.297	67	5.679	68	5.545
69	5.496	70	5.617	71	5.283	72	5.508
73	5.299	74	5.319	75	5.624	76	5.440
77	5.677	78	5.643	79	5.558	80	5.252
81	5.671	82	5.378	83	5.680	84	5.547
85	5.683	86	5.453	87	5.466	88	5.471
89	5.548	90	5.356	91	5.486	92	5.684
93	5.669	94	5.349	95	5.504	96	5.641
97	5.495	98	5.578	99	5.702	100	5.706

Hopping Frequency Sequence Name: HOP_FREQ_SEQ_02

SEQ#	Frequency (GHz)	SEQ#	Frequency (GHz)	SEQ#	Frequency (GHz)	SEQ#	Frequency (GHz)
1	5.328	2	5.655	3	5.570	4	5.291
5	5.485	6	5.342	7	5.365	8	5.720
9	5.647	10	5.264	11	5.362	12	5.403
13	5.392	14	5.284	15	5.363	16	5.461
17	5.346	18	5.381	19	5.598	20	5.528
21	5.640	22	5.315	23	5.500	24	5.539
25	5.531	26	5.459	27	5.603	28	5.372
29	5.499	30	5.263	31	5.329	32	5.366
33	5.431	34	5.586	35	5.536	36	5.266
37	5.376	38	5.654	39	5.701	40	5.285
41	5.699	42	5.327	43	5.450	44	5.567
45	5.680	46	5.581	47	5.270	48	5.633
49	5.676	50	5.353	51	5.456	52	5.454
53	5.446	54	5.532	55	5.665	56	5.443
57	5.432	58	5.371	59	5.269	60	5.559
61	5.386	62	5.535	63	5.308	64	5.451
65	5.276	66	5.718	67	5.719	68	5.287
69	5.636	70	5.292	71	5.490	72	5.700
73	5.303	74	5.569	75	5.489	76	5.364
77	5.564	78	5.335	79	5.340	80	5.326
81	5.677	82	5.375	83	5.664	84	5.427
85	5.538	86	5.509	87	5.420	88	5.344
89	5.462	90	5.682	91	5.565	92	5.691
93	5.355	94	5.687	95	5.652	96	5.352
97	5.416	98	5.286	99	5.684	100	5.425

Hopping Frequency Sequence Name: HOP_FREQ_SEQ_03

SEQ#	Frequency (GHz)	SEQ#	Frequency (GHz)	SEQ#	Frequency (GHz)	SEQ#	Frequency (GHz)
1	5.715	2	5.431	3	5.262	4	5.608
5	5.436	6	5.354	7	5.555	8	5.545
9	5.322	10	5.379	11	5.513	12	5.254
13	5.468	14	5.449	15	5.470	16	5.616
17	5.287	18	5.393	19	5.560	20	5.256
21	5.689	22	5.647	23	5.707	24	5.413
25	5.364	26	5.445	27	5.485	28	5.615
29	5.566	30	5.610	31	5.359	32	5.723
33	5.629	34	5.312	35	5.296	36	5.341
37	5.400	38	5.611	39	5.475	40	5.463
41	5.625	42	5.412	43	5.573	44	5.434
45	5.457	46	5.540	47	5.264	48	5.496
49	5.706	50	5.724	51	5.597	52	5.299
53	5.324	54	5.539	55	5.455	56	5.547
57	5.542	58	5.631	59	5.367	60	5.363
61	5.601	62	5.714	63	5.590	64	5.365
65	5.578	66	5.453	67	5.416	68	5.471
69	5.698	70	5.323	71	5.605	72	5.635
73	5.537	74	5.352	75	5.339	76	5.378
77	5.317	78	5.257	79	5.717	80	5.637
81	5.654	82	5.361	83	5.511	84	5.510
85	5.380	86	5.594	87	5.699	88	5.600
89	5.648	90	5.683	91	5.671	92	5.283
93	5.684	94	5.508	95	5.337	96	5.342
97	5.617	98	5.278	99	5.398	100	5.497

Hopping Frequency Sequence Name: HOP_FREQ_SEQ_04

SEQ#	Frequency (GHz)	SEQ#	Frequency (GHz)	SEQ#	Frequency (GHz)	SEQ#	Frequency (GHz)
1	5.267	2	5.612	3	5.554	4	5.569
5	5.698	6	5.718	7	5.288	8	5.716
9	5.621	10	5.723	11	5.322	12	5.511
13	5.570	14	5.683	15	5.721	16	5.530
17	5.508	18	5.451	19	5.416	20	5.521
21	5.501	22	5.460	23	5.527	24	5.699
25	5.363	26	5.470	27	5.304	28	5.623
29	5.453	30	5.426	31	5.441	32	5.579
33	5.398	34	5.669	35	5.333	36	5.468
37	5.557	38	5.517	39	5.665	40	5.610
41	5.448	42	5.629	43	5.380	44	5.262
45	5.597	46	5.285	47	5.318	48	5.266
49	5.270	50	5.381	51	5.315	52	5.401
53	5.463	54	5.298	55	5.607	56	5.700
57	5.711	58	5.417	59	5.717	60	5.360
61	5.429	62	5.654	63	5.524	64	5.496
65	5.445	66	5.499	67	5.280	68	5.386
69	5.351	70	5.687	71	5.584	72	5.356
73	5.661	74	5.589	75	5.663	76	5.657
77	5.478	78	5.659	79	5.389	80	5.513
81	5.555	82	5.458	83	5.502	84	5.420
85	5.549	86	5.690	87	5.641	88	5.648
89	5.452	90	5.473	91	5.542	92	5.588
93	5.632	94	5.439	95	5.250	96	5.348
97	5.466	98	5.541	99	5.481	100	5.562

Hopping Frequency Sequence Name: HOP_FREQ_SEQ_05

SEQ#	Frequency (GHz)	SEQ#	Frequency (GHz)	SEQ#	Frequency (GHz)	SEQ#	Frequency (GHz)
1	5.538	2	5.423	3	5.481	4	5.307
5	5.357	6	5.593	7	5.615	8	5.404
9	5.711	10	5.490	11	5.550	12	5.416
13	5.519	14	5.541	15	5.339	16	5.612
17	5.699	18	5.653	19	5.350	20	5.369
21	5.373	22	5.656	23	5.672	24	5.688
25	5.403	26	5.522	27	5.665	28	5.675
29	5.297	30	5.402	31	5.588	32	5.673
33	5.421	34	5.512	35	5.537	36	5.715
37	5.299	38	5.686	39	5.263	40	5.679
41	5.391	42	5.313	43	5.480	44	5.561
45	5.523	46	5.389	47	5.692	48	5.569
49	5.556	50	5.578	51	5.425	52	5.517
53	5.475	54	5.532	55	5.255	56	5.375
57	5.349	58	5.436	59	5.424	60	5.271
61	5.390	62	5.585	63	5.652	64	5.486
65	5.722	66	5.280	67	5.554	68	5.514
69	5.587	70	5.683	71	5.321	72	5.547
73	5.590	74	5.432	75	5.548	76	5.657
77	5.279	78	5.693	79	5.671	80	5.539
81	5.438	82	5.301	83	5.544	84	5.670
85	5.346	86	5.463	87	5.394	88	5.567
89	5.526	90	5.434	91	5.467	92	5.611
93	5.295	94	5.647	95	5.602	96	5.318
97	5.714	98	5.649	99	5.695	100	5.630

Hopping Frequency Sequence Name: HOP_FREQ_SEQ_06

SEQ#	Frequency (GHz)	SEQ#	Frequency (GHz)	SEQ#	Frequency (GHz)	SEQ#	Frequency (GHz)
1	5.527	2	5.604	3	5.380	4	5.393
5	5.280	6	5.665	7	5.273	8	5.473
9	5.566	10	5.647	11	5.694	12	5.645
13	5.528	14	5.359	15	5.369	16	5.564
17	5.497	18	5.669	19	5.508	20	5.459
21	5.342	22	5.563	23	5.531	24	5.605
25	5.322	26	5.436	27	5.394	28	5.611
29	5.295	30	5.441	31	5.622	32	5.469
33	5.652	34	5.638	35	5.308	36	5.375
37	5.374	38	5.309	39	5.439	40	5.626
41	5.688	42	5.345	43	5.514	44	5.646
45	5.602	46	5.666	47	5.254	48	5.271
49	5.347	50	5.470	51	5.408	52	5.700
53	5.467	54	5.480	55	5.337	56	5.673
57	5.506	58	5.417	59	5.512	60	5.348
61	5.317	62	5.621	63	5.368	64	5.557
65	5.722	66	5.266	67	5.363	68	5.678
69	5.305	70	5.485	71	5.352	72	5.668
73	5.720	74	5.509	75	5.403	76	5.460
77	5.351	78	5.556	79	5.259	80	5.629
81	5.454	82	5.723	83	5.291	84	5.356
85	5.496	86	5.681	87	5.376	88	5.689
89	5.461	90	5.711	91	5.381	92	5.279
93	5.267	94	5.533	95	5.367	96	5.361
97	5.468	98	5.389	99	5.261	100	5.357

Hopping Frequency Sequence Name: HOP_FREQ_SEQ_07

SEQ#	Frequency (GHz)	SEQ#	Frequency (GHz)	SEQ#	Frequency (GHz)	SEQ#	Frequency (GHz)
1	5.273	2	5.275	3	5.630	4	5.277
5	5.532	6	5.396	7	5.342	8	5.379
9	5.283	10	5.475	11	5.423	12	5.571
13	5.516	14	5.382	15	5.467	16	5.429
17	5.537	18	5.386	19	5.678	20	5.544
21	5.657	22	5.527	23	5.340	24	5.470
25	5.440	26	5.332	27	5.406	28	5.373
29	5.299	30	5.385	31	5.314	32	5.255
33	5.503	34	5.507	35	5.335	36	5.476
37	5.310	38	5.383	39	5.337	40	5.518
41	5.464	42	5.674	43	5.560	44	5.322
45	5.631	46	5.446	47	5.270	48	5.708
49	5.590	50	5.365	51	5.591	52	5.706
53	5.318	54	5.402	55	5.703	56	5.662
57	5.457	58	5.414	59	5.278	60	5.308
61	5.569	62	5.407	63	5.426	64	5.376
65	5.321	66	5.384	67	5.381	68	5.542
69	5.558	70	5.472	71	5.684	72	5.553
73	5.306	74	5.401	75	5.715	76	5.458
77	5.575	78	5.654	79	5.352	80	5.671
81	5.710	82	5.479	83	5.690	84	5.297
85	5.528	86	5.276	87	5.368	88	5.585
89	5.596	90	5.353	91	5.681	92	5.442
93	5.266	94	5.268	95	5.291	96	5.615
97	5.416	98	5.699	99	5.663	100	5.293

Hopping Frequency Sequence Name: HOP_FREQ_SEQ_08

SEQ#	Frequency (GHz)	SEQ#	Frequency (GHz)	SEQ#	Frequency (GHz)	SEQ#	Frequency (GHz)
1	5.706	2	5.662	3	5.360	4	5.585
5	5.609	6	5.471	7	5.569	8	5.485
9	5.292	10	5.673	11	5.486	12	5.626
13	5.430	14	5.563	15	5.659	16	5.287
17	5.687	18	5.719	19	5.616	20	5.668
21	5.621	22	5.591	23	5.329	24	5.558
25	5.540	26	5.623	27	5.393	28	5.712
29	5.689	30	5.370	31	5.451	32	5.545
33	5.448	34	5.394	35	5.588	36	5.633
37	5.561	38	5.418	39	5.522	40	5.707
41	5.480	42	5.414	43	5.491	44	5.312
45	5.704	46	5.317	47	5.291	48	5.319
49	5.321	50	5.681	51	5.273	52	5.473
53	5.547	54	5.457	55	5.404	56	5.456
57	5.296	58	5.299	59	5.358	60	5.684
61	5.705	62	5.581	63	5.355	64	5.592
65	5.575	66	5.436	67	5.284	68	5.381
69	5.542	70	5.388	71	5.267	72	5.254
73	5.643	74	5.257	75	5.618	76	5.332
77	5.560	78	5.647	79	5.362	80	5.677
81	5.670	82	5.651	83	5.656	84	5.425
85	5.584	86	5.612	87	5.379	88	5.368
89	5.600	90	5.489	91	5.657	92	5.357
93	5.263	94	5.277	95	5.583	96	5.555
97	5.307	98	5.658	99	5.286	100	5.487

Hopping Frequency Sequence Name: HOP_FREQ_SEQ_09

SEQ#	Frequency (GHz)	SEQ#	Frequency (GHz)	SEQ#	Frequency (GHz)	SEQ#	Frequency (GHz)
1	5.358	2	5.423	3	5.255	4	5.380
5	5.477	6	5.387	7	5.724	8	5.629
9	5.466	10	5.254	11	5.611	12	5.379
13	5.395	14	5.702	15	5.508	16	5.543
17	5.261	18	5.360	19	5.696	20	5.411
21	5.394	22	5.460	23	5.592	24	5.528
25	5.692	26	5.449	27	5.281	28	5.285
29	5.279	30	5.558	31	5.348	32	5.496
33	5.418	34	5.647	35	5.661	36	5.517
37	5.607	38	5.359	39	5.636	40	5.650
41	5.559	42	5.642	43	5.713	44	5.274
45	5.322	46	5.604	47	5.667	48	5.674
49	5.564	50	5.414	51	5.627	52	5.489
53	5.431	54	5.298	55	5.439	56	5.353
57	5.339	58	5.398	59	5.457	60	5.497
61	5.511	62	5.390	63	5.710	64	5.407
65	5.334	66	5.609	67	5.665	68	5.263
69	5.706	70	5.259	71	5.484	72	5.479
73	5.381	74	5.693	75	5.341	76	5.351
77	5.614	78	5.566	79	5.422	80	5.475
81	5.467	82	5.386	83	5.492	84	5.705
85	5.504	86	5.399	87	5.286	88	5.610
89	5.267	90	5.670	91	5.646	92	5.265
93	5.486	94	5.635	95	5.615	96	5.608
97	5.633	98	5.514	99	5.723	100	5.372

Hopping Frequency Sequence Name: HOP_FREQ_SEQ_10

SEQ#	Frequency (GHz)	SEQ#	Frequency (GHz)	SEQ#	Frequency (GHz)	SEQ#	Frequency (GHz)
1	5.597	2	5.266	3	5.337	4	5.578
5	5.512	6	5.712	7	5.553	8	5.671
9	5.628	10	5.713	11	5.392	12	5.346
13	5.681	14	5.520	15	5.356	16	5.488
17	5.257	18	5.393	19	5.458	20	5.605
21	5.297	22	5.287	23	5.637	24	5.710
25	5.505	26	5.549	27	5.455	28	5.385
29	5.344	30	5.402	31	5.534	32	5.452
33	5.404	34	5.461	35	5.363	36	5.322
37	5.309	38	5.638	39	5.299	40	5.445
41	5.368	42	5.288	43	5.624	44	5.516
45	5.298	46	5.548	47	5.694	48	5.685
49	5.716	50	5.500	51	5.618	52	5.431
53	5.286	54	5.547	55	5.328	56	5.351
57	5.595	58	5.253	59	5.723	60	5.350
61	5.613	62	5.542	63	5.325	64	5.255
65	5.433	66	5.469	67	5.539	68	5.420
69	5.487	70	5.345	71	5.634	72	5.483
73	5.606	74	5.722	75	5.399	76	5.386
77	5.342	78	5.459	79	5.689	80	5.658
81	5.599	82	5.557	83	5.478	84	5.477
85	5.603	86	5.473	87	5.410	88	5.540
89	5.446	90	5.443	91	5.623	92	5.550
93	5.616	94	5.670	95	5.376	96	5.341
97	5.412	98	5.596	99	5.693	100	5.347

Hopping Frequency Sequence Name: HOP_FREQ_SEQ_11

SEQ#	Frequency (GHz)	SEQ#	Frequency (GHz)	SEQ#	Frequency (GHz)	SEQ#	Frequency (GHz)
1	5.481	2	5.267	3	5.677	4	5.358
5	5.424	6	5.457	7	5.486	8	5.285
9	5.455	10	5.632	11	5.637	12	5.679
13	5.534	14	5.651	15	5.341	16	5.376
17	5.580	18	5.705	19	5.505	20	5.438
21	5.610	22	5.606	23	5.682	24	5.578
25	5.627	26	5.674	27	5.410	28	5.370
29	5.631	30	5.475	31	5.514	32	5.694
33	5.405	34	5.555	35	5.659	36	5.420
37	5.533	38	5.575	39	5.508	40	5.266
41	5.471	42	5.657	43	5.392	44	5.339
45	5.562	46	5.348	47	5.497	48	5.278
49	5.628	50	5.643	51	5.292	52	5.528
53	5.595	54	5.450	55	5.461	56	5.387
57	5.665	58	5.257	59	5.454	60	5.301
61	5.540	62	5.571	63	5.391	64	5.568
65	5.343	66	5.347	67	5.565	68	5.718
69	5.646	70	5.488	71	5.608	72	5.710
73	5.569	74	5.377	75	5.408	76	5.572
77	5.626	78	5.666	79	5.412	80	5.284
81	5.473	82	5.459	83	5.402	84	5.416
85	5.480	86	5.525	87	5.413	88	5.519
89	5.375	90	5.602	91	5.640	92	5.478
93	5.418	94	5.653	95	5.681	96	5.421
97	5.638	98	5.714	99	5.536	100	5.673

Hopping Frequency Sequence Name: HOP_FREQ_SEQ_12

SEQ#	Frequency (GHz)	SEQ#	Frequency (GHz)	SEQ#	Frequency (GHz)	SEQ#	Frequency (GHz)
1	5.585	2	5.257	3	5.621	4	5.720
5	5.611	6	5.538	7	5.556	8	5.427
9	5.657	10	5.628	11	5.508	12	5.367
13	5.291	14	5.341	15	5.300	16	5.485
17	5.630	18	5.648	19	5.697	20	5.378
21	5.386	22	5.711	23	5.584	24	5.350
25	5.365	26	5.337	27	5.501	28	5.272
29	5.463	30	5.420	31	5.668	32	5.283
33	5.323	34	5.640	35	5.629	36	5.502
37	5.612	38	5.329	39	5.469	40	5.701
41	5.588	42	5.295	43	5.418	44	5.683
45	5.315	46	5.573	47	5.517	48	5.592
49	5.387	50	5.311	51	5.595	52	5.580
53	5.445	54	5.381	55	5.318	56	5.523
57	5.271	58	5.705	59	5.712	60	5.669
61	5.715	62	5.507	63	5.623	64	5.491
65	5.515	66	5.604	67	5.267	68	5.368
69	5.625	70	5.714	71	5.581	72	5.407
73	5.665	74	5.475	75	5.616	76	5.276
77	5.474	78	5.716	79	5.423	80	5.302
81	5.410	82	5.496	83	5.471	84	5.413
85	5.339	86	5.565	87	5.266	88	5.352
89	5.521	90	5.275	91	5.652	92	5.653
93	5.601	94	5.593	95	5.681	96	5.656
97	5.476	98	5.498	99	5.348	100	5.446

Hopping Frequency Sequence Name: HOP_FREQ_SEQ_13

SEQ#	Frequency (GHz)	SEQ#	Frequency (GHz)	SEQ#	Frequency (GHz)	SEQ#	Frequency (GHz)
1	5.303	2	5.525	3	5.524	4	5.392
5	5.396	6	5.518	7	5.534	8	5.685
9	5.573	10	5.406	11	5.468	12	5.389
13	5.492	14	5.341	15	5.585	16	5.540
17	5.323	18	5.653	19	5.652	20	5.269
21	5.460	22	5.387	23	5.443	24	5.424
25	5.643	26	5.678	27	5.312	28	5.526
29	5.675	30	5.626	31	5.515	32	5.668
33	5.495	34	5.611	35	5.633	36	5.408
37	5.344	38	5.305	39	5.493	40	5.623
41	5.717	42	5.411	43	5.569	44	5.516
45	5.478	46	5.538	47	5.673	48	5.255
49	5.566	50	5.340	51	5.512	52	5.463
53	5.561	54	5.661	55	5.624	56	5.713
57	5.256	58	5.533	59	5.322	60	5.503
61	5.487	62	5.394	63	5.638	64	5.436
65	5.311	66	5.635	67	5.298	68	5.284
69	5.375	70	5.336	71	5.694	72	5.456
73	5.295	74	5.577	75	5.605	76	5.625
77	5.417	78	5.592	79	5.437	80	5.627
81	5.629	82	5.388	83	5.414	84	5.264
85	5.572	86	5.701	87	5.360	88	5.508
89	5.689	90	5.266	91	5.707	92	5.543
93	5.671	94	5.632	95	5.596	96	5.407
97	5.510	98	5.612	99	5.337	100	5.576

Hopping Frequency Sequence Name: HOP_FREQ_SEQ_14

SEQ#	Frequency (GHz)	SEQ#	Frequency (GHz)	SEQ#	Frequency (GHz)	SEQ#	Frequency (GHz)
1	5.320	2	5.569	3	5.430	4	5.515
5	5.378	6	5.686	7	5.418	8	5.682
9	5.367	10	5.715	11	5.444	12	5.405
13	5.695	14	5.421	15	5.574	16	5.293
17	5.266	18	5.450	19	5.462	20	5.524
21	5.499	22	5.520	23	5.455	24	5.270
25	5.345	26	5.560	27	5.466	28	5.491
29	5.498	30	5.602	31	5.274	32	5.550
33	5.393	34	5.454	35	5.268	36	5.590
37	5.608	38	5.424	39	5.600	40	5.276
41	5.305	42	5.374	43	5.588	44	5.662
45	5.541	46	5.516	47	5.463	48	5.677
49	5.555	50	5.540	51	5.649	52	5.484
53	5.639	54	5.641	55	5.655	56	5.316
57	5.678	58	5.357	59	5.547	60	5.269
61	5.397	62	5.318	63	5.302	64	5.596
65	5.411	66	5.538	67	5.568	68	5.626
69	5.694	70	5.671	71	5.323	72	5.267
73	5.693	74	5.643	75	5.443	76	5.598
77	5.502	78	5.528	79	5.341	80	5.445
81	5.691	82	5.353	83	5.368	84	5.575
85	5.344	86	5.440	87	5.489	88	5.501
89	5.292	90	5.355	91	5.534	92	5.642
93	5.423	94	5.545	95	5.470	96	5.409
97	5.425	98	5.612	99	5.651	100	5.688

Hopping Frequency Sequence Name: HOP_FREQ_SEQ_15

SEQ#	Frequency (GHz)	SEQ#	Frequency (GHz)	SEQ#	Frequency (GHz)	SEQ#	Frequency (GHz)
1	5.679	2	5.438	3	5.375	4	5.447
5	5.698	6	5.642	7	5.366	8	5.662
9	5.653	10	5.250	11	5.299	12	5.427
13	5.303	14	5.277	15	5.283	16	5.574
17	5.720	18	5.279	19	5.455	20	5.470
21	5.638	22	5.639	23	5.323	24	5.643
25	5.619	26	5.575	27	5.633	28	5.710
29	5.411	30	5.645	31	5.712	32	5.510
33	5.604	34	5.680	35	5.284	36	5.357
37	5.397	38	5.322	39	5.294	40	5.681
41	5.555	42	5.523	43	5.591	44	5.593
45	5.392	46	5.342	47	5.401	48	5.255
49	5.363	50	5.345	51	5.348	52	5.281
53	5.449	54	5.319	55	5.671	56	5.498
57	5.558	58	5.350	59	5.464	60	5.405
61	5.717	62	5.317	63	5.669	64	5.526
65	5.530	66	5.597	67	5.329	68	5.508
69	5.270	70	5.552	71	5.634	72	5.355
73	5.646	74	5.461	75	5.516	76	5.380
77	5.263	78	5.387	79	5.306	80	5.341
81	5.605	82	5.606	83	5.687	84	5.637
85	5.362	86	5.325	87	5.305	88	5.326
89	5.688	90	5.390	91	5.477	92	5.567
93	5.320	94	5.651	95	5.499	96	5.721
97	5.296	98	5.410	99	5.673	100	5.586

Hopping Frequency Sequence Name: HOP_FREQ_SEQ_16

SEQ#	Frequency (GHz)	SEQ#	Frequency (GHz)	SEQ#	Frequency (GHz)	SEQ#	Frequency (GHz)
1	5.426	2	5.604	3	5.396	4	5.259
5	5.410	6	5.543	7	5.666	8	5.395
9	5.569	10	5.340	11	5.348	12	5.690
13	5.679	14	5.628	15	5.515	16	5.588
17	5.436	18	5.547	19	5.555	20	5.385
21	5.456	22	5.563	23	5.499	24	5.573
25	5.526	26	5.264	27	5.521	28	5.528
29	5.334	30	5.363	31	5.470	32	5.386
33	5.275	34	5.693	35	5.493	36	5.427
37	5.665	38	5.446	39	5.681	40	5.382
41	5.336	42	5.416	43	5.447	44	5.390
45	5.278	46	5.685	47	5.263	48	5.342
49	5.345	50	5.343	51	5.497	52	5.653
53	5.417	54	5.309	55	5.509	56	5.579
57	5.441	58	5.684	59	5.397	60	5.341
61	5.372	62	5.315	63	5.554	64	5.540
65	5.546	66	5.268	67	5.299	68	5.561
69	5.317	70	5.656	71	5.318	72	5.703
73	5.516	74	5.544	75	5.454	76	5.414
77	5.273	78	5.574	79	5.535	80	5.380
81	5.457	82	5.595	83	5.548	84	5.466
85	5.672	86	5.271	87	5.486	88	5.650
89	5.490	90	5.699	91	5.381	92	5.581
93	5.276	94	5.550	95	5.487	96	5.402
97	5.257	98	5.406	99	5.323	100	5.371

Hopping Frequency Sequence Name: HOP_FREQ_SEQ_17

SEQ#	Frequency (GHz)	SEQ#	Frequency (GHz)	SEQ#	Frequency (GHz)	SEQ#	Frequency (GHz)
1	5.421	2	5.452	3	5.547	4	5.598
5	5.335	6	5.378	7	5.572	8	5.279
9	5.419	10	5.605	11	5.553	12	5.461
13	5.406	14	5.397	15	5.293	16	5.401
17	5.435	18	5.596	19	5.683	20	5.352
21	5.480	22	5.416	23	5.575	24	5.543
25	5.708	26	5.449	27	5.652	28	5.372
29	5.661	30	5.483	31	5.588	32	5.315
33	5.251	34	5.611	35	5.667	36	5.264
37	5.283	38	5.339	39	5.592	40	5.363
41	5.629	42	5.594	43	5.518	44	5.674
45	5.573	46	5.531	47	5.323	48	5.405
49	5.353	50	5.617	51	5.468	52	5.671
53	5.695	54	5.269	55	5.515	56	5.580
57	5.649	58	5.673	59	5.299	60	5.644
61	5.509	62	5.650	63	5.500	64	5.467
65	5.344	66	5.614	67	5.538	68	5.622
69	5.645	70	5.721	71	5.368	72	5.627
73	5.260	74	5.620	75	5.601	76	5.356
77	5.413	78	5.340	79	5.451	80	5.697
81	5.643	82	5.519	83	5.444	84	5.578
85	5.624	86	5.556	87	5.551	88	5.355
89	5.677	90	5.439	91	5.548	92	5.338
93	5.277	94	5.387	95	5.252	96	5.311
97	5.651	98	5.599	99	5.574	100	5.600

Hopping Frequency Sequence Name: HOP_FREQ_SEQ_18

SEQ#	Frequency (GHz)	SEQ#	Frequency (GHz)	SEQ#	Frequency (GHz)	SEQ#	Frequency (GHz)
1	5.487	2	5.444	3	5.562	4	5.715
5	5.662	6	5.308	7	5.379	8	5.453
9	5.368	10	5.629	11	5.514	12	5.329
13	5.538	14	5.356	15	5.588	16	5.391
17	5.413	18	5.700	19	5.381	20	5.618
21	5.455	22	5.558	23	5.352	24	5.582
25	5.283	26	5.709	27	5.542	28	5.394
29	5.663	30	5.689	31	5.288	32	5.262
33	5.370	34	5.371	35	5.577	36	5.702
37	5.299	38	5.465	39	5.325	40	5.503
41	5.312	42	5.549	43	5.451	44	5.314
45	5.319	46	5.274	47	5.682	48	5.388
49	5.546	50	5.513	51	5.474	52	5.713
53	5.260	54	5.251	55	5.722	56	5.408
57	5.625	58	5.392	59	5.418	60	5.389
61	5.492	62	5.668	63	5.697	64	5.482
65	5.300	66	5.647	67	5.599	68	5.494
69	5.571	70	5.348	71	5.460	72	5.716
73	5.551	74	5.327	75	5.366	76	5.509
77	5.600	78	5.406	79	5.622	80	5.495
81	5.712	82	5.404	83	5.421	84	5.464
85	5.393	86	5.470	87	5.676	88	5.617
89	5.594	90	5.637	91	5.425	92	5.691
93	5.278	94	5.410	95	5.486	96	5.632
97	5.653	98	5.400	99	5.572	100	5.426

Hopping Frequency Sequence Name: HOP_FREQ_SEQ_19

SEQ#	Frequency (GHz)	SEQ#	Frequency (GHz)	SEQ#	Frequency (GHz)	SEQ#	Frequency (GHz)
1	5.329	2	5.351	3	5.639	4	5.713
5	5.256	6	5.715	7	5.672	8	5.430
9	5.291	10	5.665	11	5.459	12	5.427
13	5.693	14	5.462	15	5.571	16	5.573
17	5.474	18	5.262	19	5.596	20	5.287
21	5.327	22	5.341	23	5.326	24	5.701
25	5.457	26	5.576	27	5.681	28	5.620
29	5.325	30	5.671	31	5.543	32	5.720
33	5.521	34	5.360	35	5.485	36	5.509
37	5.408	38	5.334	39	5.555	40	5.315
41	5.417	42	5.694	43	5.623	44	5.654
45	5.253	46	5.499	47	5.544	48	5.293
49	5.708	50	5.372	51	5.366	52	5.520
53	5.302	54	5.711	55	5.590	56	5.477
57	5.349	58	5.712	59	5.305	60	5.281
61	5.383	62	5.467	63	5.397	64	5.388
65	5.527	66	5.540	67	5.651	68	5.511
69	5.386	70	5.370	71	5.580	72	5.517
73	5.684	74	5.519	75	5.435	76	5.444
77	5.535	78	5.298	79	5.699	80	5.554
81	5.514	82	5.319	83	5.473	84	5.348
85	5.705	86	5.594	87	5.323	88	5.484
89	5.506	90	5.714	91	5.411	92	5.359
93	5.421	94	5.487	95	5.258	96	5.312
97	5.491	98	5.269	99	5.320	100	5.641

Hopping Frequency Sequence Name: HOP_FREQ_SEQ_20

SEQ#	Frequency (GHz)	SEQ#	Frequency (GHz)	SEQ#	Frequency (GHz)	SEQ#	Frequency (GHz)
1	5.288	2	5.291	3	5.457	4	5.252
5	5.596	6	5.598	7	5.306	8	5.434
9	5.633	10	5.625	11	5.374	12	5.477
13	5.684	14	5.272	15	5.664	16	5.441
17	5.399	18	5.586	19	5.261	20	5.656
21	5.621	22	5.373	23	5.280	24	5.376
25	5.349	26	5.530	27	5.632	28	5.348
29	5.333	30	5.618	31	5.391	32	5.283
33	5.265	34	5.273	35	5.594	36	5.440
37	5.548	38	5.651	39	5.724	40	5.584
41	5.676	42	5.682	43	5.506	44	5.294
45	5.679	46	5.323	47	5.649	48	5.497
49	5.361	50	5.337	51	5.286	52	5.268
53	5.524	54	5.513	55	5.257	56	5.300
57	5.697	58	5.504	59	5.492	60	5.607
61	5.525	62	5.377	63	5.432	64	5.310
65	5.320	66	5.661	67	5.250	68	5.493
69	5.593	70	5.346	71	5.456	72	5.307
73	5.368	74	5.281	75	5.636	76	5.382
77	5.540	78	5.538	79	5.502	80	5.573
81	5.692	82	5.445	83	5.590	84	5.370
85	5.570	86	5.439	87	5.654	88	5.443
89	5.352	90	5.581	91	5.295	92	5.681
93	5.322	94	5.680	95	5.327	96	5.561
97	5.345	98	5.550	99	5.356	100	5.609

Hopping Frequency Sequence Name: HOP_FREQ_SEQ_21

SEQ#	Frequency (GHz)	SEQ#	Frequency (GHz)	SEQ#	Frequency (GHz)	SEQ#	Frequency (GHz)
1	5.269	2	5.285	3	5.400	4	5.637
5	5.564	6	5.523	7	5.255	8	5.461
9	5.563	10	5.552	11	5.625	12	5.421
13	5.531	14	5.695	15	5.271	16	5.590
17	5.484	18	5.456	19	5.352	20	5.409
21	5.672	22	5.459	23	5.292	24	5.359
25	5.486	26	5.422	27	5.650	28	5.407
29	5.633	30	5.532	31	5.720	32	5.493
33	5.357	34	5.439	35	5.472	36	5.628
37	5.442	38	5.668	39	5.343	40	5.638
41	5.466	42	5.470	43	5.585	44	5.611
45	5.471	46	5.524	47	5.307	48	5.441
49	5.398	50	5.529	51	5.545	52	5.325
53	5.641	54	5.688	55	5.657	56	5.429
57	5.302	58	5.719	59	5.687	60	5.494
61	5.328	62	5.397	63	5.475	64	5.626
65	5.693	66	5.265	67	5.608	68	5.337
69	5.485	70	5.703	71	5.554	72	5.294
73	5.505	74	5.314	75	5.324	76	5.405
77	5.355	78	5.389	79	5.649	80	5.620
81	5.259	82	5.566	83	5.645	84	5.701
85	5.510	86	5.370	87	5.539	88	5.423
89	5.342	90	5.609	91	5.384	92	5.629
93	5.369	94	5.613	95	5.718	96	5.381
97	5.424	98	5.578	99	5.568	100	5.427

Hopping Frequency Sequence Name: HOP_FREQ_SEQ_22

SEQ#	Frequency (GHz)	SEQ#	Frequency (GHz)	SEQ#	Frequency (GHz)	SEQ#	Frequency (GHz)
1	5.576	2	5.614	3	5.255	4	5.381
5	5.450	6	5.715	7	5.545	8	5.517
9	5.647	10	5.317	11	5.546	12	5.375
13	5.530	14	5.439	15	5.344	16	5.541
17	5.323	18	5.513	19	5.480	20	5.586
21	5.300	22	5.565	23	5.341	24	5.472
25	5.283	26	5.524	27	5.307	28	5.284
29	5.388	30	5.583	31	5.663	32	5.332
33	5.484	34	5.362	35	5.658	36	5.295
37	5.446	38	5.491	39	5.441	40	5.570
41	5.351	42	5.533	43	5.349	44	5.655
45	5.563	46	5.638	47	5.613	48	5.646
49	5.285	50	5.696	51	5.417	52	5.358
53	5.703	54	5.669	55	5.662	56	5.713
57	5.335	58	5.321	59	5.438	60	5.355
61	5.628	62	5.412	63	5.700	64	5.674
65	5.536	66	5.334	67	5.626	68	5.465
69	5.310	70	5.518	71	5.282	72	5.551
73	5.585	74	5.548	75	5.680	76	5.376
77	5.338	78	5.440	79	5.266	80	5.648
81	5.516	82	5.468	83	5.644	84	5.414
85	5.579	86	5.393	87	5.643	88	5.537
89	5.487	90	5.592	91	5.590	92	5.423
93	5.430	94	5.288	95	5.387	96	5.636
97	5.456	98	5.508	99	5.359	100	5.425

Hopping Frequency Sequence Name: HOP_FREQ_SEQ_23

SEQ#	Frequency (GHz)	SEQ#	Frequency (GHz)	SEQ#	Frequency (GHz)	SEQ#	Frequency (GHz)
1	5.650	2	5.457	3	5.366	4	5.672
5	5.654	6	5.255	7	5.381	8	5.432
9	5.701	10	5.639	11	5.310	12	5.598
13	5.405	14	5.576	15	5.464	16	5.529
17	5.659	18	5.278	19	5.251	20	5.525
21	5.530	22	5.528	23	5.567	24	5.486
25	5.394	26	5.690	27	5.713	28	5.315
29	5.533	30	5.614	31	5.623	32	5.395
33	5.620	34	5.308	35	5.379	36	5.281
37	5.677	38	5.304	39	5.537	40	5.364
41	5.352	42	5.339	43	5.284	44	5.456
45	5.626	46	5.632	47	5.287	48	5.592
49	5.452	50	5.470	51	5.329	52	5.388
53	5.356	54	5.585	55	5.593	56	5.283
57	5.603	58	5.361	59	5.408	60	5.717
61	5.404	62	5.298	63	5.347	64	5.332
65	5.412	66	5.697	67	5.674	68	5.263
69	5.499	70	5.372	71	5.676	72	5.609
73	5.619	74	5.468	75	5.692	76	5.577
77	5.578	78	5.268	79	5.428	80	5.552
81	5.413	82	5.482	83	5.579	84	5.662
85	5.621	86	5.572	87	5.682	88	5.625
89	5.644	90	5.279	91	5.253	92	5.652
93	5.678	94	5.360	95	5.627	96	5.270
97	5.721	98	5.261	99	5.497	100	5.441

Hopping Frequency Sequence Name: HOP_FREQ_SEQ_24

SEQ#	Frequency (GHz)	SEQ#	Frequency (GHz)	SEQ#	Frequency (GHz)	SEQ#	Frequency (GHz)
1	5.564	2	5.702	3	5.585	4	5.465
5	5.407	6	5.670	7	5.522	8	5.466
9	5.628	10	5.659	11	5.485	12	5.704
13	5.640	14	5.367	15	5.510	16	5.722
17	5.412	18	5.355	19	5.430	20	5.549
21	5.361	22	5.329	23	5.389	24	5.587
25	5.621	26	5.720	27	5.451	28	5.320
29	5.321	30	5.424	31	5.508	32	5.618
33	5.278	34	5.556	35	5.387	36	5.374
37	5.562	38	5.553	39	5.470	40	5.276
41	5.457	42	5.439	43	5.711	44	5.518
45	5.458	46	5.513	47	5.500	48	5.376
49	5.402	50	5.447	51	5.669	52	5.524
53	5.400	54	5.515	55	5.625	56	5.652
57	5.449	58	5.301	59	5.484	60	5.529
61	5.541	62	5.333	63	5.255	64	5.354
65	5.695	66	5.365	67	5.701	68	5.494
69	5.646	70	5.454	71	5.613	72	5.721
73	5.595	74	5.688	75	5.690	76	5.487
77	5.415	78	5.428	79	5.548	80	5.591
81	5.277	82	5.496	83	5.323	84	5.302
85	5.719	86	5.298	87	5.299	88	5.614
89	5.405	90	5.497	91	5.563	92	5.291
93	5.724	94	5.483	95	5.271	96	5.297
97	5.559	98	5.311	99	5.426	100	5.360

Hopping Frequency Sequence Name: HOP_FREQ_SEQ_25

SEQ#	Frequency (GHz)	SEQ#	Frequency (GHz)	SEQ#	Frequency (GHz)	SEQ#	Frequency (GHz)
1	5.336	2	5.277	3	5.619	4	5.303
5	5.685	6	5.545	7	5.356	8	5.341
9	5.471	10	5.533	11	5.724	12	5.716
13	5.267	14	5.495	15	5.253	16	5.460
17	5.600	18	5.279	19	5.333	20	5.335
21	5.566	22	5.384	23	5.718	24	5.616
25	5.598	26	5.588	27	5.722	28	5.591
29	5.621	30	5.475	31	5.366	32	5.692
33	5.681	34	5.306	35	5.595	36	5.594
37	5.673	38	5.291	39	5.400	40	5.269
41	5.426	42	5.491	43	5.281	44	5.395
45	5.515	46	5.288	47	5.519	48	5.334
49	5.711	50	5.550	51	5.464	52	5.525
53	5.377	54	5.265	55	5.452	56	5.596
57	5.297	58	5.305	59	5.565	60	5.579
61	5.345	62	5.703	63	5.719	64	5.298
65	5.541	66	5.456	67	5.282	68	5.645
69	5.421	70	5.357	71	5.351	72	5.431
73	5.674	74	5.449	75	5.576	76	5.539
77	5.264	78	5.257	79	5.439	80	5.562
81	5.493	82	5.642	83	5.668	84	5.477
85	5.450	86	5.311	87	5.544	88	5.707
89	5.402	90	5.567	91	5.442	92	5.343
93	5.720	94	5.397	95	5.665	96	5.582
97	5.405	98	5.467	99	5.444	100	5.693

Hopping Frequency Sequence Name: HOP_FREQ_SEQ_26

SEQ#	Frequency (GHz)	SEQ#	Frequency (GHz)	SEQ#	Frequency (GHz)	SEQ#	Frequency (GHz)
1	5.474	2	5.271	3	5.495	4	5.592
5	5.560	6	5.447	7	5.713	8	5.561
9	5.389	10	5.526	11	5.400	12	5.715
13	5.672	14	5.388	15	5.450	16	5.325
17	5.706	18	5.556	19	5.621	20	5.522
21	5.532	22	5.357	23	5.587	24	5.258
25	5.435	26	5.329	27	5.716	28	5.571
29	5.344	30	5.250	31	5.649	32	5.639
33	5.611	34	5.466	35	5.612	36	5.274
37	5.263	38	5.539	39	5.434	40	5.645
41	5.615	42	5.572	43	5.574	44	5.549
45	5.420	46	5.646	47	5.501	48	5.402
49	5.453	50	5.320	51	5.674	52	5.491
53	5.683	54	5.700	55	5.607	56	5.441
57	5.625	58	5.464	59	5.699	60	5.490
61	5.265	62	5.719	63	5.470	64	5.494
65	5.302	66	5.391	67	5.541	68	5.641
69	5.338	70	5.722	71	5.475	72	5.295
73	5.352	74	5.692	75	5.583	76	5.529
77	5.665	78	5.603	79	5.423	80	5.465
81	5.487	82	5.415	83	5.381	84	5.354
85	5.624	86	5.502	87	5.533	88	5.688
89	5.375	90	5.272	91	5.622	92	5.437
93	5.499	94	5.714	95	5.578	96	5.576
97	5.278	98	5.513	99	5.419	100	5.383

Hopping Frequency Sequence Name: HOP_FREQ_SEQ_27

SEQ#	Frequency (GHz)	SEQ#	Frequency (GHz)	SEQ#	Frequency (GHz)	SEQ#	Frequency (GHz)
1	5.668	2	5.412	3	5.577	4	5.421
5	5.372	6	5.376	7	5.363	8	5.645
9	5.696	10	5.596	11	5.650	12	5.587
13	5.306	14	5.691	15	5.341	16	5.256
17	5.399	18	5.429	19	5.392	20	5.632
21	5.263	22	5.466	23	5.567	24	5.265
25	5.522	26	5.661	27	5.700	28	5.511
29	5.536	30	5.326	31	5.709	32	5.695
33	5.669	34	5.523	35	5.582	36	5.580
37	5.550	38	5.277	39	5.285	40	5.557
41	5.574	42	5.461	43	5.425	44	5.551
45	5.608	46	5.261	47	5.317	48	5.260
49	5.439	50	5.562	51	5.324	52	5.414
53	5.527	54	5.497	55	5.686	56	5.259
57	5.664	58	5.590	59	5.478	60	5.404
61	5.589	62	5.607	63	5.481	64	5.689
65	5.389	66	5.640	67	5.720	68	5.697
69	5.402	70	5.452	71	5.313	72	5.717
73	5.257	74	5.287	75	5.534	76	5.553
77	5.304	78	5.684	79	5.374	80	5.390
81	5.441	82	5.506	83	5.444	84	5.329
85	5.250	86	5.503	87	5.588	88	5.442
89	5.611	90	5.561	91	5.406	92	5.663
93	5.297	94	5.619	95	5.405	96	5.677
97	5.501	98	5.508	99	5.262	100	5.474

Hopping Frequency Sequence Name: HOP_FREQ_SEQ_28

SEQ#	Frequency (GHz)	SEQ#	Frequency (GHz)	SEQ#	Frequency (GHz)	SEQ#	Frequency (GHz)
1	5.307	2	5.649	3	5.482	4	5.315
5	5.443	6	5.285	7	5.390	8	5.326
9	5.654	10	5.581	11	5.263	12	5.687
13	5.679	14	5.486	15	5.279	16	5.680
17	5.387	18	5.608	19	5.487	20	5.724
21	5.683	22	5.430	23	5.436	24	5.320
25	5.281	26	5.257	27	5.539	28	5.255
29	5.622	30	5.359	31	5.251	32	5.418
33	5.456	34	5.569	35	5.628	36	5.643
37	5.301	38	5.488	39	5.338	40	5.584
41	5.685	42	5.503	43	5.411	44	5.697
45	5.574	46	5.558	47	5.468	48	5.355
49	5.478	50	5.549	51	5.283	52	5.648
53	5.695	54	5.371	55	5.304	56	5.705
57	5.722	58	5.349	59	5.453	60	5.591
61	5.678	62	5.401	63	5.284	64	5.481
65	5.381	66	5.644	67	5.422	68	5.590
69	5.547	70	5.458	71	5.274	72	5.446
73	5.523	74	5.391	75	5.719	76	5.296
77	5.521	78	5.286	79	5.435	80	5.336
81	5.619	82	5.668	83	5.565	84	5.343
85	5.434	86	5.356	87	5.374	88	5.278
89	5.449	90	5.660	91	5.544	92	5.363
93	5.604	94	5.314	95	5.499	96	5.531
97	5.322	98	5.347	99	5.675	100	5.273

Hopping Frequency Sequence Name: HOP_FREQ_SEQ_29

SEQ#	Frequency (GHz)	SEQ#	Frequency (GHz)	SEQ#	Frequency (GHz)	SEQ#	Frequency (GHz)
1	5.587	2	5.271	3	5.622	4	5.676
5	5.627	6	5.604	7	5.309	8	5.666
9	5.449	10	5.613	11	5.340	12	5.579
13	5.372	14	5.263	15	5.252	16	5.665
17	5.568	18	5.386	19	5.639	20	5.480
21	5.251	22	5.270	23	5.614	24	5.698
25	5.549	26	5.451	27	5.335	28	5.685
29	5.464	30	5.424	31	5.291	32	5.400
33	5.555	34	5.530	35	5.510	36	5.278
37	5.257	38	5.595	39	5.724	40	5.645
41	5.675	42	5.317	43	5.695	44	5.722
45	5.277	46	5.522	47	5.686	48	5.597
49	5.588	50	5.517	51	5.518	52	5.707
53	5.431	54	5.364	55	5.542	56	5.513
57	5.322	58	5.405	59	5.402	60	5.560
61	5.677	62	5.492	63	5.446	64	5.268
65	5.717	66	5.459	67	5.357	68	5.655
69	5.650	70	5.314	71	5.688	72	5.528
73	5.535	74	5.715	75	5.380	76	5.648
77	5.556	78	5.531	79	5.616	80	5.586
81	5.612	82	5.435	83	5.656	84	5.659
85	5.546	86	5.407	87	5.346	88	5.516
89	5.623	90	5.634	91	5.325	92	5.420
93	5.720	94	5.558	95	5.478	96	5.644
97	5.311	98	5.607	99	5.273	100	5.444

Hopping Frequency Sequence Name: HOP_FREQ_SEQ_30

SEQ#	Frequency (GHz)	SEQ#	Frequency (GHz)	SEQ#	Frequency (GHz)	SEQ#	Frequency (GHz)
1	5.490	2	5.296	3	5.458	4	5.553
5	5.430	6	5.516	7	5.414	8	5.618
9	5.521	10	5.544	11	5.721	12	5.438
13	5.311	14	5.677	15	5.386	16	5.382
17	5.600	18	5.446	19	5.549	20	5.422
21	5.291	22	5.581	23	5.316	24	5.359
25	5.637	26	5.588	27	5.612	28	5.288
29	5.455	30	5.541	31	5.385	32	5.557
33	5.413	34	5.701	35	5.515	36	5.254
37	5.459	38	5.714	39	5.502	40	5.528
41	5.536	42	5.260	43	5.614	44	5.451
45	5.663	46	5.532	47	5.273	48	5.482
49	5.689	50	5.326	51	5.578	52	5.537
53	5.266	54	5.387	55	5.299	56	5.513
57	5.355	58	5.297	59	5.569	60	5.262
61	5.699	62	5.551	63	5.648	64	5.679
65	5.389	66	5.607	67	5.450	68	5.421
69	5.571	70	5.629	71	5.345	72	5.623
73	5.380	74	5.643	75	5.656	76	5.500
77	5.664	78	5.550	79	5.554	80	5.269
81	5.435	82	5.442	83	5.715	84	5.284
85	5.277	86	5.582	87	5.460	88	5.412
89	5.638	90	5.354	91	5.265	92	5.323
93	5.585	94	5.539	95	5.711	96	5.390
97	5.697	98	5.619	99	5.552	100	5.650

802.11be (EHT80)

Hopping Frequency Sequence Name: HOP_FREQ_SEQ_01

SEQ#	Frequency (GHz)	SEQ#	Frequency (GHz)	SEQ#	Frequency (GHz)	SEQ#	Frequency (GHz)
1	5.540	2	5.513	3	5.526	4	5.574
5	5.501	6	5.717	7	5.590	8	5.373
9	5.338	10	5.534	11	5.388	12	5.493
13	5.447	14	5.554	15	5.593	16	5.566
17	5.688	18	5.715	19	5.350	20	5.713
21	5.404	22	5.374	23	5.571	24	5.420
25	5.588	26	5.277	27	5.407	28	5.610
29	5.278	30	5.710	31	5.366	32	5.301
33	5.666	34	5.551	35	5.531	36	5.339
37	5.410	38	5.303	39	5.267	40	5.538
41	5.327	42	5.701	43	5.358	44	5.581
45	5.408	46	5.584	47	5.477	48	5.357
49	5.703	50	5.376	51	5.683	52	5.413
53	5.662	54	5.423	55	5.632	56	5.668
57	5.619	58	5.281	59	5.429	60	5.289
61	5.306	62	5.337	63	5.596	64	5.286
65	5.592	66	5.379	67	5.362	68	5.351
69	5.433	70	5.271	71	5.384	72	5.614
73	5.504	74	5.296	75	5.712	76	5.452
77	5.687	78	5.533	79	5.599	80	5.561
81	5.293	82	5.300	83	5.302	84	5.718
85	5.291	86	5.456	87	5.505	88	5.636
89	5.367	90	5.348	91	5.527	92	5.558
93	5.640	94	5.559	95	5.436	96	5.613
97	5.472	98	5.707	99	5.607	100	5.680

Hopping Frequency Sequence Name: HOP_FREQ_SEQ_02

SEQ#	Frequency (GHz)	SEQ#	Frequency (GHz)	SEQ#	Frequency (GHz)	SEQ#	Frequency (GHz)
1	5.641	2	5.581	3	5.679	4	5.580
5	5.429	6	5.315	7	5.582	8	5.604
9	5.353	10	5.255	11	5.260	12	5.425
13	5.366	14	5.343	15	5.478	16	5.310
17	5.367	18	5.288	19	5.595	20	5.719
21	5.514	22	5.630	23	5.327	24	5.606
25	5.424	26	5.662	27	5.482	28	5.683
29	5.528	30	5.289	31	5.700	32	5.541
33	5.356	34	5.585	35	5.506	36	5.297
37	5.391	38	5.505	39	5.511	40	5.333
41	5.292	42	5.572	43	5.329	44	5.553
45	5.408	46	5.612	47	5.532	48	5.423
49	5.594	50	5.495	51	5.499	52	5.607
53	5.706	54	5.525	55	5.692	56	5.390
57	5.576	58	5.270	59	5.549	60	5.468
61	5.407	62	5.455	63	5.448	64	5.565
65	5.687	66	5.656	67	5.335	68	5.649
69	5.360	70	5.349	71	5.504	72	5.661
73	5.422	74	5.328	75	5.311	76	5.307
77	5.669	78	5.561	79	5.521	80	5.342
81	5.337	82	5.518	83	5.441	84	5.436
85	5.682	86	5.562	87	5.466	88	5.539
89	5.372	90	5.534	91	5.284	92	5.537
93	5.701	94	5.384	95	5.251	96	5.445
97	5.473	98	5.388	99	5.280	100	5.285

Hopping Frequency Sequence Name: HOP_FREQ_SEQ_03

SEQ#	Frequency (GHz)	SEQ#	Frequency (GHz)	SEQ#	Frequency (GHz)	SEQ#	Frequency (GHz)
1	5.284	2	5.304	3	5.456	4	5.489
5	5.670	6	5.409	7	5.574	8	5.448
9	5.581	10	5.467	11	5.637	12	5.651
13	5.641	14	5.407	15	5.281	16	5.321
17	5.428	18	5.355	19	5.260	20	5.276
21	5.435	22	5.640	23	5.683	24	5.333
25	5.382	26	5.712	27	5.391	28	5.401
29	5.554	30	5.383	31	5.261	32	5.315
33	5.563	34	5.326	35	5.652	36	5.393
37	5.280	38	5.352	39	5.588	40	5.595
41	5.498	42	5.618	43	5.596	44	5.307
45	5.720	46	5.495	47	5.542	48	5.469
49	5.617	50	5.623	51	5.723	52	5.440
53	5.350	54	5.338	55	5.332	56	5.602
57	5.277	58	5.367	59	5.572	60	5.611
61	5.294	62	5.584	63	5.529	64	5.678
65	5.501	66	5.267	67	5.536	68	5.301
69	5.516	70	5.650	71	5.664	72	5.662
73	5.263	74	5.458	75	5.528	76	5.707
77	5.717	78	5.418	79	5.560	80	5.604
81	5.644	82	5.396	83	5.416	84	5.514
85	5.526	86	5.699	87	5.443	88	5.674
89	5.411	90	5.671	91	5.510	92	5.257
93	5.436	94	5.424	95	5.459	96	5.273
97	5.685	98	5.463	99	5.288	100	5.275

Hopping Frequency Sequence Name: HOP_FREQ_SEQ_04

SEQ#	Frequency (GHz)	SEQ#	Frequency (GHz)	SEQ#	Frequency (GHz)	SEQ#	Frequency (GHz)
1	5.278	2	5.505	3	5.563	4	5.422
5	5.685	6	5.270	7	5.545	8	5.321
9	5.641	10	5.680	11	5.568	12	5.284
13	5.675	14	5.542	15	5.406	16	5.426
17	5.346	18	5.327	19	5.558	20	5.423
21	5.285	22	5.434	23	5.720	24	5.538
25	5.357	26	5.286	27	5.362	28	5.522
29	5.520	30	5.438	31	5.418	32	5.448
33	5.605	34	5.451	35	5.516	36	5.319
37	5.694	38	5.671	39	5.518	40	5.553
41	5.252	42	5.395	43	5.482	44	5.419
45	5.397	46	5.716	47	5.349	48	5.661
49	5.296	50	5.693	51	5.414	52	5.670
53	5.356	54	5.527	55	5.704	56	5.566
57	5.429	58	5.592	59	5.353	60	5.361
61	5.475	62	5.636	63	5.508	64	5.718
65	5.484	66	5.405	67	5.348	68	5.650
69	5.412	70	5.607	71	5.294	72	5.721
73	5.565	74	5.379	75	5.279	76	5.433
77	5.578	78	5.610	79	5.477	80	5.571
81	5.276	82	5.495	83	5.308	84	5.698
85	5.572	86	5.398	87	5.387	88	5.597
89	5.688	90	5.590	91	5.485	92	5.497
93	5.253	94	5.617	95	5.632	96	5.363
97	5.628	98	5.376	99	5.282	100	5.490

Hopping Frequency Sequence Name: HOP_FREQ_SEQ_05

SEQ#	Frequency (GHz)	SEQ#	Frequency (GHz)	SEQ#	Frequency (GHz)	SEQ#	Frequency (GHz)
1	5.535	2	5.444	3	5.468	4	5.719
5	5.264	6	5.349	7	5.554	8	5.387
9	5.462	10	5.632	11	5.490	12	5.478
13	5.340	14	5.494	15	5.323	16	5.320
17	5.560	18	5.435	19	5.367	20	5.544
21	5.519	22	5.401	23	5.616	24	5.485
25	5.477	26	5.482	27	5.669	28	5.553
29	5.682	30	5.308	31	5.293	32	5.496
33	5.480	34	5.593	35	5.268	36	5.324
37	5.657	38	5.587	39	5.712	40	5.635
41	5.473	42	5.441	43	5.442	44	5.649
45	5.597	46	5.517	47	5.279	48	5.454
49	5.689	50	5.456	51	5.529	52	5.391
53	5.515	54	5.350	55	5.434	56	5.505
57	5.539	58	5.582	59	5.604	60	5.370
61	5.413	62	5.414	63	5.285	64	5.605
65	5.648	66	5.345	67	5.489	68	5.671
69	5.540	70	5.289	71	5.598	72	5.542
73	5.636	74	5.381	75	5.347	76	5.522
77	5.711	78	5.693	79	5.319	80	5.431
81	5.501	82	5.486	83	5.280	84	5.647
85	5.398	86	5.259	87	5.570	88	5.504
89	5.558	90	5.426	91	5.706	92	5.291
93	5.253	94	5.662	95	5.362	96	5.667
97	5.590	98	5.569	99	5.531	100	5.405

Hopping Frequency Sequence Name: HOP_FREQ_SEQ_06

SEQ#	Frequency (GHz)	SEQ#	Frequency (GHz)	SEQ#	Frequency (GHz)	SEQ#	Frequency (GHz)
1	5.642	2	5.685	3	5.613	4	5.701
5	5.526	6	5.604	7	5.329	8	5.551
9	5.624	10	5.389	11	5.696	12	5.599
13	5.323	14	5.274	15	5.293	16	5.416
17	5.720	18	5.453	19	5.655	20	5.608
21	5.344	22	5.349	23	5.399	24	5.605
25	5.326	26	5.693	27	5.674	28	5.255
29	5.370	30	5.285	31	5.666	32	5.578
33	5.260	34	5.275	35	5.409	36	5.715
37	5.660	38	5.460	39	5.324	40	5.509
41	5.712	42	5.312	43	5.480	44	5.375
45	5.681	46	5.631	47	5.714	48	5.512
49	5.445	50	5.514	51	5.354	52	5.483
53	5.490	54	5.654	55	5.386	56	5.291
57	5.476	58	5.716	59	5.362	60	5.265
61	5.680	62	5.439	63	5.541	64	5.573
65	5.682	66	5.644	67	5.414	68	5.422
69	5.668	70	5.677	71	5.609	72	5.705
73	5.473	74	5.517	75	5.482	76	5.549
77	5.360	78	5.485	79	5.684	80	5.317
81	5.264	82	5.711	83	5.355	84	5.596
85	5.300	86	5.592	87	5.303	88	5.594
89	5.579	90	5.649	91	5.340	92	5.667
93	5.643	94	5.575	95	5.396	96	5.436
97	5.437	98	5.408	99	5.561	100	5.421

Hopping Frequency Sequence Name: HOP_FREQ_SEQ_07

SEQ#	Frequency (GHz)	SEQ#	Frequency (GHz)	SEQ#	Frequency (GHz)	SEQ#	Frequency (GHz)
1	5.597	2	5.360	3	5.666	4	5.431
5	5.587	6	5.521	7	5.471	8	5.553
9	5.676	10	5.338	11	5.722	12	5.347
13	5.458	14	5.498	15	5.620	16	5.641
17	5.596	18	5.295	19	5.317	20	5.605
21	5.532	22	5.650	23	5.558	24	5.700
25	5.495	26	5.481	27	5.485	28	5.390
29	5.656	30	5.648	31	5.365	32	5.708
33	5.371	34	5.441	35	5.702	36	5.504
37	5.261	38	5.398	39	5.392	40	5.572
41	5.683	42	5.567	43	5.585	44	5.623
45	5.569	46	5.256	47	5.505	48	5.649
49	5.426	50	5.264	51	5.640	52	5.690
53	5.520	54	5.466	55	5.593	56	5.568
57	5.325	58	5.383	59	5.300	60	5.389
61	5.469	62	5.253	63	5.285	64	5.724
65	5.538	66	5.467	67	5.519	68	5.686
69	5.539	70	5.313	71	5.713	72	5.312
73	5.654	74	5.299	75	5.446	76	5.366
77	5.320	78	5.479	79	5.492	80	5.340
81	5.548	82	5.671	83	5.698	84	5.674
85	5.343	86	5.710	87	5.443	88	5.503
89	5.599	90	5.474	91	5.502	92	5.437
93	5.263	94	5.604	95	5.393	96	5.372
97	5.369	98	5.262	99	5.711	100	5.527

Hopping Frequency Sequence Name: HOP_FREQ_SEQ_08

SEQ#	Frequency (GHz)	SEQ#	Frequency (GHz)	SEQ#	Frequency (GHz)	SEQ#	Frequency (GHz)
1	5.667	2	5.626	3	5.314	4	5.440
5	5.527	6	5.365	7	5.653	8	5.652
9	5.469	10	5.694	11	5.496	12	5.634
13	5.517	14	5.354	15	5.481	16	5.505
17	5.292	18	5.254	19	5.569	20	5.649
21	5.433	22	5.604	23	5.404	24	5.349
25	5.416	26	5.551	27	5.603	28	5.561
29	5.386	30	5.648	31	5.369	32	5.252
33	5.635	34	5.605	35	5.399	36	5.485
37	5.391	38	5.641	39	5.518	40	5.607
41	5.529	42	5.590	43	5.520	44	5.514
45	5.409	46	5.336	47	5.567	48	5.679
49	5.698	50	5.594	51	5.564	52	5.419
53	5.657	54	5.668	55	5.689	56	5.306
57	5.385	58	5.278	59	5.688	60	5.423
61	5.674	62	5.536	63	5.544	64	5.435
65	5.251	66	5.601	67	5.438	68	5.280
69	5.260	70	5.288	71	5.711	72	5.389
73	5.640	74	5.556	75	5.664	76	5.718
77	5.677	78	5.651	79	5.277	80	5.420
81	5.300	82	5.683	83	5.573	84	5.702
85	5.256	86	5.684	87	5.533	88	5.362
89	5.443	90	5.712	91	5.612	92	5.606
93	5.491	94	5.364	95	5.338	96	5.417
97	5.428	98	5.553	99	5.595	100	5.583

Hopping Frequency Sequence Name: HOP_FREQ_SEQ_09

SEQ#	Frequency (GHz)	SEQ#	Frequency (GHz)	SEQ#	Frequency (GHz)	SEQ#	Frequency (GHz)
1	5.652	2	5.260	3	5.508	4	5.643
5	5.653	6	5.659	7	5.381	8	5.683
9	5.724	10	5.711	11	5.577	12	5.333
13	5.682	14	5.307	15	5.258	16	5.603
17	5.605	18	5.534	19	5.520	20	5.491
21	5.367	22	5.672	23	5.355	24	5.372
25	5.651	26	5.541	27	5.274	28	5.666
29	5.498	30	5.336	31	5.420	32	5.701
33	5.496	34	5.707	35	5.361	36	5.608
37	5.582	38	5.631	39	5.289	40	5.386
41	5.568	42	5.671	43	5.455	44	5.279
45	5.558	46	5.595	47	5.363	48	5.352
49	5.549	50	5.434	51	5.602	52	5.362
53	5.379	54	5.419	55	5.554	56	5.686
57	5.366	58	5.516	59	5.285	60	5.405
61	5.319	62	5.596	63	5.394	64	5.385
65	5.356	66	5.300	67	5.641	68	5.280
69	5.332	70	5.626	71	5.674	72	5.295
73	5.664	74	5.600	75	5.523	76	5.440
77	5.286	78	5.490	79	5.259	80	5.593
81	5.531	82	5.634	83	5.489	84	5.559
85	5.527	86	5.578	87	5.322	88	5.589
89	5.709	90	5.525	91	5.535	92	5.537
93	5.636	94	5.521	95	5.323	96	5.716
97	5.611	98	5.632	99	5.282	100	5.598

Hopping Frequency Sequence Name: HOP_FREQ_SEQ_10

SEQ#	Frequency (GHz)	SEQ#	Frequency (GHz)	SEQ#	Frequency (GHz)	SEQ#	Frequency (GHz)
1	5.448	2	5.353	3	5.542	4	5.384
5	5.676	6	5.609	7	5.518	8	5.454
9	5.662	10	5.516	11	5.357	12	5.406
13	5.491	14	5.438	15	5.408	16	5.263
17	5.625	18	5.559	19	5.652	20	5.280
21	5.577	22	5.254	23	5.556	24	5.472
25	5.672	26	5.282	27	5.639	28	5.527
29	5.612	30	5.569	31	5.555	32	5.630
33	5.347	34	5.607	35	5.647	36	5.425
37	5.422	38	5.329	39	5.501	40	5.704
41	5.364	42	5.374	43	5.702	44	5.554
45	5.644	46	5.277	47	5.626	48	5.418
49	5.587	50	5.604	51	5.677	52	5.558
53	5.568	54	5.534	55	5.497	56	5.401
57	5.252	58	5.466	59	5.571	60	5.584
61	5.714	62	5.682	63	5.552	64	5.610
65	5.597	66	5.392	67	5.370	68	5.456
69	5.316	70	5.274	71	5.506	72	5.523
73	5.537	74	5.533	75	5.546	76	5.645
77	5.276	78	5.505	79	5.484	80	5.684
81	5.679	82	5.259	83	5.285	84	5.668
85	5.723	86	5.656	87	5.673	88	5.255
89	5.594	90	5.339	91	5.268	92	5.502
93	5.496	94	5.503	95	5.323	96	5.273
97	5.342	98	5.711	99	5.410	100	5.661

Hopping Frequency Sequence Name: HOP_FREQ_SEQ_11

SEQ#	Frequency (GHz)	SEQ#	Frequency (GHz)	SEQ#	Frequency (GHz)	SEQ#	Frequency (GHz)
1	5.407	2	5.441	3	5.498	4	5.515
5	5.358	6	5.316	7	5.659	8	5.695
9	5.542	10	5.393	11	5.592	12	5.682
13	5.332	14	5.675	15	5.608	16	5.588
17	5.578	18	5.291	19	5.614	20	5.282
21	5.648	22	5.476	23	5.273	24	5.312
25	5.697	26	5.658	27	5.349	28	5.600
29	5.279	30	5.431	31	5.484	32	5.372
33	5.283	34	5.378	35	5.401	36	5.505
37	5.471	38	5.295	39	5.470	40	5.341
41	5.669	42	5.366	43	5.290	44	5.475
45	5.549	46	5.633	47	5.430	48	5.539
49	5.425	50	5.387	51	5.511	52	5.373
53	5.514	54	5.634	55	5.297	56	5.461
57	5.392	58	5.516	59	5.270	60	5.280
61	5.427	62	5.570	63	5.289	64	5.310
65	5.411	66	5.412	67	5.711	68	5.568
69	5.386	70	5.655	71	5.409	72	5.374
73	5.437	74	5.302	75	5.617	76	5.572
77	5.370	78	5.667	79	5.601	80	5.447
81	5.551	82	5.525	83	5.292	84	5.481
85	5.571	86	5.605	87	5.395	88	5.496
89	5.402	90	5.644	91	5.631	92	5.432
93	5.694	94	5.662	95	5.540	96	5.489
97	5.463	98	5.521	99	5.486	100	5.616

Hopping Frequency Sequence Name: HOP_FREQ_SEQ_12

SEQ#	Frequency (GHz)	SEQ#	Frequency (GHz)	SEQ#	Frequency (GHz)	SEQ#	Frequency (GHz)
1	5.544	2	5.339	3	5.529	4	5.472
5	5.508	6	5.431	7	5.596	8	5.270
9	5.327	10	5.379	11	5.662	12	5.462
13	5.273	14	5.617	15	5.651	16	5.377
17	5.686	18	5.415	19	5.488	20	5.380
21	5.351	22	5.688	23	5.260	24	5.530
25	5.589	26	5.703	27	5.632	28	5.609
29	5.333	30	5.286	31	5.507	32	5.693
33	5.664	34	5.582	35	5.461	36	5.358
37	5.667	38	5.555	39	5.367	40	5.570
41	5.711	42	5.372	43	5.537	44	5.267
45	5.301	46	5.585	47	5.288	48	5.583
49	5.398	50	5.421	51	5.291	52	5.445
53	5.541	54	5.504	55	5.384	56	5.299
57	5.543	58	5.556	59	5.496	60	5.477
61	5.423	62	5.678	63	5.624	64	5.353
65	5.413	66	5.296	67	5.706	68	5.685
69	5.473	70	5.722	71	5.424	72	5.525
73	5.674	74	5.359	75	5.325	76	5.489
77	5.614	78	5.622	79	5.294	80	5.573
81	5.494	82	5.326	83	5.394	84	5.482
85	5.650	86	5.435	87	5.659	88	5.400
89	5.637	90	5.355	91	5.258	92	5.449
93	5.718	94	5.676	95	5.447	96	5.549
97	5.640	98	5.645	99	5.276	100	5.533

Hopping Frequency Sequence Name: HOP_FREQ_SEQ_13

SEQ#	Frequency (GHz)	SEQ#	Frequency (GHz)	SEQ#	Frequency (GHz)	SEQ#	Frequency (GHz)
1	5.358	2	5.430	3	5.615	4	5.653
5	5.439	6	5.310	7	5.399	8	5.722
9	5.721	10	5.494	11	5.352	12	5.449
13	5.538	14	5.337	15	5.438	16	5.262
17	5.307	18	5.409	19	5.503	20	5.419
21	5.487	22	5.282	23	5.417	24	5.295
25	5.644	26	5.622	27	5.383	28	5.334
29	5.692	30	5.658	31	5.598	32	5.372
33	5.573	34	5.576	35	5.491	36	5.621
37	5.380	38	5.586	39	5.527	40	5.698
41	5.342	42	5.275	43	5.492	44	5.630
45	5.529	46	5.724	47	5.269	48	5.411
49	5.474	50	5.608	51	5.553	52	5.602
53	5.429	54	5.478	55	5.312	56	5.318
57	5.673	58	5.297	59	5.369	60	5.377
61	5.375	62	5.285	63	5.558	64	5.260
65	5.390	66	5.268	67	5.656	68	5.370
69	5.596	70	5.605	71	5.591	72	5.629
73	5.506	74	5.351	75	5.281	76	5.336
77	5.524	78	5.521	79	5.461	80	5.367
81	5.296	82	5.347	83	5.435	84	5.329
85	5.340	86	5.299	87	5.680	88	5.448
89	5.261	90	5.510	91	5.265	92	5.555
93	5.595	94	5.457	95	5.280	96	5.359
97	5.410	98	5.509	99	5.379	100	5.447

Hopping Frequency Sequence Name: HOP_FREQ_SEQ_14

SEQ#	Frequency (GHz)	SEQ#	Frequency (GHz)	SEQ#	Frequency (GHz)	SEQ#	Frequency (GHz)
1	5.393	2	5.673	3	5.362	4	5.390
5	5.528	6	5.625	7	5.315	8	5.383
9	5.653	10	5.342	11	5.572	12	5.613
13	5.252	14	5.520	15	5.685	16	5.292
17	5.268	18	5.450	19	5.259	20	5.674
21	5.321	22	5.371	23	5.531	24	5.381
25	5.284	26	5.403	27	5.599	28	5.549
29	5.400	30	5.482	31	5.281	32	5.454
33	5.689	34	5.290	35	5.481	36	5.540
37	5.571	38	5.368	39	5.440	40	5.555
41	5.607	42	5.399	43	5.713	44	5.301
45	5.423	46	5.369	47	5.445	48	5.566
49	5.574	50	5.724	51	5.639	52	5.406
53	5.407	54	5.543	55	5.476	56	5.660
57	5.633	58	5.700	59	5.417	60	5.439
61	5.589	62	5.585	63	5.435	64	5.500
65	5.715	66	5.280	67	5.697	68	5.366
69	5.442	70	5.558	71	5.286	72	5.448
73	5.716	74	5.508	75	5.634	76	5.488
77	5.657	78	5.554	79	5.461	80	5.721
81	5.517	82	5.269	83	5.584	84	5.693
85	5.587	86	5.502	87	5.431	88	5.405
89	5.272	90	5.707	91	5.667	92	5.418
93	5.662	94	5.387	95	5.610	96	5.536
97	5.485	98	5.605	99	5.526	100	5.279

Hopping Frequency Sequence Name: HOP_FREQ_SEQ_15

SEQ#	Frequency (GHz)	SEQ#	Frequency (GHz)	SEQ#	Frequency (GHz)	SEQ#	Frequency (GHz)
1	5.293	2	5.401	3	5.260	4	5.640
5	5.308	6	5.684	7	5.527	8	5.417
9	5.419	10	5.660	11	5.495	12	5.628
13	5.363	14	5.470	15	5.517	16	5.412
17	5.446	18	5.302	19	5.567	20	5.712
21	5.272	22	5.335	23	5.582	24	5.500
25	5.311	26	5.550	27	5.378	28	5.601
29	5.671	30	5.667	31	5.452	32	5.271
33	5.283	34	5.719	35	5.536	36	5.652
37	5.526	38	5.481	39	5.657	40	5.254
41	5.343	42	5.505	43	5.542	44	5.483
45	5.342	46	5.259	47	5.710	48	5.545
49	5.410	50	5.516	51	5.489	52	5.696
53	5.512	54	5.554	55	5.571	56	5.433
57	5.445	58	5.634	59	5.345	60	5.434
61	5.716	62	5.613	63	5.541	64	5.268
65	5.282	66	5.252	67	5.442	68	5.488
69	5.703	70	5.586	71	5.349	72	5.544
73	5.325	74	5.514	75	5.456	76	5.508
77	5.403	78	5.387	79	5.406	80	5.653
81	5.497	82	5.454	83	5.307	84	5.430
85	5.377	86	5.431	87	5.382	88	5.539
89	5.251	90	5.420	91	5.638	92	5.676
93	5.592	94	5.579	95	5.463	96	5.678
97	5.262	98	5.364	99	5.388	100	5.261

Hopping Frequency Sequence Name: HOP_FREQ_SEQ_16

SEQ#	Frequency (GHz)	SEQ#	Frequency (GHz)	SEQ#	Frequency (GHz)	SEQ#	Frequency (GHz)
1	5.700	2	5.350	3	5.410	4	5.401
5	5.669	6	5.409	7	5.462	8	5.338
9	5.266	10	5.526	11	5.681	12	5.337
13	5.420	14	5.267	15	5.516	16	5.629
17	5.389	18	5.299	19	5.490	20	5.398
21	5.380	22	5.418	23	5.523	24	5.655
25	5.360	26	5.328	27	5.397	28	5.639
29	5.417	30	5.423	31	5.540	32	5.342
33	5.656	34	5.296	35	5.491	36	5.635
37	5.395	38	5.255	39	5.556	40	5.254
41	5.278	42	5.648	43	5.295	44	5.576
45	5.686	46	5.569	47	5.439	48	5.476
49	5.614	50	5.422	51	5.336	52	5.367
53	5.259	54	5.461	55	5.566	56	5.702
57	5.345	58	5.307	59	5.319	60	5.289
61	5.517	62	5.281	63	5.581	64	5.673
65	5.489	66	5.339	67	5.436	68	5.352
69	5.440	70	5.634	71	5.504	72	5.411
73	5.407	74	5.625	75	5.601	76	5.678
77	5.671	78	5.282	79	5.710	80	5.324
81	5.264	82	5.536	83	5.633	84	5.499
85	5.271	86	5.568	87	5.559	88	5.644
89	5.514	90	5.664	91	5.326	92	5.294
93	5.646	94	5.315	95	5.340	96	5.408
97	5.638	98	5.599	99	5.670	100	5.561

Hopping Frequency Sequence Name: HOP_FREQ_SEQ_17

SEQ#	Frequency (GHz)	SEQ#	Frequency (GHz)	SEQ#	Frequency (GHz)	SEQ#	Frequency (GHz)
1	5.563	2	5.478	3	5.723	4	5.319
5	5.374	6	5.492	7	5.469	8	5.292
9	5.525	10	5.252	11	5.350	12	5.608
13	5.323	14	5.681	15	5.388	16	5.545
17	5.291	18	5.517	19	5.253	20	5.383
21	5.489	22	5.654	23	5.704	24	5.616
25	5.621	26	5.593	27	5.435	28	5.332
29	5.420	30	5.375	31	5.587	32	5.610
33	5.498	34	5.376	35	5.661	36	5.596
37	5.413	38	5.269	39	5.701	40	5.510
41	5.266	42	5.626	43	5.516	44	5.483
45	5.467	46	5.518	47	5.586	48	5.255
49	5.512	50	5.315	51	5.639	52	5.316
53	5.667	54	5.625	55	5.495	56	5.560
57	5.455	58	5.286	59	5.324	60	5.678
61	5.555	62	5.594	63	5.662	64	5.505
65	5.320	66	5.685	67	5.282	68	5.335
69	5.677	70	5.585	71	5.526	72	5.670
73	5.400	74	5.541	75	5.488	76	5.477
77	5.480	78	5.507	79	5.449	80	5.385
81	5.473	82	5.412	83	5.714	84	5.549
85	5.690	86	5.295	87	5.619	88	5.683
89	5.411	90	5.343	91	5.664	92	5.637
93	5.351	94	5.285	95	5.691	96	5.554
97	5.415	98	5.530	99	5.692	100	5.452

Hopping Frequency Sequence Name: HOP_FREQ_SEQ_18

SEQ#	Frequency (GHz)	SEQ#	Frequency (GHz)	SEQ#	Frequency (GHz)	SEQ#	Frequency (GHz)
1	5.497	2	5.599	3	5.670	4	5.665
5	5.351	6	5.278	7	5.388	8	5.600
9	5.263	10	5.572	11	5.364	12	5.532
13	5.643	14	5.487	15	5.486	16	5.631
17	5.515	18	5.492	19	5.373	20	5.442
21	5.358	22	5.293	23	5.562	24	5.355
25	5.496	26	5.467	27	5.679	28	5.707
29	5.607	30	5.513	31	5.489	32	5.485
33	5.320	34	5.418	35	5.621	36	5.416
37	5.522	38	5.407	39	5.303	40	5.357
41	5.378	42	5.542	43	5.678	44	5.452
45	5.574	46	5.449	47	5.546	48	5.610
49	5.434	50	5.613	51	5.650	52	5.469
53	5.281	54	5.608	55	5.524	56	5.529
57	5.428	58	5.661	59	5.544	60	5.512
61	5.393	62	5.411	63	5.471	64	5.462
65	5.504	66	5.399	67	5.638	68	5.298
69	5.395	70	5.553	71	5.273	72	5.578
73	5.463	74	5.423	75	5.307	76	5.516
77	5.507	78	5.480	79	5.360	80	5.721
81	5.598	82	5.376	83	5.494	84	5.398
85	5.595	86	5.521	87	5.305	88	5.446
89	5.275	90	5.443	91	5.316	92	5.437
93	5.549	94	5.693	95	5.269	96	5.295
97	5.668	98	5.586	99	5.719	100	5.615

Hopping Frequency Sequence Name: HOP_FREQ_SEQ_19

SEQ#	Frequency (GHz)	SEQ#	Frequency (GHz)	SEQ#	Frequency (GHz)	SEQ#	Frequency (GHz)
1	5.691	2	5.551	3	5.579	4	5.350
5	5.688	6	5.622	7	5.294	8	5.547
9	5.460	10	5.446	11	5.270	12	5.541
13	5.620	14	5.571	15	5.384	16	5.633
17	5.477	18	5.503	19	5.553	20	5.629
21	5.472	22	5.542	23	5.528	24	5.544
25	5.613	26	5.700	27	5.434	28	5.358
29	5.525	30	5.305	31	5.644	32	5.516
33	5.648	34	5.684	35	5.488	36	5.478
37	5.498	38	5.335	39	5.441	40	5.361
41	5.411	42	5.420	43	5.396	44	5.515
45	5.353	46	5.266	47	5.451	48	5.386
49	5.617	50	5.588	51	5.374	52	5.532
53	5.666	54	5.669	55	5.314	56	5.431
57	5.520	58	5.306	59	5.272	60	5.279
61	5.634	62	5.654	63	5.619	64	5.504
65	5.334	66	5.685	67	5.690	68	5.646
69	5.575	70	5.641	71	5.297	72	5.282
73	5.713	74	5.479	75	5.663	76	5.695
77	5.492	78	5.493	79	5.668	80	5.327
81	5.288	82	5.296	83	5.413	84	5.511
85	5.486	86	5.597	87	5.286	88	5.661
89	5.421	90	5.405	91	5.536	92	5.719
93	5.518	94	5.590	95	5.608	96	5.408
97	5.582	98	5.303	99	5.449	100	5.414

Hopping Frequency Sequence Name: HOP_FREQ_SEQ_20

SEQ#	Frequency (GHz)	SEQ#	Frequency (GHz)	SEQ#	Frequency (GHz)	SEQ#	Frequency (GHz)
1	5.680	2	5.483	3	5.416	4	5.549
5	5.475	6	5.321	7	5.633	8	5.278
9	5.311	10	5.524	11	5.678	12	5.521
13	5.605	14	5.367	15	5.691	16	5.672
17	5.370	18	5.504	19	5.488	20	5.433
21	5.465	22	5.282	23	5.266	24	5.701
25	5.709	26	5.267	27	5.445	28	5.385
29	5.623	30	5.299	31	5.419	32	5.707
33	5.617	34	5.322	35	5.498	36	5.632
37	5.649	38	5.546	39	5.446	40	5.541
41	5.599	42	5.630	43	5.256	44	5.568
45	5.566	46	5.537	47	5.534	48	5.277
49	5.618	50	5.374	51	5.455	52	5.283
53	5.564	54	5.312	55	5.693	56	5.436
57	5.338	58	5.372	59	5.272	60	5.369
61	5.696	62	5.507	63	5.695	64	5.529
65	5.317	66	5.384	67	5.297	68	5.494
69	5.366	70	5.705	71	5.300	72	5.715
73	5.481	74	5.287	75	5.698	76	5.301
77	5.655	78	5.670	79	5.264	80	5.420
81	5.262	82	5.676	83	5.683	84	5.394
85	5.540	86	5.337	87	5.326	88	5.431
89	5.381	90	5.505	91	5.515	92	5.275
93	5.408	94	5.690	95	5.306	96	5.359
97	5.427	98	5.342	99	5.356	100	5.462

Hopping Frequency Sequence Name: HOP_FREQ_SEQ_21

SEQ#	Frequency (GHz)	SEQ#	Frequency (GHz)	SEQ#	Frequency (GHz)	SEQ#	Frequency (GHz)
1	5.600	2	5.680	3	5.444	4	5.459
5	5.718	6	5.298	7	5.441	8	5.605
9	5.622	10	5.505	11	5.286	12	5.634
13	5.683	14	5.583	15	5.428	16	5.667
17	5.570	18	5.549	19	5.553	20	5.353
21	5.602	22	5.544	23	5.377	24	5.341
25	5.677	26	5.713	27	5.629	28	5.321
29	5.483	30	5.363	31	5.636	32	5.504
33	5.595	34	5.384	35	5.474	36	5.625
37	5.269	38	5.624	39	5.665	40	5.375
41	5.712	42	5.345	43	5.418	44	5.457
45	5.311	46	5.656	47	5.507	48	5.429
49	5.440	50	5.320	51	5.540	52	5.477
53	5.411	54	5.561	55	5.352	56	5.317
57	5.497	58	5.423	59	5.576	60	5.367
61	5.509	62	5.472	63	5.641	64	5.597
65	5.559	66	5.585	67	5.626	68	5.336
69	5.271	70	5.313	71	5.420	72	5.448
73	5.443	74	5.381	75	5.647	76	5.431
77	5.370	78	5.580	79	5.323	80	5.548
81	5.430	82	5.596	83	5.523	84	5.530
85	5.560	86	5.592	87	5.314	88	5.422
89	5.607	90	5.385	91	5.628	92	5.421
93	5.463	94	5.437	95	5.646	96	5.648
97	5.536	98	5.296	99	5.312	100	5.409

Hopping Frequency Sequence Name: HOP_FREQ_SEQ_22

SEQ#	Frequency (GHz)	SEQ#	Frequency (GHz)	SEQ#	Frequency (GHz)	SEQ#	Frequency (GHz)
1	5.290	2	5.317	3	5.630	4	5.724
5	5.411	6	5.700	7	5.507	8	5.263
9	5.308	10	5.568	11	5.400	12	5.252
13	5.499	14	5.570	15	5.528	16	5.461
17	5.638	18	5.399	19	5.398	20	5.254
21	5.684	22	5.616	23	5.659	24	5.285
25	5.640	26	5.647	27	5.357	28	5.279
29	5.324	30	5.323	31	5.327	32	5.626
33	5.722	34	5.345	35	5.302	36	5.483
37	5.702	38	5.384	39	5.305	40	5.651
41	5.498	42	5.693	43	5.255	44	5.564
45	5.299	46	5.482	47	5.446	48	5.704
49	5.459	50	5.582	51	5.288	52	5.720
53	5.335	54	5.286	55	5.541	56	5.457
57	5.272	58	5.365	59	5.529	60	5.618
61	5.441	62	5.581	63	5.386	64	5.650
65	5.580	66	5.612	67	5.601	68	5.557
69	5.486	70	5.608	71	5.511	72	5.664
73	5.675	74	5.525	75	5.567	76	5.678
77	5.586	78	5.336	79	5.291	80	5.387
81	5.625	82	5.356	83	5.412	84	5.706
85	5.591	86	5.688	87	5.374	88	5.401
89	5.510	90	5.624	91	5.321	92	5.339
93	5.466	94	5.475	95	5.655	96	5.328
97	5.513	98	5.686	99	5.352	100	5.261

Hopping Frequency Sequence Name: HOP_FREQ_SEQ_23

SEQ#	Frequency (GHz)	SEQ#	Frequency (GHz)	SEQ#	Frequency (GHz)	SEQ#	Frequency (GHz)
1	5.367	2	5.276	3	5.659	4	5.686
5	5.388	6	5.552	7	5.452	8	5.285
9	5.475	10	5.441	11	5.514	12	5.266
13	5.432	14	5.462	15	5.545	16	5.348
17	5.442	18	5.489	19	5.271	20	5.277
21	5.542	22	5.594	23	5.411	24	5.517
25	5.613	26	5.275	27	5.426	28	5.661
29	5.286	30	5.595	31	5.645	32	5.688
33	5.357	34	5.690	35	5.543	36	5.364
37	5.497	38	5.393	39	5.435	40	5.345
41	5.482	42	5.344	43	5.570	44	5.593
45	5.715	46	5.602	47	5.548	48	5.451
49	5.633	50	5.471	51	5.605	52	5.324
53	5.550	54	5.526	55	5.445	56	5.651
57	5.289	58	5.582	59	5.535	60	5.251
61	5.549	62	5.362	63	5.527	64	5.294
65	5.539	66	5.423	67	5.268	68	5.400
69	5.368	70	5.684	71	5.553	72	5.703
73	5.460	74	5.436	75	5.448	76	5.309
77	5.290	78	5.260	79	5.444	80	5.588
81	5.530	82	5.682	83	5.418	84	5.560
85	5.320	86	5.486	87	5.404	88	5.428
89	5.663	90	5.401	91	5.580	92	5.484
93	5.495	94	5.319	95	5.267	96	5.618
97	5.431	98	5.327	99	5.252	100	5.547

Hopping Frequency Sequence Name: HOP_FREQ_SEQ_24

SEQ#	Frequency (GHz)	SEQ#	Frequency (GHz)	SEQ#	Frequency (GHz)	SEQ#	Frequency (GHz)
1	5.280	2	5.283	3	5.409	4	5.651
5	5.340	6	5.620	7	5.366	8	5.353
9	5.501	10	5.456	11	5.573	12	5.583
13	5.375	14	5.630	15	5.291	16	5.333
17	5.477	18	5.453	19	5.513	20	5.510
21	5.445	22	5.407	23	5.401	24	5.671
25	5.523	26	5.428	27	5.655	28	5.603
29	5.650	30	5.270	31	5.348	32	5.367
33	5.564	34	5.673	35	5.362	36	5.378
37	5.528	38	5.334	39	5.365	40	5.568
41	5.341	42	5.636	43	5.411	44	5.549
45	5.394	46	5.271	47	5.420	48	5.724
49	5.467	50	5.423	51	5.427	52	5.580
53	5.611	54	5.313	55	5.584	56	5.553
57	5.396	58	5.688	59	5.516	60	5.433
61	5.487	62	5.308	63	5.296	64	5.338
65	5.666	66	5.464	67	5.389	68	5.421
69	5.721	70	5.605	71	5.555	72	5.447
73	5.455	74	5.567	75	5.585	76	5.656
77	5.469	78	5.640	79	5.629	80	5.424
81	5.481	82	5.329	83	5.342	84	5.610
85	5.710	86	5.489	87	5.343	88	5.442
89	5.692	90	5.292	91	5.702	92	5.601
93	5.491	94	5.626	95	5.644	96	5.641
97	5.406	98	5.450	99	5.569	100	5.690

Hopping Frequency Sequence Name: HOP_FREQ_SEQ_25

SEQ#	Frequency (GHz)	SEQ#	Frequency (GHz)	SEQ#	Frequency (GHz)	SEQ#	Frequency (GHz)
1	5.615	2	5.657	3	5.676	4	5.592
5	5.327	6	5.300	7	5.337	8	5.680
9	5.448	10	5.690	11	5.417	12	5.567
13	5.604	14	5.694	15	5.516	16	5.503
17	5.312	18	5.598	19	5.696	20	5.383
21	5.718	22	5.475	23	5.603	24	5.464
25	5.425	26	5.677	27	5.320	28	5.367
29	5.313	30	5.436	31	5.463	32	5.699
33	5.565	34	5.371	35	5.411	36	5.659
37	5.661	38	5.649	39	5.391	40	5.589
41	5.452	42	5.410	43	5.484	44	5.302
45	5.692	46	5.270	47	5.386	48	5.279
49	5.601	50	5.513	51	5.602	52	5.673
53	5.501	54	5.557	55	5.494	56	5.254
57	5.571	58	5.264	59	5.573	60	5.440
61	5.281	62	5.423	63	5.358	64	5.500
65	5.701	66	5.525	67	5.446	68	5.369
69	5.499	70	5.582	71	5.717	72	5.664
73	5.515	74	5.514	75	5.461	76	5.631
77	5.719	78	5.606	79	5.483	80	5.449
81	5.458	82	5.447	83	5.616	84	5.482
85	5.453	86	5.263	87	5.542	88	5.399
89	5.469	90	5.275	91	5.295	92	5.291
93	5.416	94	5.444	95	5.599	96	5.522
97	5.640	98	5.632	99	5.472	100	5.583

Hopping Frequency Sequence Name: HOP_FREQ_SEQ_26

SEQ#	Frequency (GHz)	SEQ#	Frequency (GHz)	SEQ#	Frequency (GHz)	SEQ#	Frequency (GHz)
1	5.339	2	5.672	3	5.594	4	5.694
5	5.660	6	5.647	7	5.656	8	5.705
9	5.551	10	5.542	11	5.295	12	5.316
13	5.454	14	5.592	15	5.582	16	5.303
17	5.465	18	5.417	19	5.512	20	5.710
21	5.289	22	5.286	23	5.277	24	5.440
25	5.584	26	5.518	27	5.505	28	5.597
29	5.326	30	5.371	31	5.374	32	5.639
33	5.355	34	5.609	35	5.618	36	5.463
37	5.425	38	5.404	39	5.711	40	5.506
41	5.394	42	5.431	43	5.703	44	5.489
45	5.596	46	5.575	47	5.515	48	5.655
49	5.652	50	5.494	51	5.358	52	5.648
53	5.376	54	5.457	55	5.279	56	5.707
57	5.412	58	5.396	59	5.319	60	5.430
61	5.363	62	5.379	63	5.544	64	5.364
65	5.499	66	5.622	67	5.476	68	5.536
69	5.487	70	5.587	71	5.452	72	5.418
73	5.333	74	5.321	75	5.528	76	5.574
77	5.619	78	5.386	79	5.633	80	5.467
81	5.600	82	5.500	83	5.504	84	5.265
85	5.625	86	5.359	87	5.485	88	5.372
89	5.569	90	5.456	91	5.573	92	5.581
93	5.281	94	5.314	95	5.721	96	5.650
97	5.713	98	5.275	99	5.686	100	5.708

Hopping Frequency Sequence Name: HOP_FREQ_SEQ_27

SEQ#	Frequency (GHz)	SEQ#	Frequency (GHz)	SEQ#	Frequency (GHz)	SEQ#	Frequency (GHz)
1	5.452	2	5.650	3	5.373	4	5.568
5	5.602	6	5.448	7	5.593	8	5.367
9	5.529	10	5.515	11	5.598	12	5.338
13	5.380	14	5.524	15	5.371	16	5.401
17	5.522	18	5.411	19	5.715	20	5.590
21	5.300	22	5.691	23	5.433	24	5.430
25	5.670	26	5.318	27	5.319	28	5.333
29	5.260	30	5.425	31	5.530	32	5.708
33	5.722	34	5.712	35	5.501	36	5.654
37	5.485	38	5.424	39	5.638	40	5.445
41	5.564	42	5.439	43	5.376	44	5.442
45	5.619	46	5.552	47	5.347	48	5.408
49	5.316	50	5.643	51	5.269	52	5.484
53	5.687	54	5.419	55	5.573	56	5.473
57	5.327	58	5.293	59	5.611	60	5.475
61	5.537	62	5.583	63	5.444	64	5.661
65	5.551	66	5.255	67	5.364	68	5.349
69	5.574	70	5.588	71	5.680	72	5.497
73	5.585	74	5.534	75	5.365	76	5.721
77	5.469	78	5.488	79	5.406	80	5.348
81	5.504	82	5.671	83	5.651	84	5.375
85	5.286	86	5.507	87	5.414	88	5.519
89	5.684	90	5.438	91	5.520	92	5.265
93	5.404	94	5.711	95	5.586	96	5.657
97	5.302	98	5.575	99	5.490	100	5.464

Hopping Frequency Sequence Name: HOP_FREQ_SEQ_28

SEQ#	Frequency (GHz)	SEQ#	Frequency (GHz)	SEQ#	Frequency (GHz)	SEQ#	Frequency (GHz)
1	5.434	2	5.680	3	5.335	4	5.560
5	5.369	6	5.305	7	5.710	8	5.275
9	5.315	10	5.475	11	5.269	12	5.460
13	5.533	14	5.627	15	5.702	16	5.661
17	5.707	18	5.356	19	5.687	20	5.328
21	5.656	22	5.563	23	5.581	24	5.361
25	5.694	26	5.468	27	5.456	28	5.304
29	5.499	30	5.255	31	5.391	32	5.647
33	5.320	34	5.653	35	5.298	36	5.536
37	5.665	38	5.268	39	5.623	40	5.721
41	5.620	42	5.611	43	5.313	44	5.570
45	5.545	46	5.716	47	5.524	48	5.628
49	5.698	50	5.558	51	5.278	52	5.723
53	5.420	54	5.359	55	5.722	56	5.492
57	5.446	58	5.354	59	5.474	60	5.638
61	5.720	62	5.618	63	5.582	64	5.326
65	5.398	66	5.410	67	5.634	68	5.344
69	5.697	70	5.253	71	5.519	72	5.424
73	5.594	74	5.286	75	5.599	76	5.264
77	5.718	78	5.576	79	5.682	80	5.432
81	5.584	82	5.462	83	5.525	84	5.336
85	5.577	86	5.459	87	5.714	88	5.449
89	5.483	90	5.490	91	5.347	92	5.277
93	5.478	94	5.292	95	5.274	96	5.377
97	5.617	98	5.367	99	5.472	100	5.337

Hopping Frequency Sequence Name: HOP_FREQ_SEQ_29

SEQ#	Frequency (GHz)	SEQ#	Frequency (GHz)	SEQ#	Frequency (GHz)	SEQ#	Frequency (GHz)
1	5.410	2	5.585	3	5.609	4	5.523
5	5.304	6	5.466	7	5.262	8	5.617
9	5.311	10	5.677	11	5.590	12	5.283
13	5.305	14	5.601	15	5.404	16	5.690
17	5.302	18	5.655	19	5.668	20	5.389
21	5.412	22	5.709	23	5.286	24	5.631
25	5.626	26	5.487	27	5.257	28	5.491
29	5.328	30	5.345	31	5.651	32	5.275
33	5.605	34	5.430	35	5.588	36	5.705
37	5.289	38	5.694	39	5.365	40	5.307
41	5.673	42	5.288	43	5.458	44	5.363
45	5.573	46	5.424	47	5.654	48	5.354
49	5.548	50	5.696	51	5.440	52	5.701
53	5.629	54	5.390	55	5.334	56	5.507
57	5.434	58	5.724	59	5.485	60	5.444
61	5.527	62	5.428	63	5.360	64	5.377
65	5.542	66	5.641	67	5.423	68	5.446
69	5.483	70	5.478	71	5.537	72	5.293
73	5.612	74	5.476	75	5.445	76	5.702
77	5.596	78	5.388	79	5.544	80	5.499
81	5.621	82	5.353	83	5.402	84	5.603
85	5.650	86	5.469	87	5.327	88	5.313
89	5.721	90	5.432	91	5.646	92	5.680
93	5.640	94	5.295	95	5.606	96	5.604
97	5.539	98	5.325	99	5.468	100	5.484

Hopping Frequency Sequence Name: HOP_FREQ_SEQ_30

SEQ#	Frequency (GHz)	SEQ#	Frequency (GHz)	SEQ#	Frequency (GHz)	SEQ#	Frequency (GHz)
1	5.631	2	5.628	3	5.645	4	5.347
5	5.591	6	5.427	7	5.333	8	5.692
9	5.441	10	5.504	11	5.600	12	5.551
13	5.271	14	5.647	15	5.646	16	5.406
17	5.613	18	5.291	19	5.362	20	5.394
21	5.470	22	5.458	23	5.546	24	5.563
25	5.318	26	5.397	27	5.260	28	5.636
29	5.576	30	5.430	31	5.391	32	5.460
33	5.361	34	5.708	35	5.698	36	5.544
37	5.258	38	5.474	39	5.703	40	5.416
41	5.657	42	5.328	43	5.277	44	5.617
45	5.449	46	5.489	47	5.575	48	5.268
49	5.294	50	5.723	51	5.644	52	5.590
53	5.256	54	5.721	55	5.261	56	5.259
57	5.514	58	5.476	59	5.345	60	5.459
61	5.462	62	5.266	63	5.407	64	5.488
65	5.286	66	5.371	67	5.571	68	5.556
69	5.588	70	5.654	71	5.678	72	5.354
73	5.472	74	5.526	75	5.487	76	5.468
77	5.508	78	5.388	79	5.446	80	5.520
81	5.418	82	5.390	83	5.550	84	5.482
85	5.337	86	5.404	87	5.664	88	5.465
89	5.598	90	5.257	91	5.392	92	5.516
93	5.448	94	5.327	95	5.614	96	5.594
97	5.633	98	5.637	99	5.715	100	5.329

802.11be (EHT160)_Ch50

Hopping Frequency Sequence Name: HOP_FREQ_SEQ_01

SEQ#	Frequency (GHz)	SEQ#	Frequency (GHz)	SEQ#	Frequency (GHz)	SEQ#	Frequency (GHz)
1	5.540	2	5.513	3	5.526	4	5.574
5	5.501	6	5.717	7	5.590	8	5.373
9	5.338	10	5.534	11	5.388	12	5.493
13	5.447	14	5.554	15	5.593	16	5.566
17	5.688	18	5.715	19	5.350	20	5.713
21	5.404	22	5.374	23	5.571	24	5.420
25	5.588	26	5.277	27	5.407	28	5.610
29	5.278	30	5.710	31	5.366	32	5.301
33	5.666	34	5.551	35	5.531	36	5.339
37	5.410	38	5.303	39	5.267	40	5.538
41	5.327	42	5.701	43	5.358	44	5.581
45	5.408	46	5.584	47	5.477	48	5.357
49	5.703	50	5.376	51	5.683	52	5.413
53	5.662	54	5.423	55	5.632	56	5.668
57	5.619	58	5.281	59	5.429	60	5.289
61	5.306	62	5.337	63	5.596	64	5.286
65	5.592	66	5.379	67	5.362	68	5.351
69	5.433	70	5.271	71	5.384	72	5.614
73	5.504	74	5.296	75	5.712	76	5.452
77	5.687	78	5.533	79	5.599	80	5.561
81	5.293	82	5.300	83	5.302	84	5.718
85	5.291	86	5.456	87	5.505	88	5.636
89	5.367	90	5.348	91	5.527	92	5.558
93	5.640	94	5.559	95	5.436	96	5.613
97	5.472	98	5.707	99	5.607	100	5.680

Hopping Frequency Sequence Name: HOP_FREQ_SEQ_02

SEQ#	Frequency (GHz)	SEQ#	Frequency (GHz)	SEQ#	Frequency (GHz)	SEQ#	Frequency (GHz)
1	5.641	2	5.581	3	5.679	4	5.580
5	5.429	6	5.315	7	5.582	8	5.604
9	5.353	10	5.255	11	5.260	12	5.425
13	5.366	14	5.343	15	5.478	16	5.310
17	5.367	18	5.288	19	5.595	20	5.719
21	5.514	22	5.630	23	5.327	24	5.606
25	5.424	26	5.662	27	5.482	28	5.683
29	5.528	30	5.289	31	5.700	32	5.541
33	5.356	34	5.585	35	5.506	36	5.297
37	5.391	38	5.505	39	5.511	40	5.333
41	5.292	42	5.572	43	5.329	44	5.553
45	5.408	46	5.612	47	5.532	48	5.423
49	5.594	50	5.495	51	5.499	52	5.607
53	5.706	54	5.525	55	5.692	56	5.390
57	5.576	58	5.270	59	5.549	60	5.468
61	5.407	62	5.455	63	5.448	64	5.565
65	5.687	66	5.656	67	5.335	68	5.649
69	5.360	70	5.349	71	5.504	72	5.661
73	5.422	74	5.328	75	5.311	76	5.307
77	5.669	78	5.561	79	5.521	80	5.342
81	5.337	82	5.518	83	5.441	84	5.436
85	5.682	86	5.562	87	5.466	88	5.539
89	5.372	90	5.534	91	5.284	92	5.537
93	5.701	94	5.384	95	5.251	96	5.445
97	5.473	98	5.388	99	5.280	100	5.285

Hopping Frequency Sequence Name: HOP_FREQ_SEQ_03

SEQ#	Frequency (GHz)	SEQ#	Frequency (GHz)	SEQ#	Frequency (GHz)	SEQ#	Frequency (GHz)
1	5.284	2	5.304	3	5.456	4	5.489
5	5.670	6	5.409	7	5.574	8	5.448
9	5.581	10	5.467	11	5.637	12	5.651
13	5.641	14	5.407	15	5.281	16	5.321
17	5.428	18	5.355	19	5.260	20	5.276
21	5.435	22	5.640	23	5.683	24	5.333
25	5.382	26	5.712	27	5.391	28	5.401
29	5.554	30	5.383	31	5.261	32	5.315
33	5.563	34	5.326	35	5.652	36	5.393
37	5.280	38	5.352	39	5.588	40	5.595
41	5.498	42	5.618	43	5.596	44	5.307
45	5.720	46	5.495	47	5.542	48	5.469
49	5.617	50	5.623	51	5.723	52	5.440
53	5.350	54	5.338	55	5.332	56	5.602
57	5.277	58	5.367	59	5.572	60	5.611
61	5.294	62	5.584	63	5.529	64	5.678
65	5.501	66	5.267	67	5.536	68	5.301
69	5.516	70	5.650	71	5.664	72	5.662
73	5.263	74	5.458	75	5.528	76	5.707
77	5.717	78	5.418	79	5.560	80	5.604
81	5.644	82	5.396	83	5.416	84	5.514
85	5.526	86	5.699	87	5.443	88	5.674
89	5.411	90	5.671	91	5.510	92	5.257
93	5.436	94	5.424	95	5.459	96	5.273
97	5.685	98	5.463	99	5.288	100	5.275

Hopping Frequency Sequence Name: HOP_FREQ_SEQ_04

SEQ#	Frequency (GHz)	SEQ#	Frequency (GHz)	SEQ#	Frequency (GHz)	SEQ#	Frequency (GHz)
1	5.278	2	5.505	3	5.563	4	5.422
5	5.685	6	5.270	7	5.545	8	5.321
9	5.641	10	5.680	11	5.568	12	5.284
13	5.675	14	5.542	15	5.406	16	5.426
17	5.346	18	5.327	19	5.558	20	5.423
21	5.285	22	5.434	23	5.720	24	5.538
25	5.357	26	5.286	27	5.362	28	5.522
29	5.520	30	5.438	31	5.418	32	5.448
33	5.605	34	5.451	35	5.516	36	5.319
37	5.694	38	5.671	39	5.518	40	5.553
41	5.252	42	5.395	43	5.482	44	5.419
45	5.397	46	5.716	47	5.349	48	5.661
49	5.296	50	5.693	51	5.414	52	5.670
53	5.356	54	5.527	55	5.704	56	5.566
57	5.429	58	5.592	59	5.353	60	5.361
61	5.475	62	5.636	63	5.508	64	5.718
65	5.484	66	5.405	67	5.348	68	5.650
69	5.412	70	5.607	71	5.294	72	5.721
73	5.565	74	5.379	75	5.279	76	5.433
77	5.578	78	5.610	79	5.477	80	5.571
81	5.276	82	5.495	83	5.308	84	5.698
85	5.572	86	5.398	87	5.387	88	5.597
89	5.688	90	5.590	91	5.485	92	5.497
93	5.253	94	5.617	95	5.632	96	5.363
97	5.628	98	5.376	99	5.282	100	5.490

Hopping Frequency Sequence Name: HOP_FREQ_SEQ_05

SEQ#	Frequency (GHz)	SEQ#	Frequency (GHz)	SEQ#	Frequency (GHz)	SEQ#	Frequency (GHz)
1	5.535	2	5.444	3	5.468	4	5.719
5	5.264	6	5.349	7	5.554	8	5.387
9	5.462	10	5.632	11	5.490	12	5.478
13	5.340	14	5.494	15	5.323	16	5.320
17	5.560	18	5.435	19	5.367	20	5.544
21	5.519	22	5.401	23	5.616	24	5.485
25	5.477	26	5.482	27	5.669	28	5.553
29	5.682	30	5.308	31	5.293	32	5.496
33	5.480	34	5.593	35	5.268	36	5.324
37	5.657	38	5.587	39	5.712	40	5.635
41	5.473	42	5.441	43	5.442	44	5.649
45	5.597	46	5.517	47	5.279	48	5.454
49	5.689	50	5.456	51	5.529	52	5.391
53	5.515	54	5.350	55	5.434	56	5.505
57	5.539	58	5.582	59	5.604	60	5.370
61	5.413	62	5.414	63	5.285	64	5.605
65	5.648	66	5.345	67	5.489	68	5.671
69	5.540	70	5.289	71	5.598	72	5.542
73	5.636	74	5.381	75	5.347	76	5.522
77	5.711	78	5.693	79	5.319	80	5.431
81	5.501	82	5.486	83	5.280	84	5.647
85	5.398	86	5.259	87	5.570	88	5.504
89	5.558	90	5.426	91	5.706	92	5.291
93	5.253	94	5.662	95	5.362	96	5.667
97	5.590	98	5.569	99	5.531	100	5.405

Hopping Frequency Sequence Name: HOP_FREQ_SEQ_06

SEQ#	Frequency (GHz)	SEQ#	Frequency (GHz)	SEQ#	Frequency (GHz)	SEQ#	Frequency (GHz)
1	5.642	2	5.685	3	5.613	4	5.701
5	5.526	6	5.604	7	5.329	8	5.551
9	5.624	10	5.389	11	5.696	12	5.599
13	5.323	14	5.274	15	5.293	16	5.416
17	5.720	18	5.453	19	5.655	20	5.608
21	5.344	22	5.349	23	5.399	24	5.605
25	5.326	26	5.693	27	5.674	28	5.255
29	5.370	30	5.285	31	5.666	32	5.578
33	5.260	34	5.275	35	5.409	36	5.715
37	5.660	38	5.460	39	5.324	40	5.509
41	5.712	42	5.312	43	5.480	44	5.375
45	5.681	46	5.631	47	5.714	48	5.512
49	5.445	50	5.514	51	5.354	52	5.483
53	5.490	54	5.654	55	5.386	56	5.291
57	5.476	58	5.716	59	5.362	60	5.265
61	5.680	62	5.439	63	5.541	64	5.573
65	5.682	66	5.644	67	5.414	68	5.422
69	5.668	70	5.677	71	5.609	72	5.705
73	5.473	74	5.517	75	5.482	76	5.549
77	5.360	78	5.485	79	5.684	80	5.317
81	5.264	82	5.711	83	5.355	84	5.596
85	5.300	86	5.592	87	5.303	88	5.594
89	5.579	90	5.649	91	5.340	92	5.667
93	5.643	94	5.575	95	5.396	96	5.436
97	5.437	98	5.408	99	5.561	100	5.421

Hopping Frequency Sequence Name: HOP_FREQ_SEQ_07

SEQ#	Frequency (GHz)	SEQ#	Frequency (GHz)	SEQ#	Frequency (GHz)	SEQ#	Frequency (GHz)
1	5.597	2	5.360	3	5.666	4	5.431
5	5.587	6	5.521	7	5.471	8	5.553
9	5.676	10	5.338	11	5.722	12	5.347
13	5.458	14	5.498	15	5.620	16	5.641
17	5.596	18	5.295	19	5.317	20	5.605
21	5.532	22	5.650	23	5.558	24	5.700
25	5.495	26	5.481	27	5.485	28	5.390
29	5.656	30	5.648	31	5.365	32	5.708
33	5.371	34	5.441	35	5.702	36	5.504
37	5.261	38	5.398	39	5.392	40	5.572
41	5.683	42	5.567	43	5.585	44	5.623
45	5.569	46	5.256	47	5.505	48	5.649
49	5.426	50	5.264	51	5.640	52	5.690
53	5.520	54	5.466	55	5.593	56	5.568
57	5.325	58	5.383	59	5.300	60	5.389
61	5.469	62	5.253	63	5.285	64	5.724
65	5.538	66	5.467	67	5.519	68	5.686
69	5.539	70	5.313	71	5.713	72	5.312
73	5.654	74	5.299	75	5.446	76	5.366
77	5.320	78	5.479	79	5.492	80	5.340
81	5.548	82	5.671	83	5.698	84	5.674
85	5.343	86	5.710	87	5.443	88	5.503
89	5.599	90	5.474	91	5.502	92	5.437
93	5.263	94	5.604	95	5.393	96	5.372
97	5.369	98	5.262	99	5.711	100	5.527

Hopping Frequency Sequence Name: HOP_FREQ_SEQ_08

SEQ#	Frequency (GHz)	SEQ#	Frequency (GHz)	SEQ#	Frequency (GHz)	SEQ#	Frequency (GHz)
1	5.667	2	5.626	3	5.314	4	5.440
5	5.527	6	5.365	7	5.653	8	5.652
9	5.469	10	5.694	11	5.496	12	5.634
13	5.517	14	5.354	15	5.481	16	5.505
17	5.292	18	5.254	19	5.569	20	5.649
21	5.433	22	5.604	23	5.404	24	5.349
25	5.416	26	5.551	27	5.603	28	5.561
29	5.386	30	5.648	31	5.369	32	5.252
33	5.635	34	5.605	35	5.399	36	5.485
37	5.391	38	5.641	39	5.518	40	5.607
41	5.529	42	5.590	43	5.520	44	5.514
45	5.409	46	5.336	47	5.567	48	5.679
49	5.698	50	5.594	51	5.564	52	5.419
53	5.657	54	5.668	55	5.689	56	5.306
57	5.385	58	5.278	59	5.688	60	5.423
61	5.674	62	5.536	63	5.544	64	5.435
65	5.251	66	5.601	67	5.438	68	5.280
69	5.260	70	5.288	71	5.711	72	5.389
73	5.640	74	5.556	75	5.664	76	5.718
77	5.677	78	5.651	79	5.277	80	5.420
81	5.300	82	5.683	83	5.573	84	5.702
85	5.256	86	5.684	87	5.533	88	5.362
89	5.443	90	5.712	91	5.612	92	5.606
93	5.491	94	5.364	95	5.338	96	5.417
97	5.428	98	5.553	99	5.595	100	5.583

Hopping Frequency Sequence Name: HOP_FREQ_SEQ_09

SEQ#	Frequency (GHz)	SEQ#	Frequency (GHz)	SEQ#	Frequency (GHz)	SEQ#	Frequency (GHz)
1	5.652	2	5.260	3	5.508	4	5.643
5	5.653	6	5.659	7	5.381	8	5.683
9	5.724	10	5.711	11	5.577	12	5.333
13	5.682	14	5.307	15	5.258	16	5.603
17	5.605	18	5.534	19	5.520	20	5.491
21	5.367	22	5.672	23	5.355	24	5.372
25	5.651	26	5.541	27	5.274	28	5.666
29	5.498	30	5.336	31	5.420	32	5.701
33	5.496	34	5.707	35	5.361	36	5.608
37	5.582	38	5.631	39	5.289	40	5.386
41	5.568	42	5.671	43	5.455	44	5.279
45	5.558	46	5.595	47	5.363	48	5.352
49	5.549	50	5.434	51	5.602	52	5.362
53	5.379	54	5.419	55	5.554	56	5.686
57	5.366	58	5.516	59	5.285	60	5.405
61	5.319	62	5.596	63	5.394	64	5.385
65	5.356	66	5.300	67	5.641	68	5.280
69	5.332	70	5.626	71	5.674	72	5.295
73	5.664	74	5.600	75	5.523	76	5.440
77	5.286	78	5.490	79	5.259	80	5.593
81	5.531	82	5.634	83	5.489	84	5.559
85	5.527	86	5.578	87	5.322	88	5.589
89	5.709	90	5.525	91	5.535	92	5.537
93	5.636	94	5.521	95	5.323	96	5.716
97	5.611	98	5.632	99	5.282	100	5.598

Hopping Frequency Sequence Name: HOP_FREQ_SEQ_10

SEQ#	Frequency (GHz)	SEQ#	Frequency (GHz)	SEQ#	Frequency (GHz)	SEQ#	Frequency (GHz)
1	5.448	2	5.353	3	5.542	4	5.384
5	5.676	6	5.609	7	5.518	8	5.454
9	5.662	10	5.516	11	5.357	12	5.406
13	5.491	14	5.438	15	5.408	16	5.263
17	5.625	18	5.559	19	5.652	20	5.280
21	5.577	22	5.254	23	5.556	24	5.472
25	5.672	26	5.282	27	5.639	28	5.527
29	5.612	30	5.569	31	5.555	32	5.630
33	5.347	34	5.607	35	5.647	36	5.425
37	5.422	38	5.329	39	5.501	40	5.704
41	5.364	42	5.374	43	5.702	44	5.554
45	5.644	46	5.277	47	5.626	48	5.418
49	5.587	50	5.604	51	5.677	52	5.558
53	5.568	54	5.534	55	5.497	56	5.401
57	5.252	58	5.466	59	5.571	60	5.584
61	5.714	62	5.682	63	5.552	64	5.610
65	5.597	66	5.392	67	5.370	68	5.456
69	5.316	70	5.274	71	5.506	72	5.523
73	5.537	74	5.533	75	5.546	76	5.645
77	5.276	78	5.505	79	5.484	80	5.684
81	5.679	82	5.259	83	5.285	84	5.668
85	5.723	86	5.656	87	5.673	88	5.255
89	5.594	90	5.339	91	5.268	92	5.502
93	5.496	94	5.503	95	5.323	96	5.273
97	5.342	98	5.711	99	5.410	100	5.661

Hopping Frequency Sequence Name: HOP_FREQ_SEQ_11

SEQ#	Frequency (GHz)	SEQ#	Frequency (GHz)	SEQ#	Frequency (GHz)	SEQ#	Frequency (GHz)
1	5.407	2	5.441	3	5.498	4	5.515
5	5.358	6	5.316	7	5.659	8	5.695
9	5.542	10	5.393	11	5.592	12	5.682
13	5.332	14	5.675	15	5.608	16	5.588
17	5.578	18	5.291	19	5.614	20	5.282
21	5.648	22	5.476	23	5.273	24	5.312
25	5.697	26	5.658	27	5.349	28	5.600
29	5.279	30	5.431	31	5.484	32	5.372
33	5.283	34	5.378	35	5.401	36	5.505
37	5.471	38	5.295	39	5.470	40	5.341
41	5.669	42	5.366	43	5.290	44	5.475
45	5.549	46	5.633	47	5.430	48	5.539
49	5.425	50	5.387	51	5.511	52	5.373
53	5.514	54	5.634	55	5.297	56	5.461
57	5.392	58	5.516	59	5.270	60	5.280
61	5.427	62	5.570	63	5.289	64	5.310
65	5.411	66	5.412	67	5.711	68	5.568
69	5.386	70	5.655	71	5.409	72	5.374
73	5.437	74	5.302	75	5.617	76	5.572
77	5.370	78	5.667	79	5.601	80	5.447
81	5.551	82	5.525	83	5.292	84	5.481
85	5.571	86	5.605	87	5.395	88	5.496
89	5.402	90	5.644	91	5.631	92	5.432
93	5.694	94	5.662	95	5.540	96	5.489
97	5.463	98	5.521	99	5.486	100	5.616

Hopping Frequency Sequence Name: HOP_FREQ_SEQ_12

SEQ#	Frequency (GHz)	SEQ#	Frequency (GHz)	SEQ#	Frequency (GHz)	SEQ#	Frequency (GHz)
1	5.544	2	5.339	3	5.529	4	5.472
5	5.508	6	5.431	7	5.596	8	5.270
9	5.327	10	5.379	11	5.662	12	5.462
13	5.273	14	5.617	15	5.651	16	5.377
17	5.686	18	5.415	19	5.488	20	5.380
21	5.351	22	5.688	23	5.260	24	5.530
25	5.589	26	5.703	27	5.632	28	5.609
29	5.333	30	5.286	31	5.507	32	5.693
33	5.664	34	5.582	35	5.461	36	5.358
37	5.667	38	5.555	39	5.367	40	5.570
41	5.711	42	5.372	43	5.537	44	5.267
45	5.301	46	5.585	47	5.288	48	5.583
49	5.398	50	5.421	51	5.291	52	5.445
53	5.541	54	5.504	55	5.384	56	5.299
57	5.543	58	5.556	59	5.496	60	5.477
61	5.423	62	5.678	63	5.624	64	5.353
65	5.413	66	5.296	67	5.706	68	5.685
69	5.473	70	5.722	71	5.424	72	5.525
73	5.674	74	5.359	75	5.325	76	5.489
77	5.614	78	5.622	79	5.294	80	5.573
81	5.494	82	5.326	83	5.394	84	5.482
85	5.650	86	5.435	87	5.659	88	5.400
89	5.637	90	5.355	91	5.258	92	5.449
93	5.718	94	5.676	95	5.447	96	5.549
97	5.640	98	5.645	99	5.276	100	5.533

Hopping Frequency Sequence Name: HOP_FREQ_SEQ_13

SEQ#	Frequency (GHz)	SEQ#	Frequency (GHz)	SEQ#	Frequency (GHz)	SEQ#	Frequency (GHz)
1	5.358	2	5.430	3	5.615	4	5.653
5	5.439	6	5.310	7	5.399	8	5.722
9	5.721	10	5.494	11	5.352	12	5.449
13	5.538	14	5.337	15	5.438	16	5.262
17	5.307	18	5.409	19	5.503	20	5.419
21	5.487	22	5.282	23	5.417	24	5.295
25	5.644	26	5.622	27	5.383	28	5.334
29	5.692	30	5.658	31	5.598	32	5.372
33	5.573	34	5.576	35	5.491	36	5.621
37	5.380	38	5.586	39	5.527	40	5.698
41	5.342	42	5.275	43	5.492	44	5.630
45	5.529	46	5.724	47	5.269	48	5.411
49	5.474	50	5.608	51	5.553	52	5.602
53	5.429	54	5.478	55	5.312	56	5.318
57	5.673	58	5.297	59	5.369	60	5.377
61	5.375	62	5.285	63	5.558	64	5.260
65	5.390	66	5.268	67	5.656	68	5.370
69	5.596	70	5.605	71	5.591	72	5.629
73	5.506	74	5.351	75	5.281	76	5.336
77	5.524	78	5.521	79	5.461	80	5.367
81	5.296	82	5.347	83	5.435	84	5.329
85	5.340	86	5.299	87	5.680	88	5.448
89	5.261	90	5.510	91	5.265	92	5.555
93	5.595	94	5.457	95	5.280	96	5.359
97	5.410	98	5.509	99	5.379	100	5.447

Hopping Frequency Sequence Name: HOP_FREQ_SEQ_14

SEQ#	Frequency (GHz)	SEQ#	Frequency (GHz)	SEQ#	Frequency (GHz)	SEQ#	Frequency (GHz)
1	5.393	2	5.673	3	5.362	4	5.390
5	5.528	6	5.625	7	5.315	8	5.383
9	5.653	10	5.342	11	5.572	12	5.613
13	5.252	14	5.520	15	5.685	16	5.292
17	5.268	18	5.450	19	5.259	20	5.674
21	5.321	22	5.371	23	5.531	24	5.381
25	5.284	26	5.403	27	5.599	28	5.549
29	5.400	30	5.482	31	5.281	32	5.454
33	5.689	34	5.290	35	5.481	36	5.540
37	5.571	38	5.368	39	5.440	40	5.555
41	5.607	42	5.399	43	5.713	44	5.301
45	5.423	46	5.369	47	5.445	48	5.566
49	5.574	50	5.724	51	5.639	52	5.406
53	5.407	54	5.543	55	5.476	56	5.660
57	5.633	58	5.700	59	5.417	60	5.439
61	5.589	62	5.585	63	5.435	64	5.500
65	5.715	66	5.280	67	5.697	68	5.366
69	5.442	70	5.558	71	5.286	72	5.448
73	5.716	74	5.508	75	5.634	76	5.488
77	5.657	78	5.554	79	5.461	80	5.721
81	5.517	82	5.269	83	5.584	84	5.693
85	5.587	86	5.502	87	5.431	88	5.405
89	5.272	90	5.707	91	5.667	92	5.418
93	5.662	94	5.387	95	5.610	96	5.536
97	5.485	98	5.605	99	5.526	100	5.279

Hopping Frequency Sequence Name: HOP_FREQ_SEQ_15

SEQ#	Frequency (GHz)	SEQ#	Frequency (GHz)	SEQ#	Frequency (GHz)	SEQ#	Frequency (GHz)
1	5.293	2	5.401	3	5.260	4	5.640
5	5.308	6	5.684	7	5.527	8	5.417
9	5.419	10	5.660	11	5.495	12	5.628
13	5.363	14	5.470	15	5.517	16	5.412
17	5.446	18	5.302	19	5.567	20	5.712
21	5.272	22	5.335	23	5.582	24	5.500
25	5.311	26	5.550	27	5.378	28	5.601
29	5.671	30	5.667	31	5.452	32	5.271
33	5.283	34	5.719	35	5.536	36	5.652
37	5.526	38	5.481	39	5.657	40	5.254
41	5.343	42	5.505	43	5.542	44	5.483
45	5.342	46	5.259	47	5.710	48	5.545
49	5.410	50	5.516	51	5.489	52	5.696
53	5.512	54	5.554	55	5.571	56	5.433
57	5.445	58	5.634	59	5.345	60	5.434
61	5.716	62	5.613	63	5.541	64	5.268
65	5.282	66	5.252	67	5.442	68	5.488
69	5.703	70	5.586	71	5.349	72	5.544
73	5.325	74	5.514	75	5.456	76	5.508
77	5.403	78	5.387	79	5.406	80	5.653
81	5.497	82	5.454	83	5.307	84	5.430
85	5.377	86	5.431	87	5.382	88	5.539
89	5.251	90	5.420	91	5.638	92	5.676
93	5.592	94	5.579	95	5.463	96	5.678
97	5.262	98	5.364	99	5.388	100	5.261

Hopping Frequency Sequence Name: HOP_FREQ_SEQ_16

SEQ#	Frequency (GHz)	SEQ#	Frequency (GHz)	SEQ#	Frequency (GHz)	SEQ#	Frequency (GHz)
1	5.700	2	5.350	3	5.410	4	5.401
5	5.669	6	5.409	7	5.462	8	5.338
9	5.266	10	5.526	11	5.681	12	5.337
13	5.420	14	5.267	15	5.516	16	5.629
17	5.389	18	5.299	19	5.490	20	5.398
21	5.380	22	5.418	23	5.523	24	5.655
25	5.360	26	5.328	27	5.397	28	5.639
29	5.417	30	5.423	31	5.540	32	5.342
33	5.656	34	5.296	35	5.491	36	5.635
37	5.395	38	5.255	39	5.556	40	5.254
41	5.278	42	5.648	43	5.295	44	5.576
45	5.686	46	5.569	47	5.439	48	5.476
49	5.614	50	5.422	51	5.336	52	5.367
53	5.259	54	5.461	55	5.566	56	5.702
57	5.345	58	5.307	59	5.319	60	5.289
61	5.517	62	5.281	63	5.581	64	5.673
65	5.489	66	5.339	67	5.436	68	5.352
69	5.440	70	5.634	71	5.504	72	5.411
73	5.407	74	5.625	75	5.601	76	5.678
77	5.671	78	5.282	79	5.710	80	5.324
81	5.264	82	5.536	83	5.633	84	5.499
85	5.271	86	5.568	87	5.559	88	5.644
89	5.514	90	5.664	91	5.326	92	5.294
93	5.646	94	5.315	95	5.340	96	5.408
97	5.638	98	5.599	99	5.670	100	5.561

Hopping Frequency Sequence Name: HOP_FREQ_SEQ_17

SEQ#	Frequency (GHz)	SEQ#	Frequency (GHz)	SEQ#	Frequency (GHz)	SEQ#	Frequency (GHz)
1	5.563	2	5.478	3	5.723	4	5.319
5	5.374	6	5.492	7	5.469	8	5.292
9	5.525	10	5.252	11	5.350	12	5.608
13	5.323	14	5.681	15	5.388	16	5.545
17	5.291	18	5.517	19	5.253	20	5.383
21	5.489	22	5.654	23	5.704	24	5.616
25	5.621	26	5.593	27	5.435	28	5.332
29	5.420	30	5.375	31	5.587	32	5.610
33	5.498	34	5.376	35	5.661	36	5.596
37	5.413	38	5.269	39	5.701	40	5.510
41	5.266	42	5.626	43	5.516	44	5.483
45	5.467	46	5.518	47	5.586	48	5.255
49	5.512	50	5.315	51	5.639	52	5.316
53	5.667	54	5.625	55	5.495	56	5.560
57	5.455	58	5.286	59	5.324	60	5.678
61	5.555	62	5.594	63	5.662	64	5.505
65	5.320	66	5.685	67	5.282	68	5.335
69	5.677	70	5.585	71	5.526	72	5.670
73	5.400	74	5.541	75	5.488	76	5.477
77	5.480	78	5.507	79	5.449	80	5.385
81	5.473	82	5.412	83	5.714	84	5.549
85	5.690	86	5.295	87	5.619	88	5.683
89	5.411	90	5.343	91	5.664	92	5.637
93	5.351	94	5.285	95	5.691	96	5.554
97	5.415	98	5.530	99	5.692	100	5.452

Hopping Frequency Sequence Name: HOP_FREQ_SEQ_18

SEQ#	Frequency (GHz)	SEQ#	Frequency (GHz)	SEQ#	Frequency (GHz)	SEQ#	Frequency (GHz)
1	5.497	2	5.599	3	5.670	4	5.665
5	5.351	6	5.278	7	5.388	8	5.600
9	5.263	10	5.572	11	5.364	12	5.532
13	5.643	14	5.487	15	5.486	16	5.631
17	5.515	18	5.492	19	5.373	20	5.442
21	5.358	22	5.293	23	5.562	24	5.355
25	5.496	26	5.467	27	5.679	28	5.707
29	5.607	30	5.513	31	5.489	32	5.485
33	5.320	34	5.418	35	5.621	36	5.416
37	5.522	38	5.407	39	5.303	40	5.357
41	5.378	42	5.542	43	5.678	44	5.452
45	5.574	46	5.449	47	5.546	48	5.610
49	5.434	50	5.613	51	5.650	52	5.469
53	5.281	54	5.608	55	5.524	56	5.529
57	5.428	58	5.661	59	5.544	60	5.512
61	5.393	62	5.411	63	5.471	64	5.462
65	5.504	66	5.399	67	5.638	68	5.298
69	5.395	70	5.553	71	5.273	72	5.578
73	5.463	74	5.423	75	5.307	76	5.516
77	5.507	78	5.480	79	5.360	80	5.721
81	5.598	82	5.376	83	5.494	84	5.398
85	5.595	86	5.521	87	5.305	88	5.446
89	5.275	90	5.443	91	5.316	92	5.437
93	5.549	94	5.693	95	5.269	96	5.295
97	5.668	98	5.586	99	5.719	100	5.615

Hopping Frequency Sequence Name: HOP_FREQ_SEQ_19

SEQ#	Frequency (GHz)	SEQ#	Frequency (GHz)	SEQ#	Frequency (GHz)	SEQ#	Frequency (GHz)
1	5.691	2	5.551	3	5.579	4	5.350
5	5.688	6	5.622	7	5.294	8	5.547
9	5.460	10	5.446	11	5.270	12	5.541
13	5.620	14	5.571	15	5.384	16	5.633
17	5.477	18	5.503	19	5.553	20	5.629
21	5.472	22	5.542	23	5.528	24	5.544
25	5.613	26	5.700	27	5.434	28	5.358
29	5.525	30	5.305	31	5.644	32	5.516
33	5.648	34	5.684	35	5.488	36	5.478
37	5.498	38	5.335	39	5.441	40	5.361
41	5.411	42	5.420	43	5.396	44	5.515
45	5.353	46	5.266	47	5.451	48	5.386
49	5.617	50	5.588	51	5.374	52	5.532
53	5.666	54	5.669	55	5.314	56	5.431
57	5.520	58	5.306	59	5.272	60	5.279
61	5.634	62	5.654	63	5.619	64	5.504
65	5.334	66	5.685	67	5.690	68	5.646
69	5.575	70	5.641	71	5.297	72	5.282
73	5.713	74	5.479	75	5.663	76	5.695
77	5.492	78	5.493	79	5.668	80	5.327
81	5.288	82	5.296	83	5.413	84	5.511
85	5.486	86	5.597	87	5.286	88	5.661
89	5.421	90	5.405	91	5.536	92	5.719
93	5.518	94	5.590	95	5.608	96	5.408
97	5.582	98	5.303	99	5.449	100	5.414

Hopping Frequency Sequence Name: HOP_FREQ_SEQ_20

SEQ#	Frequency (GHz)	SEQ#	Frequency (GHz)	SEQ#	Frequency (GHz)	SEQ#	Frequency (GHz)
1	5.680	2	5.483	3	5.416	4	5.549
5	5.475	6	5.321	7	5.633	8	5.278
9	5.311	10	5.524	11	5.678	12	5.521
13	5.605	14	5.367	15	5.691	16	5.672
17	5.370	18	5.504	19	5.488	20	5.433
21	5.465	22	5.282	23	5.266	24	5.701
25	5.709	26	5.267	27	5.445	28	5.385
29	5.623	30	5.299	31	5.419	32	5.707
33	5.617	34	5.322	35	5.498	36	5.632
37	5.649	38	5.546	39	5.446	40	5.541
41	5.599	42	5.630	43	5.256	44	5.568
45	5.566	46	5.537	47	5.534	48	5.277
49	5.618	50	5.374	51	5.455	52	5.283
53	5.564	54	5.312	55	5.693	56	5.436
57	5.338	58	5.372	59	5.272	60	5.369
61	5.696	62	5.507	63	5.695	64	5.529
65	5.317	66	5.384	67	5.297	68	5.494
69	5.366	70	5.705	71	5.300	72	5.715
73	5.481	74	5.287	75	5.698	76	5.301
77	5.655	78	5.670	79	5.264	80	5.420
81	5.262	82	5.676	83	5.683	84	5.394
85	5.540	86	5.337	87	5.326	88	5.431
89	5.381	90	5.505	91	5.515	92	5.275
93	5.408	94	5.690	95	5.306	96	5.359
97	5.427	98	5.342	99	5.356	100	5.462

Hopping Frequency Sequence Name: HOP_FREQ_SEQ_21

SEQ#	Frequency (GHz)	SEQ#	Frequency (GHz)	SEQ#	Frequency (GHz)	SEQ#	Frequency (GHz)
1	5.600	2	5.680	3	5.444	4	5.459
5	5.718	6	5.298	7	5.441	8	5.605
9	5.622	10	5.505	11	5.286	12	5.634
13	5.683	14	5.583	15	5.428	16	5.667
17	5.570	18	5.549	19	5.553	20	5.353
21	5.602	22	5.544	23	5.377	24	5.341
25	5.677	26	5.713	27	5.629	28	5.321
29	5.483	30	5.363	31	5.636	32	5.504
33	5.595	34	5.384	35	5.474	36	5.625
37	5.269	38	5.624	39	5.665	40	5.375
41	5.712	42	5.345	43	5.418	44	5.457
45	5.311	46	5.656	47	5.507	48	5.429
49	5.440	50	5.320	51	5.540	52	5.477
53	5.411	54	5.561	55	5.352	56	5.317
57	5.497	58	5.423	59	5.576	60	5.367
61	5.509	62	5.472	63	5.641	64	5.597
65	5.559	66	5.585	67	5.626	68	5.336
69	5.271	70	5.313	71	5.420	72	5.448
73	5.443	74	5.381	75	5.647	76	5.431
77	5.370	78	5.580	79	5.323	80	5.548
81	5.430	82	5.596	83	5.523	84	5.530
85	5.560	86	5.592	87	5.314	88	5.422
89	5.607	90	5.385	91	5.628	92	5.421
93	5.463	94	5.437	95	5.646	96	5.648
97	5.536	98	5.296	99	5.312	100	5.409

Hopping Frequency Sequence Name: HOP_FREQ_SEQ_22

SEQ#	Frequency (GHz)	SEQ#	Frequency (GHz)	SEQ#	Frequency (GHz)	SEQ#	Frequency (GHz)
1	5.290	2	5.317	3	5.630	4	5.724
5	5.411	6	5.700	7	5.507	8	5.263
9	5.308	10	5.568	11	5.400	12	5.252
13	5.499	14	5.570	15	5.528	16	5.461
17	5.638	18	5.399	19	5.398	20	5.254
21	5.684	22	5.616	23	5.659	24	5.285
25	5.640	26	5.647	27	5.357	28	5.279
29	5.324	30	5.323	31	5.327	32	5.626
33	5.722	34	5.345	35	5.302	36	5.483
37	5.702	38	5.384	39	5.305	40	5.651
41	5.498	42	5.693	43	5.255	44	5.564
45	5.299	46	5.482	47	5.446	48	5.704
49	5.459	50	5.582	51	5.288	52	5.720
53	5.335	54	5.286	55	5.541	56	5.457
57	5.272	58	5.365	59	5.529	60	5.618
61	5.441	62	5.581	63	5.386	64	5.650
65	5.580	66	5.612	67	5.601	68	5.557
69	5.486	70	5.608	71	5.511	72	5.664
73	5.675	74	5.525	75	5.567	76	5.678
77	5.586	78	5.336	79	5.291	80	5.387
81	5.625	82	5.356	83	5.412	84	5.706
85	5.591	86	5.688	87	5.374	88	5.401
89	5.510	90	5.624	91	5.321	92	5.339
93	5.466	94	5.475	95	5.655	96	5.328
97	5.513	98	5.686	99	5.352	100	5.261

Hopping Frequency Sequence Name: HOP_FREQ_SEQ_23

SEQ#	Frequency (GHz)	SEQ#	Frequency (GHz)	SEQ#	Frequency (GHz)	SEQ#	Frequency (GHz)
1	5.367	2	5.276	3	5.659	4	5.686
5	5.388	6	5.552	7	5.452	8	5.285
9	5.475	10	5.441	11	5.514	12	5.266
13	5.432	14	5.462	15	5.545	16	5.348
17	5.442	18	5.489	19	5.271	20	5.277
21	5.542	22	5.594	23	5.411	24	5.517
25	5.613	26	5.275	27	5.426	28	5.661
29	5.286	30	5.595	31	5.645	32	5.688
33	5.357	34	5.690	35	5.543	36	5.364
37	5.497	38	5.393	39	5.435	40	5.345
41	5.482	42	5.344	43	5.570	44	5.593
45	5.715	46	5.602	47	5.548	48	5.451
49	5.633	50	5.471	51	5.605	52	5.324
53	5.550	54	5.526	55	5.445	56	5.651
57	5.289	58	5.582	59	5.535	60	5.251
61	5.549	62	5.362	63	5.527	64	5.294
65	5.539	66	5.423	67	5.268	68	5.400
69	5.368	70	5.684	71	5.553	72	5.703
73	5.460	74	5.436	75	5.448	76	5.309
77	5.290	78	5.260	79	5.444	80	5.588
81	5.530	82	5.682	83	5.418	84	5.560
85	5.320	86	5.486	87	5.404	88	5.428
89	5.663	90	5.401	91	5.580	92	5.484
93	5.495	94	5.319	95	5.267	96	5.618
97	5.431	98	5.327	99	5.252	100	5.547

Hopping Frequency Sequence Name: HOP_FREQ_SEQ_24

SEQ#	Frequency (GHz)	SEQ#	Frequency (GHz)	SEQ#	Frequency (GHz)	SEQ#	Frequency (GHz)
1	5.280	2	5.283	3	5.409	4	5.651
5	5.340	6	5.620	7	5.366	8	5.353
9	5.501	10	5.456	11	5.573	12	5.583
13	5.375	14	5.630	15	5.291	16	5.333
17	5.477	18	5.453	19	5.513	20	5.510
21	5.445	22	5.407	23	5.401	24	5.671
25	5.523	26	5.428	27	5.655	28	5.603
29	5.650	30	5.270	31	5.348	32	5.367
33	5.564	34	5.673	35	5.362	36	5.378
37	5.528	38	5.334	39	5.365	40	5.568
41	5.341	42	5.636	43	5.411	44	5.549
45	5.394	46	5.271	47	5.420	48	5.724
49	5.467	50	5.423	51	5.427	52	5.580
53	5.611	54	5.313	55	5.584	56	5.553
57	5.396	58	5.688	59	5.516	60	5.433
61	5.487	62	5.308	63	5.296	64	5.338
65	5.666	66	5.464	67	5.389	68	5.421
69	5.721	70	5.605	71	5.555	72	5.447
73	5.455	74	5.567	75	5.585	76	5.656
77	5.469	78	5.640	79	5.629	80	5.424
81	5.481	82	5.329	83	5.342	84	5.610
85	5.710	86	5.489	87	5.343	88	5.442
89	5.692	90	5.292	91	5.702	92	5.601
93	5.491	94	5.626	95	5.644	96	5.641
97	5.406	98	5.450	99	5.569	100	5.690

Hopping Frequency Sequence Name: HOP_FREQ_SEQ_25

SEQ#	Frequency (GHz)	SEQ#	Frequency (GHz)	SEQ#	Frequency (GHz)	SEQ#	Frequency (GHz)
1	5.615	2	5.657	3	5.676	4	5.592
5	5.327	6	5.300	7	5.337	8	5.680
9	5.448	10	5.690	11	5.417	12	5.567
13	5.604	14	5.694	15	5.516	16	5.503
17	5.312	18	5.598	19	5.696	20	5.383
21	5.718	22	5.475	23	5.603	24	5.464
25	5.425	26	5.677	27	5.320	28	5.367
29	5.313	30	5.436	31	5.463	32	5.699
33	5.565	34	5.371	35	5.411	36	5.659
37	5.661	38	5.649	39	5.391	40	5.589
41	5.452	42	5.410	43	5.484	44	5.302
45	5.692	46	5.270	47	5.386	48	5.279
49	5.601	50	5.513	51	5.602	52	5.673
53	5.501	54	5.557	55	5.494	56	5.254
57	5.571	58	5.264	59	5.573	60	5.440
61	5.281	62	5.423	63	5.358	64	5.500
65	5.701	66	5.525	67	5.446	68	5.369
69	5.499	70	5.582	71	5.717	72	5.664
73	5.515	74	5.514	75	5.461	76	5.631
77	5.719	78	5.606	79	5.483	80	5.449
81	5.458	82	5.447	83	5.616	84	5.482
85	5.453	86	5.263	87	5.542	88	5.399
89	5.469	90	5.275	91	5.295	92	5.291
93	5.416	94	5.444	95	5.599	96	5.522
97	5.640	98	5.632	99	5.472	100	5.583

Hopping Frequency Sequence Name: HOP_FREQ_SEQ_26

SEQ#	Frequency (GHz)	SEQ#	Frequency (GHz)	SEQ#	Frequency (GHz)	SEQ#	Frequency (GHz)
1	5.339	2	5.672	3	5.594	4	5.694
5	5.660	6	5.647	7	5.656	8	5.705
9	5.551	10	5.542	11	5.295	12	5.316
13	5.454	14	5.592	15	5.582	16	5.303
17	5.465	18	5.417	19	5.512	20	5.710
21	5.289	22	5.286	23	5.277	24	5.440
25	5.584	26	5.518	27	5.505	28	5.597
29	5.326	30	5.371	31	5.374	32	5.639
33	5.355	34	5.609	35	5.618	36	5.463
37	5.425	38	5.404	39	5.711	40	5.506
41	5.394	42	5.431	43	5.703	44	5.489
45	5.596	46	5.575	47	5.515	48	5.655
49	5.652	50	5.494	51	5.358	52	5.648
53	5.376	54	5.457	55	5.279	56	5.707
57	5.412	58	5.396	59	5.319	60	5.430
61	5.363	62	5.379	63	5.544	64	5.364
65	5.499	66	5.622	67	5.476	68	5.536
69	5.487	70	5.587	71	5.452	72	5.418
73	5.333	74	5.321	75	5.528	76	5.574
77	5.619	78	5.386	79	5.633	80	5.467
81	5.600	82	5.500	83	5.504	84	5.265
85	5.625	86	5.359	87	5.485	88	5.372
89	5.569	90	5.456	91	5.573	92	5.581
93	5.281	94	5.314	95	5.721	96	5.650
97	5.713	98	5.275	99	5.686	100	5.708

Hopping Frequency Sequence Name: HOP_FREQ_SEQ_27

SEQ#	Frequency (GHz)	SEQ#	Frequency (GHz)	SEQ#	Frequency (GHz)	SEQ#	Frequency (GHz)
1	5.452	2	5.650	3	5.373	4	5.568
5	5.602	6	5.448	7	5.593	8	5.367
9	5.529	10	5.515	11	5.598	12	5.338
13	5.380	14	5.524	15	5.371	16	5.401
17	5.522	18	5.411	19	5.715	20	5.590
21	5.300	22	5.691	23	5.433	24	5.430
25	5.670	26	5.318	27	5.319	28	5.333
29	5.260	30	5.425	31	5.530	32	5.708
33	5.722	34	5.712	35	5.501	36	5.654
37	5.485	38	5.424	39	5.638	40	5.445
41	5.564	42	5.439	43	5.376	44	5.442
45	5.619	46	5.552	47	5.347	48	5.408
49	5.316	50	5.643	51	5.269	52	5.484
53	5.687	54	5.419	55	5.573	56	5.473
57	5.327	58	5.293	59	5.611	60	5.475
61	5.537	62	5.583	63	5.444	64	5.661
65	5.551	66	5.255	67	5.364	68	5.349
69	5.574	70	5.588	71	5.680	72	5.497
73	5.585	74	5.534	75	5.365	76	5.721
77	5.469	78	5.488	79	5.406	80	5.348
81	5.504	82	5.671	83	5.651	84	5.375
85	5.286	86	5.507	87	5.414	88	5.519
89	5.684	90	5.438	91	5.520	92	5.265
93	5.404	94	5.711	95	5.586	96	5.657
97	5.302	98	5.575	99	5.490	100	5.464

Hopping Frequency Sequence Name: HOP_FREQ_SEQ_28

SEQ#	Frequency (GHz)	SEQ#	Frequency (GHz)	SEQ#	Frequency (GHz)	SEQ#	Frequency (GHz)
1	5.434	2	5.680	3	5.335	4	5.560
5	5.369	6	5.305	7	5.710	8	5.275
9	5.315	10	5.475	11	5.269	12	5.460
13	5.533	14	5.627	15	5.702	16	5.661
17	5.707	18	5.356	19	5.687	20	5.328
21	5.656	22	5.563	23	5.581	24	5.361
25	5.694	26	5.468	27	5.456	28	5.304
29	5.499	30	5.255	31	5.391	32	5.647
33	5.320	34	5.653	35	5.298	36	5.536
37	5.665	38	5.268	39	5.623	40	5.721
41	5.620	42	5.611	43	5.313	44	5.570
45	5.545	46	5.716	47	5.524	48	5.628
49	5.698	50	5.558	51	5.278	52	5.723
53	5.420	54	5.359	55	5.722	56	5.492
57	5.446	58	5.354	59	5.474	60	5.638
61	5.720	62	5.618	63	5.582	64	5.326
65	5.398	66	5.410	67	5.634	68	5.344
69	5.697	70	5.253	71	5.519	72	5.424
73	5.594	74	5.286	75	5.599	76	5.264
77	5.718	78	5.576	79	5.682	80	5.432
81	5.584	82	5.462	83	5.525	84	5.336
85	5.577	86	5.459	87	5.714	88	5.449
89	5.483	90	5.490	91	5.347	92	5.277
93	5.478	94	5.292	95	5.274	96	5.377
97	5.617	98	5.367	99	5.472	100	5.337

Hopping Frequency Sequence Name: HOP_FREQ_SEQ_29

SEQ#	Frequency (GHz)	SEQ#	Frequency (GHz)	SEQ#	Frequency (GHz)	SEQ#	Frequency (GHz)
1	5.410	2	5.585	3	5.609	4	5.523
5	5.304	6	5.466	7	5.262	8	5.617
9	5.311	10	5.677	11	5.590	12	5.283
13	5.305	14	5.601	15	5.404	16	5.690
17	5.302	18	5.655	19	5.668	20	5.389
21	5.412	22	5.709	23	5.286	24	5.631
25	5.626	26	5.487	27	5.257	28	5.491
29	5.328	30	5.345	31	5.651	32	5.275
33	5.605	34	5.430	35	5.588	36	5.705
37	5.289	38	5.694	39	5.365	40	5.307
41	5.673	42	5.288	43	5.458	44	5.363
45	5.573	46	5.424	47	5.654	48	5.354
49	5.548	50	5.696	51	5.440	52	5.701
53	5.629	54	5.390	55	5.334	56	5.507
57	5.434	58	5.724	59	5.485	60	5.444
61	5.527	62	5.428	63	5.360	64	5.377
65	5.542	66	5.641	67	5.423	68	5.446
69	5.483	70	5.478	71	5.537	72	5.293
73	5.612	74	5.476	75	5.445	76	5.702
77	5.596	78	5.388	79	5.544	80	5.499
81	5.621	82	5.353	83	5.402	84	5.603
85	5.650	86	5.469	87	5.327	88	5.313
89	5.721	90	5.432	91	5.646	92	5.680
93	5.640	94	5.295	95	5.606	96	5.604
97	5.539	98	5.325	99	5.468	100	5.484

Hopping Frequency Sequence Name: HOP_FREQ_SEQ_30

SEQ#	Frequency (GHz)	SEQ#	Frequency (GHz)	SEQ#	Frequency (GHz)	SEQ#	Frequency (GHz)
1	5.631	2	5.628	3	5.645	4	5.347
5	5.591	6	5.427	7	5.333	8	5.692
9	5.441	10	5.504	11	5.600	12	5.551
13	5.271	14	5.647	15	5.646	16	5.406
17	5.613	18	5.291	19	5.362	20	5.394
21	5.470	22	5.458	23	5.546	24	5.563
25	5.318	26	5.397	27	5.260	28	5.636
29	5.576	30	5.430	31	5.391	32	5.460
33	5.361	34	5.708	35	5.698	36	5.544
37	5.258	38	5.474	39	5.703	40	5.416
41	5.657	42	5.328	43	5.277	44	5.617
45	5.449	46	5.489	47	5.575	48	5.268
49	5.294	50	5.723	51	5.644	52	5.590
53	5.256	54	5.721	55	5.261	56	5.259
57	5.514	58	5.476	59	5.345	60	5.459
61	5.462	62	5.266	63	5.407	64	5.488
65	5.286	66	5.371	67	5.571	68	5.556
69	5.588	70	5.654	71	5.678	72	5.354
73	5.472	74	5.526	75	5.487	76	5.468
77	5.508	78	5.388	79	5.446	80	5.520
81	5.418	82	5.390	83	5.550	84	5.482
85	5.337	86	5.404	87	5.664	88	5.465
89	5.598	90	5.257	91	5.392	92	5.516
93	5.448	94	5.327	95	5.614	96	5.594
97	5.633	98	5.637	99	5.715	100	5.329

802.11b3 (EHT160)_Ch114

Hopping Frequency Sequence Name: HOP_FREQ_SEQ_01

SEQ#	Frequency (GHz)	SEQ#	Frequency (GHz)	SEQ#	Frequency (GHz)	SEQ#	Frequency (GHz)
1	5.540	2	5.513	3	5.526	4	5.574
5	5.501	6	5.717	7	5.590	8	5.373
9	5.338	10	5.534	11	5.388	12	5.493
13	5.447	14	5.554	15	5.593	16	5.566
17	5.688	18	5.715	19	5.350	20	5.713
21	5.404	22	5.374	23	5.571	24	5.420
25	5.588	26	5.277	27	5.407	28	5.610
29	5.278	30	5.710	31	5.366	32	5.301
33	5.666	34	5.551	35	5.531	36	5.339
37	5.410	38	5.303	39	5.267	40	5.538
41	5.327	42	5.701	43	5.358	44	5.581
45	5.408	46	5.584	47	5.477	48	5.357
49	5.703	50	5.376	51	5.683	52	5.413
53	5.662	54	5.423	55	5.632	56	5.668
57	5.619	58	5.281	59	5.429	60	5.289
61	5.306	62	5.337	63	5.596	64	5.286
65	5.592	66	5.379	67	5.362	68	5.351
69	5.433	70	5.271	71	5.384	72	5.614
73	5.504	74	5.296	75	5.712	76	5.452
77	5.687	78	5.533	79	5.599	80	5.561
81	5.293	82	5.300	83	5.302	84	5.718
85	5.291	86	5.456	87	5.505	88	5.636
89	5.367	90	5.348	91	5.527	92	5.558
93	5.640	94	5.559	95	5.436	96	5.613
97	5.472	98	5.707	99	5.607	100	5.680

Hopping Frequency Sequence Name: HOP_FREQ_SEQ_02

SEQ#	Frequency (GHz)	SEQ#	Frequency (GHz)	SEQ#	Frequency (GHz)	SEQ#	Frequency (GHz)
1	5.641	2	5.581	3	5.679	4	5.580
5	5.429	6	5.315	7	5.582	8	5.604
9	5.353	10	5.255	11	5.260	12	5.425
13	5.366	14	5.343	15	5.478	16	5.310
17	5.367	18	5.288	19	5.595	20	5.719
21	5.514	22	5.630	23	5.327	24	5.606
25	5.424	26	5.662	27	5.482	28	5.683
29	5.528	30	5.289	31	5.700	32	5.541
33	5.356	34	5.585	35	5.506	36	5.297
37	5.391	38	5.505	39	5.511	40	5.333
41	5.292	42	5.572	43	5.329	44	5.553
45	5.408	46	5.612	47	5.532	48	5.423
49	5.594	50	5.495	51	5.499	52	5.607
53	5.706	54	5.525	55	5.692	56	5.390
57	5.576	58	5.270	59	5.549	60	5.468
61	5.407	62	5.455	63	5.448	64	5.565
65	5.687	66	5.656	67	5.335	68	5.649
69	5.360	70	5.349	71	5.504	72	5.661
73	5.422	74	5.328	75	5.311	76	5.307
77	5.669	78	5.561	79	5.521	80	5.342
81	5.337	82	5.518	83	5.441	84	5.436
85	5.682	86	5.562	87	5.466	88	5.539
89	5.372	90	5.534	91	5.284	92	5.537
93	5.701	94	5.384	95	5.251	96	5.445
97	5.473	98	5.388	99	5.280	100	5.285

Hopping Frequency Sequence Name: HOP_FREQ_SEQ_03

SEQ#	Frequency (GHz)	SEQ#	Frequency (GHz)	SEQ#	Frequency (GHz)	SEQ#	Frequency (GHz)
1	5.284	2	5.304	3	5.456	4	5.489
5	5.670	6	5.409	7	5.574	8	5.448
9	5.581	10	5.467	11	5.637	12	5.651
13	5.641	14	5.407	15	5.281	16	5.321
17	5.428	18	5.355	19	5.260	20	5.276
21	5.435	22	5.640	23	5.683	24	5.333
25	5.382	26	5.712	27	5.391	28	5.401
29	5.554	30	5.383	31	5.261	32	5.315
33	5.563	34	5.326	35	5.652	36	5.393
37	5.280	38	5.352	39	5.588	40	5.595
41	5.498	42	5.618	43	5.596	44	5.307
45	5.720	46	5.495	47	5.542	48	5.469
49	5.617	50	5.623	51	5.723	52	5.440
53	5.350	54	5.338	55	5.332	56	5.602
57	5.277	58	5.367	59	5.572	60	5.611
61	5.294	62	5.584	63	5.529	64	5.678
65	5.501	66	5.267	67	5.536	68	5.301
69	5.516	70	5.650	71	5.664	72	5.662
73	5.263	74	5.458	75	5.528	76	5.707
77	5.717	78	5.418	79	5.560	80	5.604
81	5.644	82	5.396	83	5.416	84	5.514
85	5.526	86	5.699	87	5.443	88	5.674
89	5.411	90	5.671	91	5.510	92	5.257
93	5.436	94	5.424	95	5.459	96	5.273
97	5.685	98	5.463	99	5.288	100	5.275

Hopping Frequency Sequence Name: HOP_FREQ_SEQ_04

SEQ#	Frequency (GHz)	SEQ#	Frequency (GHz)	SEQ#	Frequency (GHz)	SEQ#	Frequency (GHz)
1	5.278	2	5.505	3	5.563	4	5.422
5	5.685	6	5.270	7	5.545	8	5.321
9	5.641	10	5.680	11	5.568	12	5.284
13	5.675	14	5.542	15	5.406	16	5.426
17	5.346	18	5.327	19	5.558	20	5.423
21	5.285	22	5.434	23	5.720	24	5.538
25	5.357	26	5.286	27	5.362	28	5.522
29	5.520	30	5.438	31	5.418	32	5.448
33	5.605	34	5.451	35	5.516	36	5.319
37	5.694	38	5.671	39	5.518	40	5.553
41	5.252	42	5.395	43	5.482	44	5.419
45	5.397	46	5.716	47	5.349	48	5.661
49	5.296	50	5.693	51	5.414	52	5.670
53	5.356	54	5.527	55	5.704	56	5.566
57	5.429	58	5.592	59	5.353	60	5.361
61	5.475	62	5.636	63	5.508	64	5.718
65	5.484	66	5.405	67	5.348	68	5.650
69	5.412	70	5.607	71	5.294	72	5.721
73	5.565	74	5.379	75	5.279	76	5.433
77	5.578	78	5.610	79	5.477	80	5.571
81	5.276	82	5.495	83	5.308	84	5.698
85	5.572	86	5.398	87	5.387	88	5.597
89	5.688	90	5.590	91	5.485	92	5.497
93	5.253	94	5.617	95	5.632	96	5.363
97	5.628	98	5.376	99	5.282	100	5.490

Hopping Frequency Sequence Name: HOP_FREQ_SEQ_05

SEQ#	Frequency (GHz)	SEQ#	Frequency (GHz)	SEQ#	Frequency (GHz)	SEQ#	Frequency (GHz)
1	5.535	2	5.444	3	5.468	4	5.719
5	5.264	6	5.349	7	5.554	8	5.387
9	5.462	10	5.632	11	5.490	12	5.478
13	5.340	14	5.494	15	5.323	16	5.320
17	5.560	18	5.435	19	5.367	20	5.544
21	5.519	22	5.401	23	5.616	24	5.485
25	5.477	26	5.482	27	5.669	28	5.553
29	5.682	30	5.308	31	5.293	32	5.496
33	5.480	34	5.593	35	5.268	36	5.324
37	5.657	38	5.587	39	5.712	40	5.635
41	5.473	42	5.441	43	5.442	44	5.649
45	5.597	46	5.517	47	5.279	48	5.454
49	5.689	50	5.456	51	5.529	52	5.391
53	5.515	54	5.350	55	5.434	56	5.505
57	5.539	58	5.582	59	5.604	60	5.370
61	5.413	62	5.414	63	5.285	64	5.605
65	5.648	66	5.345	67	5.489	68	5.671
69	5.540	70	5.289	71	5.598	72	5.542
73	5.636	74	5.381	75	5.347	76	5.522
77	5.711	78	5.693	79	5.319	80	5.431
81	5.501	82	5.486	83	5.280	84	5.647
85	5.398	86	5.259	87	5.570	88	5.504
89	5.558	90	5.426	91	5.706	92	5.291
93	5.253	94	5.662	95	5.362	96	5.667
97	5.590	98	5.569	99	5.531	100	5.405

Hopping Frequency Sequence Name: HOP_FREQ_SEQ_06

SEQ#	Frequency (GHz)	SEQ#	Frequency (GHz)	SEQ#	Frequency (GHz)	SEQ#	Frequency (GHz)
1	5.642	2	5.685	3	5.613	4	5.701
5	5.526	6	5.604	7	5.329	8	5.551
9	5.624	10	5.389	11	5.696	12	5.599
13	5.323	14	5.274	15	5.293	16	5.416
17	5.720	18	5.453	19	5.655	20	5.608
21	5.344	22	5.349	23	5.399	24	5.605
25	5.326	26	5.693	27	5.674	28	5.255
29	5.370	30	5.285	31	5.666	32	5.578
33	5.260	34	5.275	35	5.409	36	5.715
37	5.660	38	5.460	39	5.324	40	5.509
41	5.712	42	5.312	43	5.480	44	5.375
45	5.681	46	5.631	47	5.714	48	5.512
49	5.445	50	5.514	51	5.354	52	5.483
53	5.490	54	5.654	55	5.386	56	5.291
57	5.476	58	5.716	59	5.362	60	5.265
61	5.680	62	5.439	63	5.541	64	5.573
65	5.682	66	5.644	67	5.414	68	5.422
69	5.668	70	5.677	71	5.609	72	5.705
73	5.473	74	5.517	75	5.482	76	5.549
77	5.360	78	5.485	79	5.684	80	5.317
81	5.264	82	5.711	83	5.355	84	5.596
85	5.300	86	5.592	87	5.303	88	5.594
89	5.579	90	5.649	91	5.340	92	5.667
93	5.643	94	5.575	95	5.396	96	5.436
97	5.437	98	5.408	99	5.561	100	5.421

Hopping Frequency Sequence Name: HOP_FREQ_SEQ_07

SEQ#	Frequency (GHz)	SEQ#	Frequency (GHz)	SEQ#	Frequency (GHz)	SEQ#	Frequency (GHz)
1	5.597	2	5.360	3	5.666	4	5.431
5	5.587	6	5.521	7	5.471	8	5.553
9	5.676	10	5.338	11	5.722	12	5.347
13	5.458	14	5.498	15	5.620	16	5.641
17	5.596	18	5.295	19	5.317	20	5.605
21	5.532	22	5.650	23	5.558	24	5.700
25	5.495	26	5.481	27	5.485	28	5.390
29	5.656	30	5.648	31	5.365	32	5.708
33	5.371	34	5.441	35	5.702	36	5.504
37	5.261	38	5.398	39	5.392	40	5.572
41	5.683	42	5.567	43	5.585	44	5.623
45	5.569	46	5.256	47	5.505	48	5.649
49	5.426	50	5.264	51	5.640	52	5.690
53	5.520	54	5.466	55	5.593	56	5.568
57	5.325	58	5.383	59	5.300	60	5.389
61	5.469	62	5.253	63	5.285	64	5.724
65	5.538	66	5.467	67	5.519	68	5.686
69	5.539	70	5.313	71	5.713	72	5.312
73	5.654	74	5.299	75	5.446	76	5.366
77	5.320	78	5.479	79	5.492	80	5.340
81	5.548	82	5.671	83	5.698	84	5.674
85	5.343	86	5.710	87	5.443	88	5.503
89	5.599	90	5.474	91	5.502	92	5.437
93	5.263	94	5.604	95	5.393	96	5.372
97	5.369	98	5.262	99	5.711	100	5.527

Hopping Frequency Sequence Name: HOP_FREQ_SEQ_08

SEQ#	Frequency (GHz)	SEQ#	Frequency (GHz)	SEQ#	Frequency (GHz)	SEQ#	Frequency (GHz)
1	5.667	2	5.626	3	5.314	4	5.440
5	5.527	6	5.365	7	5.653	8	5.652
9	5.469	10	5.694	11	5.496	12	5.634
13	5.517	14	5.354	15	5.481	16	5.505
17	5.292	18	5.254	19	5.569	20	5.649
21	5.433	22	5.604	23	5.404	24	5.349
25	5.416	26	5.551	27	5.603	28	5.561
29	5.386	30	5.648	31	5.369	32	5.252
33	5.635	34	5.605	35	5.399	36	5.485
37	5.391	38	5.641	39	5.518	40	5.607
41	5.529	42	5.590	43	5.520	44	5.514
45	5.409	46	5.336	47	5.567	48	5.679
49	5.698	50	5.594	51	5.564	52	5.419
53	5.657	54	5.668	55	5.689	56	5.306
57	5.385	58	5.278	59	5.688	60	5.423
61	5.674	62	5.536	63	5.544	64	5.435
65	5.251	66	5.601	67	5.438	68	5.280
69	5.260	70	5.288	71	5.711	72	5.389
73	5.640	74	5.556	75	5.664	76	5.718
77	5.677	78	5.651	79	5.277	80	5.420
81	5.300	82	5.683	83	5.573	84	5.702
85	5.256	86	5.684	87	5.533	88	5.362
89	5.443	90	5.712	91	5.612	92	5.606
93	5.491	94	5.364	95	5.338	96	5.417
97	5.428	98	5.553	99	5.595	100	5.583

Hopping Frequency Sequence Name: HOP_FREQ_SEQ_09

SEQ#	Frequency (GHz)	SEQ#	Frequency (GHz)	SEQ#	Frequency (GHz)	SEQ#	Frequency (GHz)
1	5.652	2	5.260	3	5.508	4	5.643
5	5.653	6	5.659	7	5.381	8	5.683
9	5.724	10	5.711	11	5.577	12	5.333
13	5.682	14	5.307	15	5.258	16	5.603
17	5.605	18	5.534	19	5.520	20	5.491
21	5.367	22	5.672	23	5.355	24	5.372
25	5.651	26	5.541	27	5.274	28	5.666
29	5.498	30	5.336	31	5.420	32	5.701
33	5.496	34	5.707	35	5.361	36	5.608
37	5.582	38	5.631	39	5.289	40	5.386
41	5.568	42	5.671	43	5.455	44	5.279
45	5.558	46	5.595	47	5.363	48	5.352
49	5.549	50	5.434	51	5.602	52	5.362
53	5.379	54	5.419	55	5.554	56	5.686
57	5.366	58	5.516	59	5.285	60	5.405
61	5.319	62	5.596	63	5.394	64	5.385
65	5.356	66	5.300	67	5.641	68	5.280
69	5.332	70	5.626	71	5.674	72	5.295
73	5.664	74	5.600	75	5.523	76	5.440
77	5.286	78	5.490	79	5.259	80	5.593
81	5.531	82	5.634	83	5.489	84	5.559
85	5.527	86	5.578	87	5.322	88	5.589
89	5.709	90	5.525	91	5.535	92	5.537
93	5.636	94	5.521	95	5.323	96	5.716
97	5.611	98	5.632	99	5.282	100	5.598

Hopping Frequency Sequence Name: HOP_FREQ_SEQ_10

SEQ#	Frequency (GHz)	SEQ#	Frequency (GHz)	SEQ#	Frequency (GHz)	SEQ#	Frequency (GHz)
1	5.448	2	5.353	3	5.542	4	5.384
5	5.676	6	5.609	7	5.518	8	5.454
9	5.662	10	5.516	11	5.357	12	5.406
13	5.491	14	5.438	15	5.408	16	5.263
17	5.625	18	5.559	19	5.652	20	5.280
21	5.577	22	5.254	23	5.556	24	5.472
25	5.672	26	5.282	27	5.639	28	5.527
29	5.612	30	5.569	31	5.555	32	5.630
33	5.347	34	5.607	35	5.647	36	5.425
37	5.422	38	5.329	39	5.501	40	5.704
41	5.364	42	5.374	43	5.702	44	5.554
45	5.644	46	5.277	47	5.626	48	5.418
49	5.587	50	5.604	51	5.677	52	5.558
53	5.568	54	5.534	55	5.497	56	5.401
57	5.252	58	5.466	59	5.571	60	5.584
61	5.714	62	5.682	63	5.552	64	5.610
65	5.597	66	5.392	67	5.370	68	5.456
69	5.316	70	5.274	71	5.506	72	5.523
73	5.537	74	5.533	75	5.546	76	5.645
77	5.276	78	5.505	79	5.484	80	5.684
81	5.679	82	5.259	83	5.285	84	5.668
85	5.723	86	5.656	87	5.673	88	5.255
89	5.594	90	5.339	91	5.268	92	5.502
93	5.496	94	5.503	95	5.323	96	5.273
97	5.342	98	5.711	99	5.410	100	5.661

Hopping Frequency Sequence Name: HOP_FREQ_SEQ_11

SEQ#	Frequency (GHz)	SEQ#	Frequency (GHz)	SEQ#	Frequency (GHz)	SEQ#	Frequency (GHz)
1	5.407	2	5.441	3	5.498	4	5.515
5	5.358	6	5.316	7	5.659	8	5.695
9	5.542	10	5.393	11	5.592	12	5.682
13	5.332	14	5.675	15	5.608	16	5.588
17	5.578	18	5.291	19	5.614	20	5.282
21	5.648	22	5.476	23	5.273	24	5.312
25	5.697	26	5.658	27	5.349	28	5.600
29	5.279	30	5.431	31	5.484	32	5.372
33	5.283	34	5.378	35	5.401	36	5.505
37	5.471	38	5.295	39	5.470	40	5.341
41	5.669	42	5.366	43	5.290	44	5.475
45	5.549	46	5.633	47	5.430	48	5.539
49	5.425	50	5.387	51	5.511	52	5.373
53	5.514	54	5.634	55	5.297	56	5.461
57	5.392	58	5.516	59	5.270	60	5.280
61	5.427	62	5.570	63	5.289	64	5.310
65	5.411	66	5.412	67	5.711	68	5.568
69	5.386	70	5.655	71	5.409	72	5.374
73	5.437	74	5.302	75	5.617	76	5.572
77	5.370	78	5.667	79	5.601	80	5.447
81	5.551	82	5.525	83	5.292	84	5.481
85	5.571	86	5.605	87	5.395	88	5.496
89	5.402	90	5.644	91	5.631	92	5.432
93	5.694	94	5.662	95	5.540	96	5.489
97	5.463	98	5.521	99	5.486	100	5.616

Hopping Frequency Sequence Name: HOP_FREQ_SEQ_12

SEQ#	Frequency (GHz)	SEQ#	Frequency (GHz)	SEQ#	Frequency (GHz)	SEQ#	Frequency (GHz)
1	5.544	2	5.339	3	5.529	4	5.472
5	5.508	6	5.431	7	5.596	8	5.270
9	5.327	10	5.379	11	5.662	12	5.462
13	5.273	14	5.617	15	5.651	16	5.377
17	5.686	18	5.415	19	5.488	20	5.380
21	5.351	22	5.688	23	5.260	24	5.530
25	5.589	26	5.703	27	5.632	28	5.609
29	5.333	30	5.286	31	5.507	32	5.693
33	5.664	34	5.582	35	5.461	36	5.358
37	5.667	38	5.555	39	5.367	40	5.570
41	5.711	42	5.372	43	5.537	44	5.267
45	5.301	46	5.585	47	5.288	48	5.583
49	5.398	50	5.421	51	5.291	52	5.445
53	5.541	54	5.504	55	5.384	56	5.299
57	5.543	58	5.556	59	5.496	60	5.477
61	5.423	62	5.678	63	5.624	64	5.353
65	5.413	66	5.296	67	5.706	68	5.685
69	5.473	70	5.722	71	5.424	72	5.525
73	5.674	74	5.359	75	5.325	76	5.489
77	5.614	78	5.622	79	5.294	80	5.573
81	5.494	82	5.326	83	5.394	84	5.482
85	5.650	86	5.435	87	5.659	88	5.400
89	5.637	90	5.355	91	5.258	92	5.449
93	5.718	94	5.676	95	5.447	96	5.549
97	5.640	98	5.645	99	5.276	100	5.533

Hopping Frequency Sequence Name: HOP_FREQ_SEQ_13

SEQ#	Frequency (GHz)	SEQ#	Frequency (GHz)	SEQ#	Frequency (GHz)	SEQ#	Frequency (GHz)
1	5.358	2	5.430	3	5.615	4	5.653
5	5.439	6	5.310	7	5.399	8	5.722
9	5.721	10	5.494	11	5.352	12	5.449
13	5.538	14	5.337	15	5.438	16	5.262
17	5.307	18	5.409	19	5.503	20	5.419
21	5.487	22	5.282	23	5.417	24	5.295
25	5.644	26	5.622	27	5.383	28	5.334
29	5.692	30	5.658	31	5.598	32	5.372
33	5.573	34	5.576	35	5.491	36	5.621
37	5.380	38	5.586	39	5.527	40	5.698
41	5.342	42	5.275	43	5.492	44	5.630
45	5.529	46	5.724	47	5.269	48	5.411
49	5.474	50	5.608	51	5.553	52	5.602
53	5.429	54	5.478	55	5.312	56	5.318
57	5.673	58	5.297	59	5.369	60	5.377
61	5.375	62	5.285	63	5.558	64	5.260
65	5.390	66	5.268	67	5.656	68	5.370
69	5.596	70	5.605	71	5.591	72	5.629
73	5.506	74	5.351	75	5.281	76	5.336
77	5.524	78	5.521	79	5.461	80	5.367
81	5.296	82	5.347	83	5.435	84	5.329
85	5.340	86	5.299	87	5.680	88	5.448
89	5.261	90	5.510	91	5.265	92	5.555
93	5.595	94	5.457	95	5.280	96	5.359
97	5.410	98	5.509	99	5.379	100	5.447

Hopping Frequency Sequence Name: HOP_FREQ_SEQ_14

SEQ#	Frequency (GHz)	SEQ#	Frequency (GHz)	SEQ#	Frequency (GHz)	SEQ#	Frequency (GHz)
1	5.393	2	5.673	3	5.362	4	5.390
5	5.528	6	5.625	7	5.315	8	5.383
9	5.653	10	5.342	11	5.572	12	5.613
13	5.252	14	5.520	15	5.685	16	5.292
17	5.268	18	5.450	19	5.259	20	5.674
21	5.321	22	5.371	23	5.531	24	5.381
25	5.284	26	5.403	27	5.599	28	5.549
29	5.400	30	5.482	31	5.281	32	5.454
33	5.689	34	5.290	35	5.481	36	5.540
37	5.571	38	5.368	39	5.440	40	5.555
41	5.607	42	5.399	43	5.713	44	5.301
45	5.423	46	5.369	47	5.445	48	5.566
49	5.574	50	5.724	51	5.639	52	5.406
53	5.407	54	5.543	55	5.476	56	5.660
57	5.633	58	5.700	59	5.417	60	5.439
61	5.589	62	5.585	63	5.435	64	5.500
65	5.715	66	5.280	67	5.697	68	5.366
69	5.442	70	5.558	71	5.286	72	5.448
73	5.716	74	5.508	75	5.634	76	5.488
77	5.657	78	5.554	79	5.461	80	5.721
81	5.517	82	5.269	83	5.584	84	5.693
85	5.587	86	5.502	87	5.431	88	5.405
89	5.272	90	5.707	91	5.667	92	5.418
93	5.662	94	5.387	95	5.610	96	5.536
97	5.485	98	5.605	99	5.526	100	5.279

Hopping Frequency Sequence Name: HOP_FREQ_SEQ_15

SEQ#	Frequency (GHz)	SEQ#	Frequency (GHz)	SEQ#	Frequency (GHz)	SEQ#	Frequency (GHz)
1	5.293	2	5.401	3	5.260	4	5.640
5	5.308	6	5.684	7	5.527	8	5.417
9	5.419	10	5.660	11	5.495	12	5.628
13	5.363	14	5.470	15	5.517	16	5.412
17	5.446	18	5.302	19	5.567	20	5.712
21	5.272	22	5.335	23	5.582	24	5.500
25	5.311	26	5.550	27	5.378	28	5.601
29	5.671	30	5.667	31	5.452	32	5.271
33	5.283	34	5.719	35	5.536	36	5.652
37	5.526	38	5.481	39	5.657	40	5.254
41	5.343	42	5.505	43	5.542	44	5.483
45	5.342	46	5.259	47	5.710	48	5.545
49	5.410	50	5.516	51	5.489	52	5.696
53	5.512	54	5.554	55	5.571	56	5.433
57	5.445	58	5.634	59	5.345	60	5.434
61	5.716	62	5.613	63	5.541	64	5.268
65	5.282	66	5.252	67	5.442	68	5.488
69	5.703	70	5.586	71	5.349	72	5.544
73	5.325	74	5.514	75	5.456	76	5.508
77	5.403	78	5.387	79	5.406	80	5.653
81	5.497	82	5.454	83	5.307	84	5.430
85	5.377	86	5.431	87	5.382	88	5.539
89	5.251	90	5.420	91	5.638	92	5.676
93	5.592	94	5.579	95	5.463	96	5.678
97	5.262	98	5.364	99	5.388	100	5.261

Hopping Frequency Sequence Name: HOP_FREQ_SEQ_16

SEQ#	Frequency (GHz)	SEQ#	Frequency (GHz)	SEQ#	Frequency (GHz)	SEQ#	Frequency (GHz)
1	5.700	2	5.350	3	5.410	4	5.401
5	5.669	6	5.409	7	5.462	8	5.338
9	5.266	10	5.526	11	5.681	12	5.337
13	5.420	14	5.267	15	5.516	16	5.629
17	5.389	18	5.299	19	5.490	20	5.398
21	5.380	22	5.418	23	5.523	24	5.655
25	5.360	26	5.328	27	5.397	28	5.639
29	5.417	30	5.423	31	5.540	32	5.342
33	5.656	34	5.296	35	5.491	36	5.635
37	5.395	38	5.255	39	5.556	40	5.254
41	5.278	42	5.648	43	5.295	44	5.576
45	5.686	46	5.569	47	5.439	48	5.476
49	5.614	50	5.422	51	5.336	52	5.367
53	5.259	54	5.461	55	5.566	56	5.702
57	5.345	58	5.307	59	5.319	60	5.289
61	5.517	62	5.281	63	5.581	64	5.673
65	5.489	66	5.339	67	5.436	68	5.352
69	5.440	70	5.634	71	5.504	72	5.411
73	5.407	74	5.625	75	5.601	76	5.678
77	5.671	78	5.282	79	5.710	80	5.324
81	5.264	82	5.536	83	5.633	84	5.499
85	5.271	86	5.568	87	5.559	88	5.644
89	5.514	90	5.664	91	5.326	92	5.294
93	5.646	94	5.315	95	5.340	96	5.408
97	5.638	98	5.599	99	5.670	100	5.561

Hopping Frequency Sequence Name: HOP_FREQ_SEQ_17

SEQ#	Frequency (GHz)	SEQ#	Frequency (GHz)	SEQ#	Frequency (GHz)	SEQ#	Frequency (GHz)
1	5.563	2	5.478	3	5.723	4	5.319
5	5.374	6	5.492	7	5.469	8	5.292
9	5.525	10	5.252	11	5.350	12	5.608
13	5.323	14	5.681	15	5.388	16	5.545
17	5.291	18	5.517	19	5.253	20	5.383
21	5.489	22	5.654	23	5.704	24	5.616
25	5.621	26	5.593	27	5.435	28	5.332
29	5.420	30	5.375	31	5.587	32	5.610
33	5.498	34	5.376	35	5.661	36	5.596
37	5.413	38	5.269	39	5.701	40	5.510
41	5.266	42	5.626	43	5.516	44	5.483
45	5.467	46	5.518	47	5.586	48	5.255
49	5.512	50	5.315	51	5.639	52	5.316
53	5.667	54	5.625	55	5.495	56	5.560
57	5.455	58	5.286	59	5.324	60	5.678
61	5.555	62	5.594	63	5.662	64	5.505
65	5.320	66	5.685	67	5.282	68	5.335
69	5.677	70	5.585	71	5.526	72	5.670
73	5.400	74	5.541	75	5.488	76	5.477
77	5.480	78	5.507	79	5.449	80	5.385
81	5.473	82	5.412	83	5.714	84	5.549
85	5.690	86	5.295	87	5.619	88	5.683
89	5.411	90	5.343	91	5.664	92	5.637
93	5.351	94	5.285	95	5.691	96	5.554
97	5.415	98	5.530	99	5.692	100	5.452

Hopping Frequency Sequence Name: HOP_FREQ_SEQ_18

SEQ#	Frequency (GHz)	SEQ#	Frequency (GHz)	SEQ#	Frequency (GHz)	SEQ#	Frequency (GHz)
1	5.497	2	5.599	3	5.670	4	5.665
5	5.351	6	5.278	7	5.388	8	5.600
9	5.263	10	5.572	11	5.364	12	5.532
13	5.643	14	5.487	15	5.486	16	5.631
17	5.515	18	5.492	19	5.373	20	5.442
21	5.358	22	5.293	23	5.562	24	5.355
25	5.496	26	5.467	27	5.679	28	5.707
29	5.607	30	5.513	31	5.489	32	5.485
33	5.320	34	5.418	35	5.621	36	5.416
37	5.522	38	5.407	39	5.303	40	5.357
41	5.378	42	5.542	43	5.678	44	5.452
45	5.574	46	5.449	47	5.546	48	5.610
49	5.434	50	5.613	51	5.650	52	5.469
53	5.281	54	5.608	55	5.524	56	5.529
57	5.428	58	5.661	59	5.544	60	5.512
61	5.393	62	5.411	63	5.471	64	5.462
65	5.504	66	5.399	67	5.638	68	5.298
69	5.395	70	5.553	71	5.273	72	5.578
73	5.463	74	5.423	75	5.307	76	5.516
77	5.507	78	5.480	79	5.360	80	5.721
81	5.598	82	5.376	83	5.494	84	5.398
85	5.595	86	5.521	87	5.305	88	5.446
89	5.275	90	5.443	91	5.316	92	5.437
93	5.549	94	5.693	95	5.269	96	5.295
97	5.668	98	5.586	99	5.719	100	5.615

Hopping Frequency Sequence Name: HOP_FREQ_SEQ_19

SEQ#	Frequency (GHz)	SEQ#	Frequency (GHz)	SEQ#	Frequency (GHz)	SEQ#	Frequency (GHz)
1	5.691	2	5.551	3	5.579	4	5.350
5	5.688	6	5.622	7	5.294	8	5.547
9	5.460	10	5.446	11	5.270	12	5.541
13	5.620	14	5.571	15	5.384	16	5.633
17	5.477	18	5.503	19	5.553	20	5.629
21	5.472	22	5.542	23	5.528	24	5.544
25	5.613	26	5.700	27	5.434	28	5.358
29	5.525	30	5.305	31	5.644	32	5.516
33	5.648	34	5.684	35	5.488	36	5.478
37	5.498	38	5.335	39	5.441	40	5.361
41	5.411	42	5.420	43	5.396	44	5.515
45	5.353	46	5.266	47	5.451	48	5.386
49	5.617	50	5.588	51	5.374	52	5.532
53	5.666	54	5.669	55	5.314	56	5.431
57	5.520	58	5.306	59	5.272	60	5.279
61	5.634	62	5.654	63	5.619	64	5.504
65	5.334	66	5.685	67	5.690	68	5.646
69	5.575	70	5.641	71	5.297	72	5.282
73	5.713	74	5.479	75	5.663	76	5.695
77	5.492	78	5.493	79	5.668	80	5.327
81	5.288	82	5.296	83	5.413	84	5.511
85	5.486	86	5.597	87	5.286	88	5.661
89	5.421	90	5.405	91	5.536	92	5.719
93	5.518	94	5.590	95	5.608	96	5.408
97	5.582	98	5.303	99	5.449	100	5.414

Hopping Frequency Sequence Name: HOP_FREQ_SEQ_20

SEQ#	Frequency (GHz)	SEQ#	Frequency (GHz)	SEQ#	Frequency (GHz)	SEQ#	Frequency (GHz)
1	5.680	2	5.483	3	5.416	4	5.549
5	5.475	6	5.321	7	5.633	8	5.278
9	5.311	10	5.524	11	5.678	12	5.521
13	5.605	14	5.367	15	5.691	16	5.672
17	5.370	18	5.504	19	5.488	20	5.433
21	5.465	22	5.282	23	5.266	24	5.701
25	5.709	26	5.267	27	5.445	28	5.385
29	5.623	30	5.299	31	5.419	32	5.707
33	5.617	34	5.322	35	5.498	36	5.632
37	5.649	38	5.546	39	5.446	40	5.541
41	5.599	42	5.630	43	5.256	44	5.568
45	5.566	46	5.537	47	5.534	48	5.277
49	5.618	50	5.374	51	5.455	52	5.283
53	5.564	54	5.312	55	5.693	56	5.436
57	5.338	58	5.372	59	5.272	60	5.369
61	5.696	62	5.507	63	5.695	64	5.529
65	5.317	66	5.384	67	5.297	68	5.494
69	5.366	70	5.705	71	5.300	72	5.715
73	5.481	74	5.287	75	5.698	76	5.301
77	5.655	78	5.670	79	5.264	80	5.420
81	5.262	82	5.676	83	5.683	84	5.394
85	5.540	86	5.337	87	5.326	88	5.431
89	5.381	90	5.505	91	5.515	92	5.275
93	5.408	94	5.690	95	5.306	96	5.359
97	5.427	98	5.342	99	5.356	100	5.462

Hopping Frequency Sequence Name: HOP_FREQ_SEQ_21

SEQ#	Frequency (GHz)	SEQ#	Frequency (GHz)	SEQ#	Frequency (GHz)	SEQ#	Frequency (GHz)
1	5.600	2	5.680	3	5.444	4	5.459
5	5.718	6	5.298	7	5.441	8	5.605
9	5.622	10	5.505	11	5.286	12	5.634
13	5.683	14	5.583	15	5.428	16	5.667
17	5.570	18	5.549	19	5.553	20	5.353
21	5.602	22	5.544	23	5.377	24	5.341
25	5.677	26	5.713	27	5.629	28	5.321
29	5.483	30	5.363	31	5.636	32	5.504
33	5.595	34	5.384	35	5.474	36	5.625
37	5.269	38	5.624	39	5.665	40	5.375
41	5.712	42	5.345	43	5.418	44	5.457
45	5.311	46	5.656	47	5.507	48	5.429
49	5.440	50	5.320	51	5.540	52	5.477
53	5.411	54	5.561	55	5.352	56	5.317
57	5.497	58	5.423	59	5.576	60	5.367
61	5.509	62	5.472	63	5.641	64	5.597
65	5.559	66	5.585	67	5.626	68	5.336
69	5.271	70	5.313	71	5.420	72	5.448
73	5.443	74	5.381	75	5.647	76	5.431
77	5.370	78	5.580	79	5.323	80	5.548
81	5.430	82	5.596	83	5.523	84	5.530
85	5.560	86	5.592	87	5.314	88	5.422
89	5.607	90	5.385	91	5.628	92	5.421
93	5.463	94	5.437	95	5.646	96	5.648
97	5.536	98	5.296	99	5.312	100	5.409

Hopping Frequency Sequence Name: HOP_FREQ_SEQ_22

SEQ#	Frequency (GHz)	SEQ#	Frequency (GHz)	SEQ#	Frequency (GHz)	SEQ#	Frequency (GHz)
1	5.290	2	5.317	3	5.630	4	5.724
5	5.411	6	5.700	7	5.507	8	5.263
9	5.308	10	5.568	11	5.400	12	5.252
13	5.499	14	5.570	15	5.528	16	5.461
17	5.638	18	5.399	19	5.398	20	5.254
21	5.684	22	5.616	23	5.659	24	5.285
25	5.640	26	5.647	27	5.357	28	5.279
29	5.324	30	5.323	31	5.327	32	5.626
33	5.722	34	5.345	35	5.302	36	5.483
37	5.702	38	5.384	39	5.305	40	5.651
41	5.498	42	5.693	43	5.255	44	5.564
45	5.299	46	5.482	47	5.446	48	5.704
49	5.459	50	5.582	51	5.288	52	5.720
53	5.335	54	5.286	55	5.541	56	5.457
57	5.272	58	5.365	59	5.529	60	5.618
61	5.441	62	5.581	63	5.386	64	5.650
65	5.580	66	5.612	67	5.601	68	5.557
69	5.486	70	5.608	71	5.511	72	5.664
73	5.675	74	5.525	75	5.567	76	5.678
77	5.586	78	5.336	79	5.291	80	5.387
81	5.625	82	5.356	83	5.412	84	5.706
85	5.591	86	5.688	87	5.374	88	5.401
89	5.510	90	5.624	91	5.321	92	5.339
93	5.466	94	5.475	95	5.655	96	5.328
97	5.513	98	5.686	99	5.352	100	5.261

Hopping Frequency Sequence Name: HOP_FREQ_SEQ_23

SEQ#	Frequency (GHz)	SEQ#	Frequency (GHz)	SEQ#	Frequency (GHz)	SEQ#	Frequency (GHz)
1	5.367	2	5.276	3	5.659	4	5.686
5	5.388	6	5.552	7	5.452	8	5.285
9	5.475	10	5.441	11	5.514	12	5.266
13	5.432	14	5.462	15	5.545	16	5.348
17	5.442	18	5.489	19	5.271	20	5.277
21	5.542	22	5.594	23	5.411	24	5.517
25	5.613	26	5.275	27	5.426	28	5.661
29	5.286	30	5.595	31	5.645	32	5.688
33	5.357	34	5.690	35	5.543	36	5.364
37	5.497	38	5.393	39	5.435	40	5.345
41	5.482	42	5.344	43	5.570	44	5.593
45	5.715	46	5.602	47	5.548	48	5.451
49	5.633	50	5.471	51	5.605	52	5.324
53	5.550	54	5.526	55	5.445	56	5.651
57	5.289	58	5.582	59	5.535	60	5.251
61	5.549	62	5.362	63	5.527	64	5.294
65	5.539	66	5.423	67	5.268	68	5.400
69	5.368	70	5.684	71	5.553	72	5.703
73	5.460	74	5.436	75	5.448	76	5.309
77	5.290	78	5.260	79	5.444	80	5.588
81	5.530	82	5.682	83	5.418	84	5.560
85	5.320	86	5.486	87	5.404	88	5.428
89	5.663	90	5.401	91	5.580	92	5.484
93	5.495	94	5.319	95	5.267	96	5.618
97	5.431	98	5.327	99	5.252	100	5.547

Hopping Frequency Sequence Name: HOP_FREQ_SEQ_24

SEQ#	Frequency (GHz)	SEQ#	Frequency (GHz)	SEQ#	Frequency (GHz)	SEQ#	Frequency (GHz)
1	5.280	2	5.283	3	5.409	4	5.651
5	5.340	6	5.620	7	5.366	8	5.353
9	5.501	10	5.456	11	5.573	12	5.583
13	5.375	14	5.630	15	5.291	16	5.333
17	5.477	18	5.453	19	5.513	20	5.510
21	5.445	22	5.407	23	5.401	24	5.671
25	5.523	26	5.428	27	5.655	28	5.603
29	5.650	30	5.270	31	5.348	32	5.367
33	5.564	34	5.673	35	5.362	36	5.378
37	5.528	38	5.334	39	5.365	40	5.568
41	5.341	42	5.636	43	5.411	44	5.549
45	5.394	46	5.271	47	5.420	48	5.724
49	5.467	50	5.423	51	5.427	52	5.580
53	5.611	54	5.313	55	5.584	56	5.553
57	5.396	58	5.688	59	5.516	60	5.433
61	5.487	62	5.308	63	5.296	64	5.338
65	5.666	66	5.464	67	5.389	68	5.421
69	5.721	70	5.605	71	5.555	72	5.447
73	5.455	74	5.567	75	5.585	76	5.656
77	5.469	78	5.640	79	5.629	80	5.424
81	5.481	82	5.329	83	5.342	84	5.610
85	5.710	86	5.489	87	5.343	88	5.442
89	5.692	90	5.292	91	5.702	92	5.601
93	5.491	94	5.626	95	5.644	96	5.641
97	5.406	98	5.450	99	5.569	100	5.690

Hopping Frequency Sequence Name: HOP_FREQ_SEQ_25

SEQ#	Frequency (GHz)	SEQ#	Frequency (GHz)	SEQ#	Frequency (GHz)	SEQ#	Frequency (GHz)
1	5.615	2	5.657	3	5.676	4	5.592
5	5.327	6	5.300	7	5.337	8	5.680
9	5.448	10	5.690	11	5.417	12	5.567
13	5.604	14	5.694	15	5.516	16	5.503
17	5.312	18	5.598	19	5.696	20	5.383
21	5.718	22	5.475	23	5.603	24	5.464
25	5.425	26	5.677	27	5.320	28	5.367
29	5.313	30	5.436	31	5.463	32	5.699
33	5.565	34	5.371	35	5.411	36	5.659
37	5.661	38	5.649	39	5.391	40	5.589
41	5.452	42	5.410	43	5.484	44	5.302
45	5.692	46	5.270	47	5.386	48	5.279
49	5.601	50	5.513	51	5.602	52	5.673
53	5.501	54	5.557	55	5.494	56	5.254
57	5.571	58	5.264	59	5.573	60	5.440
61	5.281	62	5.423	63	5.358	64	5.500
65	5.701	66	5.525	67	5.446	68	5.369
69	5.499	70	5.582	71	5.717	72	5.664
73	5.515	74	5.514	75	5.461	76	5.631
77	5.719	78	5.606	79	5.483	80	5.449
81	5.458	82	5.447	83	5.616	84	5.482
85	5.453	86	5.263	87	5.542	88	5.399
89	5.469	90	5.275	91	5.295	92	5.291
93	5.416	94	5.444	95	5.599	96	5.522
97	5.640	98	5.632	99	5.472	100	5.583

Hopping Frequency Sequence Name: HOP_FREQ_SEQ_26

SEQ#	Frequency (GHz)	SEQ#	Frequency (GHz)	SEQ#	Frequency (GHz)	SEQ#	Frequency (GHz)
1	5.339	2	5.672	3	5.594	4	5.694
5	5.660	6	5.647	7	5.656	8	5.705
9	5.551	10	5.542	11	5.295	12	5.316
13	5.454	14	5.592	15	5.582	16	5.303
17	5.465	18	5.417	19	5.512	20	5.710
21	5.289	22	5.286	23	5.277	24	5.440
25	5.584	26	5.518	27	5.505	28	5.597
29	5.326	30	5.371	31	5.374	32	5.639
33	5.355	34	5.609	35	5.618	36	5.463
37	5.425	38	5.404	39	5.711	40	5.506
41	5.394	42	5.431	43	5.703	44	5.489
45	5.596	46	5.575	47	5.515	48	5.655
49	5.652	50	5.494	51	5.358	52	5.648
53	5.376	54	5.457	55	5.279	56	5.707
57	5.412	58	5.396	59	5.319	60	5.430
61	5.363	62	5.379	63	5.544	64	5.364
65	5.499	66	5.622	67	5.476	68	5.536
69	5.487	70	5.587	71	5.452	72	5.418
73	5.333	74	5.321	75	5.528	76	5.574
77	5.619	78	5.386	79	5.633	80	5.467
81	5.600	82	5.500	83	5.504	84	5.265
85	5.625	86	5.359	87	5.485	88	5.372
89	5.569	90	5.456	91	5.573	92	5.581
93	5.281	94	5.314	95	5.721	96	5.650
97	5.713	98	5.275	99	5.686	100	5.708

Hopping Frequency Sequence Name: HOP_FREQ_SEQ_27

SEQ#	Frequency (GHz)	SEQ#	Frequency (GHz)	SEQ#	Frequency (GHz)	SEQ#	Frequency (GHz)
1	5.452	2	5.650	3	5.373	4	5.568
5	5.602	6	5.448	7	5.593	8	5.367
9	5.529	10	5.515	11	5.598	12	5.338
13	5.380	14	5.524	15	5.371	16	5.401
17	5.522	18	5.411	19	5.715	20	5.590
21	5.300	22	5.691	23	5.433	24	5.430
25	5.670	26	5.318	27	5.319	28	5.333
29	5.260	30	5.425	31	5.530	32	5.708
33	5.722	34	5.712	35	5.501	36	5.654
37	5.485	38	5.424	39	5.638	40	5.445
41	5.564	42	5.439	43	5.376	44	5.442
45	5.619	46	5.552	47	5.347	48	5.408
49	5.316	50	5.643	51	5.269	52	5.484
53	5.687	54	5.419	55	5.573	56	5.473
57	5.327	58	5.293	59	5.611	60	5.475
61	5.537	62	5.583	63	5.444	64	5.661
65	5.551	66	5.255	67	5.364	68	5.349
69	5.574	70	5.588	71	5.680	72	5.497
73	5.585	74	5.534	75	5.365	76	5.721
77	5.469	78	5.488	79	5.406	80	5.348
81	5.504	82	5.671	83	5.651	84	5.375
85	5.286	86	5.507	87	5.414	88	5.519
89	5.684	90	5.438	91	5.520	92	5.265
93	5.404	94	5.711	95	5.586	96	5.657
97	5.302	98	5.575	99	5.490	100	5.464

Hopping Frequency Sequence Name: HOP_FREQ_SEQ_28

SEQ#	Frequency (GHz)	SEQ#	Frequency (GHz)	SEQ#	Frequency (GHz)	SEQ#	Frequency (GHz)
1	5.434	2	5.680	3	5.335	4	5.560
5	5.369	6	5.305	7	5.710	8	5.275
9	5.315	10	5.475	11	5.269	12	5.460
13	5.533	14	5.627	15	5.702	16	5.661
17	5.707	18	5.356	19	5.687	20	5.328
21	5.656	22	5.563	23	5.581	24	5.361
25	5.694	26	5.468	27	5.456	28	5.304
29	5.499	30	5.255	31	5.391	32	5.647
33	5.320	34	5.653	35	5.298	36	5.536
37	5.665	38	5.268	39	5.623	40	5.721
41	5.620	42	5.611	43	5.313	44	5.570
45	5.545	46	5.716	47	5.524	48	5.628
49	5.698	50	5.558	51	5.278	52	5.723
53	5.420	54	5.359	55	5.722	56	5.492
57	5.446	58	5.354	59	5.474	60	5.638
61	5.720	62	5.618	63	5.582	64	5.326
65	5.398	66	5.410	67	5.634	68	5.344
69	5.697	70	5.253	71	5.519	72	5.424
73	5.594	74	5.286	75	5.599	76	5.264
77	5.718	78	5.576	79	5.682	80	5.432
81	5.584	82	5.462	83	5.525	84	5.336
85	5.577	86	5.459	87	5.714	88	5.449
89	5.483	90	5.490	91	5.347	92	5.277
93	5.478	94	5.292	95	5.274	96	5.377
97	5.617	98	5.367	99	5.472	100	5.337

Hopping Frequency Sequence Name: HOP_FREQ_SEQ_29

SEQ#	Frequency (GHz)	SEQ#	Frequency (GHz)	SEQ#	Frequency (GHz)	SEQ#	Frequency (GHz)
1	5.410	2	5.585	3	5.609	4	5.523
5	5.304	6	5.466	7	5.262	8	5.617
9	5.311	10	5.677	11	5.590	12	5.283
13	5.305	14	5.601	15	5.404	16	5.690
17	5.302	18	5.655	19	5.668	20	5.389
21	5.412	22	5.709	23	5.286	24	5.631
25	5.626	26	5.487	27	5.257	28	5.491
29	5.328	30	5.345	31	5.651	32	5.275
33	5.605	34	5.430	35	5.588	36	5.705
37	5.289	38	5.694	39	5.365	40	5.307
41	5.673	42	5.288	43	5.458	44	5.363
45	5.573	46	5.424	47	5.654	48	5.354
49	5.548	50	5.696	51	5.440	52	5.701
53	5.629	54	5.390	55	5.334	56	5.507
57	5.434	58	5.724	59	5.485	60	5.444
61	5.527	62	5.428	63	5.360	64	5.377
65	5.542	66	5.641	67	5.423	68	5.446
69	5.483	70	5.478	71	5.537	72	5.293
73	5.612	74	5.476	75	5.445	76	5.702
77	5.596	78	5.388	79	5.544	80	5.499
81	5.621	82	5.353	83	5.402	84	5.603
85	5.650	86	5.469	87	5.327	88	5.313
89	5.721	90	5.432	91	5.646	92	5.680
93	5.640	94	5.295	95	5.606	96	5.604
97	5.539	98	5.325	99	5.468	100	5.484

Hopping Frequency Sequence Name: HOP_FREQ_SEQ_30

SEQ#	Frequency (GHz)	SEQ#	Frequency (GHz)	SEQ#	Frequency (GHz)	SEQ#	Frequency (GHz)
1	5.631	2	5.628	3	5.645	4	5.347
5	5.591	6	5.427	7	5.333	8	5.692
9	5.441	10	5.504	11	5.600	12	5.551
13	5.271	14	5.647	15	5.646	16	5.406
17	5.613	18	5.291	19	5.362	20	5.394
21	5.470	22	5.458	23	5.546	24	5.563
25	5.318	26	5.397	27	5.260	28	5.636
29	5.576	30	5.430	31	5.391	32	5.460
33	5.361	34	5.708	35	5.698	36	5.544
37	5.258	38	5.474	39	5.703	40	5.416
41	5.657	42	5.328	43	5.277	44	5.617
45	5.449	46	5.489	47	5.575	48	5.268
49	5.294	50	5.723	51	5.644	52	5.590
53	5.256	54	5.721	55	5.261	56	5.259
57	5.514	58	5.476	59	5.345	60	5.459
61	5.462	62	5.266	63	5.407	64	5.488
65	5.286	66	5.371	67	5.571	68	5.556
69	5.588	70	5.654	71	5.678	72	5.354
73	5.472	74	5.526	75	5.487	76	5.468
77	5.508	78	5.388	79	5.446	80	5.520
81	5.418	82	5.390	83	5.550	84	5.482
85	5.337	86	5.404	87	5.664	88	5.465
89	5.598	90	5.257	91	5.392	92	5.516
93	5.448	94	5.327	95	5.614	96	5.594
97	5.633	98	5.637	99	5.715	100	5.329

802.11be (EHT160)_Ch114

Hopping Frequency Sequence Name: HOP_FREQ_SEQ_01

SEQ#	Frequency (GHz)	SEQ#	Frequency (GHz)	SEQ#	Frequency (GHz)	SEQ#	Frequency (GHz)
1	5.540	2	5.513	3	5.526	4	5.574
5	5.501	6	5.717	7	5.590	8	5.373
9	5.338	10	5.534	11	5.388	12	5.493
13	5.447	14	5.554	15	5.593	16	5.566
17	5.688	18	5.715	19	5.350	20	5.713
21	5.404	22	5.374	23	5.571	24	5.420
25	5.588	26	5.277	27	5.407	28	5.610
29	5.278	30	5.710	31	5.366	32	5.301
33	5.666	34	5.551	35	5.531	36	5.339
37	5.410	38	5.303	39	5.267	40	5.538
41	5.327	42	5.701	43	5.358	44	5.581
45	5.408	46	5.584	47	5.477	48	5.357
49	5.703	50	5.376	51	5.683	52	5.413
53	5.662	54	5.423	55	5.632	56	5.668
57	5.619	58	5.281	59	5.429	60	5.289
61	5.306	62	5.337	63	5.596	64	5.286
65	5.592	66	5.379	67	5.362	68	5.351
69	5.433	70	5.271	71	5.384	72	5.614
73	5.504	74	5.296	75	5.712	76	5.452
77	5.687	78	5.533	79	5.599	80	5.561
81	5.293	82	5.300	83	5.302	84	5.718
85	5.291	86	5.456	87	5.505	88	5.636
89	5.367	90	5.348	91	5.527	92	5.558
93	5.640	94	5.559	95	5.436	96	5.613
97	5.472	98	5.707	99	5.607	100	5.680

Hopping Frequency Sequence Name: HOP_FREQ_SEQ_02

SEQ#	Frequency (GHz)	SEQ#	Frequency (GHz)	SEQ#	Frequency (GHz)	SEQ#	Frequency (GHz)
1	5.641	2	5.581	3	5.679	4	5.580
5	5.429	6	5.315	7	5.582	8	5.604
9	5.353	10	5.255	11	5.260	12	5.425
13	5.366	14	5.343	15	5.478	16	5.310
17	5.367	18	5.288	19	5.595	20	5.719
21	5.514	22	5.630	23	5.327	24	5.606
25	5.424	26	5.662	27	5.482	28	5.683
29	5.528	30	5.289	31	5.700	32	5.541
33	5.356	34	5.585	35	5.506	36	5.297
37	5.391	38	5.505	39	5.511	40	5.333
41	5.292	42	5.572	43	5.329	44	5.553
45	5.408	46	5.612	47	5.532	48	5.423
49	5.594	50	5.495	51	5.499	52	5.607
53	5.706	54	5.525	55	5.692	56	5.390
57	5.576	58	5.270	59	5.549	60	5.468
61	5.407	62	5.455	63	5.448	64	5.565
65	5.687	66	5.656	67	5.335	68	5.649
69	5.360	70	5.349	71	5.504	72	5.661
73	5.422	74	5.328	75	5.311	76	5.307
77	5.669	78	5.561	79	5.521	80	5.342
81	5.337	82	5.518	83	5.441	84	5.436
85	5.682	86	5.562	87	5.466	88	5.539
89	5.372	90	5.534	91	5.284	92	5.537
93	5.701	94	5.384	95	5.251	96	5.445
97	5.473	98	5.388	99	5.280	100	5.285

Hopping Frequency Sequence Name: HOP_FREQ_SEQ_03

SEQ#	Frequency (GHz)	SEQ#	Frequency (GHz)	SEQ#	Frequency (GHz)	SEQ#	Frequency (GHz)
1	5.284	2	5.304	3	5.456	4	5.489
5	5.670	6	5.409	7	5.574	8	5.448
9	5.581	10	5.467	11	5.637	12	5.651
13	5.641	14	5.407	15	5.281	16	5.321
17	5.428	18	5.355	19	5.260	20	5.276
21	5.435	22	5.640	23	5.683	24	5.333
25	5.382	26	5.712	27	5.391	28	5.401
29	5.554	30	5.383	31	5.261	32	5.315
33	5.563	34	5.326	35	5.652	36	5.393
37	5.280	38	5.352	39	5.588	40	5.595
41	5.498	42	5.618	43	5.596	44	5.307
45	5.720	46	5.495	47	5.542	48	5.469
49	5.617	50	5.623	51	5.723	52	5.440
53	5.350	54	5.338	55	5.332	56	5.602
57	5.277	58	5.367	59	5.572	60	5.611
61	5.294	62	5.584	63	5.529	64	5.678
65	5.501	66	5.267	67	5.536	68	5.301
69	5.516	70	5.650	71	5.664	72	5.662
73	5.263	74	5.458	75	5.528	76	5.707
77	5.717	78	5.418	79	5.560	80	5.604
81	5.644	82	5.396	83	5.416	84	5.514
85	5.526	86	5.699	87	5.443	88	5.674
89	5.411	90	5.671	91	5.510	92	5.257
93	5.436	94	5.424	95	5.459	96	5.273
97	5.685	98	5.463	99	5.288	100	5.275

Hopping Frequency Sequence Name: HOP_FREQ_SEQ_04

SEQ#	Frequency (GHz)	SEQ#	Frequency (GHz)	SEQ#	Frequency (GHz)	SEQ#	Frequency (GHz)
1	5.278	2	5.505	3	5.563	4	5.422
5	5.685	6	5.270	7	5.545	8	5.321
9	5.641	10	5.680	11	5.568	12	5.284
13	5.675	14	5.542	15	5.406	16	5.426
17	5.346	18	5.327	19	5.558	20	5.423
21	5.285	22	5.434	23	5.720	24	5.538
25	5.357	26	5.286	27	5.362	28	5.522
29	5.520	30	5.438	31	5.418	32	5.448
33	5.605	34	5.451	35	5.516	36	5.319
37	5.694	38	5.671	39	5.518	40	5.553
41	5.252	42	5.395	43	5.482	44	5.419
45	5.397	46	5.716	47	5.349	48	5.661
49	5.296	50	5.693	51	5.414	52	5.670
53	5.356	54	5.527	55	5.704	56	5.566
57	5.429	58	5.592	59	5.353	60	5.361
61	5.475	62	5.636	63	5.508	64	5.718
65	5.484	66	5.405	67	5.348	68	5.650
69	5.412	70	5.607	71	5.294	72	5.721
73	5.565	74	5.379	75	5.279	76	5.433
77	5.578	78	5.610	79	5.477	80	5.571
81	5.276	82	5.495	83	5.308	84	5.698
85	5.572	86	5.398	87	5.387	88	5.597
89	5.688	90	5.590	91	5.485	92	5.497
93	5.253	94	5.617	95	5.632	96	5.363
97	5.628	98	5.376	99	5.282	100	5.490

Hopping Frequency Sequence Name: HOP_FREQ_SEQ_05

SEQ#	Frequency (GHz)	SEQ#	Frequency (GHz)	SEQ#	Frequency (GHz)	SEQ#	Frequency (GHz)
1	5.535	2	5.444	3	5.468	4	5.719
5	5.264	6	5.349	7	5.554	8	5.387
9	5.462	10	5.632	11	5.490	12	5.478
13	5.340	14	5.494	15	5.323	16	5.320
17	5.560	18	5.435	19	5.367	20	5.544
21	5.519	22	5.401	23	5.616	24	5.485
25	5.477	26	5.482	27	5.669	28	5.553
29	5.682	30	5.308	31	5.293	32	5.496
33	5.480	34	5.593	35	5.268	36	5.324
37	5.657	38	5.587	39	5.712	40	5.635
41	5.473	42	5.441	43	5.442	44	5.649
45	5.597	46	5.517	47	5.279	48	5.454
49	5.689	50	5.456	51	5.529	52	5.391
53	5.515	54	5.350	55	5.434	56	5.505
57	5.539	58	5.582	59	5.604	60	5.370
61	5.413	62	5.414	63	5.285	64	5.605
65	5.648	66	5.345	67	5.489	68	5.671
69	5.540	70	5.289	71	5.598	72	5.542
73	5.636	74	5.381	75	5.347	76	5.522
77	5.711	78	5.693	79	5.319	80	5.431
81	5.501	82	5.486	83	5.280	84	5.647
85	5.398	86	5.259	87	5.570	88	5.504
89	5.558	90	5.426	91	5.706	92	5.291
93	5.253	94	5.662	95	5.362	96	5.667
97	5.590	98	5.569	99	5.531	100	5.405

Hopping Frequency Sequence Name: HOP_FREQ_SEQ_06

SEQ#	Frequency (GHz)	SEQ#	Frequency (GHz)	SEQ#	Frequency (GHz)	SEQ#	Frequency (GHz)
1	5.642	2	5.685	3	5.613	4	5.701
5	5.526	6	5.604	7	5.329	8	5.551
9	5.624	10	5.389	11	5.696	12	5.599
13	5.323	14	5.274	15	5.293	16	5.416
17	5.720	18	5.453	19	5.655	20	5.608
21	5.344	22	5.349	23	5.399	24	5.605
25	5.326	26	5.693	27	5.674	28	5.255
29	5.370	30	5.285	31	5.666	32	5.578
33	5.260	34	5.275	35	5.409	36	5.715
37	5.660	38	5.460	39	5.324	40	5.509
41	5.712	42	5.312	43	5.480	44	5.375
45	5.681	46	5.631	47	5.714	48	5.512
49	5.445	50	5.514	51	5.354	52	5.483
53	5.490	54	5.654	55	5.386	56	5.291
57	5.476	58	5.716	59	5.362	60	5.265
61	5.680	62	5.439	63	5.541	64	5.573
65	5.682	66	5.644	67	5.414	68	5.422
69	5.668	70	5.677	71	5.609	72	5.705
73	5.473	74	5.517	75	5.482	76	5.549
77	5.360	78	5.485	79	5.684	80	5.317
81	5.264	82	5.711	83	5.355	84	5.596
85	5.300	86	5.592	87	5.303	88	5.594
89	5.579	90	5.649	91	5.340	92	5.667
93	5.643	94	5.575	95	5.396	96	5.436
97	5.437	98	5.408	99	5.561	100	5.421

Hopping Frequency Sequence Name: HOP_FREQ_SEQ_07

SEQ#	Frequency (GHz)	SEQ#	Frequency (GHz)	SEQ#	Frequency (GHz)	SEQ#	Frequency (GHz)
1	5.597	2	5.360	3	5.666	4	5.431
5	5.587	6	5.521	7	5.471	8	5.553
9	5.676	10	5.338	11	5.722	12	5.347
13	5.458	14	5.498	15	5.620	16	5.641
17	5.596	18	5.295	19	5.317	20	5.605
21	5.532	22	5.650	23	5.558	24	5.700
25	5.495	26	5.481	27	5.485	28	5.390
29	5.656	30	5.648	31	5.365	32	5.708
33	5.371	34	5.441	35	5.702	36	5.504
37	5.261	38	5.398	39	5.392	40	5.572
41	5.683	42	5.567	43	5.585	44	5.623
45	5.569	46	5.256	47	5.505	48	5.649
49	5.426	50	5.264	51	5.640	52	5.690
53	5.520	54	5.466	55	5.593	56	5.568
57	5.325	58	5.383	59	5.300	60	5.389
61	5.469	62	5.253	63	5.285	64	5.724
65	5.538	66	5.467	67	5.519	68	5.686
69	5.539	70	5.313	71	5.713	72	5.312
73	5.654	74	5.299	75	5.446	76	5.366
77	5.320	78	5.479	79	5.492	80	5.340
81	5.548	82	5.671	83	5.698	84	5.674
85	5.343	86	5.710	87	5.443	88	5.503
89	5.599	90	5.474	91	5.502	92	5.437
93	5.263	94	5.604	95	5.393	96	5.372
97	5.369	98	5.262	99	5.711	100	5.527

Hopping Frequency Sequence Name: HOP_FREQ_SEQ_08

SEQ#	Frequency (GHz)	SEQ#	Frequency (GHz)	SEQ#	Frequency (GHz)	SEQ#	Frequency (GHz)
1	5.667	2	5.626	3	5.314	4	5.440
5	5.527	6	5.365	7	5.653	8	5.652
9	5.469	10	5.694	11	5.496	12	5.634
13	5.517	14	5.354	15	5.481	16	5.505
17	5.292	18	5.254	19	5.569	20	5.649
21	5.433	22	5.604	23	5.404	24	5.349
25	5.416	26	5.551	27	5.603	28	5.561
29	5.386	30	5.648	31	5.369	32	5.252
33	5.635	34	5.605	35	5.399	36	5.485
37	5.391	38	5.641	39	5.518	40	5.607
41	5.529	42	5.590	43	5.520	44	5.514
45	5.409	46	5.336	47	5.567	48	5.679
49	5.698	50	5.594	51	5.564	52	5.419
53	5.657	54	5.668	55	5.689	56	5.306
57	5.385	58	5.278	59	5.688	60	5.423
61	5.674	62	5.536	63	5.544	64	5.435
65	5.251	66	5.601	67	5.438	68	5.280
69	5.260	70	5.288	71	5.711	72	5.389
73	5.640	74	5.556	75	5.664	76	5.718
77	5.677	78	5.651	79	5.277	80	5.420
81	5.300	82	5.683	83	5.573	84	5.702
85	5.256	86	5.684	87	5.533	88	5.362
89	5.443	90	5.712	91	5.612	92	5.606
93	5.491	94	5.364	95	5.338	96	5.417
97	5.428	98	5.553	99	5.595	100	5.583

Hopping Frequency Sequence Name: HOP_FREQ_SEQ_09

SEQ#	Frequency (GHz)	SEQ#	Frequency (GHz)	SEQ#	Frequency (GHz)	SEQ#	Frequency (GHz)
1	5.652	2	5.260	3	5.508	4	5.643
5	5.653	6	5.659	7	5.381	8	5.683
9	5.724	10	5.711	11	5.577	12	5.333
13	5.682	14	5.307	15	5.258	16	5.603
17	5.605	18	5.534	19	5.520	20	5.491
21	5.367	22	5.672	23	5.355	24	5.372
25	5.651	26	5.541	27	5.274	28	5.666
29	5.498	30	5.336	31	5.420	32	5.701
33	5.496	34	5.707	35	5.361	36	5.608
37	5.582	38	5.631	39	5.289	40	5.386
41	5.568	42	5.671	43	5.455	44	5.279
45	5.558	46	5.595	47	5.363	48	5.352
49	5.549	50	5.434	51	5.602	52	5.362
53	5.379	54	5.419	55	5.554	56	5.686
57	5.366	58	5.516	59	5.285	60	5.405
61	5.319	62	5.596	63	5.394	64	5.385
65	5.356	66	5.300	67	5.641	68	5.280
69	5.332	70	5.626	71	5.674	72	5.295
73	5.664	74	5.600	75	5.523	76	5.440
77	5.286	78	5.490	79	5.259	80	5.593
81	5.531	82	5.634	83	5.489	84	5.559
85	5.527	86	5.578	87	5.322	88	5.589
89	5.709	90	5.525	91	5.535	92	5.537
93	5.636	94	5.521	95	5.323	96	5.716
97	5.611	98	5.632	99	5.282	100	5.598

Hopping Frequency Sequence Name: HOP_FREQ_SEQ_10

SEQ#	Frequency (GHz)	SEQ#	Frequency (GHz)	SEQ#	Frequency (GHz)	SEQ#	Frequency (GHz)
1	5.448	2	5.353	3	5.542	4	5.384
5	5.676	6	5.609	7	5.518	8	5.454
9	5.662	10	5.516	11	5.357	12	5.406
13	5.491	14	5.438	15	5.408	16	5.263
17	5.625	18	5.559	19	5.652	20	5.280
21	5.577	22	5.254	23	5.556	24	5.472
25	5.672	26	5.282	27	5.639	28	5.527
29	5.612	30	5.569	31	5.555	32	5.630
33	5.347	34	5.607	35	5.647	36	5.425
37	5.422	38	5.329	39	5.501	40	5.704
41	5.364	42	5.374	43	5.702	44	5.554
45	5.644	46	5.277	47	5.626	48	5.418
49	5.587	50	5.604	51	5.677	52	5.558
53	5.568	54	5.534	55	5.497	56	5.401
57	5.252	58	5.466	59	5.571	60	5.584
61	5.714	62	5.682	63	5.552	64	5.610
65	5.597	66	5.392	67	5.370	68	5.456
69	5.316	70	5.274	71	5.506	72	5.523
73	5.537	74	5.533	75	5.546	76	5.645
77	5.276	78	5.505	79	5.484	80	5.684
81	5.679	82	5.259	83	5.285	84	5.668
85	5.723	86	5.656	87	5.673	88	5.255
89	5.594	90	5.339	91	5.268	92	5.502
93	5.496	94	5.503	95	5.323	96	5.273
97	5.342	98	5.711	99	5.410	100	5.661

Hopping Frequency Sequence Name: HOP_FREQ_SEQ_11

SEQ#	Frequency (GHz)	SEQ#	Frequency (GHz)	SEQ#	Frequency (GHz)	SEQ#	Frequency (GHz)
1	5.407	2	5.441	3	5.498	4	5.515
5	5.358	6	5.316	7	5.659	8	5.695
9	5.542	10	5.393	11	5.592	12	5.682
13	5.332	14	5.675	15	5.608	16	5.588
17	5.578	18	5.291	19	5.614	20	5.282
21	5.648	22	5.476	23	5.273	24	5.312
25	5.697	26	5.658	27	5.349	28	5.600
29	5.279	30	5.431	31	5.484	32	5.372
33	5.283	34	5.378	35	5.401	36	5.505
37	5.471	38	5.295	39	5.470	40	5.341
41	5.669	42	5.366	43	5.290	44	5.475
45	5.549	46	5.633	47	5.430	48	5.539
49	5.425	50	5.387	51	5.511	52	5.373
53	5.514	54	5.634	55	5.297	56	5.461
57	5.392	58	5.516	59	5.270	60	5.280
61	5.427	62	5.570	63	5.289	64	5.310
65	5.411	66	5.412	67	5.711	68	5.568
69	5.386	70	5.655	71	5.409	72	5.374
73	5.437	74	5.302	75	5.617	76	5.572
77	5.370	78	5.667	79	5.601	80	5.447
81	5.551	82	5.525	83	5.292	84	5.481
85	5.571	86	5.605	87	5.395	88	5.496
89	5.402	90	5.644	91	5.631	92	5.432
93	5.694	94	5.662	95	5.540	96	5.489
97	5.463	98	5.521	99	5.486	100	5.616

Hopping Frequency Sequence Name: HOP_FREQ_SEQ_12

SEQ#	Frequency (GHz)	SEQ#	Frequency (GHz)	SEQ#	Frequency (GHz)	SEQ#	Frequency (GHz)
1	5.544	2	5.339	3	5.529	4	5.472
5	5.508	6	5.431	7	5.596	8	5.270
9	5.327	10	5.379	11	5.662	12	5.462
13	5.273	14	5.617	15	5.651	16	5.377
17	5.686	18	5.415	19	5.488	20	5.380
21	5.351	22	5.688	23	5.260	24	5.530
25	5.589	26	5.703	27	5.632	28	5.609
29	5.333	30	5.286	31	5.507	32	5.693
33	5.664	34	5.582	35	5.461	36	5.358
37	5.667	38	5.555	39	5.367	40	5.570
41	5.711	42	5.372	43	5.537	44	5.267
45	5.301	46	5.585	47	5.288	48	5.583
49	5.398	50	5.421	51	5.291	52	5.445
53	5.541	54	5.504	55	5.384	56	5.299
57	5.543	58	5.556	59	5.496	60	5.477
61	5.423	62	5.678	63	5.624	64	5.353
65	5.413	66	5.296	67	5.706	68	5.685
69	5.473	70	5.722	71	5.424	72	5.525
73	5.674	74	5.359	75	5.325	76	5.489
77	5.614	78	5.622	79	5.294	80	5.573
81	5.494	82	5.326	83	5.394	84	5.482
85	5.650	86	5.435	87	5.659	88	5.400
89	5.637	90	5.355	91	5.258	92	5.449
93	5.718	94	5.676	95	5.447	96	5.549
97	5.640	98	5.645	99	5.276	100	5.533

Hopping Frequency Sequence Name: HOP_FREQ_SEQ_13

SEQ#	Frequency (GHz)	SEQ#	Frequency (GHz)	SEQ#	Frequency (GHz)	SEQ#	Frequency (GHz)
1	5.358	2	5.430	3	5.615	4	5.653
5	5.439	6	5.310	7	5.399	8	5.722
9	5.721	10	5.494	11	5.352	12	5.449
13	5.538	14	5.337	15	5.438	16	5.262
17	5.307	18	5.409	19	5.503	20	5.419
21	5.487	22	5.282	23	5.417	24	5.295
25	5.644	26	5.622	27	5.383	28	5.334
29	5.692	30	5.658	31	5.598	32	5.372
33	5.573	34	5.576	35	5.491	36	5.621
37	5.380	38	5.586	39	5.527	40	5.698
41	5.342	42	5.275	43	5.492	44	5.630
45	5.529	46	5.724	47	5.269	48	5.411
49	5.474	50	5.608	51	5.553	52	5.602
53	5.429	54	5.478	55	5.312	56	5.318
57	5.673	58	5.297	59	5.369	60	5.377
61	5.375	62	5.285	63	5.558	64	5.260
65	5.390	66	5.268	67	5.656	68	5.370
69	5.596	70	5.605	71	5.591	72	5.629
73	5.506	74	5.351	75	5.281	76	5.336
77	5.524	78	5.521	79	5.461	80	5.367
81	5.296	82	5.347	83	5.435	84	5.329
85	5.340	86	5.299	87	5.680	88	5.448
89	5.261	90	5.510	91	5.265	92	5.555
93	5.595	94	5.457	95	5.280	96	5.359
97	5.410	98	5.509	99	5.379	100	5.447

Hopping Frequency Sequence Name: HOP_FREQ_SEQ_14

SEQ#	Frequency (GHz)	SEQ#	Frequency (GHz)	SEQ#	Frequency (GHz)	SEQ#	Frequency (GHz)
1	5.393	2	5.673	3	5.362	4	5.390
5	5.528	6	5.625	7	5.315	8	5.383
9	5.653	10	5.342	11	5.572	12	5.613
13	5.252	14	5.520	15	5.685	16	5.292
17	5.268	18	5.450	19	5.259	20	5.674
21	5.321	22	5.371	23	5.531	24	5.381
25	5.284	26	5.403	27	5.599	28	5.549
29	5.400	30	5.482	31	5.281	32	5.454
33	5.689	34	5.290	35	5.481	36	5.540
37	5.571	38	5.368	39	5.440	40	5.555
41	5.607	42	5.399	43	5.713	44	5.301
45	5.423	46	5.369	47	5.445	48	5.566
49	5.574	50	5.724	51	5.639	52	5.406
53	5.407	54	5.543	55	5.476	56	5.660
57	5.633	58	5.700	59	5.417	60	5.439
61	5.589	62	5.585	63	5.435	64	5.500
65	5.715	66	5.280	67	5.697	68	5.366
69	5.442	70	5.558	71	5.286	72	5.448
73	5.716	74	5.508	75	5.634	76	5.488
77	5.657	78	5.554	79	5.461	80	5.721
81	5.517	82	5.269	83	5.584	84	5.693
85	5.587	86	5.502	87	5.431	88	5.405
89	5.272	90	5.707	91	5.667	92	5.418
93	5.662	94	5.387	95	5.610	96	5.536
97	5.485	98	5.605	99	5.526	100	5.279

Hopping Frequency Sequence Name: HOP_FREQ_SEQ_15

SEQ#	Frequency (GHz)	SEQ#	Frequency (GHz)	SEQ#	Frequency (GHz)	SEQ#	Frequency (GHz)
1	5.293	2	5.401	3	5.260	4	5.640
5	5.308	6	5.684	7	5.527	8	5.417
9	5.419	10	5.660	11	5.495	12	5.628
13	5.363	14	5.470	15	5.517	16	5.412
17	5.446	18	5.302	19	5.567	20	5.712
21	5.272	22	5.335	23	5.582	24	5.500
25	5.311	26	5.550	27	5.378	28	5.601
29	5.671	30	5.667	31	5.452	32	5.271
33	5.283	34	5.719	35	5.536	36	5.652
37	5.526	38	5.481	39	5.657	40	5.254
41	5.343	42	5.505	43	5.542	44	5.483
45	5.342	46	5.259	47	5.710	48	5.545
49	5.410	50	5.516	51	5.489	52	5.696
53	5.512	54	5.554	55	5.571	56	5.433
57	5.445	58	5.634	59	5.345	60	5.434
61	5.716	62	5.613	63	5.541	64	5.268
65	5.282	66	5.252	67	5.442	68	5.488
69	5.703	70	5.586	71	5.349	72	5.544
73	5.325	74	5.514	75	5.456	76	5.508
77	5.403	78	5.387	79	5.406	80	5.653
81	5.497	82	5.454	83	5.307	84	5.430
85	5.377	86	5.431	87	5.382	88	5.539
89	5.251	90	5.420	91	5.638	92	5.676
93	5.592	94	5.579	95	5.463	96	5.678
97	5.262	98	5.364	99	5.388	100	5.261

Hopping Frequency Sequence Name: HOP_FREQ_SEQ_16

SEQ#	Frequency (GHz)	SEQ#	Frequency (GHz)	SEQ#	Frequency (GHz)	SEQ#	Frequency (GHz)
1	5.700	2	5.350	3	5.410	4	5.401
5	5.669	6	5.409	7	5.462	8	5.338
9	5.266	10	5.526	11	5.681	12	5.337
13	5.420	14	5.267	15	5.516	16	5.629
17	5.389	18	5.299	19	5.490	20	5.398
21	5.380	22	5.418	23	5.523	24	5.655
25	5.360	26	5.328	27	5.397	28	5.639
29	5.417	30	5.423	31	5.540	32	5.342
33	5.656	34	5.296	35	5.491	36	5.635
37	5.395	38	5.255	39	5.556	40	5.254
41	5.278	42	5.648	43	5.295	44	5.576
45	5.686	46	5.569	47	5.439	48	5.476
49	5.614	50	5.422	51	5.336	52	5.367
53	5.259	54	5.461	55	5.566	56	5.702
57	5.345	58	5.307	59	5.319	60	5.289
61	5.517	62	5.281	63	5.581	64	5.673
65	5.489	66	5.339	67	5.436	68	5.352
69	5.440	70	5.634	71	5.504	72	5.411
73	5.407	74	5.625	75	5.601	76	5.678
77	5.671	78	5.282	79	5.710	80	5.324
81	5.264	82	5.536	83	5.633	84	5.499
85	5.271	86	5.568	87	5.559	88	5.644
89	5.514	90	5.664	91	5.326	92	5.294
93	5.646	94	5.315	95	5.340	96	5.408
97	5.638	98	5.599	99	5.670	100	5.561

Hopping Frequency Sequence Name: HOP_FREQ_SEQ_17

SEQ#	Frequency (GHz)	SEQ#	Frequency (GHz)	SEQ#	Frequency (GHz)	SEQ#	Frequency (GHz)
1	5.563	2	5.478	3	5.723	4	5.319
5	5.374	6	5.492	7	5.469	8	5.292
9	5.525	10	5.252	11	5.350	12	5.608
13	5.323	14	5.681	15	5.388	16	5.545
17	5.291	18	5.517	19	5.253	20	5.383
21	5.489	22	5.654	23	5.704	24	5.616
25	5.621	26	5.593	27	5.435	28	5.332
29	5.420	30	5.375	31	5.587	32	5.610
33	5.498	34	5.376	35	5.661	36	5.596
37	5.413	38	5.269	39	5.701	40	5.510
41	5.266	42	5.626	43	5.516	44	5.483
45	5.467	46	5.518	47	5.586	48	5.255
49	5.512	50	5.315	51	5.639	52	5.316
53	5.667	54	5.625	55	5.495	56	5.560
57	5.455	58	5.286	59	5.324	60	5.678
61	5.555	62	5.594	63	5.662	64	5.505
65	5.320	66	5.685	67	5.282	68	5.335
69	5.677	70	5.585	71	5.526	72	5.670
73	5.400	74	5.541	75	5.488	76	5.477
77	5.480	78	5.507	79	5.449	80	5.385
81	5.473	82	5.412	83	5.714	84	5.549
85	5.690	86	5.295	87	5.619	88	5.683
89	5.411	90	5.343	91	5.664	92	5.637
93	5.351	94	5.285	95	5.691	96	5.554
97	5.415	98	5.530	99	5.692	100	5.452

Hopping Frequency Sequence Name: HOP_FREQ_SEQ_18

SEQ#	Frequency (GHz)	SEQ#	Frequency (GHz)	SEQ#	Frequency (GHz)	SEQ#	Frequency (GHz)
1	5.497	2	5.599	3	5.670	4	5.665
5	5.351	6	5.278	7	5.388	8	5.600
9	5.263	10	5.572	11	5.364	12	5.532
13	5.643	14	5.487	15	5.486	16	5.631
17	5.515	18	5.492	19	5.373	20	5.442
21	5.358	22	5.293	23	5.562	24	5.355
25	5.496	26	5.467	27	5.679	28	5.707
29	5.607	30	5.513	31	5.489	32	5.485
33	5.320	34	5.418	35	5.621	36	5.416
37	5.522	38	5.407	39	5.303	40	5.357
41	5.378	42	5.542	43	5.678	44	5.452
45	5.574	46	5.449	47	5.546	48	5.610
49	5.434	50	5.613	51	5.650	52	5.469
53	5.281	54	5.608	55	5.524	56	5.529
57	5.428	58	5.661	59	5.544	60	5.512
61	5.393	62	5.411	63	5.471	64	5.462
65	5.504	66	5.399	67	5.638	68	5.298
69	5.395	70	5.553	71	5.273	72	5.578
73	5.463	74	5.423	75	5.307	76	5.516
77	5.507	78	5.480	79	5.360	80	5.721
81	5.598	82	5.376	83	5.494	84	5.398
85	5.595	86	5.521	87	5.305	88	5.446
89	5.275	90	5.443	91	5.316	92	5.437
93	5.549	94	5.693	95	5.269	96	5.295
97	5.668	98	5.586	99	5.719	100	5.615

Hopping Frequency Sequence Name: HOP_FREQ_SEQ_19

SEQ#	Frequency (GHz)	SEQ#	Frequency (GHz)	SEQ#	Frequency (GHz)	SEQ#	Frequency (GHz)
1	5.691	2	5.551	3	5.579	4	5.350
5	5.688	6	5.622	7	5.294	8	5.547
9	5.460	10	5.446	11	5.270	12	5.541
13	5.620	14	5.571	15	5.384	16	5.633
17	5.477	18	5.503	19	5.553	20	5.629
21	5.472	22	5.542	23	5.528	24	5.544
25	5.613	26	5.700	27	5.434	28	5.358
29	5.525	30	5.305	31	5.644	32	5.516
33	5.648	34	5.684	35	5.488	36	5.478
37	5.498	38	5.335	39	5.441	40	5.361
41	5.411	42	5.420	43	5.396	44	5.515
45	5.353	46	5.266	47	5.451	48	5.386
49	5.617	50	5.588	51	5.374	52	5.532
53	5.666	54	5.669	55	5.314	56	5.431
57	5.520	58	5.306	59	5.272	60	5.279
61	5.634	62	5.654	63	5.619	64	5.504
65	5.334	66	5.685	67	5.690	68	5.646
69	5.575	70	5.641	71	5.297	72	5.282
73	5.713	74	5.479	75	5.663	76	5.695
77	5.492	78	5.493	79	5.668	80	5.327
81	5.288	82	5.296	83	5.413	84	5.511
85	5.486	86	5.597	87	5.286	88	5.661
89	5.421	90	5.405	91	5.536	92	5.719
93	5.518	94	5.590	95	5.608	96	5.408
97	5.582	98	5.303	99	5.449	100	5.414

Hopping Frequency Sequence Name: HOP_FREQ_SEQ_20

SEQ#	Frequency (GHz)	SEQ#	Frequency (GHz)	SEQ#	Frequency (GHz)	SEQ#	Frequency (GHz)
1	5.680	2	5.483	3	5.416	4	5.549
5	5.475	6	5.321	7	5.633	8	5.278
9	5.311	10	5.524	11	5.678	12	5.521
13	5.605	14	5.367	15	5.691	16	5.672
17	5.370	18	5.504	19	5.488	20	5.433
21	5.465	22	5.282	23	5.266	24	5.701
25	5.709	26	5.267	27	5.445	28	5.385
29	5.623	30	5.299	31	5.419	32	5.707
33	5.617	34	5.322	35	5.498	36	5.632
37	5.649	38	5.546	39	5.446	40	5.541
41	5.599	42	5.630	43	5.256	44	5.568
45	5.566	46	5.537	47	5.534	48	5.277
49	5.618	50	5.374	51	5.455	52	5.283
53	5.564	54	5.312	55	5.693	56	5.436
57	5.338	58	5.372	59	5.272	60	5.369
61	5.696	62	5.507	63	5.695	64	5.529
65	5.317	66	5.384	67	5.297	68	5.494
69	5.366	70	5.705	71	5.300	72	5.715
73	5.481	74	5.287	75	5.698	76	5.301
77	5.655	78	5.670	79	5.264	80	5.420
81	5.262	82	5.676	83	5.683	84	5.394
85	5.540	86	5.337	87	5.326	88	5.431
89	5.381	90	5.505	91	5.515	92	5.275
93	5.408	94	5.690	95	5.306	96	5.359
97	5.427	98	5.342	99	5.356	100	5.462

Hopping Frequency Sequence Name: HOP_FREQ_SEQ_21

SEQ#	Frequency (GHz)	SEQ#	Frequency (GHz)	SEQ#	Frequency (GHz)	SEQ#	Frequency (GHz)
1	5.600	2	5.680	3	5.444	4	5.459
5	5.718	6	5.298	7	5.441	8	5.605
9	5.622	10	5.505	11	5.286	12	5.634
13	5.683	14	5.583	15	5.428	16	5.667
17	5.570	18	5.549	19	5.553	20	5.353
21	5.602	22	5.544	23	5.377	24	5.341
25	5.677	26	5.713	27	5.629	28	5.321
29	5.483	30	5.363	31	5.636	32	5.504
33	5.595	34	5.384	35	5.474	36	5.625
37	5.269	38	5.624	39	5.665	40	5.375
41	5.712	42	5.345	43	5.418	44	5.457
45	5.311	46	5.656	47	5.507	48	5.429
49	5.440	50	5.320	51	5.540	52	5.477
53	5.411	54	5.561	55	5.352	56	5.317
57	5.497	58	5.423	59	5.576	60	5.367
61	5.509	62	5.472	63	5.641	64	5.597
65	5.559	66	5.585	67	5.626	68	5.336
69	5.271	70	5.313	71	5.420	72	5.448
73	5.443	74	5.381	75	5.647	76	5.431
77	5.370	78	5.580	79	5.323	80	5.548
81	5.430	82	5.596	83	5.523	84	5.530
85	5.560	86	5.592	87	5.314	88	5.422
89	5.607	90	5.385	91	5.628	92	5.421
93	5.463	94	5.437	95	5.646	96	5.648
97	5.536	98	5.296	99	5.312	100	5.409

Hopping Frequency Sequence Name: HOP_FREQ_SEQ_22

SEQ#	Frequency (GHz)	SEQ#	Frequency (GHz)	SEQ#	Frequency (GHz)	SEQ#	Frequency (GHz)
1	5.290	2	5.317	3	5.630	4	5.724
5	5.411	6	5.700	7	5.507	8	5.263
9	5.308	10	5.568	11	5.400	12	5.252
13	5.499	14	5.570	15	5.528	16	5.461
17	5.638	18	5.399	19	5.398	20	5.254
21	5.684	22	5.616	23	5.659	24	5.285
25	5.640	26	5.647	27	5.357	28	5.279
29	5.324	30	5.323	31	5.327	32	5.626
33	5.722	34	5.345	35	5.302	36	5.483
37	5.702	38	5.384	39	5.305	40	5.651
41	5.498	42	5.693	43	5.255	44	5.564
45	5.299	46	5.482	47	5.446	48	5.704
49	5.459	50	5.582	51	5.288	52	5.720
53	5.335	54	5.286	55	5.541	56	5.457
57	5.272	58	5.365	59	5.529	60	5.618
61	5.441	62	5.581	63	5.386	64	5.650
65	5.580	66	5.612	67	5.601	68	5.557
69	5.486	70	5.608	71	5.511	72	5.664
73	5.675	74	5.525	75	5.567	76	5.678
77	5.586	78	5.336	79	5.291	80	5.387
81	5.625	82	5.356	83	5.412	84	5.706
85	5.591	86	5.688	87	5.374	88	5.401
89	5.510	90	5.624	91	5.321	92	5.339
93	5.466	94	5.475	95	5.655	96	5.328
97	5.513	98	5.686	99	5.352	100	5.261

Hopping Frequency Sequence Name: HOP_FREQ_SEQ_23

SEQ#	Frequency (GHz)	SEQ#	Frequency (GHz)	SEQ#	Frequency (GHz)	SEQ#	Frequency (GHz)
1	5.367	2	5.276	3	5.659	4	5.686
5	5.388	6	5.552	7	5.452	8	5.285
9	5.475	10	5.441	11	5.514	12	5.266
13	5.432	14	5.462	15	5.545	16	5.348
17	5.442	18	5.489	19	5.271	20	5.277
21	5.542	22	5.594	23	5.411	24	5.517
25	5.613	26	5.275	27	5.426	28	5.661
29	5.286	30	5.595	31	5.645	32	5.688
33	5.357	34	5.690	35	5.543	36	5.364
37	5.497	38	5.393	39	5.435	40	5.345
41	5.482	42	5.344	43	5.570	44	5.593
45	5.715	46	5.602	47	5.548	48	5.451
49	5.633	50	5.471	51	5.605	52	5.324
53	5.550	54	5.526	55	5.445	56	5.651
57	5.289	58	5.582	59	5.535	60	5.251
61	5.549	62	5.362	63	5.527	64	5.294
65	5.539	66	5.423	67	5.268	68	5.400
69	5.368	70	5.684	71	5.553	72	5.703
73	5.460	74	5.436	75	5.448	76	5.309
77	5.290	78	5.260	79	5.444	80	5.588
81	5.530	82	5.682	83	5.418	84	5.560
85	5.320	86	5.486	87	5.404	88	5.428
89	5.663	90	5.401	91	5.580	92	5.484
93	5.495	94	5.319	95	5.267	96	5.618
97	5.431	98	5.327	99	5.252	100	5.547

Hopping Frequency Sequence Name: HOP_FREQ_SEQ_24

SEQ#	Frequency (GHz)	SEQ#	Frequency (GHz)	SEQ#	Frequency (GHz)	SEQ#	Frequency (GHz)
1	5.280	2	5.283	3	5.409	4	5.651
5	5.340	6	5.620	7	5.366	8	5.353
9	5.501	10	5.456	11	5.573	12	5.583
13	5.375	14	5.630	15	5.291	16	5.333
17	5.477	18	5.453	19	5.513	20	5.510
21	5.445	22	5.407	23	5.401	24	5.671
25	5.523	26	5.428	27	5.655	28	5.603
29	5.650	30	5.270	31	5.348	32	5.367
33	5.564	34	5.673	35	5.362	36	5.378
37	5.528	38	5.334	39	5.365	40	5.568
41	5.341	42	5.636	43	5.411	44	5.549
45	5.394	46	5.271	47	5.420	48	5.724
49	5.467	50	5.423	51	5.427	52	5.580
53	5.611	54	5.313	55	5.584	56	5.553
57	5.396	58	5.688	59	5.516	60	5.433
61	5.487	62	5.308	63	5.296	64	5.338
65	5.666	66	5.464	67	5.389	68	5.421
69	5.721	70	5.605	71	5.555	72	5.447
73	5.455	74	5.567	75	5.585	76	5.656
77	5.469	78	5.640	79	5.629	80	5.424
81	5.481	82	5.329	83	5.342	84	5.610
85	5.710	86	5.489	87	5.343	88	5.442
89	5.692	90	5.292	91	5.702	92	5.601
93	5.491	94	5.626	95	5.644	96	5.641
97	5.406	98	5.450	99	5.569	100	5.690

Hopping Frequency Sequence Name: HOP_FREQ_SEQ_25

SEQ#	Frequency (GHz)	SEQ#	Frequency (GHz)	SEQ#	Frequency (GHz)	SEQ#	Frequency (GHz)
1	5.615	2	5.657	3	5.676	4	5.592
5	5.327	6	5.300	7	5.337	8	5.680
9	5.448	10	5.690	11	5.417	12	5.567
13	5.604	14	5.694	15	5.516	16	5.503
17	5.312	18	5.598	19	5.696	20	5.383
21	5.718	22	5.475	23	5.603	24	5.464
25	5.425	26	5.677	27	5.320	28	5.367
29	5.313	30	5.436	31	5.463	32	5.699
33	5.565	34	5.371	35	5.411	36	5.659
37	5.661	38	5.649	39	5.391	40	5.589
41	5.452	42	5.410	43	5.484	44	5.302
45	5.692	46	5.270	47	5.386	48	5.279
49	5.601	50	5.513	51	5.602	52	5.673
53	5.501	54	5.557	55	5.494	56	5.254
57	5.571	58	5.264	59	5.573	60	5.440
61	5.281	62	5.423	63	5.358	64	5.500
65	5.701	66	5.525	67	5.446	68	5.369
69	5.499	70	5.582	71	5.717	72	5.664
73	5.515	74	5.514	75	5.461	76	5.631
77	5.719	78	5.606	79	5.483	80	5.449
81	5.458	82	5.447	83	5.616	84	5.482
85	5.453	86	5.263	87	5.542	88	5.399
89	5.469	90	5.275	91	5.295	92	5.291
93	5.416	94	5.444	95	5.599	96	5.522
97	5.640	98	5.632	99	5.472	100	5.583

Hopping Frequency Sequence Name: HOP_FREQ_SEQ_26

SEQ#	Frequency (GHz)	SEQ#	Frequency (GHz)	SEQ#	Frequency (GHz)	SEQ#	Frequency (GHz)
1	5.339	2	5.672	3	5.594	4	5.694
5	5.660	6	5.647	7	5.656	8	5.705
9	5.551	10	5.542	11	5.295	12	5.316
13	5.454	14	5.592	15	5.582	16	5.303
17	5.465	18	5.417	19	5.512	20	5.710
21	5.289	22	5.286	23	5.277	24	5.440
25	5.584	26	5.518	27	5.505	28	5.597
29	5.326	30	5.371	31	5.374	32	5.639
33	5.355	34	5.609	35	5.618	36	5.463
37	5.425	38	5.404	39	5.711	40	5.506
41	5.394	42	5.431	43	5.703	44	5.489
45	5.596	46	5.575	47	5.515	48	5.655
49	5.652	50	5.494	51	5.358	52	5.648
53	5.376	54	5.457	55	5.279	56	5.707
57	5.412	58	5.396	59	5.319	60	5.430
61	5.363	62	5.379	63	5.544	64	5.364
65	5.499	66	5.622	67	5.476	68	5.536
69	5.487	70	5.587	71	5.452	72	5.418
73	5.333	74	5.321	75	5.528	76	5.574
77	5.619	78	5.386	79	5.633	80	5.467
81	5.600	82	5.500	83	5.504	84	5.265
85	5.625	86	5.359	87	5.485	88	5.372
89	5.569	90	5.456	91	5.573	92	5.581
93	5.281	94	5.314	95	5.721	96	5.650
97	5.713	98	5.275	99	5.686	100	5.708

Hopping Frequency Sequence Name: HOP_FREQ_SEQ_27

SEQ#	Frequency (GHz)	SEQ#	Frequency (GHz)	SEQ#	Frequency (GHz)	SEQ#	Frequency (GHz)
1	5.452	2	5.650	3	5.373	4	5.568
5	5.602	6	5.448	7	5.593	8	5.367
9	5.529	10	5.515	11	5.598	12	5.338
13	5.380	14	5.524	15	5.371	16	5.401
17	5.522	18	5.411	19	5.715	20	5.590
21	5.300	22	5.691	23	5.433	24	5.430
25	5.670	26	5.318	27	5.319	28	5.333
29	5.260	30	5.425	31	5.530	32	5.708
33	5.722	34	5.712	35	5.501	36	5.654
37	5.485	38	5.424	39	5.638	40	5.445
41	5.564	42	5.439	43	5.376	44	5.442
45	5.619	46	5.552	47	5.347	48	5.408
49	5.316	50	5.643	51	5.269	52	5.484
53	5.687	54	5.419	55	5.573	56	5.473
57	5.327	58	5.293	59	5.611	60	5.475
61	5.537	62	5.583	63	5.444	64	5.661
65	5.551	66	5.255	67	5.364	68	5.349
69	5.574	70	5.588	71	5.680	72	5.497
73	5.585	74	5.534	75	5.365	76	5.721
77	5.469	78	5.488	79	5.406	80	5.348
81	5.504	82	5.671	83	5.651	84	5.375
85	5.286	86	5.507	87	5.414	88	5.519
89	5.684	90	5.438	91	5.520	92	5.265
93	5.404	94	5.711	95	5.586	96	5.657
97	5.302	98	5.575	99	5.490	100	5.464

Hopping Frequency Sequence Name: HOP_FREQ_SEQ_28

SEQ#	Frequency (GHz)	SEQ#	Frequency (GHz)	SEQ#	Frequency (GHz)	SEQ#	Frequency (GHz)
1	5.434	2	5.680	3	5.335	4	5.560
5	5.369	6	5.305	7	5.710	8	5.275
9	5.315	10	5.475	11	5.269	12	5.460
13	5.533	14	5.627	15	5.702	16	5.661
17	5.707	18	5.356	19	5.687	20	5.328
21	5.656	22	5.563	23	5.581	24	5.361
25	5.694	26	5.468	27	5.456	28	5.304
29	5.499	30	5.255	31	5.391	32	5.647
33	5.320	34	5.653	35	5.298	36	5.536
37	5.665	38	5.268	39	5.623	40	5.721
41	5.620	42	5.611	43	5.313	44	5.570
45	5.545	46	5.716	47	5.524	48	5.628
49	5.698	50	5.558	51	5.278	52	5.723
53	5.420	54	5.359	55	5.722	56	5.492
57	5.446	58	5.354	59	5.474	60	5.638
61	5.720	62	5.618	63	5.582	64	5.326
65	5.398	66	5.410	67	5.634	68	5.344
69	5.697	70	5.253	71	5.519	72	5.424
73	5.594	74	5.286	75	5.599	76	5.264
77	5.718	78	5.576	79	5.682	80	5.432
81	5.584	82	5.462	83	5.525	84	5.336
85	5.577	86	5.459	87	5.714	88	5.449
89	5.483	90	5.490	91	5.347	92	5.277
93	5.478	94	5.292	95	5.274	96	5.377
97	5.617	98	5.367	99	5.472	100	5.337

Hopping Frequency Sequence Name: HOP_FREQ_SEQ_29

SEQ#	Frequency (GHz)	SEQ#	Frequency (GHz)	SEQ#	Frequency (GHz)	SEQ#	Frequency (GHz)
1	5.410	2	5.585	3	5.609	4	5.523
5	5.304	6	5.466	7	5.262	8	5.617
9	5.311	10	5.677	11	5.590	12	5.283
13	5.305	14	5.601	15	5.404	16	5.690
17	5.302	18	5.655	19	5.668	20	5.389
21	5.412	22	5.709	23	5.286	24	5.631
25	5.626	26	5.487	27	5.257	28	5.491
29	5.328	30	5.345	31	5.651	32	5.275
33	5.605	34	5.430	35	5.588	36	5.705
37	5.289	38	5.694	39	5.365	40	5.307
41	5.673	42	5.288	43	5.458	44	5.363
45	5.573	46	5.424	47	5.654	48	5.354
49	5.548	50	5.696	51	5.440	52	5.701
53	5.629	54	5.390	55	5.334	56	5.507
57	5.434	58	5.724	59	5.485	60	5.444
61	5.527	62	5.428	63	5.360	64	5.377
65	5.542	66	5.641	67	5.423	68	5.446
69	5.483	70	5.478	71	5.537	72	5.293
73	5.612	74	5.476	75	5.445	76	5.702
77	5.596	78	5.388	79	5.544	80	5.499
81	5.621	82	5.353	83	5.402	84	5.603
85	5.650	86	5.469	87	5.327	88	5.313
89	5.721	90	5.432	91	5.646	92	5.680
93	5.640	94	5.295	95	5.606	96	5.604
97	5.539	98	5.325	99	5.468	100	5.484

Hopping Frequency Sequence Name: HOP_FREQ_SEQ_30

SEQ#	Frequency (GHz)	SEQ#	Frequency (GHz)	SEQ#	Frequency (GHz)	SEQ#	Frequency (GHz)
1	5.631	2	5.628	3	5.645	4	5.347
5	5.591	6	5.427	7	5.333	8	5.692
9	5.441	10	5.504	11	5.600	12	5.551
13	5.271	14	5.647	15	5.646	16	5.406
17	5.613	18	5.291	19	5.362	20	5.394
21	5.470	22	5.458	23	5.546	24	5.563
25	5.318	26	5.397	27	5.260	28	5.636
29	5.576	30	5.430	31	5.391	32	5.460
33	5.361	34	5.708	35	5.698	36	5.544
37	5.258	38	5.474	39	5.703	40	5.416
41	5.657	42	5.328	43	5.277	44	5.617
45	5.449	46	5.489	47	5.575	48	5.268
49	5.294	50	5.723	51	5.644	52	5.590
53	5.256	54	5.721	55	5.261	56	5.259
57	5.514	58	5.476	59	5.345	60	5.459
61	5.462	62	5.266	63	5.407	64	5.488
65	5.286	66	5.371	67	5.571	68	5.556
69	5.588	70	5.654	71	5.678	72	5.354
73	5.472	74	5.526	75	5.487	76	5.468
77	5.508	78	5.388	79	5.446	80	5.520
81	5.418	82	5.390	83	5.550	84	5.482
85	5.337	86	5.404	87	5.664	88	5.465
89	5.598	90	5.257	91	5.392	92	5.516
93	5.448	94	5.327	95	5.614	96	5.594
97	5.633	98	5.637	99	5.715	100	5.329

--- END ---